

DXG-589V

User's Manual

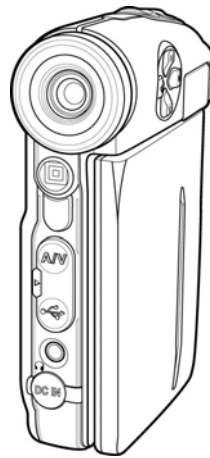

DXG USA

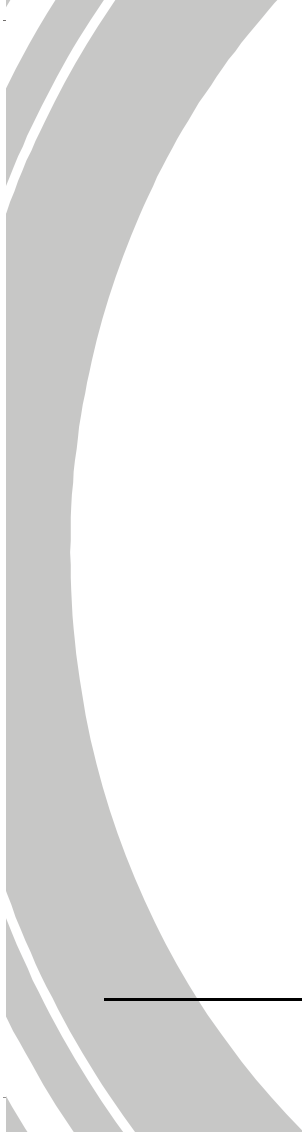

Table of Contents

<i>Preface</i>	<i>vi</i>
<i>About this manual</i>	<i>vi</i>
<i>Copyright</i>	<i>vi</i>
<i>Precautions</i>	<i>vii</i>
1 Introduction	1
1.1 System requirements	1
1.2 Features	1
1.3 Unpacking the video camera	2
1.4 About the camera	3
1.4.1 Front view	3
1.4.2 Back view	3
1.4.3 Top view	4
1.4.4 Bottom view	4
1.4.5 Right view.....	5
1.4.6 Left View.....	5
1.4.7 Adjusting the LCD display.....	6
1.4.8 LCD/Game control buttons	7
1.4.9 Using the Remote Controller.....	11
2 Getting started	13
2.1 Inserting an SD card	13
2.2 Inserting the batteries	14
2.3 Charging the battery/Using the power adapter	15
2.4 Turning on for the first time	15

2.5	<i>Changing modes</i>	15
2.6	<i>Before you start</i>	16
2.6.1	Setting the date and time.....	16
2.6.2	Setting the language	17
2.7	<i>Shoot/Playback video</i>	18
2.7.1	Shooting a video clip:.....	18
2.7.2	Playing the video clip.....	19
2.8	<i>Taking/viewing pictures</i>	20
2.8.1	Taking a still picture:.....	20
2.8.2	Viewing images:.....	21
2.9	<i>Playing music files</i>	22
2.10	<i>Playing video games</i>	23
2.11	<i>Voice recording</i>	24
2.11.1	To playback a voice file:.....	25
2.12	<i>Using the Video Recorder Feature</i>	26
2.13	<i>Connecting to a computer</i>	27
2.14	<i>Connecting to a TV</i>	28
2.15	<i>Connecting the earphones</i>	28
2.16	<i>Connecting the power adapter</i>	29
3	<i>Using the camera</i>	30
3.1	<i>Video mode</i>	30
3.1.1	Video mode icons	30
3.1.2	Quick access menu	32
3.2	<i>Camera mode</i>	33
3.2.1	Camera mode icons	33

3.2.2	Using the macro function	34
3.2.3	Using the zoom function.....	34
3.2.4	Using the LED flash light.....	35
3.2.5	Quick access menu	36
3.3	<i>Playback mode</i>	37
3.3.1	Playback mode icons	37
3.3.2	Thumbnail mode.....	38
3.4	<i>Music mode</i>	39
3.4.1	Music mode icons	39
3.5	<i>Voice mode</i>	40
3.5.1	Voice mode icons	40
3.6	<i>USB mode</i>	41
3.6.1	Using the PC cam feature	41
3.6.2	Using the mass storage feature	41
3.6.3	Using DPS feature.....	41
3.7	<i>Game mode</i>	42
3.7.1	Playing video games	42
4	Using the menus	50
4.1	<i>DV menu</i>	50
4.1.1.	Video size.....	50
4.1.2.	Video quality	51
4.1.3.	White balance.....	52
4.1.4.	Exposure adjustment (EV).....	53
4.1.5.	Color effect	54
4.2	<i>DV playback menu</i>	55

4.2.1	Delete all	55
4.2.2	Unlock all.....	56
4.3	Picture menu	57
4.3.1	Size.....	57
4.3.2	Image quality.....	58
4.3.3	White balance	59
4.3.4	Exposure adjustment (EV).....	60
4.3.5	Color effect	61
4.3.6	Self-timer.....	62
4.3.7	Drive mode.....	63
4.3.8	Date stamp.....	64
4.4	Camera playback menu.....	65
4.4.1	Delete all	65
4.4.2	Unlock all.....	66
4.4.3	Slide show.....	67
4.4.4	DPOF one.....	68
4.4.5	DPOF all.....	70
4.5	Music menu.....	71
4.5.1	Repeat.....	71
4.5.2	Delete all	72
4.6	Setup menu.....	73
4.6.1	Date/time	73
4.6.2	Beep	73
4.6.3	Format	74
4.6.4	Default.....	75
4.6.5	Memory status	76

4.6.6	Language	76
4.6.7	TV system	77
4.6.8	Power off timer	78
4.6.9	Frequency	79
5	Installing software and drivers	80
5.1	<i>Drivers</i>	80
5.1.1	Mass Storage.....	80
5.2	<i>Presto! Video Works 6</i>	82
5.3	<i>Presto! Mr. Photo 3</i>	83
5.4	<i>XviD codec for PC</i>	84
Appendix		87
	<i>Specifications</i>	87
	<i>Troubleshooting</i>	90

Preface

Congratulations on your purchase of this advanced video camera. Make sure that you read this manual carefully and keep it in a safe place for future reference.

About this manual

Every effort has been made to ensure that the contents of this manual are correct and up to date. However, no guarantee is made regarding the accuracy of the contents. If the contents of this manual do not tally with the camera, please take the camera as a criterion. We reserve the right to change the contents of this manual and specifications of the product without prior notice.

If the accessories do not tally with the actual package, please take the actual package as the criterion.

Copyright

© Copyright 2007.

All rights reserved. No part of this publication may be reproduced, transmitted, transcribed, stored in a retrieval system or translated into any language or computer language, in any form or by any means, electronic, mechanical, magnetic, optical, manual or otherwise, without the prior written permission of the manufacturer.

Precautions

General precautions

- Do not use or store the product in dusty, dirty, or sandy areas, as its components may be damaged.
- Do not store the product in a hot environment. High temperatures can shorten the life of electronic devices, damage batteries and warp or melt certain plastics.
- Do not store the product in cold areas. When the product warms up to its normal temperature, moisture can form inside; this may damage the electronic circuits.
- Do not attempt to open the casing or attempt your own repairs. High-voltage internal components create the risk of electric shock when exposed.
- Do not drop or knock the product. Rough handling may damage the internal components.
- Do not use harsh chemicals, cleaning solvents or strong detergents to clean the product. Wipe the product with a slightly damp soft cloth.
- Do not fire the flash while it is too close to the subject's eyes. Intense light from the flash can cause eye damage if it is fired too close to the eyes. When using the flash, the camera should be at least one meter from the eyes of the subject.
- Do not open battery cover while an image is being recorded. Doing so will not only make storage of the current image impossible, it can also corrupt other image data already stored in file.
- If the product or any of its accessories are not working properly, take them to your nearest qualified service center. The personnel there will assist you and if necessary, arrange for the product to be repaired.
- Test for proper operation before using the camera.

- Before using the camera to record images, make sure you first record a number of test images and check the results to ensure that the camera is configured correctly and operating properly (refer to “2. Getting started” section)

Operation conditions

- This camera is designed for use in temperatures ranging for 0°C to 40°C (32°F to 104°F)
- Do not use or keep the camera in the following areas.
 - in areas subject to direct sunlight
 - in areas subject to high humidity or dust
 - near air conditioners, heaters, or other areas subject to temperature extremes
 - inside of a closed vehicle, especially one parked in the sun.
 - in areas subject to strong vibration

Power supply

- Use only the type of battery and charger that came with your camera. Using any other type of battery or charger may damage the equipment and invalidate the warranty.
- When using Li-ion batteries in this product, ensure that they are inserted correctly. Inserting the batteries incorrectly can cause damage to the product and possibly start a fire.
- Never use any other AC adapter besides the one that comes with this camera.

1 Introduction

Read this section to learn about the features and functions of this video camera. This chapter covers system requirements, package contents, and description of the hardware components.

1.1 System requirements

The video camera requires a PC with the following specifications:

- Windows® XP, 2000, and ME operating system
- Intel® Pentium III 500MHz CPU or higher
- At least 256 MB of RAM or higher
- Standard USB 1.1 port or higher
- 4x speed CD-ROM drive or higher
- At least 200MB of available disk space

Note: A USB 1.1 port will enable you to transfer files to and from your host PC, but transfer speed will be much faster with a USB 2.0 port.

1.2 Features

The video camera offers a variety of features and functions including:

- Digital camcorder
- Digital Camera
- Voice recorder
- Music player
- Multimedia player
- Game player

Additionally, the camera features 4X advance zoom, 4X digital zoom, USB mass storage, and an SD card reader.

1.3 Unpacking the video camera

The following items should be present in the package. If any item is missing or appears damaged, contact your dealer immediately.



Video camera



AV-IN/Audio cable



USB/TV out cable



Earphones



CD-ROM
(Driver and application
software)



User manual



Li-ion battery



Power adapter



Battery charger



Pouch



Wrist strap



Remote Control

1.4 About the camera

Refer to the following illustrations to familiarize yourself with the buttons and controls of this video camera.

1.4.1 Front view

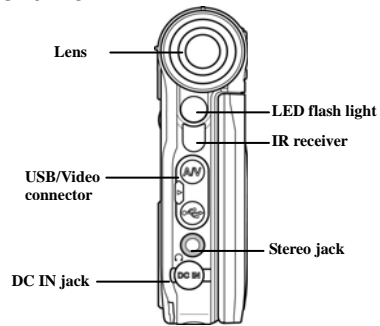

1.4.2 Back view

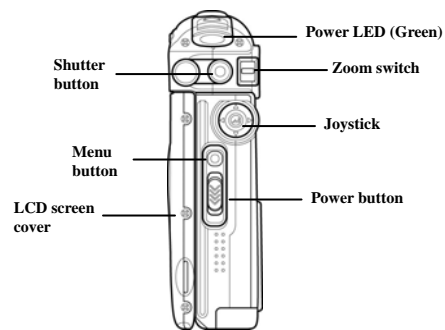

1.4.3 Top view

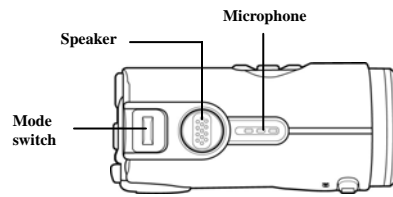

1.4.4 Bottom view

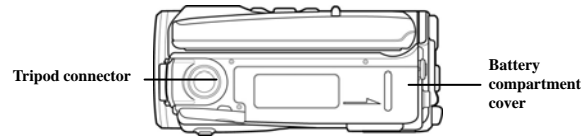

1.4.5 Right view



1.4.6 Left View

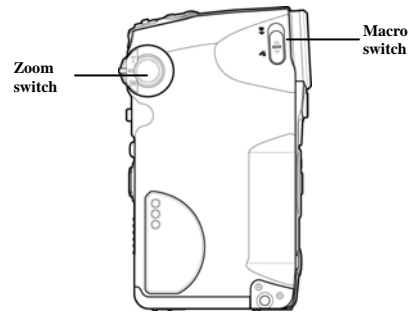

1.4.7 Adjusting the LCD display

Flip and twist the LCD screen as shown while capturing a still image or recording a video clip.

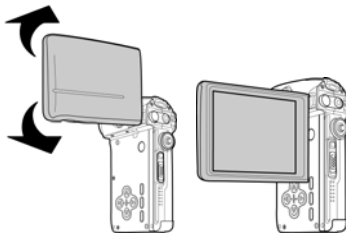



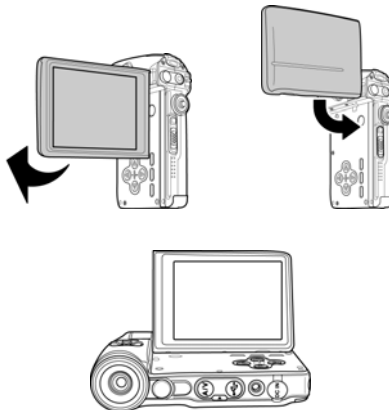

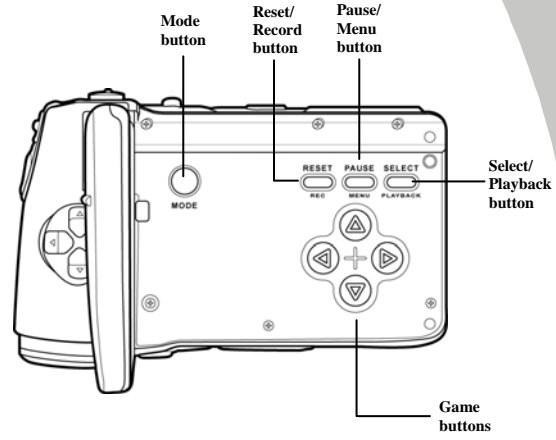

Flip and twist the LCD screen as shown to sit the screen on the game control panel when playing the built-in video games.











1.4.8 LCD/Game control buttons



See the table below for a description of each button's function.

Button	Name	Function
	Power switch	Slide the power switch down to turn on/off the video camera.
	Zoom switch	<ul style="list-style-type: none"> ● Move up/ down to zoom in/ out while shooting video clips or taking pictures. ● Move up/ down to enlarge/ reduce images while reviewing still images. ● Move up/ down to adjust volume while playing video or voice files.
	Menu button	Press to display main OSD (on-screen display) menus.
  MODE	Mode switch/ Mode button	Use to toggle Camcorder (DV), Camera, Music, Game, and Voice modes.
	Joystick	<ul style="list-style-type: none"> ● In Playback mode, move the joystick left/right to select previous/next video clip/image/ voice/ music file to play. Move the joystick up and down to fast

		<p>forward or rewind during a file playback.</p> <ul style="list-style-type: none"> ● In DV/Camera mode, move up/down/right to show the quick access menu options. And move left to turn on the LED flash light. Move right to access timer. ● In DV/Camera/Voice Playback mode, move down to protect the files from accidental deletion. Press the center joystick button to playback audio and video files. ● In Music mode, move up to toggle the repeat options. Press the center joystick to play/stop playing the audio files.
	Select/ Playback button	Press to playback images, video clips, or recorded voice files.
	Pause/ Menu button	<ul style="list-style-type: none"> ● Press to display main OSD menu. ● In Game mode, press to pause while playing a game.
	Reset/ Record button	<ul style="list-style-type: none"> ● In Game mode, press to exit to the main menu. ● In DV/Voice mode, press to start recording.
	Shutter button	<ul style="list-style-type: none"> ● Press to start/stop the video/voice recording in DV/Voice mode.

		<ul style="list-style-type: none"> ● Press to capture a picture in Camera mode. ● Press to play/stop when playing video/voice files.
	Macro switch	Move the switch to the  position to enable Macro mode.
	Directional pad	<ul style="list-style-type: none"> ● Used as directional keys in Game mode. ● Used as joystick buttons in DV/ Camera/Voice /Music /Playback mode. ● In Playback mode, press the up and down directional pads to fast forward or rewind during file playback.
	Game buttons	<ul style="list-style-type: none"> ● In Game mode, press the buttons to execute game commands. ● In DV Playback and Voice Playback modes, press  to start/stop file playback.

1.4.9 Using the Remote Control

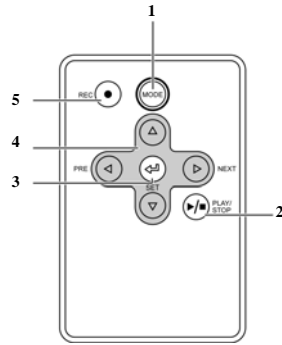

Refer to the following table for the functions of the remote control buttons.

No.	Button	Function
1	Mode	Use to toggle Camcorder (DV) , Camera , Music , Game , and Voice modes.
2	Play/Stop	<ul style="list-style-type: none"> ● In Playback mode, press to play or stop when playing back a video clip, or recorded voice files. ● In Music mode, press to play or stop when playing back a music file.
3	Set	In OSD menus, press to confirm your selection.

4	Directional pad	<ul style="list-style-type: none">● In Playback mode, move the joystick left/right to select previous/next video clip/image/ voice/ music file to play.● In DV/Camera mode, move up/down/right to show the quick access menu options. And move left to turn on the LED flash light.● In DV/Camera/Voice Playback mode, move down to protect the files from accidental deletion. Press the center joystick button to playback audio and video files.
5	REC	In DV/Voice mode, press to start recording.

2 Getting started

Read this section to learn how to start using the video camera. This section covers basic functions such as switching on, inserting the battery and memory cards, and configuring preliminary settings. See later chapters for advanced functions.

2.1 Inserting an SD card

An SD card can be installed in the video camera to provide additional storage space for still images, video clips, or other files.

1. Open battery compartment cover.

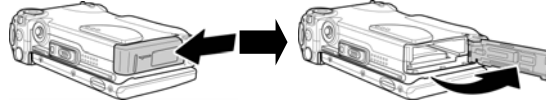

2. Insert an SD card as shown. Make sure the gold contacts are facing away from the battery.



3. Close the battery compartment cover.

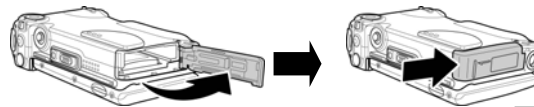

2.2 Inserting the batteries

This video camera is designed to use a rechargeable Li-ion battery. Only use the battery supplied or similar battery recommended by the manufacturer or your dealer.

Note: Install the batteries exactly as described here. Ensure that the polarity of the batteries is correct. Installing the batteries incorrectly could cause damage to the camera and possibly start a fire.

1. Open the battery compartment cover.

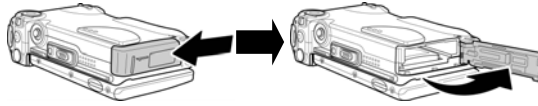

2. Insert the battery as shown.

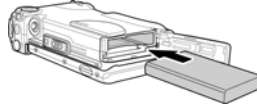

3. Close the battery compartment cover.

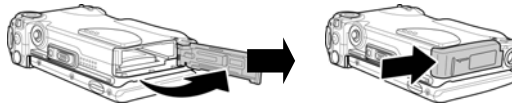

2.3 Charging the battery/Using the power adapter

You can charge the battery with the charging unit provided or use the camera by connecting the power adapter to the DC IN jack on the camera.

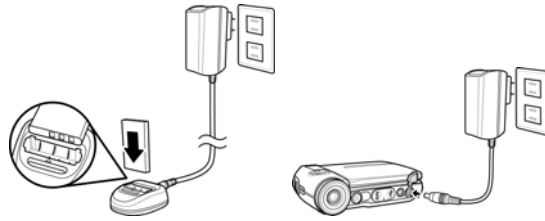

2.4 Turning on for the first time

Slide the power switch "down" to turn the video camera on/off.

2.5 Changing modes

The video camera can operate in six modes: **Camcorder (DV)**, **Camera**, **Music**, **Game**, and **Voice**. Slide the mode switch or press the **MODE** button to toggle different modes.

2.6 Before you start

Before you start using the video camera, some basic settings such as date and time and languages are needed to be configured.

2.6.1 Setting the date and time

1. Turn on the video camera, and press the **MENU** button to display the menu screen. Move the joystick left/right to view the **Setup** menu.

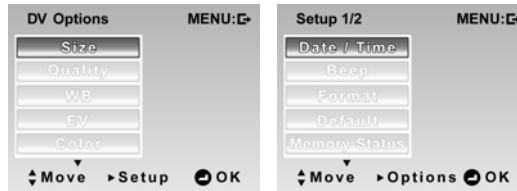

2. Use the joystick to highlight the **Date/Time** option. Press the center joystick button to confirm. Move the joystick left or right to highlight each field.

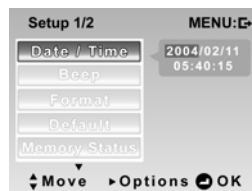

3. Adjust each value by moving joystick up and down. Press the center joystick button to save your changes.
4. Press the **MENU** button to exit.

2.6.2 Setting the language

1. Turn the video camera on, and press the **MENU** button to display the menu screen. Move the joystick left or right to view the **Setup** menu.
2. Move the joystick down to go to the second page and highlight the **Language** option. Press the center joystick button to confirm.



3. Use the joystick to select the desired language. After the language is selected, press the center joystick button to confirm.



4. Press the **MENU** button to exit.

2.7 Capture/Playback video

2.7.1 Shooting a video clip:

1. Turn on the video camera and switch to DV mode.

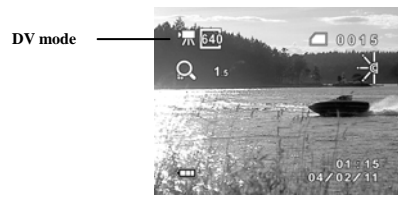

2. Use the LCD screen to frame the subject.
3. Press the **Shutter** button to start recording.
4. Press the **Shutter** button again to stop recording.
5. The video clip is automatically saved with a unique file name.

Note: The recorded file is saved in mp4 AVI format. To view AVI files on your computer, please install XviD 1.03 codec (included on the Software CD).

2.7.2 Playing the video clip

1. In **DV mode**, press the **Playback** button and the most recent file displays on the LCD screen.



2. Move the joystick left and right to scroll through the video clips. Press the center joystick button or the **button** to playback the video clip.
3. To pause while playing back the video clip, press the center joystick button or the **button** again.
4. When viewing the video clip, use the **zoom** switch to adjust the volume.
5. Press the **Shutter** button to stop playing.
6. Move the joystick or the directional pad **up** to delete the current file. Highlight the **OK** option and press the center joystick button to confirm.
7. Move the joystick or the directional pad **down** to protect the current file. A **lock** icon displays on the screen when the file is protected. Move the joystick down again to unlock the file.
8. Press the Playback button again to return to **DV mode**.

2.8 Taking/viewing pictures

2.8.1 Taking a still picture:

1. Turn on the camera and switch to **Camera** mode.

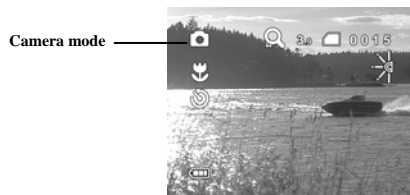

2. Use the LCD screen to frame the subject.
3. Press the **Shutter** button to capture the image.
4. The picture is automatically saved with a unique file name.

2.8.2 Viewing images:

1. In **Camera** mode, press the **Playback** button and the most recent image displays on the LCD screen.

Playback mode





2. Move the joystick **left** or **right** to scroll through the images.
3. Use the **zoom** switch to scale the image. Use the joystick to move the zoomed image up and down, left and right.
4. Move the joystick or the directional pad **up** to display the **Delete** option. Use the joystick to choose **OK** to delete the current picture.
5. Move the joystick or the directional pad **down** to protect the current picture. A  icon displays on the screen when the file is protected. Move the joystick down again to unlock the picture.
6. Press the **Playback** button again to return to **Camera** mode.

2.9 Playing music files

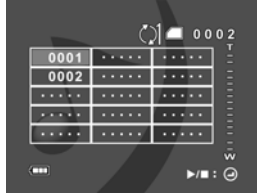
1. Turn on the video camera and switch to **Music mode**.





2. Move the joystick **left** or **right** to select the file to playback.
3. Press the center joystick button or the  button to playback the selected music file.
4. When playing back a voice file, use the **zoom** switch to adjust the volume.
5. Move the joystick or the directional pad **up** to delete the selected music file. Use the joystick to highlight **OK** and press the center joystick button to confirm.
6. Move the joystick or the directional pad **down** to toggle the repeat options. You can choose to repeat the selected music file or all files.
7. Press the center joystick button or the  again to stop.

Note: When adding music files to the camera memory or memory card, you need to create a folder called **Music** and save the music files in it.

2.10 Playing video games

1. Turn on the video camera and switch to **Game** mode.



2. Press the  button to display the **Game** menu.
3. Use the joystick or the directional pad to select the game you want to play.
4. Press the  button to start playing the game.
5. Press the **PAUSE** button to pause while playing a game. Press the **PAUSE** button again to resume.
6. See “Playing video games” on 3.7.1 for a brief introduction and instructions on how to play the games.

2.11 Voice recording

To make a voice recording:

1. Turn on the video camera and switch to **Voice mode**.

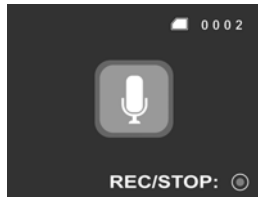



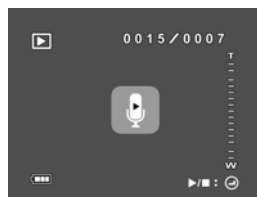

2. Press the **Shutter** button to start recording.
3. Press the **Shutter** button again to stop.
4. The voice file will automatically be saved with a unique file name.

2.11.1 To playback a voice file:

1. In Voice mode, press the **Playback** button and the most recent file is displayed on the LCD screen.



2. Move the joystick **left** or **right** to select the voice file you want to play. Press the center joystick button or the  button to playback the voice file.
3. When playing back a voice file, use the **zoom** switch to adjust the volume.
4. Press the **center joystick** button or the  button again to stop.
5. Move the joystick or the directional pad **up** to delete the current file. Use the joystick to highlight OK and press the center joystick button to confirm.
6. Move the joystick or the directional pad **down** to protect the  file. A  icon displays on screen when the file is protected. Move the joystick **down again** to unlock the file.
7. Press the Playback button to return to **Voice** mode.

2.12 Using the Video Recorder Feature

1. Turn on the video camera.
2. Connect the video camera to an AV out device such as a **DVD player** using the AV-In and audio cables as shown.

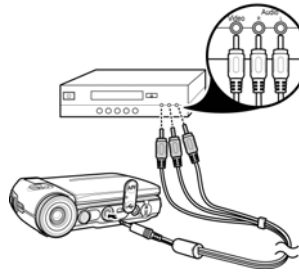

3. Press the **Shutter** button to start recording.

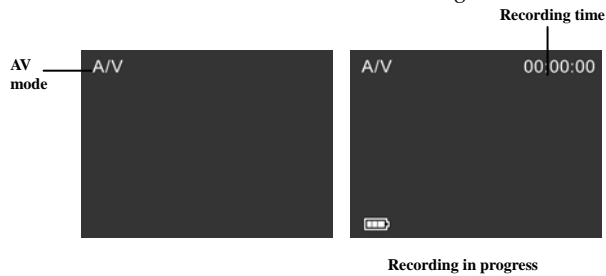

4. Press the **Shutter** button again to stop. The video clip will automatically be saved with a unique file name.

Note: The recorded file will be saved in mp4 avi format. To view AVI files on your computer, please install XviD 1.03 codec (included in the Software CD).

2.13 Connecting to a computer

Read this section to learn how to transfer files to a PC or use the camera as a PC web-camera for conferences.

Connect the video camera to a computer with the USB cable provided.

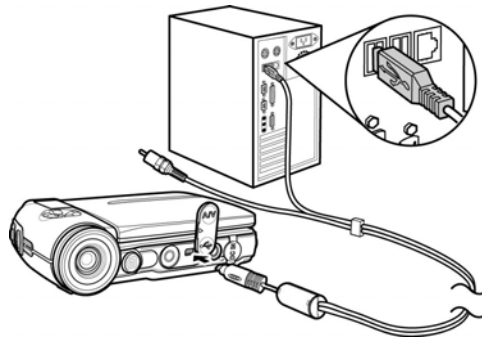

2.14 Connecting to a TV

Connect the video camera to a TV as shown with the AV cables provided.

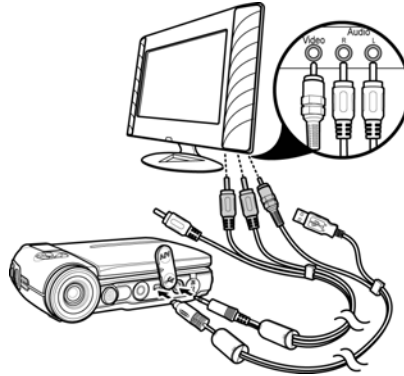

2.15 Connecting the earphones

Connect the earphones to the video camera as shown.

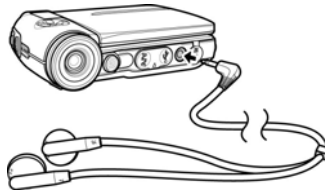

2.16 Connecting the power adapter

Connect the power adapter to the video camera as shown.

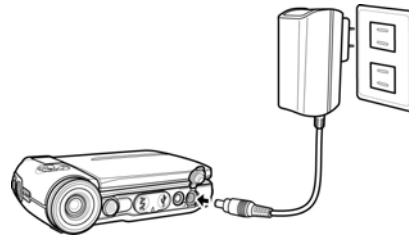

3 Using the camera

Read this section to learn how to use the camera.

3.1 Video mode





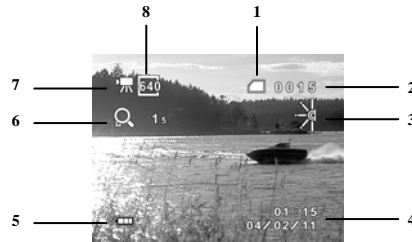

Use DV mode to capture video clips and store them in internal memory or on an SD card.





3.1.1 Video mode icons

Use the following picture to familiarize yourself with the DV mode icons and symbols.



See the table below for a description of each icon and symbol.

1		Memory status indicator  indicates that an SD card is inserted  indicates that internal memory is used
2		Displays the number of files saved
3		LED flash light indicator
4		Date and time
5		Battery indicator

6		Zoom indicator. An  icon indicates the zoom is in use. (White icon indicates advance zoom while purple indicates digital zoom)
7		Video mode indicator
8		Image size indicator

3.1.2 Quick access menu

You can make adjustments to the current settings by pressing the scroll wheel/joystick.

In **DV** mode, use the **joystick** to display the quick access menu. You can adjust settings such as file size, image quality, EV compensation, and white balance.



To make adjustments, do the following:

1. Move the joystick or the directional pad **up** to toggle file size options.
2. Move the joystick or the directional pad **down** to toggle image quality options.
3. Move the joystick or the directional pad **right** to toggle the white balance options.
4. Press the **center** joystick or the **square** button to display the EV compensation. Move the joystick **down** to adjust the EV value and press the **center joystick button** to confirm.

3.2 Camera mode

Use **Camera** mode to capture still pictures and store them in the internal memory or on an SD card.

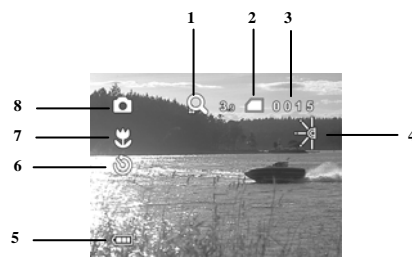

3.2.1 Camera mode icons

Use the following picture to familiarize yourself with the **Camera** mode icons and symbols.





See the table below for a description of each icon and symbol.

1		Zoom indicator
2	 	Memory status indicator SD card Internal memory
3	0015	Displays the number of stored files
4		LED flash light indicator
5		Battery status indicator
6		Self-timer indicator

7		Macro mode indicator When macro function is enabled, the  icon displays on the screen. The icon is not shown when this function is off.
8		Camera mode indicator

3.2.2 Using the macro function

This function can capture subjects up close. In macro mode, subjects can be as close as 21-23 cm.

While in **Camera** mode, make sure that the **macro switch** is in the Macro mode, as indicated by the  icon, same  icon appears on the LCD screen.

Move the macro switch down to cancel the macro function.

3.2.3 Using the zoom function

The camera is equipped with 4x advance zoom and 4x digital zoom.

Move the zoom switch **up** to get closer to a subject.

Move the zoom switch **down** to move away from a subject.

The zoom ratio is displayed on the screen.

Note: Video recording: supports 4x advance zoom and 4x digital zoom. Still images: supports 1-5m 16x digital zoom; 10m 12x digital zoom. Advance zoom is not available in Camera mode.

3.2.4 Using the LED flash light

Use the LED flash light to illuminate subjects in dark environments.

In **DV** and **Camera** mode, move the joystick left to turn the focus assist lamp on/off. An  icon displays on the screen when activated.

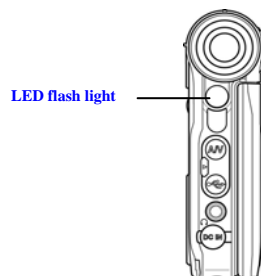

3.2.5 Quick access menu

You can also make adjustments of the current setting by pressing the scroll wheel.

In **Camera** mode, pressing the center joystick button to display the quick access menu. You can adjust the settings such as file size, EV compensation, white balance, image quality and self-timer.



To make adjustments, do the following:

1. Move the joystick or the directional pad **up** to toggle file size options.
2. Move the joystick or the directional pad **down** to toggle image quality options.
3. Move the joystick or the directional pad **right** to toggle the self-timer options.
4. **Press** the center joystick or the square button to display the EV compensation. Move the joystick up/down to adjust the EV value and press the center joystick button to confirm.

3.3 Playback mode







Use **Playback** mode to review all the files stored in the video camera.

3.3.1 Playback mode icons

Refer to the following picture to familiarize yourself with the **Playback** mode icons and symbols.



See the table below for a description of each icon and symbol.

1		Displays the number of current image or video/total number of pictures/video clips
2	 : Video clips 	Shows current file type No icon is shown for still image files
3		File protect indicator
4		Battery status indicator
5		Playback mode icon

3.3.2 Thumbnail mode

When in **Camera Playback** mode, press the **Shutter** button to show image as thumbnails.

1. Turn on the video camera and make sure it is in **Playback** mode.
2. The most recent image displays on the screen. Press the **Shutter** button to view **four** thumbnail images on the LCD screen.

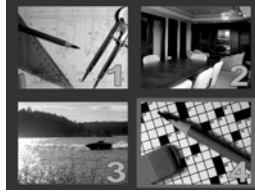

3. Use the joystick to highlight an image, press the **Shutter** button to view the image in full screen mode.
4. Press the **Shutter** button again to return to thumbnail view.

Note: Only image files are shown in thumbnail mode.

3.4 Music mode

The video camera has a built-in music player. Audio files can be played on the camera through earphones or internal speakers.

3.4.1 Music mode icons

Refer to the following picture to familiarize yourself with the **Music** mode icons and symbols.

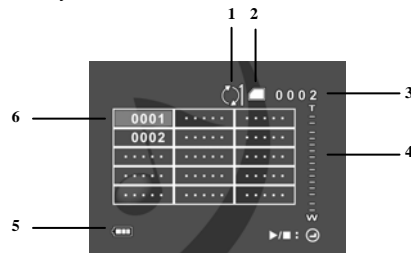

1		Repeat mode indicator : Repeat all : Repeat one
2		Memory status indicator : SD card : Internal memory
3		Displays the number of music files stored on memory
4		Volume indicator
5		Battery status indicator
6		File list

3.5 Voice mode

Use **Voice** mode to record a voice file and store it in internal memory or on an SD card.

3.5.1 Voice mode icons

Refer to the following picture to familiarize yourself with the **Voice** mode icons and symbols.

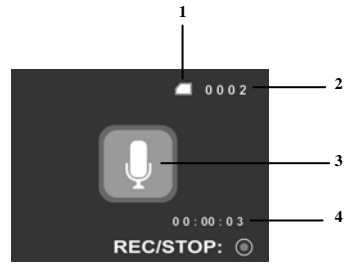

See the table below for a description of each icon and symbol.

1	Memory status indicator
2	Displays number of voice files recorded
3	Voice mode indicator
4	Displays recording time

3.6 USB mode

You can use **USB mode** to connect to a printer or a host PC. Before connecting to a printer or PC, refer to “Installing software and drivers” on page 80.

When the video camera is connected to a computer or printer using the USB cable, the following menu appears:



Use the joystick to highlight an option and press the center joystick button to confirm.

3.6.1 Using the PC cam feature

When set as a **PC cam**, the video camera can be used as a webcam for video conferencing.

3.6.2 Using the mass storage feature

When used as a **USB mass storage device**, the video camera displays as two removable drives in Windows Explorer. One drive is the camera internal memory, and the other is the SD card. Drag and drop files to and from the removable drives just like any other storage device.

3.6.3 Using DPS feature

Connect to a printer using the USB cable exactly in the same way as you would connect a PC.

3.7 Game mode

With this camcorder, the world is your playground. Use the **Game** mode to play one of the 20 built-in video games in this video camera.

3.7.1 Playing video games

The following screen appears when you're on Game mode.



Refer to the section below for a brief introduction and instructions on how to play the games.

Deep Storm



You are a battleship commander fighting your way through a storm of fighter ships, bad weather, and fearsome enemies.

Directional Pad: [4 directions](#)

Left  Button: Fire

Pinball Fish



Travel beneath the sea to capture schools of beautiful fish for the public aquarium. Bounce the capture ball into the fish to collect as many of them as possible. Scoop up bonus icons when they appear, but don't let them distract you from catching fish!

Directional Pad: Left and Right

Left  Button: Launch the ball

Jewel Fever



In this fun puzzle game, you are helping Mr. Stubbs, the fun-loving pirate, collect gems for his treasure chest. As they drop from above, scoop up the gems from one area and fire them somewhere else. When they hit other gems of the same color they are collected.

Directional Pad: Left and Right

Left  Button: Collect gems

Right  Button: Fire gems

Dream Bubble



Four connected bubbles fall in random shapes from the top of the screen. Rotate the shapes to complete a line without any gaps and the line disappears. Prevent the screen from filling up to increase your score.

Directional Pad: 3 directions

Left  Button: Rotate the shape

Right  Button: Set Bomb

Down/Up direction: Accelerate

Busy Bong



Move the crates over all the holes and advance to the next level before time runs out in this exciting puzzle game.

Directional Pad: 4 directions

Left  Button: Undo one step

Right  Button: Reset level

Magic Jelly



Bounce on magic jelly while dodging the enemy, and collecting power-ups. Set bombs to change the color of every jelly cube before the time runs out and you explode!

Directional Pad: 4 directions

Left  Button: Set a bomb

Plumber



Escape the clutches of the evil Bugbear, and watch out for traps along the way. Find the hidden key to advance to the next level.

Directional Pad: 4 directions

Left  Button: Jump

Right  Button: Throw the wrench

Mr. Onion



The Snowman has taken Mr Onion's friend. He must collect all the keys to advance to the next level. Can you help him rescue his friend before it's too late?

Directional Pad: 4 directions

Left  Button: Fire

Bubble Blaster



Blast the multi-colored bubbles before they reach the end of the track. Bubbles can only be destroyed when three or more of the same color bubbles connect. The higher your score, the faster they move.

Directional Pad: 2 directions

Left  Button: Fire

Seek the Resources



Sneak in to the enemy's lair to steal all their resources, watch out for flying bullets and devilish traps.

Directional Pad: 4 directions

Left  Button: Fire

Tiger Rescue



An invading force threatens your country. Their weapons have overwhelmed your defenses, but there is still hope. Select from four experimental fighter planes and fearlessly pilot your country to victory.

Directional Pad: 4 directions

Left  Button: Fire

Right  Button: Activate special weapon

The Lost World



You are trapped in a lost world far from home. Sneak passed guards and traverse perilous rivers as you fight for your life.

Directional Pad: 4 directions

Pool Pro



Help Jim realize his life's dream of becoming a Pool Pro.

Directional Pad: Position the black ball

Left  Button: Adjust the black ball angle, shot

Right  Button: View the ball numbers

Final Escape



Push single bricks into your enemy, or two bricks to make them explode. Destroy all your enemies to advance to the next level.

Directional Pad: 4 directions

Left/Right ( / ) Button: Push brick

Make Way



Help the rabbit find his way home. Destroy all obstacles to find the gate before time runs out and the hunter gets his dinner!

Directional Pad: 4 directions

Left  Button: Destroy obstacles

Lucy Que



Move and rotate the shapes to fill in the picture, or even design your own picture!

Directional Pad: 4 directions

Left  Button: Pick up / Put down a shape

Right  Button: Rotate the shape

Caddie



Knock out three of the same objects in a row to score points before your time runs out!

Directional Pad: 4 directions

Left  Button: Hit an object

Get the Meat



The hungry caveman must find all the food in the shortest time while avoiding wild animals and nasty obstacles.

Directional Pad: 4 directions

Left  Button: Throw the ax

Super Move Quest



Connect any three objects of the same type into a row to score!

Directional Pad: 4 directions

Left  Button: Confirm selection

Find the Way



The baby has lost his way, but a brave dog is leading him home. Cross the forest and the farmland, but watch out for obstacles as you lead the baby to safety.

Directional Pad: 4 directions

Left  Button: Jump

4 Using the menus

Read this section to learn how to configure the camera settings and use the advanced features.

4.1 DV menu

When in DV mode, press the **MENU** button to show the DV Options menu.

4.1.1. Video size

Use this option to set the size of the captured video clips. Larger video sizes contain more detail and therefore use more memory space.

1. Turn the video camera on and ensure it is in **DV** mode.
2. Press the **MENU** button and use the joystick to highlight the **Size** option. Press the center joystick button to display the submenu.
3. Use the joystick to select **640x480** or **320x240**. Press the center joystick button to confirm.

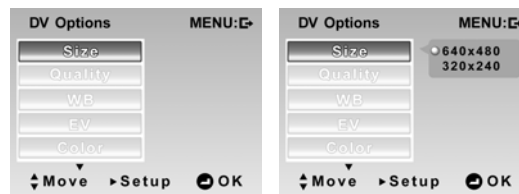

4. Press the **MENU** button again to exit the menu.

4.1.2. Video quality

There are three different levels of video quality setting. Higher quality video needs more memory storage space.

1. Turn the video camera on and ensure it is in **DV** mode.
2. Press the **MENU** button and use the joystick to highlight the **Quality** option. Press the center joystick button to display the submenu.
3. Use the joystick to select **Fine** or **Normal**. Press the center joystick button to confirm.

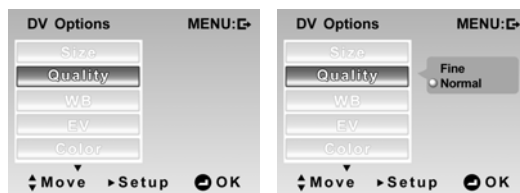

4. Press the **MENU** button again to exit the menu.

4.1.3. White balance

Use this option to correct color difference for different lighting conditions. When white balance is set to **Auto**, the video camera automatically compensates for different lighting conditions.

1. Turn the video camera on and ensure it is in **DV** mode.
2. Press the **MENU** button and use the joystick to highlight the **WB** option. Press the center joystick button to display the submenu.
3. Use the joystick to select **Auto**, **Sunny**, **Cloudy**, **Tungsten**, or **Fluorescent**. Press the center joystick button to confirm.

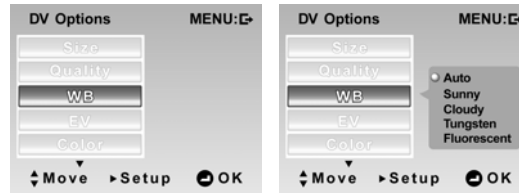

4. Press the **MENU** button again to exit the menu.

4.1.4. Exposure adjustment (EV)

Use this setting to change the exposure for pictures. Usually, this value is set to zero. Increase the value to light up a subject with strong back lighting, or decrease the value if taking a picture of something very bright.

1. Turn the video camera on and ensure it is in **DV** mode.
2. Press the **MENU** button and move the joystick down to go to the next page and highlight the **EV** option. Press the center joystick button to display the submenu.
3. Use the joystick to adjust EV value, which ranges from **+2EV** to **-2EV**. Press the center joystick button to confirm.

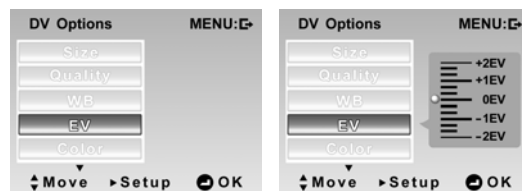

4. Press the **MENU** button again to exit the menu.

4.1.5. Color effect

The camera can capture standard color images, black and white images, or sepia tone to give an old-fashioned look.

1. Turn the video camera on and ensure it is in **DV** mode.
2. Press the **MENU** button and move the joystick down to go to the next page and highlight the **Color** option. Press the center joystick button to display the submenu.
3. Use the joystick to select **Normal**, **B & W**, or **Sepia**. Press the center joystick button to confirm.

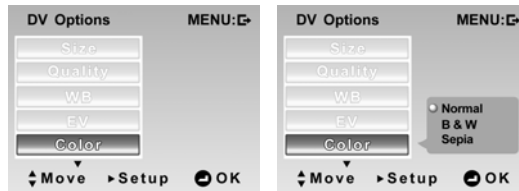

4. Press the **MENU** button again to exit the menu

4.2 DV playback menu

Use the playback menu to manage the files stored in the internal memory or on the SD card.

4.2.1 Delete all

Use this function to delete files.

1. Turn the video camera on and ensure it is in **DV** mode. Press the **Playback** button and then press the **MENU** button to display **DV Playback** menu.
2. Use the joystick to highlight the **Delete all** option. Press the center joystick button to display the submenu.
3. Use the joystick to select **OK** or **Cancel**. Press the center joystick button to confirm.

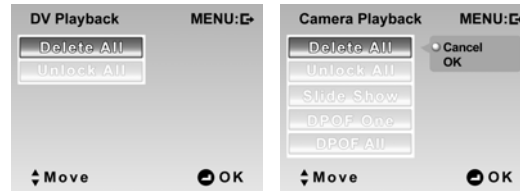

4. Press the **MENU** button again to exit the menu.

Note: Once deleted, files cannot be recovered. Make sure the files are transferred to PC via USB cable or saved to another storage device. Files that have been protected will not be deleted. You have to unlock the files first before deleting them.

4.2.2 Unlock all

Use this function to unlock files that are protected to prevent accidental deletion.

1. Turn the video camera on and ensure it is in **DV** mode. Press the **Playback** button and then press the **MENU** button to display **DV Playback** menu.
2. Use the joystick to highlight the **Unlock all** option. Press the center joystick button to display the submenu.
3. Use the joystick to select **OK** or **Cancel**. Press the center joystick button to confirm.

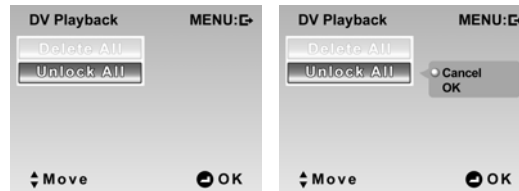

4. Press the **MENU** button again to exit the menu.

Note: To lock a file, move the joystick down in **Playback** mode. A lock icon is displayed to show that the file is protected.

4.3 Picture menu

In **Camera** mode, press the **MENU** button to show the Camera Options menu.

4.3.1 Size

Use this option to set the size of the captured image. Larger images contain more detail and therefore use more memory space.

1. Turn the video camera on and ensure it is in **Camera** mode.
2. Press the **MENU** button and use the joystick to highlight the **Size** option. Press the center joystick button to display the submenu.
3. Use the joystick to select **1M**, **3M**, **5M**, or **10M**. Press the center joystick button to confirm.

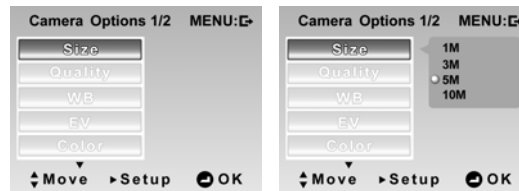

4. Press the **MENU** button again to exit the menu.

4.3.2 Image quality

Use this option to set the quality of the captured image. Higher quality images contain more details and therefore use more memory.

1. Turn the video camera on and ensure it is in **Camera** mode.
2. Press the **MENU** button and use the joystick to highlight the **Quality** option. Press the center joystick button to display the submenu.
3. Use the joystick to select from **Fine**, or **Normal**. Press the center joystick button to confirm.



4. Press the **MENU** button again to exit the menu.

4.3.3 White balance

Use this option to correct color difference due to lighting conditions.

1. Turn the video camera on and ensure it is in **Camera** mode.
2. Press the **MENU** button and use the joystick to highlight the **WB** option. Press the center joystick button to display the submenu.
3. Use the joystick to select **Auto**, **Sunny**, **Cloudy**, **Tungsten**, or **Fluorescent**. Press the center joystick button to confirm.



4. Press the **MENU** button again to exit the menu.

4.3.4 Exposure adjustment (EV)

Use this setting to change the exposure for pictures. Usually, this value is set to zero. Increase the value to light up a subject with strong back lighting, or decrease the value if taking a picture of something very bright.

1. Turn the video camera on and ensure it is in **Camera** mode.
2. Press the **MENU** button and use the joystick to highlight the **EV** option. Press the center joystick button to display the submenu.
3. Use the joystick to adjust EV value. The range is from **+2EV** to **-2EV**. Press the center joystick button to confirm.



4. Press the **MENU** button again to exit the menu.

4.3.5 Color effect

The camera can capture standard color images, black and white images, or sepia tone to give an old-fashioned look. When the color effect function is set to **Normal**, it is set to color mode.

1. Turn the video camera on and ensure it is in **Camera** mode.
2. Press the **MENU** button and use the joystick to highlight the **Color** option. Press the center joystick button to display the submenu.
3. Use the joystick to select **Normal**, **B & W**, or **Sepia**. Press the center joystick button to confirm.



4. Press the **MENU** button again to exit the menu.

4.3.6 Self-timer

This function allows you to capture an image of yourself by adding a 10 second delay between when the **Shutter** button is pressed and when the picture is actually taken.

1. Turn the video camera on and ensure it is in **Camera** mode.
2. Press the **MENU** button and move the joystick down to go to the next page and highlight the **Self-timer** option. Press the center joystick button to display the submenu.
3. Use the joystick to select **Off**, **10 sec.**, or **20 sec.** Press the center joystick button to confirm.

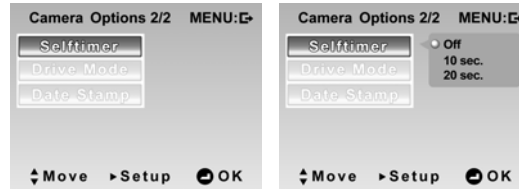

4. Press the **MENU** button again to exit the menu.
5. Press the **Shutter** button and the self-timer starts. An image is captured after the specified time delay.

4.3.7 Drive mode

Use this option to choose taking a picture in **Single** shot or **Continuous** shot mode.

1. Turn the video camera on and ensure it is in **Camera** mode.
2. Press the **MENU** button and move the joystick down to go to the next page and highlight the **Drive Mode** option. Press the center joystick button to display the submenu.
3. Use the joystick to select **Single** or **Continuous** shot . Press the center joystick button to confirm.
 - **Single** shot: Only one picture will be taken.
 - **Continuous** shot: Three pictures are taken in succession when the **Shutter** button is pressed.

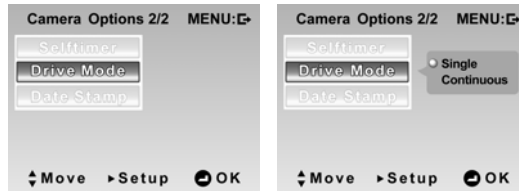

4. Press the **MENU** button again to exit the menu.

4.3.8 Date stamp

Use this option to turn on/off the date stamp when a photo is taken.

1. Turn the video camera on and ensure it is in **Camera** mode.
2. Press the **MENU** button and press the joystick down to go to the next page and highlight the **Date Stamp** option. Press the center joystick button to display the submenu.
3. Use the joystick to select whether to show the date stamp on the screen. Press the center joystick button to confirm.

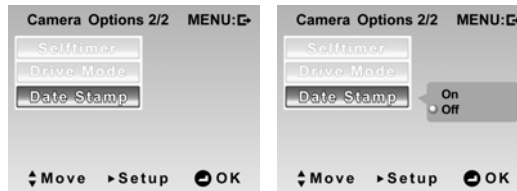

4. Press the **MENU** button again to exit the menu.

4.4 Camera playback menu

4.4.1 Delete all

Use this function to delete files.

1. Turn the video camera on and ensure it is in **Camera** mode. Press the **Playback** button and then press the **MENU** button to display the **Camera Playback** menu.
2. Use the joystick to highlight the **Delete All** option. Press the center joystick button to display the submenu.
3. Use the joystick to select **OK** or **Cancel**. Press the center joystick button to confirm.

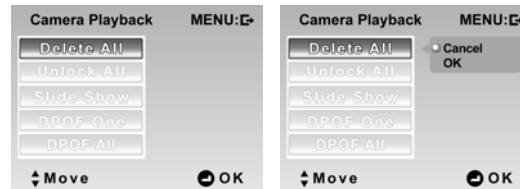

4. Press the **MENU** button again to exit the menu.

Note: Once deleted, files cannot be recovered. Make sure the files are transferred to PC via USB cable or saved to other storage device. Files that have been protected will not be deleted.

4.4.2 Unlock all

Use this function to unlock all protected files.

1. Turn the video camera on and ensure it is in **Camera** mode. Press the **Playback** button and then press the **MENU** button to display the **Camera Playback** menu.
2. Use the joystick to highlight the **Unlock All** option. Press the center joystick button to display the submenu.
3. Use the joystick to select **OK** or **Cancel**. Press the center joystick button to confirm.

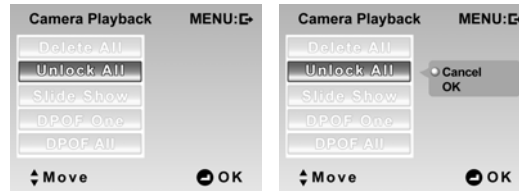

4. Press the **MENU** button again to exit the menu.

Note: To lock a file, move the joystick down in **Playback** mode. A lock  icon is displayed to show the file is protected.

4.4.3 Slide show

The camera includes a slide show function, which displays each image in turn with a regular interval between pictures.

1. Turn the video camera on and ensure it is in **Camera** mode. Press the **Playback** button and then press the **MENU** button to display the **Camera Playback** menu.
2. Press the **MENU** button, and use the joystick to highlight the **Slide Show** option. Press the center joystick button to display the submenu.
3. Use the joystick to select **Start** and press the center joystick button to confirm.

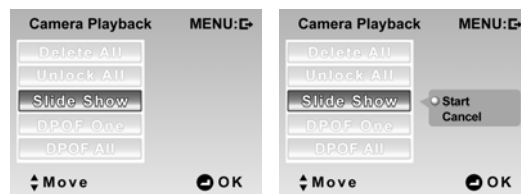

4. The images will be displayed one after another. Press the center joystick button to stop the slide show.

4.4.4 DPOF one

Use the DPOF (Digital Print Order Format) function to tag pictures stored in the memory card with print information. You can tag all pictures to be printed or select individual pictures.

1. Turn video the camera on and ensure it is in **Camera** mode. Press the **Playback** button and then press the **MENU** button to display the **Camera Playback** menu.
2. Press the **MENU** button, and use the joystick to highlight the **DPOF One** option. Press the center joystick button to display the submenu.
3. Use the joystick to select **On/Off**, and press the **OK** button to confirm.

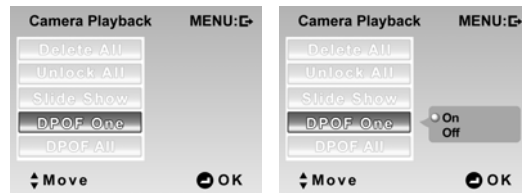

4. The most recent picture is displayed on the screen. Move the joystick up and down to set the number of prints, and move the joystick left and right to select other photos. You can set a maximum of nine prints for each picture.



Note: A memory card is required for DPOF function.

4.4.5 DPOF all

Use the DPOF (Digital Print Order Format) function to tag all pictures stored in the memory card with print information.

1. Turn the video camera on and ensure it is in **Camera** mode. Press the **Playback** button and then press the **MENU** button to display the **Camera Playback** menu.
2. Press the **MENU** button, and move the joystick down to highlight the **DPOF All** option. Press the center joystick button to display the submenu.
3. Move the joystick up and down to select from **Start** or **Cancel**, and press the center joystick button to confirm.

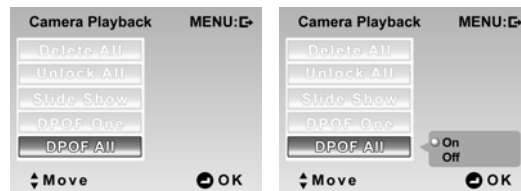

4.5 Music menu

4.5.1 Repeat

Use this function to repeatedly play a single music file or all music files on the SD card or internal memory.

1. Turn the video camera on and ensure it is in **Music** mode.
2. Press the **MENU** button and use the joystick to highlight the **Repeat** option. Press the center joystick button to display the submenu.
3. Use the joystick to select **Normal**, **Single** or **All**.
 - **Normal**: Repeat function is off.
 - **Single**: Repeatedly play the selected music file.
 - **All**: Repeatedly play all music filesPress the center joystick button to confirm.



4. Press the **MENU** button again to exit the menu.

4.5.2 Delete all

Use this function to delete files.

1. Turn the video camera on and ensure it is in **Music** mode.
2. Press the **MENU** button and use the joystick to highlight the **Delete all** option. Press the center joystick button to display the submenu.
3. Use the joystick to select **OK** or **Cancel**. Press the center joystick button to confirm.

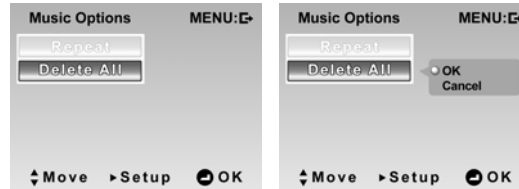

4. Press the **MENU** button again to exit the menu.

Note: Once deleted, files cannot be recovered. Make sure the files are transferred to PC via USB cable or saved to another storage device.

4.6 Setup menu

The **Setup** menu can be accessed from any camera mode and is used to configure miscellaneous camera functions.

4.6.1 Date/time

See section 2.6.1 "Setting the date and time".

4.6.2 Beep

1. Turn the video camera on, and press the **MENU** button to display the menu screen.
2. Move the joystick **right** to display the **Setup** menu and use the joystick to highlight the **Beep** option. Press the center joystick button to display the submenu.
3. Use the joystick to turn the beep **on/off**, and press the center joystick button to confirm.

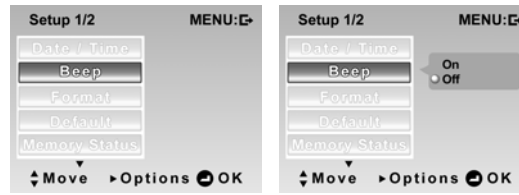

4. Press the **MENU** button again to exit the menu.

4.6.3 Format

Use this function to format the current storage media. This format action will delete everything on the media.

1. Turn the video camera on, and press the **MENU** button to display the menu screen.
2. Move the joystick **right** to display the **Setup** menu and use the joystick to highlight the **Format** option. Press the center joystick button to display the submenu.
3. Use the joystick to select **OK** or **Cancel**, and press the center joystick button to confirm.

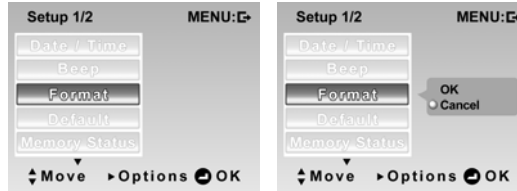

4. The memory card is formatted.
5. Press the **MENU** button again to exit the menu.

4.6.4 Default

Use this option to reset all settings to the default settings.

1. Turn the video camera on, and press the **MENU** button to display the menu screen.
2. Move the joystick **right** to display the **Setup** menu and use the joystick to highlight the **Default** option. Press the center joystick button to display the submenu.
3. Use the joystick select **OK** or **Cancel**, and press the center joystick button to confirm.

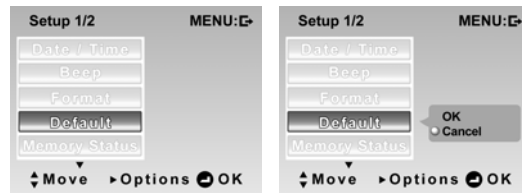

4. Press the **MENU** button again to exit the menu.

4.6.5 Memory status

This function displays the memory status and the number of video clips, photos, music and voice files saved in the video camera.

1. Turn the video camera on, and press the **MENU** button to display the menu screen.
2. Move the joystick **right** to display the **Setup** menu and use the joystick to highlight the **Memory Status** option. Press the center joystick button to confirm.
3. The number of files saved and the free memory space are displayed on the screen. Press the center joystick button again to exit.

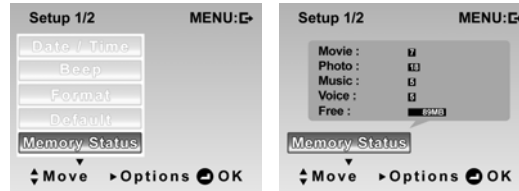

4. Press the **MENU** button to exit the menu.

4.6.6 Language

Please refer to section 2.6.2 "Setting the language"

4.6.7 TV system

1. Use the TV option to set the TV system for the area.
2. Turn the video camera on, and press the **MENU** button to display the menu screen.
3. Move the joystick **right** to display the **Setup** menu. Move the joystick down to go to the next page and highlight the **TV System** option. Press the center joystick button to display the submenu.
4. Use the joystick to select **NTSC** or **PAL**, and press the center joystick button to confirm.

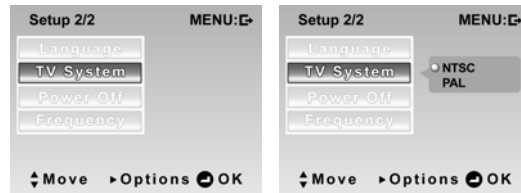

5. Press the **MENU** button again to exit the menu.

4.6.8 Power off timer

Use this function to switch the camera off automatically after a period of inactivity for power saving.

1. Turn the video camera on, and press the **MENU** button to display the menu screen.
2. Move the joystick **right** to display the **Setup** menu. Move the joystick down to go to the next page and highlight the **Power Off** option. Press the center joystick button to display the submenu.
3. Use the joystick to select **Off**, **2 minutes**, or **5 minutes**. Press the center joystick button to confirm.

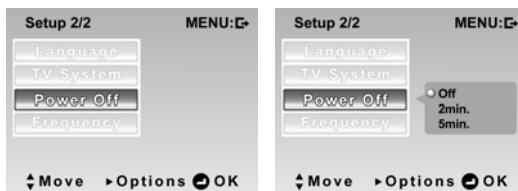

4. Press the **MENU** button again to exit the menu.

4.6.9 Frequency

Use the Frequency option to set the frequency system for your area.

To set the frequency:

1. Turn the video camera on, and press and hold the **MENU** button to display the menu screen.
2. Move the joystick **right** to show the **Setup** menu. Move the joystick down to go to the next page and highlight the **Frequency** option. Press the center joystick button to display the submenu.
3. Use the joystick to select **50Hz**, or **60Hz**. Press the center joystick button to confirm.



4. Press the **MENU** button again to exit the menu.

5 Installing software and drivers

Read this section to learn how to install drivers and software for the camera.

5.1 Drivers

You can use the “Mass Storage” functions of the camera on the PC.

5.1.1 Mass Storage

The digital camera offers Mass Storage function via the built-in card reader. You can treat this digital camera as a USB device.

You will only need to install a driver for the camera if your operating system is Windows 98SE. Windows XP/ME/2000 are plug and play operating systems and do not require a driver to be manually loaded.

When the driver has been installed and the camera is connected, the camera memory and any inserted SD card displays as Mass Storage in Windows Explorer. Files can be dragged and dropped in the same way as with an ordinary disk.

To install the driver, do the following:

1. Insert the supplied CD-ROM in the CD-ROM drive.
2. If the CD-ROM doesn't automatically boot, use Windows Explorer to execute the **InstallMgr.exe** file in the root directory.

The following screen is displayed.



3. Click **Install** to start driver installation.
4. Follow the on-screen instructions.
5. Click **Finish** to restart the computer. Video camera driver installation is complete.

5.2 Presto! Video Works 6

Presto! Video Works 6 is an advanced software application for editing video.

To install Presto! Video Works 6:

1. Insert the supplied CD-ROM in the CD-ROM drive.
2. If the CD-ROM doesn't automatically boot, use Windows Explorer to execute the **InstallMgr.exe** file in the root directory.

The following screen is displayed.



3. Click the **Install** button to begin the installation and process follow the instructions on-screen.

More information about Presto! Video Works 6 can be found in the help files when the application is started.

5.3 Presto! Mr. Photo 3

Presto! Mr. Photo 3 is an advanced photo editing software application.

To install Presto! Mr. Photo 3:

1. Insert the supplied CD-ROM in the CD-ROM drive.
2. If the CD-ROM doesn't automatically boot, use Windows Explorer to execute the **InstallMgr.exe** file in the root directory.

The following screen is displayed.



3. Click **Install** to begin the installation process and follow the instructions on-screen.

More information about Presto! Mr. Photo 3 can be found in the help files when the application is started.

5.4 XviD codec for PC

Installing the XviD codec program

1. Insert the supplied CD provided into the CD-ROM drive.
2. If the CD-ROM doesn't automatically boot, use Windows Explorer to execute the **InstallMgr.exe** file in the root directory.
3. Click **Install** to begin the installation process and follow the instructions on-screen. Click **Next** to continue.



4. Click **I accept the agreement** to accept the conditions of Software License Agreement and click **Next** to continue.

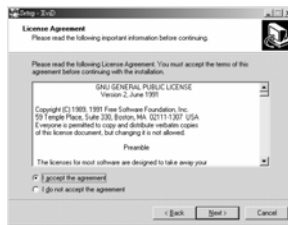

5. Click **Browse** to select the folder location and click **Next** to continue.

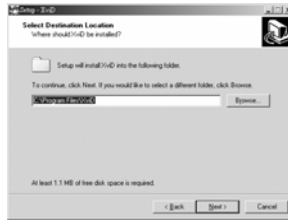

6. Click **Browse** to select a different program folder or click **Next** to continue.



7. Click **Next** to continue from the additional tasks setup screen.

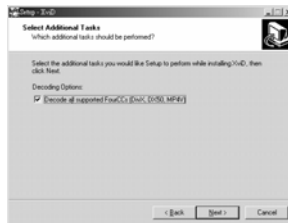

8. Press **Install** to continue from the main program setup screen.

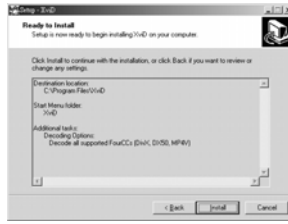

9. Press **Cancel** if you want to stop setup during installation.

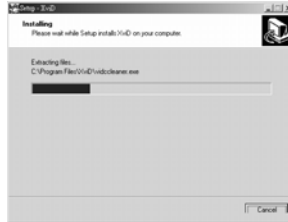

10. The following screen displays after the installation is complete. Click **Finish** to close the setup program.



Appendix

Specifications

General	
Imaging sensor	1/2.5" CMO 5.0 Megapixel sensor
Active pixels	5.0 Megapixel
Storage media	Built-in 32 MB flash memory SD Card (MMC compatible), can support up to 2GB
Sensor sensitivity	Auto
Color effects	Color/B&W/Sepia (video)
Lens	Fixed lens Wide: F/3.1, f=7.5mm
Focus range	Normal: 1.5m~infinity Macro: 21~23cm
Still image	Formats: JPEG (DPOF, EXIF), Direct Print Resolution: 1MP, 3MP, 5MP, 10MP (Firmware interpolation) Quality: Fine, Normal
Movie clips	MPEG-4 Resolution: 640 x 480, 320 x 240

General

	Quality: Fine, Normal Frame rate: 20 fps (max.)
Zoom	Video recording: 4x advance zoom, 4x digital zoom Still image: 1-5m 16x digital zoom; 10 m 12x digital zoom Still image playback: 20x digital zoom (max.)
Audio	Supports music audio format
Audio video	Yes
TFT Monitor	3.0" TFT high resolution (960 x 240 pixels)
Flash	0.5~1.0m range On/Off
White balance	Auto/Sunny/Cloudy/Tungsten/ Fluorescent
EV compensation	-2.0 EV~+2.0 EV (in 0.3 EV steps)
Self-timer	Off, 10, 20 seconds
PC interface	Camera: USB 2.0 (high speed) PC Cam: USB 2.0 (high speed)

General	
TV out format	NTSC/PAL
Remote control	Range 7m (straight)
Shutter	Electronic shutter 1/4~1/1000 second
Auto power off	Off, 2 min., 5 min.
Power supply	One NP60 rechargeable Li-ion battery 5V DC-in
Dimension	90 (W) x 70 (L) x 37 (H) mm
Weight	<165g (without batteries)

Troubleshooting

Problem	Possible Cause	Solution
Cannot turn on the camera.	The battery is not inserted correctly. The battery has no power.	<ul style="list-style-type: none">• Insert the batteries correctly. (See 2.2. Inserting the batteries.)• Charge the battery. (See 2.3 Charging the battery.)
The camera suddenly turns off.	The power off function was enabled. The camera is running out of battery.	<ul style="list-style-type: none">• Turn the power on again.• Charge the battery. (See 2.3 Charging the battery.)
The captured image is not stored in memory.	Before the image is saved the power has been cut off.	<ul style="list-style-type: none">• When the battery indicator turns red, charge battery immediately.

The camera turns off when capturing image using self-timer.	The camera is running out of battery.	<ul style="list-style-type: none"> • Charge the battery. (See 2.3 Charging the battery.)
The image is out of focus.	The subject is beyond focus range.	<ul style="list-style-type: none"> • Please take a picture within the available focus range and choose normal or macro mode. (See 3.2.2 Using the macro function)
IR remote controller does not function.	The remote control is used beyond the range.	<ul style="list-style-type: none"> • Operate the remote control in the available range.
Memory card cannot be used.	<p>The memory card is protected.</p> <p>The memory card contains non-DCF images taken by other cameras.</p>	<ul style="list-style-type: none"> • Unlock the memory card. • Format the memory card. (See 4.6.3 Format.) Before formatting the

		card, ensure you back up the files.
All buttons are inactive.	Short circuit occurred when connecting the camera with other devices.	<ul style="list-style-type: none">• Remove the battery from the camera and insert it again.
Cannot play a video clip on my PC	The video codec may not be installed.	<ul style="list-style-type: none">• Please install the XviD codec (see 5.4 XviD codec for PC)

Website:

Please visit our website at www.dxgusa.com for any product updates or special announcements.

You can also check out our online support desk where you can register your product, send emails to our technical support, and find a list of frequently asked questions (FAQs).

The logo consists of several concentric, semi-transparent white circles of varying diameters, creating a ripple effect. The text "DXG USA (logo)" is positioned to the right of the circles.

DXG USA (logo)

Free Manuals Download Website

<http://myh66.com>

<http://usermanuals.us>

<http://www.somanuals.com>

<http://www.4manuals.cc>

<http://www.manual-lib.com>

<http://www.404manual.com>

<http://www.luxmanual.com>

<http://aubethermostatmanual.com>

Golf course search by state

<http://golfingnear.com>

Email search by domain

<http://emailbydomain.com>

Auto manuals search

<http://auto.somanuals.com>

TV manuals search

<http://tv.somanuals.com>