

Clarion® N.I.C.E.

User's Guide



Navigation In-Car Entertainment

Dear Customer

Congratulations on your purchase of the world's finest brand in the electronic industry. At Clarion we are committed to quality and are confident that you will be pleased with your purchase.

Clarion's Navigation In-Car Entertainment system (N.I.C.E.) system provides four products in one:

- Exceptional navigation supported by a built-in global positioning system (GPS)
- SIRIUS Satellite Radio with 120 channels of information and entertainment (with optional NAVSIR installed)
- Connection for a rearview camera, DVD player or video game system
- Music player and photo viewer with 10GB of storage for music, such as MP3, and JPEG photo files

The unit's compact design, 7-inch digital Thin Film Transistor (TFT) Liquid Crystal Display (LCD) provides high-resolution images that won't strain the eye. This translates into easy-to-use mapping and control screens. The display doubles as a touchscreen control pad.

N.I.C.E. comes with both car cigarette lighter and regular power adapters so you can use the unit in your car or at home.

Clarion welcomes you to an experience like no other. To learn more about Clarion's complete line of audio and video products, please visit us at our Website:

www.clarion.com

This Guide

If you're an experienced electronics owner, read "Quick Start" on page 9 to get started quickly.

If you're new to electronic systems, read this guide carefully.

- For installation procedures, check components at the beginning of "Quick Start" on page 9, then see "Installation" on page 26.
- To learn how to navigate using the GPS, see "Navigation" on page 33.

Warning

Do not let the N.I.C.E. distract you as you drive. You are responsible for the vehicle. Always drive safely and follow traffic rules. It is not recommended to leave your unit in the vehicle because of the exposure to heat.

FCC Notice

This unit complies with the interference limits relative to a Class B digital device, applicable under Part 15 of the FCC Rules regarding installation in a residential environment. If the unit is not installed in accordance with these instructions, it could cause harmful interference to radio or television reception. If this condition persists after corrective action, consult your dealer or experienced installation facility.

Copyright and Trademarks

This document is copyrighted by Clarion. You may not copy any portion of it without permission.

© 2005 SIRIUS Satellite Radio Inc. "SIRIUS" and the SIRIUS dog logo are registered trademarks of SIRIUS Satellite Radio Inc.

All other names are trademarks or registered trademarks of their respective owners.

Contents

This Guide	4	Frequently-asked questions	23
Copyright and Trademarks	4	Navigation	23
1 Quick Start	9	SIRIUS radio	25
Check contents	9	Entertainment options	25
Front view	10	2 Installation	26
Back view	11	Vehicle Precautions	26
Getting started	12	Install the unit in a vehicle	26
Navigation or entertainment	12	Connect power	27
Modes of operation	13	Connecting the radio receiver	28
Start navigation	14	Connect to a rearview camera	29
Define your destination	15	Audio through your car stereo	30
Main navigation screen	16	3 Navigation	33
Sirius Satellite Radio controls	17	How global positioning works	33
Music player controls	18	Starting navigation	33
Photo viewer controls	19	Define your destination	35
Video player controls	20	Navigating to a specific address	37
Using the remote	21	Navigating in an unfamiliar city	38
Remote control features	22	Scrolling through lists	41
Turning the unit off	23	Using the onscreen keyboard	42
		Pointing to your destination	45

Traveling to your destination	47	Playing music while navigating	61
Visually tracking your route	48	Traveling with N.I.C.E.	62
Recovering from a wrong turn	48	4 Customizing	63
Controlling automatic recalculation	49	Changing screen brightness	63
Which way is up	49	Setting the speaker volume	65
Changing map perspective	50	Customizing navigation	66
Zooming in and out	50	Accessing preferences.....	66
Viewing an intersection close up.....	51	Maximizing space for the map	68
Monitoring signal strength.....	51	Shortest time or shortest distance	69
Canceling route guidance	51	Avoiding interstates and toll roads.....	69
Previewing your journey	52	Changing the language.....	70
Turn simulation on	52	Changing distance units.....	71
Define your current location	52	Defining position using lists.....	72
Define your destination	53	Defining position by pointing	72
Backing up safely	54	Turning voice guidance on and off.....	73
Precautions	54	5 SIRIUS Satellite Radio	74
Backing up procedure	54	How satellite radio works	75
Updating the address book	55	Getting started	76
Adding an address	55	Note your ID number.....	76
Adding/editing/deleting addresses	57	Activate the radio service.....	78
Listening to the radio while navigating	60	Antenna Aiming	78

Basic Operations	79	Locking out certain channels	89
Direct tuning by channel	80	Locking a channel.....	89
Tuning by category	81	Accessing locked channels.....	91
Tuning by previewing	81	Restoring a locked channel	91
Previewing by category.....	81	Changing the lock code	92
Previewing all channels	82	Resetting factory defaults	93
Tuning by favorites	82	6 Music modes	95
Storing favorites.....	82	Playing music	95
Direct tuning by band and preset.....	83	Supported formats	95
Tuning by preset number.....	83	Portable music storage	95
Tuning by preset list.....	84	Configuring music playback	96
Searching for favorites	84	7 Video mode	98
Storing favorite information.....	84	Video options	98
Finding favorites	85	Supported format.....	98
Viewing stored favorite information.....	85	Playing a movie or game	98
Deleting one stored favorite.....	85	Connect to the player.....	99
Deleting all stored favorites	85	Viewing a movie or playing a game	99
Parental control features	86	Backing up with the camera	100
Skipping channels	87	Viewing a slide show	100
Accessing skipped channels.....	88	Photo storage	101
Restoring a skipped channel	88	Showing slides.....	101

8	Care and updating	103		
	Cleaning the unit	103		
	Updating the map database	103		
	Copying files	103		
	Removing the unit	104		
	Connecting to your PC	105		
	Copying files	106		
	Disconnecting from the PC	109		
	Deleting photo and music files	110		
	Updating the firmware	111		
	Troubleshooting	113		
9	Reference	117		
	Modes	117		
	Mode buttons	117		
	Mode grid	117		
	Navigation reference	118		
	Onscreen buttons.....	118		
	Start Route Guidance	120		
	Edit Address Book	122		
	Navigation Setup.....	122		
	Set Volume Level.....	124		
	Set Language.....	124		
	SIRIUS satellite radio reference	126		
	Music reference	128		
	Photo reference	128		
	Video reference	129		
	Setup reference	129		
	Specifications	130		
10	Limited Warranty Information	145		

1. Quick Start

Check contents

If anything is missing, contact your dealer immediately.

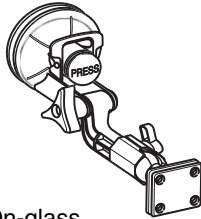

On-glass mounting bracket

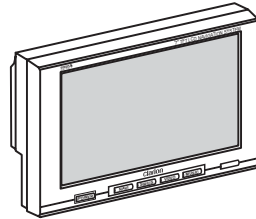

Main unit



Remote control



Carrying bag

Also included: this guide and a packet of four screws



Home power cord and adapter

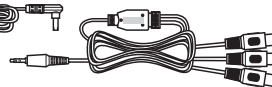

Audio/video cable



Vehicle power cord



Camera input cable

Front view

Liquid Crystal Display (LCD)

Displays maps and entertainment

SIRIUS

Accesses Satellite radio

NAVI

Accesses navigation using the built-in GPS

POWER

Turns the power on and off

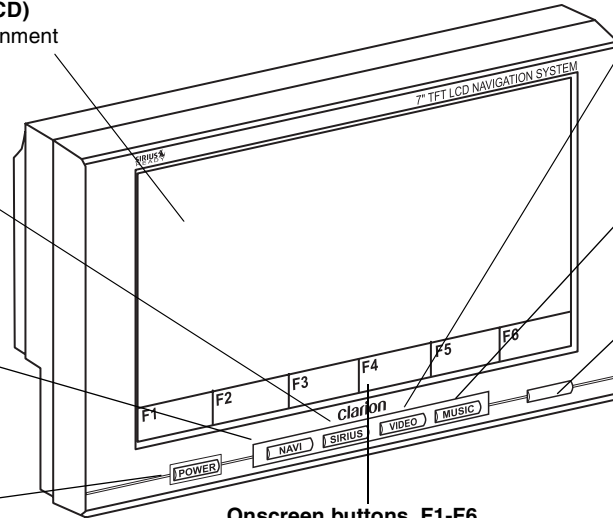

Onscreen buttons, F1-F6

The functions of these six buttons change depending on the mode the unit is in

VIDEO

Used when backing up vehicles equipped with a rearview camera and for video playback

MUSIC

Plays music files

Infrared sensor

Communicates with your remote control

20GB hard disk drive

Located inside the unit: 10GB used to store maps and 10GB for photos and music

Back view

VIDEO IN

Connects to rearview camera

AUDIO OUT

Connects to the stereo AUX input on a vehicle stereo system. To connect without cable, see "Audio through your car stereo" on page 30

EXT. I/O

Connects to Clarion's NAVSIR SIRIUS Satellite Radio interface

A/V IN (RCA input)

Connects to external video source, such as DVD player, camera or video game system

GPS antenna

Rotates at 90 degree angle to unit to improve GPS signal reception

USB 2.0 (DEVICE)

Connects to computer for downloading updated maps, photos and music files; can transfer to and from unit

DC IN

Connects to power cable

USB 1.1 (HOST)

Directly receives memory stick or connects to extension cable for a portable memory storage device; port supports playback/viewing only; you cannot transfer files from or to device

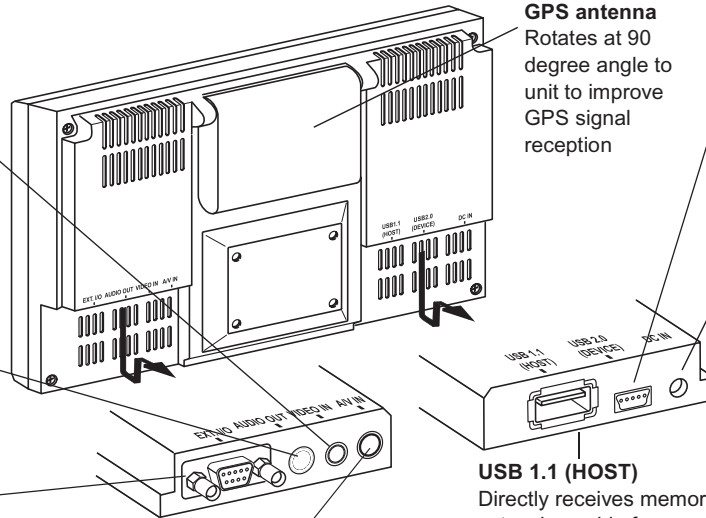

Getting started

1. Press the POWER button.

The Clarion logo appears; if the speaker is on you hear two beeps, and the navigation caution screen appears after a brief pause.

2. Read the caution and press the Press-to-accept button.

Note

Press onscreen buttons firmly and slowly for best performance.

You're ready to use the N.I.C.E. as a navigation tool and entertainment center.

Navigation or entertainment

The mode button



looks like a

toolbox.

Note

The mode button is button F6 in navigation mode. In the other modes, it appears in the upper left corner of the screen.

Pressing this button displays a grid of features from which you can select NAVIGATION, SIRIUS (radio), MUSIC, PHOTO, VIDEO and SETUP.

Modes of operation

NAVIGATION

Corresponds to the NAVI button below the LCD and launches navigation mode. For details, see "Navigation" on page 33.

PHOTO

Launches photo viewing mode. For details, see "Video mode" on page 98.



VIDEO

Corresponds to the VIDEO button and launches video mode. For details, see "Video mode" on page 98.

SETUP

Provides access to three configuration options. For a complete summary of details, see "Setup reference" on page 129.

SIRIUS

Corresponds to button of the same name and launches satellite radio mode. For details, see "SIRIUS Satellite Radio" on page 74.

MUSIC

Corresponds to button of the same name and launches music mode. For details, see "Playing music" on page 95.

Start navigation

Satellite

Green when satellite found; light green when signal is weak; gray when satellite not found

Display area

Used to view maps and navigation menus.



Navigation button (F3)

Start navigation here

Exit button (F1)

Cancels current

NOTE: The big step numbers in this example shows how to begin defining the destination by defining the state first. You can also define a destination by point of interest or by pointing at the map. See "Navigation" on page 33.

Define your destination



Page up (F2) and Page down (F4)
 Move backward and forward through up to four items at a time in a list

Keyboard button (F5) Displays onscreen keyboard for finding names easily
Back button (F6) Returns to the previous menu

Main navigation screen

Next maneuver

Shows next turn you will make

Pointer

Indicates current location on map

Compass

Indicates current direction of movement or location of north

Scale

Indicates current map scale

ZOOM (F1 and F2)

Enlarges and reduces map

Route

Highlighted in magenta

Next intersection

Pops up as you approach next intersection

Map view (F4)

Alternates among 2D, 3D and split-screen map views

Speaker button (F5)

Repeats verbal guidance for next maneuver

Mode button (F6)

Displays grid of features; see "Modes of operation" on page 13

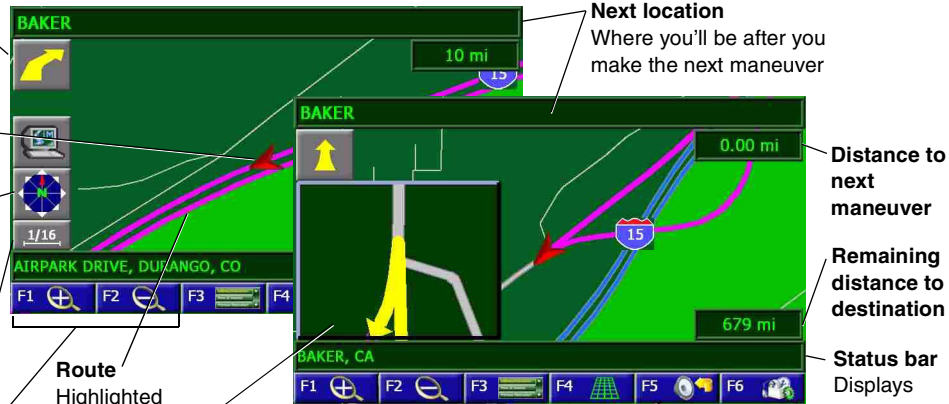
**Next location**

Where you'll be after you make the next maneuver

Distance to next maneuver

Remaining distance to destination

Status bar
Displays current location

Sirius Satellite Radio controls

The diagram shows a Sirius Satellite Radio control interface with the following components and descriptions:

- Current mode**: Points to the 'SIRIUS' logo at the top of the screen.
- Mode button**: Points to the 'MENU' button at the top of the screen. Description: Opens the menu grid.
- Channel indicator**: Points to the 'Channel Tune Mode' header at the top of the screen. Description: Identifies the channel.
- Band or preset indicator**: Points to the 'CH : 184' and 'Band : A' indicators. Description: Way to group favorite channels.
- Channel buttons**: Points to the '<< CH' and 'CH >>' buttons. Description: Moves to the previous and next channels.
- Keypad buttons**: Points to the numeric keypad (1-0). Description: Jump directly to a channel or preset; hold to store preset.
- MENU**: Description: Displays options menu.
- BAND**: Description: Switches among bands A, B and C, each with 10 preset channels; hold to tune by preset.
- MEMO (memory)**: Description: Stores up to 20 artist, song title combinations; hold to recall stored information.
- DISP (display)**: Points to the 'DISP' button at the top of the screen. Description: Hold to display list of channels.
- Signal strength meter**: Points to the signal strength icon in the top right corner. Description: Shows strength of SIRIUS satellite signal.
- Artist, composer, title**: Points to the 'CH NAME : Preview' and 'CAT NAME : ENTERTAINMENT' text. Description: Display in two lines.
- Channel name**: Points to the 'CH NAME : Preview' text.
- Category name**: Points to the 'CAT NAME : ENTERTAINMENT' text. Description: Content group.
- Category previous and next**: Points to the '<< CAT' and 'CAT >>' buttons. Description: Moves to previous and next categories.
- Volume up and down**: Points to the '+' and '-' volume buttons. Description: Adjusts internal speaker volume.

Music player controls

Portable memory storage button
Displays contents of a portable memory storage device connected to the USB 1.1 port

Folder button
Displays music folders

Music mode button
Alternates among playback options: normal, repeat, repeat folder and random

Mode button
Opens the menu grid



NOTE: If playing music on a portable memory storage device, you can only play; you cannot transfer files to or from the device.

Photo viewer controls

Portable memory storage button

Displays contents of a portable memory storage device connected to the USB 1.1 port

NOTE: You can only view photos on a portable memory storage device; you cannot transfer them to or from it

Mode button

Opens the menu grid

Full-screen button

Enlarges photo to fill screen; touch the screen to return to photo default size

Previous and next buttons

Display the previous and next photo

Slide show button

Starts slide show

NOTE: You can only view photos that are 1MB or smaller in size



Video player controls

Full-screen button

Enlarges image to fill the screen; touch the screen to return to photo default size

Audio/Video input

Displays input from DVD or video game system

NOTE: Unit disables video playback when vehicle is in motion

Mode button

Opens menu grid

Rearview camera

Displays video input from camera mounted at back of vehicle

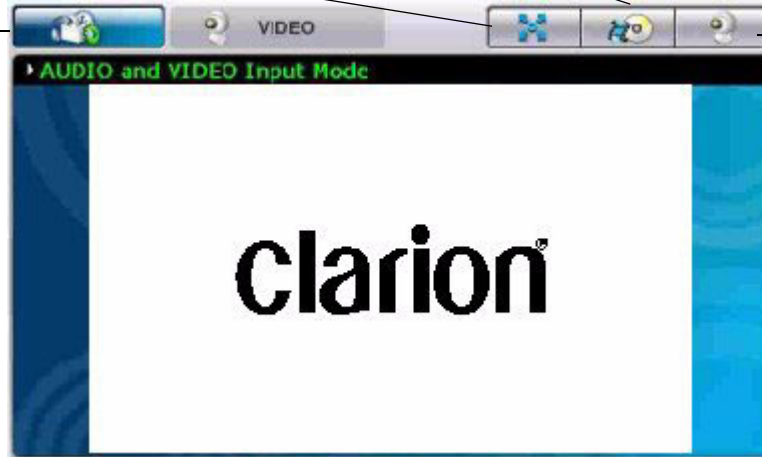

Using the remote

The wireless remote control supplied with N.I.C.E. operates most features from a remote location. The buttons on the remote control function the same way their equivalents do on the unit.

For optimal operation, always aim the remote control toward the infrared sensor on the N.I.C.E. front panel.



Infrared sensor

Front of N.I.C.E.

Remote control features

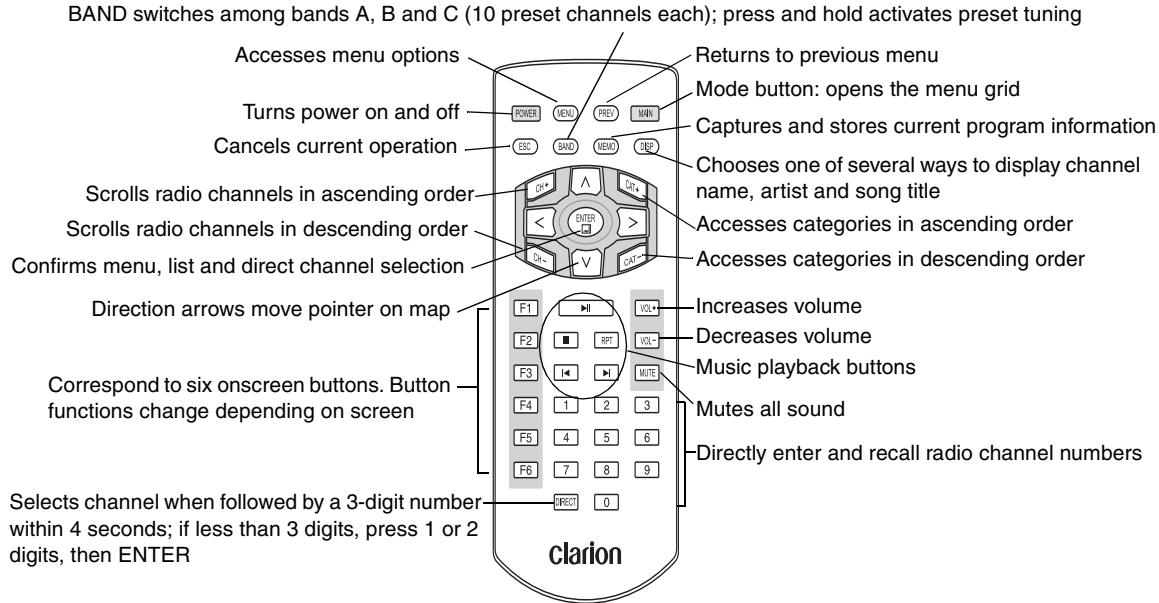

Turning the unit off

Press the POWER button. The unit stores the current mode and turns off.

When you turn the power on again, the unit returns to the mode you were in when you powered off.

Frequently-asked questions

The questions in this section are often asked by people who are learning to use N.I.C.E. For troubleshooting help, see "Troubleshooting" on page 113.

Navigation

Can I review the planned route without actually driving it?

- Yes. In Setup, Navigation Preferences, press Simulation Off to change it to Simulation On. When you define your destination, the unit simulates the route independent of the GPS.

I don't like to drive on freeways (interstates). Can N.I.C.E. calculate a route without going on the freeway?

- Yes. In Setup, Navigation Preferences, press Avoid Freeway No to change it to Avoid Freeway Yes.

I don't like toll roads. Can N.I.C.E. calculate a route that avoids toll roads?

- Yes. In Setup, Navigation Preferences, press Toll Yes to change it to Toll No.

Can N.I.C.E. calculate a route that may be a little out of the way, but that may save time?

- N.I.C.E. assumes that going by interstate is faster than going by normal roads. In Setup, Navigation Preferences, change Shortest Distance to Shortest Time and the unit will route you via interstate if one is nearby.

Can I get rid of all the information icons and boxes so I can see more of the map?

- Yes. In Setup, Display Options, press GPS Icon Display, Status Bar Display, etc. to turn them off.

Can I hear the voice announcing the next maneuver again?

- Yes. While traveling in the direction of the next maneuver, press the speaker button (F5).

Can I find out what road I am currently on?

- The unit displays your current location in a status box at the bottom of the screen.

Can I tell how far it is to the next maneuver?

- The voice guidance announces the distance to the next maneuver well before you get there, if voice guidance is on. A box in the upper right of the screen constantly updates this distance.

Does the unit show me how many miles are left to the destination?

- Yes. The unit displays miles (or kilometers) remaining in the box at the lower right of the screen.

What is the yellow arrow in the upper left of the screen?

- This arrow indicates the next maneuver.

Why does the map always display north at the top? I want the top of the map to show the direction I'm traveling.

- In Setup, Navigation Preferences, press North Up to change it to Heading Up. This changes the map orientation so that the direction you are heading is at the top of the map.

SIRIUS radio

Can I listen to SIRIUS satellite radio while I navigate?

- Yes. While in navigation mode, press SIRIUS and the unit overlays the top portion of the screen with the SIRIUS controls. Voice guidance always overrides the radio.

Entertainment options

Can I play music files while I navigate?

- Yes. While in navigation mode, press MUSIC and, as with the radio, the unit overlays the top portion of the screen with the MUSIC controls. Voice guidance overrides the music.

2. Installation

This chapter explains how to install the unit in a vehicle and use it at home.

Vehicle Precautions

Follow these precautions to avoid serious auto accident or personal injury:

- Do not mount the N.I.C.E. where it will block your view through the windshield or your view of dashboard indicators and displays.
- Do not mount the N.I.C.E. where it might obstruct the operation of a safety device, such as air bags, etc.

Install the unit in a vehicle

1. Using the screws supplied, mount the N.I.C.E. onto the on-glass mounting bracket.

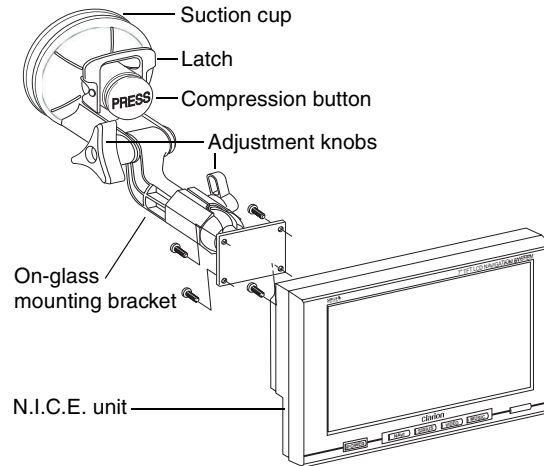

On-glass mounting bracket and unit

- Place the on-glass mounting bracket in position with the suction cup touching the glass.

Make sure it does not obstruct the driver's view of the road from any angle, but still has a direct path through the windshield to the GPS satellite. If you are not sure consult a professional installer for help.

- Press and hold the compression button.
- While holding the compression button, lift the latch towards the compression button until it locks in place.
- Adjust the position of the unit using the adjustment knobs.
- You may extend the unit's GPS antenna by lifting it to a 90 degree angle with the unit or leave it as is and extend it later if the GPS signal is weak.

Connect power

- Plug the vehicle power cord into the DC IN socket on the unit.

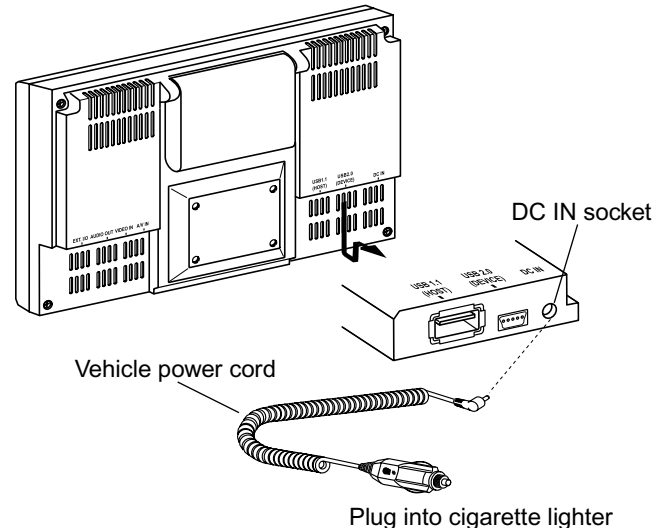

Power connection

2. Plug the other end of the cord into the cigarette lighter socket of your vehicle.
3. Turn the power on and your ready to use N.I.C.E. for navigation.

Connecting the radio receiver

If you also have the NAVSIR satellite radio receiver installed, follow these steps to connect it to the N.I.C.E.

1. Connect one end of the NAVSIR cable to the external I/O port on the back of the N.I.C.E.

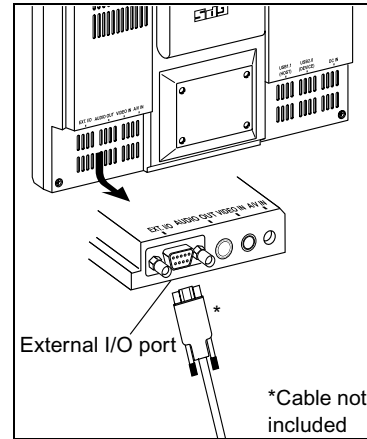

NAVSIR connection

2. Connect the other end to the NAVSIR.

See the NAVSIR documentation for where to connect this cable.

Note

NAVSIR receives power through the N.I.C.E.

Connect to a rearview camera

If your vehicle is equipped with a rearview camera for backing up, connect the camera to the N.I.C.E.:

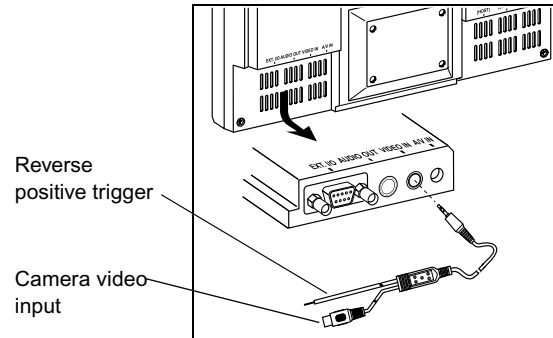

Camera connection

For connecting to the reverse gear, consult a professional installer.

Audio through your car stereo

As the N.I.C.E. is a portable device and designed to travel with you, it comes with its own internal speaker.

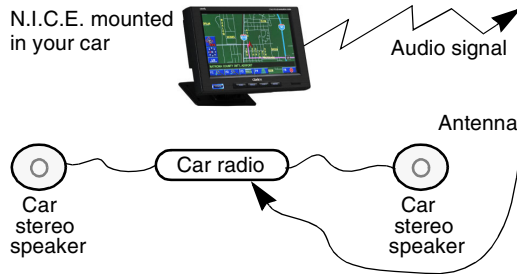

How the FM transmitter works

While riding in a vehicle, the unit's built-in FM transmitter can send audio output from the N.I.C.E. through your vehicle's radio antenna to its stereo system.

Follow these steps to activate the FM transmitter:

1. Press the onscreen mode button (F6 in navigation mode).
2. Press SETUP on the menu grid.



N.I.C.E. SETUP button

Menu grid

1. The Unit displays the SETUP menu.

FM frequency and internal speaker button



N.I.C.E. SETUP menu

2. Press the FM Frequency and Internal Speaker button.

The unit displays the FM Frequencies and Internal Speaker menu.

3. Press FM Transmitter on the touch-sensitive screen.

The unit displays a list of frequencies.

Mode button

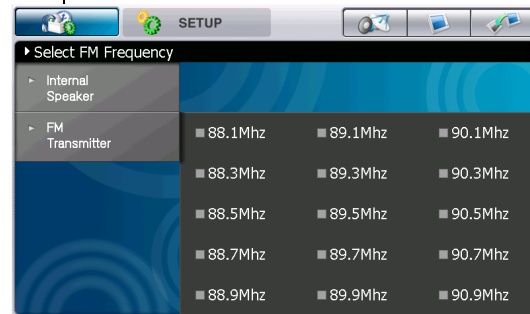

FM Frequencies List

Although the unit will work on a frequency that is transmitting a radio station, some interference may occur. For best performance,

select any frequency that is not in use by a radio station.

4. Press one of the frequencies.

The unit automatically begins transmitting and returns to the SETUP menu.

Note

Turn this option off if you are using low level audio outputs in your particular application.

3. Navigation

This chapter explains how to navigate using the N.I.C.E. If this is the first time you've used the unit, read this chapter from beginning to end. Later, use it to refer to specific procedures.

How global positioning works

N.I.C.E. uses a global positioning system (GPS) to provide easy navigation anywhere within the United States and Canada, providing no obvious satellite signal obstructions are in the way. Obstructions

include nearby buildings, high terrain, parking garages and tunnels.

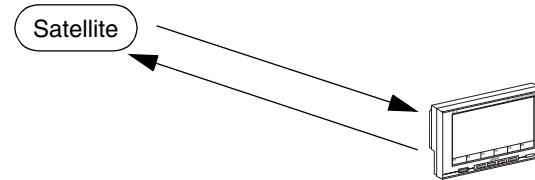

N.I.C.E. communicates with an overhead satellite to calibrate its position

Starting navigation

Caution

If your car has been sitting in the sun, the N.I.C.E. may be hot to the touch and sunlight may make it difficult to read the screen.

The unit starts up in the mode that was running when you turned the power off. If this is the first time you've used the unit, it starts in navigation mode. Otherwise:

1. Press the NAVI button below the LCD.



Navigation button

OR

Press the onscreen mode button, then press the onscreen NAVIGATION button.



Mode and navigation onscreen buttons

A caution screen appears.



Navigation caution screen

2. Read the caution, then press the Press-to-accept button.

Note

Press onscreen buttons firmly and slowly for best performance.

If the unit is within site of a satellite, the GPS automatically locates you on the map.



GPS signal strength indicator

Current position

Main navigation screen

The red pointer identifies your position.

Define your destination

Warning

Always define your destination while parked. Do not attempt to define a destination while driving.

1. Press the navigation button (F3).

The Navigation menu appears.

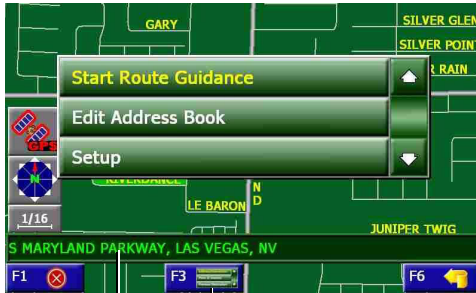

Current location Navigation button (F3)

Navigation menu

The status bar, located just above the onscreen buttons at the bottom of the screen displays your current location and system status information, such as the active menu name.

2. Press Start Route Guidance

The unit displays several ways to select a destination.

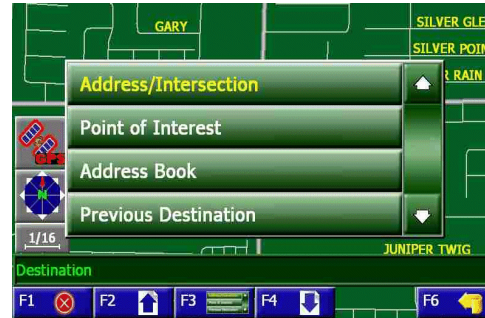

Destination options

There are two basic ways to define a destination:

- Use lists to define the address.
- Point to it on the map (scroll down to see this option).

3. Press one of the method options.

If you scrolled down and chose Map, you can define your destination by touching the map. See “Pointing to your destination” on page 45.

If you chose any of the other options, the unit prompts you to choose items from one or more lists.

- Address or intersection

For more on this method, continue reading the next topic.

- Point of interest

For more on this method, see “Navigating in an unfamiliar city” on page 38.

- Address book

This option lists addresses previously stored in the address book by name.

Use this method for a destination in your area that you visit occasionally. For how to store an address, see “Updating the address book” on page 55.

- Previous destination

This option lists your last 15 destinations.

Use this method when traveling to quickly recall temporarily important addresses, such as your hotel or rental car agency.

Navigating to a specific address

Address/Intersection provides four ways to enter the address: state or province name, postal code, city name or street name. You can start with any of the four.

Use this method to travel to a new location for which you have a specific address.

The unit displays the names of four lists



Address/Intersection options

State/Province Name, City Name and Street Name lead to lists. See “Scrolling through lists” on page 41.

By postal Code goes directly to the onscreen keyboard. See “Using the onscreen keyboard” on page 42.

Navigating in an unfamiliar city

Point of interest lets you define a destination when you don't know its address.

This method is especially useful when traveling in an unfamiliar city. It can save time and the expense of driving around when you need to find, for example, a gasoline station or a grocery store.

The N.I.C.E. database maintains a list of two million points of interest organized by categories, such as city center, airport, restaurant, and tourist information.

After selecting Point of interest, the unit offers five options:



Four of the point of interest options

- State/Province Name limits all other lists (postal code, phone, and first few letters). See “Scrolling through lists” on page 41.
- By Category displays a list of categories.
- By Postal Code and Phone go directly to the onscreen keyboard. See “Using the onscreen keyboard” on page 42.

1. Scroll down to view the fifth point of interest option.



Fifth point of interest option visible

By First Few Letters is especially useful if you know only the state or province in which a famous place is located, but you don't know how it might be categorized nor do you know its postal code or phone number.

2. Select an option.

For State/Province Name, By Postal Code, By Phone and By First Few Letters, see “Using the onscreen keyboard” on page 42.

The following screen displays when you choose By Category.



Categories list

3. Select the type of place you're looking for, such as a bank or ATM.

The unit prompts you to choose how to display the locations.

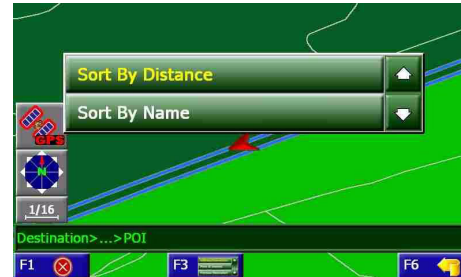

Sort point of interest locations options

4. If you know the name you're looking for, choose Sort By Name.

If you're in an unfamiliar city press Sort By Distance for the closest point of interest.

5. Select the destination from the resulting list.

Continue with “Traveling to your destination” on page 47.

Scrolling through lists

There are two ways to scroll through a long list, such as the list of city names.



Multi-item scroll buttons (F2 and F4) scroll up to four items at a time

Up and down scroll buttons scroll one item at a time

List of city names with scrolling arrows

- Scroll through the menu one item at a time, using the menu's up and down scroll buttons.
- Scroll through the menu options up to four items at a time, using the onscreen multi-item scroll buttons (F2 and F4) at the bottom of the screen.

If the list is long, press the keyboard button (F5) and use the onscreen keyboard.

Using the onscreen keyboard

State/Province Name, City Name, Street Name, By Postal Code, By Phone, and By First Few Letters display a list.



Keyboard button (F5)

Sample list showing states and provinces

Some options display this keyboard automatically. Lists give you the choice of scrolling or using the keyboard to save time.

1. If you're viewing a long list, such as all the streets in California, press the keyboard button (F5).

The unit displays the onscreen keyboard.

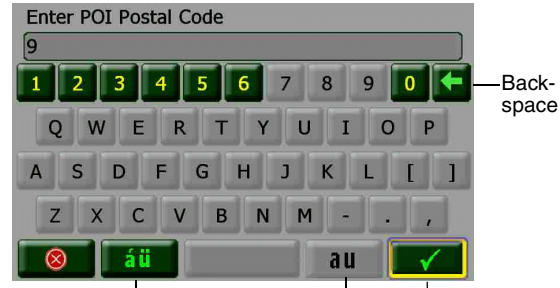

Special characters button

Accept button

Standard characters button

*Onscreen keyboard ready to type
point of interest postal code*

2. Press the first few letters of the name or postal code.

Only keys for valid letters appear in green. The rest are grayed out. The letters you type appear in the box at the top of the keyboard.

If you've defined your state and are entering a postal code the unit fills in the beginning digit based on the system database. This helps avoid typing errors.

In the example, the first digit, "9" of the postal code appeared automatically and only the keys needed to enter the rest of the postal code are available.

3. To type letters with diacritical marks, such as "é" and "ñ," press the special characters button.
4. Press the standard characters button to return to standard characters.

Press the backspace key if you make a mistake.

5. After typing one or more characters, press the accept button (check mark).

The system generates a short list of options based on the characters you typed so far.

The following is an example of a short list of cities.

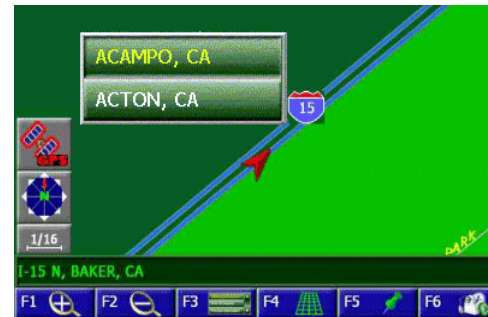

Short list of cities

The next example is a short list of streets.



Short list of streets

Above this list the unit displays the address range for all the streets in the list. A quick check with the address you're seeking should confirm that you are in the right area.

6. Press an item to select it.

When you select the street, the unit gives you the option of specifying a specific house/ building number or an intersection.



Address or intersection

If you choose Address, the unit displays the valid range of addresses at the top of the onscreen keyboard.



Keyboard with address range

7. Type the address and press the accept button (check mark).

Continue with “Traveling to your destination” on page 47.

Pointing to your destination

Rather than enter an address, you can use your finger to touch a location on the map.

1. Press the navigation button (F3) followed by Start Route Guidance, then scroll down to Map and press it.

OR

Just touch the location you wish to use as your destination on the map without pressing the navigation button first.

Crosshairs appear at your current location.



Crosshairs

Crosshairs mark the location you touched

2. Touch the location on the map.

If the location is not on the map, touch the map in the direction of the location as if your finger was doing the traveling.

Continue touching the map until you pinpoint the location.

3. Press the push pin button (F5).

The unit displays the selected destination as a list item.

4. Press the name to confirm the location.

If you started by pressing the navigation button, continue with the next topic.

If you just pointed to the destination, the unit prompts you to select how to use the location.

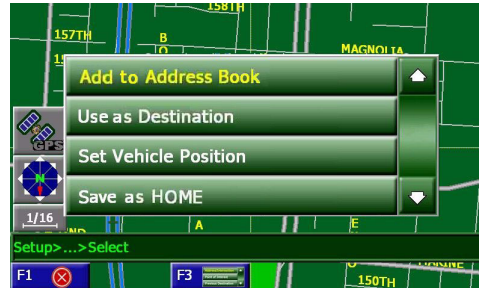

Uses for a pinpointed location

5. Press Use as Destination and continue with the next topic.

Traveling to your destination

Once you select a destination, N.I.C.E. calculates your route, based on any preferences you set (See “Customizing” on page 63). Route calculation progress appears on the status bar.

Note

The longer your journey, the longer the system takes to calculate your route. If you're driving across the country, don't worry if the unit takes a few more seconds.

A magenta line traces the beginning of your journey and your next appears at top left.

Directions can be visual only, or include verbal instructions, depending on whether or not you prefer

voice guidance to be on or off. See “Turning voice guidance on and off” on page 73 for more information about this option.

If voice guidance is on, you hear is “Please proceed to the highlighted route.” Once you begin driving, N.I.C.E. will provide additional instructions.

Start driving. If at any time you want to hear the verbal instruction again, press the speaker button (F5).

Note

If signal strength seems weak, extend the GPS antenna on the back of the unit. To locate the antenna, see “Back view” on page 11.

Visually tracking your route

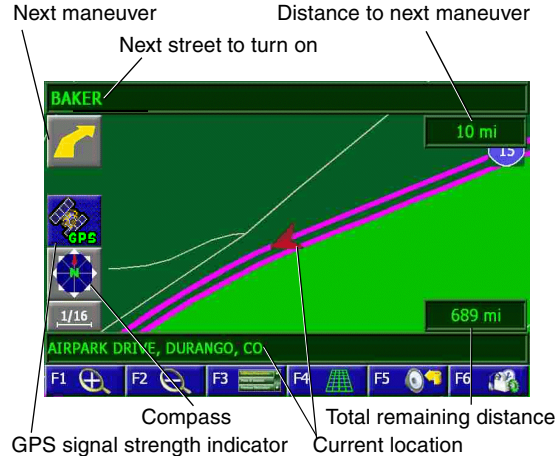

Map during navigation

The red pointer moves on the map as you drive and your current location appears in the status bar

located just above the buttons at the bottom of the screen.

A close-up of your next maneuver displays in the upper left corner of the screen.

The name of the next street to turn onto appears in the bar at the top of the screen and the distance to the next maneuver appears in the upper right corner.

The total trip distance displays in the lower right corner.

Recovering from a wrong turn

Don't worry if you miss a turn or intentionally stray off course to avoid roadwork or an accident. With automatic recalculation on, N.I.C.E. remaps your journey as soon as you turn away from its calculated route.

It also updates the compass information and onscreen distance indicators.

Controlling automatic recalculation

If you don't want the unit to recalculate your route, you can turn automatic recalculation off.

For example, you may know how to detour around an accident and want to just continue with the same journey after the detour.

1. Press the navigation button (F3), then press Setup.
2. Press Navigation Preferences and scroll down to Auto Recalc On.
3. Press this button to turn automatic recalculation off.

The original route remains highlighted.

4. Turn this option back on again after the detour.

Which way is up

The top of the screen can always point north or it can point in the direction you are traveling.

- North Up displays a map with north always toward the top of the screen.
- Heading Up displays a map with your direction of travel always toward the top of the screen.

This setting makes the map move around more as you travel, but some people prefer it.

You'll have to try both settings to decide which you prefer. See "Customizing" on page 63.

Changing map perspective

N.I.C.E. offers three different map views.



Map button

3D perspective with clouds

Press the map button to alternate among 2D, 3D and split screen views. With 3D view you can see more of the road ahead. Daytime blue sky and clouds turn to stars at night.

Zooming in and out

Pressing the zoom buttons changes the scale of the map.

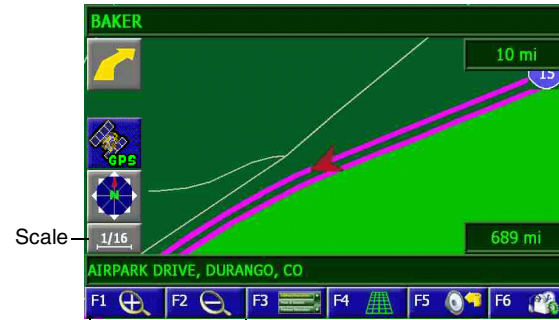

Scale

Zoom buttons

Map during navigation

The farthest you can zoom in is to 1/16th of a mile. The farthest out you can zoom is to eight miles.

Viewing an intersection close up

When you are within one mile of the next intersection, N.I.C.E. displays an enlarged view of the intersection on the left side of the screen

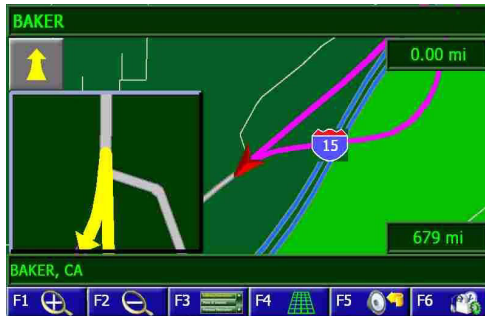

Enlarged intersection

To turn this feature off, see “Maximizing space for the map” on page 68.

Monitoring signal strength

The GPS indicator shows the strength of the GPS signal:



Strong signal (green)



Weak signal (light green)



No satellite connection (gray)

Canceling route guidance

If you change your mind after selecting a destination:

1. On the main navigation screen, press the navigation button (F3).

The unit displays three options.



Navigation options menu

2. Press Cancel Route.

The main navigation screen appears.

Previewing your journey

This procedure lets you preview a route starting from any location.

Turn simulation on

This feature activates route guidance without actually going anywhere.

1. Press the navigation button (F3).
2. Press Setup.
3. Press Navigation Preferences.
4. Scroll down and press Simulation to turn it on.

The simulation icon replaces the signal strength indicator along the left edge of the screen.

5. Press the exit button (F1) to close Setup.

Define your current location

1. Touch any location on the map.

Crosshairs appear and the unit centers the point you touched on the screen.

If the address is not on the map, touch the map in the direction of the address as if your finger was doing the traveling.

Continue touching the map until you find the location.

2. Press the push pin button (F5).

The unit displays the selected location as a list item.

3. Press the name to confirm the location.
4. Press Set Vehicle Position.

The red pointer moves to this position.

Define your destination

Touch your destination as you did for defining your current location.

OR

Press the navigation button (F3) and use the menus to define your destination.

As soon as definition is complete:

- The unit calculates the route and begins route guidance.
- The red pointer moves along the route in 0.01 mile increments.
- A beep sounds when the unit turns onto a new street.

Note

After you've previewed your journey, Simulation automatically resets itself to off.

Backing up safely

If you own a van or SUV, you know how difficult it can be to maneuver into or out of a parking space. With a camera mounted at the back of your vehicle and your N.I.C.E. installed, you can back up safely.

Precautions

- Always back up with care.
- Objects in on the video screen may be larger than they appear.

Backing up procedure

When the N.I.C.E. detects that you have put the car into reverse, it switches to rearview camera mode.

Note

*Automatic camera on requires the the reverse trigger be connected.
Consult a professional installer.*

If the reverse trigger is not connected:

1. Press the VIDEO button below the LCD.

OR

Press the mode button, press VIDEO on the menu grid, then press the audio/video input button.

2. Press the Camera button.

The output from the camera displays in the video window.



Video window

3. Press the full-screen button to stretch the video input to fill the screen. Press the screen to return to the default menu.

Updating the address book

Adding addresses to the address book involves selecting an address from the N.I.C.E. database and associating a name, such as “Office,” “Grandma’s house” with that address.

The only aspect of the address book that you can later edit is the name you associate with an address.

Adding an address

You may add your current address or an address after using it as a destination to the address book. The following procedure explains how to add an address without using it as a destination first.

1. Touch the address location on the map.

Crosshairs appear and the unit centers the point you touched on the screen.



Crosshairs mark the location you touched

If the address is not on the map, touch the map in the direction of the address as if your finger was doing the traveling.

If the location is a long way away from the current location, zoom out (F2) before you touch the map, then zoom in again (F1) when you are getting close to the location.

Continue touching the map until you find the location.

2. Press the push pin button (F5).

The unit displays the selected location as a list item.

3. Press the name to confirm the location.
4. Press Add to Address Book.

The unit displays the onscreen keyboard.

5. Type a name to associate with this address, such as "Friend's house," "Market," etc,
6. Press the accept button (check mark) to save the name.

The unit asks you to confirm the save.

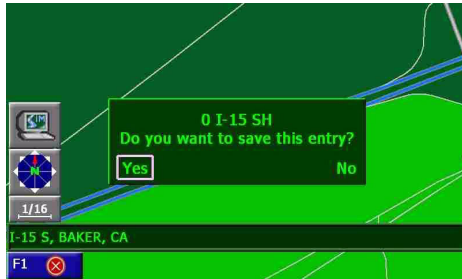

Sample confirmation message

The name associated with the example above is, "O I-15 SH."

7. Press Yes to save the name or No to return to the previous menu.

Adding/editing/deleting addresses

1. Press the navigation button (F3).

2. Press Edit Address Book.

The unit gives you four options:

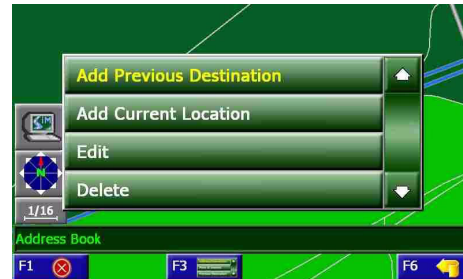

Edit address book options screen

- Add Previous Destination displays a list of previous destinations including the one you just entered,
- Add Current Location lets you enter your current location.

- Edit lets you change the name associated with an address.
- Delete removes the address from the address book.

3. Press the desired option.

If you pressed Add Previous Destination, the unit displays a list of previous destinations.



Previous destinations list

If you chose to edit an existing name, the unit displays a list of the addresses currently stored.

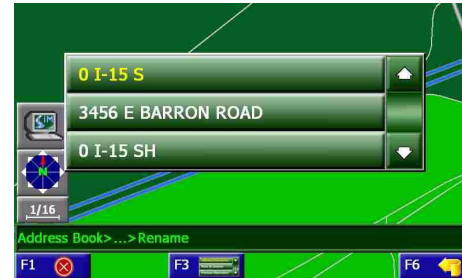

Currently-stored address list

4. Press the desired item.

The onscreen keyboard appears, with the address name displayed near the top.

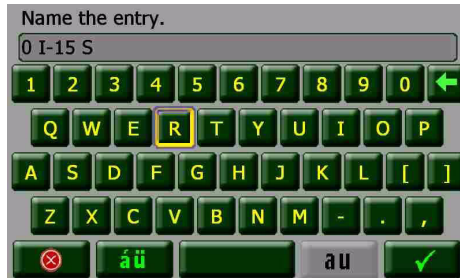

Name The Entry screen

You can edit only the name associated with the address. To change the address itself, delete it and add it again.

5. Press the accept button (check mark) to save the address using the displayed name.

OR

Press and hold the backspace button to erase the existing name, then type a name.

For example, rather than use the address of our local school as the name, you could change it to "SCHOOL."

6. Press the accept button (check mark) to save the edited name.
- A confirmation screen appears.
7. Press Yes to save your entry or No to return to the Name-the-entry screen.

The main navigation screen appears.

Listening to the radio while navigating

To listen while you navigate, press the SIRIUS button below the LCD.

The SIRIUS controls overlay the top of the navigation screen.



Minimized radio controls overlay the navigation screen

When minimized, only the top line appears.

When maximized, two additional lines appear.

Exit button Turns radio off
Information Displays radio signal strength, current channel and band
Expand/minimize overlay Controls display of channel selection controls

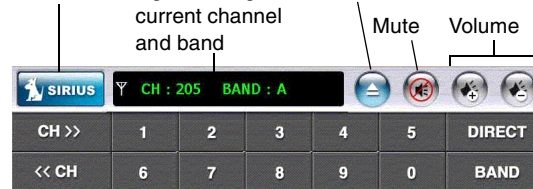

Maximized SIRIUS radio controls

- To move forward and backward through the channels, press the channel buttons.
- To switch among channel, artist and song title, touch the information window.

- To directly select a channel, press the DIRECT button followed by the channel button.
- To select a preset channel, press BAND to alternate among the three bands, then press the band number.

Note

Voice guidance takes priority over the radio.

Playing music while navigating

To listen to stored music while you navigate, press the MUSIC button below the LCD.

The MUSIC controls overlay the top of the navigation screen.



Expanded music controls overlay the navigation screen

When minimized, only the top line appears.

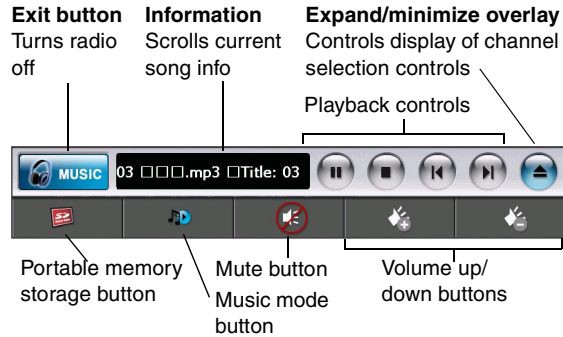

MUSIC radio controls

Note

Voice guidance takes priority over music.

For more information about playing music, see “Playing music” on page 95.

Traveling with N.I.C.E.

To remove the unit from your vehicle, lift up the latch that holds the suction cup to the windshield.

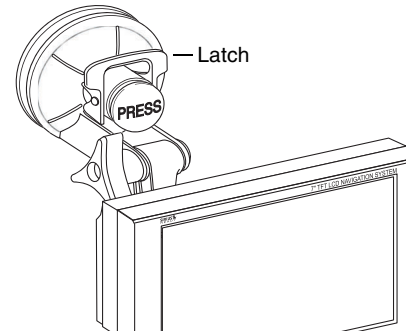

Locating the latch

You can use the unit at home. To carry it with you when you travel, put it in the carrying case.

4. Customizing

This chapter explains how to customize the N.I.C.E. unit and features to suit your preferences.

Changing screen brightness

1. Press the onscreen mode button followed by Setup on the menu grid.



N.I.C.E. SETUP button

Menu grid

1. The unit displays the SETUP menu.



Setup menu

2. Press the LCD button.

1. The unit displays the brightness bar.

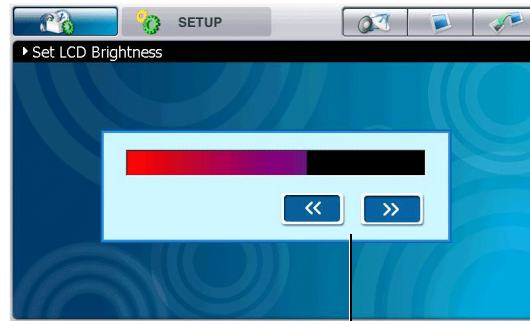

Brightness arrows

Brightness bar

2. Press the left and right arrows to adjust the brightness of the screen.
The new setting takes effect immediately.
3. Press the LCD button again to accept the new setting.

Setting the speaker volume

You control the volume through a setup option or by using the volume up/down buttons on the radio and music default screens, and on the remote control. Each method adjusts the same volume setting.

This procedure explains how to set volume using navigation setup.

1. If you're not in navigation mode, press NAVI.
2. Press the navigation button (F3) followed by Setup.
3. On the Setup menu, press Set Volume level.

The volume level displays on the status bar.

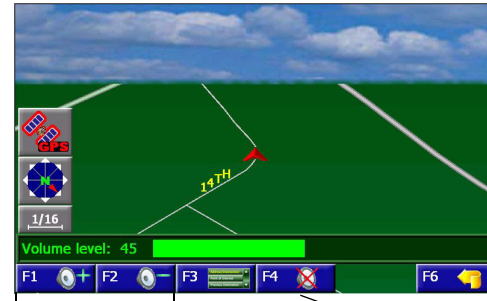

Volume up (F1) and down (F2) buttons Mute (F4)

Volume level bar

4. Press and hold the Volume Up (F1) or Volume Down (F2) buttons to adjust the volume between 0 and 100 percent.
5. Press the mute button (F4) to mute all sound.
6. Press the navigation button (F3) to return to the main navigation screen, or simply wait a few seconds and the main navigation screen appears automatically.

Note

The volume buttons on the radio and music screens change the same volume setting as the SETUP option.

To mute only the guidance voice, see "Turning voice guidance on and off" on page 73.

Customizing navigation

Accessing preferences

These general instructions work for all options.

1. If you're not already on the main navigation screen, press the navigation button (F3).

The navigation menu appears.

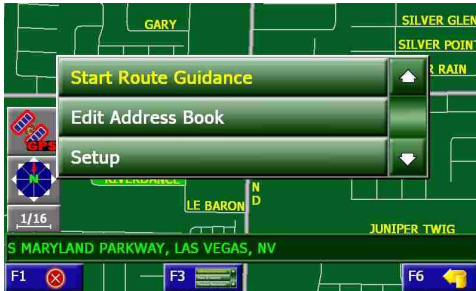

Navigation button (F3)

Navigation menu

2. Press Setup.

The Setup menu appears.



Multi-item scroll buttons (F2 & F4) Back button (F6)

Setup menu

3. Press an option button.

Use the multi-item scroll buttons to view additional options.

4. Press the button to turn the feature on/off.
5. Scroll down to display additional options.
6. Press the back button (F6) to return to the Setup menu.
7. When you're finished, press the exit button (F1).

Maximizing space for the map

To see more of the map, turn off all the indicators, icons and status bars that provide additional information.

1. To access these options, press Display Options on the Setup menu.

The options menu or settings appear.

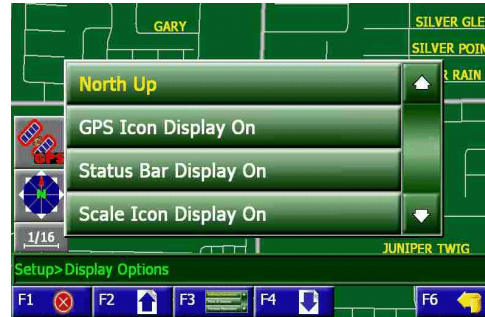

Display Options menu

Consider turning off:

- GPS Icon
- Status Bar (this is the bar located at the bottom of the screen, just above the buttons)
- Scale Icon

- Compass Icon
 - Next maneuver Icon
 - Enlarged Intersection icon
2. Press the option to change it.
 3. When you're finished, press the exit button (F1).

Shortest time or shortest distance

You can configure the unit to calculate the shortest distance or the shortest time.

1. Press the navigation button (F3).
2. Press Setup.
3. Press Navigation Preferences
4. Press the Shortest Distance/Shortest Time button.

When set to Shortest Distance, the unit calculates the route based on the shortest distance, as the crow flies.

When set to Shortest Time, the unit calculates the route based on the shortest estimated travel time. This time is based on road type (for example, interstates are assumed to be faster).

5. When you're finished, press the exit button (F1).

Avoiding interstates and toll roads

If you don't like to drive on freeways or wish to avoid toll roads, the unit will calculate a route that avoids these roads.

1. Press the navigation button (F3).
2. Press Setup.

Press Navigation Preferences and scroll to view the following options.



Navigation preferences

- Press the Avoid Freeway Yes/No button to display the desired setting.
 - Press the Toll Yes/No button to display the desired setting.
3. When you're finished, press the exit button (F1).

Changing the language

1. Press the navigation button (F3).
2. Press Setup.
3. Press Set Language.

The Languages menu appears.



Languages menu

4. Press the desired language.

N.I.C.E. supports English, Spanish and French.

The caution screen appears in the selected language.

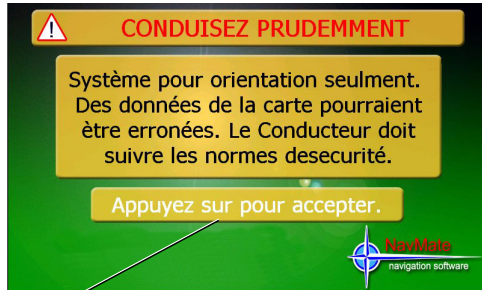

Accept button

Caution screen in French

5. Press the accept button.

The map database and verbal guidance are now set for the selected language

All menu items remain in English.

6. When you're finished, press the exit button (F1).

Changing distance units

The distance to the next maneuver appears in the upper right of the screen. The unit can report distances in miles, kilometers and meters, or miles and yards.

1. Press the navigation button (F3).
2. Press Setup.
3. Scroll down and press Set Distance Units.

The unit displays.



Units menu

4. Press the desired distance unit. The main navigation screen appears.

The new units setting appears next time you navigate.

5. When you're finished, press the exit button (F1).

Defining position using lists

If your starting point is in a high-rise complex or large manufacturing plant where the N.I.C.E. mounted in your vehicle does not have direct access to the satellite signal, follow this or the procedure in the next topic to establish your point of origin (HOME).

1. Press the navigation button (F3),
2. Press Setup.
3. Scroll down and press Set Vehicle Position.
4. Use the menus to define the point of origin in the same way you defined a destination. See "Define your destination" on page 35.

Defining position by pointing

Rather than use the lists as in the previous topic to define your origin, you can use the map itself.

1. Touch the address on the map,

If the address is not on the map, touch the map in the direction of the address as if your finger was doing the traveling.

Continue touching the map until you find the location.

2. Press the push pin button (F5).

The unit displays the selected location as a list item.

3. Press the name to confirm the location.
4. Press Save as HOME.

The unit displays, "Home Location Saved," and returns to the use options list.

Turning voice guidance on and off

When voice guidance is on (the default setting), N.I.C.E. provides verbal, step-by-step directions as you travel the selected route.

1. Press the navigation button (F3).
2. Press Setup.
3. Press Navigation Preferences.
4. Scroll down and press Voice Guidance On/Off.

To hear the voice, the internal speaker must be on (see "Setup reference" on page 129) or the FM Transmitter feature, which sends audio output to your car's stereo speakers, must be selected and configured. See "Audio through your car stereo" on page 30.

5. When you're finished, press the exit button (F1).

5. SIRIUS Satellite Radio

SIRIUS satellite radio makes available over 120 channels of commercial-free entertainment for your car, home or office. Of those 120 channels, 65 provide original content.



Music channels include today's hits, R&B oldies, classical music, country, bluegrass, jazz, latin, reggae, rock and more.

In season you can listen to 16 NFL games a week, up to 40 NBA games a week, and up to 40 NHL games a week. Coupled with great sports news from ESPN, SIRIUS offers unrivaled sports coverage.

News and entertainment offerings include NPR, CNBC, Fox News, Radio Disney and E! Entertainment Radio.

How satellite radio works

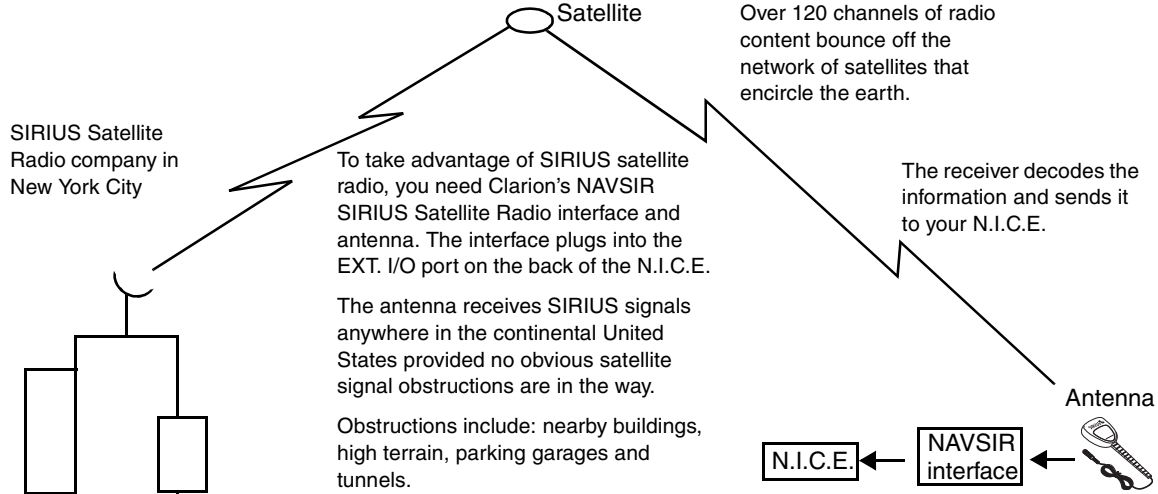

Getting started

To listen to SIRIUS satellite radio you need two things in addition to your N.I.C.E.:

- Optional NAVSIR interface installed in your vehicle.
This unit receives the satellite signal. For installation instructions, see the user's guide that comes with the NAVSIR.
- A subscription to SIRIUS satellite radio.

Note your ID number

1. Press the SIRIUS button at the bottom of the screen or press the mode button (toolbox), then press SIRIUS.

2. If you are in navigation mode, press SIRIUS again to open the full SIRIUS display.



SIRIUS main screen

3. Press the onscreen MENU button.

- 4. The unit displays the Menu Options page with the SIRIUS ID option highlighted.



Options menu

- 5. Press the SIRIUS ID menu item.

- 6. The 12-digit SIRIUS ID number appears.



Options menu

- 7. Write this number here.

--	--	--	--	--	--	--	--	--	--	--	--

Activate the radio service

- Visit Sirius.com and click JOIN, then follow the onscreen instructions.

OR

- Call SIRIUS at 1-888-539-SIRIUS (7474).

A Customer Care representative will activate your service. A subscription fee is involved.

Note

Make sure to have your identification number accessible when calling Sirius.

Antenna Aiming

To receive a good signal requires a direct line of sight between you and the satellite. If your reception is poor, moving the antenna may help. This option

confirms that the antenna is in the best position to receive the satellite signal.

1. Press MENU.
2. The options menu appears.



Options menu

3. Press the ANTENNA AIMING menu option.

The unit displays two 10-segment horizontal bar graphs with a minus (-) to the left and a plus (+) to the right.



Antenna aiming graphs

The satellite (SAT) graph displays the satellite signal strength. The terrestrial (TER) graph shows the terrestrial signal strength.

Note

In urban areas where structures may affect the line of sight satellite signal, terrestrial repeaters (TER) strengthen the signal. They may not be available in your geographical location.

Basic Operations

1. After activating your SIRIUS subscription, press the SIRIUS button at the bottom of the screen
2. If the unit is in navigation mode, press the SIRIUS button again.

The SIRIUS logo appears for three seconds followed by the SIRIUS default display.



SIRIUS default display

For a complete identification of each item on this display, see “Sirius Satellite Radio controls” on page 17.

If you’re playing the radio for the first time, the unit displays “Updating Channels.”

3. Press the onscreen channel previous and next buttons to move to the next channel. The channel starts playing.

Definition

A channel is a source of satellite radio content.

Direct tuning by channel

If you know the three-digit channel number:

1. Touch the middle of the screen.
2. Enter the channel number using the row of numbered buttons along the bottom of the screen.

The unit changes immediately to the channel.

If you enter only one or two digits, the unit waits for three seconds before changing the channel.

Tuning by category

Category groups channels by music genre or other content. For example, your favorite rock channels are in the category "ROCK."

1. Press the onscreen previous and next category buttons to select a category.
2. Press the displayed channel option to select the channel within the category.

The channel begins playing and the LCD returns to the default display.

Tuning by previewing

There are two ways to preview what's playing before selecting a channel.

Previewing by category

This procedure lets you view by category what's currently playing on other channels without changing the current channel.

1. Press the onscreen previous and next category buttons to select a category.

The unit displays a list of categories.

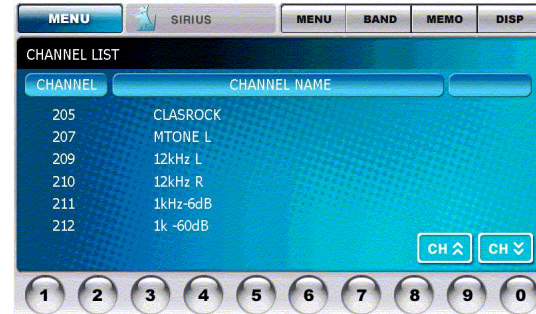

Channel list

2. Press DISP (display).

Touching DISP again and again alternates the list among channel, artist name and song title

3. Press the channel name on the touch-sensitive screen to select it.

The channel begins playing and the LCD returns to the default display.

Previewing all channels

This procedure lets you view regardless of category what's currently playing on other channels without changing the current channel.

1. Press DISP (display).

The unit displays a list of all channels regardless of category.

2. Press DISP again and again to alternate the list among channel, artist name and song title.

3. Press the channel name on the touch-sensitive screen to select it.

The channel begins playing and the LCD returns to the default display.

Use channel up and down to scroll among channels.

Tuning by favorites

The receiver can locate up to 30 favorite channels—10 per band. This feature saves time by presetting only the channels you like.

Storing favorites

1. Press BAND briefly to select A, B, or C.

The Band indicator changes to the corresponding preset band. Each band locates 10 presets.

2. Locate the channel you want to assign to a preset by direct tuning. See "Direct tuning by channel" on page 80.

3. With the channel playing, press and hold any of the numbered keypad buttons (0-9) for one second.

The channel number flashes and remains lit to indicate that the unit stored the channel number. The current channel number replaces any previously stored channel associated with that number.

Direct tuning by band and preset

1. Press BAND briefly and again briefly to switch among the three bands: A, B, and C.

The Band indicator changes to the corresponding preset band.

2. Press one of the 0 - 9 keys.

The associated preset channel begins playing and the LCD returns to the default display.

Tuning by preset number

1. Press and hold BAND to enter Preset Tune Mode.

The Band indicator changes to show the current preset number.

2. Press the previous and next channel buttons to move backward and forward through all presets.

The associated preset channel begins playing and the LCD returns to the default display.

This procedure displays only stored presets in band and preset number order (A-1, A-2... B-1, B-2... C-1, C-2...).

To return to Channel Tune Mode without selecting a preset, press and hold BAND.

Tuning by preset list

1. Press and hold BAND.
2. Press DISP.
The unit displays up to five preset channels.
3. Press DISP again and again to alternate among channel name, artist name and song title.
4. Press the onscreen previous and next channel buttons to scroll through the preset list.
5. Press the channel on the touch-sensitive screen to select it.

The channel changes and the display indicates that you are in Preset Tune Mode.

Searching for favorites

When you turn N.I.C.E. on, it can automatically search the incoming SIRIUS signal and alert you when a favorite song is playing. Then it's up to you to switch from your current channel to the channel playing your favorite.

Storing favorite information

You may store a list of up to 20 favorite artists and song titles. To store a favorite, it must be currently playing.

When a favorite song is playing, press MEMO (memory).

The unit makes sure you have not already stored this channel as another preset.

Assuming it does not find a duplicate, the unit stores the current program information in its memory and displays a pop-up screen that shows how many of

the 20 memory slots are used and how many are empty.

Finding favorites

If it finds one or more songs playing on channels other than the current channel, the N.I.C.E. beeps and displays “Memory Alert” for two seconds followed by the list of favorites that are currently playing appears.

Press the name of the song on the touch-sensitive screen to select the channel.

The stored channel begins to play and the display reverts to its condition before the alert occurred.

If you make no selection within 10 seconds, the display returns to its previous status.

Viewing stored favorite information

1. Press and hold MEMO for three seconds.

The unit displays the stored information, one item at a time.

2. Press the onscreen previous and next channel buttons to page through all 20 items.

Deleting one stored favorite

1. Press and hold MEMO for three seconds.

The unit displays the stored information, one item at a time.

2. Briefly press the favorite name.
3. Press Yes or No on the touch-sensitive screen.

Deleting all stored favorites

1. Press MENU.

The options menu appears.

2. Press the MEMORY OPTION menu item.

The unit displays two options: Automatic Memory Search and Clear All Memory.



Memory options

To exit without clearing memory, press MENU again.

3. Under Clear All Memory, press Yes.

Parental control features

You may restrict young people from accessing specific channels in two ways:

- Skip specific channels when tuning.
Use this feature to completely omit specific channels, which the SIRIUS receiver does not even download from the satellite. For instructions, continue with the next topic.
- Require the listener to enter a four-digit lock code to play specific channels.

Use this feature to allow only those who know the four-digit activation code to listen to the channel. For instructions, see “Locking out certain channels” on page 89.

Skipping channels

With hundreds of channels available, you may wish to limit the accessible list to only those you like.

1. Press the onscreen MENU button.
2. The options menu appears.



Options menu

3. Press the ADD or SKIP onscreen menu item.
4. Press the onscreen previous and next channel buttons to display the channel selections.
Press DISP again and again to alternate among channel name, name of current artist, and name of current song.
5. Press the channel number on the touch-sensitive screen to skip the channel.

The unit displays “Skip” next to the channel number and will not download this channel during regular tuning.



Channel list with one channel skipped

Pressing the channel number again includes the channel in the download and removes the “Skip” setting.

To return to the menu exit without setting this option, press MENU again.

Accessing skipped channels

There are only two ways to access skipped channels:

- Enter the channel number directly. See “Direct tuning by channel” on page 80.
- Use the Add option to restore the channel.

Restoring a skipped channel

1. Press the onscreen MENU button.
2. Press the ADD and SKIP onscreen menu item.
3. Press the previous and next channel buttons to highlight the skipped channel.
4. Press the channel number on the touch-sensitive screen.

“SKIP” disappears next to the channel number.

Locking out certain channels

Locking a channel requires the entry of the four-digit lock code to play the channel. You can use this feature to prevent unauthorized people, such as children, from accessing specific channels.

Locking a channel

When you select this option, the unit prompts you to define a four-digit lock code.

1. Press the onscreen MENU button.

The options menu appears



Options menu

2. Press the LOCK or UNLOCK menu item.
The unit displays the lock code entry box.

- If this is the first time you've used this feature, enter the default code "0000."

If you've used this feature before, enter your unique four-digit code. To change this code, see "Changing the lock code" on page 92.

The unit displays a channel list with the current channel highlighted.

- Press the onscreen previous and next buttons to highlight the channel to lock.

- Press the channel number on the touch-sensitive screen to lock the channel.



Channel list with one channel locked

The unit displays "LOCK" next to the channel number. Although the unit will download this channel, it will not allow access during regular tuning without entering the lock code.

To exit without setting this option, press Enter or MENU again.

Accessing locked channels

To access a locked channel:

1. Enter the direct channel number.
2. Enter the four-digit lock code.

The channel begins to play.

Note

The channel returns to the locked status if you change channels or turn the unit off (for example, turn the vehicle off).

Restoring a locked channel

When you select this option:

1. Press the onscreen MEMO button.
2. Press Lock Options on the touch-sensitive screen.

The unit displays the lock code entry box.

3. Enter the four-digit code.

The unit displays a channel list with the current channel highlighted.

4. Press the onscreen previous and next channel buttons to highlight the locked channel.
5. Press the channel number on the touch-sensitive screen to unlock it.

“LOCK” disappears next to the channel number.

Changing the lock code

1. Press the onscreen MENU button.

The options menu appears.



Options menu

2. Press the EDIT CODE menu item.

The unit displays the lock code entry box.



Edit code entry box

3. Enter the four-digit code or "0000" if this is the first time you're setting the code.

The New Code prompt appears.

4. Enter the new four-digit code using the keypad buttons.

The unit prompts you to confirm the code.

5. Enter the new four-digit code again.

You have changed the lock code.

To exit without setting this option, press Enter or MENU again.

Resetting factory defaults

To return the unit to the configuration it had when you purchased it:

1. Press MENU.

The options menu appears.



Options menu

2. Press the FACTORY DEFAULT menu item.

The unit displays:

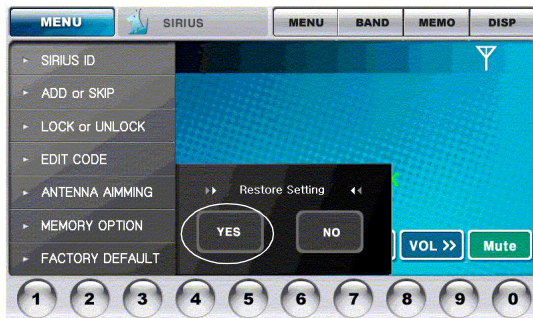

Restore setting options

3. Press YES.

All SIRIUS option settings return to their factory defaults.

6. Music modes

This chapter provides guidelines for using the N.I.C.E. in video and music mode.

Playing music

You can play music stored on the unit's hard disk or on a portable memory storage device connected to the USB 1.1 port.

For information about how to download music (and photos) from your PC to the N.I.C.E., see "Copying files" on page 103.

Supported formats

- MP3
- WMA
- WAVE

Portable music storage

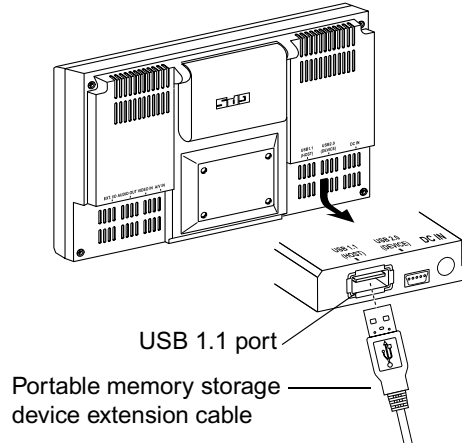

Portable memory storage device connection

1. If the music is stored on a memory stick insert the stick directly into the USB 1.1 port on the back of the unit.

If the portable memory storage device has an extension cable, connect the cable.

Power to the N.I.C.E. may be on or off when you connect the device.

2. If the power to the unit is off, turn it on.

Configuring music playback

To listen while you navigate, choose music and configure how you want your files to play (random, etc.) before you start navigating.

1. Press the MUSIC button below the LCD.

The music banner appears across the top of the screen.

2. Press the MUSIC button again.

The music default screen appears and the last song you were listening to begins to play.



Default music screen

3. To change the song, press the title of a different song in the right pane.

OR

To play a song in a different folder, press the folder button.

OR

To play a song stored on an portable memory storage device, press the portable memory storage button.

Note

Only MP3 files can be played while navigating.

4. Press the song title on the touchscreen.

The song begins to play. When it's finished, the unit plays the next song based on the music mode.

5. Press the music mode to alternate among these options:



Music mode button



Repeat all songs in one folder.

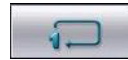

Repeat current song.



Play all songs in system at random.

7. Video mode

This chapter provides guidelines for using the N.I.C.E. in video and photo modes.

Video options

N.I.C.E. includes several video options:

- Backup view
If your vehicle is equipped with a rearview camera, output from the camera displays in the N.I.C.E. video window. For more information, see “Backing up safely” on page 54.
- Viewing a DVD movie
- Playing video games
- Viewing digital photos stored in your camera, on a memory stick or on the N.I.C.E. hard disk.

Supported format

The unit supports the JPEG format for photos 1MB or smaller in size.

Playing a movie or game

Note

It is illegal to drive and watch a video at the same time. When the GPS detects motion, it disables video viewing.

Connect to the player

Plug the DVD player or video game system cable into the A/V IN port on the back of the unit.

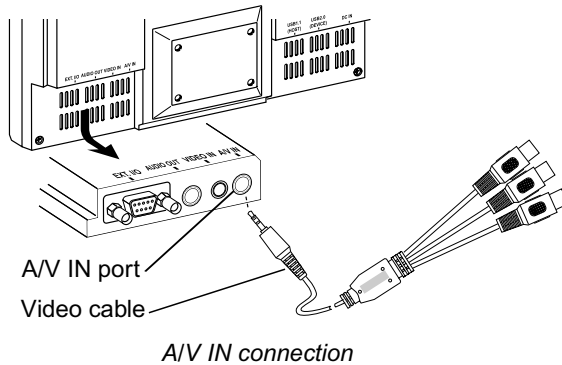

Viewing a movie or playing a game

1. Press VIDEO at the bottom of the screen.
OR

Press the onscreen mode button and then press VIDEO.

The unit displays the video window.

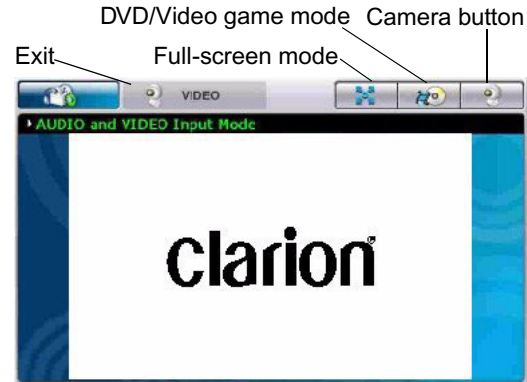

2. Load your DVD player or video game and press play.

The image displays on the screen.

3. Press the full-screen mode button to stretch the video input to fill the screen.

Backing up with the camera

1. Press the VIDEO button below the LCD.

OR

Press the onscreen mode button and press VIDEO.

2. Press the camera button.

The image appears in the video window.

3. Press the full-screen button to stretch the rearview camera image to fill the screen.

Viewing a slide show

In photo mode, the N.I.C.E. lets you page through digital photos stored on the unit's hard disk or on a portable memory storage device connected to the USB 1.1 port.

Photo storage

Power to the N.I.C.E. may be on or off when you connect a portable memory storage device.

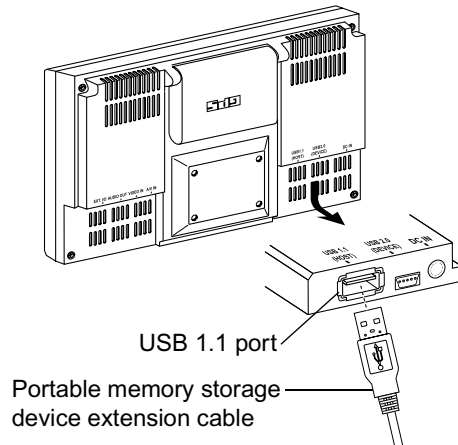

Portable memory storage device connection

1. If the photos are stored on a memory stick insert the stick directly into the USB 1.1 port on the back of the unit.

If the portable memory storage device has an extension cable, connect the cable.

If the photos are on your computer, see “Copying files” on page 103 for how to copy them from the PC to the N.I.C.E.

2. If the power to the unit is off, turn it on.

Showing slides

1. Press the mode button (F6 on the navigation screen) and press PHOTO.

The unit displays the photo default screen.

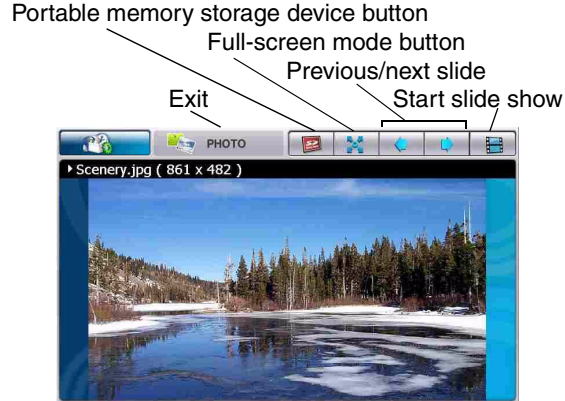

Photo viewer screen

2. To select digital images on a portable memory storage device, press the portable memory storage device button.
3. To expand the image to fill the screen, press the full-screen mode button.
4. Press the Start-slide-show button to start the show.
5. Press the previous and next buttons to view the images.

8. Care and updating

This chapter covers cleaning the unit, updating the map database, uploading music and photos from a PC to the N.I.C.E., updating the unit's firmware, and troubleshooting.

Cleaning the unit

To remove dust, gently wipe the unit with a damp, soft, clean cloth.

Do not spray any cleaning agent directly on the LCD.

If you accidentally drop the unit in water, do not turn the power on until it has fully dried out.

Updating the map database

Clarion continuously publishes new map databases on DVD. You can purchase the latest map DVD from the Clarion Website:

www.clarion.com

Once you have the DVD, follow the steps in the next topic to update the N.I.C.E. map database.

Copying files

N.I.C.E. can store up to 10 GB of music and photo files, making it easy to listen to your favorite music or view your favorite photos while on the road.

Music must be in MP3, WMA, or WAVE format; photos must be in JPEG format.

You copy files from the PC to the N.I.C.E. or from the N.I.C.E. to the PC using standard Windows® procedures.

Removing the unit

If you have a laptop computer you may be able to transfer files without removing the N.I.C.E. from your vehicle.

1. Otherwise, lift the latch that holds the suction cup to the windshield to remove the N.I.C.E. from your vehicle.

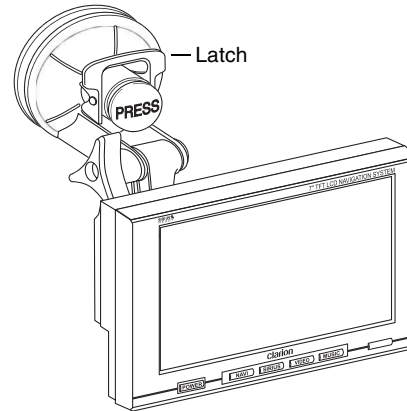

Locating the latch

2. Carry the N.I.C.E. to the PC.

Connecting to your PC

You connect your N.I.C.E. to a PC using a standard USB 2.0 cable. Most computers come with this cable or you can purchase one at your computer store.

1. Make sure power to both the PC and the N.I.C.E. is turned off.

2. Connect one end of a standard USB cable to the USB 2.0 port on the N.I.C.E.

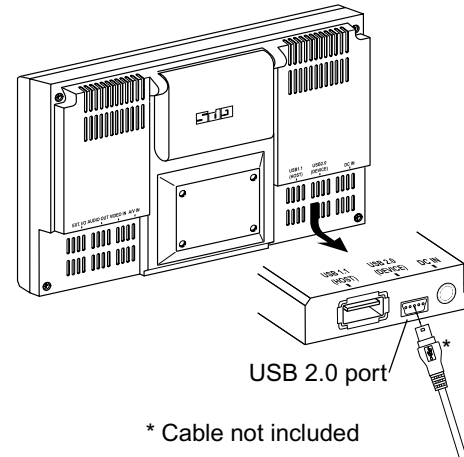

* Cable not included

USB 2.0 connection

3. Connect the other end of the USB cable to the PC's USB 2.0 port.

4. Turn on power to both the PC and the N.I.C.E.

Copying files

1. If you're updating the map database, insert the DVD with the new database in the DVD drive on the PC.
2. On the PC, open My Computer or Windows Explorer.

Consult your Windows manual if you need help.

Windows opens a screen showing all the drives on your computer. Windows assigns a drive letter to the N.I.C.E. based on the other drives in your system.

Therefore, the drive letter you see may be different from the one in the following example.

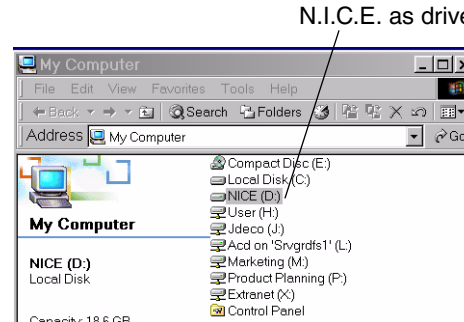

Sample My Computer window

3. Double-click the N.I.C.E. drive icon.

The N.I.C.E. folder opens, displaying the default Map, Music and Photo folders.

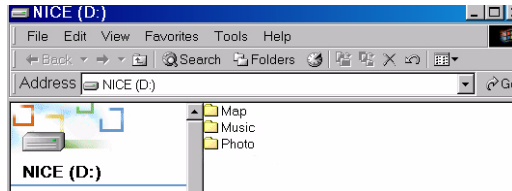

N.I.C.E. drive window

Note

If you delete the default Music or Photo folders, make new ones using Windows Explorer. (Consult your Windows manual for instructions.)

The folders must be named Music and Photo, otherwise you will be unable to view the photos on the N.I.C.E.

4. Double-click one of the folders, Map, Music or Photos in the N.I.C.E. window to open it.

If you're copying from the PC to the N.I.C.E., this is the destination folder. If you're copying from the N.I.C.E. to the PC, this is the source folder.

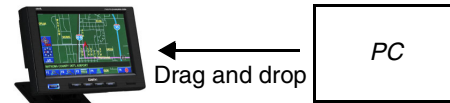

Destination folder

Source folder

Copy direction when updating the N.I.C.E.

5. Open another My Computer window.
6. If you're copying music or photos, navigate to the PC music or photos folder.

OR

If you're updating the map database, open the DVD.

If you're copying from the PC to the N.I.C.E., this is the source folder. If you're copying from the N.I.C.E. to the PC, this is the destination folder.

7. Arrange the two windows on the PC desktop so that you can see the contents of both the source and destination folders.
8. In the source folder, select the files to copy.

Hold CTRL and click individual file names to select them.

OR

Click the file at the top of the list, hold SHIFT and click the last file in the list.

OR

Hold CTRL and press A to select all files in the list.

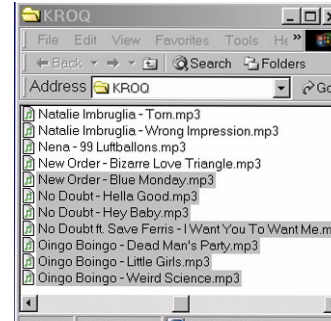

Sample selection of source music files

9. Click and drag the selected files to the selected destination Music or Photo folder.

A Copying message may appear, depending on the PC's operating system and processor speed.

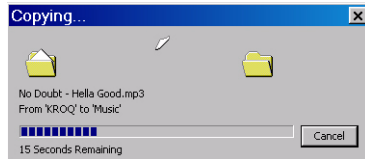

Sample Copying message

When the copy is finished, the files appear in the selected Music or Photo folder on the N.I.C.E.

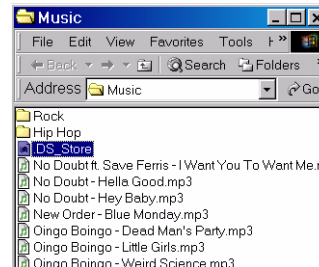

Sample Music folder after copying files

Disconnecting from the PC

1. Turn off power to the N.I.C.E. and shut down the PC.
2. Unplug the USB cable from both the N.I.C.E. and the PC.

Deleting photo and music files

1. Follow the steps in “Connecting to your PC” on page 105.
2. On the PC, open My Computer or Windows Explorer.

Consult your Windows manual if you need help.

Windows opens a window showing all the drives on your computer. Windows assigns a drive letter to the N.I.C.E. based on the other drives in your system,

3. Double-click on the drive icon to open the N.I.C.E. folder.

Windows opens the folder that contains the default Map, Music and Photo folders.

4. Double-click the folder on the N.I.C.E. that contains the file(s) to delete.

Caution

Do not delete the Map folder, as it contains all of the maps used for navigation.

5. Select the files to delete.

Hold CTRL and click individual file names to select them.

OR

Click the file at the top of the list, hold SHIFT and click the last file in the list.

OR

Hold CTRL and press A to select all files in the list.

6. Press the Delete key on your PC keyboard.

A confirmation dialog appears.

7. Click Yes to delete the files, or No if you're not sure.

After pressing Yes, the files are deleted from the N.I.C.E.

Note

The N.I.C.E. does not maintain a Recycle bin from which you can retrieve files you may have deleted by mistake. Once you delete files, they are gone.

Updating the firmware

From time to time Clarion upgrades the N.I.C.E. firmware.

Definition

Firmware is the operating system (OS) or software stored in the N.I.C.E. that controls system features and displays screens and messages.

1. Using a PC, copy the upgraded software from the Clarion website onto portable memory storage.
2. Insert the portable memory storage into the USB 1.1 (Host) port on the N.I.C.E.
3. Press the onscreen mode button followed by Setup on the menu grid.

The unit displays the SETUP menu.

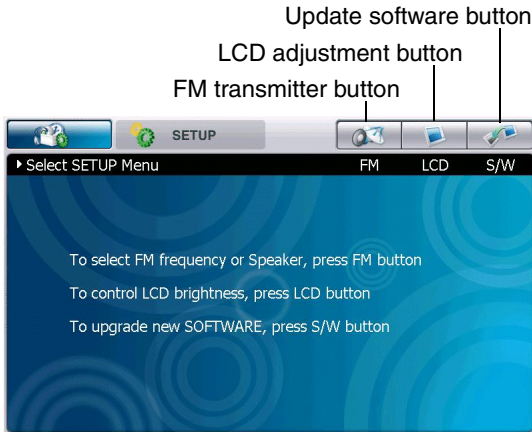

Setup menu

4. Press the update software button.

The unit displays the current Operating System (OS) version and searches for any upgrades.

5. Follow the instructions on the screen.

Troubleshooting

Description	Probable Cause	Remedy
N.I.C.E. does not turn on.	The power cable may not be properly connected. The fuse may be blown.	Check power cable and fuse.
GPS signal strength is weak	In some applications/installations, GPS signal may be difficult to receive.	Position the built-in GPS antenna to a better angle for signal reception. To locate the antenna, see "Back view" on page 11. If the signal is still weak, consider purchasing the NAVGPS, an externally mounted GPS antenna. Consult your dealer for further assistance.

Description	Probable Cause	Remedy
The GPS signal was lost while en route.	The unit's line of sight to the GPS satellite has been obstructed, such as by entering a tunnel or parking garage.	Check the signal strength meter. If the signal does not return, you can manually set the vehicle position. For more information, see "Defining position using lists" on page 72
The LCD displays, "Check antenna".	The SIRIUS satellite radio antenna is not connected.	Check the antenna connection to the Satellite radio receiver.
	The antenna or its cable is faulty.	Contact the system installer or vendor.
Reception is marred by audio static or loss of clarity.	The FM frequency contains static.	Switch to another FM frequency.
	The vehicle's antenna is not connected to the radio.	Check the vehicle antenna cable.
GPS satellite indicator is gray indicating it cannot connect to a satellite.	Check for obstacles over or around the antenna.	Extend the GPS antenna or change your location to eliminate nearby obstacles, such as bridges and tall buildings.

Description	Probable Cause	Remedy
You hear no sound from the unit's internal speaker.	The speaker may be turned off or redirected to the stereo speakers in your car or home.	<ol style="list-style-type: none"> 1. Press the NAVI button; press Setup, Navigation Preferences. 2. Scroll to Voice Guidance and press the button to change the setting from Off to On. 3. Press the back button (F6) to go back to navigation preferences or the exit button (F1) to return to the main navigation screen.
You hear no sound from your car stereo speakers	You've selected an unavailable FM frequency.	Tune to the correct FM frequency.
N.I.C.E. displays an "abort" message		Turn the power off and back on again, and start over.

Description	Probable Cause	Remedy
When trying to update firmware, the unit displays, "OS Update File can't be found"	To update, you need the update software on portable memory storage in the USB 1.1 (Host) port. See "Updating the firmware" on page 111.	Double-check all connections.

9. Reference

Modes

You select operational modes by pressing either physical or onscreen buttons.

Mode buttons

These buttons appear below the LCD.



Selects navigation mode.



Selects SIRIUS Satellite radio mode.



Selects video mode, used to view input from the rearview camera, videos, and play video games.



Selects music mode, used to play MP3, WMA and WAVE files.

Mode grid

This button appears onscreen in all modes.



Pressing it displays a grid of menu options.



Enters navigation mode; used for navigation. For navigation options, see "Setup reference" on page 129.



Enters SIRIUS satellite radio mode; used to play SIRIUS satellite radio. For radio options, see "SIRIUS satellite radio reference" on page 126.

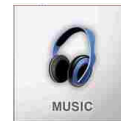

Enters music playback mode; used to play music, such as MP3 files. For music options, see "Music reference" on page 128.



Enters photo viewing mode; used to view photos stored on the N.I.C.E. For photo options, see “Photo reference” on page 128.



Enters video mode; used to back up vehicles equipped with a rearview camera and to view DVD movies or play video games. For video options, see “Video reference” on page 129.



Enters setup mode; used to select FM transmitter frequency, set LCD brightness, and upgrade software. For setup options, see “Setup reference” on page 129

Navigation reference

Onscreen buttons



Exit button (F1), returns immediately to the navigation map.



Zoom in button (F1), expands the detail of the map.



Volume up button (F1), raises the volume of the route guidance voice.



Scroll up (back) button (F2), displays previous options four at a time.



Zoom out button (F2), shows more of the map at once.



Volume down button (F2), lowers the volume of the route guidance voice.



Navigation button (F3), starts navigation and accesses navigation setup options.



Pointer button (F3) centers the map at the current location.



Scroll down (forward) button (F4), displays next options four at a time.



Mute button (F4), turns all sound off.



Map button (F4), changes map perspective.



Push pin button (F5), selects the point on the map marked by the crosshairs when defining a location with your finger. This location can become your new destination, vehicle position, home or address to include in the address book.



Speaker button (F5), repeats the verbal instruction.



Keyboard button (F5), accesses the onscreen keyboard. Start typing the first one or two letters on the onscreen keyboard, then press the accept button (check mark) to view potential names from the map database.

To avoid typing mistakes, the unit grays out keys you don't need.



Back button (F6), returns to the previous screen.



Accept button, accepts characters typed on the onscreen keyboard and returns to the map or displays a short list of items.

Start Route Guidance

To access these options, press the navigation button (F3).



Defines specific address or intersection to which you're headed (your destination).

State/Province Name: selects the location state or province. Use this option if the destination is in a different state or province than the one in which you are located. Once you select the state or province, you choose a location by postal code, city name or street name.

Postal Code: displays the onscreen keyboard so you can enter the desired location by postal code. Once you enter the Postal Code, the system displays a street list

automatically. You don't need to go back to the City Name and Street Name options.

City Name: displays a list of all cities in the currently-selected state or province. You may scroll through the list or press the keyboard button to use the onscreen keyboard.

When you select the city, the system automatically displays a list of streets.

Street Name: displays a list of all streets in the currently-selected state or province.

If more than one street exists with the same name, the system lists all streets followed by a list of cities in which this street exists.

When you select the city, the unit gives you the option of setting a specific address or an intersection for your destination.

If you choose Address, the unit displays the onscreen keyboard so you can enter the address. The top of the screen displays the address range.

Point of Interest

Defines a public location, such as a bank or hospital, as your location.

State/Province Name: selects the state or province in which the point of interest is located. Use this option if the point of interest is in a different state or province than the one in which you are located. Once you select the state or province, you choose a point of interest by category, postal code, phone number, or first few letters of the name.

By Category: displays all points of interest in your chosen state or province in logical groups

(categories) that make the address easy to find.

By Postal Code: displays all points of interest in the specified postal code.

By Phone: selects the point of interest by phone number.

By First Few Letters: selects a point of interest by entering the first few letters of its name.

Address Book

Defines a location based on address you previously stored. The unit displays all the locations stored in the address book. Scroll through them to find the one you're looking for.

A green rectangular button with a gradient and a slight shadow, containing the text "Previous Destination" in white.

Selects a location based on the last 15 destinations.

A green rectangular button with a gradient and a slight shadow, containing the text "Map" in white.

Selects a destination by pinpointing it on the touchscreen. When using this feature F3 becomes the pointer button and F5 the push pin button.

Edit Address Book

Adds and deletes entries from the address book and allows you to edit a name associated with the address, such as "Mom's house."

A green rectangular button with a gradient and a slight shadow, containing the text "Add Previous Destination" in yellow.

Adds your most recent destination to the address book.

A green rectangular button with a gradient and a slight shadow, containing the text "Add Current Location" in white.

Adds your current destination to the address book.

A green rectangular button with a gradient and a slight shadow, containing the text "Edit" in white.

Displays the location names stored in the address book for editing. You cannot edit any other components of the address.

A green rectangular button with a gradient and a slight shadow, containing the text "Delete" in white.

Removes the selected location from the address book.

Navigation Setup

To access these options, press the navigation button (F3), then press Setup.

Navigation Preferences

Simulation

On: used to preview and demonstrate how route guidance works.

Off: default setting.

Shortest

Time: calculates route based on road type. Interstates are assumed to offer the quickest route.

Distance: calculates route based on shortest distance as the crow flies.

Avoid Freeway

Yes: calculates route without taking you on a freeway or interstate.

No: calculates route based on Shortest setting.

Toll
Yes: includes toll roads in the calculation.
No: excludes toll roads from the calculation.

Auto Recalc

On: calculates a new route when you turn off your current route.

Off: disables recalculation.

Voice Guidance

On: turns speaker on so you can hear voice guidance and play music.

Off: turns speaker off.

Display Options

Heading Up: sets the top of the map display to the direction in which you are traveling.

North Up: sets the top of the map display to north.

GPS Icon Display

On: turns display of the GPS indicator on.

Off: turns display of the GPS indicator off.

See “Monitoring signal strength” on page 51 for examples of the three versions that indicate strong, weak and no satellite signal.

Status Bar Display, Scale Icon Display, Compass Icon Display, Next Maneuver, Enlarged Intersection

On: turns display of indicator on.

Off: turns display of indicator off.

Set Volume Level

Displays graphical representation of current volume setting in the status bar, changes button F1 to increase volume and button F2 to decrease volume, and changes button F4 to mute.

Press and hold buttons F1 or F2 to change the volume setting. Press button F4 to mute the sound. After a few seconds the volume setting returns to the default screen.

Set Language

This option allows you to choose the language (English, Spanish or French) to use for explanatory text and driving directions.

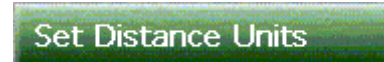

Miles: displays distances in miles.

Kilometers / meters: displays distances in metric kilometers and meters.

Miles / yards: displays distances in miles and yards.

Set Vehicle Position

Address/Intersection: moves the red pointer to a specific location defined by the address that follows.

As you enter the address, N.I.C.E. prompts with possibilities to speed entry. For an explanation of these options, see “Address/Intersection” on page 120.

Point of Interest: moves the red pointer to a special public place, such as an airport, grocery store, hospital, etc.

For an explanation of the Point of Interest settings, see “Point of Interest” on page 121.

Address Book: moves the red pointer to a location you previously stored.

Previous Destination: moves the red pointer to one of 15 last places you set as a destination.

Map: sets point of origin at the place you touch on the map.

System Diagnostics

You'll need to access this option only if instructed to do so by a customer service representative.

GPS Diagnostics: tests the satellite connection and displays satellite information.

System Information: displays the current software version.

SIRIUS satellite radio reference

1. To access the satellite radio options, press the onscreen MENU button.

The Menu options list appears on the left side of the screen.

2. Press the option name in the menu.

The option settings appear to the right of the menu.

3. Press the setting button.

If, while on the Menu Options, you don't actually set any option for 10 seconds, the menu closes.

To exit Menu options without changing anything, press the onscreen MENU button again.



▶ SIRIUS ID

Displays your unique 12-digit SIRIUS ID number. You can't change this number, for example: ESN 000492229812.

See "Getting started" on page 76 for more information.



▶ ADD or SKIP

This option selects channel(s) to skip. See "Skipping channels" on page 87 for steps.



▶ LOCK or UNLOCK

This option controls access to specific channels. See "Locking out certain channels" on page 89 for more information.

▶ EDIT CODE

This option associates a four-digit code with a specific channel requiring you to enter that code to hear the channel. See “Changing the lock code” on page 92 for more information.

▶ ANTENNA AIMING

This option adjusts SIRIUS satellite signal strength reaching the N.I.C.E. when you’re using the unit in your home.

SAT: displays the strength of the SIRIUS signal from the satellite.

TER: displays the strength of the signal coming from terrestrial repeaters.

See “Antenna Aiming” on page 78 for more information.

▶ MEMORY OPTION

This option lets you control the automatic memory search function and clear all memory slots.

Clear all Memory: clears all favorite artist and song title combinations you previously stored.

For more information about storing favorites in memory, see “Skipping channels” on page 87.

▶ FACTORY DEFAULT

This option restores the factory default settings for all options. Settings are Yes and No.

Music reference



Portable memory storage device button, displays folders on the device connected to the USB 1.1 port.



Folder button, displays folders on the N.I.C.E.



Music mode button, alternates among repeat, play folder in order, and random among all songs.



Repeat all songs in one folder.



Repeats current song.



Play all songs in system in random order.

Photo reference



Portable memory storage device button, displays folders on the device connected to the USB 1.1 port.



Enlarges image to fit screen.



Displays previous slide.



Displays next slide.



Starts slide show.

Video reference



Enlarges image to fit screen.



Displays image from DVD or video game.



Displays input from rearview camera.

Setup reference

To access these options, press the mode button (F3), then press the SETUP cube on the menu grid.



FM Transmitter button, redirects audio output from the speakers in the N.I.C.E. to the speakers in your car using a wireless connection.

On: directs audio output to your vehicle's stereo speakers.

Off: directs audio output to the N.I.C.E.'s own internal speakers.



LCD adjustments button sets the brightness of the LCD.



Upgrade software button, displays the current operating system version and update status.

Specifications

Dimensions (W x H x D):	191mm x 128mm x 31mm
Operating system	Windows CE version 4.2
Embedded processor	High Performance Embedded 32-bit RISC (ARM 9 Core)
Memory	64MB SDRAM 32MB Flash Memory 20GB Hard Disk Drive
Power source	12 ~ 24V DC (using cigar jack)
Map database	Nav Tech Map Database
Temperature	-10° ~ +85°C
Liquid crystal display (LCD)	7" Digital TFT Touchscreen LCD 800 horizontal x 480 vertical pixels

Index

A

- A/V IN port 11, 101
- Abort message 115
- Accept button (keyboard) 42
- Add Current Location
 - to address book 55, 122
- ADD or SKIP 87, 126
- Add Previous Destination
 - to address book 55, 122
- Address
 - book, updating 55, 122
 - editing name 57
 - navigating to 37
 - range 44
 - selecting 44
- Address Book 37, 121, 125
- Address/Intersection 37, 120, 125
- Adjustment knobs 26

- Antenna 78
 - GPS 11, 27
 - radio 75, 78
- ANTENNA AIMING 127
- Artist, storing radio favorites 84
- AUDIO OUT port 11
- Audio, output to vehicle stereo 30
- Auto Recalc 123
- Avoid Freeway 123

B

- Back button (F6) 15, 119
- Back view (of N.I.C.E.) 11
- Backing up a vehicle 54
- Backup camera, see rearview camera 20
- Band or preset indicator 17
- BAND, radio button 17, 82
- Brightness, adjusting screen 63
- Buttons
 - accept button (check mark) 42
 - back (F6) 15, 119
 - BAND (radio) 17

- category (radio) 17
- channel (radio) 17
- check mark 119
- compression 26
- DISP (radio) 17
- DVD/video game 129
- exit (F1) 14, 118
- F1-F6 10
- FM transmitter 129
- folder button on music screen 18
- full-screen 19, 20, 99, 128, 129
- keyboard (F5) 15, 119
- keypad on radio screen 17
- LCD adjustments 129
- map view (F4) 16, 119
- MEMO (radio) 17
- MENU (radio) 17
- mode (F6) 16, 117
- mode (toolbox) 12, 17, 18, 19, 20, 34
- MUSIC 96, 117
- music folder 128
- music mode 18, 97, 128
- mute (F4) 119
- NAVI 10, 34, 117
- navigation (F3) 119
- Page up (F2)/page down (F4) 15
- pointer (F3) 119
- portable memory storage 18, 128
- POWER 10
- previous and next (photo viewer) 19
- push pin (F5) 119
- rearview camera 20, 129
- remote control 22
- scroll down (F4) 119
- scroll on navigation screen 41
- scroll up (F2) 118
- SIRIUS 10, 117
- slide show 19
- speaker (F5) 16, 119
- upgrade software 129
- VIDEO 10, 117
- volume up/down (F1 and F2) 118
- volume up/down on radio screen 17
- zoom (F1 and F2) 16, 118

By Category 39, 121
 By First Few Letters 39, 121
 By Phone 39, 121
 By Postal Code 39, 121

C

Camera, connecting unit to rearview 29

Category

- buttons (radio) 17
- name (radio) 17
- radio turning by 81

Changing route 48

Channel

- buttons 17
- indicator 17
- name (radio) 17
- selecting directly 80

Channels

- locking 89
- saving favorites 82
- skipping 87

- tuning by category 81
- unlocking 91
- characters, and diacritical marks 43
- Check antenna message 114
- Check mark button 42, 119
- City Name 120
- Cleaning the N.I.C.E. 103
- Compass Icon 69
- Compass Icon Display 124
- Compass indicator 16
- Compression button 26
- Computer, connecting to 105
- Contents (of package) 9
- Controls
 - music 18
 - navigation 14
 - photo viewer 19
 - radio 17
 - remote 21
 - video player 20
- Copying files to N.I.C.E. 106

Current location 48
 defining 52

Customizing
 navigation 66
 screen brightness 63

D

Database of maps, updating 103
DC IN port 11
Defaults, restoring factory for radio 93
Delete
 address from address book 57, 122
 photo and music files 110
Demonstrating navigation 52
Destination
 defining 15, 35, 53
 finding in an unfamiliar city 38
 pointing to 45
Diagnostics, GPS 125
Dimensions 130
Direct button on remote 22
Direction, of top of screen 49

DISP radio button 17
Display Options 123
Distance
 changing units 71
 remaining 16, 48
 to destination 24
 to next maneuver 16, 24, 48
DVD
 movie, playing 99
 video game button 129
 viewing 98

E

Edit Address Book 57, 122
EDIT CODE 127
Enlarged Intersection 124
Enlarged Intersection Icon 69
Exit button (F1) 14, 118
EXT I/O port 11, 75

F

- F1-F6 buttons 10
- Factory defaults, restoring for radio 93, 127
- FAQ 23
- Favorites (radio)
 - deleting 85
 - finding 85
- Favorites, storing radio favorites 84
- Firmware
 - upgrade button 129
 - upgrading 111
- Flash card/drive 95
- FM transmitter 30
 - button 129
- Folder button, music 18, 128
- Formats
 - for photos 98
 - music 95, 98
- Freeways, avoiding 23, 69
- Front view (of N.I.C.E.) 10
- Full-screen button 19, 20, 99, 128, 129

G

- Gasoline station, finding (example) 38
- Global positioning 33
- GPS
 - antenna 11, 27
 - can't find satellite 114
 - diagnostics 125
 - Icon 68
 - Icon Display 124
 - signal lost en route 114
 - signal strength 48, 51
 - signal strength weak 113

H

- Hard disk 10
- Heading Up (direction of map) 123

I

- ID number, SIRIUS radio 76
- Indicators
 - band or preset 17

- channel 17
- compass 16
- GPS signal strength 14, 48, 51
- next intersection 16
- next maneuver 16
- pointer 16
- removing from screen 68
- scale 16

Infrared sensor 10, 21

Installation 26

Intersection

- enlarged 51
- selecting 44

Interstates, avoiding 23, 69

J

Journey

- canceling 51
- previewing 52
- starting 33

JPEG format 103

K

Keyboard

- accept button (check mark) 42
- button (F5) 15, 119
- onscreen 42

Keypad buttons on radio screen 17

Kilometers 72, 124

Knobs, adjustment 26

L

Language

- changing 70
- setting 124

LCD 10

- adjusting brightness 63
- adjustments button 129
- specification 130

Lists, scrolling 41

Location

- current 48
- defining current by pointing 52

- finding in an unfamiliar city 38
- next 16
- Lock code (radio) 92
- LOCK or UNLOCK 89, 126

M

- Map 122, 125
 - button (F4) 119
 - change perspective 50
 - enlarging 50
 - maximizing view of 68
 - updating database 103
 - view button (F4) 16
- MEMO radio button 17
- Memory
 - button on remote 22
 - card/drive 95
 - specification 130
- MEMORY OPTION 127
- Menu grid 117
- MENU radio button 17
- Miles 72, 124
- Mode button (F6) 16
- mode button (F6) 117
- Mode button (toolbox) 12, 17, 18, 19, 20, 34
- Modes
 - music 13, 95
 - navigation 13
 - navigation setup 13
 - of operation 13
 - photo 13
 - SIRIUS 13
 - video 13, 98
- Mounting bracket 26
- MP3 format 95, 97, 98, 103
- Music
 - button reference 128
 - controls 96
 - copying from PC 106
 - deleting 110
 - folder, what to do if you delete 107
 - listening while navigating 25
 - main screen 96
 - mode 13

- mode button 18, 97, 128
- player controls 18
- player, main screen 18
- playing 95
- playing while navigating 61, 97
- storage 95

MUSIC button 117

Mute

- button (F4) 119
- button, remote control 22

N

N.I.C.E.

- cleaning 103
- folders 107
- starting 12
- traveling with 62
- updating software 111

NAVI button 34, 117

Navigation

- button (F3) 119
- canceling 51

- controls 14
- defining destination 15
- main screen 16, 35
- mode 13
- preference, recalculation 49
- preferences 24, 66, 123
- reference 120
- setup 122
- Setup, reference 122
- starting 14, 33

NAVSIR 75

- connecting to 27

Next

- intersection indicator 16
- location 16
- maneuver 24, 48, 124
- maneuver indicator 16
- street 48

Next Maneuver Icon 69

North

- always up 49
- Up (direction) 123

O

- On-glass mounting bracket 26
- Onscreen keyboard 42
- Operating system 130
- Origin
 - defining by pointing 52, 72
 - defining using lists 72
- OS update file can't be found message 116

P

- page up (F2)/page down (F4) buttons 15
- Parental control (radio content) 86
- PC, connecting to 105
- Perspective, changing map 50
- Photo
 - button reference 128
 - folder, what to do if you delete 107
 - mode 13
 - storage 101
 - viewer controls 19
 - viewer, main screen 19

Photos

- copying from PC 106
- deleting 110
- Place, finding in an unfamiliar city 38
- Playing songs in sequence 128
- Point of Interest 37, 121, 125
- Pointer
 - button (F3) 119
 - indicator 16
- Pointing to destination 45
- Portable memory storage
 - device button 18, 128
 - device connection 95
- Ports
 - A/V IN 11, 101
 - AUDIO OUT 11
 - DC IN 11
 - EXT. I/O 11
 - USB 1.1 (HOST) 11, 95
 - USB 2.0 (DEVICE) 11, 105
 - VIDEO IN 11
- Postal Code 120

Power

- does not turn on 113
- off 23
- on 12, 28

POWER button 10**Preferences, navigation 66****Presetting favorite radio channels 82****Previous & next buttons (photo viewer) 19****Previous Destination 37, 122, 125****Problem solving 113****Push pin button (F5) 119****R****Radio 74, 126**

- channel, selecting directly 80
- controls 17
- deleting favorites 85
- direct tuning 80
- how it works 75
- listening while navigating 25, 60
- lock code 92
- locking out channels 89

main screen 17**parental control 86****receiver 28****reference 126****saving favorites 82****searching for favorite artists/titles 85****signal strength meter 17****skipping channels 87****storing favorite artists and titles 84****subscription 76****tuning 79****tuning by band and preset 83****tuning by category 81****tuning by favorites 85****Random order to play songs 128****RCA input 11****Rearview****camera button 20, 129****camera, backing up 54****camera, connecting 29****Recalculation, automatic 49****Reference 117**

Remote control 21
Removing unit from vehicle 62
Repeating songs 128
Route
 calculation 23, 47
 canceling 51
 changing 48
 guidance, canceling 51
 guidance, reference 120
 guidance, starting 36
 marker 16
 planning 23
 previewing 52
 tracking visually 48

S

SAT (radio) 79, 127
Satellite radio 74
 controls 17
 how it works 75
 receiver 28
Satellite signal strength (GPS) 14

Scale Icon 68
Scale Icon Display 124
Scale indicator 16
Screen, adjusting brightness 63
Scroll
 down button (F4) 119
 up button (F2) 118
Scrolling lists 41
Sensor, infrared 10
Set Distance Units 124
Set Language 124
Set Origin 125
Set Volume Level 124
Setup
 mode for navigation 13
 navigation 122
 navigation preferences 66
SETUP (N.I.C.E.)
 menu 31, 63
 reference 129
Shortest Distance 69, 123
Shortest Time 69, 123

Signal strength

GPS

indicator 48

lost 114

strong, weak and none 51

weak 113

meter (radio) 17

Simulation 23, 52, 123

SIRIUS

button 10, 117

main screen 17

mode 13

radio 74

radio controls 17

reference 126

SIRIUS ID 76, 126

Slide show

buttons 19, 128

viewing 100

Software

upgrade button 129

Software, updating 111

Songs

play in random order 128

play in sequence 128

repeating 128

storing favorites 84

Sort By Distance 40

Sort By Name 40

Sound

none through speaker 115

none through stereo system 115

through stereo speakers 30

Speaker

button (F5) 16, 119

no sound 115

Special characters, typing 43

Specifications 130

Start Route Guidance 120

State/Province Name 38, 121

Static on radio 114

Station (radio), see channel

Status bar 16, 68

Status Bar Display 124

- Stereo, routing audio to vehicle 30
- Stopping navigation 51
- Storage
 - for music 95, 98
 - for photos 101
 - for video 101
- Street Name 120
- Subscription, radio 76
- System
 - diagnostics 125
 - Information 125

T

- Temperature specifications 130
- TER (radio) 79, 127
- Toll roads 123
 - avoiding 23, 69
- Trip
 - canceling 51
 - previewing 52
 - see also route
 - starting 33

- Troubleshooting 113
- Tuning
 - by preset 83
 - the radio 79

U

- Unit N.I.C.E. diagnostics 125
- Units (distance), changing 71
- Updating N.I.C.E. software 111
- USB 1.1 (HOST) port 11, 95
- USB 2.0 (DEVICE) port 11, 105
- Use as Destination 46

V

- Vehicle
 - backing up 54
 - installing N.I.C.E. in 26
- Video
 - game, playing 99
 - main screen 99
 - mode 13, 98

- player controls 20
- player, main screen 20
- VIDEO button 10, 117
- Video button, reference 129
- VIDEO IN port 11
- Viewing enlarged map 50
- Voice guidance 24, 47, 62, 123
 - on/off 73
- Volume
 - buttons on radio screen 17
 - buttons on remote control 22
 - setting 124
 - up/down button (F1 and F2) 118

W

- WAVE format 95, 98, 103
- WMA format 95, 98, 103
- Wrong turn, recovering from 48

Z

- Zoom buttons (F1 and F2) 16, 118
- Zooming in and out 50

1. Limited Warranty Information

For USA and Canada only

This product is warranted against all defects in material workmanship for a period of one year from the date of original purchase. Clarion ProAudio products, except for speakers, are covered by a two year limited warranty when installed by an authorized Clarion dealer. The conditions of this limited warranty and the extent of responsibility of Clarion Corporation of America ("Clarion") under this limited warranty are as follows:

1. PROOF OF DATE OF PURCHASE WILL BE REQUIRED FOR WARRANTY SERVICE OF THIS PRODUCT. IN THE CASE OF THE TWO (2) YEAR LIMITED WARRANTY FOR CLARION PROAUDIO PRODUCT, PROOF OF INSTALLATION BY AN AUTHORIZED DEALER IS REQUIRED. INFORMATION ABOUT CLARION AUTHORIZED WARRANTY SERVICE CENTERS MAY BE OBTAINED BY CONTACTING CLARION AT THE ADDRESS BELOW.
 2. This limited warranty will become void if service performed by anyone other than an approved Clarion Warranty Service Center results in damage to the product.
 3. This limited warranty does not apply to any product which has been subject to misuse, neglect or accident, or which has had the serial number altered, defaced or removed, or which has been connected, installed, adjusted or repaired, other than in accordance with the instructions furnished by Clarion.
 4. This limited warranty does not cover car static or other electrical interferences, tape head or laser pick-up cleaning or adjustments, or labor costs for the removal or reinstallation of the unit for repair.
 5. The sole responsibility of Clarion under this limited warranty shall be limited to the repair of the product or replacement of the product, at the sole discretion of Clarion.
6. Product must be shipped in its original carton or equivalent carton, fully insured, with shipping charges prepaid. Clarion will not assume any responsibility for any loss or damage incurred in shipping.
 7. ALL IMPLIED WARRANTIES EXCEPT TO THE EXTENT PROHIBITED BY APPLICABLE LAW SHALL HAVE NO GREATER DURATION THAN THE WARRANTY PERIOD SET FORTH ABOVE. UNDER NO CIRCUMSTANCES SHALL CLARION BE LIABLE FOR ANY LOSS OR DAMAGE, DIRECT OR CONSEQUENTIAL, ARISING OUT OF THE USE OR INABILITY TO USE THE PRODUCT. BECAUSE SOME STATES DO NOT ALLOW LIMITATIONS ON HOW LONG AN IMPLIED WARRANTY LASTS OR EXCLUSIONS OR LIMITATIONS OF INCIDENTAL OR CONSEQUENTIAL DAMAGES, THE ABOVE LIMITATIONS OR EXCLUSIONS MAY NOT APPLY TO YOU.
 8. THIS LIMITED WARRANTY GIVES YOU SPECIFIC LEGAL RIGHTS, AND YOU MAY ALSO HAVE OTHER RIGHTS WHICH VARY FROM STATE TO STATE.
 9. Should you have any difficulties with the performance of this product during the warranty period, please call or visit our web site (www.clarion.com) for a listing of Authorized Warranty Service Centers in your area. You may also contact Clarion at the address listed below.

In USA:
Clarion Corporation of America
Attn: Customer Service Manager
661 W. Redondo Beach Blvd.
Gardena, CA. 90247-4201
1-800-GO-CLARION
(310)327-9100

In Canada:
Clarion Canada, Inc.
Warranty Service Center
2239 Winston Park Drive
Oakville, Ontario L6H 5R1
(905)829-4600

© 2005 SIRIUS Satellite Radio Inc. "SIRIUS" and the SIRIUS dog logo are registered trademarks of SIRIUS Satellite Radio Inc.

Clarion Corporation of America
661 West Redondo Beach Blvd.
Gardena, California 90247-4201
www.clarion.com

NICE31805 Rev1.0

Free Manuals Download Website

<http://myh66.com>

<http://usermanuals.us>

<http://www.somanuals.com>

<http://www.4manuals.cc>

<http://www.manual-lib.com>

<http://www.404manual.com>

<http://www.luxmanual.com>

<http://aubethermostatmanual.com>

Golf course search by state

<http://golfingnear.com>

Email search by domain

<http://emailbydomain.com>

Auto manuals search

<http://auto.somanuals.com>

TV manuals search

<http://tv.somanuals.com>