



## **Catalyst 3750-E Switch Getting Started Guide INCLUDING LICENSE AND WARRANTY**

- 1** About this Guide
- 2** Taking Out What You Need
- 3** Running Express Setup
- 4** Managing the Switch
- 5** Planning Switch Stacks
- 6** Rack-Mounting
- 7** Connect to the Switch Ports
- 8** In Case of Difficulty
- 9** Obtaining Documentation
- 10** Obtaining Technical Assistance
- 11** Cisco 90-Day Limited Hardware Warranty Terms



# 1 About this Guide

This guide provides instructions on how to use Express Setup to initially configure your Catalyst switch. Also covered are switch management options, basic rack-mounting procedures, stacking procedures, port and module connection procedures, and troubleshooting help.

For additional installation and configuration information for Catalyst 3750-E switches, see the Catalyst 3750-E documentation on Cisco.com. For system requirements, important notes, limitations, open and resolved bugs, and last-minute documentation updates, see the release notes, also on Cisco.com.

When using the online publications, refer to the documents that match the Cisco IOS software version running on the switch. The software version is on the Cisco IOS label on the switch rear panel.

You can order printed copies of the manuals from the Cisco.com sites and from the telephone numbers listed in the “Obtaining Documentation” section on page 24.

For translations of the warnings that appear in this publication, see the *Regulatory Compliance and Safety Information for the Catalyst 3750-E and Catalyst 3560-E Switch* that accompanies this guide.

## 2 Taking Out What You Need

Follow these steps:

1. Unpack and remove the switch and the accessory kit from the shipping box.
2. Return the packing material to the shipping container, and save it for future use.
3. Verify that you have received the items shown on page 3. If any item is missing or damaged, contact your Cisco representative or reseller for instructions. Some switch models might include additional items that are not shown on page 3.
4. For switches with the optional 1150-W power supply module (model C3K-PWR-1150WAC), install the power supply in the switch as described in the installation notes after you rack-mount the switch.

# Shipping Box Contents

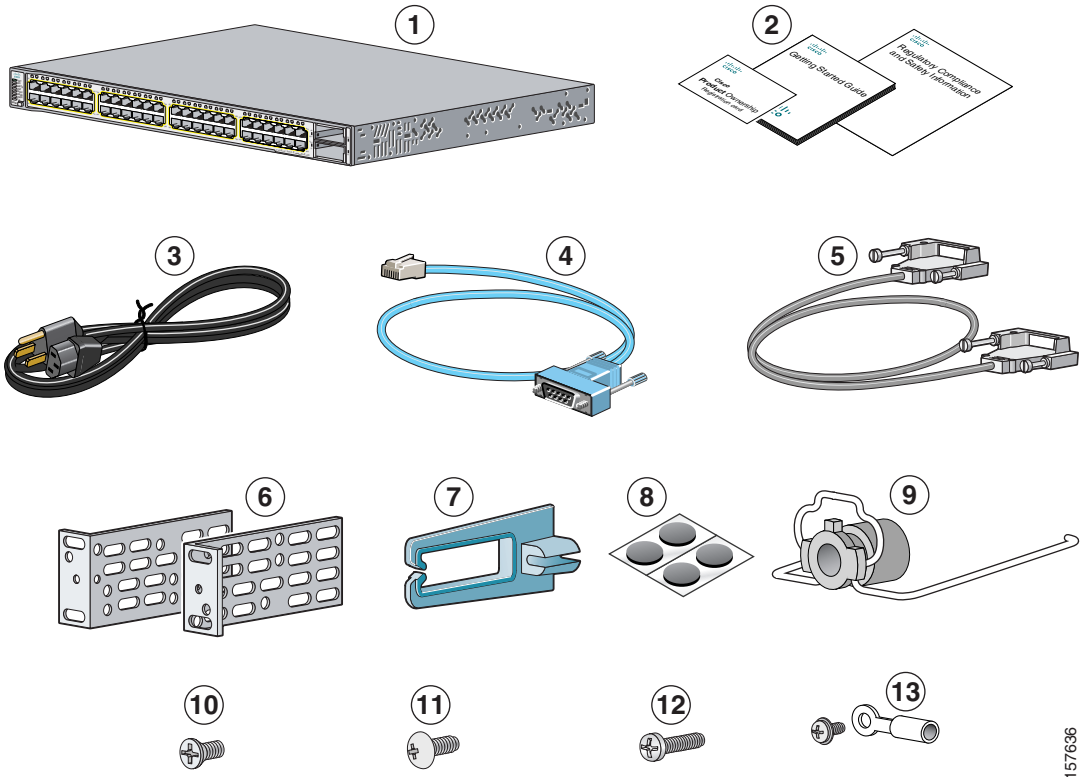

157636

<b>1</b>	Catalyst 3750E-48 Power over Ethernet (PoE) switch	<b>8</b>	Four rubber mounting feet
<b>2</b>	Documentation	<b>9</b>	Power cord retainer
<b>3</b>	AC power cord	<b>10</b>	Four number-12 Phillips machine screws
<b>4</b>	Console cable	<b>11</b>	Twelve number-8 Phillips flat-head screws
<b>5</b>	StackWise cable, 0.5-meter, 1-meter or 3-meter <sup>1</sup>	<b>12</b>	One black Phillips machine screw
<b>6</b>	Two 19-inch mounting brackets	<b>13</b>	Ground lug screw and ring terminal
<b>7</b>	Cable guide		

1. (0.5-meter supplied when not specified)

### 3 Running Express Setup

When you first set up the switch, you should use Express Setup to enter the initial IP information. Doing this enables the switch to connect to local routers and the Internet. You can then access the switch through the IP address for further configuration.

You need this equipment to set up the switch:

- A PC with Windows 2000 or XP installed.
- A web browser (Internet Explorer 5.5, 6.0, Netscape 7.1 or later) with JavaScript enabled.
- A straight-through or crossover Category 5 Ethernet cable to connect your PC to the switch.

Disable any pop-up blockers or proxy settings in your browser software and any wireless client running on your PC.

To run Express Setup:

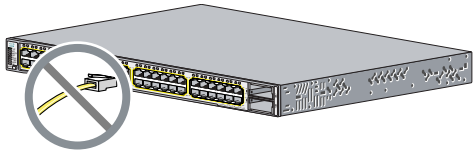
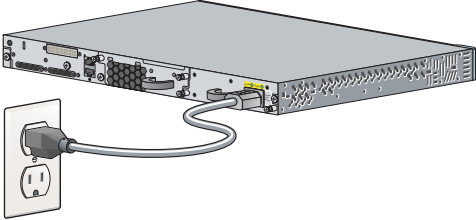
<p><b>Step 1</b> Make sure that nothing is connected to the switch.</p> <p>During Express Setup, the switch acts as a DHCP server. If your PC has a static IP address, change your PC settings before you begin to temporarily use DHCP.</p>	
<p><b>Step 2</b> Power the switch.</p> <p>For AC-powered switches, connect the AC power cord to the switch power supply and to a grounded AC outlet.</p> <p>For DC-powered switches, see the wiring instructions in the hardware installation guide on Cisco.com.</p>	
<p><b>Step 3</b> When the switch powers on, it begins the power-on self-test (POST). During POST, the LEDs blink while tests verify that the switch functions properly.</p> <p>Wait for the switch to complete POST, which can take several minutes.</p>	
<p><b>Step 4</b> Verify that POST has completed by confirming that the SYST LED remains green. If the switch fails POST, the SYST LED turns amber. See the “In Case of Difficulty” section on page 22 if your switch fails POST.</p>	

**Step 5** Press and hold the Mode button for 3 seconds. When all of the LEDs above the Mode button turn green, release the Mode button.

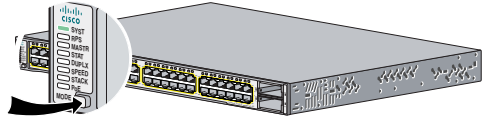

**Step 6** If the LEDs above the Mode button blink after you press the button, release it. Blinking LEDs mean that the switch is already configured and cannot go into Express Setup mode. For more information, see the “Resetting the Switch” section on page 23.

**Step 7** Verify that the switch is in Express Setup mode. Make sure that all LEDs above the Mode button are green. (On some switch models, the RPS LED remains off.)

**Step 8** Connect a Category 5 Ethernet cable to any 10/100/1000 Ethernet port on the switch front panel or to the Ethernet management port on the rear panel. Connect the other end of the cable to the Ethernet port on your PC.

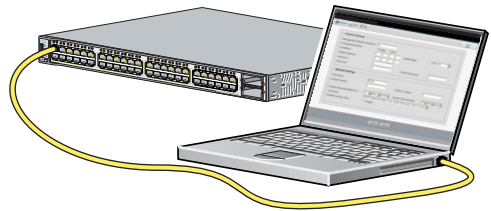

**Step 9** Verify that the LEDs on both Ethernet ports are green.  
Wait 30 seconds.

**Step 10** Launch a web browser on your PC. Enter the IP address 10.0.0.1 in the web browser, and press **Enter**.

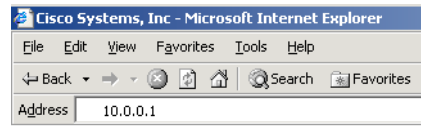

---

**Step 11** The Express Setup Basic Settings page appears. If it does not appear, see the “In Case of Difficulty” section on page 22.

Basic Settings | Advanced Settings

**Network Settings**

Management Interface (VLAN ID): 1

IP Address: [ ] [ ] [ ] [ ] Subnet Mask: 255.255.255.0

Default Gateway: [ ] [ ] [ ] [ ]

Switch Password: [ ] Confirm Switch Password: [ ]

**Ethernet Management Port Settings**

IP Address: [ ] [ ] [ ] [ ] Subnet Mask: 255.255.255.0

**Optional Settings**

Host Name: Switch

System Date (DD/MM/YYYY): 6 / Sep / 2006 System Time (HH:MM): 09 : 56 PM

Time Zone: (GMT + 05:30) Bombay, Calcutta, Madras, New Delhi

Daylight Saving Time:  Enable

157686

---

**Step 12** Enter this information in the **Network Settings** fields:

- In the **Management Interface (VLAN ID)** field, the default is 1. Enter a new VLAN ID only if you want to change the management interface through which you manage the switch. The VLAN ID range is 1 to 1001.
- In the **IP Address** field, enter the IP address of the switch. In the **IP Subnet Mask** field, click the drop-down arrow, and select an **IP Subnet Mask**.
- In the **Default Gateway** field, enter the IP address for the default gateway (router).
- Enter your password in the **Switch Password** field. The password can be from 1 to 25 alphanumeric characters, can start with a number, is case sensitive, allows embedded spaces, but does not allow spaces at the beginning or end. In the **Confirm Switch Password** field, enter your password again.

---

**Step 13** (Optional) Enter this information in the **Ethernet Management Port Settings** fields:

- In the **IP Address** field, enter the IP address of the Ethernet management port. In the **IP Subnet Mask** field, click the drop-down arrow, and select an **IP Subnet Mask**.

---

**Step 14** (Optional) You can enter the **Optional Settings** information now or enter it later by using the device manager interface:

- In the **Host Name** field, enter a name for the switch. The host name is limited to 31 characters; embedded spaces are not allowed.
  - Enter the date, time, and time zone information in the **System Date**, **System Time**, and **Time Zone** fields. Click **Enable** to enable daylight saving time.
-

**Step 15** (Optional) You can select the **Advanced Settings** tab on the Express Setup window and enter the advanced settings now or enter them later by using the device manager interface.

The screenshot shows the 'Advanced Settings' tab in a configuration window. It contains the following fields and options:

- Telnet Access:** Radio buttons for 'Enable' and 'Disable' (selected).
- Telnet Password:** Text input field.
- Confirm Telnet Password:** Text input field.
- SNMP:** Radio buttons for 'Enable' and 'Disable' (selected).
- SNMP Read Community:** Text input field.
- SNMP Write Community:** Text input field.
- System Contact:** Text input field.
- System Location:** Text input field.
- IPv6 Settings:** A checkbox labeled 'Enable IPv6' with a help icon.

157718

**Step 16** (Optional) Enter this information in the **Advanced Setting** fields:

- In the **Telnet Access** field, click **Enable** if you are going to use Telnet to manage the switch by using the command-line interface (CLI). If you enable Telnet access, you must enter a Telnet password.
- In the **Telnet Password** field, enter a password. The Telnet password can be from 1 to 25 alphanumeric characters, is case sensitive, allows embedded spaces, but does not allow spaces at the beginning or end. In the **Confirm Telnet Password** field, re-enter the Telnet password.
- In the **SNMP** field, click **Enable** to enable Simple Network Management Protocol (SNMP). Enable SNMP only if you plan to manage switches by using CiscoWorks 2000 or another SNMP-based network-management system.
- If you enable SNMP, you must enter a community string in the **SNMP Read Community** field, the **SNMP Write Community** field, or both. SNMP community strings authenticate access to MIB objects. Embedded spaces are not allowed in SNMP community strings. When you set the SNMP read community, you can access SNMP information, but you cannot change it. When you set the SNMP write community, you can both access and change SNMP information.
- In the **System Contact** and **System Location** fields, enter a contact name and the wiring closet, floor, or building where the switch is located.

**Step 17** (Optional) You can enable IPv6 on the switch in the Advanced Settings screen. In the **Enable IPv6** field, click **Enable** to enable IPv6 on the switch. Note: Enabling IPv6 restarts the switch when you complete Express Setup.

---

**Step 18** To complete Express Setup, click **Submit** in the Network Settings or the Advanced Settings screen to save your settings. Click **Cancel** to clear your settings.

When you click **Submit**, the switch is configured and exits Express Setup mode. The PC displays a warning message and then tries to connect with the new switch IP address. If you configured the switch with an IP address that is in a different subnet from the PC, connectivity between the PC and the switch is lost. If you enabled IPv6, the switch restarts.

**Step 19** Disconnect the switch from the PC, and install the switch in your production network. See the “Managing the Switch” section on page 8 for information about configuring and managing the switch.

If you need to rerun Express Setup, see the “Resetting the Switch” section on page 23.

---

## Refreshing the PC IP Address

After you complete Express Setup, you should refresh the PC IP address:

- For a dynamically assigned IP address, disconnect the PC from the switch, and reconnect the PC to the network. The network DHCP server assigns a new IP address to the PC.
- For a statically assigned IP address, change it to the previously configured IP address.

# 4 Managing the Switch

After you complete Express Setup and install the switch in your network, use the device manager or other management options described in this section for further configuration.

## Using the Device Manager

The simplest way to manage the switch is by using the device manager that is in the switch memory. This is a web interface that offers quick configuration and monitoring. You can access the device manager from anywhere in your network through a web browser.

Follow these steps:

1. Launch a web browser on your PC or workstation.
2. Enter the switch IP address in the web browser, and press **Enter**. The device manager page appears.
3. Use the device manager to perform basic switch configuration and monitoring. Refer to the device manager online help for more information.
4. For more advanced configuration, download and run the Cisco Network Assistant, which is described in the next section.



## Downloading Cisco Network Assistant

Cisco Network Assistant is a software program that you download from Cisco.com and run on your PC. It offers advanced options for configuring and monitoring multiple devices, including switches, switch clusters, switch stacks, routers, and access points. Network Assistant is free—there is no charge to download, install, or use it.

Follow these steps:

1. Go to this Web address: <http://www.cisco.com/go/NetworkAssistant>.  
You must be a registered Cisco.com user, but you need no other access privileges.
2. Find the Network Assistant installer.
3. Download the Network Assistant installer, and run it. (You can run it directly from the Web if your browser offers this choice.)
4. When you run the installer, follow the displayed instructions. In the final panel, click **Finish** to complete the Network Assistant installation.

Refer to the Network Assistant online help and the getting started guide for more information.

## Command-Line Interface

You can enter Cisco IOS commands and parameters through the CLI. Access the CLI by connecting your PC directly to the switch console port or to the Ethernet management port.

### Using the switch console port:

Follow these steps:

1. Connect the supplied RJ-45-to-DB-9 adapter cable to the standard 9-pin serial port on the PC. Connect the other end of the cable to the console port on the switch.
2. Start a terminal-emulation program on the PC.
3. Configure the PC terminal emulation software for 9600 baud, 8 data bits, no parity, 1 stop bit, and no flow control.
4. Use the CLI to enter commands to configure the switch. See the software configuration guide and the command reference for more information.

## Using the switch Ethernet management port:

Follow these steps:

1. Connect a Category 5 Ethernet cable to the PC Ethernet port. Connect the other end of the cable to the Ethernet management port on the switch rear panel.
2. Start a Telnet session on the PC.
3. Enter the switch IP address that you assigned by using Express Setup.
4. Use the CLI to enter commands to configure the switch. See the software configuration guide and the command reference for more information.

## Other Management Options

You can use SNMP management applications such as CiscoWorks Small Network Management Solution (SNMS) and HP OpenView to configure and manage the switch. You also can manage it from an SNMP-compatible workstation that is running platforms such as HP OpenView or SunNet Manager.

The Cisco IE2100 Series Configuration Registrar is a network management device that works with embedded Cisco Networking Services (CNS) agents in the switch software. You can use IE2100 to automate initial configurations and configuration updates on the switch.

See the “Accessing Help Online” section on page 23 for a list of supporting documentation.

## 5 Planning Switch Stacks

Before connecting the switches in a stack, keep in mind these stacking guidelines:

- Size of the switch and any optional power supply module. The 1150-W power supply module is longer than the other modules. Stacking switches with the same power supply modules together makes it easier to cable the switches.
- Length of cable. Depending on the configurations that you have, you might need different sized cables. If you do not specify the length of the StackWise cable, the 0.5-meter cable is supplied. If you need the 1-meter cable or the 3-meter cable, you can order it from your Cisco supplier.
- Access to the switch rear panel and to the rear of the rack if you are planning to stack the switches. If you do not have access to the rear panel, make sure that you cable the switches before you rack-mount them.
- For switch stacks that are rack-mounted, review this recommended sequence of events:
  - If you are using the RPS 2300, install the RPS first at the bottom of the stack. If needed, allow one RU space between the RPS and the first switch above to provide room for cabling.
  - Connect all the 22-pin RPS cables to the RPS 2300 as needed.
  - Rack-mount the switches. If you have the optional 1150-W power supply module, first rack-mount the switch before installing the power supply module.
  - Connect the RPS cable to the first switch above the RPS 2300. Connect the stack cables to the first switch above the RPS.
  - Connect the RPS cable to the next switch above the RPS 2300. Connect the stack cables to the next switch above the RPS.
  - Repeat until all devices are connected.

For switch dimensions, StackWise cable part numbers, and additional stacking guidelines, see the switch hardware installation guide on Cisco.com. For concepts and procedures to manage switch stacks, see the switch software configuration guide and the stack compatibility guide also on Cisco.com.

## Stack Cabling Configurations

These illustrations show the recommended switch stack configurations with redundant StackWise cabling connections for optimized stack bandwidth. For more configuration examples, see the hardware installation guide on Cisco.com.

### Vertical Stacking

In this example, the stack uses the 0.5-meter StackWise cable to make redundant connections.

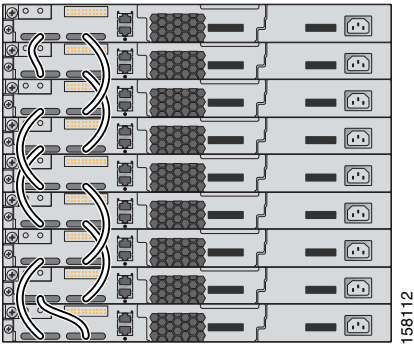

In this example, the stacks use both the 0.5- and the 3-meter StackWise cables to make redundant connections.

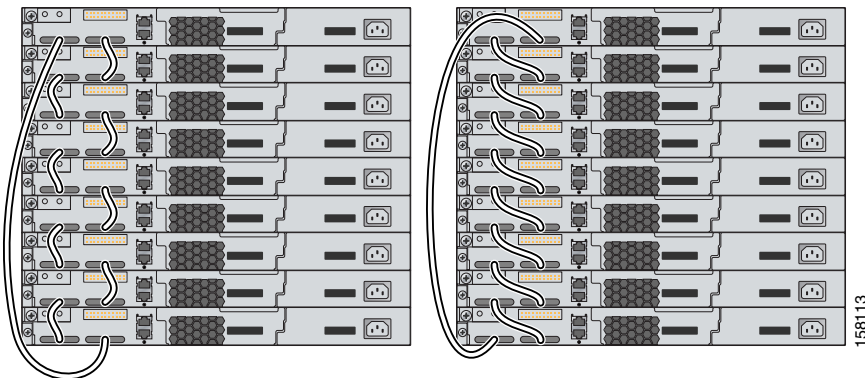

## Side-By-Side Stacking

In this example, eight switches are stacked side-by-side with redundant connections by using 0.5- and 3-meter StackWise cables.

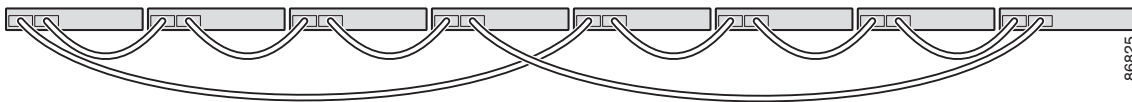

In this example, nine switches are stacked side-by-side with redundant connections by using 0.5- and 3-meter StackWise cables.

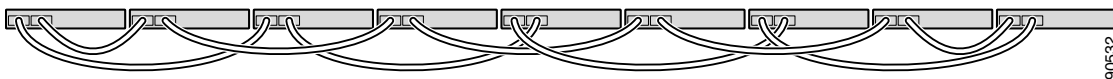

## Power On Sequence for Switch Stacks

Consider these guidelines before you power on the switches in a stack:

- The sequence in which the switches are first powered on might affect the switch that becomes the stack master.
- If you want a particular switch to become the stack master, power on that switch first. This switch becomes the stack master and remains the stack master until a master re-election is required. After 20 seconds, power on the remaining switches in the stack.
- If you have no preference for which switch becomes the stack master, power on all the switches in the stack within a 20-second timeframe. These switches participate in the stack master election. Switches powered on after the 20-second timeframe do not participate in the election.
- Power off a switch before you add it to or remove it from an existing switch stack.

For more information on stack master elections, see the “Managing Switch Stacks” chapter in the switch software configuration guide.

## 6 Rack-Mounting

This section covers basic 19-inch rack-mounting and switch port connections. As an example, all the illustrations show the Catalyst 3750E-48 PoE switch. You can install and connect other Catalyst 3750-E switches as shown in these illustrations. For additional installation and cabling information, see the hardware installation guide on Cisco.com.

### Equipment That You Supply

You need a Phillips screwdriver to rack-mount the switch. For connecting the StackWise cables, you need a ratcheting torque screwdriver capable of 5 lbf-in. (80 ozf-in.).

### Before You Begin

Before installing the switch, verify that these guidelines are met:

- Clearance to front and rear panels is such that
  - Front-panel indicators can be easily read.
  - Access to ports is sufficient for unrestricted cabling.
- Make sure that there is access to the rear of the rack if you are planning to stack the switches or connect the RPS 2300. If you do not have access to the rear panel, make that sure you cable the switches before you rack-mount them.
- If you have the optional 1150-W power supply module, first rack-mount the switch before installing the power supply module.
- AC power cord can reach from the AC power outlet to the connector on the switch rear panel.
- Cabling is away from sources of electrical noise, such as radios, power lines, and fluorescent lighting fixtures. Make sure the cabling is safely away from other devices that might damage the cables.
- Airflow around the switch and through the vents is unrestricted.
- Temperature around the unit does not exceed 113°F (45°C). If the switch is installed in a closed or multirack assembly, the temperature around it might be greater than normal room temperature.
- For copper connections on Ethernet ports, cable lengths from the switch to connected devices can be up to 328 feet (100 meters).
- For cable lengths for X2 transceiver modules and SFP-module connections, see the hardware installation guide on Cisco.com and the documentation that shipped with the module.

## Installation Warning Statements

This section includes the basic installation warning statements. Translations of these warning statements appear in the *Regulatory Compliance and Safety Information for the Catalyst 3750-E and Catalyst 3560-E Switch* document that shipped with the switch and is also available on Cisco.com.



---

### Warning

---

**To prevent the switch from overheating, do not operate it in an area that exceeds the maximum recommended ambient temperature of 113°F (45°C). To prevent airflow restriction, allow at least 3 inches (7.6 cm) of clearance around the ventilation openings.**

Statement 17B

---



---

### Warning

---

**Do not reach into a vacant slot or chassis while you install or remove a module or a fan. Exposed circuitry could constitute an energy hazard.** Statement 206

---



---

### Warning

---

**To prevent bodily injury when mounting or servicing this unit in a rack, you must take special precautions to ensure that the system remains stable. The following guidelines are provided to ensure your safety:**

- **This unit should be mounted at the bottom of the rack if it is the only unit in the rack.**
  - **When mounting this unit in a partially filled rack, load the rack from the bottom to the top with the heaviest component at the bottom of the rack.**
  - **If the rack is provided with stabilizing devices, install the stabilizers before mounting or servicing the unit in the rack.** Statement 1006
-



### Warning

**Only trained and qualified personnel should be allowed to install, replace, or service this equipment.** Statement 1030



### Caution

To comply with the Telcordia GR-1089 Network Equipment Building Systems (NEBS) standard for electromagnetic compatibility and safety, connect the Ethernet cables only to intrabuilding or nonexposed wiring or cabling.



### Note

The grounding architecture of this product is DC-isolated (DC-I)

## Before Attaching the Brackets

To install the switch in a rack, you must first remove the screws from the switch chassis so that the mounting brackets can be attached. For attachment at the front-mounting position, remove two Phillips truss-head screws from the switch side panels. For attachment at the mid-mounting position, remove one screw. For attachment at the rear-mounting position, remove two screws.

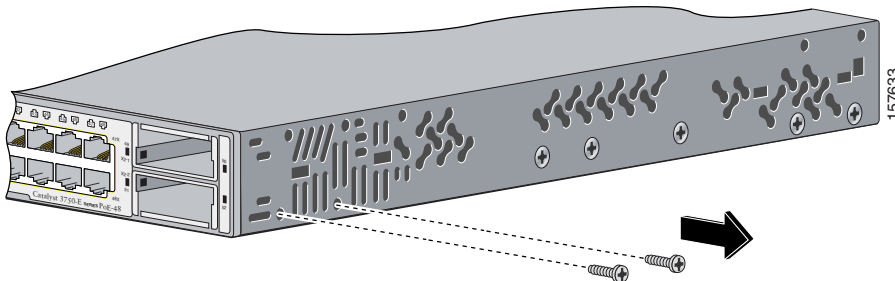



## Attaching the Brackets

Use four number-8 Phillips flat-head screws to attach the long side of each bracket to the switch in one of three mounting positions.

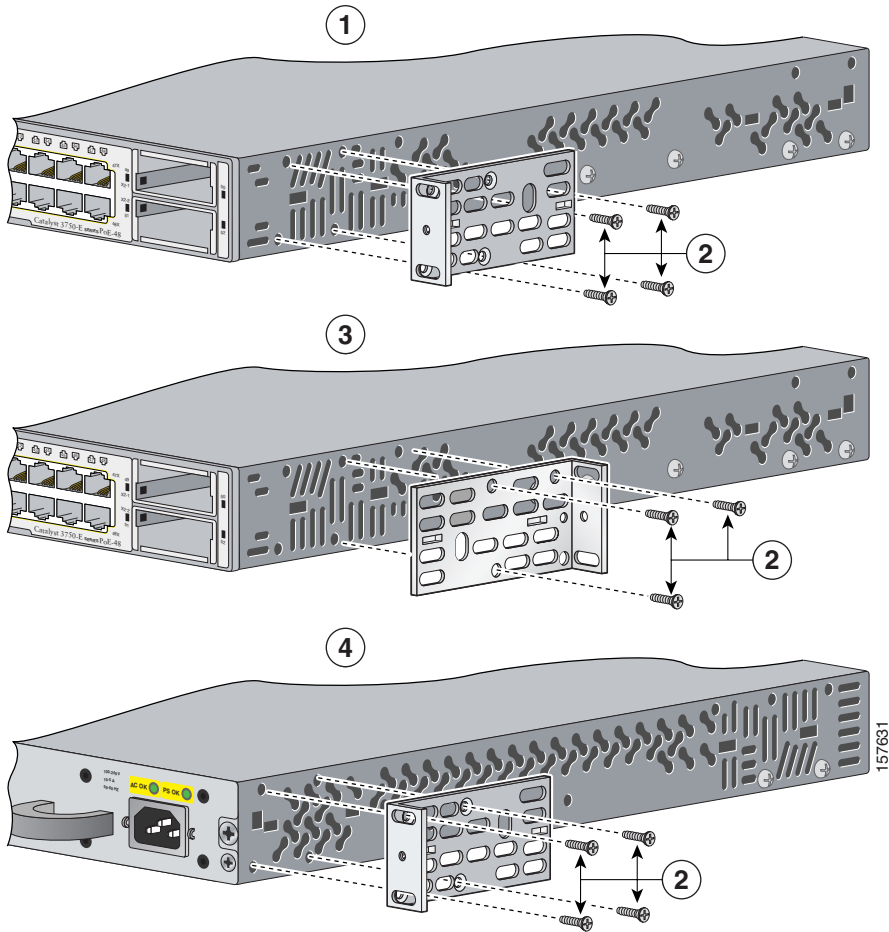

<b>1</b>	Front-mounting position	<b>3</b>	Mid-mounting position
<b>2</b>	Number-8 Phillips flat-head screws	<b>4</b>	Rear-mounting position

## Rack-Mount the Switch

Use the four number-12 Phillips machine screws to attach the brackets to the rack. Use the black Phillips machine screw to attach the cable guide to the left or right bracket.

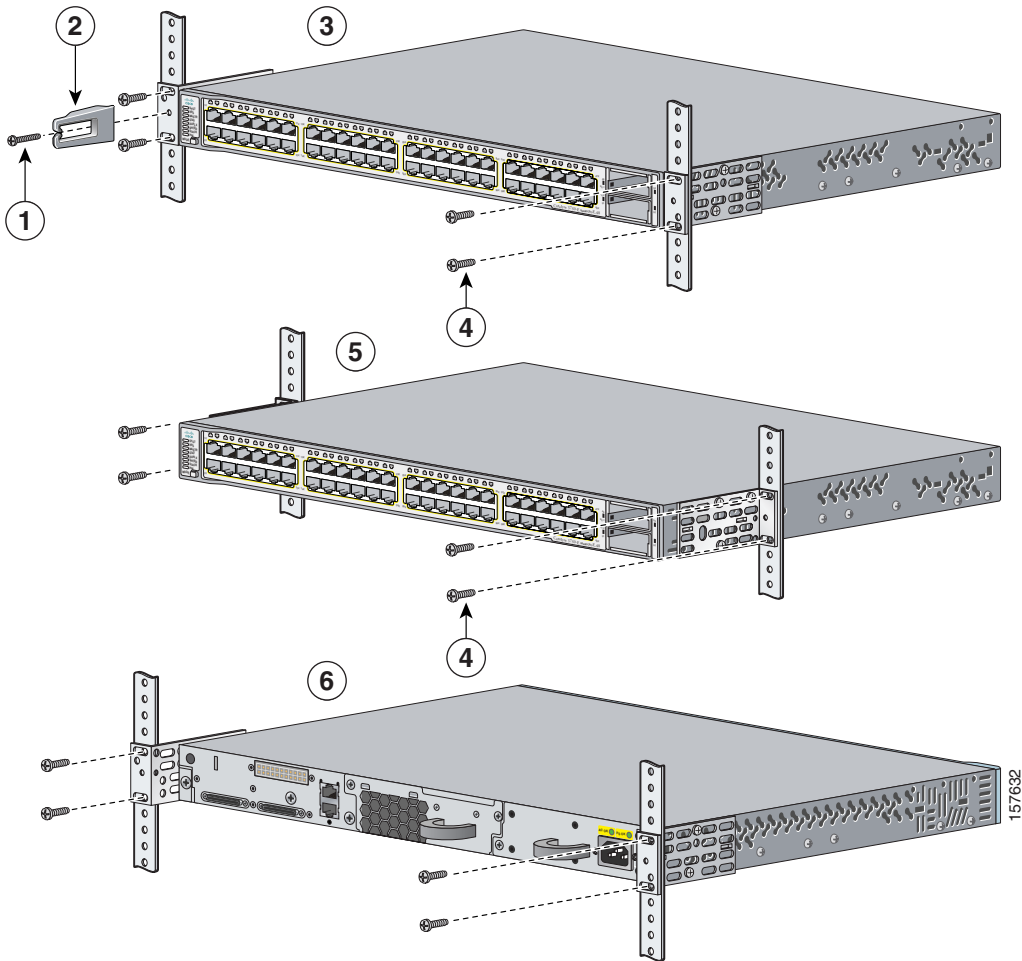

1	Black Phillips machine screw	4	Number-12 Phillips machine screws
2	Cable guide	5	Mid-mounting position
3	Front-mounting position	6	Rear-mounting position

## Connect the StackWise Cables

Use the window in the StackWise cable to align the connector correctly. Insert the cable into the StackWise port on the back of the switch. Using a ratcheting torque screwdriver, tighten the retainer screws to 5 lbf-in. (80 ozf-in.). Insert the other end of the cable into the connector of the other switch, and tighten the retainer screws to 5 lbf-in. (80 ozf-in.). Avoid overtightening the screws. Always use a Cisco-approved StackWise cable to connect the switches.

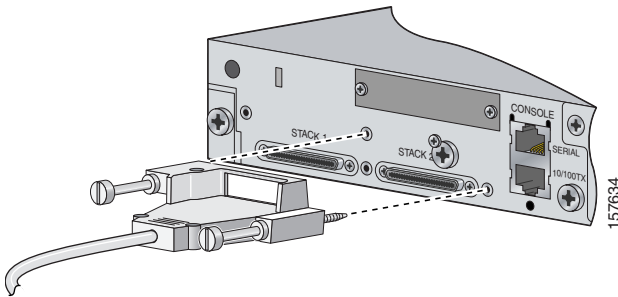

### Caution

---

Removing and installing the StackWise cable can shorten its useful life. Do not remove and insert the cable more often than is absolutely necessary.

---

## 7 Connect to the Switch Ports

This section describes how to connect to the fixed switch ports and to the 10-Gigabit Ethernet module slots.

### Connect to 10/100/1000 Ports

The 10/100/1000 Ethernet ports use standard RJ-45 connectors with Ethernet pinouts. The maximum cable length is 328 feet (100 meters). The 100BASE-TX and 1000BASE-T traffic requires Category 5, Category 5e, or Category 6 UTP cable. The 10BASE-T traffic can use Category 3 or Category 4 cable.

The autonegotiation feature is enabled by default on the switch. At this setting, the switch ports configure themselves to operate at the speed of attached devices. If the attached device does not support autonegotiation, you can explicitly set the switch port speed and the duplex parameters. To maximize performance, either let the ports autonegotiate both speed and duplex, or set the port speed and duplex parameters on both ends of the connection.

For simplified cabling, the automatic medium-dependent interface crossover (auto-MDIX) feature is enabled by default on the switch. With auto-MDIX enabled, the switch detects the required cable type for copper Ethernet connections and configures the interface accordingly. Therefore, you can use either a crossover or a straight-through cable for connections to a switch 10/100/1000 Ethernet port, regardless of the type of device on the other end of the connection.

See the switch software configuration guide or the switch command reference on Cisco.com for more information about enabling or disabling autonegotiation and auto-MDIX.

### Connect to 10/100/1000 PoE Ports

The 10/100/1000 PoE ports have the same default settings and cabling requirements that are described in the previous section.

The PoE ports provide PoE support for devices compliant with IEEE 802.3af and also provide Cisco pre-standard PoE support for Cisco IP Phones and Cisco Aironet Access Points.

Each port can deliver up to 15.4 W of PoE. With the 1150-W power supply module, the Catalyst 3750E-48PS switch can deliver 15.4 W on all 48 ports. With the 750-W power supply module, the switches can deliver 15.4 W of PoE on any 24 of the 48 ports, or any combination of the ports can deliver an average of 7.7 W of PoE at the same time, up to a maximum switch power output of 370 W. On a per-port basis, you can control whether or not a PoE port automatically provides power when an IP phone or an access point is connected.

See the hardware installation guide on Cisco.com for more information about the switch power supply options.

## Install and Connect to Devices in the 10-Gigabit Ethernet Slots

The switch 10-Gigabit Ethernet module slots are used for connections to other switches and routers. The module slots operate in full-duplex mode and use the hot-swappable Cisco X2 transceiver modules and the Cisco TwinGig Converter Module. The X2 transceiver modules have SC connectors to connect to multimode fiber (MMF) and single-mode fiber (SMF) cables. The Cisco converter modules have two SFP-module slots that convert the 10-Gigabit interface into a dual SFP interface.

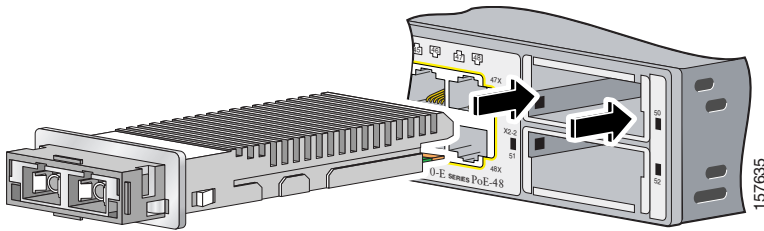

When installing a transceiver module or the Cisco TwinGig Converter Module in the upper 10-Gigabit Ethernet module slot (slot 1), position the module face up. When using the lower module slot (slot 2), position the module face down.

Use only Cisco X2 transceiver modules, Cisco converter modules, and Cisco SFP modules with the switch. Each Cisco module has an internal serial EEPROM that is encoded with security information. This encoding provides a way for Cisco to identify and validate that the module meets the requirements for the switch.

## Verify Port Connectivity

After you connect a device to the switch port, the port LED turns amber while the switch establishes a link. This process takes about 30 seconds. Then the LED turns green when the switch and the attached device have an established link. If the LED is off, the device might not be turned on, there might be a cable problem, or there might be a problem with the adapter installed in the device. See the “In Case of Difficulty” section on page 22 for information about online assistance.

## 8 In Case of Difficulty

If you experience difficulty, help is available in this section and also on Cisco.com. This section includes Express Setup troubleshooting, how to reset the switch, how to access help online, and where to find more information.

### Troubleshooting Express Setup

If Express Setup does not run, or if the Express Setup page does not appear in your browser:

- Did you verify that POST successfully ran before starting Express Setup?  
If not, make sure that only the SYST and STAT LEDs are green before pressing the Mode button to enter the Express Setup mode.
- Did you press the Mode button while the switch was still running POST?  
If yes, wait until POST completes. Power cycle the switch. Wait until POST completes. Confirm that the SYST and STAT LEDs are green. Press the Mode button to enter Express Setup mode.
- Did you try to continue without confirming that the switch was in Express Setup mode?  
Verify that all LEDs above the Mode button are green. (The RPS LED is off.) If necessary, press the Mode button to enter Express Setup mode.
- Does your PC have a static IP address?  
If yes, change your PC settings to temporarily use DHCP before connecting to the switch.
- Did you connect the Ethernet cable to the console port instead of to a 10/100/1000 Ethernet port or the 10/100 Ethernet management port on the switch?  
If yes, disconnect the cable from the console port. Then connect the cable to an Ethernet port on the switch and on the PC. Wait 30 seconds before you enter **10.0.0.1** in the browser.
- Did you wait 30 seconds after you connected the switch and the PC before you entered the IP address in your browser?  
If not, wait 30 seconds, re-enter **10.0.0.1** in the browser, and press **Enter**.
- Did you enter the wrong address in the browser, or is there an error message?  
If yes, re-enter **10.0.0.1** in the browser, and press **Enter**.

## Resetting the Switch

This section describes how to reset the switch by rerunning Express Setup. These are reasons why you might want to reset the switch:

- You installed the switch in your network and cannot connect to it because you assigned the incorrect IP address.
- You want to clear all configuration from the switch and assign a new IP address.
- You are trying to enter Express Setup mode, and the switch LEDs start blinking when you press the Mode button (which means that the switch is already configured with IP information).



### Caution

---

Resetting the switch deletes the configuration and reboots the switch.

---

To reset the switch:

- Press and hold the Mode button. The switch LEDs begin blinking after about 3 seconds. Continue holding down the Mode button. The LEDs stop blinking after 7 more seconds, and then the switch reboots.

The switch now behaves like an unconfigured switch. You can enter the switch IP information by using Express Setup as described in the “Running Express Setup” section on page 4.

## Accessing Help Online

First look for a solution to your problem in the troubleshooting section of the hardware installation guide or the software configuration guide on Cisco.com. You can also access the Cisco Technical Support and Documentation website for a list of known hardware problems and extensive troubleshooting documentation.

## For More Information

For more information about the switch, see these documents on Cisco.com:

- *Catalyst 3750-E and Catalyst 3560-E Switch Hardware Installation Guide* (not orderable, but available on Cisco.com).
- *Regulatory Compliance and Safety Information for the Catalyst 3750-E and Catalyst 3560-E Switch* (order number DOC-7817569=).
- *Release Notes for the Catalyst 3750-E and Catalyst 3560-E Switch* (not orderable but available on Cisco.com)

- *Catalyst 3750-E and Catalyst 3560-E Switch Software Configuration Guide* (not orderable, but available on Cisco.com).
- *Catalyst 3750-E and Catalyst 3560-E Switch Stack Compatibility Guide* (not orderable but available on Cisco.com)
- *Catalyst 3750-E and Catalyst 3560-E Switch Command Reference* (not orderable, but available on Cisco.com).
- *Catalyst 3750-E and Catalyst 3560-E Switch System Message Guide* (not orderable, but available on Cisco.com).
- *Installation Notes for the Catalyst 3750-E, Catalyst 3560-E, and RPS 2300 Power Supply Modules* (order number DOC-7817570=)
- *Installation Notes for the Catalyst 3750-E and Catalyst 3560-E Switch Fan Module* (order number DOC-7817571=)
- *Installation Notes for the Cisco TwinGig Converter Module* (order number DOC-7817572=)
- *Cisco Redundant Power System 2300 Hardware Installation Guide* (order number DOC-7817647=)
- *Cisco Redundant Power System 2300 Compatibility Matrix* (not orderable but available on Cisco.com)

## 9 Obtaining Documentation

Cisco documentation and additional literature are available on Cisco.com. Cisco also provides several ways to obtain technical assistance and other technical resources. These sections explain how to obtain technical information from Cisco Systems.

### Cisco.com

You can access the most current Cisco documentation at this URL:

<http://www.cisco.com/univercd/home/home.htm>

You can access the Cisco website at this URL:

<http://www.cisco.com>

You can access international Cisco websites at this URL:

[http://www.cisco.com/public/countries\\_languages.shtml](http://www.cisco.com/public/countries_languages.shtml)



## Documentation DVD

Cisco documentation and additional literature are available in a Documentation DVD package, which may have shipped with your product. The Documentation DVD is updated regularly and may be more current than printed documentation. The Documentation DVD package is available as a single unit.

Registered Cisco.com users (Cisco direct customers) can order a Cisco Documentation DVD (product number DOC-DOCDVD=) from the Ordering tool or Cisco Marketplace.

Cisco Ordering tool:

<http://www.cisco.com/en/US/partner/ordering/>

Cisco Marketplace:

<http://www.cisco.com/go/marketplace/>

## Ordering Documentation

You can find instructions for ordering documentation at this URL:

[http://www.cisco.com/univercd/cc/td/doc/es\\_inpk/pdi.htm](http://www.cisco.com/univercd/cc/td/doc/es_inpk/pdi.htm)

You can order Cisco documentation in these ways:

- Registered Cisco.com users (Cisco direct customers) can order Cisco product documentation from the Ordering tool:  
<http://www.cisco.com/en/US/partner/ordering/>
- Nonregistered Cisco.com users can order documentation through a local account representative by calling Cisco Systems Corporate Headquarters (California, USA) at 408 526-7208 or, elsewhere in North America, by calling 1 800 553-NETS (6387).

## Documentation Feedback

You can send comments about technical documentation to [bug-doc@cisco.com](mailto:bug-doc@cisco.com).

You can submit comments by using the response card (if present) behind the front cover of your document or by writing to the following address:

Cisco Systems  
Attn: Customer Document Ordering  
170 West Tasman Drive  
San Jose, CA 95134-9883

We appreciate your comments.

# Cisco Product Security Overview

Cisco provides a free online Security Vulnerability Policy portal at this URL:

[http://www.cisco.com/en/US/products/products\\_security\\_vulnerability\\_policy.html](http://www.cisco.com/en/US/products/products_security_vulnerability_policy.html)

From this site, you can perform these tasks:

- Report security vulnerabilities in Cisco products.
- Obtain assistance with security incidents that involve Cisco products.
- Register to receive security information from Cisco.

A current list of security advisories and notices for Cisco products is available at this URL:

<http://www.cisco.com/go/psirt>

If you prefer to see advisories and notices as they are updated in real time, you can access a Product Security Incident Response Team Really Simple Syndication (PSIRT RSS) feed from this URL:

[http://www.cisco.com/en/US/products/products\\_psirt\\_rss\\_feed.html](http://www.cisco.com/en/US/products/products_psirt_rss_feed.html)

## Reporting Security Problems in Cisco Products

Cisco is committed to delivering secure products. We test our products internally before we release them, and we strive to correct all vulnerabilities quickly. If you think that you might have identified a vulnerability in a Cisco product, contact PSIRT:

- Emergencies—[security-alert@cisco.com](mailto:security-alert@cisco.com)
- Nonemergencies—[psirt@cisco.com](mailto:psirt@cisco.com)



**Tip** We encourage you to use Pretty Good Privacy (PGP) or a compatible product to encrypt any sensitive information that you send to Cisco. PSIRT can work from encrypted information that is compatible with PGP versions 2.x through 8.x.

Never use a revoked or an expired encryption key. The correct public key to use in your correspondence with PSIRT is the one that has the most recent creation date in this public key server list:

<http://pgp.mit.edu:11371/pks/lookup?search=psirt%40cisco.com&op=index&exact=on>

In an emergency, you can also reach PSIRT by telephone:

- 1 877 228-7302
- 1 408 525-6532

# 10 Obtaining Technical Assistance

For all customers, partners, resellers, and distributors who hold valid Cisco service contracts, Cisco Technical Support provides 24-hour-a-day, award-winning technical assistance. The Cisco Technical Support Website on Cisco.com features extensive online support resources. In addition, Cisco Technical Assistance Center (TAC) engineers provide telephone support. If you do not hold a valid Cisco service contract, contact your reseller.

## Cisco Technical Support Website

The Cisco Technical Support Website provides online documents and tools for troubleshooting and resolving technical issues with Cisco products and technologies. The website is available 24 hours a day, 365 days a year, at this URL:

<http://www.cisco.com/techsupport>

Access to all tools on the Cisco Technical Support Website requires a Cisco.com user ID and password. If you have a valid service contract but do not have a user ID or password, you can register at this URL:

<http://tools.cisco.com/RPF/register/register.do>



### Note

---

Use the Cisco Product Identification (CPI) tool to locate your product serial number before submitting a web or phone request for service. You can access the CPI tool from the Cisco Technical Support Website by clicking the **Tools & Resources** link under Documentation & Tools. Choose **Cisco Product Identification Tool** from the Alphabetical Index drop-down list, or click the **Cisco Product Identification Tool** link under Alerts & RMAs. The CPI tool offers three search options: by product ID or model name; by tree view; or for certain products, by copying and pasting **show** command output. Search results show an illustration of your product with the serial number label location highlighted. Locate the serial number label on your product and record the information before placing a service call.

---

## Submitting a Service Request

Using the online TAC Service Request Tool is the fastest way to open S3 and S4 service requests. (S3 and S4 service requests are those in which your network is minimally impaired or for which you require product information.) After you describe your situation, the TAC Service Request Tool provides recommended solutions. If your issue is not resolved using the recommended resources, your service request is assigned to a Cisco TAC engineer. The TAC Service Request Tool is located at this URL:

<http://www.cisco.com/techsupport/servicerequest>

For S1 or S2 service requests or if you do not have Internet access, contact the Cisco TAC by telephone. (S1 or S2 service requests are those in which your production network is down or severely degraded.) Cisco TAC engineers are assigned immediately to S1 and S2 service requests to help keep your business operations running smoothly.

To open a service request by telephone, use one of the following numbers:

Asia-Pacific: +61 2 8446 7411 (Australia: 1 800 805 227)

EMEA: +32 2 704 55 55

USA: 1 800 553-2447

For a complete list of Cisco TAC contacts, go to this URL:

<http://www.cisco.com/techsupport/contacts>

## Definitions of Service Request Severity

To ensure that all service requests are reported in a standard format, Cisco has established severity definitions.

**Severity 1 (S1)**—Your network is “down,” or there is a critical impact to your business operations. You and Cisco will commit all necessary resources around the clock to resolve the situation.

**Severity 2 (S2)**—Operation of an existing network is severely degraded, or significant aspects of your business operation are negatively affected by inadequate performance of Cisco products. You and Cisco will commit full-time resources during normal business hours to resolve the situation.

**Severity 3 (S3)**—Operational performance of your network is impaired, but most business operations remain functional. You and Cisco will commit resources during normal business hours to restore service to satisfactory levels.

**Severity 4 (S4)**—You require information or assistance with Cisco product capabilities, installation, or configuration. There is little or no effect on your business operations.

## Obtaining Additional Publications and Information

Information about Cisco products, technologies, and network solutions is available from various online and printed sources.

- Cisco Marketplace provides a variety of Cisco books, reference guides, and logo merchandise. Visit Cisco Marketplace, the company store, at this URL:  
<http://www.cisco.com/go/marketplace/>
- *Cisco Press* publishes a wide range of general networking, training and certification titles. Both new and experienced users will benefit from these publications. For current Cisco Press titles and other information, go to Cisco Press at this URL:

<http://www.ciscopress.com>

- *Internet Protocol Journal* is a quarterly journal published by Cisco Systems for engineering professionals involved in designing, developing, and operating public and private internets and intranets. You can access the Internet Protocol Journal at this URL:  
<http://www.cisco.com/ipj>
- World-class networking training is available from Cisco. You can view current offerings at this URL:  
<http://www.cisco.com/en/US/learning/index.html>

## 11 Cisco 90-Day Limited Hardware Warranty Terms

There are special terms applicable to your hardware warranty and various services that you can use during the warranty period. Your formal Warranty Statement, including the warranties and license agreements applicable to Cisco software, is available on Cisco.com. Follow these steps to access and download the *Cisco Information Packet* and your warranty and license agreements from Cisco.com.

1. Launch your browser, and go to this URL:  
[http://www.cisco.com/univercd/cc/td/doc/es\\_inpck/cetrans.htm](http://www.cisco.com/univercd/cc/td/doc/es_inpck/cetrans.htm)  
The Warranties and License Agreements page appears.
2. To read the *Cisco Information Packet*, follow these steps:
  - a. Click the **Information Packet Number** field, and make sure that the part number 78-5235-03B0 is highlighted.
  - b. Select the language in which you would like to read the document.
  - c. Click **Go**.  
The Cisco Limited Warranty and Software License page from the Information Packet appears.
  - d. Read the document online, or click the **PDF** icon to download and print the document in Adobe Portable Document Format (PDF).



### Note

You must have Adobe Acrobat Reader to view and print PDF files. You can download the reader from Adobe's website: <http://www.adobe.com>

3. To read translated and localized warranty information about your product, follow these steps:
  - a. Enter this part number in the Warranty Document Number field:  
78-5236-01C0
  - b. Select the language in which you would like to read the document.
  - c. Click **Go**.  
The Cisco warranty page appears.

- d. Review the document online, or click the PDF icon to download and print the document in Adobe Portable Document Format (PDF).

You can also contact the Cisco service and support website for assistance:

[http://www.cisco.com/public/Support\\_root.shtml](http://www.cisco.com/public/Support_root.shtml).

### **Duration of Hardware Warranty**

Ninety (90) days.

### **Replacement, Repair, or Refund Policy for Hardware**

Cisco or its service center will use commercially reasonable efforts to ship a replacement part within ten (10) working days after receipt of a Return Materials Authorization (RMA) request. Actual delivery times can vary, depending on the customer location.

Cisco reserves the right to refund the purchase price as its exclusive warranty remedy.

### **To Receive a Return Materials Authorization (RMA) Number**

Contact the company from whom you purchased the product. If you purchased the product directly from Cisco, contact your Cisco Sales and Service Representative.

Complete the information below, and keep it for reference:

Company product purchased from	
Company telephone number	
Product model number	
Product serial number	
Maintenance contract number	





**Corporate Headquarters**  
Cisco Systems, Inc.  
170 West Tasman Drive  
San Jose, CA 95134-1706  
USA  
www.cisco.com  
Tel: 408 526-4000  
800 553-NETS (6387)  
Fax: 408 526-4100

**European Headquarters**  
Cisco Systems International BV  
Haarlerbergpark  
Haarlerbergweg 13-19  
1101 CH Amsterdam  
The Netherlands  
www-europe.cisco.com  
Tel: 31 0 20 357 1000  
Fax: 31 0 20 357 1100

**Americas Headquarters**  
Cisco Systems, Inc.  
170 West Tasman Drive  
San Jose, CA 95134-1706  
USA  
www.cisco.com  
Tel: 408 526-7660  
Fax: 408 527-0883

**Asia Pacific Headquarters**  
Cisco Systems, Inc.  
168 Robinson Road  
#28-01 Capital Tower  
Singapore 068912  
www.cisco.com  
Tel: +65 6317 7777  
Fax: +65 6317 7799

Cisco Systems has more than 200 offices in the following countries. Addresses, phone numbers, and fax numbers are listed on the **Cisco Website at [www.cisco.com/go/offices](http://www.cisco.com/go/offices)**

Argentina • Australia • Austria • Belgium • Brazil • Bulgaria • Canada • Chile • China PRC • Colombia • Costa Rica • Croatia • Cyprus • Czech Republic • Denmark • Dubai, UAE  
Finland • France • Germany • Greece • Hong Kong SAR • Hungary • India • Indonesia • Ireland • Israel • Italy • Japan • Korea • Luxembourg • Malaysia • Mexico  
The Netherlands • New Zealand • Norway • Peru • Philippines • Poland • Portugal • Puerto Rico • Romania • Russia • Saudi Arabia • Scotland • Singapore  
Slovakia • Slovenia • South Africa • Spain • Sweden • Switzerland • Taiwan • Thailand • Turkey • Ukraine • United Kingdom • United States • Venezuela • Vietnam • Zimbabwe

© 2006 Cisco Systems, Inc. All rights reserved.

78-17568-01  
DOC-7817568=



## Free Manuals Download Website

<http://myh66.com>

<http://usermanuals.us>

<http://www.somanuals.com>

<http://www.4manuals.cc>

<http://www.manual-lib.com>

<http://www.404manual.com>

<http://www.luxmanual.com>

<http://aubethermostatmanual.com>

Golf course search by state

<http://golfingnear.com>

Email search by domain

<http://emailbydomain.com>

Auto manuals search

<http://auto.somanuals.com>

TV manuals search

<http://tv.somanuals.com>