



Cisco Video Surveillance 2500 Series IP Camera User Guide

Models CIVS-IPC-2500 and CIVS-IPC-2500W

Americas Headquarters

Cisco Systems, Inc.
170 West Tasman Drive
San Jose, CA 95134-1706
USA
<http://www.cisco.com>
Tel: 408 526-4000
800 553-NETS (6387)
Fax: 408 527-0883

Text Part Number: OL-19273-02

NOTICE. ALL STATEMENTS, INFORMATION, AND RECOMMENDATIONS IN THIS MANUAL ARE BELIEVED TO BE ACCURATE BUT ARE PRESENTED WITHOUT WARRANTY OF ANY KIND, EXPRESS OR IMPLIED. USERS MUST TAKE FULL RESPONSIBILITY FOR THEIR APPLICATION OF ANY PRODUCTS.

THE SOFTWARE LICENSE AND LIMITED WARRANTY FOR THE ACCOMPANYING PRODUCT ARE SET FORTH IN THE INFORMATION PACKET THAT SHIPPED WITH THE PRODUCT AND ARE INCORPORATED HEREIN BY THIS REFERENCE. IF YOU ARE UNABLE TO LOCATE THE SOFTWARE LICENSE OR LIMITED WARRANTY, CONTACT YOUR CISCO REPRESENTATIVE FOR A COPY.

The Cisco implementation of TCP header compression is an adaptation of a program developed by the University of California, Berkeley (UCB) as part of UCB's public domain version of the UNIX operating system. All rights reserved. Copyright © 1981, Regents of the University of California.

NOTWITHSTANDING ANY OTHER WARRANTY HEREIN, ALL DOCUMENT FILES AND SOFTWARE OF THESE SUPPLIERS ARE PROVIDED "AS IS" WITH ALL FAULTS. CISCO AND THE ABOVE-NAMED SUPPLIERS DISCLAIM ALL WARRANTIES, EXPRESSED OR IMPLIED, INCLUDING, WITHOUT LIMITATION, THOSE OF MERCHANTABILITY, FITNESS FOR A PARTICULAR PURPOSE AND NONINFRINGEMENT OR ARISING FROM A COURSE OF DEALING, USAGE, OR TRADE PRACTICE.

IN NO EVENT SHALL CISCO OR ITS SUPPLIERS BE LIABLE FOR ANY INDIRECT, SPECIAL, CONSEQUENTIAL, OR INCIDENTAL DAMAGES, INCLUDING, WITHOUT LIMITATION, LOST PROFITS OR LOSS OR DAMAGE TO DATA ARISING OUT OF THE USE OR INABILITY TO USE THIS MANUAL, EVEN IF CISCO OR ITS SUPPLIERS HAVE BEEN ADVISED OF THE POSSIBILITY OF SUCH DAMAGES.

CCDE, CCENT, Cisco Eos, Cisco Lumin, Cisco Nexus, Cisco StadiumVision, Cisco TelePresence, Cisco WebEx, the Cisco logo, DCE, and Welcome to the Human Network are trademarks; Changing the Way We Work, Live, Play, and Learn and Cisco Store are service marks; and Access Registrar, Aironet, AsyncOS, Bringing the Meeting To You, Catalyst, CCDA, CCDP, CCIE, CCIP, CCNA, CCNP, CCSP, CCVP, Cisco, the Cisco Certified Internetwork Expert logo, Cisco IOS, Cisco Press, Cisco Systems, Cisco Systems Capital, the Cisco Systems logo, Cisco Unity, Collaboration Without Limitation, EtherFast, EtherSwitch, Event Center, Fast Step, Follow Me Browsing, FormShare, GigaDrive, HomeLink, Internet Quotient, IOS, iPhone, iQuick Study, IronPort, the IronPort logo, LightStream, Linksys, MediaTone, MeetingPlace, MeetingPlace Chime Sound, MGX, Networkers, Networking Academy, Network Registrar, PCNow, PIX, PowerPanels, ProConnect, ScriptShare, SenderBase, SMARTnet, Spectrum Expert, StackWise, The Fastest Way to Increase Your Internet Quotient, TransPath, WebEx, and the WebEx logo are registered trademarks of Cisco Systems, Inc. and/or its affiliates in the United States and certain other countries.

All other trademarks mentioned in this document or website are the property of their respective owners. The use of the word partner does not imply a partnership relationship between Cisco and any other company. (0809R)

Cisco Video Surveillance 2500 Series IP Camera User Guide
Copyright © 2008-2011 Cisco Systems, Inc. All rights reserved.



CONTENTS

Preface 1-5

Overview 1-5

Organization 1-5

Obtaining Documentation, Obtaining Support, and Security Guidelines 1-5

CHAPTER 1

Overview 1-1

Features 1-1

IP Camera Physical Details 1-2

DC Auto Iris Lens Connector Pinouts 1-6

Package Contents 1-6

CHAPTER 2

Getting Started 2-1

Installing the Cisco Video Surveillance IP Camera 2-1

Performing the Initial Setup of the IP Camera 2-5

Accessing the IP Camera Windows 2-6

Adjusting Back Focus on the IP Camera 2-8

Powering the IP Camera On or Off 2-8

Resetting the IP Camera 2-9

Converting a Wireless Camera between Wired and Wireless Modes 2-9

Cleaning the IP Camera 2-10

CHAPTER 3

Configuring and Managing the IP Camera 3-1

Configuration Overview 3-1

Navigating the Configuration Windows 3-4

Setup Windows 3-5

Basic Setup Window 3-5

Wireless Setup Window 3-7

Advanced Setup Window 3-11

IP Filter Window 3-14

EAPOL Window 3-14

Administration Windows 3-15

Users Window 3-16

Maintenance Window 3-17

Firmware Window	3-19
Audio/Video Windows	3-19
Video Window	3-19
Audio Window	3-24
Security Windows	3-26
Product Process Window	3-26
Initialization Window	3-27
Complexity Window	3-27
Applications Windows	3-28
Mail & FTP Window	3-28
Motion Detection Window	3-30
Event Window	3-31
SNMP Window	3-34
Alarm I/O Ports Window	3-35
PTZ (RS-485) Window	3-36
Preset Positions Window	3-37
Status Windows	3-38
System Window	3-39
Audio/Video Window	3-39
Network Window	3-40
Syslog & Log Window	3-41
Video Log Window	3-46

CHAPTER 4**Viewing Live Video 4-1**

Viewing Video through the Home Window Overview	4-1
Home Window Overview	4-1
Home Window Controls	4-3
Viewing Video through Third-Party Devices or Software	4-6

CHAPTER 5**Troubleshooting 5-1****APPENDIX A****Using the IP Camera with Cisco VSM 1-1****INDEX**



Preface

Overview

This document provides information about installing, configuring, using, managing, and troubleshooting following products:

- Cisco Video Surveillance 2500 IP Camera, model CIVS-IPC-2500
- Cisco Video Surveillance 2500W IP Camera, model CIVS-IPC-2500W

Organization

This manual is organized as follows:

Chapter 1, “Overview”	Provides an overview of the IP camera and its features
Chapter 2, “Getting Started”	Provides instructions for installing and performing the initial setup of the IP camera, connecting to the IP camera so that you can configure it or view video from it, powering the IP camera on and off, resetting the IP camera, and adjusting its back focus
Chapter 3, “Configuring and Managing the IP Camera”	Explains how to configure, manage, and administer the IP camera through the web-based interface
Chapter 4, “Viewing Live Video”	Explains how to view live video from the IP camera
Chapter 5, “Troubleshooting”	Provides basic troubleshooting information

Obtaining Documentation, Obtaining Support, and Security Guidelines

For information about obtaining documentation, submitting a service request, and gathering additional information, see the monthly *What’s New in Cisco Product Documentation*, which also lists all new and revised Cisco technical documentation, at:

<http://www.cisco.com/en/US/docs/general/whatsnew/whatsnew.html>

Subscribe to the *What's New in Cisco Product Documentation* as a Really Simple Syndication (RSS) feed and set content to be delivered directly to your desktop using a reader application. The RSS feeds are a free service and Cisco currently supports RSS version 2.0.



CHAPTER 1

Overview

This chapter provides an overview of the Cisco Video Surveillance IP Cameras and its features. It includes these topics:

- [Features, page 1-1](#)
- [IP Camera Physical Details, page 1-2](#)

Features

The Cisco Video Surveillance IP Cameras offer a feature-rich digital camera solution for a video surveillance system. They provide high-quality, bandwidth-efficient video capture and transmission, with support for D1 resolution, motion-triggered viewing, and MPEG-4 encoding. The IP camera is available in models for use in wired and wireless networks. The wired model can be powered through an external power adapter or by integrated Power over Ethernet (PoE); the wireless model requires an external power adapter and does not support PoE.

In addition, the devices provide networking and security capabilities, including multicast support, hardware-based Advanced Encryption Standard (AES), hardware-based Data Encryption Standard/Triple Data Encryption Standard (DES/3DES) encryption, and for the wireless IP camera, 802.1X authentication.

The IP camera includes the following key features:

- **Built-in MPEG4 encoder**—An internal MPEG4 encoder can generate up to two video streams.
- **Built-in MJPEG encoder**—An internal MJPEG encoder can generate the primary or secondary video stream.
- **Day/night switch support**—An IR-cut filter provides increased sensitivity in low-light conditions.
- **Two-way audio communication**—Audio can be encoded with the video. With the internal or optional external microphone and optional external speaker, you can communicate with people at the IP camera location while you are in a remote location and viewing images from the IP camera.
- **Multi-protocol support**—Supports these protocols: DHCP, FTP, HTTP, HTTPS, NTP, RTP, RTSP, SMTP, SSL/TLS, and TCP/IP.
- **Web-based management**—You perform ongoing administration and management of the IP camera through web-based configuration menus.
- **Motion detection**—The IP camera can detect motion in up to three designated fields of view by analyzing changes in pixels and generate an alert if motion is detected.
- **Flexible scheduling**—You can configure the IP camera to respond to events that occur within a designated schedule.

- **Syslog support**—The IP camera can send log data to a Syslog server.
- **IP address filter**—You can designate IP addresses that can access the IP camera and IP addresses that cannot access the IP camera.
- **User-definable HTTP/ HTTPS port number**—Allows you to define the port that is used to connect to the camera through the Internet.
- **DHCP support**—The IP camera can automatically obtain its IP addresses in a network in which DHCP is enabled.
- **Network Time Protocol (NTP) support**—Allows the IP camera to calibrate its internal clock with a local or Internet time server.
- **Support for C and CS mount lenses**—Supports a variety of C and CS mount lenses.
- **RS-485/PTZ support**—Supports Pelco D protocol, which enables PTZ functions when used with a supported motorized zoom lens, external pan/tilt mount, and control device.
- **Power options**—The wired IP camera can be powered with 12 volts DC, which is provided through an optional external power adapter, or through PoE (802.3af), which is provided through a supported switch; the wireless IP camera does not support PoE and requires an external power adapter.
- **Camera access control**—You can control access to IP camera configuration windows and live video by configuring various user types and log in credentials.
- **Cisco Media API**—The IP camera supports the open, standards based, Cisco Media Application Programming Interface.
- **Wireless support**—The wireless IP camera is compatible with networks that conform to the IEEE802.11b or IEEE802.11g specifications.

IP Camera Physical Details

The IP camera includes a reset button, built-in microphone, status LEDs, several ports for connecting external devices, and two threaded mounting holes, one on the bottom and one on the top.

[Figure 1-1](#) and the table that follows describe the items on the front of the IP camera.

Figure 1-1 Front of IP Camera

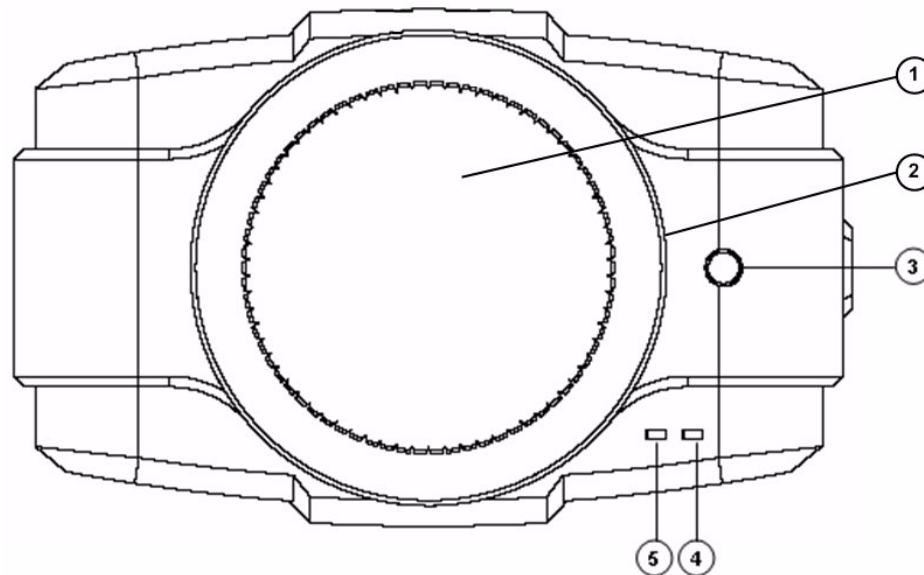

1	Lens opening	The IP camera supports a variety of C and CS mount lenses, which attach here. For best performance, Cisco recommends that you use a DC auto iris lens.
2	Focus ring	Allows you to adjust the back focus of the IP camera. You must loosen the focus ring hex screw on the bottom of the IP camera before you can rotate the focus ring. For instructions, see the “Adjusting Back Focus on the IP Camera” section on page 2-8.
3	Microphone	Captures audio. There also is a connection for an optional external microphone on the rear of the IP camera.
4	Activity LED (green)	Indicates activity as follows: <ul style="list-style-type: none"> • Off—No activity • Blinking—Activity detected Activity can occur when the IP camera communicates with the network or when a user views video from the IP camera. If you check the Enable LED Operations check box in the Basic Setup window, the Activity LED does not light. For more information see the “Basic Setup Window” section on page 3-5.
5	Ready LED (amber)	Indicates power state as follows: <ul style="list-style-type: none"> • On—Power is on • Off—No power • Blinking—IP camera is starting up. The start up process takes 15 to 20 seconds. If you check the Enable LED Operations check box in the Basic Setup window, the Ready LED does not light. For more information see the “Basic Setup Window” section on page 3-5.

Figure 1-2 and the table that follows describe the items on the rear of the IP camera.

Figure 1-2 Rear of IP Camera

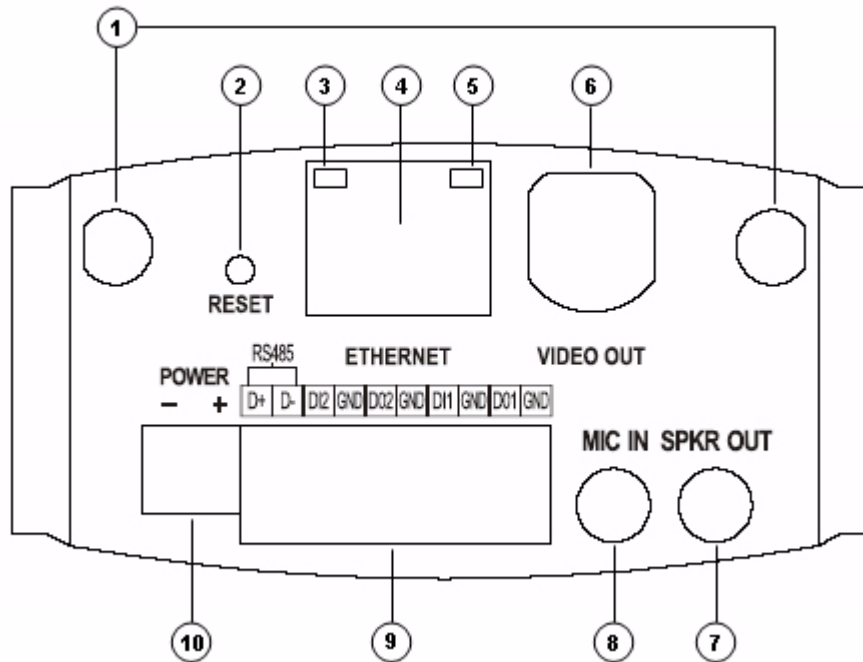

1	Antenna connectors (wireless model only)	Antennas screw into these connectors and are used for communication in wireless networks.
2	Reset button	Recessed button that reboots the IP camera or resets it to a default state. You can use a pin or paper clip to depress it. It can be used any time that the IP camera is on and can have various effects, as described in the “Resetting the IP Camera” section on page 2-9.
3	Network LED (amber)	Indicates information about the network connections as follows: <ul style="list-style-type: none"> • On—LAN or wireless connection is detected • Off—LAN or wireless connection is not detected • Blinking—Data is being transmitted or received via the LAN or wireless connection
4	LAN port	Accepts a standard LAN cable to connect the IP camera to a 10/100BASET router, or switch. On the wireless IP camera model, attaching a LAN cable disables the wireless interface. Only one interface, wired or wireless, can be active at a time. Connect or disconnect the LAN cable only when the IP camera is powered off. Doing so while the IP camera is powered on does not switch the interface between wired and wireless.
5	PoE LED (green)	Indicates information about PoE as follows: <ul style="list-style-type: none"> • On—PoE connection is detected • Off—PoE connection is not detected

6	Analog video output	BNC connector for video output (75 ohm).
7	Speaker output	Allows the connection of an optional external speaker through a standard 3.5 mm mini phone jack.
8	Microphone input	Allows the connection of an optional external microphone (with pre-amplifier) through a standard 3.5 mm mini phone jack. Microphones that are designed for use with PCs usually are compatible with this input jack. Connecting an external microphone disables the internal microphone on the IP camera.
9	GPIO ports	General purpose input/output (GPIO) terminal block that includes a 2-pin RS-485 port, 2 input ports (labeled DI1, DI2), 2 output ports (labeled DO1, DO2), and 4 ground ports (labeled GND).
10	Power input	Provides for the connection of an optional 12 V, 1 amp DC power adapter.  Caution Use only the Cisco specified power supply adapter.

Figure 1-3 and the table that follows describe the items on the side of the IP camera.

Figure 1-3 Side of IP Camera

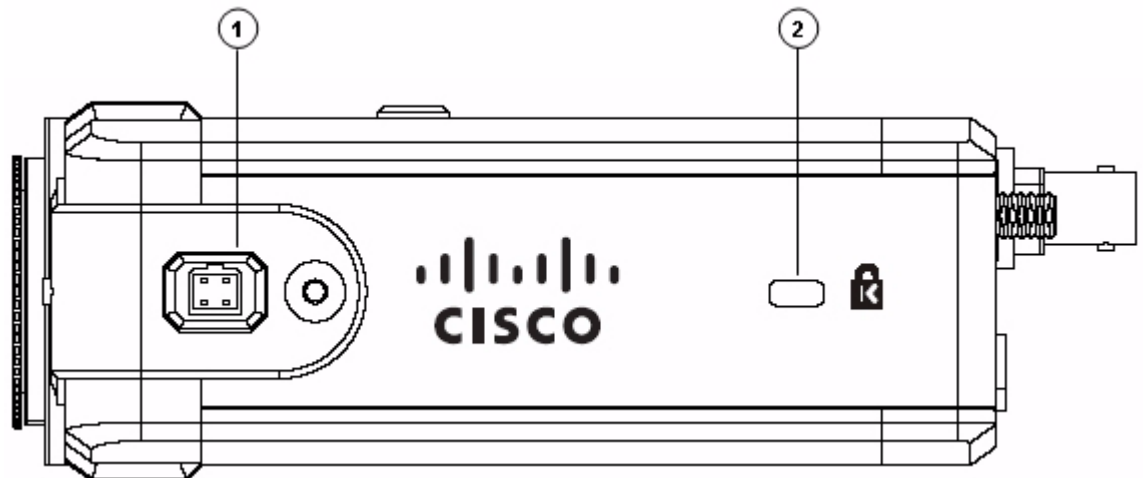

1	DC auto iris lens connector	Connection for cable from DC auto iris lens
2	Lockdown cable slot	Connection for Kensington-compatible lockdown equipment

DC Auto Iris Lens Connector Pinouts

Figure 1-4 and the table that follows describe the pinouts of the DC auto iris lens connector on the IP camera.

Figure 1-4 DC Auto Iris Lens Connector Pinouts

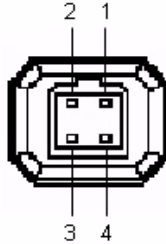

Pin	Function
1	Damp –
2	Damp +
3	Drive +
4	Drive –

Package Contents

The the Cisco Video Surveillance IP Camera package includes these items:

- Camera
- Lens opening dust cap
- Mounting hole protector
- Antennas (wireless model only)
- Terminal block for power connection
- C mount lens adaptor
- 0.9 mm Allen wrench for unlocking and locking the focus ring
- Regulatory Compliance and Safety Information
- Quick Start Guide



CHAPTER 2

Getting Started

This chapter provides instructions for installing and performing the initial setup of the Cisco Video Surveillance IP Camera. It also describes how to access the IP camera through a web browser so that you can configure it or view video from it, and how to perform other important tasks.

This chapter includes these topics:

- [Installing the Cisco Video Surveillance IP Camera, page 2-1](#)
- [Performing the Initial Setup of the IP Camera, page 2-5](#)
- [Accessing the IP Camera Windows, page 2-6](#)
- [Adjusting Back Focus on the IP Camera, page 2-8](#)
- [Powering the IP Camera On or Off, page 2-8](#)
- [Resetting the IP Camera, page 2-9](#)
- [Converting a Wireless Camera between Wired and Wireless Modes, page 2-9](#)
- [Cleaning the IP Camera, page 2-10](#)

Installing the Cisco Video Surveillance IP Camera

This section describes how to install the Cisco Video Surveillance IP camera. Before installing, review these guidelines:

- The wired IP camera requires a network cable and a connection to a standard 10/100BaseT router or switch. To power the IP camera with Power over Ethernet (PoE), a switch must be 802.3af compliant.
- The wireless IP camera can be installed in a network that conforms to the IEEE802.11b or IEEE802.11g specifications.
- For a wireless IP camera, or wired IP camera using a network connection that does not provide PoE, you must use the Cisco 12 V power adapter (Cisco part number CIVS-PWRPAC-12V). You can order the power adapter from Cisco.
- For a wireless IP camera, you must initially connect it using a network cable so that you can configure the settings that are required to access it through a wireless network. The following procedure provides instructions for doing so.
- If you are using an external speaker, microphone, input device, output device, or control device, you must configure additional settings after installing and performing the initial set up of the IP camera before the external device can fully operate. For detailed information about these settings, see [Chapter 3, “Configuring and Managing the IP Camera.”](#)

- If you do not connect an external device (speaker, microphone, analog video display, input device, output device, or control device) when you perform the following installation procedure, you can install any of these devices later.

**Warning**

Installation of the equipment must comply with local and national electrical codes. Statement 1074

**Warning**

The power supply must be placed indoors. Statement 331

**Note**

If you use the IP camera outdoors, place the camera and the power supply in a suitable NEMA enclosure.

**Warning**

This product requires short-circuit (overcurrent) protection, to be provided as part of the building installation. Install only in accordance with national and local wiring regulations. Statement 1045

**Warning**

This product must be connected to a power-over-ethernet (PoE) IEEE 802.3af compliant power source or an IEC60950 compliant limited power source. Statement 353

**Warning**

The plug-socket combination must be accessible at all times, because it serves as the main disconnecting device. Statement 1019

**Caution**

Inline power circuits provide current through the communication cable. Use the Cisco provided cable or a minimum 24AWG communication cable

To install the IP camera, follow the steps in [Table 2-1](#). For illustrations of the connectors and ports that the steps refer to, see the [“IP Camera Physical Details”](#) section on page 1-2.

Table 2-1 **Installing the IP Camera**

	Action	Explanation
Step 1	Attach a lens to the lens opening on the IP camera.	<ul style="list-style-type: none"> • If you are using a CS mount lens, screw the lens into the lens opening. The IP camera accepts CS-mount lenses with a lens protrusion of up to 5 mm. • If you are using a C mount lens, screw the C mount lens adapter that is supplied with the IP camera into the lens opening, then screw the lens into the adapter. <p>Ensure that the lens is clean because any dirt may degrade the quality of video images.</p> <p>Note Save the lens opening dust cap and replace the dust cap if you remove the lens.</p>

Table 2-1 Installing the IP Camera (continued)

	Action	Explanation
Step 2	If you are using a DC auto iris lens, connect its cable to the DC auto iris lens connector on the IP camera.	For best performance, Cisco recommends that you use a DC auto iris lens.
Step 3	<i>Wireless model only:</i> Attached the supplied antennas to the antenna connectors on the rear of the IP camera.	The two antennas screw into the antenna connectors.
Step 4	<i>Optional.</i> Connect a speaker to the speaker output jack on the rear of the IP camera.	A speaker plays audio that is captured by a microphone that is attached to the PC on which you view video from the camera.
Step 5	<i>Optional.</i> Connect a microphone to the microphone input jack on the rear of the IP camera.	Connecting an external microphone disables the IP camera internal microphone. Place the external microphone in a location that allows it to capture the audio that you want. The microphone must include a pre-amplifier.
Step 6	<i>Optional.</i> Connect an NTSC or PAL compliant analog video display device to the video output connector on the rear of the IP camera.	This device displays video from the IP camera. The display does not include the time stamp or text that are configured for the camera.
Step 7	<i>Optional.</i> Use the GPIO ports on the rear of the IP camera to connect external devices that trigger or respond to alarms. Devices that trigger alarms connect through alarm input ports, and devices that respond to alarms connect through alarm output ports.	You can connect up to two input devices and two output devices to these ports: DI1—Alarm input 1 DI2—Alarm input 2 DO1—Alarm output 1 DO2—Alarm output 2 GND—Ground (for use if needed)
Step 8	<i>Optional.</i> Use the RS485 GPIO ports on the rear of the IP camera to connect a control device (motorized housing) that supports the Pelco D protocol.	These ports are labeled D+ (data plus) and D- (data minus) and accept a cable with two conductors. The cable fits into the ports in one way. Make sure to insert it properly.
Step 9	<i>Wired model only:</i> Connect a category 5 or higher network cable to the LAN port on the back of the camera and to a 10/100BaseT router or switch. <i>Wireless model only:</i> Temporarily connect a category 5 or higher network cable to the LAN port on the back of the camera and to a 10/100BaseT router, switch, or directly to an Ethernet port on a PC, or configure your access point to match the default wireless settings of the IP camera.	If you are installing the wired IP camera and your network provides PoE, the IP camera powers on. Skip to Step 11 . If you are installing a wireless IP camera, and you want to configure wireless settings on the IP camera now, you must temporarily use a category 5 or higher network cable so that you can access the IP camera configuration windows. If you do not have convenient access to the IP camera or do not want to configure its wireless settings, configure your access point to match the default wireless settings of the IP camera: DHCP enabled, SSID = cisco, and all security disabled.

Table 2-1 Installing the IP Camera (continued)

	Action	Explanation
Step 10	If you are using a wireless IP camera, or a wired IP camera on a network connection that does not provide PoE, connect the optional 12 V power adapter.	<p>First, connect the bare wires at the end of the power adapter to the terminal block that is provided with the IP camera:</p> <ul style="list-style-type: none"> • With the screws on the terminal block facing down, put the positive wire into the slot at the right rear of the terminal block and put the negative wire into the slot on the left. (On the Cisco power adapter, the positive wire has a white stripe and the negative wire has no stripe.) • Use a small flat-head screwdriver to tighten the screws on the bottom of the terminal block so that the power adapter wires are attached securely. <p>Note The power adapter may include an attached terminal block that does not fit the IP camera. If so, remove that terminal block and replace it with the one that is provided with the IP camera.</p> <p>Next, plug the terminal block into the power input port on back of the IP camera. The terminal block fits into the input port in one way. Make sure that the tabs on the terminal block face the bottom of the IP camera.</p> <p>Finally, plug the power adapter into an electrical outlet. The IP camera powers up.</p>
Step 11	Check the LEDs on the IP camera.	<ul style="list-style-type: none"> • The Ready LED blinks while the IP camera starts up. After 15 to 20 seconds, startup completes and the Ready LED should remain on. • The Network LED should be on.
Step 12	<i>Wireless model only:</i> If you connected the IP camera to a router, switch, or Ethernet port on a PC as described in Step 9 , configure wireless settings, then power down the IP camera, disconnect the network cable, and power up the IP camera.	<p>Connect to the IP camera as described in the Performing the Initial Setup of the IP Camera, page 2-5, then configure wireless settings as described in Chapter 3, “Configuring and Managing the IP Camera.” At a minimum, you must configure the service set identifier (SSID) in the Basic Setup window.</p> <p>After configuring, disconnect the power cable and the network cable, then reconnect the power cable. After the IP camera powers up, make sure that the Ready LED and Network LED are on.</p>
Step 13	Mount the IP camera in the desired location.	<p>Connect the mounting device to the threaded mounting hole on the bottom or top of the IP camera, depending on your installation requirement.</p> <p>You may first need to remove the rubber protector from the mounting hole. Place this protector in the unused mounting hole.</p>
Step 14	<i>Optional.</i> Use the lockdown cable slot to secure the IP camera.	You can secure the IP camera to a fixed object by using Kensington-compatible lockdown equipment

After you install the IP camera, follow the instructions in the “[Performing the Initial Setup of the IP Camera](#)” section on page 2-5 to access and configure the camera.

Performing the Initial Setup of the IP Camera

After you install IP camera, or after you perform a factory reset procedure, you must access the IP camera and make initial configuration settings. These settings include administrator and root passwords, and whether the IP camera can be accessed through an HTTP connection in addition to the default HTTPS (HTTP secure) connection.

To make these configuration settings, you connect to the IP camera from any PC that is on the same network as the IP camera. The PC must meet these requirements:

- Operating system—Microsoft Windows 2000, XP, or Vista
- Browser—Internet Explorer 6.x with Service Pack 2, or later

In addition, you must know the IP address of the IP camera. By default, when the IP camera powers on, it attempts to obtain an IP address from a DHCP server in your network. If the camera cannot obtain an IP address through DHCP within 90 seconds, it uses a default IP address of 192.168.0.100.

To connect to the IP camera for the first time and make initial configuration settings, perform the following steps. You can change these configuration settings in the future as described in the “[Initialization Window](#)” section on page 3-27.

Procedure

-
- Step 1** Start Internet Explorer, enter **HTTPS://ip_address** in the address field, and press **Enter**.
Replace *ip_address* with the IP address that the IP camera obtained through DHCP or, if the camera is unable to obtain this IP address, enter **192.168.0.100**.
The Account window appears.
- Step 2** In the Set Password and Verify Password fields in the Admin column, enter a password for the IP camera administrator.
You must enter the same password in both fields. The password is case sensitive and must contain at least eight characters, which can be letters, numbers, and special characters, but no spaces. Special characters are: ! " # \$ % & ' () * + , - . : ; < = > ? @ [\] ^ _ ` { | } ~.
- Step 3** In the Set Password and Verify Password fields in the Root column, enter a password that is used when accessing the IP camera through a Secure Shell (SSH) connection.
You must enter the same password in both fields. The password is case sensitive and must contain at least eight characters, which can be letters, numbers, and special characters, but no spaces. Special characters are: ! " # \$ % & ' () * + , - . : ; < = > ? @ [\] ^ _ ` { | } ~.
You use the root password if you need to troubleshoot the IP camera through a SSH connection with the assistance of the Cisco Technical Assistance Center.
- Step 4** In the HTTP area, click the **HTTP** radio button if you want to allow both HTTP and HTTPS connections to the IP camera.
The default setting is HTTPS, which allows only HTTPS (secure) connections to the IP camera.
- Step 5** Click **Apply**.
The IP camera reboots.

Step 6 After the IP camera reboots, start Internet Explorer and, in the Address field, enter the following:

protocol://ip_address

where:

- *protocol* is **HTTPS** or **HTTP**. (You can use HTTP only if you enabled it in [Step 4](#).)
- *ip_address* is the IP address that you used in [Step 1](#).

Step 7 If you are prompted to install ActiveX controls, which are required to view video from the IP camera, follow the on-screen prompts to do so.

The Main window appears and video from the IP camera starts playing automatically.

You can take these actions in the Main window:

- Click the **Setup** link to access configuration menus for the camera. For detailed information about these menus, see [Chapter 3, “Configuring and Managing the IP Camera.”](#)
 - Click the **Home** link to view and control live video from the camera. For detailed information about these actions, see [Chapter 4, “Viewing Live Video.”](#)
 - Click the **Logout** button to exit the window.
-

Accessing the IP Camera Windows

After you perform the initial configuration as described in the [“Performing the Initial Setup of the IP Camera” section on page 2-5](#), follow the steps in this section each time that you want to access the IP camera windows to make configuration settings or view live video.

You access these windows by connecting to the IP camera from any PC that is on the same network as the IP camera and that meets these requirements:

- Operating system—Microsoft Windows 2000, Windows XP, or Vista
- Browser—Internet Explorer 6.x with Service Pack 2, or later

You need this information to access the IP camera windows:

- IP address of the IP camera. By default, the IP camera attempts to obtain an IP address from a DHCP server in your network. If the IP camera cannot obtain an IP address through DHCP within 90 seconds of powering up or resetting, it uses the default IP address of 192.168.0.100.
- Port number, if other than the default value. Default port numbers for the IP camera are 443 for HTTPS and 80 for HTTP. The IP camera administrator can enable an alternative HTTPS port and an alternative HTTP port as described in the [“Advanced Setup Window” section on page 3-11](#).
- Your user name and password for the IP camera. The IP camera administrator configures user names and passwords as described in the [“Users Window” section on page 3-16](#).

To access the IP camera windows, follow these steps:

Procedure

Step 1 Start Internet Explorer and enter the following in the address field:

protocol://ip_address:port_number

where:

- *protocol* is **HTTPS** for a secure connection or **HTTP** for a non-secure connection. You can use HTTP only if you configure the camera to accept non-secure HTTP connections as described in the “Performing the Initial Setup of the IP Camera” section on page 2-5.
- *ip_address* is the IP address of the IP camera. The default IP address is 192.168.0.100.
- *port_number* is the port number that is used for HTTPS or HTTP connections to the IP camera. You do not need to enter a port number if you are connecting through the default HTTPS port 443 or the default HTTP port 80.

For example,

- Enter the following for a secure connection if the IP address is 192.168.0.100 and the HTTPS port number is 443:

https://192.168.0.100

- Enter the following for a secure connection if the IP address is 203.70.212.52 and the HTTPS port number is 1024:

https://203.70.212.52:1024

- Enter the following for a non-secure connection if the IP address is 203.70.212.52 and the HTTP port number is 80:

http://203.70.212.52

- Enter the following for a non-secure connection if the IP address is 203.70.212.52 and the HTTP port number is 1024:

http://203.70.212.52:1024

Step 2 Enter your IP camera user name and password when prompted, then click **OK**.

To log in as the IP camera administrator, enter the user name **admin** (all lower case) and the password that is configured for the administrator. To log in as a user, enter the user name and password that are configured for the user.

The Main window appears and video from the IP camera starts playing automatically. You can take these actions in the Main window:

- Click the **Setup** link to access configuration menus for the camera. For detailed information about these menus, see [Chapter 3, “Configuring and Managing the IP Camera.”](#)
- Click the **Home** link to view and control live video from the camera. For detailed information about these actions, see [Chapter 4, “Viewing Live Video.”](#)
- Click the **Logout** button to exit the window.

Adjusting Back Focus on the IP Camera

To obtain the sharpest image from the camera, you may need to adjust its back focus. This adjustment is useful if the focus control on a lens does not allow you to obtain a sharp enough image.

To adjust the back focus, perform the following steps while viewing video from the camera. For information about viewing video, see [Chapter 4, “Viewing Live Video.”](#)

Procedure

-
- Step 1** With a lens attached to the IP camera, use the 0.9 mm Allen wrench that is supplied with the IP camera to loosen the focus ring hex screw.
- This screw is on the bottom of the camera just behind the focus ring.
- Step 2** Adjust the back focus by aiming the IP camera at an object that is at least 15 feet (4.5 meters) away and rotating the focus ring to obtain a clear image as follows:
- For a variable-focus lens, obtain a sharp picture in both wide-angle and telephoto positions.
 - For a zoom lens, ensure that the object of interest remains in focus throughout the entire zoom range of the lens.
- Step 3** Use the Allen wrench to tighten the focus ring hex screw.
-

1	Back focus hex screw
2	Panning lock screw
3	Analog video output port
4	Zoom lock screw
5	Focus lock screw
6	Tilt lock screws

Powering the IP Camera On or Off

The IP camera does not include an on/off switch. You power it on or off by connecting it to or disconnecting it from a power source. When you power off the IP camera, it retains configuration information.

To power on the IP camera, take either of these actions:

- Use an STP category 5 or higher network cable to connect the IP camera to a network switch that provides 802.3af compliant PoE
- Use the appropriate power adapter to connect the IP camera to a wall outlet

To power off the IP camera, take either of these actions:

- If the IP camera is receiving PoE, disconnect the network cable
- If the IP camera is receiving power through the power adapter, unplug the adapter from the wall or disconnect it from the camera

Resetting the IP Camera

You reset the IP camera by pressing the Reset button on the rear of the device (see [Figure 1-2 on page 1-4](#)).

There are various reset types, as described in [Table 2-2](#).

You also can perform some reset operations from the Maintenance window as described in the [“Maintenance Window” section on page 3-17](#).

Table 2-2 *Resetting the IP Camera*

Reset Type	Procedure	Remarks
Reboot.	Press and immediately release the Reset button.	This action is equivalent to powering the IP camera down and then powering it up. Settings that are configured for the IP camera are retained.
IP address reset.	Press and hold the Reset button for at least 1 second but no more than 9 seconds.	If DHCP is enabled in your network, the IP camera obtains an IP address from the DHCP server. Otherwise, after 90 seconds, the IP camera IP address resets to the default address of 192.168.0.100. All other configuration settings are retained.
Factory reset.	Press and hold the button for at least 10 seconds.	Sets all IP camera options to their default values. After you perform this procedure, follow the steps in the “Performing the Initial Setup of the IP Camera” section on page 2-5 .

Converting a Wireless Camera between Wired and Wireless Modes

The wireless IP camera can operate in either of these modes:

- **Wired mode**—A category 5 or higher network cable is connected to the LAN port on the back of the camera and to a 10/100BaseT router or switch. In this mode, the IP camera communicates with the network through the cable.
- **Wireless mode**—The IP camera communicates with the network through a wireless connection.

To convert a wireless IP camera from wired mode to wireless mode, disconnect the network cable and the power adapter from the IP camera. Then, reconnect the power adapter.

To convert a wireless IP camera from wireless mode to wired mode, disconnect the power adapter from the IP camera. Next, connect a network cable to the LAN port on the back of the camera and to a 10/100BaseT router or switch. Then, reconnect the power adapter.

Cleaning the IP Camera

To clean an IP camera, follow these guidelines:

- To clean the IP camera housing, use a clean, dry, soft cloth to gently wipe the surface of the housing
- To clean the lens, use only tissue paper or solution that is designed for high quality optical lenses.



CHAPTER 3

Configuring and Managing the IP Camera

The Cisco Video Surveillance IP Camera provides configuration windows that you use to configure and manage the IP camera. This chapter explains how to access the configuration windows, describes each window, and provides detailed information about the options that are available in each window.

When configuring the IP camera, be aware of these guidelines:

- You must install and set up the Cisco Video Surveillance IP camera as described in [Chapter 2, “Getting Started,”](#) before you can access the configuration menus.
- You must be an IP camera administrator or an IP camera user with administrator privileges to access the configuration windows.
- For security, the configuration windows time out after 2 minutes of no activity. If a time out occurs, a pop-up window prompts you to log back in by entering your user name and password when you next press a key or click an item. When you log back in, the configuration window that you were displaying remains on your screen, but all settings revert to their last saved values.

This chapter includes these topics:

- [Configuration Overview, page 3-1](#)
- [Navigating the Configuration Windows, page 3-4](#)
- [Setup Windows, page 3-5](#)
- [Administration Windows, page 3-15](#)
- [Audio/Video Windows, page 3-19](#)
- [Security Windows, page 3-26](#)
- [Applications Windows, page 3-28](#)
- [Status Windows, page 3-38](#)

Configuration Overview

There are many settings and options that you can configure for the IP camera. The items that you configure depend on several factors, including your camera model, operational requirements, and connected external devices.

[Table 3-1](#) provides general information to help you determine what items you need to configure for your situation. Use this table as a guide as you configure your IP camera and as a reference if you need to change configurations in the future.

Table 3-1 Guidelines for Configuring the IP Camera

Configuration Item	Explanation	Guidelines for Use	Reference
IP camera name and description	Identifies the IP camera.	Recommended.	See the “Basic Setup Window” section on page 3-5.
LED operation	Determines whether the LEDs on the front of the IP camera light or remain off.	Optional.	See the “Basic Setup Window” section on page 3-5.
Time information	Sets the date and time for the IP camera. Also determines how the IP camera obtains the date and time, its time zone, and whether it adjusts for daylight saving time.	Recommended.	See the “Basic Setup Window” section on page 3-5.
Network options	Determine how the IP camera obtains its IP address, and provides options for configuring subnet mask, gateway, and DNS servers.	IP address is required if DHCP is not enabled in your network, other items depend on your network configuration.	See the “Basic Setup Window” section on page 3-5.
Wireless options (wireless model only)	Set various communication and security options for the wireless IP camera.	SSID is required, security options are recommended.	See the “Wireless Setup Window” section on page 3-7.
Advanced network and protocol options	Determine whether the IP camera uses Cisco Discovery Protocol (CDP) and it uses Bonjour, configure alternate ports for HTTP or HTTPS connections, configure RTP or RTSP options, and configure QoS.	Optional, depending on your network and requirements.	See the “Advanced Setup Window” section on page 3-11.
IP address filters	Controls access to the IP camera by IP address.	Optional.	See the “IP Filter Window” section on page 3-14.
EAPOL	Configures Extensible Authentication Protocol Over LANs (EAPOL) for authenticating and controlling user traffic to a protected network	Optional.	See the “EAPOL Window” section on page 3-14.
IP camera users	Sets the password for the IP camera administrator, and sets log in credentials and privileges for up to 20 users.	Optional.	See the “Users Window” section on page 3-16.

Table 3-1 Guidelines for Configuring the IP Camera (continued)

Configuration Item	Explanation	Guidelines for Use	Reference
Video options	Sets video resolution and quality, whether you use one or two video streams, streaming mode, picture appearance, whether video includes a time stamp or text overlay, and how the IP camera handles day and night modes.	Optional, depending on your requirements.	See the “Video Window” section on page 3-19.
Audio options	Includes options for audio streams that are received or sent by the IP camera.	Required if you use the internal or an external microphone, or an external speaker.	See the “Audio Window” section on page 3-24.
Security options	Let you stop IP camera processes, configure administrator and root password requirements, and allow access to the IP camera through HTTP or Secure Shell (SSH) connections.	Optional.	See the “Security Windows” section on page 3-26.
Mail and FTP options	Determines whether and how the IP camera notifies you when an event occurs.	Required if you want the IP camera send e-mail notification of an event.	See the “Mail & FTP Window” section on page 3-28.
Motion detection	Determines whether and how the IP camera detects activity in its field of view, which in turn can generate an alert.	Optional.	See the “Motion Detection Window” section on page 3-30.
Event handling	Determines actions that the IP camera takes when it detects an event. An event can be motion that is detected in the field of view or a state change that is detected on and input port.	Optional.	See the “Event Window” section on page 3-31.
SNMP options	Configure SNMP settings.	Optional.	See the “SNMP Window” section on page 3-34.
I/O ports options	Set the default states for the IP camera input and output ports, how the ports respond to events, and how the ports respond to manual control.	Required if you connect devices through the IP camera input or output ports.	See the “Alarm I/O Ports Window” section on page 3-35.
Pan, tilt, zoom options	Enable PTZ functions for the IP camera.	Required to control PTZ functions.	See the “PTZ (RS-485) Window” section on page 3-36
Patrol sequence options	Define a preset position and patrol sequence for the IP camera.	Optional.	See the “PTZ (RS-485) Window” section on page 3-36 and the “Preset Positions Window” section on page 3-37.

Table 3-1 Guidelines for Configuring the IP Camera (continued)

Configuration Item	Explanation	Guidelines for Use	Reference
Log file options	Control which log information the IP camera captures and whether it sends the log file to a Syslog server.	Recommended.	See the “Syslog & Log Window” section on page 3-41.
Video log options	Let you manage the IP camera video log.	Recommended.	See the “Video Log Window” section on page 3-46.

Navigating the Configuration Windows

After you access the configuration windows as described in the “[Accessing the IP Camera Windows](#)” section on page 2-6, a window appears that includes the following components:

- Navigation tree—Appears at the left of the window and provides links to each configuration window
- Basic Setup window—Appears at the right of the window

The navigation tree always appears. The right area varies depending on the configuration window that you choose from the navigation tree.

You can perform the following activities from when any configuration window is displayed:

- Click the **Home** link at the top of the Navigation Tree to display live video from the IP camera. For related information, see [Chapter 4, “Viewing Live Video.”](#)
- Click the **Logout** button to exit the Main window and close your web browser.
- Use the Navigation Tree to access each configuration window. To do so, click the link or the plus sign (+) next to the link for the group of configuration windows that you want. The name of each associated window appears as a link. Then click the link for the desired window.

To collapse a set of links, click the minus sign (-) next to the top-level link.

The configuration windows are organized as follows:

- Setup
 - Basic Setup
 - Wireless Setup (applies to wireless model only)
 - Advanced Setup
 - IP Filter
 - EAPOL
- Administration
 - Users
 - Maintenance
 - Firmware
- Audio/Video
 - Video
 - Audio
- Security

- Product Process
- Initialization
- Complexity
- Applications
 - Mail & FTP
 - Motion Detection
 - Event
 - SNMP
 - Alarm I/O Ports
 - PTZ (RS-485)
- Status
 - System
 - Audio Video
 - Network
 - Syslog & Log
 - Video Log

Setup Windows

The Setup windows let you configure a variety of basic and advanced settings for the IP camera, and to designate IP addresses that are allowed or denied access to the IP camera.

The following sections describe the Setup windows in detail:

- [Basic Setup Window, page 3-5](#)
- [Wireless Setup Window, page 3-7](#)
- [Advanced Setup Window, page 3-11](#)
- [IP Filter Window, page 3-14](#)
- [EAPOL Window, page 3-14](#)

Basic Setup Window

The Basic Setup window provides options for configuring device and network settings for the IP camera.

To display the Basic Setup window, access the configuration windows as described in the “[Accessing the IP Camera Windows](#)” section on page 2-6, click **Setup**, then click **Basic Setup**.

If you change any options except the Current Date/Time in the Basic Setup window, you must click **Save** to save the changes. To discard the changes, click **Cancel** before clicking **Save**. These buttons appear at the bottom of the window. You may need to scroll down to see them.

[Table 3-2](#) describes the options in the Basic Setup window.

Table 3-2 Basic Setup Window Options

Option	Description
Device Settings	
Device ID	<i>Display only.</i> Unique identifier of the IP camera. The device ID is configured for the IP camera at the factory.
Camera Name	Enter a name for the IP camera. This name appears in the video log if an event occurs. (For related information, see the “Video Log Window” section on page 3-46.) The camera name can include any combination of up to 15 letters and numbers. Cisco recommends that you give each IP camera a unique name so that you can identify it easily.
Description	Enter a description of the IP camera. For example, enter the IP camera location, such as “North Entrance.” The description can include any combination of up to 32 letters, numbers, and spaces.
Enable LED Operations	Check this check box if you want the Ready LED or Activity LED on the front of the IP camera to light when the IP camera receives power or performs an activity. If you do not check this check box, these LEDs do not light.
Current Date/Time	<i>Display only.</i> Current date and time of the internal clock of the IP camera. To change the date or time, click Change to display the Set Date/Time window, then take the appropriate action: <ul style="list-style-type: none"> To synchronize the IP camera date and time with the date and time of the PC that you are using, click Sync with PC. To set the IP camera date and time to any values, enter the values in the New Date and New Time fields, then click Set New Time. To exit the Date/Time window, click Close.
Time Zone	From the drop-down list, choose the time zone in which the IP camera is located. The time that appears when you view video from this IP camera reflects this time zone.
Adjust for Daylight Saving Time	Check this check box if you want the time of the IP camera to adjust automatically for daylight saving time.
Check here if you want to update the time automatically from the NTP server from the Internet	Check this check box if you want the IP camera to obtain its time from a network time protocol (NTP) server. If you check this check box, the camera contacts the designated NTP server every 64 seconds and synchronizes its internal clock with the time of that server.
NTP Server Address	If you configured the IP camera to obtain its time from an NTP server, enter the IP address of the NTP server.
NTP Port	If you configured the IP camera to obtain its time from an NTP server, enter the NTP server port number. The default value is 123.

Table 3-2 Basic Setup Window Options (continued)

Option	Description
Network Settings	
Configuration Type	Choose the option that indicates how the IP camera obtains its IP address: <ul style="list-style-type: none"> • Obtain Address Automatically (DHCP)—If your network includes a DHCP server for dynamic allocation of IP addresses, choose this option if you want DHCP to assign an IP address and subnet mask to the IP camera. Depending on your router, the default gateway, primary DNS server, and secondary DNS server may also be assigned. The DHCP server must be configured to allocate static IP addresses based on MAC addresses so that the IP camera always receives the same address. • Fixed IP Address—Choose this option if you want to manually enter an IP address, subnet mask, and default gateway for the camera.
IP Address	If you configured the IP camera for a fixed IP address, enter that IP address.
Subnet Mask	If you configured the IP camera for a fixed IP address, enter the subnet mask for the IP camera. Use the same value that is configured for the PCs on your network.
Gateway	If you configured the IP camera for a fixed IP address, enter the gateway for the IP camera. Use the same value that is configured for the PCs on your network.
Primary DNS	<i>Optional.</i> Enter the IP address of the primary the DNS server that is used in your network. Use the same value that is used for the PCs on your LAN. Typically, your ISP provides this address. This address is required if you use a DNS name instead of an IP address in the SMTP Mail Server field in the Mail & FTP window.
Secondary DNS	<i>Optional.</i> Enter the IP address of a secondary (backup) DNS server to use if the primary DNS server is unavailable. Enter the DNS server to be used if the primary DNS server is unavailable.

Wireless Setup Window

The Wireless Setup window provides options for configuring wireless security and region settings for the Wireless IP camera. This window is not available for the wired IP camera model.

To display the Wireless Setup window, access the configuration windows as described in the “[Accessing the IP Camera Windows](#)” section on page 2-6, click **Setup**, then click **Wireless Setup**.

If you change any options in the Wireless Setup window, you must click **Save** to save the changes. To discard the changes, click **Cancel** before clicking **Save**. These buttons appear at the bottom of the window. You may need to scroll down to see them.

[Table 3-2](#) describes the options in the Wireless Setup window.

Table 3-3 *Wireless Setup Window Options*

Option	Description
Wireless Settings	
SSID	<p>Enter the service set identifier (SSID) that is used by wireless devices on your network.</p> <p>The SSID can be any combination of up to 32 of alpha, numeric, and special characters. It is case sensitive.</p> <p>The default value is cisco (all lower case). For increased security, change this value to an SSID of your choice.</p>
Network Type	<i>Display only.</i> Displays information about the network infrastructure.
Security	<i>Display only.</i> If security is enabled for the IP camera, displays the security mode that is configured.
Region	<i>Display only.</i> Displays the region that is configured for the IP camera. The region determines which channels the wireless IP camera uses to communicate with an access point.
Edit Security Settings / Hide Security Settings toggle button	Click the Edit Security Settings button to display the Security Mode drop-down list. Click the Hide Security Settings to hide this drop-down list.
Security Mode	<p>If you clicked the Edit Security Settings button, choose the desired security mode for the IP camera:</p> <ul style="list-style-type: none"> • Disabled—No security is used. Data is not encrypted before transmission and anyone using the correct SSID can connect to the camera through your network. • WEP—The 802.11b standard and a basic encryption method. The encryption system is not as strong as other methods, but it is supported by all clients. • WPA/WPA2 Personal—This method, sometimes called <i>mixed mode</i>, allows clients to use either WPA-PSK (with TKIP) or WPA2-PSK (with AES) encryption methods. • WPA/WPA2 Enterprise—Data transmissions are encrypted using either the WPA or WPA2 standard. Requires that RADIUS be configured on your network to provide the client authentication.
WEP Security Mode Options	
Note These options appear if you choose WEP from the Security Mode drop-down list.	
TX Key	<p>If you enter a WEP key in one of the Key fields, choose the number of the field that contains the key to use.</p> <p>For added security, you can periodically change the TX Key option to designate a different WEP key.</p>
WEP Encryption	<p>Choose the WEP encryption strength:</p> <ul style="list-style-type: none"> • 64 Bit Keys (10 Hex characters)—Designates 64 bit encryption keys with 10 hexadecimal characters • 128 Bit Keys (26 Hex characters)—Designates 128 bit encryption keys with 26 hexadecimal characters

Table 3-3 *Wireless Setup Window Options (continued)*

Option	Description
Passphrase	If you want to generate keys for encryption, enter a word or group of printable characters and click the Generate button. If WEP encryption is set to 64 bit, each of the 4 key fields is populated with a key value. If WEP encryption strength is set to 128 bit, only the first WEP key field is populated with a key value.
Key 1 Key 2 Key 3 Key 4	Enter the WEP key value, in hexadecimal format, that the IP camera uses to connect to the network. Each wireless IP camera that accesses the same access point in a network must have the same WEP key values.
Authentication	Choose the appropriate value, Open System or Shared Key . Refer to the documentation for your wireless card to determine the method to use. Note In Infrastructure mode, either setting typically works, because most access points can use both methods.

WPA/WPA2 Personal Mode Options

Note These options appear if you choose **WPA/WPA2** from the Security Mode drop-down list.

Encryption	<i>Display only.</i> Encryption algorithm that is used by the IP camera: TKIP and AES.
Shared Key	Enter a value for the shared key. The value must contain from 8 to 63 alphanumeric characters. Data is encrypted using an algorithm that is derived from this network key. Each wireless IP camera that accesses the same access point in a network must have the same shared key values.

Table 3-3 Wireless Setup Window Options (continued)

Option	Description
WPA/WPA2 Enterprise Mode Options	
Note These options appear if you choose WPA/WPA2 Enterprise from the Security Mode drop-down list.	
Protocol Type	<p>Choose a protocol type and enter desired information in the fields that appear:</p> <ul style="list-style-type: none"> • EAP-TLS—If you choose this option, the following fields appear. Enter information as appropriate. <ul style="list-style-type: none"> – User ID—User identifier that is used to log in to the RADIUS server. – Root CA—Path and folder on this PC or location of a Windows network shared folder where the root certificate file is stored. You can click Browse to find this location. After you enter this information, click Upload to upload the certificate from the local PC to the IP camera. – User CA—Path and folder on this PC or location of a Windows network shared folder. You can click Browse to find this location. After you enter this information, click Upload to upload the certificate from the local PC to the IP camera. – Password—IP camera client log in password for the RADIUS server. • EAP-FAST—If you choose this option, the following fields appear. Enter information as appropriate. <ul style="list-style-type: none"> – Allow Automatic PAC Provisioning—Check this check box if you want to allow authentication servers to establish a secure connection with the IP camera so that they can provide the IP camera with new Protected Access Credentials (PACs). – User ID—User identifier that is used to log in to the RADIUS server. – Password—IP camera client log in password for the RADIUS server. – Anonymous ID—<i>Optional</i>. Anonymous identifier to be used instead of a user name for logging in to the RADIUS server. – PAC File—Path and folder where the PAC file is stored. You can click Browse to find this location. <p>After you enter this information, click Upload to upload the certificate to the IP camera.</p>
Edit Region Settings / Hide Region Settings toggle button	Click the Edit Region Settings button to display the Region Option drop-down list. Click the Hide Region Settings to hide this drop-down list.

Table 3-3 *Wireless Setup Window Options (continued)*

Option	Description
Region Option	<p>Choose the region in which the IP camera operates. The region determines which channels the wireless IP camera uses to communicate with an access point.</p> <p>Options are:</p> <ul style="list-style-type: none"> • Americas—Causes the IP camera to communicate with an access point on channels 1 through 11. • EMEA/Asia—Causes the IP camera to communicate with an access point on channels 1 through 13. • Custom—Causes the IP camera to communicate with an access point on the channels that you specify. Use this option to customize channel communication settings for your area. When you choose this option, 13 channel check boxes appear. Check the check boxes that correspond to the channels that you want.

Advanced Setup Window

The Advanced Setup window provides options for configuring various network and protocol settings for the IP camera.

To display the Advanced Setup window, access the configuration windows as described in the [“Accessing the IP Camera Windows”](#) section on page 2-6, click **Setup**, then click **Advanced Setup**.

If you change any options in the Advanced Setup window, you must click **Save** to save the changes. To discard the changes, click **Cancel** before clicking **Save**. These buttons appear at the bottom of the window. You may need to scroll down to see them.

[Table 3-4](#) describes the options in the Advanced Setup window.

Table 3-4 *Advanced Setup Window Options*

Option	Description
CDP	
Enable CDP (Cisco Discovery Protocol)	Check this check box if CDP is enabled in your network and you want the IP camera to send CDP discovery messages.
Bonjour	
Enable Bonjour (Cisco Discovery Protocol)	<p>Check this check box if Bonjour is enabled in your network and you want the IP camera to send Bonjour discovery messages.</p> <p>Bonjour enables the automatic discovery of computers, devices, and services on and IP network.</p>

Table 3-4 Advanced Setup Window Options (continued)

Option	Description
HTTP/HTTPS	
Enable HTTP Alternative Port	<p>Check this check box to enable Internet access to the IP camera through an HTTP port other than the default port 80. If you enable this option, enter a port number from 1024 through 65535.</p> <p>If you configure an alternative HTTP port, you must specify the port number in the URL for the IP camera when you access it through an HTTP connection. For example, if the IP address of the IP camera is 192.168.1.100 and the alternative HTTP port is 1024, enter this URL for the IP camera: <code>http://192.168.1.100:1024</code>.</p>
Enable HTTPS Alternative Port	<p>Check this check box to enable Internet access to the IP camera through an HTTPS port other than the default port 443. If you enable this option, enter a port number from 1024 through 65535.</p> <p>If you configure an alternative HTTPS port, you must specify the port number in the URL for the IP camera when you access it through an HTTPS connection. For example, if the IP address of the IP camera is 192.168.1.100 and the alternative HTTPS port is 1024, enter this URL for the IP camera: <code>https://192.168.1.100:1024</code>.</p>
RTP/RTSP	
RTSP Port	<p>Transmission Control Protocol (TCP) port on which the IP camera receives Real-Time Streaming Protocol (RTSP) commands. You must configure this port to allow third-party devices or software to access video streams from the IP camera.</p> <p>RTSP is a standard for connecting a client to control streaming data (MPEG-4) over the web.</p> <p>Valid values are 554 and 1024 through 65535. The default value is 554.</p>
RTP Data Port	<p>Universal Data Protocol (UDP) port on which the IP camera transmits Real-Time Transport Protocol (RTP) data.</p> <p>RTP is a standard for transmitting real-time data, such as audio and video, to selected clients.</p> <p>Valid values are 1024 through 65535. The default value is 5000. The default value can be used for multicasting and typically does not need to be changed.</p>
Max RTP Video Packet Length	<p>Maximum number of bytes per video packet that are sent in each RTP request.</p> <p>Configure a lower number if you are streaming video to a cell phone that requires smaller data packets.</p> <p>Valid values are 400 through 1400. The default value is 1400.</p>
Max RTP Audio Packet	<p>Maximum number of bytes per audio packet that are sent in each RTP request.</p> <p>Configure a lower number if you are streaming video to a cell phone that requires smaller data packets.</p> <p>Valid values are 400 through 1400. The default value is 1400.</p>

Table 3-4 *Advanced Setup Window Options (continued)*

Option	Description
Enable Multicast	Check this check box to send video and audio data as a multicast stream. When multicast is enabled, the IP camera sends video and audio to the multicast addresses that you designate. Multicast enables multiple devices to receive the video signal from the IP camera simultaneously.
Video Address	<i>Appears if you enabled multicast.</i> Enter the multicast IP address on which the IP camera sends a video stream. The default value is 224.2.0.1.
Video Port	<i>Appears if you enabled multicast.</i> Enter the port on which the IP camera sends a multicast video stream. Valid values are even numbers 1024 through 65534. The default value is 2240.
Audio Address	<i>Appears if you enabled multicast.</i> Enter the multicast IP address on which the IP camera sends an audio stream. The default value is 224.2.0.1.
Audio Port	<i>Appears if you enabled multicast.</i> Enter the port on which the IP camera sends a multicast audio stream. Valid values are even numbers 1024 through 65534. The default value is 2242.
Time to Live	<i>Appears if you enabled multicast.</i> Enter the number of hops, which specifies the number of network devices that an audio-video stream can pass before arriving at its destination or being dropped. Valid values are 1 through 255. The default value is 16.
QoS	
Enable QoS Mode	Check this check box and click the Audio , Video , or Both radio button to enable Quality of Service (QoS) for audio streams, video streams, or both streams. Note QOS applies to Layer 3 only, and is applied to ASF and RTP video streams. When QOS is applied to an ASF video stream, DSCP values are not distinguished between audio and video streams because they are applied to the same stream. When QOS is applied to an RTP video stream, DSCP values are distinguished between audio and video streams because they are applied to different streams.
Enable WMM (802.11e QoS)	<i>Applies to wireless IP camera only.</i> Check this check box to enable wireless multimedia extensions for 802.11e QoS, which provides basic QoS features for the wireless IP camera.
DSCP	If you enable QoS, enter the Differentiated Services Code Point (DSCP) to be used to process QoS packets. The default value is 12.

IP Filter Window

The IP Filter window provides options for controlling access to the IP camera by designating a list of IP addresses that can access the IP camera and a list of IP addresses that cannot access the IP camera.

To display the IP Filter window, access the configuration windows as described in the “[Accessing the IP Camera Windows](#)” section on page 2-6, click **Setup**, then click **IP Filter**.

If you change any options in the IP Filter window, you must click **Save** to save the changes. To discard the changes, click **Cancel** before clicking **Save**. These buttons appear at the bottom of the window. You may need to scroll down to see them.

[Table 3-5](#) describes the options in the IP Filter window.

Table 3-5 IP Filter Window Options

Option	Description
Options	<p>Choose the option that specifies how to control IP addresses from which the IP camera can be accessed:</p> <ul style="list-style-type: none"> • Disable—Do not use the IP address filtering feature. In this case, the IP camera can be accessed from a device with any IP address. • Enable and deny the following IP address—Lets you designate one or more IP addresses or range of IP addresses that cannot access the IP camera. All other IP addresses can access the IP camera. • Enable and allow the following IP address—Lets you designate one or more IP addresses or range of IP addresses that can access the IP camera. All other IP addresses cannot access the IP camera.
Single/Range	<p>If you enable IP address filtering, choose either of the following options from as many drop-down lists as needed:</p> <ul style="list-style-type: none"> • Single—Enter an IP address that is denied or allowed access to the IP camera, depending on the Options setting. • Range—Enter a range of IP address that is denied or allowed access to the IP camera, depending on the Options setting.

EAPOL Window

The EAPOL window provides options for configuring Extensible Authentication Protocol Over LANs (EAPOL). This protocol is used to authenticate and control user traffic in an 802.1x network.

To display the EAPOL window, access the configuration windows as described in the “[Accessing the IP Camera Windows](#)” section on page 2-6, click **Setup**, then click **EAPOL**.

If you change any options in the EAPOL window, you must click **Save** to save the changes. To discard the changes, click **Cancel** before clicking **Save**. These buttons appear at the bottom of the window. You may need to scroll down to see them.

[Table 3-5](#) describes the options in the EAPOL window.

Table 3-6 IP Filter Window Options

Option	Description
Enable EAPOL	Check this check box to enable EAPOL on the IP camera.
EAP-TLS Options	
Note These options appear if you check the Enable EAPOL check box and then choose EAP-TLS from the Protocol Type drop-down list.	
User ID	User identifier that is used to log in to the RADIUS server.
Root Certificate	Path and folder on this PC or location of a Windows network shared folder where the root certificate file is stored. You can click Browse to find this location. After you enter this information, click Upload to upload the certificate from the local PC to the IP camera.
Validate Root Certificate	Check this check box if you want the identity of the RADIUS server to be validated.
User Certificate	Path and folder on this PC where the user certificate file is stored. You can click Browse to find this location. After you enter this information, click Upload to upload the certificate from the local PC to the IP camera.
Password	IP camera client log in password for the RADIUS server.
EAP-FAST Options	
Note These options appear if you check the Enable EAPOL check box and then choose EAP-FAST from the Protocol Type drop-down list.	
Allow Automatic PAC Provisioning	Check this check box if you want to allow authentication servers to establish a secure connection with the IP camera so that they can provide the IP camera with new Protected Access Credentials (PACs).
User ID	User identifier that is used to log in to the RADIUS server.
Password	IP camera client log in password for the RADIUS server.
Anonymous ID	Unsigned public identifier to be used instead of a user name for logging in to the RADIUS server.
PAC File	Path and folder on this PC where the Protected Access Credential (PAC) file is stored. You can click Browse to find this location. After you enter this information, click Upload to upload the certificate from the local PC to the IP camera.

Administration Windows

The Administration windows let you configure IP camera users, reset or restart the IP camera, and upgrade firmware on the IP camera.

The following sections describe the Setup windows in detail:

- [Users Window, page 3-16.](#)
- [Maintenance Window, page 3-17](#)
- [Firmware Window, page 3-19.](#)

Users Window

The Users window lets you configure access to the IP camera for the following types of users:

- **Administrator**—Can access the configuration windows for the IP camera, view video in the Home window, and access all controls in the Home window.
- **User**—You can configure up to 20 users and assign privilege levels to each one.

To display the Users window, access the configuration windows as described in the [“Accessing the IP Camera Windows”](#) section on page 2-6, click **Administration**, then click **Users**.

When you make configuration settings in this window, follow these guidelines:

- If you configure information in a field the Administrator area, click **Change** in that area or **Save** at the bottom of the screen to save your changes.
- If you configure information in the User List area, click **Add** next to the user or **Save** at the bottom of the screen to save your changes.
- To remove a user, click **Delete** next to the user. If you delete a user who is logged into the IP camera, the user remains logged in and can continue access the IP camera.
- To discard the changes before you click **Change** or **Save**, click **Cancel**.
- The **Save** and **Cancel** buttons appear at the bottom of the window. You may need to scroll down to see them.

[Table 3-7](#) describes the options in the Users window.

Table 3-7 Users Window Options

Option	Description
Administrator	
User ID	<i>Display only.</i> The user ID for the IP camera administrator is Admin. The administrator can access the configuration windows for the IP camera, control all IP camera functions, view video from the IP camera, and access the Administrator windows
User name	<i>Display only.</i> The user name for the IP camera administrator is admin (all lower case).
Password	Enter a password for the IP camera administrator. The password must contain least 8 characters, which can be letters, numbers, and special characters, but no spaces. It is case sensitive. Note You can also set this password and configure other requirements for it in the Initialization window as described in the “Initialization Window” section on page 3-27.
Confirm Password	Re-enter the password for the administrator.
User List	
User ID	<i>Display only.</i> There are 20 default user IDs, User 1 through User 20.
User Name 1 – 20	Enter a unique name for the user. The name can include up to 32 letters and numbers. It is case sensitive.

Table 3-7 *Users Window Options (continued)*

Option	Description
Password	Enter a password for the user. The password is case sensitive and must contain at least 8 characters, which can be letters, numbers, and special characters, but no spaces. Special characters are: ! " # \$ % & ' () * + , - . : ; < = > ? @ [\] ^ _ ` { } ~.
Confirm Password	Re-enter the password for the user.
Privilege Level	Choose the desired privilege level for the user: <ul style="list-style-type: none"> • Administrator—Same as the IP camera administrator. Allows the user to access the configuration windows for the IP camera, view video in the Home window, and access all controls in the Home window. • Monitor—Allows the user to view video in the Home window and to access all controls in the Home window. • Viewer—Allows the user to view video in the Home window and to access these controls in the Home window: resolution, digital zoom, snapshot, speaker on/off, speaker volume, microphone on/off, microphone volume.

Maintenance Window

The Maintenance window provides options for resetting or restarting the IP camera, saving configuration information from the IP camera, and uploading the configuration information to the IP camera.

Saving and uploading configuration is useful for these activities:

- **Configuring multiple IP cameras**—If your network includes several IP cameras that should have similar configurations, you can configure one IP camera, save that configuration, and upload it to other IP cameras. Then, instead of manually configuring all options on each IP camera, you manually configure only the options that are unique, such as the IP address, if not obtained from DHCP.
- **Backing up configuration**—If you save the configuration from the IP camera, you can upload it to the IP camera to restore the configuration if it is lost, or if you can upload it to a replacement IP camera, if needed.

To display the Maintenance window, access the configuration windows as described in the [“Accessing the IP Camera Windows”](#) section on page 2-6, click **Administration**, then click **Maintenance**.

Table 3-8 describes the options in the Maintenance window.

Table 3-8 Maintenance Window Options

Option	Description
Restore Factory Defaults	<p>Click the Restore button to restore all IP camera settings to their factory default values.</p> <p>To confirm the restore procedure, click OK in the confirmation pop-up window. Otherwise, click Cancel.</p> <p>This action has the same effect as pressing and holding the Reset button on the IP camera for at least 10 seconds. After you perform this procedure, follow the steps in the “Performing the Initial Setup of the IP Camera” section on page 2-5.</p>
Restart	<p>Click the Restart button to reboot the software on IP camera.</p> <p>To confirm the restart procedure, click OK in the confirmation pop-up window. Otherwise, click Cancel.</p> <p>This action has the same effect as pressing and immediately releasing the Reset button on the IP camera, or powering the IP camera down and then powering it up.</p>
Configuration	<p>Click the Save button to save the current IP camera configuration information to a binary file.</p> <p>When you click this button, the File Download window appears. Use this window to save the configuration file. This file must include the extension .cfg.</p> <p>You can then upload this configuration information to any IP camera in the network. This feature is useful for creating a backup of this configuration and for configuring other IP cameras based on this configuration.</p>
Upload	<p>Path and folder where a configuration file is stored. You can click Browse to find this location. After you enter this information, click Upload and follow the on-screen prompts to load the configuration file to the IP camera.</p> <p>After you upload a configuration file to the IP camera, the IP camera restarts automatically.</p> <p>If you upload configuration from another IP camera that is active in your network, make sure to configure this IP camera with a name, description, and unique IP address (if not obtained from DHCP). To change these options, see the “Basic Setup Window” section on page 3-5.</p> <p>Note A configuration file that you upload includes the passwords that are configured for the administrator and for users. If you change any passwords after saving the configuration file, be aware that uploading the file overwrites the new passwords with the saved ones.</p>

Firmware Window

The Firmware window lets you view information about the firmware that is installed on the IP camera and upgrade the firmware.

Before you upgrade firmware, download the firmware file to a PC that is accessible on your network and unzip the file if it is zipped. To download firmware, go to this web page:

<http://www.cisco.com/en/US/products/ps7307/index.html>

After you upgrade firmware, the IP camera restarts automatically. It retains all configuration information.

To display the Firmware window, access the configuration windows as described in the “[Accessing the IP Camera Windows](#)” section on page 2-6, click **Administration**, then click **Firmware**.

Table 3-9 describes the options in the Firmware window.

Table 3-9 Firmware Window Options

Option	Description
Firmware Version	<i>Display only.</i> Firmware version that is loaded on the IP camera.
Upgrade	<p>Click the Upgrade button to upgrade the firmware on the IP camera.</p> <p>When you click this button, the Upgrade Firmware window appears. In this window, enter the path and folder where the firmware upgrade file for the IP camera is stored. The upgrade file may be stored on another PC. You can click Browse to find this location. After you enter this information, click Upgrade and follow the on-screen prompts to load the firmware upgrade on the IP camera.</p> <p>Note Do not power down the IP camera during the upgrade procedure.</p>
Recovery Firmware Version	<i>Display only.</i> Firmware version of the recovery image. If an upgrade fails, the IP camera boots from the recovery image.

Audio/Video Windows

The Audio/Video windows provide options for configuring audio and video from the IP camera.

The following sections describe the Setup windows in detail:

- [Video Window](#), page 3-19.
- [Audio Window](#), page 3-24

Video Window

The Video window provides options for configuring the video from the IP camera. You can configure settings for the primary and an optional secondary video stream.

Configuring a secondary stream is useful for providing third-party devices or software with a video stream that is at a lower resolution than the primary. Some devices and software require this lower resolution. For related information, see the “[Viewing Video through Third-Party Devices or Software](#)” section on page 4-6.

To display the Video window, access the configuration windows as described in the “[Accessing the IP Camera Windows](#)” section on page 2-6, click, **Audio/Video**, then click **Video**.

If you change any options in the Video window, you must click **Save** to save the changes. To discard the changes, click **Cancel** before clicking **Save**. These buttons appear at the bottom of the window. You may need to scroll down to see them.

Table 3-10 describes the options in the Video window.

Table 3-10 Video Window Options

Option	Description
Streaming Mode	<p>Choose the mode that the IP camera uses for video streaming:</p> <ul style="list-style-type: none"> • Single MPEG-4 Stream—Configures MPEG-4 for the primary stream. The stream can be up to D1 resolution and 30 fps for NTSC or 25 fps for PAL. • Single MJPEG Stream—Configures MJPEG for the primary stream. The stream can be up to D1 resolution and 15 fps. • Dual MPEG-4 Streams—Configures MPEG-4 for the primary stream and the secondary stream. The primary stream can be up to 4 CIF and 25 fps for NTSC or 20 fps for PAL. The secondary stream can be up to CIF and 15 fps. • Dual Streams (MPEG-4 + MJPEG)—Configures MPEG-4 for the primary stream and MJPEG for the secondary stream. The primary stream can be up to 4CIF and 25 fps for NTSC or 20 fps for PAL. The secondary stream can be up to CIF and 15 fps.
MPEG-4 Settings 1	
Note These MPEG-4 Settings options appear if you choose Single MPEG-4 Stream , Dual MPEG-4 Streams , or Dual Streams (MPEG-4 + MJPEG) from the Streaming Mode drop-down list.	
Resolution	<p>Choose the desired video resolution format for the primary video stream from the IP camera.</p> <p>For the wired IP camera, the default resolution is 720 x 480 for NTSC or 720 x 576 for PAL. For the wireless IP camera, the default resolution is 4CIF.</p>
Video Quality Control	<p>Choose an option for the video quality of the primary video stream from the IP camera:</p> <ul style="list-style-type: none"> • Constant Bit Rate—Specifies that the video stream is output at or close to the constant bit rate that you choose. The default value for the wired IP camera is 4 Mbps. The default value for the wireless IP camera is 1 Mbps. A higher bit rate provides better video quality but consumes more bandwidth. • Fixed Quality—Specifies that video is output at a fixed quality, which ranges from Very High to Very Low. The bit rate may vary to maintain this quality. The default fixed quality is Normal. A higher fixed quality provides better video quality but consumes more bandwidth. <p>You can use these options to help manage bandwidth use in your network. For example, if the IP camera is focused on an area with little movement, such as an emergency exit, you can configure it with a low fixed quality.</p>

Table 3-10 Video Window Options (continued)

Option	Description
Max. Frame Rate	<p>Choose the desired maximum frame rate per second for the primary video stream from the IP camera.</p> <p>For the wired IP camera, the default values are 30 for NTSC and 25 for PAL. For the wireless IP camera, default value is 15.</p> <p>A higher maximum frame rate provides better video quality but consumes more bandwidth</p>
MPEG-4 Settings 2	
Note These MPEG-4 Settings 2 options appear if you choose the Dual MPEG-4 Streams from the Streaming Mode drop-down list.	
Resolution	Choose the resolution of the secondary video stream.
Video Quality Control	<p>Choose an option for video quality for the secondary video stream from the IP camera:</p> <ul style="list-style-type: none"> • Constant Bit Rate—Specifies that the video stream is output at or close to the constant bit rate that you choose. The default value is 64 Kbps. A higher bit rate provides better video quality but consumes more bandwidth. • Fixed Quality—Specifies that video is output at a fixed quality, which ranges from Very High to Very Low. The bit rate may vary to maintain this quality. The default fixed quality is Normal. A higher fixed quality provides better video quality but consumes more bandwidth.
Max. Frame Rate	<p>Choose the desired maximum frame rate per second for the secondary video stream from the IP camera.</p> <p>For the wired IP camera, the default values are 25 for NTSC or 20 for PAL. For the wireless IP camera, default value is 15.</p> <p>A higher maximum frame rate provides better video quality but consumes more bandwidth</p>
MJPEG Settings	
Note These MPJEG Settings 2 options appear if you choose the Single MJPEG Stream or the Dual Streams (MPEG-4 + MJPEG) from the Streaming Mode drop-down list.	
Resolution	Choose the resolution of the MJPEG video stream.
Fixed Video Quality	Specifies that video is output at a fixed quality, which ranges from Very High to Very Low. The bit rate may vary to maintain this quality. The default fixed quality is Normal. A higher fixed quality provides better video quality but consumes more bandwidth.
Max. Frame Rate	<p>Choose the desired maximum frame rate per second for the secondary video stream from the IP camera.</p> <p>The default value is 5.</p> <p>A higher maximum frame rate provides better video quality but consumes more bandwidth</p>

Table 3-10 Video Window Options (continued)

Option	Description
Video Adjustment	
Video System	<p>Choose the media format that the IP camera should use: NTSC/60 Hz or PAL/50 Hz.</p> <p>If your IP camera receives a voltage with a 60Hz signal, choose NTSC/60 Hz. If your IP camera receives a voltage with a 50 Hz signal, choose PAL/50 Hz to prevent flickering in the video image.</p>
Preset	<p>Choose one the following preset white balance modes from the Preset drop-down list:</p> <ul style="list-style-type: none"> • Normal—Suitable for most conditions that do not have special lighting • Indoor—Suitable for indoor conditions when the Normal setting does not provide a clear image • Fluorescent—Suitable for indoor conditions with fluorescent lighting • Outdoor—Suitable for outdoor conditions <p>The default setting is Normal.</p>
Brightness	<p>Choose a positive value to increase the brightness of the video from the IP camera or choose a negative value to decrease the brightness. For example, if the IP camera is facing a bright light and the video appears too dark, you can increase the brightness.</p> <p>The default value is Normal, which is suitable for most conditions.</p>
Sharpness	<p>Choose a positive value to increase the sharpness of the video from the IP camera or choose a negative value to decrease the sharpness.</p> <p>The default value is Normal, which is suitable for most conditions.</p>
Contrast	<p>Choose a positive value to increase the contrast of the video from the IP camera or choose a negative value to decrease the contrast.</p> <p>The default value is Normal, which is suitable for most conditions.</p>
Saturation	<p>Choose a positive value to increase the saturation of the video from the IP camera or choose a negative value to decrease the saturation.</p> <p>High saturation provides a vivid, intense color for a video image. With less saturation, the video image appears more muted and gray.</p> <p>The default value is Normal, which is suitable for most conditions.</p>
Frame Repeat Count	<p>Designates how video output from the IP camera displays. The IP camera generates two independent fields (odd and even) for each video capture, which occur 60 times per second for NTSC or 50 times per second for PAL.</p> <p>When Frame Repeat Count is set to 1, the IP camera combines one odd and one even field to compose a video frame. When Frame Repeat Count is set to 2, the IP camera uses one of the fields two times to compose a video frame.</p> <p>A setting of 1 provides smoother video. It is designed for software that can display interlaced video.</p> <p>The default value is 2.</p>

Table 3-10 Video Window Options (continued)

Option	Description
Options	
Enable Time Stamp	Check this check box to display the time from the internal clock of the IP camera as an overlay on the video image from the IP camera.
Enable Text Display	<p>Check this check box to display designated text as an overlay on the video image from the IP camera, and enter alphanumeric text of up to 20 characters.</p> <p>This option can be useful for identifying this IP camera in an installation with several IP cameras.</p>
Day/Night Vision	
Switch Mode	<p>Choose the day/night vision mode for the IP camera:</p> <ul style="list-style-type: none"> • Auto—IP camera automatically switches between day and night mode based on the lighting condition threshold that you specify. • Day—IP camera always remains in day mode. • Night—IP camera always remains in night mode. • Night schedule—IP camera switches to and from Night mode based on the Start and End times. <p>Note If you configure a night schedule, make sure that the time on the IP camera is set correctly.</p>
Validation Time	<p>If the Switch Mode option is set to Auto, specify the time that the camera waits before switching Day/Night modes. The light level must continually exceed the threshold for the duration of the validation time to trigger a transition between the modes.</p> <p>For example, if the Validation Time is set to 5 seconds and the current light level exceeds the Night/Day Threshold for 5 seconds, the camera switches mode. However, if the light level falls below the threshold during the Validation Time, the timer resets and the camera remains in the same mode. The default value for Validation Time is 2 seconds.</p> <p>Note If a camera experiences lighting conditions that cause it to switch continuously between Day and Night modes three times within 20 minutes (as the result of a low light scene with excessive IR illumination or the thresholds being configured too close together), the camera locks in to its last state for 20 minutes.</p> <p>For example, if the first transition is from Day to Night, the camera will switch from Day to Night to Day to Night and then remain in Night mode for 20 minutes. If the first transition is from Night to Day, the camera will switch from Night to Day to Night to Day and then remain in Day mode for 20 minutes.</p> <p>To unlock the 20 minute hold period, manually configure the camera to Day mode, then Night mode, then Day mode, and then Auto mode.</p>

Table 3-10 Video Window Options (continued)

Option	Description
Day to Night Threshold	If the Switch Mode is set to Auto, choose the value that specifies the relative light threshold at which the IP camera switches from day to night mode. A lower value designates that the IP camera switches from day to night mode in brighter conditions. A higher value designates that the IP camera switches modes in darker conditions. The default value is 24 for all presets.
Night to Day Threshold	If the Switch Mode is set to Auto is set to Auto, choose the value that specifies the relative light threshold at which the IP camera switches from night to day mode. A lower value designates that the IP camera switches from night to day mode in darker conditions. A higher value designates that the IP camera switches modes in lighter conditions. The default value is 6 for Outdoor preset and 16 for Normal, Indoor, Fluorescent and Metal Halide.
Start Time	If the Switch Mode is set to Night schedule, enter the time, in 24 hour format, that the camera enables its night filter.
End Time	If the Switch Mode is set to Night schedule, enter the time, in 24 hour format, that the camera disables its night filter.

Audio Window

The Audio window provides options for enabling and configuring audio that is transmitted to and from the IP camera. You can configure audio for these devices:

- **Internal microphone**—The IP camera includes an internal microphone that can capture audio at the camera location. This audio is sent to the PC that you use to view video from the IP camera. You can listen to the audio when viewing video in the Home window.
- **External microphone**—You can connect an optional external microphone (available from third-parties) to the IP camera. This audio is sent to the PC that you use to view video from the IP camera. You can listen to the audio when viewing video in the Home window. Connecting an external microphone disables the internal microphone.
- **External speaker**— You can connect an optional external speaker (available from third-parties) to the IP camera. This speaker plays audio that is captured by the microphone of the PC that you use to view video from the IP camera. The PC can capture and send this audio only when the Home window is open.

To display the Audio window, access the configuration windows as described in the “[Accessing the IP Camera Windows](#)” section on page 2-6, click **Audio/Video**, then click **Audio**.

If you change any options in the Audio window, you must click **Save** to save the changes. To discard the changes, click **Cancel** before clicking **Save**. These buttons appear at the bottom of the window. You may need to scroll down to see them.

[Table 3-11](#) describes the options in the Audio window.

Table 3-11 Audio Window Options

Option	Description
Enable Audio	<p>Check this check box to enable audio from the IP camera, and choose one of these options:</p> <ul style="list-style-type: none"> • Simplex - Listen Only—Enables a simplex connection that allows you to receive audio from the IP camera but not transmit audio to the IP camera • Simplex - Talk Only—Enables a simplex connection that allows you to transmit audio to the IP camera but not receive audio from the IP camera • Half Duplex - Talk or Listen—Enables a half duplex connection that lets you receive audio from and transmit audio to the IP camera, but not simultaneously • Full Duplex - Talk and Listen—Enables a full duplex connection that lets you simultaneously receive audio from and transmit audio to the IP camera <p>Note When you enable transmitting audio to the IP camera (which enables the internal or external microphone), the internal microphone on the IP camera or an external microphone that is attached to the IP camera is muted by default. To unmute the microphone, use the Microphone On toggle button in the Home window. For detailed information, see the “Home Window Controls” section on page 4-3.</p>
Enable Microphone	<p><i>Display only.</i> A check indicates that the internal microphone on the IP camera or an external microphone that is attached to the IP camera is enabled.</p> <p>The microphone is enabled when you check the Enable Audio check box and choose Simplex - Listen Only, Half Duplex - Talk or Listen, or Full Duplex - Talk and Listen.</p> <p>Note If you connect an external microphone, the internal microphone on the IP camera is disabled.</p>
Enable External Speaker	<p><i>Display only.</i> A check indicates that a speaker that is connected to the IP camera is enabled.</p> <p>The speaker is enabled when you check the Enable Audio check box and choose Simplex - Talk Only, Half Duplex - Talk or Listen, or Full Duplex - Talk and Listen to make this check box available.</p>
Audio Type	<p>Choose the codec for audio that is transmitted from the IP camera.</p> <p>This option is available when you check the Enable Audio check box and choose Simplex - Listen Only, Half Duplex - Talk or Listen, or Full Duplex - Talk and Listen.</p>

Security Windows

The Security windows provide options for stopping IP camera processes, configuring administrator and root password requirements, and enabling access to the IP camera through HTTP or Secure Shell (SSH) connections.

The following sections describe the Security windows in detail:

- [Product Process Window, page 3-26](#)
- [Initialization Window, page 3-27](#)
- [Complexity Window, page 3-27](#)

Product Process Window

The Product Process window displays the processes that occupy TCP or UDP ports and lets you stop any of these processes.

Take care when stopping processes because some processes are required for the camera to operate properly.

Processes that you stop in this window can restart the next time that you log in to the IP camera. If you delete a required process and the camera stops functioning, exit your web browser and then log back in to the IP camera to restart the process.

To stop any process, click the **Delete** button that appears to the right of the process.

To make sure that the Product Process window shows the most current information, click the **Refresh** button.

[Table 3-12](#) describes the options in the Product Process window. All options are for display only.

Table 3-12 *Product Process Window Options*

Option	Description
Protocol	Port (tcp or udp) that the process occupies
Local Address	IP address of the device that the process is listening to
Foreign Address	IP address and port number of the client device that is connected for the process
State	State of the process
Program Name	Name of the process

Initialization Window

The Initialization window lets you configure administrator and root passwords, whether the IP camera can be accessed through an HTTP connection in addition to the default HTTPS (HTTP secure) connection, and whether the IP camera can be accessed through a SSH connection.

Table 3-13 describes the options in the Initialization window.

Table 3-13 Initialization Window Options

Option	Description
Admin Password	<p>Allows you to change the password for the IP camera administrator.</p> <p>The password is case sensitive and must contain at least 8 characters, which can be letters, numbers, and special characters, but no spaces. Special characters are: ! " # \$ % & ' () * + , - . : ; < = > ? @ [\] ^ _ ` { } ~.</p> <p>Note You can also change this password in the Users window as described in the “Users Window” section on page 3-16.</p>
Root Password	<p>Allows you to change the root password, which is used when accessing the IP camera through a SSH connection.</p> <p>The password is case sensitive and must contain at least 8 characters, which can be letters, numbers, and special characters, but no spaces. Special characters are: ! " # \$ % & ' () * + , - . : ; < = > ? @ [\] ^ _ ` { } ~.</p>
HTTP	<p>Click the Enable radio button if you want to allow HTTP and HTTPS connections to the IP camera.</p> <p>By default, the IP camera allows only HTTPS connections.</p>
SSH	<p>Click the Enable radio button is you want to allow access to the camera through a SSH connection.</p>

Complexity Window

The Complexity window provides options for configuring requirements for the IP camera administrator and user passwords.

Table 3-14 describes the options in the Complexity window.

Table 3-14 Complexity Window Options

Option	Description
Password Check 1	<p>Password must contain characters from at least 3 of these categories:</p> <ul style="list-style-type: none"> • Lower case letters (a through z) • Upper case letters (A through Z) • Digits (0 through 9) • Special characters (: ! " # \$ % & ' () * + , - . : ; < = > ? @ [\] ^ _ ` { } ~)
Password Check 2	Administrator password cannot include any character that occurs 3 or more times consecutively
Password Check 3	Password cannot be the same as the user name either forward of reversed
Password Check 4	Not used

Applications Windows

The Applications windows provide options for configuring and managing a variety of applications and IP camera activities.

The following sections describe the Applications windows in detail:

- [Mail & FTP Window, page 3-28.](#)
- [Motion Detection Window, page 3-30](#)
- [Event Window, page 3-31](#)
- [SNMP Window, page 3-34](#)
- [Alarm I/O Ports Window, page 3-35](#)
- [PTZ \(RS-485\) Window, page 3-36](#)
- [Preset Positions Window, page 3-37](#)

Mail & FTP Window

When the IP camera detects an event, it can send an e-mail message to up to three designated recipients. The e-mail notifies recipients that an event occurred and provides access to video of the event. The Mail & FTP window includes options for configuring how such messages are sent. You enable e-mail alerts and configure options for event video files as described in the “[Event Window](#)” section on [page 3-31](#).

The e-mail message includes the subject line that you configure. In addition, depending on your configuration, the message can provide video of the event that triggered the alert in either or both of the following ways:

- By including a link to an FTP server from which recipients can download the video file to a local PC.
- By including the video file as an attachment that recipients can view using a standard media player. The file name is *Camera_name-Event_Name-yymmdd-hhmmss.xxx*, where:
 - *Camera_name* is the name of the IP camera, as configured in the Camera Name field in the Basic Setup window.
 - *Event_name* describes the event that caused the alert. For motion detection events, this field is the name of the video field area in which motion was detected (for example, Window 2). For input events, this field is input1 or input2, depending on which input port the event was detected.
 - *yymmdd* is the 2-digit year, month, and date on which the event occurred.
 - *hhmmss* is the, hours, minutes, and seconds at which the event occurred.
 - *xxx* is the format of the file (asf, mp4, or 3gp), as configured in the Video Format (MPSG-4) field in the Event window.



Note A large video file may exceed the maximum file size for e-mail attachments that is configured on your mail server.

By default, the video in a video file starts when an event starts and ends 5 seconds after the event ends. You can designate that additional video be included before and after an event as described in the “[Event Window](#)” section on [page 3-31](#).

To display the Mail & FTP window, access the configuration windows as described in the [“Accessing the IP Camera Windows”](#) section on page 2-6, click **Applications**, then click **Mail & FTP**.

If you change any options in the Mail & FTP window, you must click **Save** to save the changes. To discard the changes, click **Cancel** before clicking **Save**. These buttons appear at the bottom of the window. You may need to scroll down to see them.

Table 3-15 describes the options in the Mail & FTP window.

Table 3-15 Mail & FTP Window Options

Option	Description
Primary SMTP Server	
Primary SMTP	Check this check box to cause e-mail messages to be sent to the primary Simple Mail Transport Protocol (SMTP) server.
SMTP Mail Server	Enter the name or IP address of the primary SMTP server. If you enter a name, you must configure the Primary DNS option as described in the “Basic Setup Window” section on page 3-5.
Authentication	If the primary SMTP server requires authentication to send e-mail, choose the appropriate authentication type. The authentication type typically is the same as that for the POP3 server that you use to receive e-mail.
Account Name	If the primary SMTP server requires authentication, enter the account name for the server.
Password	If the primary SMTP server requires authentication, enter the account password for the server.
POP Server Name	Enter the name of the POP3 mail server that you use to receive e-mail.
Secondary SMTP Server	
Secondary SMTP	Check this check box to cause e-mail messages to be sent to a secondary (backup) SMTP server if the primary SMTP server is unavailable.
SMTP Mail Server	Enter the IP address of the secondary SMTP server.
Authentication	If the secondary SMTP server requires authentication to send e-mail, choose the appropriate authentication type. The authentication type typically is the same as that for the POP3 server that you use to receive e-mail.
Account Name	If the secondary SMTP server requires authentication, enter the account name for the server.
Password	If the secondary SMTP server requires authentication, enter the account password for the server.
POP Server Name	Enter the name of the POP3 mail server that you use to receive e-mail.
E-Mail Setup	
Send To	Enter at least 1 e-mail address to which e-mail messages are sent when an event occurs. The second and third addresses are optional.
Show “From” as	Enter the e-mail address to be shown in the From field for e-mail messages that are sent when an event occurs.
Subject	Enter the text to be shown in the Subject field for the e-mail messages that the IP camera sends when events occur. The subject can contain up to 48 characters, including spaces.

Table 3-15 Mail & FTP Window Options (continued)

Option	Description
E-mail Body	
Attach Video Streaming URL Address	Check this check box to include in the message body the URL of an FTP server from which you can download a video file to your local PC.
Primary FTP	
Primary FTP	Check this check box to cause the IP camera automatically upload event video files to the primary FTP server when the files are created.
FTP Server	Enter the IP address of the primary FTP server to which event video files are uploaded.
Port	Enter the port number of the primary FTP server to which event video files are uploaded. The default value is 21.
Login name	Enter the log in name of the primary FTP Server.
Password	Enter the password of the primary FTP Server.
File Path Name	Enter path where the event video file is stored on the primary FTP server.
Enable Passive Mode	Check this check box to enable the passive mode feature of the primary FTP server.
Secondary FTP	
Secondary FTP	Check this check box cause the IP camera automatically upload event video files to a secondary (backup) FTP server if the primary FTP server is unavailable.
FTP Server	Enter the IP address of the secondary FTP server.
Port	Enter the port number of the secondary FTP server.
Login name	Enter the log in name of the secondary FTP Server.
Password	Enter the password of the secondary FTP Server.
File Path Name	Enter path where event video files are stored on the secondary FTP server.
Enable Passive Mode	Check this check box to enable the passive mode feature of the secondary FTP server.

Motion Detection Window

The Motion Detection window allows you to configure up to three areas in a video field. The IP camera monitors activity in each area. If activity exceeds a configured threshold in any of these areas, the IP camera generates an alert and takes the actions that are configured in the Event window. (See the “[Event Window](#)” section on page 3-31 for more information.)

To display the Motion Detection window, access the configuration windows as described in the “[Accessing the IP Camera Windows](#)” section on page 2-6, click **Applications**, then click **Motion Detection**.

The Motion Detection window displays the current video from the IP camera and provides several configuration options. If you are prompted to install ActiveX controls when trying to access this window, follow the on-screen prompts to do so. ActiveX controls are required to see the video and the options.

If you change any options in the Motion Detection window, you must click **Apply** to save the changes.

**Note**

In addition to moving objects, motion detection can be triggered by rapid changes in lighting conditions or by movement of the IP camera itself.

Table 3-16 describes the options in the Motion Detection window.

Table 3-16 Motion Detection Window Options

Option	Description
Setting Custom Area	<p>Check this check box to cause the IP camera to examine up to 4 areas in its video field for activity. Then configure these options:</p> <ul style="list-style-type: none"> • Window check boxes—Check up to 4 check boxes to specify up to 4 areas in the IP camera video field. If desired, enter a name of up to 12 characters for each area in the field next to the corresponding check box. When you check a check box, a window appears in the IP camera view. This window designates the area to examine for motion. Drag the window to the desired area, and drag an edge or corner of the window to resize it. To remove a window, uncheck its check box. • Indicator—<i>Display only</i>. Horizontal bar that represents how much activity is being detected in the area. You can test the sensitivity setting by causing motion the area and looking at this indicator. • Sensitivity—Drag the slider to specify the relative amount of activity in the area that causes an event alert. A lower value means that more activity is required to trigger an alert. A higher value means that less activity is required.

Event Window

The Event window provides options for configuring how the IP camera handles events. An event is either of the following:

- Motion that the IP camera detects. For related information about motion detection, see the “[Motion Detection Window](#)” section on page 3-30.
- A change of state from low to high or from high to low on an input port of the IP camera. For related information about input ports, see the “[Alarm I/O Ports Window](#)” section on page 3-35.

When an event occurs, it triggers the IP camera to take certain configured actions. For example, an event can cause the IP camera to send a notification e-mail message to designated recipients and upload a video file to an SMTP server or an FTP server, or it can cause the IP camera to activate an output port.

The Event window allows you to designate up to 10 schedules. If an event takes place within a designated schedule, the IP camera takes the actions that you configure.

To display the Event window, access the configuration windows as described in the “[Accessing the IP Camera Windows](#)” section on page 2-6, click **Applications**, then click **Event**.

If you change any options in the Event window, except deleting an event from the event schedule list, you must click **Save** to save the changes. To discard the changes, click **Cancel** before clicking **Save**. These buttons appear at the bottom of the window. You may need to scroll down to see them.

Table 3-17 describes the options in the Event window.

Table 3-17 Event Window Options

Option	Description
Event Schedule	
Event Schedule List	Displays the schedules that you configure in the New Schedule area. To remove an event from the list, highlight it and click Delete .
New Schedule	
Effective Time Frame	Choose a day or range of days. If an event occurs during this time, and between the times that you configure in the following two fields, the IP camera takes the configured actions (sends an e-mail message, sends a relay through its output ports). If an event occurs outside of this time, the IP camera does not take any actions.
Start Time	Enter the start time for the effective time frame.
End Time	Enter the end time for the effective time frame.
Add button	Adds the schedule that is defined in the Effective Time Frame, Start Time, and End Time fields. You can add up to 10 schedules.
Clear button	Clears the values that are in the Effective Time Frame, Start Time, and End Time fields.
Trigger Event	
Enable	Check this check box to cause the IP camera to take configured actions when an event triggers. You configure these actions in the Actions field.
Triggered by	Choose the desired options to designate the events that trigger actions: <ul style="list-style-type: none"> • Input 1—Event is triggered when input port 1 on the IP camera changes state as configured by the Trigger Events When option in the Alarm I/O Ports window. • Input 2—Event is triggered when input port 2 on the IP camera changes state as configured by the Trigger Events When option in the Alarm I/O Ports window. • Motion Detection—Event is triggered when the camera detects motion, as described in the “Motion Detection Window” section on page 3-30.

Table 3-17 Event Window Options (continued)

Option	Description
Actions	<p>Choose the desired options to designate actions that the camera takes when events occur:</p> <ul style="list-style-type: none"> • E-Mail—Causes an e-mail message to be delivered to the SMTP server. The e-mail alerts users that an event has occurred, and may include a video file of the event and the URL of an FTP server from which users can download the video file. (For more information about e-mail messages, see the “Mail & FTP Window” section on page 3-28.) • FTP—Causes the video file to upload to the FTP server. (The FTP server must be configured as described in the “Mail & FTP Window” section on page 3-28.) • Alarm Output 1—Applies to output port 1 on the IP camera. Causes the output port state to be activated as configured. (For more information about output ports, see the “Alarm I/O Ports Window” section on page 3-35.) • Alarm Output 2—Applies to output port 2 on the IP camera. Causes the output port state to be activated as configured (For more information about output ports, see the “Alarm I/O Ports Window” section on page 3-35.) • Interval—Choose the amount of time, in minutes, that the camera waits after detecting a condition before it triggers an event. A setting of 0 indicates no delay.
Attachment	
<p>Note These Attachment options appear if you enable the Trigger Event option and choose the E-Mail or FTP option.</p>	
Overwrite/Replace oldest video file when SDRAM is full	<p>Check this check box to overwrite the oldest video file that is stored on the IP camera with the new video file when the SDRAM on the IP camera does not have enough room for the new file.</p> <p>If you do not check this option, the IP camera does not save new video files when its SDRAM does not have room for the files.</p>
Attachment Type	<p>Choose the type of file that is attached to an e-mail or FTP notification.</p> <ul style="list-style-type: none"> • JPEG Image—Attaches JPEG images from the event. • Video—Attaches a video file of the event.
Frame Rate	<p>Appears if you choose the JPEG Image option from the Attachment Type drop-down list.</p> <p>Choose the number of JPEG images that are captured per second during the event.</p>
Video Format (MPSG-4)	<p>Appears if you choose the Video option from the Attachment Type drop-down list.</p> <p>Choose the format (asf, mp4, or 3gp) for the video file of the event. If you choose mp4, or 3gp, video files do not include audio.</p>

Table 3-17 Event Window Options (continued)

Option	Description
Pre-Capture Length	Length, in seconds, of additional video that is included in the video file immediately before the event. The default value is 0 (no pre-capture video).
Post-Capture Length	Length, in seconds, of additional video that is included in the video file immediately after the event. The default value is 5.

SNMP Window

The SNMP window allows you to configure Simple Network Management Protocol (SNMP) settings for the IP camera. These settings can help you manage complex networks by sending messages to different devices on the network.

To display the SNMP window, access the configuration windows as described in the “[Accessing the IP Camera Windows](#)” section on page 2-6, click **Applications**, then click **SNMP**.

If you change any options in the SNMP window, you must click **Save** to save the changes. To discard the changes, click **Cancel** before clicking **Save**. These buttons appear at the bottom of the window. You may need to scroll down to see them.

[Table 3-18](#) describes the options in the SNMP window.

Table 3-18 SNMP Window Options

Option	Description
SNMP Enable	Check this check box to enable SNMP.
System Object ID	<i>Display only.</i> Displays the system object ID, which identifies system properties of the IP camera.
System Contact	Enter system contact information for the system administrator. For example, enter the e-mail address of the system administrator.
SysLocation	Enter system location information, which identifies the physical location of the IP camera.
Read Community String	Enter the SNMP read community string, which identifies the valid read community. The default value is public (all lower case).
Primary Trap Receiver	Enter the IP address of primary trap receiver of the SNMP manager.
Secondary Trap Receiver	Enter the IP address of secondary trap receiver of the SNMP manager.

Alarm I/O Ports Window

The Alarm I/O Ports window allows you to configure various options for the two input and two output ports on the IP camera. A state change of an input ports triggers a camera to take configured actions. Output ports send relays that can control external devices, such as alarms or door switches.

To display the Alarm I/O Ports window, access the configuration windows as described in the “[Accessing the IP Camera Windows](#)” section on page 2-6, click **Applications**, then click **I/O Ports**.

If you change any options in the Alarm I/O Ports window, you must click **Save** to save the changes. To discard the changes, click **Cancel** before clicking **Save**. These buttons appear at the bottom of the window. You may need to scroll down to see them.

Table 3-19 describes the options in the Alarm I/O Ports window.

Table 3-19 Alarm I/O Ports Window Options

Option	Description
Alarm Input Settings	
Current Status	<i>Display only.</i> For each input port on the IP camera, displays its current state (high or low).
Trigger Events When	For each input port on the IP camera, Input 1 and Input 2, choose the state (high or low) that triggers designated camera actions. When an IP port changes to this state, the camera determines that an event has occurred and takes actions as configured in the Trigger Event area in the Event Window.
Alarm Output Settings	
Current Status	<i>Display only.</i> For each output port on the IP camera, displays its current state (high or low).
Power On State	For each output port on the IP camera, Output 1 and Output 2, choose the state (low or high) that the port is set to when the IP camera powers on or is reset. The port changes to this state when you click Save . The default setting is High.
Event Action	For each output port on the IP camera, Output 1 and Output 2, choose the state that the port changes to when an event occurs. If you choose None, the port does not change states.
Manual Control Settings	
Definition Mappings	For each output port on the IP camera, Output 1 and Output 2, choose the state that the designated port changes to when you click the On or Off button in the Home window: <ul style="list-style-type: none"> • ON maps to High—Changes the state of the port to high when you click the On button, and changes the state of the port to low when you click the Off button. • ON maps to Low—Changes the state of the port to low when you click the On button, and changes the state of the port to high when you click the Off button. For related information, see the descriptions of the On and Off button in Table 4-1 on page 4-3 .

PTZ (RS-485) Window

The PTZ (RS-485) window allows you to enable pan, tilt, zoom (PTZ) functions for the IP camera. These functions require that the IP camera be installed with a motorized zoom/focus lens in a pan/tilt mount that supports the Pelco D protocol.

This window also provides options for configuring a patrol sequence, or *sequence*, for the IP camera. A sequence consists of up to 20 steps, each of which causes the camera to move to a designated position and remain in the position for 30 seconds.

To display the PTZ (RS-485) window, access the configuration windows as described in the [“Accessing the IP Camera Windows”](#) section on page 2-6, click **Applications**, then click **PTZ (RS-485)**.

If you change any options in the PTZ (RS-485) window, you must click **Save** to save the changes. To discard the changes, click **Cancel** before clicking **Save**. These buttons appear at the bottom of the window. You may need to scroll down to see them.

Table 3-20 describes the options in the PTZ (RS-485) window.

Table 3-20 PTZ (RS-485) Window Options

Option	Description
Enable External PTZ	Check this check box to enable configuration of the PTZ settings.
Port Settings	
Baud Rate	Choose the Baud rate value that is configured on the device that controls the PTZ functions of the IP camera.
Data Bits	Choose the data bits value that is configured on the device that controls the PTZ functions of the IP camera.
Parity	Choose the parity value that is configured on the device that controls the PTZ functions of the IP camera.
Stop Bits	Choose the stop bits value that is configured on the device that controls the PTZ functions of the IP camera.
Address	Enter the logical address of the external PTZ device. To determine this address, refer to the documentation for the device.
Preset Position	
Note The Preset Position option appears if you check the Enable External PTZ check box.	
Set Preset Position	Click the Set Preset Position button to define a preset position of the IP camera. When you click this button, the Set Pan/Tilt window appears. For detailed information about this window, see the “Preset Positions Window” section on page 3-37.

Table 3-20 PTZ (RS-485) Window Options (continued)

Option	Description
Patrol Sequence	
Patrol Sequence	<p>Configure the order in which the IP camera executes preset operations.</p> <p>The preset list contains up to 9 positions that you configure as described in the “Preset Positions Window” section on page 3-37. The Sequence list specifies the order in which the IP camera goes to each preset position when you execute a sequence. (To execute a sequence, use the Patrol Sequence button as described in the “Home Window Controls” section on page 4-3.)</p> <p>Each preset position in a sequence is called a <i>step</i>. A sequence can include up to 20 steps, so it can include the same preset position more than once. When the sequence executes, the IP camera goes to the first position in the Sequence list, then moves through each position in the list in order. It remains in each position for 30 seconds. It stops at the last position in the list.</p> <p>To create the preset sequence, click the first desired preset position in the Preset list and click Add >>. The preset position appears in the Sequence list. Repeat this procedure as needed to create the sequence.</p> <p>To remove a preset position from the Sequence list, choose the desired position and click Remove.</p>

Preset Positions Window

If you click the **Set Preset Position** button in the PTZ (RS-485) window, as described in the Set Preset Position row in [Table 3-20](#), the Preset window appears. This window displays the current video from the IP camera and provides options for configuring up to nine preset positions for the IP camera.

To use the options that are in this window, the IP camera must be installed with a motorized zoom/focus lens in a pan/tilt mount that supports the Pelco D protocol.

If you are prompted to install ActiveX controls when trying to access this window, follow the on-screen prompts to do so. ActiveX controls are required to see the video and the options.

If you change any options in the Preset window, you must click **Save** to save the changes. To exit this window, click **Back**.

[Table 3-21](#) describes the options in the Preset Positions window.

Table 3-21 Preset Positions Options





Option	Description
Zoom In button 	Use these buttons to control optical zooming for the IP camera.
Zoom Out button 	

Table 3-21 Preset Positions Options (continued)

Option	Description
Navigation Keys	Set the pan and tilt positions as follows: <ul style="list-style-type: none"> To pan the IP camera, use the left or right arrow buttons To tilt the IP camera, use the up or down arrow buttons To move the IP camera to its home position, click the Move Camera Home button, which is located in the middle of the group of arrow keys
Focus Far button 	Use these buttons to control focus settings for the IP camera.
Focus Near button 	
Set Home	Click the Set Home button to define the current IP camera position, zoom setting, and focus setting as its home position.
Preset List	Choose a name from this list to update this window with information that has been set for that preset position. To remove a preset position, choose it from this list and click Remove .
Preset Name	After positioning the IP camera by using the Navigation keys, add this position as a preset position by entering a name of up to 16 characters and clicking Add . After you click Save in the Set Pan/Tilt window, this preset name is available from the Preset List drop-down list in this window and on the Preset list in the PTZ (RS-485) window.
Pan Speed	Choose the relative speed for the IP camera panning action. Options range from 1 (slowest) to 10 (fastest).
Tilt Speed	Choose the relative speed for the IP camera tilting action. Options range from 1 (slowest) to 10 (fastest).

Status Windows

The Status windows provide options for viewing and managing a variety of system information.

The following sections describe the Applications windows in detail:

- [System Window, page 3-39](#)
- [Audio/Video Window, page 3-39](#)
- [Network Window, page 3-40](#)
- [Syslog & Log Window, page 3-41](#)
- [Video Log Window, page 3-46](#)

System Window

The System window displays information about the IP camera.

To display the System window, access the configuration windows as described in the “[Accessing the IP Camera Windows](#)” section on page 2-6, click **Status**, then click **System**.

To make sure that the System window shows the most current information, click the **Refresh** button.

[Table 3-22](#) describes the options in the System window. All options are for display only.

Table 3-22 System Window Options

Option	Description
System Status	
Firmware Version	Version of the firmware that is installed on the IP camera.
Hardware Version	Not used.
Sensor Firmware Version	Version of the sensor firmware that is installed by the factory on the IP camera.
MAC Address	MAC address of the IP camera.
Camera Name	Name of the IP camera, as configured in the Basic Setup window. For more information, see the “ Basic Setup Window ” section on page 3-5.
Description	Description of the IP camera, as configured in the Basic Setup window. For more information, see the “ Basic Setup Window ” section on page 3-5.
Date/Time	Current date and time of the IP camera. To set the date and time, see the “ Basic Setup Window ” section on page 3-5.
UDI	
Note The Unique Device Identifier (UDI) provides information about Cisco devices.	
Product Identifier	Cisco product ID of the IP camera.
Version Identifier	Not used.
Serial Number	Serial number of the IP camera.
Entity Name	Cisco top level assembly part number of the IP camera.
Product Description	Revision of the Cisco top level assembly part number.

Audio/Video Window

The Audio/Video window displays information about the audio and video streams from the IP camera. You configure audio options as described in the “[Audio Window](#)” section on page 3-24. You configure video options as described in the “[Video Window](#)” section on page 3-19.

To display the Audio/Video window, access the configuration windows as described in the “[Accessing the IP Camera Windows](#)” section on page 2-6, click **Status**, then click **Image**.

To make sure that the Audio/Video window shows the most current information, click the **Refresh** button.

[Table 3-23](#) describes the options in the Audio/Video window. All options are for display only.

Table 3-23 Audio/Video Window Options

Option	Description
MPEG-4 Settings 1	
Resolution	Image size of the primary video stream.
Image Quality	Image quality of the primary video stream.
Frame Rate	Frame rate of the primary video stream.
MPEG-4 Settings 2	
Note	These options appear if the Resolution setting for MPEG-4 Settings 1 in the Video window is lower than 720 x 480 for NTSC or 720 x 576 for PAL.
Resolution	Image size of the second video stream.
Image Quality	Image quality of the second video stream.
Frame Rate	Frame rate of the second video stream.
Audio Setting	
Note	This option appears if you configured the Enable Audio option in the Audio window.
Audio Setting	Displays the audio setting that is configured for the IP camera.

Network Window

The Network window displays information about various IP camera network settings and operations. You configure the settings as described in the “[Basic Setup Window](#)” section on page 3-5 and the “[Wireless Setup Window](#)” section on page 3-7.

To display the Network window, access the configuration windows as described in the “[Accessing the IP Camera Windows](#)” section on page 2-6, click **Status**, then click **Network**.

To make sure that the Network window shows the most current information, click the **Refresh** button.

[Table 3-24](#) describes the options in the Network window. All options are for display only.

Table 3-24 Network Window Options

Option	Description
Network	
Network Type	Type of network in use.
Connection Speed	<i>Wired model only.</i> Speed and type of the camera connection to the network.
IP Address	IP address of the IP camera.
Subnet Mask	Subnet mask that is associated with the IP address of the IP camera.
Gateway	IP address of the remote gateway that is used by the IP camera.
Primary DNS	IP address of the primary Domain Name Server (DNS).
Secondary DNS	IP address of the secondary DNS.
Wireless	
Note	These options apply to the wireless IP camera only.
SSID	Wireless SSID.

Table 3-24 Network Window Options (continued)

Option	Description
Channel	Wireless channel in use.
Connection Speed	Speed and type of the wireless IP camera connection to the network.
Security	Security setting for wireless connections.

Syslog & Log Window

The Syslog & Log window lets you manage the IP camera log file, which captures and stores information about the IP camera and its activities.

The IP camera captures the information that you specify and stores the log file in its internal SDRAM. If the SDRAM becomes full, the IP camera begins to overwrite existing information. To prevent this situation, configure the IP camera to send log information to a Syslog server and periodically clear log information from SDRAM manually by using the Clear Log option in the Syslog & Log window.



Note

The camera also maintains a video log file. For more information, see the [“Video Log Window” section on page 3-46](#).

To display the Syslog & Log window, access the configuration windows as described in the [“Accessing the IP Camera Windows” section on page 2-6](#), click **Status**, then click **Syslog & Log**.

[Table 3-25](#) describes the options in the Syslog & Log window.

Table 3-25 Syslog & Log Window Options

Option	Description
Local Log	
Minimum Log Severity	<p>Choose the minimum severity of messages that the appear in the log file. The system logs all messages of this severity and higher. Message severities, from highest to lowest, are:</p> <ul style="list-style-type: none"> • Emergency—The system is unusable. • Alert—A situation occurred that requires immediate action. • Critical—A situation occurred that requires action soon. • Error—An error occurred, but it does not necessarily affects the ability of the system to function. • Warning—A undesirable condition occurred. • Notice—Notification about a system condition that is not necessarily an error condition. • Informational—Information about a system activity. • Debug—Information about a system activity with detailed technical information. Includes messages of every other severity. <p>The default severity is Informational.</p>

Table 3-25 Syslog & Log Window Options (continued)

Option	Description
Sys Log Server	
Enable Syslog Server	<p>Check this check box to send the log information that you chose in the Log area to a designated server. The selected information also is maintained on the IP camera until you clear it or it is overwritten.</p> <p>This option is useful for consolidating logs in deployments with several IP cameras and for retaining logs when you clear them from the IP camera.</p>
Syslog Server Address	Enter the IP address of the Syslog server.
Syslog Port	<p>Enter the port number that receives the logs on the Syslog server.</p> <p>Valid values are 514 and 1024 through 65535. The default Syslog port is 514.</p>
Syslog Facility	Enter the system facility that receives logs on the Syslog server.
Minimum Log Severity	<p>Choose the minimum severity of messages that are sent to the Syslog server. The system sends all messages of this severity and higher. Message severities, from highest to lowest, are:</p> <ul style="list-style-type: none"> • Emergency—The system is unusable. • Alert—A situation occurred that requires immediate action. • Critical—A situation occurred that requires action soon. • Error—An error occurred, but it does not necessarily affects the ability of the system to function. • Warning—A undesirable condition occurred. • Notice—Notification about a system condition that is not an error condition. • Informational—Information about a system activity. • Debug—Information about a system activity with detailed technical information. Includes messages of every other severity. <p>The default severity is Informational.</p>
Log List	
Log List pane	<p>Displays information from the log type or types that you specified.</p> <p>For an explanation of each log message that can appear, see Table 3-26.</p>
Refresh	Click the Refresh button to update the information in the Log List pane.
Clear Log	Click the Clear Log button to delete all messages in the log file.

[Table 3-26](#) describes the messages that can appear in the IP camera log file. When you view the log file, each message includes the date and time that it was logged.

Table 3-26 Syslog and Log Information

Message	Explanation
System log messages.	
Note These messages appear if you enable the System Log option.	
Alert: Detected motion	Alert generated by the IP camera detecting motion in a configured video field.
Alert: Input Port <i>Port_Number</i> triggered.	Alert generated by the indicated port changing state.
Audio: Disable microphone.	Captures information when audio devices are enabled or disabled in the Audio window.
Audio: Disable speaker.	
Audio: Enable microphone. (audio type: G.711 A-Law)	
Audio: Enable microphone. (audio type: G.711 u-Law)	
Audio: Enable microphone. (audio type: G.726)	
Audio: Enable speaker.	
DHCP: Lease release successfully.	Provides information about DHCP activities in networks that include DHCP.
DHCP: Lease release unsuccessfully.	
DHCP: Lease renewal successfully.	
DHCP: Lease renewal unsuccessfully.	
DHCP: Timeout error when renewing DHCP lease.	
DST: Adjust DST <i>Number</i> hour automatically.	The IP camera has automatically adjusted its clock by the indicated number of hours for the beginning or end of daylight saving time.
DST: DST begin.	The IP camera has adjusted its clock for the beginning of daylight saving time.
DST: DST end.	The IP camera has adjusted its clock for the end of daylight saving time.
LOG: Clear all messages.	You have used the Clear Log button to delete the log file from the IP camera SDRAM.
LOG: Log file is full. Start to wrap around.	The IP camera SDRAM is full and existing log information is beginning to be overwritten.
Network: Failed to get the IP address. Camera set to default IP address.	IP camera is unable to obtain an IP address through DHCP and is set to the default IP address of 192.168.0.100.
Network: LAN activated.	IP camera obtained a network IP address.
Network: Wired link down.	Wired IP camera lost connection to the network.
Network: Wired link up.	Wired IP camera established connection to the network.
Network: Wireless activated.	Wireless IP camera successfully associated with an access point and obtained an IP address

Table 3-26 Syslog and Log Information (continued)

Message	Explanation
NTP: Failed to synchronize data & time with the NTP server.	Provides information when you configure the IP camera to obtains its time from an NTP server.
NTP: No NTP server specified.	
NTP: Synchronization OK.	
NTP: The NTP server cannot be reached.	
output: Failed to set output port <i>Port_Number</i> .	Provides information when you configure the output ports on the IP camera.
output: Set output port <i>Port_Number</i> to high OK.	
output: Set output port <i>Port_Number</i> to low OK.	
output: Set output port <i>Port_Number</i> to pulse OK.	
PTZ: Focus far.	A user clicked the Focus Far button in the Home window.
PTZ: Focus near.	A user clicked the Focus Near button in the Home window.
PTZ: Go to home.	A user clicked the Move Camera Home button in the Home window.
PTZ: Go to Preset <i>Position_Number</i> .	Provides information when you pan or tilt the IP camera or it move it to a preset position.
PTZ: Move down.	
PTZ: Move left.	
PTZ: Move right.	
PTZ: Move up.	
PTZ: Zoom in.	
PTZ: Zoom out.	
Sensor: Change from Day mode to Night mode.	
Sensor: Change from Night mode to Day mode.	The IP camera switched from night mode to day mode.
SSH: Invalid SSH login attempt. [ip: <i>Address</i>]	A user attempted to log in to the IP camera through SSH. <i>Address</i> is the IP address of the system that was used.
SSH: SSH user logged in. [ip: <i>Address</i>]	A user logged in to the IP camera through SSH. <i>Address</i> is the IP address of the system that was used.
SSH: SSH user logged out. [ip: <i>Address</i>]	A user logged out of the IP camera through SSH. <i>Address</i> is the IP address of the system that was used.
Stream: HTTP stream started. [id: <i>User</i> , ip: <i>Address</i>]	Provides information when a user accesses (HTTP stream started) or exits (HTTP stream stopped) the Home window. <i>User</i> is the IP camera user name of the user. <i>Address</i> is the IP address of the PC that was used.
Stream: HTTP stream stopped. [id: <i>User</i> , ip: <i>Address</i>]	

Table 3-26 Syslog and Log Information (continued)

Message	Explanation
Stream: RTSP stream started. [ip: <i>Type</i> , UDP: <i>Address_1:Port_1</i> -> <i>Address_2:Port_2</i> , <i>User</i>]	Provides information when an RTSP stream from the IP camera is initiated (RTSP stream started) or stopped (RTSP stream stopped). <i>Type</i> is the type of stream (Video or Audio). <i>Address_1:Port_1</i> are the IP address and port number of the IP camera. <i>Address_2:Port_2</i> are IP address and port number of the device that receives the stream. <i>User</i> is the IP camera user name of the user who started or stopped the stream.
Stream: RTSP stream stopped. [ip: <i>Type</i> , UDP: <i>Address_1:Port_1</i> -> <i>Address_2:Port_2</i> , <i>User</i>]	
successful admin user login.	A user with administrator privileges logged in to the IP camera.
successful view only user login.	A user with viewer privileges or monitor privileges logged in to the IP camera.
System: Cancel upgrade process	An IP camera administrator cancelled a firmware upgrade that was in process.
System: Invalid upgrade file	You are attempting to upgrade firmware for the IP camera but are using an invalid firmware file.
System: Reset to factory defaults.	Factory reset procedure performed for the IP camera.
Unsuccessful login attempt.	A user tried but was unable to log in to the IP camera.
Web: Invalid login attempt. [id: <i>User_ID</i> , ip: <i>Address</i>]	Provides information when someone logs in, or attempts to log in, to the IP camera.
Web: User logged in to web UI. [id: <i>User_ID</i> , ip: <i>Address</i>]	<i>User</i> is the IP camera user name of the user. <i>Address</i> is the IP address of the PC that was used.
Web: User logged out from web UI. [id: <i>User_ID</i> , ip: <i>Address</i>]	
Wireless: Link down by AP when receiving DeAuth.	Wireless IP camera cannot communicate with the access point.
Wireless: Link down by STA when changing SSID.	A user is changing the SSID for the wireless IP camera.
Wireless: Link down when losing BEACON.	Wireless IP camera cannot communicate with the access point because the access point is shutting down.
Wireless: Link up.	Wireless IP camera established connection to the access point.

Table 3-26 Syslog and Log Information (continued)

Message	Explanation
FTP log messages.	
Note These messages appear if you enable the FTP Log option.	
FTP: Error during the connection or timeout. [host: <i>Address</i>]	Provide information when the camera uploads a video file to the FTP server.
FTP: File uploading failed. [host: <i>Address</i>]	<i>Address</i> is the IP address of the FTP server.
FTP: File uploaded successfully. [host: <i>Address</i>]	
FTP: Login failed. [host: <i>Address</i>]	
FTP: No such remote path. [host: <i>Address</i>]	
FTP: Unknown FTP server. [host: <i>Address</i>]	
SMTP log messages.	
Note These messages appear if you enable the FTP Log option.	
SMTP: Error during the connection or timeout. [host: <i>Address</i>]	Provide information when the IP camera generates an e-mail alert and communicates with an SMTP server.
SMTP: Invalid sender address. [host: <i>Address</i>]	<i>Address</i> is the IP address of the SMTP server.
SMTP: POP before SMTP authentication failed. [host: <i>Address</i>]	
SMTP: Recipient address. [<i>Address</i>] rejected	
SMTP: Send E-mail OK.	
SMTP: SMTP authentication failed. [host: <i>Address</i>]	
SMTP: Unknown SMTP server. [host: <i>Address</i>]	

Video Log Window

The View Video Log window lets you manage video files. If the Trigger Event option is enabled in the Event window, the IP camera creates a video file for each event that it detects. The Video Log window lists each video file, and lets you view, download, or delete the files.

The IP camera stores video log files in its internal SDRAM. When the SDRAM becomes full, the IP camera stops storing additional video files or begins overwriting the oldest video files, depending on the setting of the **Overwrite/Replace oldest video file when SDRAM is full** option in the Event window. (See the “[Event Window](#)” section on page 3-31 for additional information.)

To prevent the SDRAM from becoming full, periodically delete video logs.

To display the View Video Log window, access the configuration windows as described in the “[Accessing the IP Camera Windows](#)” section on page 2-6, click **Status**, then click **View Video Log**.

[Table 3-27](#) describes the option in the View Video Log window.

Table 3-27 View Video Log Window Options

Option	Description
Video Log	<p>Displays a list of video logs. Files are named <i>Camera_name-Event_Name-yymmdd-hhmmss.xxx</i>, where:</p> <ul style="list-style-type: none"> • <i>Camera_name</i> is the name of the IP camera, as configured in the Camera Name field in the Basic Setup window. • <i>Event_name</i> describes the event that caused the alert. For motion detection events, this field is the name of the video field area in which motion was detected (for example, Window 2). For input events, this field is input1 or input2, depending on which input port the event was detected. • <i>yymmdd</i> is the 2-digit year, month, and date on which the event occurred. • <i>hhmmss</i> is the, hours, minutes, and seconds at which the event occurred. • <i>xxx</i> is the format of the file (asf, mp4, or 3gp), as configured in the Video Format (MPSG-4) field in the Event window. <p>An example file name is: CAM00194FFDFF66-Window 2-080213-012934.asf</p> <p>To view a video file, click its name. The file plays in the default media player on your PC. (If the video file does not play properly through an HTTPS connection, download it to your PC and open it in a media player.)</p> <p>To download a video file to your PC, right-click its name and follow the prompts to save it on your PC. You can then open the saved file in a media player.</p>
Delete button	Deletes the corresponding video file.
Delete All button	Deletes all video files in the Video Log window.



CHAPTER 4

Viewing Live Video

After you install and set up the Cisco Video Surveillance IP Camera as described in [Chapter 2, “Getting Started,”](#) users can connect to the IP camera through Internet Explorer and access the Home window to view live video from the IP camera.

The home window also provides for controlling the video display and certain IP camera functions. Available controls depend on the user type or privilege level. The IP camera administrator and users with the administrator or monitor privilege can access all controls in the Home window. IP camera users with the viewer privilege can access only the resolution, digital zoom, snapshot, speaker on/off, speaker volume, microphone on/off, and microphone volume controls. (For detailed information about user types and privileges, see the [“Users Window” section on page 3-16.](#))

You also can configure the IP camera to allow access to its video through a mobile device, or through the VLC media player or equivalent software.

This chapter includes these topics:

- [Viewing Video through the Home Window Overview, page 4-1](#)
- [Viewing Video through Third-Party Devices or Software, page 4-6](#)

Viewing Video through the Home Window Overview

To view live video, access the Home window as described in the [“Accessing the IP Camera Windows” section on page 2-6.](#) This window displays live video from the camera and lets you control a variety of camera and display functions.

Home Window Overview

[Figure 4-1](#) describes the main features of the Home window.



Note

The controls that you see in the Home window depend on your user type or privilege level and the configurations settings for the IP camera.

Figure 4-1 Home Window



1	Digital zoom factor. For information about digital zooming, see the “Home Window Controls” section on page 4-3 .
2	IP camera date and time. You configure the date and time for the IP camera as described in the “Basic Setup Window” section on page 3-5 .
3	Video display and audio controls. For detailed information, see the “Home Window Controls” section on page 4-3 .
4	Text that you configured to display for the IP camera. You configure this text in the Enable Text Display field in the Video window. For more information, see the “Video Window” section on page 3-19 .
5	Video from the IP camera.
6	Number of users who are accessing the camera through web browsers.
7	IP camera controls. For detailed information, see the “Home Window Controls” section on page 4-3 .

Home Window Controls

The Home window provides controls for several IP camera features. [Table 4-1](#) describes the controls in the Home window.



Note

The IP camera administrator and users with the administrator or monitor privilege can access all IP camera, video display, and audio controls. Users with the viewer privilege can access video display and audio controls only.

Table 4-1 Home Window Controls







Control	Description
IP camera controls	
Stream Option 	Selects the mode that the IP camera uses for video streaming. The options depend on the configuration of the Streaming Mode option in the Video window. For related information, see the “Video Window” section on page 3-19 .
Alarm Output On button 	Changes the state of the designated IP camera output port (1 or 2) as defined by the Definition Mappings option in the I/O Ports window. For information about the Definition Mappings option, see the “Alarm I/O Ports Window” section on page 3-35 .
Alarm Output Off button 	Changes the state of the designated IP camera output port (1 or 2) as defined by the Definition Mappings option in the I/O Ports window. For information about the Definition Mappings option, see the “Alarm I/O Ports Window” section on page 3-35 .
Preset Camera View drop-down list 	When you choose a preset position from this list, the camera immediately goes to that preset position. If the camera is executing a patrol sequence, choosing a preset position from this list cancels the sequence. This button appears only if you enabled external PTZ for the camera. For information about enabling external PTZ and configuring preset positions, see the “PTZ (RS-485) Window” section on page 3-36 .
Patrol Sequence button 	Click this button to execute the sequence that is configured for this IP camera. For information about configuring a sequence, see the “PTZ (RS-485) Window” section on page 3-36 .
Zoom Out button 	Use these buttons to control optical zooming. The optical zoom function requires that the IP camera be installed with a motorized zoom/focus lens in a pan/tilt mount that supports the Pelco D protocol and that PTZ functions are enabled. For more information, see the “PTZ (RS-485) Window” section on page 3-36 .
Zoom In button 	

Table 4-1 Home Window Controls (continued)











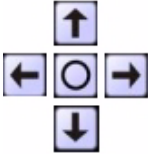



Control	Description
IP camera control buttons 	<p>To pan the IP camera, use the left or right arrow buttons.</p> <p>To tilt the IP camera, use the up or down arrow buttons.</p> <p>To move the IP camera to its home position, click the Move to Home button, which is located in the middle of the group of arrow keys.</p> <p>Pan and tilt functions require that the IP camera be installed with a pan/tilt mount that supports the Pelco D protocol and that PTZ functions are enabled. For more information, see the “PTZ (RS-485) Window” section on page 3-36.</p> <p>For information about configuring the home position, see the “Preset Positions Window” section on page 3-37.</p>
Focus far button 	<p>Use these buttons to adjust the focus of the IP camera.</p> <p>The focus function requires that the IP camera be installed with a motorized zoom/focus lens in a pan/tilt mount that supports the Pelco D protocol and that PTZ functions are enabled. For more information, see the “PTZ (RS-485) Window” section on page 3-36.</p>
Focus Near button 	
Day button 	<p>Improves video quality when the IP camera captures video in bright conditions.</p> <p>This button appears only if you configure the Day/Night Vision Switch Mode to Day or Night. For more information, see the “Video Window” section on page 3-19.</p>
Night button 	<p>Improves video quality when the IP camera captures video in dark conditions.</p> <p>This button appears only if you configure the Day/Night Vision Switch Mode to Day or Night. For more information, see the “Video Window” section on page 3-19.</p>
Video display and audio controls	
Resolution drop-down list 	<p>Selects resolution for the video display:</p> <ul style="list-style-type: none"> • AUTO—Resolution that is configured in the Resolution field in the Video window. For more information, see the “Video Window” section on page 3-19. • 720 x 480—D1 resolution. • 704 x 480—4CIF resolution. • 352 x 240—CIF resolution.
Digital Zoom button 	<p>Accesses the digital zoom feature, which enlarges the video image by 2 times or 4 times. To zoom the video image, follow these steps:</p> <ol style="list-style-type: none"> 1. Click the Digital Zoom button once for 2 times zooming or twice for 4 times zooming. The button changes to include a 2 or 4, which indicates the zoom factor. 2. Click the video image. The image resizes as indicated and the zoom factor (2X or 4X) appears in the upper left corner of the video display. <p>To return the video image to normal size, click the Digital Zoom button twice when in 2-times zoom mode or click it once when in 4-times zoom mode.</p>

Table 4-1 Home Window Controls (continued)

Control	Description
Snapshot button 	<p>Captures and saves a snapshot image of the current video image in the format and location of your choice, and with the file name of your choice.</p> <p>When you click this button, follow these steps to save the image:</p> <ol style="list-style-type: none"> 1. In the Snapshot window, click Save. 2. In the Save Picture As window, enter the path and folder for the image, the file name for the image, and the format (BMP or JPG) for the image, then click Save.
Speaker Off toggle button 	<p>Click the Speaker Off button to mute audio that is sent from the IP camera to the PC that you are using. The button changes to the Speaker On button. Click the Speaker On button to unmute audio. The button changes to the Speaker Off button.</p> <p>These buttons appear if audio is enabled for the IP camera. For information about enabling audio, see the “Audio Window” section on page 3-24.</p>
Speaker On toggle button 	
Speaker Volume slider 	<p>Appears to the right of the Speaker On or Speaker Off button if audio is enabled for the IP camera. When the speaker is unmuted, use this slider to adjust the volume at which your PC speakers play the audio from the IP camera.</p> <p>For information about enabling audio, see the “Audio Window” section on page 3-24.</p>
Microphone Off toggle button 	<p>Click the Microphone Off button to mute the audio stream that is captured and sent to the IP camera from the internal or external microphone of the PC that you are using. When you click this button, the speaker that is attached to the IP camera does not play audio that is transmitted from your PC.</p> <p>Note If you are simultaneously accessing other IP cameras in different browser sessions on the same PC, clicking this button in one browser session does not mute the audio that the PC sends to the other IP cameras.</p> <p>When you click the Microphone Off button, it changes to the Microphone On button. Click the Microphone On button to unmute audio that is sent to the IP camera. The button changes to the Microphone Off button.</p> <p>These buttons appear if half-duplex or full-duplex is enabled for audio. For information about enabling half-duplex or full-duplex, see the “Audio Window” section on page 3-24.</p>
Microphone On toggle button 	
Microphone Sensitivity slider 	<p>Appears to the right of the Microphone On button or Microphone Off button if audio is enabled for the IP camera. Use this slider to adjust the gain of the PC microphone (that is, how sensitive it is to the audio that it picks up and that is sent to the IP camera).</p>

Viewing Video through Third-Party Devices or Software

You can allow users to access video streams from the IP camera through third-party mobile devices, or through the VLC media player or equivalent software.

To do so, you must configure the RTSP Port option in the Advanced Setup window. This option enables the IP camera to receive Real-Time Streaming Protocol (RTSP) commands. For more information, see the “[Advanced Setup Window](#)” section on page 3-11.

To access a primary MPEG-4 stream, configure **Single MPEG-4 Stream**, **Dual MPEG-4 Streams**, or **Dual Streams (MPEG-4 + MJPEG)** for the Streaming Mode option in the Video window. These settings lets you enable a primary MPEG-4 video stream, which is useful for providing third-party devices. For more information, see the “[Video Window](#)” section on page 3-19.

To access a secondary MPEG-4 stream, configure **Dual MPEG-4 Streams** for the Streaming Mode option in the Video window. This setting lets you enable a secondary MPEG-4 video stream, which is useful for providing third-party devices or software with a video stream that is at a lower resolution than the primary stream. Some software and devices require this lower resolution, which is 352 x 240 for NTSC or 352 x 288 for PAL. For more information, see the “[Video Window](#)” section on page 3-19.

To access an MJPEG stream, configure **Single MJPEG Stream** or **Dual Streams (MPEG-4 + MJPEG)** for the Streaming Mode option in the Video window. This setting lets you enable an MJPEG video stream, which is useful for providing third-party devices. For more information, see the “[Video Window](#)” section on page 3-19

This section provides examples for how to access various video streams. For related information, see *Cisco Video Surveillance API Reference Guide*.

Accessing the Primary MPEG-4 Stream by using VLC Player

In the following commands, replace *username* with your IP camera user ID, replace *password* with your IP camera password, and replace *ip_address* with the IP address of the IP camera.

- To access the primary MPEG-4 stream with video and audio, enter either of these commands:

```
rtsp://username:password@ip_address/img/media.sdp
```

```
rtsp://username:password@ip_address/img/media.sav
```

- To access the primary MPEG-4 stream with video only, enter either of these commands:

```
rtsp://username:password@ip_address/img/video.sav
```

```
http://username:password@ip_address/img/video.asf
```

- To access the primary MPEG-4 stream with audio only, enter this command:

```
rtsp://username:password@ip_address/img/audio.sav
```

Accessing the Primary MPEG-4 Stream by using Devices or Software other than VLC Player

In the following commands, *ip_address* with the IP address of the IP camera. After you enter the command, enter your IP camera user name and password when prompted.

- To access the primary MPEG-4 stream with video and audio, enter either of these commands:

```
rtsp://ip_address/img/media.sdp
```

```
rtsp://ip_address/img/media.sav
```

- To access the primary MPEG-4 stream with video only, enter either of these commands:

```
rtsp://ip_address/img/video.sav
```

```
http://ip_address/img/video.asf
```

- To access the primary MPEG-4 stream with audio only, enter this command:

```
rtsp://ip_address/img/audio.sav
```

Accessing the Secondary MPEG-4 Stream by using VLC Player

In the following commands, replace *username* with your IP camera user ID, replace *password* with your IP camera password, and replace *ip_address* with the IP address of the IP camera.

- To access the secondary MPEG-4 stream with video and audio, enter either of these commands:

```
rtsp://username:password@ip_address/img/media2.sdp
```

```
rtsp://username:password@ip_address/img/media2.sav
```

- To access the secondary MPEG-4 stream with video only, enter either of these commands:

```
rtsp://username:password@ip_address/img/video2.sav
```

```
http://username:password@ip_address/img/video2.asf
```

- To access the secondary MPEG-4 stream with audio only, enter this command:

```
rtsp://username:password@ip_address/img/audio2.sav
```

Accessing the Secondary MPEG-4 Stream by using Devices or Software other than VLC Player

In the following commands, *ip_address* with the IP address of the IP camera. After you enter the command, enter your IP camera user name and password when prompted.

- To access the secondary MPEG-4 stream with video and audio, enter either of these commands:

```
rtsp://ip_address/img/media2.sdp
```

```
rtsp://ip_address/img/media2.sav
```

- To access the secondary MPEG-4 stream with video only, enter either of these commands:

```
rtsp://ip_address/img/video2.sav
```

```
http://ip_address/img/video2.asf
```

- To access the secondary MPEG-4 stream with audio only, enter this command:

```
rtsp://ip_address/img/audio2.sav
```

Accessing the MJPEG Stream by using VLC Player

In the following commands, replace *username* with your IP camera user ID, replace *password* with your IP camera password, and replace *ip_address* with the IP address of the IP camera.

- To access the MJPEG stream with video and audio, enter either of these commands:

```
rtsp://username:password@ip_address/img/jpgmedia.sdp
```

```
rtsp://username:password@ip_address/img/jpgmedia.sav
```

- To access the MJPEG stream with video only, enter either of these commands:

```
rtsp://username:password@ip_address/img/jpgvideo.sav
```

```
http://username:password@ip_address/img/video.mjpeg
```

Accessing the MJPEG Stream by using Devices or Software other than VLC Player

In the following commands, *ip_address* with the IP address of the IP camera. After you enter the command, enter your IP camera user name and password when prompted.

To access the MJPEG stream with video and audio, enter either of these commands:

rtsp://ip_address/img/jpgmedia.sdp

rtsp://ip_address/img/jpgmedia.sav

- To access the MJPEG stream with video only, enter this command:

rtsp://ip_address/img/jpgvideo.sav



CHAPTER 5

Troubleshooting

This chapter describes some common problems that may be encountered while using the IP camera and provides possible solutions.

Symptom Cannot connect to an IP camera through a web browser.

Possible Cause You are not using a supported PC operating system or web browser, you entered an incorrect IP address for the IP camera, the PC that you are using is not on the same LAN as the IP camera, you are entering an invalid port number for an HTTP or HTTPS connection, or you are trying to access the IP camera from a device with an IP address that is restricted from access.

Recommended Action Make sure that you are using a PC that is running Microsoft Windows 2000, XP, or Vista and that you are using Internet Explorer 6.x with Service Pack 2, or later. Make sure that you enter the correct IP address. If you are connecting through a LAN, make sure that the PC is on the same network as the IP camera. If you are connecting through the Internet, make sure to enter the correct port number. Make sure that the device does not have an IP address that is restricted from access (see the [“IP Filter Window”](#) section on page 3-14.)

Symptom Cannot connect to the IP camera by using a wireless connection.

Possible Cause The wireless interface may be disabled, or wireless settings may not be properly configured.

Recommended Action If a network cable is connected to the IP camera, power down the IP camera, remove the cable, then power up the camera. Make sure that wireless settings are configured as described in the [Wireless Setup Window](#), page 3-7.

Symptom Cannot log in to the IP camera as the administrator.

Possible Cause You are entering the log in credentials incorrectly or have forgotten the administrator password.

Recommended Action The administrator user name is **admin** and the password is the one that you configured. Both credentials are case sensitive, so make sure to enter them exactly as they are configured. If you forget the administrator password, you must perform a factory reset as described in the [“Resetting the IP Camera”](#) procedure on page 2-9, then reconfigure the IP camera. If you take these actions, do not use the Upload option in the Maintenance window to reload a saved configuration file because that process restores the password that you forgot.

Symptom Configuration windows do not display when you click the **Setup** link in the Main window.

Possible Cause You or another user recently exited the configuration windows by exiting a browser without first clicking the **Logout** button. In this case, it can take up to 2 minutes before the configuration windows become available.

Recommended Action Wait 2 minutes and try again.

Symptom The motion detection feature does not send e-mail alerts.

Possible Cause The e-mail alert feature is not properly configured or the SMTP server that the IP camera uses to send the e-mail may be filtering e-mail to prevent spam from being sent from your server.

Recommended Action Configure e-mail alerts as described in the [“Basic Setup Window” section on page 3-5](#), the [“Mail & FTP Window” section on page 3-28](#), and the [“Event Window” section on page 3-31](#). Try using a different SMTP server or contact your ISP to see if SMTP access is being blocked.

Symptom The motion detection feature is configured but video files that are provided in e-mail alerts do not show moving objects.

Possible Cause The motion detection feature does not actually detect motion. It compares frames to see if they are different. Major differences between frames are assumed to be caused by moving objects, but the motion detector can also be triggered by sudden changes in light level or movement of the IP camera itself.

Recommended Action Try to avoid situations with sudden changes in light level and do not bump or move the IP camera. The motion detection feature works best when the IP camera is mounted securely in locations where there is steady. This feature may not work properly if the IP camera is outdoors.

Symptom Blurry images when viewing video.

Possible Cause The lens may be dirty, back focus may not be adjusted properly, or video settings may not be configured for optimal clarity.

Recommended Action Clean the lens on the IP camera. Adjust the back focus as described in the [“Adjusting Back Focus on the IP Camera” section on page 2-8](#). Configure options for video as described in the [“Video Window” section on page 3-19](#).



APPENDIX **A**

Using the IP Camera with Cisco VSM

Cisco Video Surveillance Manager (VSM) is a suite of powerful and flexible video surveillance applications that interoperate with a wide range of devices and cameras to provide a complete, standards-based video surveillance solution. VSM consists of modules to manage, archive, view, and distribute video.

The following guidelines apply when you use the IP camera with VSM:

- Obtaining the Required Driver Pack

To use the IP camera with VSM, you must download and install a driver pack. For information about this driver pack, refer to your VSM documentation, which is available here:

<http://www.cisco.com/web/solutions/ps/products.html#netcentric>

- The IP camera must be installed and configured as described in [Chapter 2, “Getting Started.”](#)
- You must create a separate user account with administrator privileges for each Media Server. Configuration connections for a Media Server are limited just as they are for user sessions. Viewing and managing video streams from VSM requires administrator-level privileges.

For information about how to configure a user account, see the [“Video Window” section on page 3-19.](#)

- A user with administrator privileges cannot be logged in to the IP camera and use VSM at the same time
- Cisco recommends that you configure video resolution (NTSC or PAL) from the IP camera configuration windows.

For instructions, see the [“Video Window” section on page 3-19.](#)



INDEX

A

action

- configuring [3-33](#)
- overview [3-31](#)
- triggered by event [3-31](#)

ActiveX controls [3-30](#)

activity indication [1-3](#)

Activity LED [1-3](#)

Administration windows [3-15](#)

Administrator user type

- configuring [3-16](#)
- description [3-16](#)
- password
 - recovering [5-1](#)
 - setting [3-16, 3-27](#)
- user name [3-16](#)

Advanced Setup window

- options [3-11](#)
- overview [3-11](#)

Alarm I/O Ports window

- options [3-35](#)
- overview [3-35](#)

analog video display [2-3](#)

antenna [1-4](#)

Applications windows [3-28](#)

audio

- codec [3-25](#)
- enabling [3-25](#)
- full duplex [3-25](#)
- half duplex [3-25](#)
- overview [3-24](#)
- simplex [3-25](#)

Audio/Video windows [3-19](#)

Audio window

- options [3-25](#)
- overview [3-24](#)

authentication, for wireless IP camera [3-9](#)

auto, day/night vision switch mode [3-23](#)

B

back focus

- adjusting [2-8](#)
- focus ring [2-8](#)

backing up, configuration of IP camera [3-17](#)

Basic Setup window

- options [3-6](#)
- overview [3-5](#)

Baud rate, for PTZ [3-36](#)

bit rate, of video [3-20](#)

Bonjour, enabling on camera [3-11](#)

brightness, of video [3-22](#)

C

camera

See IP camera

CDP (Cisco Discovery Protocol), enabling on camera [3-11](#)

Cisco Video Surveillance IP Camera

See IP camera

Cisco Video Surveillance Manager (VSM), using IP camera with [1-1](#)

cleaning, IP camera [2-10](#)

C mount lens [1-3, 2-2](#)

codec, for audio [3-25](#)

- Complexity window
 - options [3-27](#)
 - overview [3-27](#)
 - configuration
 - guidelines [3-1](#)
 - overview [3-1](#)
 - requirements [3-1](#)
 - configuration, of IP camera
 - backing up [3-17](#)
 - copying to camera [3-17](#)
 - saving [3-17](#)
 - uploading [3-17](#)
 - configuration file
 - saving [3-18](#)
 - uploading [3-18](#)
 - configuration windows
 - accessing [2-6](#)
 - Administration windows [3-15](#)
 - Advanced Setup window [3-11](#)
 - Alarm I/O Ports window [3-35](#)
 - Applications windows [3-28](#)
 - Audio/Video windows [3-19](#)
 - Audio window [3-24](#)
 - Basic Setup window [3-5](#)
 - Complexity window [3-27](#)
 - EAPOL window [3-14](#)
 - Event window [3-31](#)
 - Firmware window [3-19](#)
 - Image window [3-39](#)
 - Initialization window [3-27](#)
 - IP Filter window [3-14](#)
 - Mail & FTP window [3-28](#)
 - Maintenance window [3-17](#)
 - Motion Detection window [3-30](#)
 - navigating [3-4](#)
 - Network window [3-40](#)
 - options [3-4](#)
 - overview [3-1](#)
 - Preset Positions window [3-37](#)
 - Product Process window [3-26](#)
 - PTZ (RS-485) window [3-36](#)
 - Security windows [3-26](#)
 - Setup windows [3-5](#)
 - SNMP window [3-34](#)
 - Status windows [3-38](#)
 - Syslog& Log window [3-41](#)
 - System window [3-39](#)
 - time out [3-1](#)
 - Users window [3-16](#)
 - Video Log window [3-46](#)
 - Video window [3-19](#)
 - Wireless Setup window [3-7](#)
 - connecting, to the IP camera
 - after the first time [2-6](#)
 - for the first time [2-5](#)
 - PC requirements for [2-5, 2-6](#)
 - secure connection [2-7](#)
 - contrast, of video [3-22](#)
 - control device, installing [2-3](#)
 - CS mount lens [1-3, 2-2](#)
-
- D**
- data bits, for PTZ [3-36](#)
 - date and time
 - of IP camera [3-6](#)
 - update through NTP server [3-6](#)
 - day, day/night vision switch mode [3-23](#)
 - day/night vision
 - schedule times [3-24](#)
 - switch mode [3-23](#)
 - threshold [3-24](#)
 - validation time [3-23](#)
 - Day button [4-4](#)
 - daylight saving time, adjustment for [3-6](#)
 - DC auto iris lens
 - connecting [1-3](#)
 - connector pinouts [1-6](#)

description, for IP camera [3-6](#)
 DHCP, obtaining IP address through [2-5, 2-9, 3-7](#)
 DNS server
 primary [3-7, 3-40](#)
 secondary [3-7, 3-40](#)
 DSCP, for QoS [3-13](#)
 dual streaming [3-19, 4-6](#)

E

EAP-FAST [3-10](#)
 EAPOL window
 options [3-15](#)
 overview [3-14](#)
 EAP-TLS [3-10](#)
 e-mail notification
 configuring [3-29](#)
 enabling [3-33](#)
 From field [3-29](#)
 FTP server link [3-28, 3-30](#)
 log file [3-46](#)
 of event [3-28](#)
 primary FTP server [3-30](#)
 recipients list [3-29](#)
 secondary FTP server [3-30](#)
 Subject field [3-29](#)
 video file attachment [3-28](#)
 end time, day/night vision schedule [3-24](#)
 event
 actions [3-31](#)
 configuring [3-32](#)
 enabling trigger [3-32](#)
 interval before triggering [3-33](#)
 notification of [3-28](#)
 overview [3-28, 3-31](#)
 scheduling [3-32](#)
 trigger types [3-32](#)
 video of [3-28](#)
 Event window

options [3-32](#)
 overview [3-31](#)

F

factory default configurations, restoring [3-18](#)
 factory reset [2-9](#)
 firmware
 upgrading [3-19](#)
 version in IP camera [3-19, 3-39](#)
 Firmware window
 options [3-19](#)
 overview [3-19](#)
 focus
 back focus [2-8](#)
 configuring [3-38](#)
 controlling [4-4](#)
 FTP log
 description [3-46](#)
 FTP server
 enabling uploading video file to [3-33](#)
 link to in notification e-mail [3-28, 3-30](#)
 log of upload activities [3-46](#)
 primary [3-30](#)
 secondary [3-30](#)
 full duplex [3-25](#)

G

gateway, for IP camera [3-7, 3-40](#)
 General purpose input/output (GPIO) port [1-5](#)

H

half duplex [3-25](#)
 hardware version, of IP camera [3-39](#)
 Home link, in Main window [2-6, 2-7](#)
 home position

- configuring [3-38](#)
 - moving camera to [4-4](#)
 - Home window
 - accessing [2-6](#)
 - controls in [4-3](#)
 - figure [4-2](#)
 - overview [4-1](#)
 - HTTP
 - accessing camera through [2-7](#)
 - allowing access through [2-5, 3-27](#)
 - alternative port [3-12](#)
 - default port [3-12](#)
 - HTTPS
 - accessing camera through [2-7](#)
 - alternative port [3-12](#)
 - default port [3-12](#)
-
- I/O ports
 - See* input ports, *and see* output ports
 - Image window
 - options [3-40](#)
 - overview [3-39](#)
 - Initialization window
 - options [3-27](#)
 - overview [3-27](#)
 - input device, connecting [2-3](#)
 - input ports
 - connecting devices to [2-3](#)
 - event trigger state [3-35](#)
 - on IP camera [1-5](#)
 - state change [3-31](#)
 - installing
 - analog video display [2-3](#)
 - control device [2-3](#)
 - external microphone [2-3](#)
 - IP camera [2-1](#)
 - speaker [2-3](#)
 - IP address
 - controlling access by [3-14](#)
 - default for IP camera [2-5, 2-6, 2-7](#)
 - fixed [3-7](#)
 - obtaining from DCHP server [2-5](#)
 - obtaining from DHCP server [2-9](#)
 - obtaining through DHCP [2-9, 3-7](#)
 - of IP camera [3-7, 3-40](#)
 - IP camera
 - accessing through a web browser [2-5, 2-6](#)
 - back focus of [2-8](#)
 - cleaning [2-10](#)
 - configuration file [3-18](#)
 - connecting to after the first time [2-6](#)
 - connecting to for the first time [2-5](#)
 - controlling access to [3-14](#)
 - date and time of [3-6](#)
 - DC auto iris lens connector pinouts [1-6](#)
 - description [1-2, 3-6](#)
 - firmware [3-19](#)
 - focus [2-8, 4-4](#)
 - General purpose input/output (GPIO) port [1-5](#)
 - home position [3-38](#)
 - I/O ports on [3-35](#)
 - installation [2-1](#)
 - IP address [3-7, 3-40](#)
 - LAN port on [1-4](#)
 - lens [1-3, 2-2](#)
 - locking down [2-4](#)
 - mounting [2-4](#)
 - name [3-6](#)
 - overview [1-1](#)
 - package contents [1-6](#)
 - panning [4-4](#)
 - power connection [1-5](#)
 - powering off [2-8](#)
 - powering on [2-8](#)
 - resetting [1-4](#)
 - restarting [3-18](#)

- restoring factory default configurations [3-18](#)
- SDRAM [3-33, 3-41, 3-46](#)
- serial number [3-39](#)
- tilting [4-4](#)
- time zone [3-6](#)
- troubleshooting [5-1](#)
- Unique Device Identifier (UDI) [3-39](#)
- user types [3-16](#)
- windows [2-6](#)
- zoom
 - digital [4-4](#)
 - optical [3-38, 4-3](#)

IP Filter window

- options [3-14](#)
- overview [3-14](#)

K

- Kensington lockdown equipment [2-4](#)

L

- LAN port [1-4](#)

LED

- Activity [1-3](#)
- controlling operation of [3-6](#)
- disabling [3-6](#)
- enabling [3-6](#)
- Network [1-4](#)
- PoE [1-4](#)
- Ready [1-3](#)

lens

- attaching to IP camera [2-2](#)
- C mount [2-2](#)
- CS mount [2-2](#)
- DC auto iris [1-3, 2-3](#)
- for IP camera [1-3](#)
- type [1-3](#)

live video

- controlling through Home window [4-1](#)
- viewing
 - through Home window [4-3](#)
 - through home window [4-1](#)
 - through third-party device or software [4-1](#)
- See also* video

- lockdown, IP camera [2-4](#)

log

- FTP [3-46](#)
- SMTP [3-46](#)
- system [3-43](#)

log file

- clearing [3-42](#)
- storage of [3-41](#)
- video [3-46](#)
- viewing [3-42](#)

- logical address, for PTZ controller [3-36](#)

- Logout button, in Main window [2-6, 2-7](#)

M

- MAC address, of IP camera [3-39](#)

Mail & FTP window

- options [3-29](#)
- overview [3-28](#)

Maintenance window

- options [3-18](#)
- overview [3-17](#)

Main window

- description [2-6, 2-7](#)
- Home link [2-6, 2-7](#)
- Logout button [2-6, 2-7](#)
- Setup link [2-6, 2-7](#)

microphone

- enabling [3-25](#)
- external [1-5, 3-24](#)
- installing external [2-3](#)
- internal [1-3, 3-24](#)

- muting PC [4-5](#)
- on camera [1-3](#)
- PC [4-5](#)
- sensitivity of PC [4-5](#)
- mixed mode [3-8](#)
- mobile device, viewing video through [4-6](#)
- motion detection
 - custom area [3-31](#)
 - event trigger [3-32](#)
 - overview [3-30](#)
 - triggers [3-31](#)
- Motion Detection window
 - options [3-31](#)
 - overview [3-30](#)
- mounting, IP camera [2-4](#)
- multicast
 - audio address [3-13](#)
 - audio port [3-13](#)
 - enabling [3-13](#)
 - video address [3-13](#)
 - video port [3-13](#)
- muting
 - PC microphone [4-5](#)
 - PC speaker [4-5](#)

N

- name, of IP camera [3-6, 3-39](#)
- network
 - activity [1-4](#)
 - type [3-40](#)
 - viewing information about [3-40](#)
- Network LED [1-4](#)
- Network window
 - options [3-40](#)
 - overview [3-40](#)
- night, day/night vision switch mode [3-23](#)
- Night button [4-4](#)
- night schedule, day/night vision switch mode [3-23](#)

O

- output device, connecting [2-3](#)
- output ports
 - activating when event occurs [3-33](#)
 - changing state [4-3](#)
 - connecting devices to [2-3](#)
 - on IP camera [1-5](#)
 - power on state [3-35](#)
 - state change [3-35](#)

P

- package contents [1-6](#)
- pan, tilt, zoom
 - See* PTZ
- panning [4-4](#)
- pan speed [3-38](#)
- parity, for PTZ [3-36](#)
- password
 - complexity [3-27](#)
 - configuring requirements for [3-27](#)
 - for Administrator user type [3-16, 3-27](#)
 - for primary FTP server [3-30](#)
 - for primary SMTP server [3-29](#)
 - for RADIUS server [3-10](#)
 - for secondary FTP server [3-30](#)
 - for secondary SMTP server [3-29](#)
 - for User user type [3-17](#)
 - hardening [3-27](#)
 - requirements for [2-5, 3-16, 3-17](#)
 - root [3-27](#)
- patrol sequence
 - See* sequence
- pinouts, for DC auto iris lens connector [1-6](#)
- PoE LED [1-4](#)
- port number [2-6](#)
- power
 - indication [1-3](#)

- port for power adapter [1-5](#)
- powering off the IP camera [2-8](#)
- powering on the IP camera [2-8](#)
- Power over Ethernet (PoE) [2-1](#)
- terminal block [2-4](#)
- power adapter
 - connecting [2-4](#)
 - supported [2-1](#)
- Power over Ethernet (PoE) [1-4, 2-1](#)
- preset list [3-37, 3-38](#)
- preset position
 - configuring [3-36](#)
 - moving IP camera to [4-3](#)
- Preset Positions window
 - options [3-37](#)
 - overview [3-37](#)
- privilege level, for users [3-17](#)
- processes
 - descriptions [3-26](#)
 - stopping [3-26](#)
- Product Process window
 - options [3-26](#)
 - overview [3-26](#)
- PTZ
 - Baud rate [3-36](#)
 - configuring [3-36](#)
 - data bits [3-36](#)
 - enabling external control of [3-36](#)
 - logical address of controlling device [3-36](#)
 - pan speed [3-38](#)
 - parity [3-36](#)
 - stop bits [3-36](#)
 - tilt speed [3-38](#)
- PTZ (RS-485) window
 - options [3-36](#)
 - overview [3-36](#)

Q

- Quality of Service (QoS), enabling [3-13](#)

R

- Ready LED [1-3](#)
- rebooting, IP camera [2-9](#)
- region, for wireless IP camera [3-10, 3-11](#)
- reset
 - factory default values [2-9](#)
 - IP address [2-9](#)
- Reset button [1-4](#)
- resetting the IP camera [1-4](#)
- resolution
 - See* video, resolution
- restarting, IP camera [3-18](#)
- restoring, factory default configurations [3-18](#)
- root password [3-27](#)
- RTP data port [3-12](#)
- RTSP port [3-12](#)

S

- saturation, of video [3-22](#)
- scheduling, events [3-32](#)
- SDRAM [3-33, 3-41, 3-46](#)
- secure connection [2-7](#)
- security
 - authentication, for wireless IP camera [3-9](#)
 - controlling processes [3-26](#)
 - for wireless IP camera [3-8](#)
 - mixed mode [3-8](#)
 - mode for wireless IP camera [3-8](#)
 - password hardening [3-27](#)
 - protocol type [3-10](#)
 - shared key [3-9](#)
 - stopping processes [3-26](#)
 - WEP encryption [3-8](#)

- WEP key [3-9](#)
- WEP options for wireless IP camera [3-8](#)
- WPA/WPA2 enterprise mode options [3-10](#)
- WPA/WPA2 personal mode options [3-9](#)
- Security windows [3-26](#)
- sensitivity
 - PC microphone [4-5](#)
- sensor firmware version, of IP camera [3-39](#)
- sequence
 - executing [4-3](#)
 - overview [3-36, 3-37](#)
 - Preset list [3-37](#)
 - steps [3-37](#)
- serial number [3-39](#)
- Setup link, in Main window [2-6, 2-7](#)
- Setup windows [3-5](#)
- shared key [3-9](#)
- sharpness, of video [3-22](#)
- simplex [3-25](#)
- SMTP log
 - description [3-46](#)
- SMTP server
 - configuring for e-mail notification [3-29](#)
 - primary [3-29](#)
 - secondary [3-29](#)
- snapshot, of video image [4-5](#)
- SNMP, configuring [3-34](#)
- SNMP window
 - options [3-34](#)
 - overview [3-34](#)
- speaker
 - enabling [3-25](#)
 - external [1-5, 3-24](#)
 - installing [2-3](#)
- SSH, allowing access through [3-27](#)
- start time, day/night vision schedule [3-24](#)
- Status windows [3-38](#)
- steps, in a sequence [3-37](#)
- stop bits, for PTZ [3-36](#)

- subnet mask, of IP camera [3-7](#)
- switch mode [3-23](#)
- Syslog [3-41](#)
- Syslog & Log window
 - options [3-41](#)
 - overview [3-41](#)
- Syslog server [3-42](#)
- system log
 - description [3-43](#)
- System window
 - options [3-39](#)
 - overview [3-39](#)

T

- terminal block [2-4](#)
- text overlay, on video [3-23](#)
- tilting [4-4](#)
- tilt speed [3-38](#)
- time out, of configuration windows [3-1](#)
- time stamp, on video [3-23](#)
- time zone, of IP camera [3-6](#)
- trigger, for event [3-32](#)
- troubleshooting
 - administrator password recovery [5-1](#)
 - alerts [5-2](#)
 - cannot access IP camera through browser [5-1](#)
 - motion detection [5-2](#)
 - wireless connection [5-1](#)
- TX key [3-8](#)

U

- Unique Device Identifier (UDI) [3-39](#)
- upgrading firmware [3-19](#)
- user name
 - for Administrator user type [3-16](#)
 - requirements for [3-16](#)

Users window

- options [3-16](#)
- overview [3-16](#)

user type

- Administrator [3-16](#)
- configuring [3-16](#)
- privilege level [3-17](#)
- User [3-16](#)

User user type

- configuring [3-16](#)
- description [3-16](#)
- password [3-17](#)

V

video

- analog display, installing [2-3](#)
 - bit rate [3-20](#)
 - brightness [3-22](#)
 - contrast [3-22](#)
 - format [3-22](#)
 - frame rate [3-21, 3-40](#)
 - image, viewing information about [3-39](#)
 - image quality [3-40](#)
 - of event [3-28](#)
 - primary stream [3-19, 3-20, 4-6](#)
 - quality [3-20](#)
 - resolution [3-20, 3-40, 4-4](#)
 - saturation [3-22](#)
 - secondary stream [3-19, 3-21, 4-6](#)
 - sharpness [3-22](#)
 - stream 1 settings [3-20](#)
 - stream 2 settings [3-21](#)
 - text overlay [3-23](#)
 - time stamp on [3-23](#)
 - viewing live
 - through Home window [4-1, 4-3](#)
 - through third-party device or software [4-1](#)
- See also* live video

video file

- deleting [3-47](#)
- description [3-46](#)
- displaying [3-47](#)
- duration [3-28](#)
- e-mail attachment [3-28](#)
- file name description [3-28, 3-47](#)
- format [3-33](#)
- managing [3-47](#)
- overwriting [3-33](#)
- post-capture length [3-34](#)
- pre-capture length [3-34](#)
- saving [3-33](#)
- storage of [3-46](#)
- viewing [3-47](#)

Video Log window

- deleting files in [3-47](#)
- downloading files in [3-47](#)
- options [3-47](#)
- overview [3-46](#)
- viewing files in [3-47](#)

Video window

- options [3-20](#)
- overview [3-19](#)

VLC media player, viewing video through [4-6](#)

volume

- of audio from camera [4-5](#)
- of PC microphone [4-5](#)
- of PC speaker [4-5](#)

W

WEP

- encryption [3-8](#)
- key [3-9](#)

white balance, preset modes [3-22](#)wired mode [2-9](#)

wireless IP camera

- channel [3-41](#)

region [3-10](#), [3-11](#)

security [3-41](#)

SSID [2-4](#), [3-8](#), [3-40](#)

wired mode [2-9](#)

wireless mode [2-9](#)

wireless mode [2-9](#)

Wireless Setup window

options [3-8](#)

overview [3-7](#)

Z

zoom

digital [4-4](#)

optical [3-37](#), [4-3](#)

Free Manuals Download Website

<http://myh66.com>

<http://usermanuals.us>

<http://www.somanuals.com>

<http://www.4manuals.cc>

<http://www.manual-lib.com>

<http://www.404manual.com>

<http://www.luxmanual.com>

<http://aubethermostatmanual.com>

Golf course search by state

<http://golfingnear.com>

Email search by domain

<http://emailbydomain.com>

Auto manuals search

<http://auto.somanuals.com>

TV manuals search

<http://tv.somanuals.com>