



## **Cisco 860 Series, Cisco 880 Series, and Cisco 890 Series Integrated Services Routers Hardware Installation Guide**

**Cisco Systems, Inc.**  
[www.cisco.com](http://www.cisco.com)

Cisco has more than 200 offices worldwide.  
Addresses, phone numbers, and fax numbers  
are listed on the Cisco website at  
[www.cisco.com/go/offices](http://www.cisco.com/go/offices).

Text Part Number: OL-16215-11  
Last Revised: December 10, 2013

THE SPECIFICATIONS AND INFORMATION REGARDING THE PRODUCTS IN THIS MANUAL ARE SUBJECT TO CHANGE WITHOUT NOTICE. ALL STATEMENTS, INFORMATION, AND RECOMMENDATIONS IN THIS MANUAL ARE BELIEVED TO BE ACCURATE BUT ARE PRESENTED WITHOUT WARRANTY OF ANY KIND, EXPRESS OR IMPLIED. USERS MUST TAKE FULL RESPONSIBILITY FOR THEIR APPLICATION OF ANY PRODUCTS.

THE SOFTWARE LICENSE AND LIMITED WARRANTY FOR THE ACCOMPANYING PRODUCT ARE SET FORTH IN THE INFORMATION PACKET THAT SHIPPED WITH THE PRODUCT AND ARE INCORPORATED HEREIN BY THIS REFERENCE. IF YOU ARE UNABLE TO LOCATE THE SOFTWARE LICENSE OR LIMITED WARRANTY, CONTACT YOUR CISCO REPRESENTATIVE FOR A COPY.

The following information is for FCC compliance of Class A devices: This equipment has been tested and found to comply with the limits for a Class A digital device, pursuant to part 15 of the FCC rules. These limits are designed to provide reasonable protection against harmful interference when the equipment is operated in a commercial environment. This equipment generates, uses, and can radiate radio-frequency energy and, if not installed and used in accordance with the instruction manual, may cause harmful interference to radio communications. Operation of this equipment in a residential area is likely to cause harmful interference, in which case users will be required to correct the interference at their own expense.

The following information is for FCC compliance of Class B devices: The equipment described in this manual generates and may radiate radio-frequency energy. If it is not installed in accordance with Cisco's installation instructions, it may cause interference with radio and television reception. This equipment has been tested and found to comply with the limits for a Class B digital device in accordance with the specifications in part 15 of the FCC rules. These specifications are designed to provide reasonable protection against such interference in a residential installation. However, there is no guarantee that interference will not occur in a particular installation.

Modifying the equipment without Cisco's written authorization may result in the equipment no longer complying with FCC requirements for Class A or Class B digital devices. In that event, your right to use the equipment may be limited by FCC regulations, and you may be required to correct any interference to radio or television communications at your own expense.

You can determine whether your equipment is causing interference by turning it off. If the interference stops, it was probably caused by the Cisco equipment or one of its peripheral devices. If the equipment causes interference to radio or television reception, try to correct the interference by using one or more of the following measures:

- Turn the television or radio antenna until the interference stops.
- Move the equipment to one side or the other of the television or radio.
- Move the equipment farther away from the television or radio.
- Plug the equipment into an outlet that is on a different circuit from the television or radio. (That is, make certain the equipment and the television or radio are on circuits controlled by different circuit breakers or fuses.)

Modifications to this product not authorized by Cisco Systems, Inc. could void the FCC approval and negate your authority to operate the product.

The Cisco implementation of TCP header compression is an adaptation of a program developed by the University of California, Berkeley (UCB) as part of UCB's public domain version of the UNIX operating system. All rights reserved. Copyright © 1981, Regents of the University of California.

NOTWITHSTANDING ANY OTHER WARRANTY HEREIN, ALL DOCUMENT FILES AND SOFTWARE OF THESE SUPPLIERS ARE PROVIDED "AS IS" WITH ALL FAULTS. CISCO AND THE ABOVE-NAMED SUPPLIERS DISCLAIM ALL WARRANTIES, EXPRESSED OR IMPLIED, INCLUDING, WITHOUT LIMITATION, THOSE OF MERCHANTABILITY, FITNESS FOR A PARTICULAR PURPOSE AND NONINFRINGEMENT OR ARISING FROM A COURSE OF DEALING, USAGE, OR TRADE PRACTICE.

IN NO EVENT SHALL CISCO OR ITS SUPPLIERS BE LIABLE FOR ANY INDIRECT, SPECIAL, CONSEQUENTIAL, OR INCIDENTAL DAMAGES, INCLUDING, WITHOUT LIMITATION, LOST PROFITS OR LOSS OR DAMAGE TO DATA ARISING OUT OF THE USE OR INABILITY TO USE THIS MANUAL, EVEN IF CISCO OR ITS SUPPLIERS HAVE BEEN ADVISED OF THE POSSIBILITY OF SUCH DAMAGES.

Cisco and the Cisco logo are trademarks or registered trademarks of Cisco and/or its affiliates in the U.S. and other countries. To view a list of Cisco trademarks, go to this URL: [www.cisco.com/go/trademarks](http://www.cisco.com/go/trademarks). Third-party trademarks mentioned are the property of their respective owners. The use of the word partner does not imply a partnership relationship between Cisco and any other company. (1110R)

Any Internet Protocol (IP) addresses used in this document are not intended to be actual addresses. Any examples, command display output, and figures included in the document are shown for illustrative purposes only. Any use of actual IP addresses in illustrative content is unintentional and coincidental.

*Cisco 860 Series, Cisco 880 Series, and Cisco 890 Series Integrated Services Routers Hardware Installation Guide*  
© 2013 Cisco Systems, Inc. All rights reserved.



**Preface** i

- Objective i
- Audience i
- Organization ii
- Conventions ii
- Related Documentation ix
- Searching Cisco Documents x
- Obtaining Documentation and Submitting a Service Request x

**CHAPTER 1**

**Product Overview** 1-1

- General Description 1-2
- Cisco 860 Series ISRs 1-2
- Cisco 860VAE Series ISRs 1-3
  - Interfaces 1-3
  - IOS Images 1-4
- Cisco 860VAE-W-A-K9, Cisco 860VAE-W-E-K9, and Cisco 860VAE-POE-W-A-K9 ISRs 1-6
  - Model-Specific Features 1-6
  - Common Features 1-6
    - External Interfaces 1-7
    - USB Interface 1-7
    - LED Indicators 1-8
- Cisco 880 Series ISRs 1-11
  - Cisco 880 Series Data Routers 1-11
  - Cisco 880 Series Voice and Data Routers 1-14
    - Cisco 881 SRST and Cisco 888 SRST 1-14
    - Cisco 881-V, Cisco 887VA-V, and Cisco 887VA-V-W 1-18
  - Cisco 880 Series with Embedded WLAN Antennas 1-20
    - Cisco 887VA-WD 1-20
    - C881WD 1-21
- Cisco 890 Series ISRs 1-22
  - Cisco 891, Cisco 892, and Cisco 892F 1-22
  - Cisco 892FSP, Cisco 896VA, Cisco 897VA, and Cisco 898EA 1-25
- Hardware Features 1-32

**REVIEW DRAFT – CISCO CONFIDENTIAL**

- Kensington Lock 1-32
- Reset Button 1-32
  - Cisco 860VAE Routers—Custom Configuration File 1-32
  - Custom Configuration File for Cisco 892FSP, 896VA, 897VA, and Cisco 898EA 1-33
- LEDs 1-35
  - Shared LEDs on the Cisco 881-V and Cisco 887VA-V Voice and Data Routers 1-40
- Memory 1-41
- USB Port 1-42
- Fan 1-43
- Power Supply 1-43
- Power over Ethernet Module 1-43
- 3G Cellular Data WAN Connectivity 1-44
- Wireless LAN Connectivity 1-45
  - Supported Cisco Radio Antennas 1-46
- Small Form-Factor Pluggable Port 1-46
- Feature Summary 1-47

**CHAPTER 2**

**Installing the Router 2-1**

- Equipment, Tools, and Connections 2-2
  - Items Shipped with your Router 2-2
  - Additional Items 2-2
- Connections 2-3
  - Ethernet Devices 2-3
- Installing the Router 2-3
  - Warnings 2-4
  - Installing Antennas 2-4
  - Installing on a Table 2-7
  - Mounting on a Wall 2-8
  - Installing in a Rack 2-11
  - Installing the Router Ground Connection 2-13
  - Installing the FIPS Cover 2-14

**CHAPTER 3**

**Connecting the Router 3-1**

- Safety Warnings 3-2
- Preparing to Connect the Router 3-4
  - Preventing Damage to the Router 3-4
- Connecting a PC, Server, or Workstation 3-5
- Connecting a Phone 3-6
- Connecting an External Ethernet Switch 3-7

**REVIEW DRAFT – CISCO CONFIDENTIAL**

Connecting the V.92 modem Port	3-8
Connecting a Terminal or PC to the Console Port	3-9
Terminal Emulator Settings	3-10
Connecting a Modem to the Auxiliary Port	3-10
Connecting the 3G Card	3-11
Installing the 3G Adapter for Extended Cable/Antenna	3-17
Connecting a Data BRI Port	3-21
Connecting an FE Line to an FE WAN Port	3-23
Connecting a GE Line to an GE WAN Port	3-24
Connecting an xDSL Line	3-25
Connecting Power over Ethernet	3-27
Connecting the AC Adapter	3-28
Connecting an FXS Line	3-32
Connecting an FXO Line	3-34
Connecting a Voice ISDN BRI Line	3-35
Connecting a Small Form-Factor Pluggable Module	3-37
Safety Warnings	3-37
Installing an SFP Module	3-38
Removing an SFP Module	3-38
Online Insertion and Removal	3-39
Verifying Connections	3-40

**CHAPTER 4****Initial Configuration 4-1**

Cisco Configuration Professional Express	4-1
Cisco IOS CLI	4-1
Setup Command Facility	4-3
Verifying the Initial Configuration	4-5
Initial Configuration of the Wireless Access Point	4-6

**APPENDIX A****Technical Specifications A-1**

Router Specifications	A-2
All Models Except Cisco 860VAE Series	A-2
Cisco 860VAE Series	A-3
Cisco 860VAE-W-A-K9, Cisco 860VAE-W-E-K9, and Cisco 860VAE-POE-W-A-K9 Series	A-4
Power Supply	A-5
Wireless Access Point	A-5
FE and GE Port Pinouts	A-6

**REVIEW DRAFT – CISCO CONFIDENTIAL**

Console and Auxiliary Port Connector Pinouts **A-7**

FXS and FXO Port Connector Pinouts **A-7**

VDSL2 Port Connector Pinouts **A-7**

ADSL2+ Port Connector Pinouts **A-8**

V.92 Port Connector Pinouts **A-8**

G.SHDSL Port Connector Pinouts **A-8**

Data BRI Port Connector Pinouts **A-9**

Voice ISDN BRI Interface Pin Numbers and Functions **A-10**

SFP Port Connector Pinouts **A-10**

Cable Specifications **A-11**

    Ethernet Cable Specifications **A-11**

    Maximum Cable Length **A-11**



## Preface

---

This preface describes the objectives, audience, organization, and conventions of this guide, and describes related documents that have additional information. It contains the following sections:

- [Objective, page i](#)
- [Audience, page i](#)
- [Organization, page ii](#)
- [Conventions, page ii](#)
- [Related Documentation, page ix](#)
- [Searching Cisco Documents, page x](#)
- [Obtaining Documentation and Submitting a Service Request, page x](#)

## Objective

This guide provides an overview and explains how to install, connect, and perform initial configuration for the wireless and nonwireless Cisco 860 series, Cisco 880 series, and Cisco 890 series Integrated Services Routers (ISRs). Some information may not apply to your particular router model.

For warranty, service, and support information, see the “Cisco One-Year Limited Hardware Warranty Terms” section in *Readme First for the Cisco 800 Series Integrated Services Routers* that was shipped with your router.

## Audience

This guide is intended for Cisco equipment providers who are technically knowledgeable and familiar with Cisco routers and Cisco IOS software and features.

# Organization

This guide is organized into the following chapters and appendix.

Chapter	Name	Description
Chapter 1	<a href="#">Chapter 1, “Product Overview”</a>	Describes the router models and the hardware features available.
Chapter 2	<a href="#">Chapter 2, “Installing the Router”</a>	Lists the items shipped with the router, the equipment and tools necessary for installing the router, the safety warnings and guidelines, and the procedures for installing the router.
Chapter 3	<a href="#">Chapter 3, “Connecting the Router”</a>	Describes typical connections for the router, procedures for connecting the router to various devices, and how to verify the connections.
Chapter 4	<a href="#">Chapter 4, “Initial Configuration”</a>	Provides the procedures for initially configuring the router settings.
Appendix A	<a href="#">Appendix A, “Technical Specifications”</a>	Provides the router, port, and cabling specifications.

## Conventions

This section describes the conventions used in this guide.



### Note

Means *reader take note*. Notes contain helpful suggestions or references to additional information and material.



### Caution

This symbol means *reader be careful*. In this situation, you might do something that could result in equipment damage or loss of data.



### Tip

Means *the following information will help you solve a problem*. The tip information might not be troubleshooting or even an action, but could be useful information.





Warning

## IMPORTANT SAFETY INSTRUCTIONS

This warning symbol means danger. You are in a situation that could cause bodily injury. Before you work on any equipment, be aware of the hazards involved with electrical circuitry and be familiar with standard practices for preventing accidents. Use the statement number provided at the end of each warning to locate its translation in the translated safety warnings that accompanied this device. Statement 1071

## SAVE THESE INSTRUCTIONS

Waarschuwing

## BELANGRIJKE VEILIGHEIDSINSTRUCTIES

Dit waarschuwingssymbool betekent gevaar. U verkeert in een situatie die lichamelijk letsel kan veroorzaken. Voordat u aan enige apparatuur gaat werken, dient u zich bewust te zijn van de bij elektrische schakelingen betrokken risico's en dient u op de hoogte te zijn van de standaard praktijken om ongelukken te voorkomen. Gebruik het nummer van de verklaring onderaan de waarschuwing als u een vertaling van de waarschuwing die bij het apparaat wordt geleverd, wilt raadplegen.

## BEWAAR DEZE INSTRUCTIES

Varoitus

## TÄRKEITÄ TURVALLISUUSOHJEITA

Tämä varoitusmerkki merkitsee vaaraa. Tilanne voi aiheuttaa ruumiillisia vammoja. Ennen kuin käsittelet laitteistoa, huomioi sähköpiirien käsittelyyn liittyvät riskit ja tutustu onnettomuuksien yleisiin ehkäisytapoihin. Turvallisuusvaroitusten käännökset löytyvät laitteen mukana toimitettujen käännettyjen turvallisuusvaroitusten joukosta varoitusten lopussa näkyvien lausuntonumeroiden avulla.

## SÄILYTÄ NÄMÄ OHJEET

Attention

## IMPORTANTES INFORMATIONS DE SÉCURITÉ

Ce symbole d'avertissement indique un danger. Vous vous trouvez dans une situation pouvant entraîner des blessures ou des dommages corporels. Avant de travailler sur un équipement, soyez conscient des dangers liés aux circuits électriques et familiarisez-vous avec les procédures couramment utilisées pour éviter les accidents. Pour prendre connaissance des traductions des avertissements figurant dans les consignes de sécurité traduites qui accompagnent cet appareil, référez-vous au numéro de l'instruction situé à la fin de chaque avertissement.

## CONSERVEZ CES INFORMATIONS

Warnung

## WICHTIGE SICHERHEITSHINWEISE

Dieses Warnsymbol bedeutet Gefahr. Sie befinden sich in einer Situation, die zu Verletzungen führen kann. Machen Sie sich vor der Arbeit mit Geräten mit den Gefahren elektrischer Schaltungen und den üblichen Verfahren zur Vorbeugung vor Unfällen vertraut. Suchen Sie mit der am Ende jeder Warnung angegebenen Anweisungsnummer nach der jeweiligen Übersetzung in den übersetzten Sicherheitshinweisen, die zusammen mit diesem Gerät ausgeliefert wurden.

## BEWAHREN SIE DIESE HINWEISE GUT AUF.

**Avvertenza      IMPORTANTI ISTRUZIONI SULLA SICUREZZA**

Questo simbolo di avvertenza indica un pericolo. La situazione potrebbe causare infortuni alle persone. Prima di intervenire su qualsiasi apparecchiatura, occorre essere al corrente dei pericoli relativi ai circuiti elettrici e conoscere le procedure standard per la prevenzione di incidenti. Utilizzare il numero di istruzione presente alla fine di ciascuna avvertenza per individuare le traduzioni delle avvertenze riportate in questo documento.

**CONSERVARE QUESTE ISTRUZIONI**

**Advarsel      VIKTIGE SIKKERHETSINSTRUKSJONER**

Dette advarselssymbolet betyr fare. Du er i en situasjon som kan føre til skade på person. Før du begynner å arbeide med noe av utstyret, må du være oppmerksom på farene forbundet med elektriske kretser, og kjenne til standardprosedyrer for å forhindre ulykker. Bruk nummeret i slutten av hver advarsel for å finne oversettelsen i de oversatte sikkerhetsadvarslene som fulgte med denne enheten.

**TA VARE PÅ DISSE INSTRUKSJONENE**

**Aviso      INSTRUÇÕES IMPORTANTES DE SEGURANÇA**

Este símbolo de aviso significa perigo. Você está em uma situação que poderá ser causadora de lesões corporais. Antes de iniciar a utilização de qualquer equipamento, tenha conhecimento dos perigos envolvidos no manuseio de circuitos elétricos e familiarize-se com as práticas habituais de prevenção de acidentes. Utilize o número da instrução fornecido ao final de cada aviso para localizar sua tradução nos avisos de segurança traduzidos que acompanham este dispositivo.

**GUARDE ESTAS INSTRUÇÕES**

**¡Advertencia!      INSTRUCCIONES IMPORTANTES DE SEGURIDAD**

Este símbolo de aviso indica peligro. Existe riesgo para su integridad física. Antes de manipular cualquier equipo, considere los riesgos de la corriente eléctrica y familiarícese con los procedimientos estándar de prevención de accidentes. Al final de cada advertencia encontrará el número que le ayudará a encontrar el texto traducido en el apartado de traducciones que acompaña a este dispositivo.

**GUARDE ESTAS INSTRUCCIONES**

**Varning!      VIKTIGA SÄKERHETSANVISNINGAR**

Denna varningssignal signalerar fara. Du befinner dig i en situation som kan leda till personskada. Innan du utför arbete på någon utrustning måste du vara medveten om farorna med elkretsar och känna till vanliga förfaranden för att förebygga olyckor. Använd det nummer som finns i slutet av varje varning för att hitta dess översättning i de översatta säkerhetsvarningar som medföljer denna anordning.

**SPARA DESSA ANVISNINGAR**

**Figyelem** **FONTOS BIZTONSÁGI ELOÍRÁSOK**

**Ez a figyelmeztető jel veszélyre utal. Sérülésveszélyt rejtő helyzetben van. Mielott bármely berendezésen munkát végezte, legyen figyelemmel az elektromos áramkörök okozta kockázatokra, és ismerkedjen meg a szokásos balesetvédelmi eljárásokkal. A kiadványban szereplő figyelmeztetések fordítása a készülékhez mellékelt biztonsági figyelmeztetések között található; a fordítás az egyes figyelmeztetések végén látható szám alapján kereshető meg.**

**ORIZZE MEG EZEKET AZ UTASÍTÁSOKAT!**

**Предупреждение** **ВАЖНЫЕ ИНСТРУКЦИИ ПО СОБЛЮДЕНИЮ ТЕХНИКИ БЕЗОПАСНОСТИ**

**Этот символ предупреждения обозначает опасность. То есть имеет место ситуация, в которой следует опасаться телесных повреждений. Перед эксплуатацией оборудования выясните, каким опасностям может подвергаться пользователь при использовании электрических цепей, и ознакомьтесь с правилами техники безопасности для предотвращения возможных несчастных случаев. Воспользуйтесь номером заявления, приведенным в конце каждого предупреждения, чтобы найти его переведенный вариант в переводе предупреждений по безопасности, прилагаемом к данному устройству.**

**СОХРАНИТЕ ЭТИ ИНСТРУКЦИИ**

**警告** **重要的安全性说明**

此警告符号代表危险。您正处于可能受到严重伤害的工作环境中。在您使用设备开始工作之前，必须充分意识到触电的危险，并熟练掌握防止事故发生的标准工作程序。请根据每项警告结尾提供的声明号码来找到此设备的安全性警告说明的翻译文本。

请保存这些安全性说明

**警告** **安全上の重要な注意事項**

「危険」の意味です。人身事故を予防するための注意事項が記述されています。装置の取り扱い作業を行うときは、電気回路の危険性に注意し、一般的な事故防止策に留意してください。警告の各国語版は、各注意事項の番号を基に、装置に付属の「Translated Safety Warnings」を参照してください。

これらの注意事項を保管しておいてください。

**주의** **중요 안전 지침**

이 경고 기호는 위험을 나타냅니다. 작업자가 신체 부상을 일으킬 수 있는 위험한 환경에 있습니다. 장비에 작업을 수행하기 전에 전기 회로와 관련된 위험을 숙지하고 표준 작업 관례를 숙지하여 사고를 방지하십시오. 각 경고의 마지막 부분에 있는 경고문 번호를 참조하여 이 장치와 함께 제공되는 번역된 안전 경고문에서 해당 번역문을 찾으십시오.

이 지시 사항을 보관하십시오.

**Aviso INSTRUÇÕES IMPORTANTES DE SEGURANÇA**

Este símbolo de aviso significa perigo. Você se encontra em uma situação em que há risco de lesões corporais. Antes de trabalhar com qualquer equipamento, esteja ciente dos riscos que envolvem os circuitos elétricos e familiarize-se com as práticas padrão de prevenção de acidentes. Use o número da declaração fornecido ao final de cada aviso para localizar sua tradução nos avisos de segurança traduzidos que acompanham o dispositivo.

**GUARDE ESTAS INSTRUÇÕES**

**Advarsel VIGTIGE SIKKERHEDSANVISNINGER**

Dette advarselssymbol betyder fare. Du befinder dig i en situation med risiko for legemeskade. Før du begynder arbejde på udstyr, skal du være opmærksom på de involverede risici, der er ved elektriske kredsløb, og du skal sætte dig ind i standardprocedurer til undgåelse af ulykker. Brug erklæringsnummeret efter hver advarsel for at finde oversættelsen i de oversatte advarsler, der fulgte med denne enhed.

**GEM DISSE ANVISNINGER**

تحذير

إرشادات الأمان الهامة

يوضح رمز التحذير هذا وجود خطر. وهذا يعني أنك متواجد في مكان قد ينتج عنه التعرض لإصابات. قبل بدء العمل، احذر مخاطر التعرض للصدمات الكهربائية وكن على علم بالإجراءات القياسية للحيلولة دون وقوع أي حوادث. استخدم رقم البيان الموجود في آخر كل تحذير لتحديد مكان ترجمته داخل تحذيرات الأمان المترجمة التي تأتي مع الجهاز. قم بحفظ هذه الإرشادات

**Upozorenje VAŽNE SIGURNOSNE NAPOMENE**

Ovaj simbol upozorenja predstavlja opasnost. Nalazite se u situaciji koja može prouzročiti tjelesne ozljede. Prije rada s bilo kojim uređajem, morate razumjeti opasnosti vezane uz električne sklopove, te biti upoznati sa standardnim načinima izbjegavanja nesreća. U prevedenim sigurnosnim upozorenjima, priloženima uz uređaj, možete prema broju koji se nalazi uz pojedino upozorenje pronaći i njegov prijevod.

**SAČUVAJTE OVE UPUTE**

**Upozornění DŮLEŽITÉ BEZPEČNOSTNÍ POKYNY**

Tento upozorňující symbol označuje nebezpečí. Jste v situaci, která by mohla způsobit nebezpečí úrazu. Před prací na jakémkoliv vybavení si uvědomte nebezpečí související s elektrickými obvody a seznamte se se standardními opatřeními pro předcházení úrazům. Podle čísla na konci každého upozornění vyhledejte jeho překlad v přeložených bezpečnostních upozorněních, která jsou přiložena k zařízení.

**USCHOVEJTE TYTO POKYNY**

Προειδοποίηση

## ΣΗΜΑΝΤΙΚΕΣ ΟΔΗΓΙΕΣ ΑΣΦΑΛΕΙΑΣ

Αυτό το προειδοποιητικό σύμβολο σημαίνει κίνδυνο. Βρίσκεστε σε κατάσταση που μπορεί να προκαλέσει τραυματισμό. Πριν εργαστείτε σε οποιοδήποτε εξοπλισμό, να έχετε υπόψη σας τους κινδύνους που σχετίζονται με τα ηλεκτρικά κυκλώματα και να έχετε εξοικειωθεί με τις συνήθειες πρακτικές για την αποφυγή ατυχημάτων. Χρησιμοποιήστε τον αριθμό δήλωσης που παρέχεται στο τέλος κάθε προειδοποίησης, για να εντοπίσετε τη μετάφρασή της στις μεταφρασμένες προειδοποιήσεις ασφαλείας που συνοδεύουν τη συσκευή.

ΦΥΛΑΞΤΕ ΑΥΤΕΣ ΤΙΣ ΟΔΗΓΙΕΣ

אזהרה

## הוראות בטיחות חשובות

סימן אזהרה זה מסמל סכנה. אתה נמצא במצב העלול לגרום לפציעה. לפני שתעבוד עם ציוד כלשהו, עליך להיות מודע לסכנות הכרוכות במעגלים חשמליים ולהכיר את הנהלים המקובלים למניעת תאונות. השתמש במספר ההוראה המסופק בסופה של כל אזהרה כדי לאתר את התרגום באזהרות הבטיחות המתורגמות שמצורפות להתקן.

שמור הוראות אלה

предупреждение

## ВАЖНИ БЕЗБЕДНОСНИ НАПАТСТВИЈА

Симболот за предупредување значи опасност. Се наоѓате во ситуација што може да предизвика телесни повреди. Пред да работите со опремата, бидете свесни за ризикот што постои кај електричните кола и треба да ги познавате стандардните постапки за спречување на несреќни случаи. Искористете го бројот на изјавата што се наоѓа на крајот на секое предупредување за да го најдете неговиот период во преведените безбедносни предупредувања што се испорачани со уредот.

ЧУВАЈТЕ ГИ ОБИЕ НАПАТСТВИЈА

Ostrzeżenie

## WAŻNE INSTRUKCJE DOTYCZĄCE BEZPIECZEŃSTWA

Ten symbol ostrzeżenia oznacza niebezpieczeństwo. Zachodzi sytuacja, która może powodować obrażenia ciała. Przed przystąpieniem do prac przy urządzeniach należy zapoznać się z zagrożeniami związanymi z układami elektrycznymi oraz ze standardowymi środkami zapobiegania wypadkom. Na końcu każdego ostrzeżenia podano numer, na podstawie którego można odszukać tłumaczenie tego ostrzeżenia w dołączonym do urządzenia dokumencie z tłumaczeniami ostrzeżeń.

NINIEJSZE INSTRUKCJE NALEŻY ZACHOWAĆ

Upozornenie

## DÔLEŽITÉ BEZPEČNOSTNÉ POKYNY

Tento varovný symbol označuje nebezpečenstvo. Nachádzate sa v situácii s nebezpečenstvom úrazu. Pred prácou na akomkoľvek vybavení si uvedomte nebezpečenstvo súvisiace s elektrickými obvodmi a oboznámte sa so štandardnými opatreniami na predchádzanie úrazom. Podľa čísla na konci každého upozornenia vyhľadajte jeho preklad v preložených bezpečnostných upozorneniach, ktoré sú priložené k zariadeniu.

USCHOVAJTE SI TENTO NÁVOD

## Opozorilo POMEMBNI VARNOSTNI NAPOTKI

Ta opozorilni simbol pomeni nevarnost. Nahajate se v situaciji, kjer lahko pride do telesnih poškodb. Preden pričnete z delom na napravi, se morate zavedati nevarnosti udara električnega toka, ter tudi poznati preventivne ukrepe za preprečevanje takšnih nevarnosti. Uporabite obrazložitevno številko na koncu posameznega opozorila, da najdete opis nevarnosti v priloženem varnostnem priročniku.

### SHRANITE TE NAPOTKE!

警告

重要安全性指示

此警告符號代表危險，表示可能造成人身傷害。使用任何設備前，請留心電路相關危險，並熟悉避免意外的標準作法。您可以使用每項警告後的聲明編號，查詢本裝置隨附之安全性警告譯文中的翻譯。請妥善保留此指示



Warning

**When installing the product, please use the provided or designated connection cables/power cables/AC adaptors. Using any other cables/adaptors could cause a malfunction or a fire. Electrical Appliance and Material Safety Law prohibits the use of UL-certified cables (that have the "UL" shown on the code) for any other electrical devices than products designated by CISCO. The use of cables that are certified by Electrical Appliance and Material Safety Law (that have "PSE" shown on the code) is not limited to CISCO-designated products.** Statement 371



Warning

**There is the danger of explosion if the battery is replaced incorrectly. Replace the battery only with the same or equivalent type recommended by the manufacturer. Dispose of used batteries according to the manufacturer's instructions.** Statement 1015



Warning

**Do not use this product near water; for example, near a bath tub, wash bowl, kitchen sink or laundry tub, in a wet basement, or near a swimming pool.** Statement 1035



Warning

**Never install telephone jacks in wet locations unless the jack is specifically designed for wet locations.** Statement 1036



Warning

**Never touch uninsulated telephone wires or terminals unless the telephone line has been disconnected at the network interface.** Statement 1037



Warning

**Avoid using a telephone (other than a cordless type) during an electrical storm. There may be a remote risk of electric shock from lightning.** Statement 1038



**Warning**

---

**Only trained and qualified personnel should be allowed to install, replace, or service this equipment.**  
Statement 1030

---



**Warning**

---

**Read the installation instructions before connecting the system to the power source.** Statement 1004

---



**Warning**

---

**Ultimate disposal of this product should be handled according to all national laws and regulations.**  
Statement 1040

---

## Related Documentation

In addition to the Cisco 860 series, Cisco 880 series, and Cisco 890 series *ISR Hardware Installation Guide* (this document), the Cisco 860 series, Cisco 880 series, and Cisco 890 series ISR documentation set includes the following documents:

- [\*Regulatory Compliance and Safety Information for Cisco 800 Series\*](#)
- [\*Cisco 860 Series, Cisco 880 Series, and Cisco 890 Series Integrated Services Routers Software Configuration Guide\*](#)
- [\*Software Activation on Cisco Integrated Services Routers and Cisco Integrated Service Routers G2\*](#)
- [\*Cisco IOS Software Activation Configuration Guide\*](#)
- [\*Declarations of Conformity and Regulatory Information for Cisco Access Products with 802.11a/b/g and 802.11b/g Radios\*](#)
- [\*Cisco IOS Release Notes\*](#)
- [\*Cisco IOS Quality of Service Solutions Command Reference, Release 12.4T\*](#)
- [\*Cisco IOS Security Configuration Guide, Release 12.4T\*](#)
- [\*Cisco IOS Security Command Reference, Release 12.4T\*](#)
- [\*Cisco IOS Command Reference for Cisco Aironet Access Points and Bridges, versions 12.4\(10b\) JA and 12.3\(8\) JEC\*](#)
- [\*Wireless LAN Controllers\*](#)
- [\*Unified Wireless LAN Access Points\*](#)
- [\*Cisco IOS Voice Port Configuration Guide\*](#)
- [\*SCCP Controlled Analog \(FXS\) Ports with Supplementary Features in Cisco IOS Gateways\*](#)
- [\*Cisco CP Express User's Guide\*](#)

---

## Searching Cisco Documents

To search a HTML document using a web browser, press **Ctrl-F** (Windows) or **Cmd-F** (Apple). In most browsers, the option to search whole words only, invoke case sensitivity, or search forward and backward is also available.

To search a PDF document in Adobe Reader, use the basic Find toolbar (**Ctrl-F**) or the Full Reader Search window (**Shift-Ctrl-F**). Use the Find toolbar to find words or phrases within a specific document. Use the Full Reader Search window to search multiple PDF files simultaneously and to change case sensitivity and other options. Adobe Reader's online help has more information about how to search PDF documents.

## Obtaining Documentation and Submitting a Service Request

For information on obtaining documentation, submitting a service request, and gathering additional information, see the monthly *What's New in Cisco Product Documentation*, which also lists all new and revised Cisco technical documentation:

<http://www.cisco.com/en/US/docs/general/whatsnew/whatsnew.html>

Subscribe to the *What's New in Cisco Product Documentation* as an RSS feed and set content to be delivered directly to your desktop using a reader application. The RSS feeds are a free service. Cisco currently supports RSS Version 2.0.y





# Product Overview

---

This chapter provides an overview of the features available for the Cisco 860 series, Cisco 880 series, and Cisco 890 series Integrated Services Routers (ISRs), and contains the following sections:

- [General Description, page 1-2](#)
- [Cisco 860 Series ISRs, page 1-2](#)
- [Cisco 860VAE Series ISRs, page 1-3](#)
- [Cisco 860VAE-W-A-K9, Cisco 860VAE-W-E-K9, and Cisco 860VAE-POE-W-A-K9 ISRs, page 1-6](#)
- [Cisco 880 Series ISRs, page 1-11](#)
- [Cisco 890 Series ISRs, page 1-22](#)
- [Hardware Features, page 1-32](#)



**Note**

---

For compliance and safety information, see *Regulatory Compliance and Safety Information Roadmap* that ships with the router and [Regulatory Compliance and Safety Information for Cisco 800 Series](#).

---



**Note**

---

Some illustrations in this document show a wireless router. Both wireless and nonwireless models are available in the Cisco 860 series, Cisco 880 series, and Cisco 890 series ISRs. Port and feature locations are similar for both wireless and nonwireless routers.

---



**Note**

---

Throughout this document the term VDSL refers to support for VDSL2 (ITU G.993.2) and ADSL refers to support for ADSL, ADSL2, & ADSL2+ (ITU G.992.1, G.992.3, & G.992.5).

---

## General Description

The Cisco 860 series, Cisco 880 series, and Cisco 890 series ISRs provide data, voice, Wi-Fi CERTIFIED™ wireless access point (AP), integrated Virtual Private Network (VPN), and backup capabilities to corporate teleworkers and to remote and small offices with fewer than 20 users. These routers are capable of bridging and multiprotocol routing between LAN and WAN ports. The routers provide advanced features, such as high speed DSL (G.SHDSL, ADSL, or VDSL), 802.11n, quality of service (QoS), firewall, antivirus protection, and Secure Socket Layer (SSL). The Cisco 860VAE, 886VA and 887VA series routers have the additional capability of DSL Multi-mode (VDSL/ADSL).

The Cisco 860 series, Cisco 880 series, and Cisco 890 series ISRs have a desktop form factor with built-in wall-mount features. The Cisco 890 series ISRs also have optional rack-mount features. These ISRs are powered by an external power supply adapter. The various models differ in the WAN interface and features that they support.

## Cisco 860 Series ISRs

The Cisco 860 series ISRs are fixed-configuration data routers that support the following features:

- An integrated 4-port 10/100 Ethernet switch for connecting to the LAN
- A 10/100 Fast Ethernet (FE) port for connecting to the WAN.
- Optional, embedded Wi-Fi CERTIFIED™, 802.11b/g/n-compliant wireless AP

Figure 1-1 shows the front panel details of the Cisco 860 wireless router.

**Figure 1-1** Front Panel of the Cisco 860 Series Wireless ISR

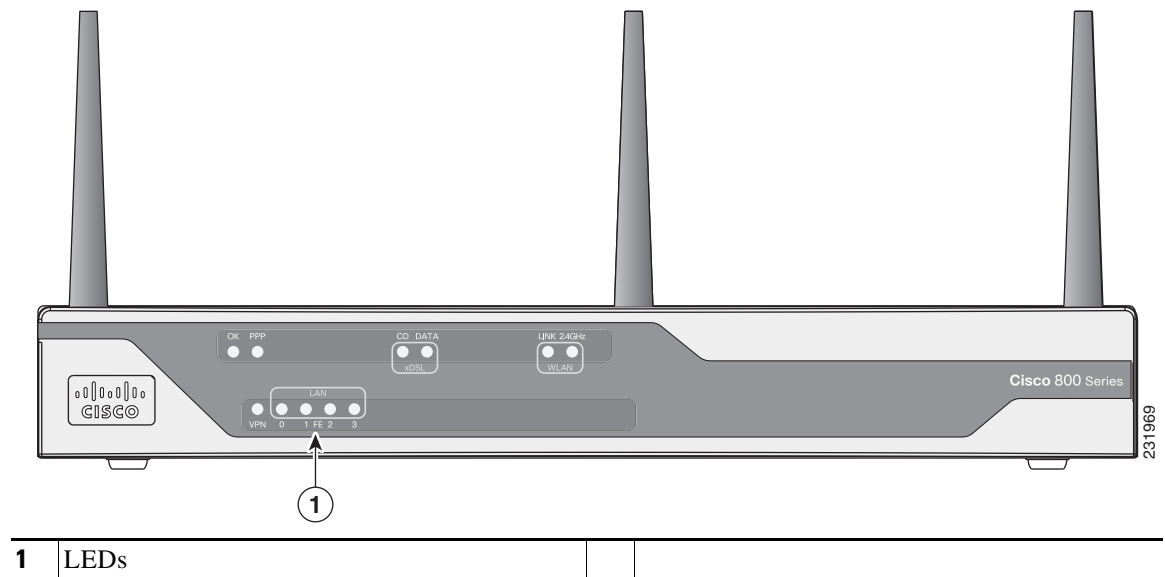
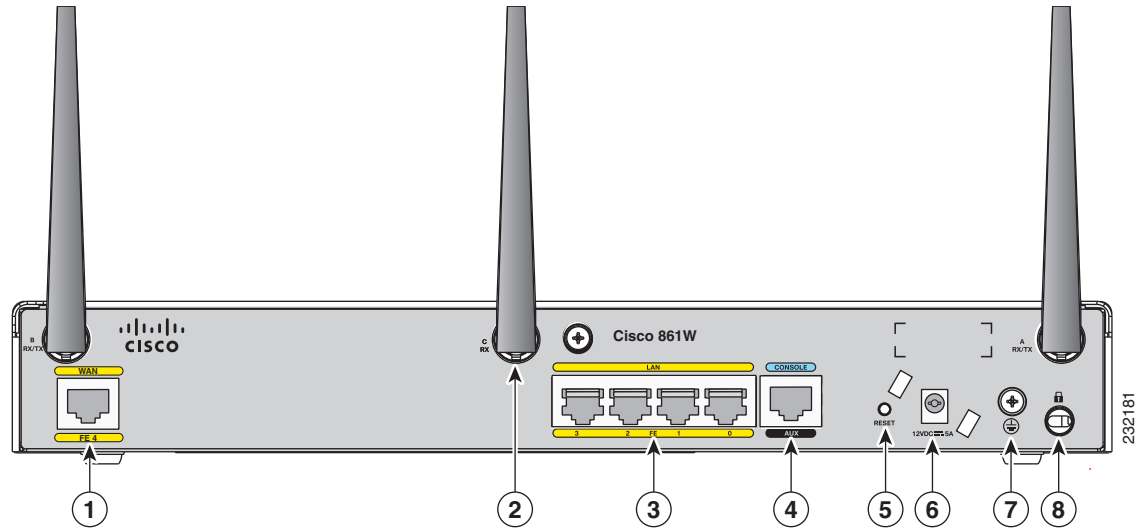

Figure 1-2 shows the back panel details of the Cisco 861 wireless (861W) ISR. Nonwireless routers do not have antennas on the back panel. However, the feature locations are similar for all Cisco 860 series routers.

Figure 1-2 Back Panel of the Cisco 861W ISR



1	Primary WAN port—10/100	5	Reset button
2	Antenna—captive omnidirectional dipole WLAN antenna (wireless models only)	6	Power connector
3	4-port 10/100 Ethernet switch	7	Earth ground connection
4	Serial port—console or auxiliary	8	Kensington security slot

## Cisco 860VAE Series ISRs

The Cisco 860VAE series ISRs are fixed-configuration data routers. This section describes the features of the products in this series.

### Interfaces

Table 1-1 describes the interfaces of the Cisco 860VAE series routers.

Table 1-1 Interfaces of the Cisco 860VAE Series ISRs

Interfaces	Model			
	866VAE	867VAE	866VAE-K9	867VAE-K9
4 FE <sup>1</sup> switch ports	x	x	x	x
1 GE <sup>2</sup> switch port	—	—	x	x
1 GE WAN port	x	x	x	x

**Table 1-1** Interfaces of the Cisco 860VAE Series ISRs (continued)

Interfaces	Model			
	866VAE	867VAE	866VAE-K9	867VAE-K9
1 VDSL/ADSL over POTS port	—	x	—	x
1 VDSL/ADSL over ISDN port	x	—	x	—

1. FE = Fast Ethernet
2. GE = Gigabit Ethernet

**Note**

The Cisco 866VAE, 867VAE, 866VAE-K9, and 867VAE-K9 routers each have two WAN ports. Only one of the two ports can be active at any given time.

## IOS Images

Table 1-2 describes the IOS images included in Cisco 860VAE series routers.

**Table 1-2** IOS Images of the Cisco 860VAE Series ISRs

IOS Image	Model			
	866VAE	867VAE	866VAE-K9	867VAE-K9
c860vae-ipbasek9-mz	x	x	—	—
c860vae-advsecurityk9-mz	—	—	x	x
c860vae-advsecurityk9_npe-mz	—	—	x	x

Figure 1-3 shows the front panel details of the Cisco 866VAE, Cisco 867VAE, Cisco 866VAE-K9, and Cisco 867VAE-K9 integrated services routers (ISRs).

**Figure 1-3** Front Panel of the Cisco 860VAE series ISR

<b>1</b>	LEDs		
----------	------	--	--

Figure 1-4 shows the back panel details of the Cisco 866VAE ISR.

Figure 1-4 Back Panel of the Cisco 866VAE ISR

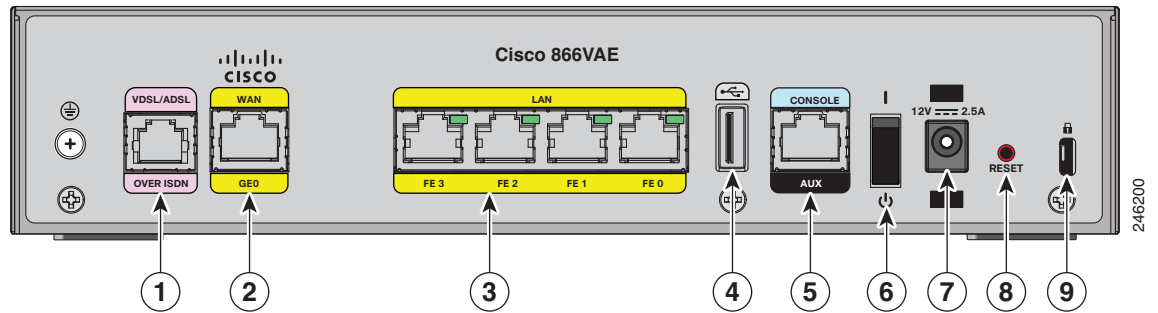

1	xDSL port <sup>1</sup>	6	On/Off switch
2	GE WAN interface	7	Power connector
3	Ethernet LAN FE interfaces (FE0 through FE3 interfaces)	8	Reset button
4	USB port	9	Kensington security slot
5	Serial port—console or auxiliary		

1. Using RJ-11.

Figure 1-5 shows the back panel details of the Cisco 867VAE-K9.

Figure 1-5 Back Panel of the Cisco 867VAE-K9 ISR

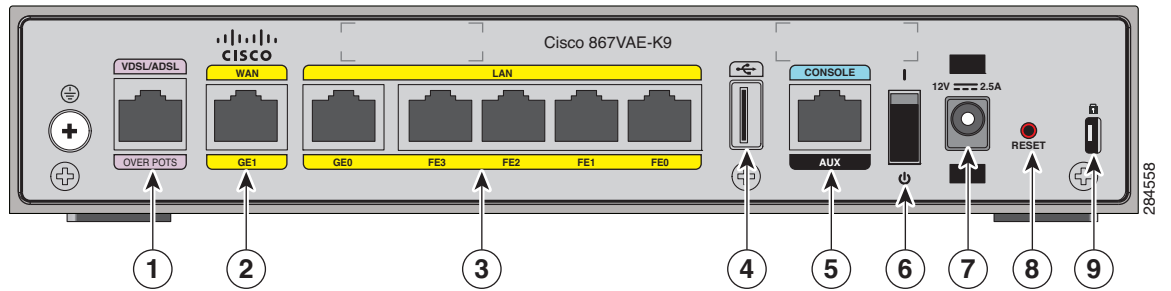

1	xDSL port	6	On/Off switch
2	GE WAN interface	7	Power connector
3	Ethernet LAN GE and FE interfaces (GE0 interface and FE0 through FE3 interfaces)	8	Reset button
4	USB port	9	Kensington security slot
5	Serial port—console or auxiliary		

# Cisco 860VAE-W-A-K9, Cisco 860VAE-W-E-K9, and Cisco 860VAE-POE-W-A-K9 ISRs

This section provides a hardware overview of the following Cisco 860VAE Series Integrated Services Routers (ISRs):

- C866VAE-W-E-K9
- C867VAE-W-A-K9
- C867VAE-W-E-K9
- C867VAE-POE-W-A-K9

## Model-Specific Features

Table 1-3 describes the features specific to each of these router models:

**Table 1-3** Model-Specific Router Features

Feature	C866VAE-W-E-K9	C867VAE-W-A-K9	C867VAE-W-E-K9	C867VAE-POE-W-A-K9
WAN interface and mode	One GE port, DSL over ISDN, Europe WiFi	One GE port, DSL over POTS, America WiFi	One GE port, DSL over POTS, Europe WiFi	One GE port, DSL over POTS, America WiFi
Power-over-Ethernet (PoE)	No	No	No	Yes

## Common Features

The following key features are common to each of these router models:

- Dual WAN interface (Gigabit Ethernet [GE] and dual-mode ADSL2+ /VDSL2)
- 2.4 GHz wireless LAN (WLAN) interface
- Five Layer 2 LAN switches: two Gigabit Ethernet and three Fast Ethernet
- One USB 2.0 port in high-speed host mode
- One RJ-45 console port (RS-232 interface)
- Support for up to 512 MB DRAM using DDR in 16-bit mode
- Support for 8 MB Serial Peripheral Interface Bus (SPI) flash memory for boot and 128 MB NAND flash memory for storing IOS
- Reset/Recovery switch
- Silent convection cooling—no fan

## External Interfaces

Figure 1-6 shows the back I/O panel of the Cisco 867VAE-POE-W-A-K9 series router.

**Figure 1-6 Back I/O Panel**

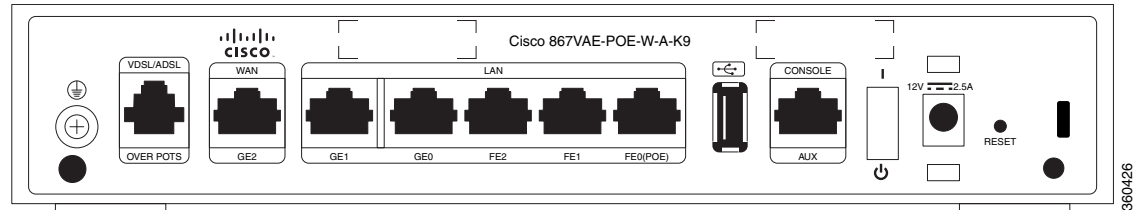

Table 1-4 describes the external interfaces included with these router models.

**Table 1-4 External Interfaces**

Interface	Connector	Quantity	Port	Port Label
FE LAN port	RJ-45	3	FE LAN PORT 0	FE0 <sup>1</sup>
			FE LAN PORT 1	FE1
			FE LAN PORT 2	FE2
GE LAN port	RJ-45	2	GE LAN PORT 0	GE0
			GE LAN PORT 1	GE1
GE WAN port (10/100/1000 Base-T)	RJ-45	1	GE WAN PORT	GE2
ADSL2+/VDSL2 WAN port	RJ-11	1	—	—
Host USB port	USB 2.0	1	—	—
Console port	RJ-45	1	—	—

1. Provides Power-over-Ethernet (PoE) for the Cisco C867VAE-POE-W-A-K9.



**Note**

For the Cisco C867VAE-POE-W-A-K9, Power-over-Ethernet (PoE) is available using port FE0, with a 60-W power supply.

## USB Interface

The USB 2.0 interface enables:

- Transferring data using a USB flash token (USB memory stick) for system recovery and other tasks.
- Cisco IOS software boot from USB.

Use only the following Cisco USB 2.0 flash tokens:

- MEMUSB-128FT (128 MB)
- MEMUSB-256FT (256 MB)
- MEMUSB-1024FT (1 GB)

**Note**

The USB 2.0 port cannot be used for connecting external devices or as a console for devices other than those specified in the *USB eToken Device and USB Flash Features Support Data Sheet*, available at: [http://www.cisco.com/en/US/prod/collateral/modules/ps6247/product\\_data\\_sheet0900aecd80232473.html](http://www.cisco.com/en/US/prod/collateral/modules/ps6247/product_data_sheet0900aecd80232473.html)

## LED Indicators

These router models include LED indicators on the back panel for each LAN port, and additional LED indicators on the front panel of the unit.

### LED Indicators for LAN Ports

On the back panel of the unit, each LAN port includes an LED indicator. [Table 1-5](#) describes the LED indicators.

**Table 1-5 Back Panel LED Indicators for LAN Ports**

Port	LED Color	Description
<b>FE Ports</b>		
FE LAN 0	Green	Off—No link. Faster flashing indicates heavier traffic.
FE LAN 1	Green	Off—No link. Faster flashing indicates heavier traffic.
FE LAN 2	Green	Off—No link. Faster flashing indicates heavier traffic.
<b>GE Ports</b>		
GE LAN 0	Green	Off—No link. Faster flashing indicates heavier traffic.
GE LAN 1	Green	Off—No link. Faster flashing indicates heavier traffic.



### LED Indicators on Front Panel

The front panel includes several LED indicators. [Figure 1-7](#) shows the location of the LED indicators.

**Figure 1-7** Front Panel LED Indicators



<b>1</b>	LED indicators	
----------	----------------	--

Table 1-6 describes the LED indicators.

**Table 1-6 Front Panel LED Indicators**

LED	LED Color	LED Activity	Description
<b>Left Side</b>			
DSL ACT	Green	Flashing	DSL WAN activity. Faster flashing indicates heavier traffic.
	Off	—	Device is powered off. or No DSL WAN activity.
DSL LINK	Green	Solid	DSL WAN mode is selected and DSL training is complete.
		Flashing	DSL WAN mode is selected but DSL LinkUp state is incomplete, such as in-training (slow initially, fast when almost connected).
	Off	—	Device is powered off. or GE WAN mode is selected.
GE ACT	Green	Flashing	GE WAN activity (traffic in either direction). Faster flashing indicates heavier traffic.
	Off	—	Device is powered off. or No GE WAN activity. or No link.
GE MODE	Green	Solid	GE WAN mode is selected.
	Off	—	Device is powered off. or DSL WAN mode is selected.
<b>Right Side</b>			
WLAN	Green	Solid	WLAN enabled.
		Flashing	Indicates WLAN activity (traffic in either direction).
	Off	—	Device is powered off. or WLAN is disabled.
Power	Green	Solid	On—The device is powered on.
	Off	—	Device is powered off.

# Cisco 880 Series ISRs

The Cisco 880 series ISRs have data and voice capabilities. They have the following features:

- Integrated 4-port 10/100 Ethernet switch for connecting to the LAN
- 10/100 FE, VDSL<sub>o</sub>POTS, ADSL over POTS, ADSL over ISDN, DSL Multi-mode (VDSL/ADSL<sub>o</sub>POTS, VDSL/ADSL<sub>o</sub>ISDN Cisco VA models only), or G.SHDSL port for connecting to the WAN
- Optional embedded Wi-Fi CERTIFIED™, 802.11b/g/n-compliant wireless AP
- Optional 2-port Power over Ethernet (PoE)



**Note** The Cisco 880 series ISRs can include an optional PoE module that provides power to 802.3af-compliant devices connected to ethernet ports 0 and 1. If this feature was not configured with the factory order, you must order and install it to enable the PoE function.

- DIMM expansion socket that can accept up to 512 MB of additional memory, for a total of 768 MB system memory

The following features are located on the front panel:

- USB 1.1 port
- Express card slot for third-generation (3G) cellular data WAN connectivity, available only on the Cisco 880G models

This section contains the following topics:

- [Cisco 880 Series Data Routers, page 1-11](#)
- [Cisco 880 Series Voice and Data Routers, page 1-14](#)
- [Cisco 880 Series with Embedded WLAN Antennas, page 1-20](#)

## Cisco 880 Series Data Routers

The Cisco 880 series data routers provide integrated VPN, embedded Wi-Fi CERTIFIED™, 802.11b/g/n-compliant wireless AP, 3G, and backup capabilities. [Figure 1-8](#) through [Figure 1-11](#) show the features available on Cisco 880 series data routers. Some of the features shown may not be available on your router.

Depending on the router model, the primary WAN port can be G.SHDSL, VDSL<sub>o</sub>POTS, VDSL/ADSL over ISDN, VDSL/ADSL over POTS, or 10/100 FE. See the [Cisco 880 Series Integrated Services Routers](#) data sheet for the WAN interface that is supported on your router.

[Figure 1-8](#) shows the front panel details of the Cisco 880 wireless data router. The USB port and the 3G card slot are located on the front panel.

**Figure 1-8 Front Panel of the Cisco 880 Series Wireless Data Router**

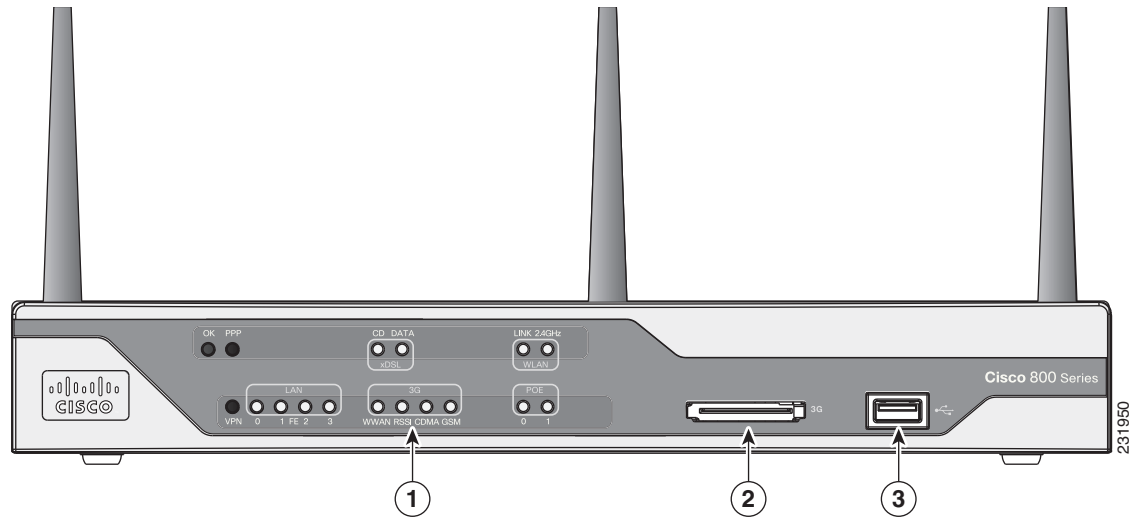

<b>1</b>	LEDs	<b>3</b>	USB port
<b>2</b>	3G express card slot—Supports third-party <sup>1</sup> 3G card (Cisco 880G models only)		

1. See the *Cisco 880 Series Integrated Services Routers* data sheet for supported vendors.

Figure 1-9 shows the back panel details of the Cisco 886VA data router.

**Figure 1-9 Back Panel of the Cisco 886VA Router**

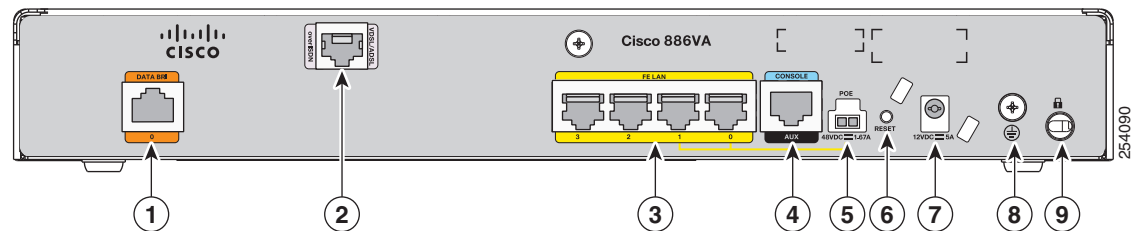

<b>1</b>	Data BRI <sup>1</sup> 0	<b>6</b>	Reset button
<b>2</b>	Primary WAN port—VDSL/ADSL over ISDN	<b>7</b>	Power connector
<b>3</b>	4-port 10/100 Ethernet switch <sup>2</sup>	<b>8</b>	Earth ground connection
<b>4</b>	Serial port—console or auxiliary	<b>9</b>	Kensington security slot
<b>5</b>	PoE power connector—optional		

1. BRI = Basic rate interface.

2. Ports 0 and 1 provide PoE with the optional PoE module installed.



**Caution** The primary WAN port is designed for an RJ-45 connector only. Damage to the primary WAN port may occur if a non-RJ-45 connector is inserted.

Figure 1-10 shows the back panel details of the Cisco 887VA and 886VA-M data router.

Figure 1-10 Back Panel of the Cisco 887VA and 887VA-M Router

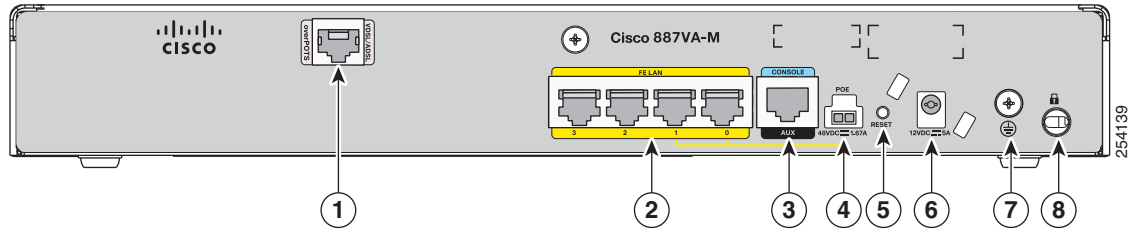

1	Primary WAN port—VDSL/ADSL over POTS <sup>1</sup>	5	Reset button
2	4-port 10/100 Ethernet switch <sup>2</sup>	6	Power connector
3	Serial port—console or auxiliary	7	Earth ground connection
4	PoE power connector—optional	8	Kensington security slot

1. 887VA-M has Annex M support.
2. Ports 0 and 1 provide PoE with the optional PoE module installed.

**Caution** For the Cisco 887VA, the primary WAN port is designed for an RJ-11 connector only. Damage to the primary WAN port may occur if a non-RJ-11 connector is inserted.

Figure 1-11 shows the back panel details of the Cisco 888W data router. Nonwireless routers do not have antennas on the back panel. However, the feature locations are similar across all Cisco 880 series data routers.

Figure 1-11 Back Panel of the Cisco 888W Data Router

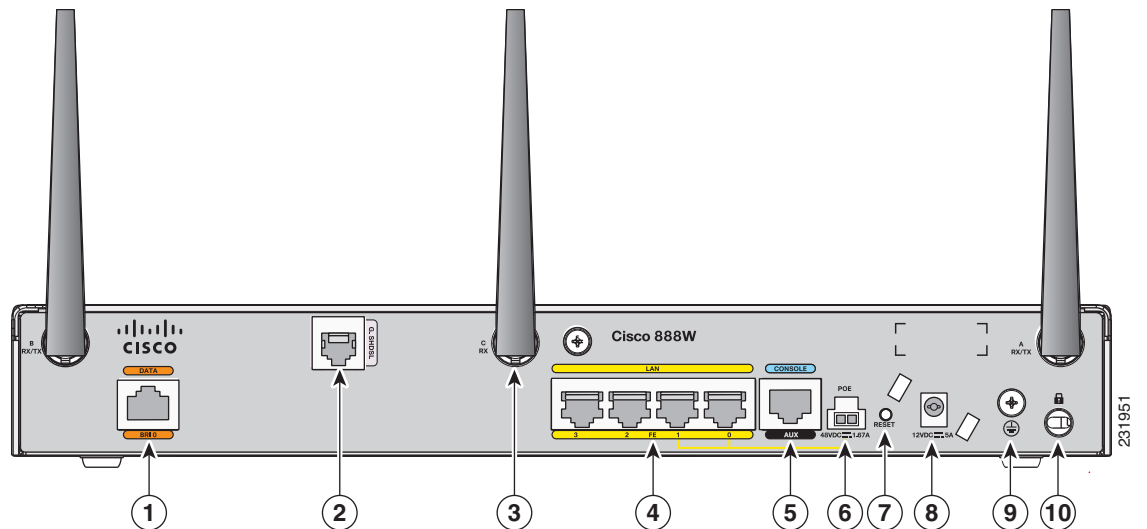

<b>1</b>	ISDN port—not available on 3G models	<b>6</b>	PoE power connector for optional PoE module <sup>1</sup>
<b>2</b>	Primary WAN port <sup>2</sup> —G.SHDSL, VDSL <sub>o</sub> POTS, ADSL <sub>o</sub> POTS, ADSL <sub>o</sub> ISDN, or 10/100 FE	<b>7</b>	Reset button
<b>3</b>	Antenna—captive omnidirectional dipole WLAN antenna (wireless models only)	<b>8</b>	Power connector
<b>4</b>	4-port 10/100 Ethernet switch	<b>9</b>	Earth ground connection
<b>5</b>	Serial port—console or auxiliary	<b>10</b>	Kensington security slot

1. The Cisco 880 series ISRs can include an optional PoE module that provides power to 802.3af-compliant devices connected to ethernet ports 0 and 1. If this feature was not configured with the factory order, you must order and install it to enable the PoE function.
2. Depending on the router model, the primary WAN port can be G.SHDSL, VDSL<sub>o</sub>POTS, or 10/100 FE. The VDSL<sub>o</sub>POTS port is in the same location as the G.SHDSL port. The 10/100 FE WAN port is located at the bottom left corner. See [Figure 1-2](#) for the location of the 10/100 FE WAN port.

## Cisco 880 Series Voice and Data Routers

The Cisco 880 series voice and data routers provide both voice and data ports. The voice ports managed voice services that interface with Foreign Exchange Station (FXS), Foreign Exchange Office (FXO), or BRI connections.

### Cisco 881 SRST and Cisco 888 SRST

[Figure 1-12](#), [Figure 1-13](#), and [Figure 1-14](#) show the features available on the Cisco 881 SRST and Cisco 888 SRST routers. The features available vary, depending on the router model. Some features may not be available on your router.

Depending on the router model, the primary WAN port can be either G.SHDSL or 10/100 FE. See the [Cisco 880 Series Integrated Services Routers](#) data sheet for the WAN interface and voice ports that are supported on your router.

Figure 1-12 shows the front panel details of the Cisco 881 SRST and Cisco 888 SRST wireless voice router.

**Figure 1-12** Front Panel of the Cisco 881 SRST and Cisco 888 SRST Wireless Voice Router

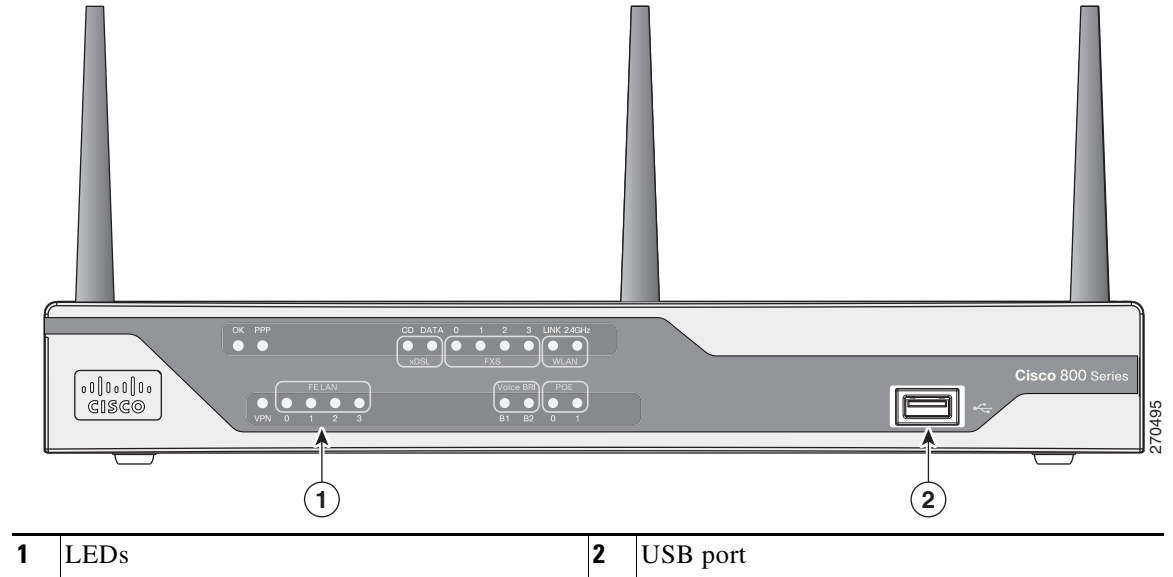
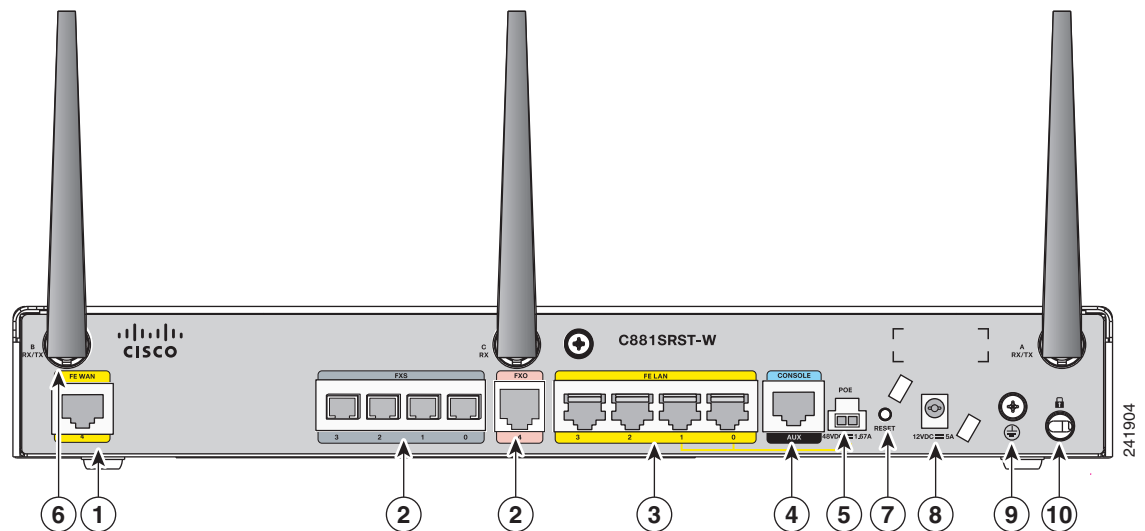

Figure 1-13 shows the back panel details of the Cisco 881SRST-W voice router.

**Figure 1-13 Back Panel of the Cisco C881SRST-W Voice Router**



<b>1</b>	Primary WAN port <sup>1</sup> —10/100 FE	<b>6</b>	Antenna—captive wireless omnidirectional dipole WLAN antenna (wireless models only)
<b>2</b>	Voice ports—four FXS <sup>2</sup> /DID <sup>3</sup> ports, one FXO <sup>4</sup> port with TBP <sup>5</sup> power failover	<b>7</b>	Reset button
<b>3</b>	4-port 10/100 Ethernet switch <sup>6</sup>	<b>8</b>	Power connector
<b>4</b>	Serial port—console or auxiliary	<b>9</b>	Earth ground connection
<b>5</b>	PoE power connector for optional PoE module <sup>7</sup>	<b>10</b>	Kensington security slot

1. Depending on the router model, the primary WAN port can be either G.SHDL or 10/100 FE.

2. FXS = Foreign Exchange Station.

3. DID = Direct Inward Dialing.

4. FXO = Foreign Exchange Office.

5. TBP = trunk bypass.

6. Ports 0 and 1 provide PoE with the optional PoE module installed

7. The Cisco 880 series ISRs can include an optional PoE module that provides power to 802.3af-compliant devices connected to ethernet ports 0 and 1. If this feature was not configured with the factory order, you must order and install the Field Replaceable Unit (FRU) to enable the PoE function. For this you either need the FRU “800-IL-PM=2” or “800G2-POE-2”. If your device has a separate PoE inlet, use the 800-IL-PM=2, if it has one combined inlet (a description saying “POE OPTION REQUIRES 5A POWER ADAPTOR”), then use the 800G2-POE-2.



Figure 1-14 shows the back panel details of the Cisco 888SRST-W voice router.

**Figure 1-14 Back Panel of the Cisco C888SRST-W Voice Router**

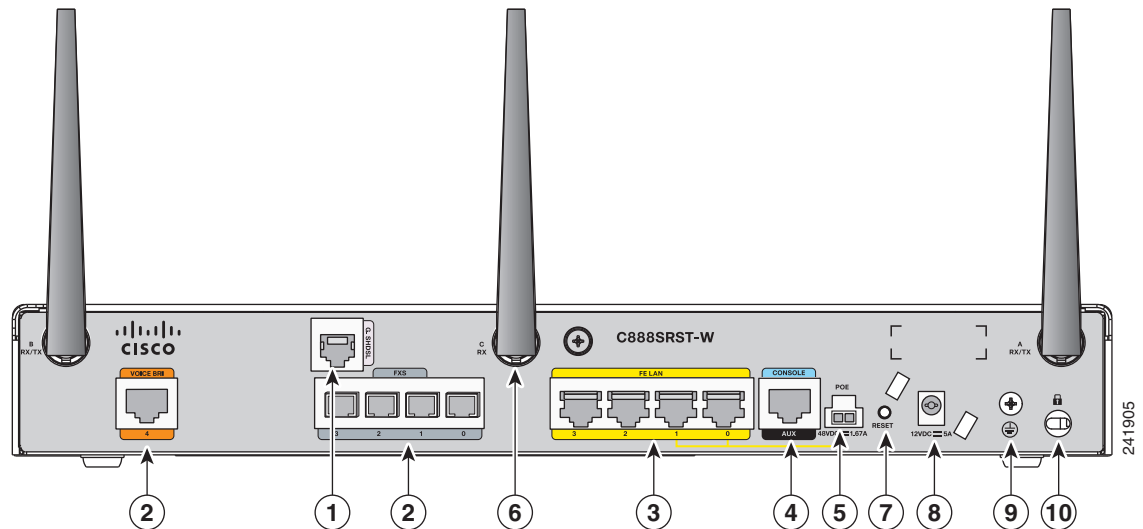

<b>1</b>	Primary WAN port <sup>1</sup> —G.SHDSL	<b>6</b>	Antenna—captive wireless omnidirectional dipole WLAN antenna (wireless models only)
<b>2</b>	Voice ports—four FXS/DID ports and one voice BRI port	<b>7</b>	Reset button
<b>3</b>	4-port 10/100 Ethernet switch <sup>2</sup>	<b>8</b>	Power connector
<b>4</b>	Serial port—console or auxiliary	<b>9</b>	Earth ground connection
<b>5</b>	PoE power connector for optional PoE module <sup>3</sup>	<b>10</b>	Kensington security slot

1. Depending on the router model, the primary WAN port can be either G.SHDL or 10/100 FE.
2. Ports 0 and 1 provide PoE with the optional PoE module.
3. The Cisco 880 series ISRs can include an optional PoE module that provides power to 802.3af-compliant devices connected to ethernet ports 0 and 1. If this feature was not configured with the factory order, you must order and install the Field Replaceable Unit (FRU) to enable the PoE function. For this you either need the FRU “800-IL-PM=2” or “800G2-POE-2”. If your device has a separate PoE inlet, use the 800-IL-PM=2, if it has one combined inlet (a description saying “POE OPTION REQUIRES 5A POWER ADAPTOR”), then use the 800G2-POE-2.



**Caution**

The primary WAN port on all 888E models is designed for an RJ-45 connector only. Damage to the primary WAN port may occur if a non-RJ-45 connector is inserted.

## Cisco 881-V, Cisco 887VA-V, and Cisco 887VA-V-W

Figure 1-15, Figure 1-16, and Figure 1-17 show the features available on the Cisco 881-V and Cisco 887VA-V routers. The features available vary, depending on the router model. Some features may not be available on your router.

The Cisco 881-V and Cisco 887VA-V voice and data series gives you the flexibility to use either FXS or BRI voice ports. However, the number of concurrent calls that can be supported by the router is limited by the codec complexity setting on the router. Table 1-7 lists the maximum number of calls that is supported when the **codec complexity** command is configured for Flexible, Medium or High complexity.



### Note

Configuring the codec complexity setting to support secure calls uses DSP resources, but does not affect the maximum number of supported calls.

**Table 1-7** Maximum Number of Supported Calls

	Flexible Complexity	Medium Complexity	High Complexity
C881-V	9	8	6
C887VA-V	8	8	6
C887VA-V-W	8	8	6

Figure 1-15 shows the front panel details of the Cisco 881-V, Cisco 887VA-V, and Cisco 887VA-V-W.

**Figure 1-15** Front Panel of the Cisco 881-V, Cisco 887VA-V, and Cisco 887VA-V-W Routers

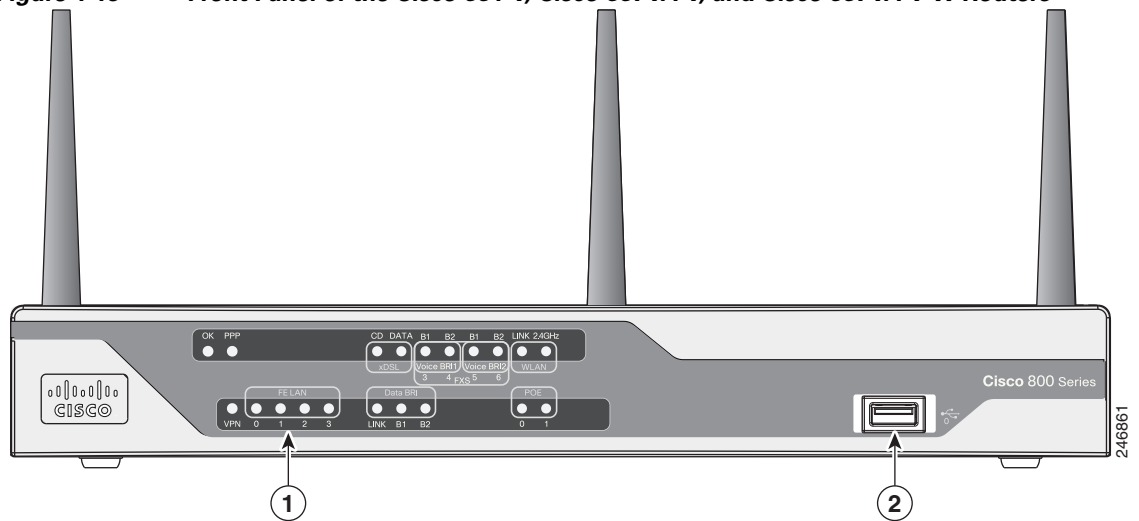

<b>1</b>	LEDs	<b>2</b>	USB port
----------	------	----------	----------

Figure 1-16 shows the back panel for the Cisco 887VA-V-W router. The Cisco 887VA-V (non-wireless) router does not have the antennas on the back panel.

Figure 1-16 Back Panel of the Cisco 887 VA-V Router

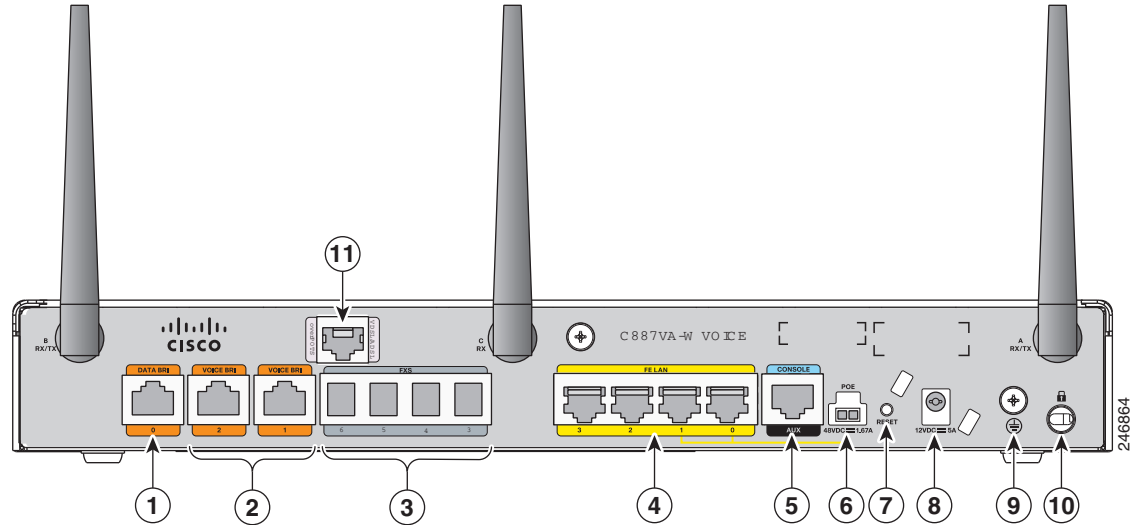

1	Data BRI	7	Reset Button
2	Voice BRI	8	Power connector
3	Voice ports—four FXS/DID ports	9	Earth ground connection
4	Fast Ethernet LAN—four ports	10	Kensington security slot
5	Console Port	11	Primary WAN port—VDSL/ADSL over POTS
6	PoE power connector (optional)		

Figure 1-17 shows the back panel for the Cisco 881-V router.

Figure 1-17 Back Panel of the Cisco 881-V Router

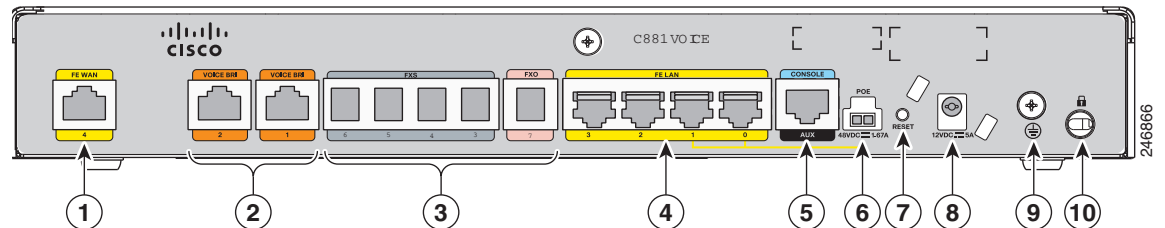

1	Fast Ethernet WAN port	6	PoE power connector (optional)
2	Voice BRI ports	7	Reset button
3	Voice ports—four FXS/DID ports and one FXO port.	8	Power connector
4	Fast Ethernet LAN—four ports	9	Earth ground connection
5	Console Port	10	Kensington security slot

## Cisco 880 Series with Embedded WLAN Antennas

Some Cisco 880W, 880WD, and 880-WD ISRs have three embedded WLAN antennas.

These ISRs are fixed-platform routers that:

- Provide integrated VPN, embedded Wi-Fi CERTIFIED™, 802.11b/g/n-compliant wireless AP, and backup capabilities.
- Use single-band (2.4 GHz) WLAN cards or dual-band (2.4 GHz and 5 GHz) WLAN cards.
- Require a single external power supply: a 30-W power supply for non-POE-enabled routers or a 60-W power supply for POE-enabled routers.
- Have a fixed 512 MB of system memory.

For information on configuring the Cisco 880 series ISRs, see [Cisco 880 Series Integrated Services Router Software Configuration Guide](#).

## Cisco 887VA-WD

Figure 1-18 shows the front panel details of the C887VA-WD-A-K9 and C887VA-WD-E-K9 ISRs. The front panel has LEDs only. All the ports are in the back panel.

**Figure 1-18** Front Panel of the C887VA-WD-A-K9 and C887VA-WD-E-K9 ISRs

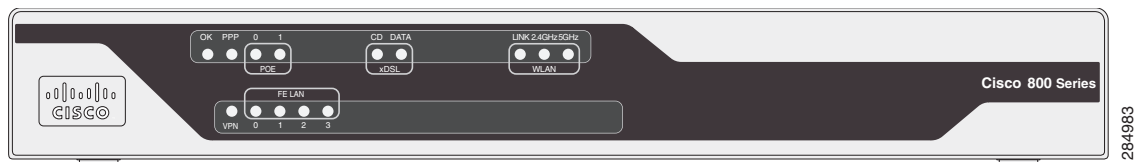
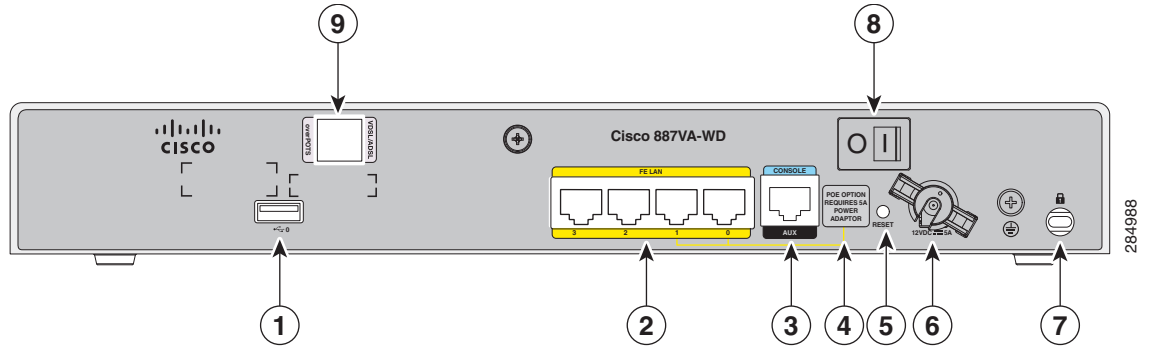

Figure 1-19 shows the back panel details of the C887VA-WD-A-K9 and C887VA-WD-E-K9 ISRs.

Figure 1-19 Back Panel of the C887VA-WD-A-K9 and C887VA-WD-E-K9 ISRs



1	USB port	6	Power connector
2	4-port 10/100 Ethernet switch	7	Kensington security slot
3	Serial port—console or auxiliary	8	Power switch
4	<b>Note</b> No separate PoE power supply is required for routers with embedded WLAN antennas. For information on system power supply requirements when PoE is enabled, see the “Power over Ethernet Module” section on page 1-43.	9	VDSL/ADSL port
5	Reset button		

## C881WD

Figure 1-20 shows the front panel details of the C881WD-A-K9 and C881WD-E-K9 ISRs. The front panel has LEDs only. All the ports are in the back panel.

Figure 1-20 Front Panel of the C881WD-A-K9 and C881WD-E-K9 ISRs

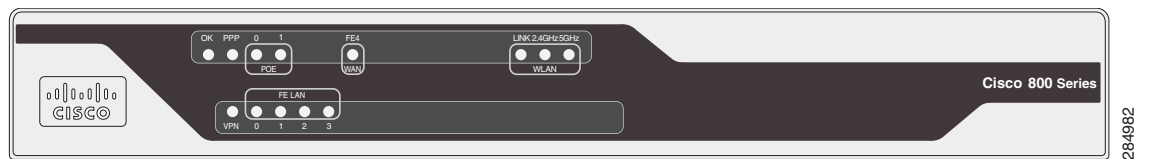
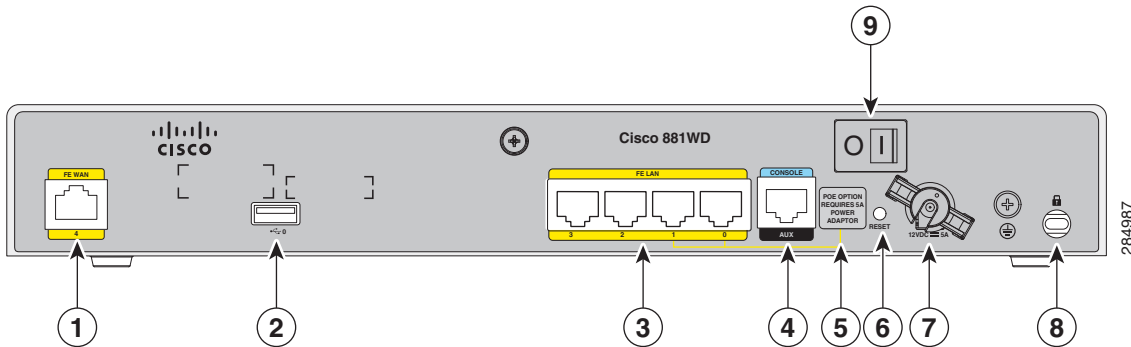

Figure 1-21 shows the back panel details of the C881WD-A-K9 and C881WD-E-K9 ISRs.

Figure 1-21 Back Panel of the C881WD-A-K9 and C881WD-E-K9 ISRs



1	Primary WAN port—10/100 FE	6	Reset button
2	USB port	7	Power connector
3	4-port 10/100 Ethernet switch	8	Kensington security slot
4	Serial port—console or auxiliary	9	Power switch
5	<b>Note</b> No separate PoE power supply is required for routers with embedded WLAN antennas. For information on system power supply requirements when PoE is enabled, see the <a href="#">“Power over Ethernet Module”</a> section on page 1-43.		

## Cisco 890 Series ISRs

### Cisco 891, Cisco 892, and Cisco 892F

The Cisco 891, Cisco 892, and Cisco 892F ISRs have the following features:

- Integrated 8-port 10/100 Ethernet switch for connecting to the LAN
- 10/100 FE and 10/100/1000 Gigabit Ethernet (GE) port for connecting to the WAN
- Separate console and auxiliary ports
- Optional embedded Wi-Fi CERTIFIED™ dual radio 802.11a/b/g/n-compliant wireless AP
- Optional 4-port PoE



**Note** The Cisco 890 series ISRs can include an optional PoE module that provides power to 802.3af-compliant devices connected to ethernet ports 0 through 3. If this feature was not configured with the factory order, you must order and install it to enable the PoE function.

- Security feature card (SFC) socket
- DIMM expansion socket that can accept up to 512 MB of additional memory, for a total of 768 MB system memory in Cisco 891 and 892 series ISRs, and a total of 1 GB system memory in Cisco 892F series ISRs
- Three reverse-polarity threaded Neill-Concelman (RP-TNC) connectors on the back panel for non-captive dual-band WLAN antenna (wireless models only)
- Support for the AIM2-CUE-K9 and AIM2-APPRE-104-K9
- GE small-form-factor pluggable (SFP) port (Cisco 892F series ISRs only)

The following feature is located on the front panel:

- Two USB 2.0 ports

Figure 1-22 shows the front panel details of the Cisco 890 wireless router.

**Figure 1-22 Front Panel of the Cisco 890 Series Wireless ISR**

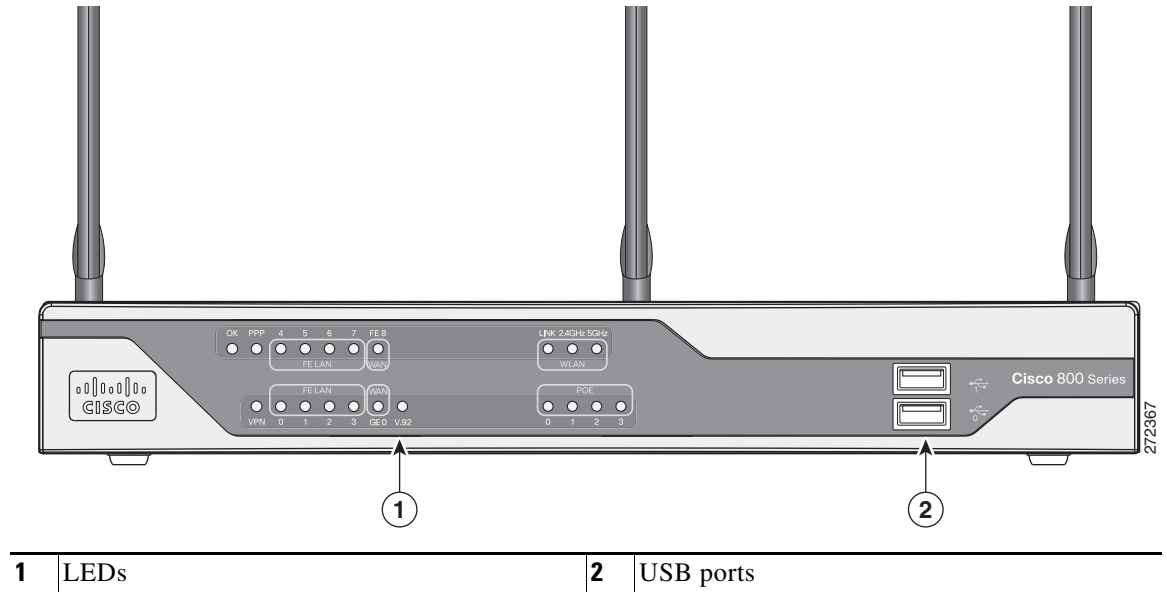
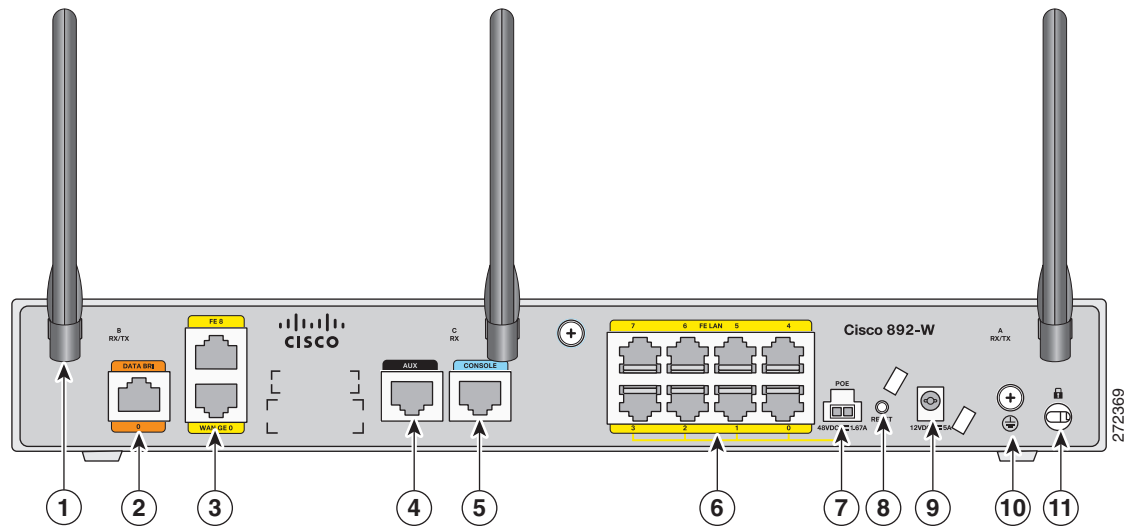

Figure 1-23 shows the back panel details of the Cisco 892-W router. Nonwireless routers do not have RP-TNC antennas or connectors on the back panel. Some of the features that are shown may not be available on your router. However, the feature locations are similar across all Cisco 890 series routers.

**Figure 1-23 Back Panel of the Cisco 892-W Router**



<b>1</b>	Antenna—dipole swivel antenna attached to RP-TNC connectors (wireless models only)	<b>7</b>	PoE power connector for optional PoE module <sup>1</sup>
<b>2</b>	Backup—Data BRI <sup>2</sup> or V.92 <sup>3</sup> port	<b>8</b>	Reset button
<b>3</b>	Primary WAN port—FE and GE	<b>9</b>	Power connector
<b>4</b>	Auxiliary port	<b>10</b>	Earth ground connection
<b>5</b>	Console port	<b>11</b>	Kensington security slot
<b>6</b>	8-port 10/100 Ethernet switch		

1. The Cisco 890 series ISRs can include an optional PoE module that provides power to 802.3af-compliant devices connected to ethernet ports 0 through 3. If this feature was not configured with the factory order you must order and install it to enable the PoE function.
2. The Data BRI port is available only on the Cisco 892 router models.
3. The V.92 port (not shown) is available only on the Cisco 891 router models and is located between the console port and the Ethernet switch.



Figure 1-24 shows the location of the SFP port in a Cisco 892F-W router.

**Figure 1-24 SFP Port Location in a Cisco 892F-W Router**

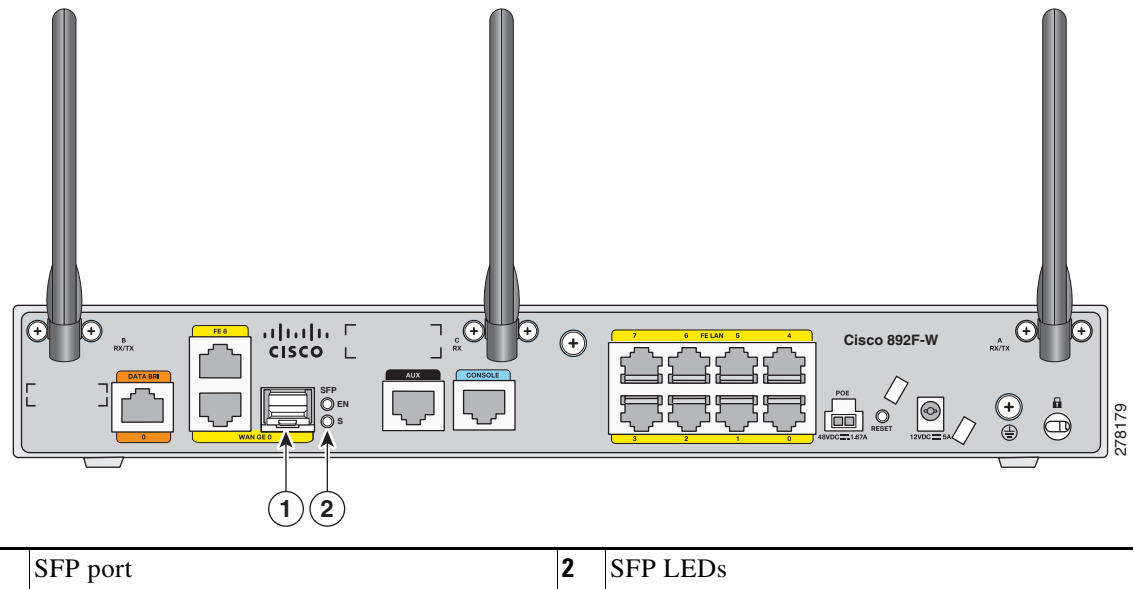

## Cisco 892FSP, Cisco 896VA, Cisco 897VA, and Cisco 898EA

The Cisco 892FSP, 896VA, 897VA (897VA, 897VAM, 897VAW, 897VAMW), and 898EA routers have the following features:

- Integrated 8-port 10/100/1000 Gigabit Ethernet (GE) switch for connecting to the LAN
- Two 10/100/1000 GE ports for the Cisco 892FSP
- One 10/100/1000 GE port for the Cisco 896VA, 897VA, and the Cisco 898EA. Either the SFP socket or the 10/100/1000 GE port can be active at a given time, but not both.
- Single console and auxiliary ports for configuration and management
- 512 MB of on-board memory (upgrade option to 1 GB)
- 256 MB flash memory for the Cisco 896VA, 897VA, and Cisco 898EA
- One USB 2.0 port
- Optional internal adapter for inline PoE on 4 switch ports for IP phones or external wireless access points for Cisco 896VA, 897VA, and 898EA models only. No PoE support on Cisco 892FSP.



### Note

The Cisco 892FSP does not support AIM2-CUE-K9 and AIM2-APPRE-104-K9 because it does not have an SFC socket.

Figure 1-25 shows the back panel of the Cisco 892FSP router.

**Figure 1-25 Back Panel of the Cisco 892FSP Router**

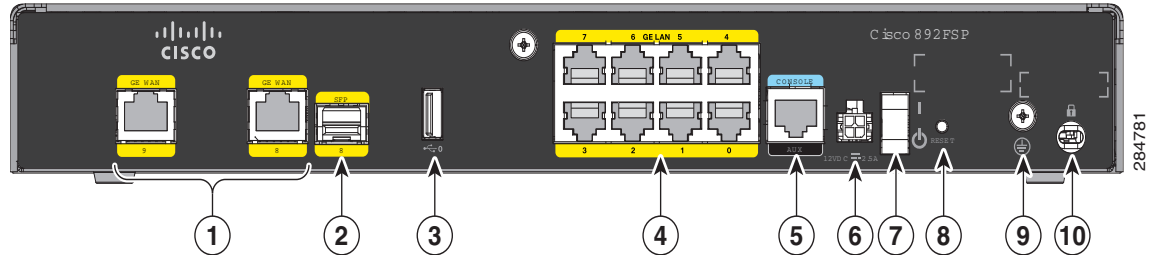

1	GE WAN interface	6	Power connector
2	SFP port	7	On/Off switch
3	USB port	8	Reset button
4	8-port Gigabit Ethernet switch	9	Earth ground connection
5	Console / Auxiliary port	10	Kensington security slot

Figure 1-26 shows the front panel of the Cisco 892FSP router.

**Figure 1-26 Front Panel of the Cisco 892FSP Router**

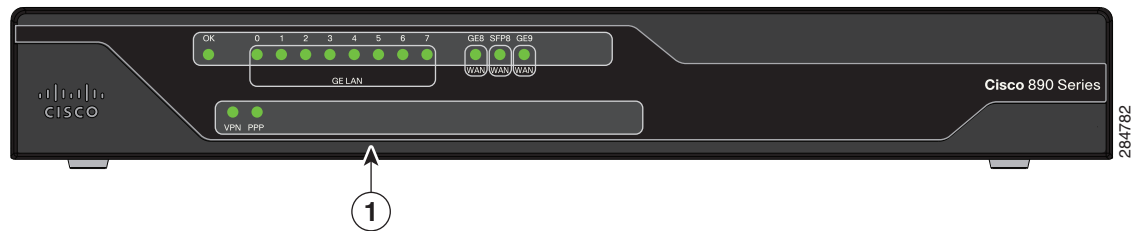

1	LEDs
---	------

Figure 1-27 shows the back panel of the Cisco 896VA router.

Figure 1-27 Back Panel of the Cisco 896VA Router

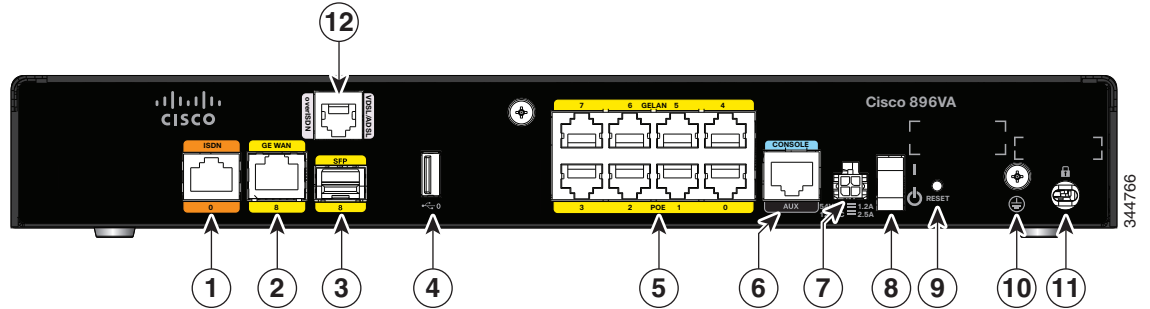

1	ISDN	7	Power connector
2	GE WAN interface	8	On/Off switch
3	SFP port	9	Reset button
4	USB port	10	Earth ground connection
5	8-port Gigabit Ethernet switch <sup>1</sup>	11	Kensington security slot
6	Console / Auxiliary port	12	VDSL / ADSL over ISDN

1. Port 0 through 3 can be configured as POE. POE is an optional feature for this model. If this feature was not configured with the factory order, you must order and install it to enable the PoE function.

Figure 1-28 shows the front panel of the Cisco 896VA and the Cisco 897VA router.

Figure 1-28 Front Panel of the Cisco 896VA and Cisco 897VA Router

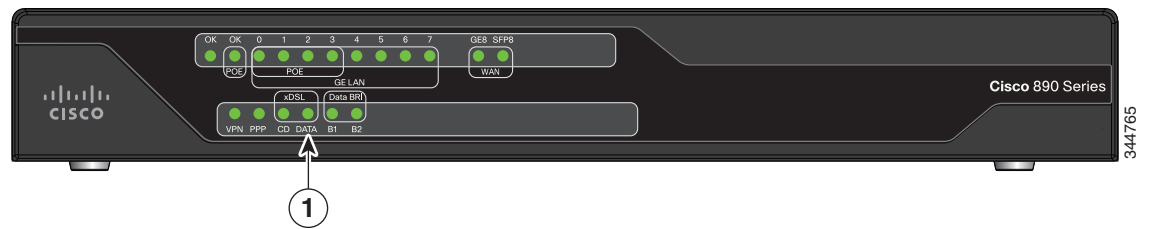

1	LEDs
---	------

Figure 1-29 shows the back panel of the Cisco 897VA router.

**Figure 1-29 Back Panel of the Cisco 897VA Router**

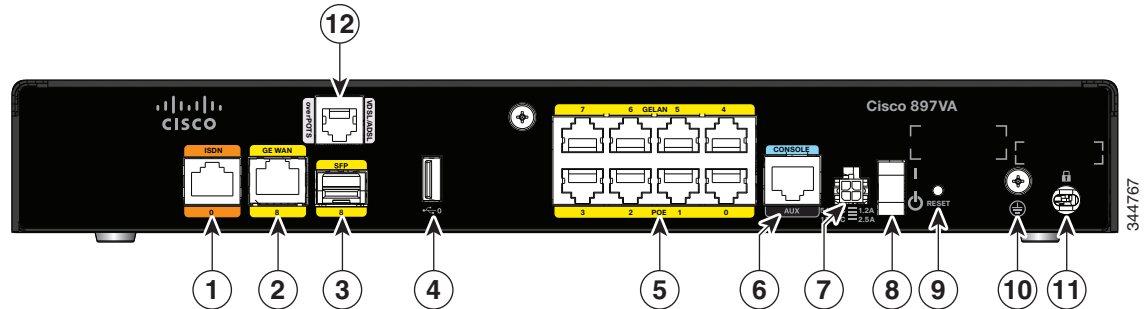

1	ISDN	7	Power connector
2	GE WAN interface	8	On/Off switch
3	SFP port	9	Reset button
4	USB port	10	Earth ground connection
5	8-port Gigabit Ethernet switch <sup>1</sup>	11	Kensington security slot
6	Console / Auxiliary port	12	VDSL / ADSL over POTS

1. Port 0 through 3 can be configured as POE. POE is an optional feature for this model. If this feature was not configured with the factory order, you must order and install it to enable the PoE function.

Figure 1-30 shows the back panel of the Cisco 897VAM router.

**Figure 1-30 Back Panel of the Cisco 897VAM Router**

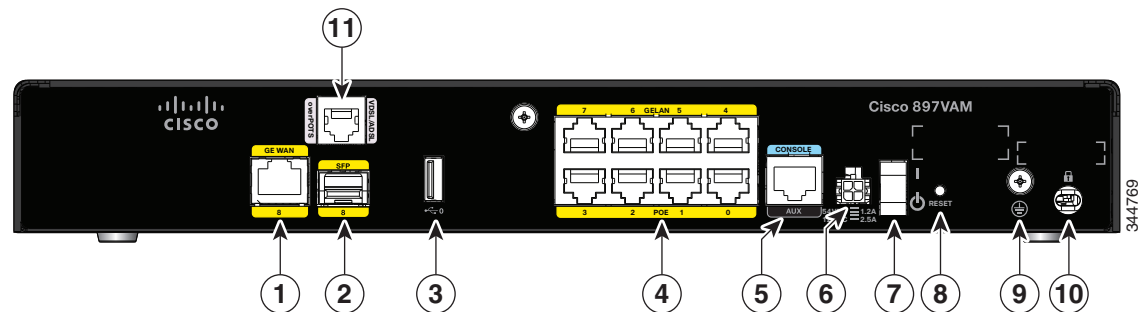

1	GE WAN interface	7	On/Off switch
2	SFP port	8	Reset button
3	USB port	9	Earth ground connection

4	8-port Gigabit Ethernet switch <sup>1</sup>	10	Kensington security slot
5	Console / Auxiliary port	11	VDSL / ADSL over POTS
6	Power connector		

1. Port 0 through 3 can be configured as POE. POE is an optional feature for this model. If this feature was not configured with the factory order, you must order and install it to enable the PoE function.

Figure 1-31 shows the front panel of the Cisco 897VAM router.

Figure 1-31 Front Panel of the Cisco 897VAM Router

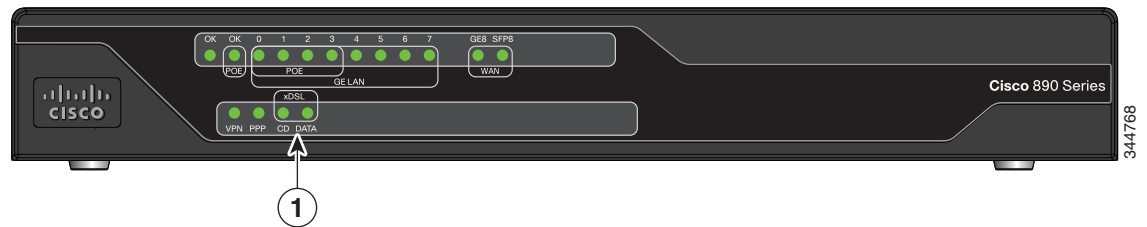

1	LEDs
---	------

Figure 1-32 shows the back panel of the Cisco 897VAW router.

Figure 1-32 Back Panel of the Cisco 897VAW Router

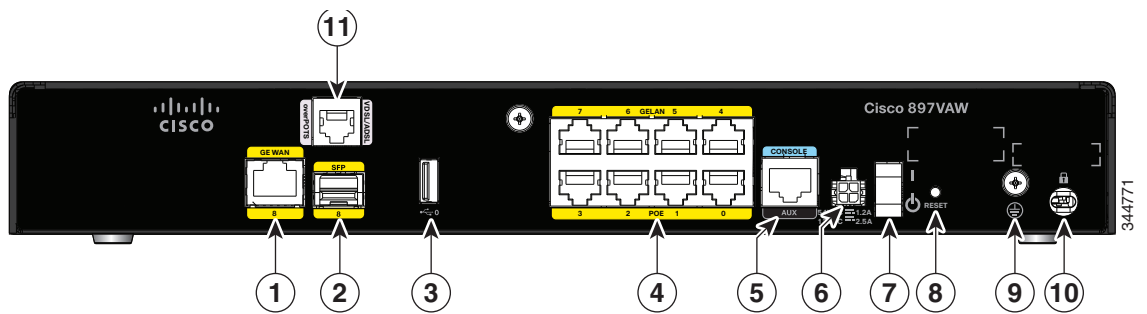

1	GE WAN interface	7	On/Off switch
2	SFP port	8	Reset button
3	USB port	9	Earth ground connection
4	8-port Gigabit Ethernet switch <sup>1</sup>	10	Kensington security slot
5	Console / Auxiliary port	11	VDSL / ADSL over POTS
6	Power connector		

1. Port 0 through 3 can be configured as POE. POE is an optional feature for this model. If this feature was not configured with the factory order, you must order and install it to enable the PoE function.

Figure 1-33 shows the front panel of the Cisco 897VAW and the Cisco 897VAMW router.

Figure 1-33 Front Panel of the Cisco 897VAW and the Cisco 897VAMW Router

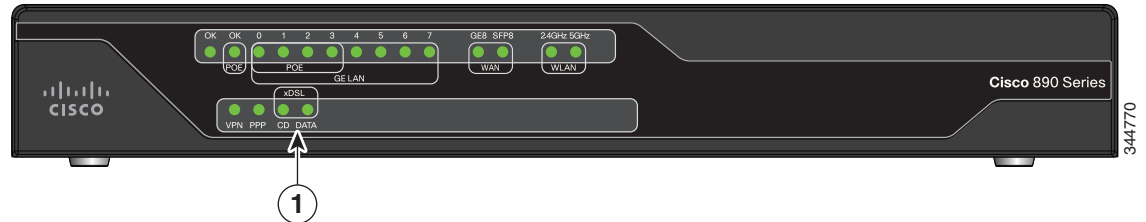

1	LEDs
---	------

Figure 1-34 shows the back panel of the Cisco 897VAMW router.

Figure 1-34 Back Panel of the Cisco 897VAMW Router

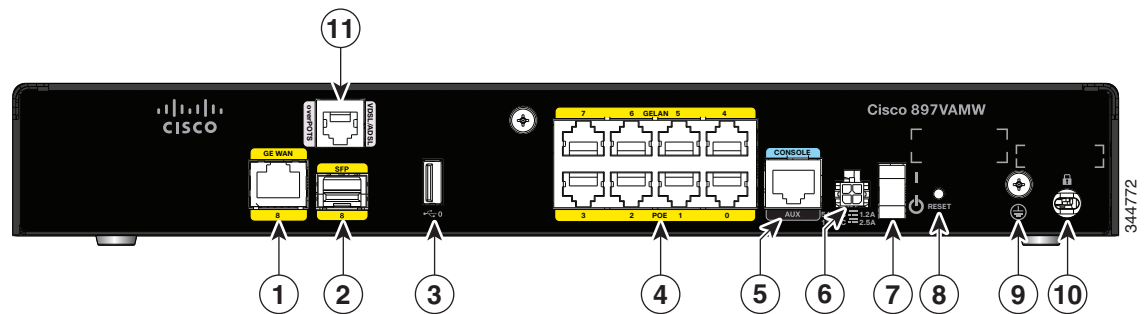

1	GE WAN interface	7	On/Off switch
2	SFP port	8	Reset button
3	USB port	9	Earth ground connection
4	8-port Gigabit Ethernet switch <sup>1</sup>	10	Kensington security slot
5	Console / Auxiliary port	11	VDSL / ADSL over POTS
6	Power connector		

1. Port 0 through 3 can be configured as POE. POE is an optional feature for this model. If this feature was not configured with the factory order, you must order and install it to enable the PoE function.

Figure 1-35 shows the back panel of the Cisco 898EA router.

Figure 1-35 Back Panel of the Cisco 898EA Router

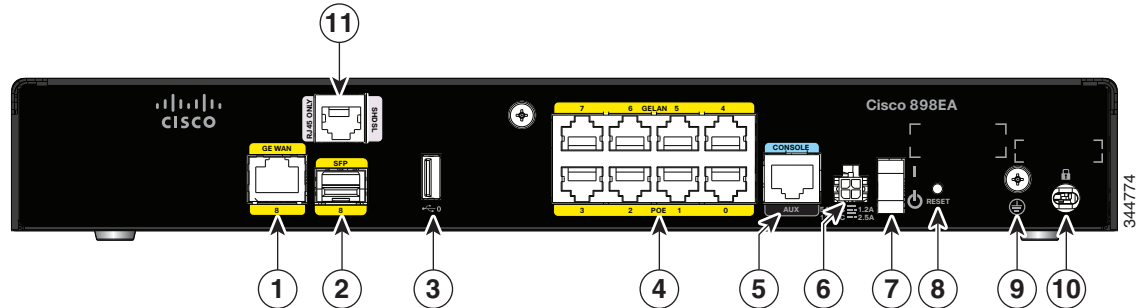

1	GE WAN interface	7	On/Off switch
2	SFP port	8	Reset button
3	USB port	9	Earth ground connection
4	8-port Gigabit Ethernet switch <sup>1</sup>	10	Kensington security slot
5	Console / Auxiliary port	11	SHDSL (RJ45 Only)
6	Power connector		

1. Port 0 through 3 can be configured as POE. POE is an optional feature for this model. If this feature was not configured with the factory order, you must order and install it to enable the PoE function.



**Caution** The primary WAN port is designed for an RJ-45 connector only. Damage to the primary WAN port may occur if a non-RJ-45 connector is inserted.

Figure 1-36 shows the front panel of the Cisco 898EA router.

Figure 1-36 Front Panel of the Cisco 898EA Router

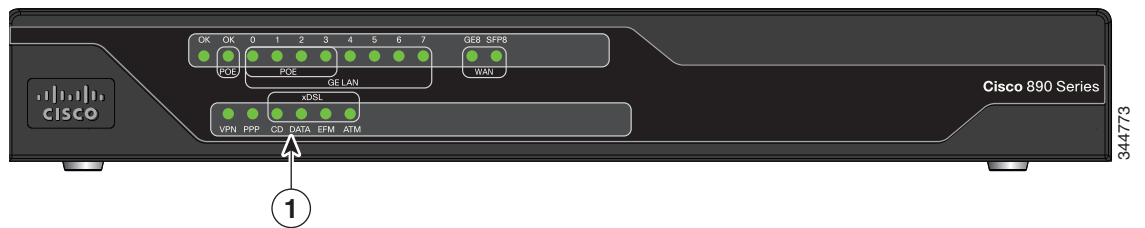

1	LEDs
---	------

# Hardware Features

This section provides an overview of the following hardware features for the Cisco 860 series, 880 series, and 890 series ISRs. A feature summary is available at the end of this section.

- [Kensington Lock](#)
- [Reset Button](#)
- [LEDs](#)
- [Memory](#)
- [USB Port](#)
- [Fan](#)
- [Power over Ethernet Module](#)
- [3G Cellular Data WAN Connectivity](#)
- [Wireless LAN Connectivity](#)
- [Small Form-Factor Pluggable Port](#)
- [Feature Summary](#)

## Kensington Lock

A Kensington security slot is located on the router back panel. To secure the router to a desktop or other surface, use the Kensington lockdown equipment.

## Reset Button

The Reset button is used to restore the router to the factory default configuration or to load a custom configuration file.

There are two different ways to do this:

1. by pressing the Reset button within 5 seconds of powering up the router; or
2. by pressing the Reset button for 5 seconds while running IOS.

**Note**

---

If you execute a **CLI reboot** command while the embedded wireless AP is running Cisco Unified IOS software, the router reboots, but the AP continues running. Clients with Cisco Unified IOS software are controlled by a wireless LAN controller (WLC) and can be reset only by the controller.

---

## Cisco 860VAE Routers—Custom Configuration File

On Cisco 860VAE routers, the reset button can be used to load a custom configuration file without having to use the CLI. The configuration file can be located on an external USB flash drive or on the router's compact flash.



The custom configuration file must be named one of the following:

- customer-config
- SN-customer-config

where “SN” is the unique hardware serial number.

When the system attempts to load a custom configuration file, configuration files on a USB flash drive have priority over configuration files on the router's flash drive and the “SN-customer-config” file name has priority over the “customer-config” file name. The priority for loading a configuration file is as follows:

1. USB flash0: SN-customer-config
2. USB flash0: customer-config
3. Router flash: SN-customer-config
4. Router flash: customer-config

If the router does not find a valid custom configuration file, the system aborts the process.

To reset the router to the factory default configuration, follow these steps:

- 
- Step 1** Verify that IOS is running correctly by checking that the system status LED is on.
- Step 2** Press and hold the Reset button until the system status LED begins to flash. Typically, this occurs within 5 seconds.

The router reloads itself after the startup configuration has been replaced with the new customer configuration.

---

## Custom Configuration File for Cisco 892FSP, 896VA, 897VA, and Cisco 898EA

For the first method, the configuration file can be located on the router's compact flash or on the router's nvram. The custom configuration file must use **cfg** as the filename extension.

When the system attempts to load a custom configuration file, configuration files on nvram have priority over configuration files on the router's compact flash.

The priority for loading a configuration file is as follows:

1. nvram: \*.cfg
2. Router flash: \*.cfg

If the router does not find a valid custom configuration file, the system aborts the process.

To reset the router to the factory default configuration or to load a custom configuration file, follow these steps:

- 
- Step 1** Turn the power on.
- Step 2** Press and hold the Reset button until the system status LED begins to flash. Typically, this occurs within 5 seconds.

The router reloads itself after the startup configuration has been replaced with the new customer configuration.

---

For the second method, the configuration file can be located on an external USB flash drive or on the router's compact flash.

The custom configuration file must be named one of the following:

- customer-config
- customer-config.SN ?

where "SN" is the unique hardware serial number.

When the system attempts to load a custom configuration file, configuration files on a USB flash drive have priority over configuration files on the router's flash drive and the "customer-config.SN" file name has priority over the **customer-config** file name.

The priority for loading a configuration file is as follows:

1. usbflash0:customer-config.SN
2. usbflash0:customer-config
3. Router flash:customer-config.SN
4. Router flash:customer-config

If the router does not find a valid custom configuration file, the system aborts the process.

To reset the router to the factory default configuration or to load a custom configuration file, follow these steps:

- 
- Step 1** Verify that IOS is running correctly by checking that the system status LED is on.
- Step 2** Press and hold the Reset button until the system status LED begins to flash. Typically, this occurs within 5 seconds.

The router reloads itself after the startup configuration has been replaced with the new customer configuration.

---

## LEDs

The LEDs are located on the front panel of the router.

- [Table 1-8](#) describes the LEDs for the Cisco 860 series, 880 series, and 890 series ISRs.
- [Table 1-9](#) lists the LED descriptions for the Cisco 866VAE, Cisco 867VAE, Cisco 866VAE-K9, and Cisco 867VAE-K9 ISRs.
- [Table 1-10](#) lists the LED description for the Cisco 892FSP ISR, 896VA, 897VA, and 898EA.
- For a description of LEDs for Cisco 860VAE-W-A-K9, Cisco 860VAE-W-E-K9, and Cisco 860VAE-POE-W-A-K9 ISRs models, see the “[Cisco 860VAE-W-A-K9, Cisco 860VAE-W-E-K9, and Cisco 860VAE-POE-W-A-K9 ISRs](#)” section on page 1-6.

**Table 1-8 LED Descriptions for the Cisco 860 Series, Cisco 880 Series, and Cisco 890 Series ISRs**

LED	Color	Description	860 Series	880 Series	890 Series
Power OK	Green	On—DC power is being supplied to the router and the Cisco IOS software is running.  Blinking—Bootup is in process, or the router is in Rommon monitor mode.  Off—Power is not supplied to the router.	All models	All models	All models
Link Status FE0	Green	On—Ethernet port is connected.	All models	All models	All models
Link Status FE1		Blinking—Data is either being received or being transmitted.			
Link Status FE2		Off—Ethernet port is not connected.			
Link Status FE3					
Link Status FE4	Green	On—Ethernet port is connected.	—	—	All models
Link Status FE5		Blinking—Data is either being received or being transmitted.			
Link Status FE6		Off—Ethernet port is not connected.			
Link Status FE7					
FE WAN Port Link Status	Green	On—Port is connected.  Blinking—Data is either being received or being transmitted.  Off—Port is not connected.	861 models	881 models	All models
GE WAN Port Link Status	Green	On—Port is connected.  Blinking—Data is either being received or being transmitted.  Off—Port is not connected.	—	—	All models

**Table 1-8 LED Descriptions for the Cisco 860 Series, Cisco 880 Series, and Cisco 890 Series ISRs (continued)**

LED	Color	Description	860 Series	880 Series	890 Series
WLAN (2.4 GHz)	Green	On—Radio is connected, SSID <sup>1</sup> is configured, and client is associated, but no data is being received or being transmitted.  Slow blinking—Radio is connected, SSID is configured, and beacons are being transmitted.  Fast blinking—Data is either being received or being transmitted.  Off—Radio is shut down, and no SSID is configured.	Wireless models	Wireless models	Wireless models
WLAN (5 GHz)	Green	On—Radio is connected, SSID is configured, and client is associated, but no data is being received or being transmitted.  Slow blinking—Radio is connected, SSID is configured, and beacons are being transmitted.  Fast blinking—Data is either being received or being transmitted.  Off—Radio is shut down, and no SSID is configured.	—	Wireless models	Wireless models
WLAN LINK (Autonomous Mode)	Green	On—Wireless link is up.  Blinking—Ethernet link is up, and data is either being received or being transmitted.  Off—Wireless link is down.	Wireless models	Wireless models	Wireless models
WLAN LINK (Unified Mode)	Green	On—Ethernet link is up, and wireless access point (AP) is communicating with LWAPP <sup>2</sup> controller.  Blinking—Ethernet link is up, but wireless AP is not communicating with LWAPP controller.  Off—Ethernet link is down.	—	Wireless models	Wireless models
PoE	Green	On—PoE is connected and powered.  Off—PoE is not installed.	—	Models with PoE	Models with PoE
	Amber	On—Fault with the PoE.			
VPN	Green	On—VPN is connected.	—	All models	All models
PPP <sup>3</sup>	Green	On—At least one PPP session is established.	—	All models	All models
xDSL <sup>4</sup> CD	Green	On—The xDSL interface is connected to the DSLAM <sup>5</sup> .  Blinking—Training to the line.  Off—Indicates that a connection has not been established or the port is shut down.	—	887, 887VA, 887VA-M8 888 models	896VA, 897VA, 898EA
xDSL Data	Green	Blinking—The xDSL interface is either receiving or transmitting data.  Off—No data is being transmitted or being received.	—	887, 887VA, 887VA-M8 88 models	896VA, 897VA, 898EA
xDSL ATM	Green	On—The router is operating in ATM <sup>6</sup> mode.  Off—Not operating in ATM mode.	—	888E	—

**Table 1-8 LED Descriptions for the Cisco 860 Series, Cisco 880 Series, and Cisco 890 Series ISRs (continued)**

LED	Color	Description	860 Series	880 Series	890 Series
xDSL EFM	Green	Blink—The router is operating in EFM <sup>7</sup> mode. Off—Not operating in EFM mode.	—	—	898EA
Data BRI LINK	Green	On—ISDN D channel is connected.	—	887, 888 models	892 models
Data BRI B1	Green	Blinking—B1 channel is either receiving or sending data, or data is passing through ISDN channel 1.	—	887, 888 models	892 models
Data BRI B2	Green	Blinking—B2 channel is receiving or sending data, or data is passing through ISDN channel 2.	—	887, 887V, 888 models	892 models
3G <sup>8</sup> WWAN <sup>9</sup>	Green	On—Service is established. Slow Blinking—Searching for service. Fast Blinking—Data is either being received or being transmitted.	—	3G models	—
3G RSSI <sup>10</sup>	Green	Off—Low signal strength (lower than -100 dBm). On—High RSSI (-69 dBm or higher). Slow Blinking—Low or medium RSSI (-99 to -90 dBm). Fast Blinking—Medium RSSI (-89 to -70 dBm).	—	3G models	—
	Amber	On—No service.	—	3G models	—
3G GSM <sup>11</sup>	Green	On—Service is established. Off—No service.	—	3G models	—
3G CDMA <sup>12</sup>	Green	On—Service is established. Off—No service.	—	3G models	—
FXO Voice	Green	On—FXO port is connected. Blinking—FXO port is either receiving or transmitting data.	—	881 <sup>13</sup>	—
BRI Voice LNK	Green	On—BRI interface is connected.	—	—	—
BRI Voice B1	Green	On—BRI B1 channel is connected. Blinking—BRI B1 channel is either receiving or transmitting data.	—	—	—
BRI Voice B2	Green	On—BRI B2 channel is connected. Blinking—BRI B2 channel is either receiving or transmitting data.	—	—	—
FXS/DID Voice	Green	On—FXS/DID port is connected. Blinking—FXS/DID port is either receiving or transmitting data.	—	SRST models	—
V.92 Modem	Green	On—Modem is connected. Blinking—V.92 port is either receiving or transmitting data.	—	—	891 models

**Table 1-8 LED Descriptions for the Cisco 860 Series, Cisco 880 Series, and Cisco 890 Series ISRs (continued)**

LED	Color	Description	860 Series	880 Series	890 Series
SFP <sup>14</sup> EN	Off	Not present.	—	—	892F models
	Green	Present and enabled.	—	—	
	Amber	Present with failure.	—	—	
SFP S	Green	Blinking—Blinking frequency indicates port speed.	—	—	892F models

1. SSID = service set identifier.
2. LWAPP = Lightweight Access Point Protocol.
3. PPP = Point-to-Point Protocol.
4. xDSL = General term referring to various forms of DSL, including ADSL (asymmetric digital subscriber line) and VDSL (very-high-data-rate digital subscriber line).
5. DSLAM = digital subscriber line access multiplexer.
6. ATM = Asynchronous Transfer Mode.
7. EFM = Ethernet in the First Mile.
8. 3G = Third-Generation.
9. WWAN = wireless WAN.
10. RSSI = Received Signal Strength Indicator.
11. GSM = Global System for Mobile Communication.
12. CDMA = code division multiple access.
13. SRST = Survivable Remote Site Telephony.
14. SFP = small-form-factor pluggable.

[Table 1-9](#) describes the LEDs for the Cisco 866VAE, Cisco 867VAE, Cisco 866VAE-K9, and Cisco 867VAE-K9 ISRs.

**Table 1-9 LED Descriptions for the Cisco 866VAE, Cisco 867VAE, Cisco 866VAE-K9, and Cisco 867VAE-K9 ISRs**

LED	Activity	Description
Power/System	Power/System LED: Solid GE_MODE LED: Off DSL_LINK LED: Off	Power is on and system running in the Rommon mode.  <b>Note</b> During the early booting stage, both Power/System, GE_MODE and DSL_LINK LED will be turned on temporarily for the power on test. DSL_LINK and GE_MODE LED will be turned off later after booting into Rommon.
	Power/System LED: Solid GE_MODE LED: Solid DSL_LINK LED: Off	IOS functioning in GE WAN mode.
	Power/System LED: Solid GE_MODE LED: Off DSL_LINK LED: Solid or flashing	IOS functioning in DSL_WAN mode.  <b>Note</b> In IOS DSL_WAN mode, DSL_LINK LED will be solid after DSL training complete or flashing during training.
xDSL <sup>1</sup> ACT	Green	On—DSL interface is up. Blinking—DSL WAN activity (traffic in either direction). Faster blinking—Heavier traffic Off—Device is powered off or the DSL WAN interface is down.

**Table 1-9** LED Descriptions for the Cisco 866VAE, Cisco 867VAE, Cisco 866VAE-K9, and Cisco 867VAE-K9 ISRs

LED	Activity	Description
xDSL Link	Green	On—DSL WAN Mode is selected and DSL training complete. Blinking—DSL WAN Mode is selected but incomplete DSL Link Up state, such as in-training, or controller “OFF,” or no cable attached to DSL connector. Off—Device is powered off or GE WAN mode is selected.
GE ACT	Green	On—GE WAN interface is up. Blinking—GE WAN activity (traffic in either direction). Off—Device is powered off or GE WAN interface is down.
GE Mode	Green	On—GE WAN Mode is selected. Off—Device is powered off or DSL WAN mode is selected.

1. xDSL = General term referring to various forms of DSL, including ADSL (asymmetric digital subscriber line) and VDSL (very-high-data-rate digital subscriber line).

Table 1-10 describes the LEDs for the Cisco 892FSP.

**Table 1-10 LED description for Cisco 892FSP ISR, 896VA, 897VA, and 898EA Routers**

LED	Color	Activity	Description
PWR_OK	Green	Power Status	Off—No power. Steady on—Normal operation. Blink—Boot up phase or in ROM Monitor mode.
GE0	Green/Amber	Link Status	Green On—Ethernet port is connected.
GE1			Amber On—Fault with PoE. There is a fault with the inline power supply.
GE2			Green/Amber Blinking—Data is either being received or being transmitted.
GE3			
GE4			
GE5	Green	Link Status	On—Ethernet port is connected.
GE6			Blinking—Data is either being received or being transmitted.
GE7			Off—Ethernet port is not connected.
GE WAN ports	Green	Link Status	On—Port is connected. Blinking—Data is either being received or being transmitted. Off—No link.
SFP WAN ports	Green	Link Status	On—Port is connected. Blinking—Data is either being received or being transmitted. Off—No link.
VPN_OK	Green	—	Off—No tunnel. Steady on—At least one tunnel is up.
PPP_OK	Green	—	Off—No PPP session. Steady on—At least one PPP established.

## Shared LEDs on the Cisco 881-V and Cisco 887VA-V Voice and Data Routers

On the Cisco 881-V, Cisco 887VA-V, and Cisco 887VA-V-W routers, the BRI1, BRI2 and the FXS ports share LED indicators. The following ports share an LED indicator:

- BRI 1B1 channel and FXS 3
- BRI 1B2 channel and FSX 4
- BRI 2B1 channel and FXS 5
- BRI 2 B2 channel and FXS 6



Because the LED indicators are shared, the LED illuminates (green) when either port is active. For example, the LED indicator labeled BRI 1 B1 illuminates when either the BRI1 B1 channel is active or when the FXS port is active. You can determine the activity status on each interface by using the following commands.

- For activity status on the FXS ports, use the **show port summary** command.
- For activity status on the BRI ISDN port, use the **show isdn status** command.

Figure 1-37 shows a close-up view of the LED indicators.

**Figure 1-37 Close-up of the BRI and FXS LED Indicators**

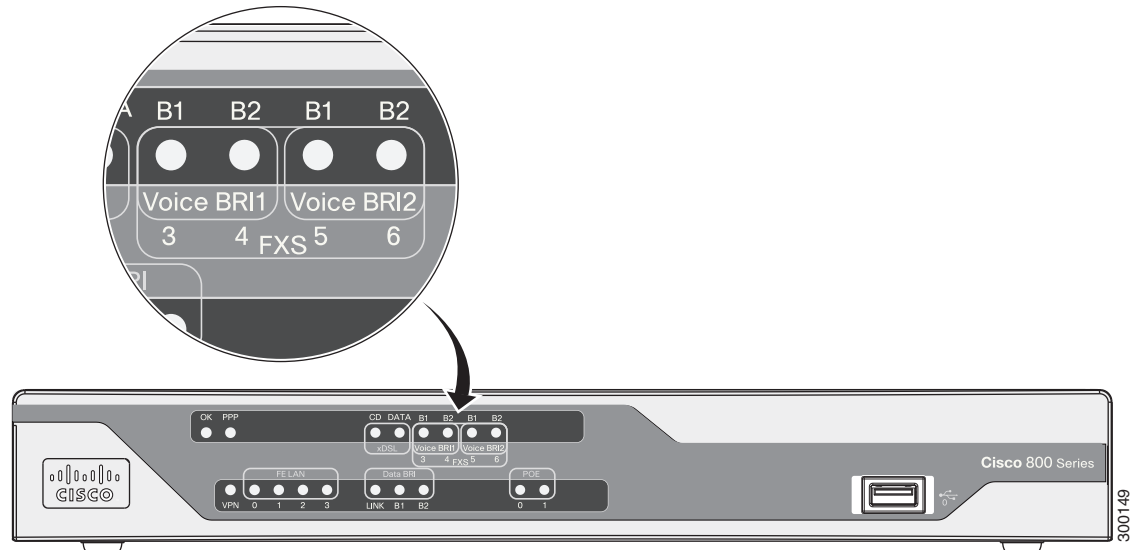

## Memory

The Cisco 860 series, 880 series, and 890 series routers contain flash memory and main memory.

### Flash Memory

The Cisco 860 series, 880 series, and 890 series ISRs use non-upgradable flash memory storage. The onboard flash memory contains the Cisco IOS software image, the boot flash contains the ROMMON boot code, and a separate non-volatile flash contains the cookie configuration.

Table 1-11 describes the default flash memory storage.

**Table 1-11 Flash Memory Storage**

Models	Flash Memory Storage
Cisco 860 series and 880 series routers	128 MB
Cisco 880 series voice routers and Cisco 890 series routers	256 MB
Cisco 880 series routers with embedded WLAN antennas	256 MB
Cisco 860VAE routers	8 MB boot flash, 128 MB for IOS
Cisco 860VAE-K9	64 MB boot flash and IOS

**Note**

Flash memory is not upgradable. An external USB flash memory module may be used if additional flash memory is needed.

**Main Memory**

Table 1-12 describes the main onboard memory storage for different router models.

**Table 1-12 Main Onboard Memory Storage**

Models	Onboard Memory Storage	Expandability
Cisco 860 series routers	256 MB	Not expandable.
Cisco 860VAE series routers	256 MB	Not expandable.
Cisco 880 series routers	256 MB (expandable to 768 MB)	A memory expansion slot accommodates a PC2-4200, 256-MB or 512-MB double data rate 2 (DDR2) SODIMM, for a maximum of 768 MB.
Cisco 880 series routers with embedded WLAN antennas	512 MB	Not expandable.
Cisco 892FSP, 896VA, 897VA, 898EA routers	512 MB	Expandable to 1 GB.

## USB Port

Table 1-13 describes the USB ports for different router models.

**Table 1-13 USB Ports**

Models	USB
Cisco 860 series (non-VAE)	No USB ports.
Cisco 860VAE series	One USB 1.1-compliant port located on the back panel. The USB port does not support eToken.
Cisco 860VAE-W-A-K9, Cisco 860VAE-W-E-K9, and Cisco 860VAE-POE-W-A-K9 series	For more information, refer to the “ <a href="#">Cisco 860VAE-W-A-K9, Cisco 860VAE-W-E-K9, and Cisco 860VAE-POE-W-A-K9 ISRs</a> ” section on page 1-6.
Cisco 880 series	One USB 1.1-compliant port located on the front panel. The USB port provides connection for USB devices such as security tokens and flash memory.
Cisco 890 series <sup>1</sup>	Two USB 2.0-compliant ports located on the front panel.
Cisco 892FSP, Cisco 896VA, Cisco 897VA, Cisco 898EA	One USB 2.0-compliant port located on the back panel.

1. Except for Cisco 892FSP, Cisco 896VA, Cisco 897VA, and Cisco 898EA.

## Fan

Some router models do not have a fan, while other models have either one or two fans.

The fans spin at full speed, as a diagnostic aid, immediately after the router is powered up. After the router has booted, the fans spin as fast as necessary to minimize fan noise while maintaining a safe internal operating temperature.

The following models have no fan:

- Cisco 892FSP
- Cisco 896VA
- Cisco 897VA
- Cisco 898EA

## Power Supply

The Cisco 892FSP has a single +12V power supply input. The Cisco 892FSP power connector is different from the barrel-type connector on other 890 series models. The AC adapter cable connector has four pins and a built-in locking mechanism. [Figure 3-27](#) shows the power adapter connector.

The Cisco 896VA, 897VA, and Cisco 898EA use PoE (12 VDC 43 W, -54 VDC 80 W) and non-PoE (12 VDC 60 W) power supplies.

## Power over Ethernet Module

The Cisco 880 series ISRs can include an optional Power over Ethernet (PoE) module that provides power to 802.3af-compliant devices connected to FE ports 0 and 1.

The Cisco 890 series ISRs can include an optional PoE module that provides power to 802.3af-compliant devices connected to FE ports 0, 1, 2, and 3.

The PoE module is an option available only for the Cisco 880 series and 890 series ISRs and requires a 48 V external power adapter.

This function can be added to an 880 or 890 series router by installing the PoE adapter card in the router and inserting the PoE 48 V external power adapter.



### Note

The Cisco 880 series ISRs with embedded WLAN antennas require a single external power supply: a 30 W power supply for non-POE-enabled routers or a 60 W power supply for POE-enabled routers. For the back panels of some of these routers, see [Figure 1-19](#) and [Figure 1-21](#).

The following PoE budget is available:

- C867VAE-POE-W-A-K9: 15.4 W (one port PoE)
- Cisco 880 series: 30.8 W (2 ports each 15.4 W)
- Cisco 890 series: 61.6 W (4 ports each 15.4 W)

## 3G Cellular Data WAN Connectivity

The 3G (Evolution Data Only [EVDO], Universal Mobile Telecommunications Systems [UMTS]) cellular interface is intended for use as a backup data link, but it can also be used as a primary WAN data link. The 3G technology is third-generation wide-area cellular technology that is used in voice telephony and broadband wireless data in a mobile environment.

Some Cisco 880G models come with a 34-mm express card slot ready for use with a commercial 3G card radio. The 3G express card slot is located on the front panel. For a list of supported 3G cards, see the [Cisco 880 Series Integrated Services Routers Data Sheet](#).

Other Cisco 880G models come with embedded WAN modems for use over GSM or CDMA networks. These routers have antenna connectors on the back panel. GSM routers have two SIM card slots. For information on configuring Cisco 880 series ISRs for 3G, see [Configuring Cisco EHWIC and 880G for 3G \(EV-DO Rev A\)](#) and [Configuring Cisco EHWIC and 880G for 3.7G \(HSPA+\)/3.5G \(HSPA\)](#).

## Wireless LAN Connectivity

The embedded Wi-Fi CERTIFIED™, 802.11a/b/g/n-compliant wireless AP is preinstalled in the router as an optional feature. The Cisco 860 series routers support autonomous features and network configurations. The Cisco 880 series and 890 series routers support both autonomous and unified features and network configurations.

The wireless AP does not have an external Console port. Use the router's Console port as described in [Chapter 3, "Connecting a Terminal or PC to the Console Port."](#) To configure the wireless device, use the Cisco IOS command-line interface (CLI).

[Table 1-14](#) describes the radios and antennas for the Cisco 860 series, 880 series, and 890 series routers.

**Note**

Cisco 860VAE ISRs do not support wireless LAN connectivity.

The 5-GHz radio operates in the Unlicensed National Information Infrastructure (UNII) 1, 2, 3, 5-GHz frequency bands.

**Table 1-14** Wireless Device Radios and Antennas

Radio Module	Platform	Radio Band	Maximum Data Throughput <sup>1</sup>	Mode	Antenna
Single-band 802.11b/g/n draft 2.0 radio module	Cisco 860 and 880 series routers  <b>Note</b> Cisco 860VAE ISRs do not support wireless LAN connectivity.	2.4 GHz	Up to 100 Mb/s	Cisco 860 series: autonomous only  Cisco 880 series: autonomous and unified	Three captive, omnidirectional dipole antennas: 2 dBi at 2.4 GHz
Single-band 802.11b/g/n radio module	Cisco 880 series routers with embedded WLAN antennas	2.4 GHz	100 Mb/s per radio, up to 200 Mb/s total	Autonomous and unified	Three embedded, omnidirectional antennas: 2 dBi at 2.4 GHz
Dual-band 802.11a/n and 802.11b/g/n radio modules		2.4 GHz and 5 GHz			Three embedded, dual-band, omnidirectional antennas: 2 dBi at 2.4 GHz and 5 dBi at 5 GHz
Dual-band simultaneous 802.11a/n and 802.11b/g/n radio modules	Cisco 890	2.4 GHz and 5 GHz	100 Mb/s per radio, up to 200 Mb/s total	Autonomous and unified	Three dual-band, removable, 2.4-GHz/5-GHz omnidirectional dipole RP-TNC antenna <sup>2</sup>

1. Actual data rate is highly dependent on your wireless environment.

2. The antennas require some minor installation. They must be screwed onto the RP-TNC antenna connectors on the I/O side of the chassis. See the following document on Cisco.com for feature information: <http://www.cisco.com/en/US/docs/routers/access/wireless/hardware/notes/antdip.html>

## Supported Cisco Radio Antennas

The Cisco 891, Cisco 892, and Cisco 892F come with three removable dipole antennas that can be replaced using the Cisco approved antenna extenders listed in [Table 1-15](#).

**Note**

Cisco supports only the antennas listed in [Table 1-15](#) with the Cisco 890 series dual-band radio module.

**Table 1-15** Cisco Antennas Supported on the Cisco 890 Series ISRs

Cisco Part Number	Antenna Type	Maximum Gain	Description
AIR-ANTM2050D-R	Omnidirectional	2.0 dBi at 2.4 GHz 5.0 dBi at 5 GHz	This is the default antenna. It is a swivel-mount dipole dual-band blade antenna. For more information, see <a href="#">Cisco Multiband Swivel-Mount Dipole Antenna (AIR-ANTM2050D-R)</a> .
AIR-ANTM4050V-R	Omnidirectional	4.0 dBi at 2.4 GHz 5.0 dBi at 5 GHz	Ceiling-mount dual-band antenna. This antenna has a clip that allows it to be mounted on a drop-ceiling cross member. For more information, see <a href="#">Cisco Multiband Diversity Omnidirectional Ceiling-Mount Antenna</a> .
AIR_ANTM5560P-R	Patch	5.5 dBi at 2.4 GHz 6.0 dBi at 5 GHz	Wall-mount dual-band antenna. For more information, see <a href="#">Cisco Multiband Wall-Mount, Corner-Mount, or Mast-Mount Antenna</a> .

## Small Form-Factor Pluggable Port

The SFP port supports auto-media-detection, auto-failover, and remote fault indication (RFI), as described in the IEEE 802.3ah specification.

See the Cisco 892F data sheet for a list of supported SFPs.

## Feature Summary

Table 1-16 summarizes the hardware features available in the Cisco 860 series, Cisco 880 series, and Cisco 890 series ISRs.

**Table 1-16** Hardware Features Available in Cisco 860 Series, Cisco 880 Series, and Cisco 890 Series ISRs

Feature	Description	860 Series	880 Series	890 Series
Reset button	Resets the router configuration to the factory default.	All models	All models	All models
	Resets the router configuration to customer configuration.	866VAE, 867VAE, 866VAE-K9, 867VAE-K9	—	—
FE <sup>1</sup> built-in switch ports	Provides connection to 10/100BASE-T (10/100-Mb/s) Fast Ethernet networks. The autosensing function in these routers eliminates the need for a crossover cable and enables the router to detect MDI <sup>2</sup> or MDIX <sup>3</sup> in any other PC or hub with a straight-through cable or a crossover cable.	All models	All models	891, 892, 892F
GE <sup>4</sup> built-in switch port	Provides connection to 10/100/1000BASE-T (10/100/1000-Mb/s) Gigabit Ethernet networks. The autosensing function in these routers eliminates the need for a crossover cable and enables the router to detect MDI <sup>5</sup> or MDIX <sup>6</sup> in any other PC or hub with a straight-through cable or a crossover cable.	866VAE-K9, 867VAE-K9	—	892FSP, 896VA, 897VA, 897VAM, 897VAW, 897VAMW, 898EA
Console or AUX port	Provides a connection to the terminal or PC for software configuration or troubleshooting. The Console port may be configured as a virtual auxiliary port for dial backup and remote management.  Cisco 891, Cisco 892, and Cisco 892F have separate console and auxiliary ports.  Cisco 892FSP has combined console and auxiliary port.	All models	All models	All models
Security features	Provides support for VPNs <sup>7</sup> , Cisco IOS Firewall, and IPSec <sup>8</sup> . The Cisco 880 series routers also provide URL filtering.	861, 867, 866VAE-K9, 867VAE-K9	All models	All models
Embedded wireless AP	Provides Wi-Fi CERTIFIED™ 802.11a/b/g/n compliance. The Cisco 860 series routers contain a single 802.11b/g/n radio. Some Cisco 880 series routers contain a single 802.11b/g/n radio while others contain dual 802.11a/n and 802.11b/g/n radios. The Cisco 890 series routers contain dual 802.11b/g/n and 802.11a/n radios.	Wireless models  802.11b/g/n	Wireless models  802.11b/g/n <sup>9</sup> and 802.11a/n <sup>10</sup>	Wireless models  802.11b/g/n and 802.11a/n
FE WAN port	Provides connection to 10/100BASE-T. Can be connected to other network devices, such as a cable modem, an xDSL <sup>11</sup> modem, or router. The router is capable of bridging and multiprotocol routing between the LAN and WAN ports.	861	881	891, 892, 892F

Table 1-16 Hardware Features Available in Cisco 860 Series, Cisco 880 Series, and Cisco 890 Series ISRs (continued)

Feature	Description	860 Series	880 Series	890 Series
GE WAN port	10/100/1000 GE WAN Port.	866VAE, 867VAE, 866VAE-K9, 867VAE-K9	—	All models
VDSL <sub>o</sub> POTS <sup>12</sup> port	Provides connection to a VDSL network.	—	887V	—
ADSL <sub>o</sub> POTS	Provides ADSL connection over basic telephone service with Annex A and Annex B ITU G. 992.1 (ADSL), G.992.3 (ADSL2), and G.992.5 (ADSL).	—	—	—
ADSL <sub>o</sub> ISDN	Provides ADSL connection over ISDN.	—	—	—
DSL Multi-mode (VDSL and ADSL2/2+)	Provides ADSL2/2+ or VDSL connection over POTS or ISDN (ISDN on 886VA only).	866VAE, 867VAE, 866VAE-K9, 867VAE-K9	886VA, 887VA,887V A-M	892FSP, 896VA, 897VA, 897VAM, 897VAW, 897VAMW, 898EA
Real-time clock (RTC)	RTC provides nonvolatile date and time when the router is powered on. The RTC is used for verifying the validity of the Certification Authority stored on the router. It is backed up by a nonreplaceable lithium battery.	866VAE, 867VAE, 866VAE-K9, 867VAE-K9	All models	All models
USB port,	<p>Supports USB 1.1. Provides connection for USB devices such as security tokens and flash memory.</p> <p>The Cisco 880 series routers have a single USB port; the Cisco 890 series routers have two USB ports.</p> <p>Cisco 880 series routers with embedded WLAN antennas have one USB 2.0 port.</p> <p>Cisco 892FSP and Cisco 860VAE series routers have one USB 2.0 port on the rear panel for temporary installation of a Cisco-approved USB memory device for maintenance purposes only. The port supports only USB 2.0. Refer to the product datasheet for the list of supported USB flash memory devices.</p> <p><b>Note</b> Cisco 860VAE series router USB port does not support eToken.</p>	866VAE, 867VAE, 866VAE-K9, 867VAE-K9	All models	All models
PoE <sup>13</sup>	<p>(Optional) Provides power for 802.3af-compliant devices (such as phones) that are connected to the router.</p> <p>The Cisco 880 series routers support a 2-port PoE module; the Cisco 890 series routers support a 4-port PoE module.</p>	—	Models with PoE	Models with PoE
G.SHDSL <sup>14</sup> port	Provides 2-wire or 4-wire connection to a G.SHDSL network.	—	888	898EA
3G <sup>15</sup> card slot	Provides backup data link.	—	3G models	—



**Table 1-16** Hardware Features Available in Cisco 860 Series, Cisco 880 Series, and Cisco 890 Series ISRs (continued)

Feature	Description	860 Series	880 Series	890 Series
Dying gasp	Detects when the router is losing power, and sends a power-fail signal to warn the DSLAM <sup>16</sup> about the impending line drop.	866VAE, 867VAE, 866VAE-K9, 867VAE-K9,  xDSL models	888EA,  xDSL models	892FSP, 896VA, 897VA, 897VAM, 897VAW, 897VAMW, 898EA
Data BRI port	Provides backup and remote management functions by connecting to the ISDN service provider if the main VDSL or G.SHDSL link fails.	—	xDSL models, except for the 3G and SRST <sup>17</sup> models	892
V.92 modem	Provides dial backup and remote management functions if the main WAN link fails.	—	—	891
FXO <sup>18</sup> port	An FXO interface connects local calls to a central office or PBX. This is the interface a standard telephone provides.	—	881 SRST	—
FXS <sup>19</sup> /DID <sup>20</sup> port	An FXS interface connects directly to a standard telephone, fax machine, or similar device. This interface supplies ringing voltage and dial tone to the station.	—	SRST models	—
BRI voice port	The ISDN BRI S/T voice interface provides a client-side (TE) ISDN S/T physical interface for connection to an NT1 device that terminates an ISDN telephone network.	—	887V	—
SFP <sup>21</sup> port	Supports auto-media-detection, auto-failover, and remote fault indication (RFI), as described in the IEEE 802.3ah specification.  See the Cisco 892F data sheet for a list of supported SFPs.	—	—	892F models, 892FSP, 896VA, 897VA, 897VAM, 897VAW, 897VAMW, 898EA

1. FE = Fast Ethernet.
2. MDI = media-dependent interface in normal mode.
3. MDIX = media-dependent interface in crossover mode.
4. GE = Gigabit Ethernet.
5. MDI = media-dependent interface in normal mode.
6. MDIX = media-dependent interface in crossover mode.
7. VPN = Virtual Private Network.
8. IPsec = IP security.
9. This applies to most models of the Cisco 880 series routers.
10. This applies to Cisco 880 series routers with embedded, wireless antennas.
11. xDSL = General term referring to various forms of DSL, including ADSL (asymmetric digital subscriber line), VDSL (very-high-data-rate digital subscriber line), and G.SHDSL.
12. VDSL2oPOTS = very-high-data-rate digital subscriber line 2 over plain old telephone service.
13. PoE = Power over Ethernet. This function can be added to an 880 or 890 series router by installing the PoE adapter card in the router and inserting the PoE 48-V external power adapter.

14. G.SHDSL = (global industry standard) symmetrical high-speed DSL.
15. 3G = Third-Generation.
16. DSLAM = digital subscriber line access multiplexer.
17. SRST = Survivable Remote Site Telephony.
18. FXO = Foreign Exchange Office.
19. FXS = Foreign Exchange Station.
20. DID = Direct Inward Dialing.
21. SFP = small-form-factor pluggable.



## Installing the Router

This chapter describes the equipment and the procedures for successfully installing the Cisco 860 series, 880 series, and 890 series Integrated Services Routers (ISRs), and contains the following sections:

- [Equipment, Tools, and Connections, page 2-2](#)
- [Installing the Router, page 2-3](#)



### Note

For compliance and safety information, see the *Regulatory Compliance and Safety Information Roadmap* that ships with the router and the [Regulatory Compliance and Safety Information for Cisco 800 Series](#).



### Warning

**All wireless LAN products in the 5.2/5.3GHz band cannot be used outdoors. Use the product only indoors.** Statement 372



### Warning

**Read the installation instructions before connecting the system to the power source.** Statement 1004



### Warning

**Only trained and qualified personnel should be allowed to install, replace, or service this equipment.** Statement 1030



### Warning

**Ultimate disposal of this product should be handled according to all national laws and regulations.** Statement 1040



### Warning

**Do not locate the antenna near overhead power lines or other electric light or power circuits, or where it can come into contact with such circuits. When installing the antenna, take extreme care not to come into contact with such circuits, because they may cause serious injury or death. For proper installation and grounding of the antenna, please refer to national and local codes (for example, U.S.:NFPA 70, National Electrical Code, Article 810, Canada: Canadian Electrical Code, Section 54).** Statement 1052



### Warning

**No user-serviceable parts inside. Do not open.** Statement 1073

# Equipment, Tools, and Connections

This section describes the equipment, tools, and connections necessary for installing your Cisco 860 series, 880 series, and 890 series ISRs. It contains the following topics:

- [Items Shipped with your Router, page 2-2](#)
- [Additional Items, page 2-2](#)
- [Connections, page 2-3](#)
- [Ethernet Devices, page 2-3](#)

## Items Shipped with your Router

Unpack the box and verify that all items listed on the invoice were shipped with the router.

[Table 2-1](#) lists the items and their quantities that are shipped with each router model.

**Table 2-1** *Items and Their Quantities That Are Shipped with the Cisco 860 Series, Cisco 880 Series, and Cisco 890 Series ISRs*

Item	Cisco 860 Series Routers	Cisco 860VAE Series Routers <sup>1</sup>	Cisco 880 Series Routers	Cisco 890 Series Routers
Straight-through RJ-45 Ethernet cable	1	—	1	1
ADSL RJ-11-to-RJ-11 straight-through cable	—	—	—	1
RJ-11 DSL <sup>2</sup> cable	1 <sup>3</sup>	n/a	1 <sup>4</sup>	1
DSL RJ-45-to-dual-RJ-11 breakout cable	—	n/a	1 <sup>5</sup>	1
RJ-45-to-DB-9 console cable	1	—	1	1
External 12 VDC power supply adapter	1	1	1	1
AC power supply cable with cable retention clip	1	1	1	1
Cisco Configuration Professional (Cisco CP) CD <sup>6</sup>	1	1	1	1

1. By default, no cables are shipped with Cisco 860VAE models unless requested through the dynamic configuration tool.

2. DSL = digital subscriber line.

3. Shipped with Cisco 867 models only.

4. Shipped with Cisco 886, 887, 887M, and 886-J models only.

5. Shipped with Cisco 888E models only.

6. Cisco CP is optional by order and available only on some SKUs.

## Additional Items

The following items are not shipped with the router but are required for installation:

- ESD-preventive cord and wrist strap.
- Screws for mounting the router on a wall:

- Two number-10 wood screws (round- or pan-head) with number-10 washers, or two number-10 washer-head screws, for mounting on a wall stud. The screws must be long enough to penetrate at least 3/4 in. (20 mm) into the supporting wood or metal wall stud.
- Two number-10 wall anchors with washers, for mounting the router on a hollow-wall.
- Wire crimper for chassis grounding.
- Wire for connecting the chassis to an earth ground:
  - AWG 14 (2 mm<sup>2</sup>) or larger wire for NEC-compliant chassis grounding.
  - AWG 18 (1 mm<sup>2</sup>) or larger wire for EN/IEC 60950-compliant chassis grounding.
- Ring terminal with an inner diameter of 1/4 in. (5 to 7 mm), for NEC-compliant chassis grounding.
- Ethernet cables for connecting to the Fast Ethernet (FE) WAN and LAN ports.

## Connections

Obtain a broadband or Ethernet connection from your service provider.

## Ethernet Devices

Identify the Ethernet devices that you will connect to the router: hub, servers, and workstations or PCs. Ensure that each device has a network interface card (NIC) for connecting to Ethernet ports.

- If you plan to configure the software using Cisco IOS commands through the console port, provide an ASCII terminal or a PC that is running terminal emulation software to connect to the console port.
- If you plan to connect a modem, provide the modem and modem cable.
- If you plan to use the Data BRI port, provide an NT1 device and an ISDN S/T cable.
- If you plan to use the cable-lock feature, provide a Kensington or equivalent locking cable.

## Installing the Router

This section describes how to install the Cisco 860 series, 880 series, and 890 series ISRs. These routers can either be installed on a table top or other flat horizontal surface or be mounted on a wall. The Cisco 890 series ISRs may be mounted in a rack. This section also describes how to attach WLAN antennas to the Cisco 890 series routers. This section contains the following topics:

- [Warnings, page 2-4](#)
- [Installing Antennas, page 2-4](#)
- [Installing on a Table, page 2-7](#)
- [Mounting on a Wall, page 2-8](#)
- [Installing in a Rack, page 2-11](#)
- [Installing the Router Ground Connection, page 2-13](#)
- [Installing the FIPS Cover, page 2-14](#)

## Warnings

**Warning**

**This equipment needs to be grounded. Use a green and yellow 12 to 14 AWG ground wire to connect the host to earth ground during normal use.** Statement 242

**Warning**

**This equipment must be grounded. Never defeat the ground conductor or operate the equipment in the absence of a suitably installed ground conductor. Contact the appropriate electrical inspection authority or an electrician if you are uncertain that suitable grounding is available.** Statement 1024

**Warning**

**Read the wall-mounting instructions carefully before beginning installation. Failure to use the correct hardware or to follow the correct procedures could result in a hazardous situation to people and damage to the system.** Statement 378

**Note**

- Do not stack anything on top of the router.
- Do not cover or obstruct the router vents located on both sides and top of the routers; otherwise, overheating could occur and cause damage to the router.
- Place router in ventilated area to avoid local air heating.

**Caution**

Do not cover or obstruct the router vents located on both sides of the router; otherwise, overheating could occur and cause damage to the router.

**Caution**

Do not place anything on top of the router that weighs more than 10 pounds (4.5 kilograms), and do not stack routers on a desktop. Excessive weight on top of the router could damage the chassis.

**Caution**

Do not install the router or power supplies next to a heat source of any kind, including heating vents.

**Caution**

The top surface of the router is hot since heat is dissipated through the top. Do not keep any object in direct contact with the surface for a prolonged period.

## Installing Antennas

The Cisco 890 series wireless routers have three reverse-polarity threaded Neill-Concelman (RP-TNC) connectors on the back panel. The antennas that are shipped with the router are dual-band 2.4-GHz to 5-GHz omnidirectional dipole antennas.

**Warning**

**All wireless LAN products in the 5.2/5.3GHz band cannot be used outdoors. Use the product only indoors.** Statement 372



**Note**

Before you install the Cisco 890 series wireless router on a table, wall, or rack, connect the antennas to the back panel. It is difficult to attach the antennas after the router is installed.

To attach the radio antennas to your wireless router, follow these steps:

- Step 1** Manually screw the antennas tight to the RP-TNC connectors on the back of the router.

**Figure 2-1 Attaching Antennas to the Router**

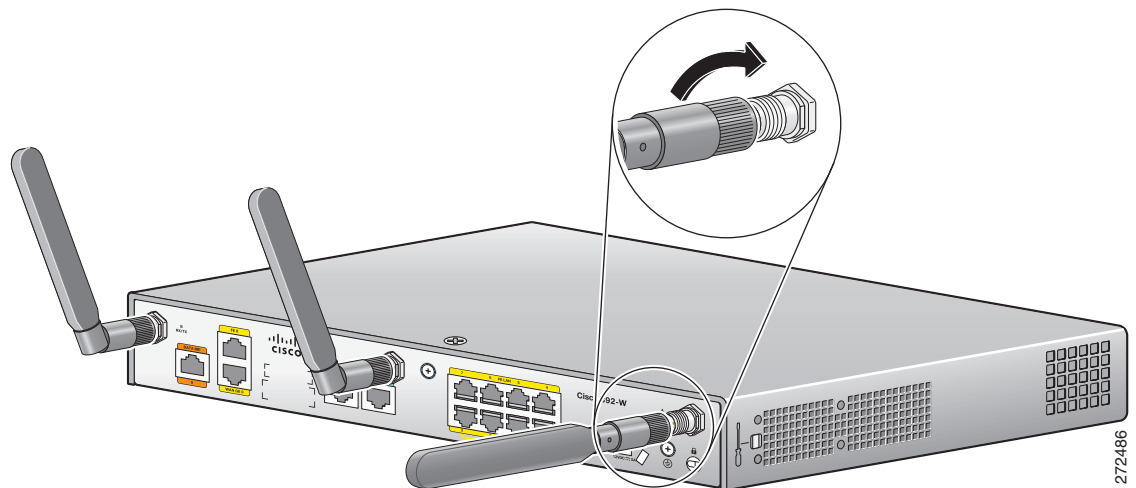

- Step 2** Orient the antennas. For optimum wireless performance, the antennas should be perpendicular with respect to the floor.
- a. If the router is being mounted on a desk, orient the antennas straight up.
  - b. If the router is being mounted on a wall, orient the antennas perpendicular to the floor, as shown in [Figure 2-2](#) and [Figure 2-3](#).

**Figure 2-2**     *Antennas Oriented Vertically Up*

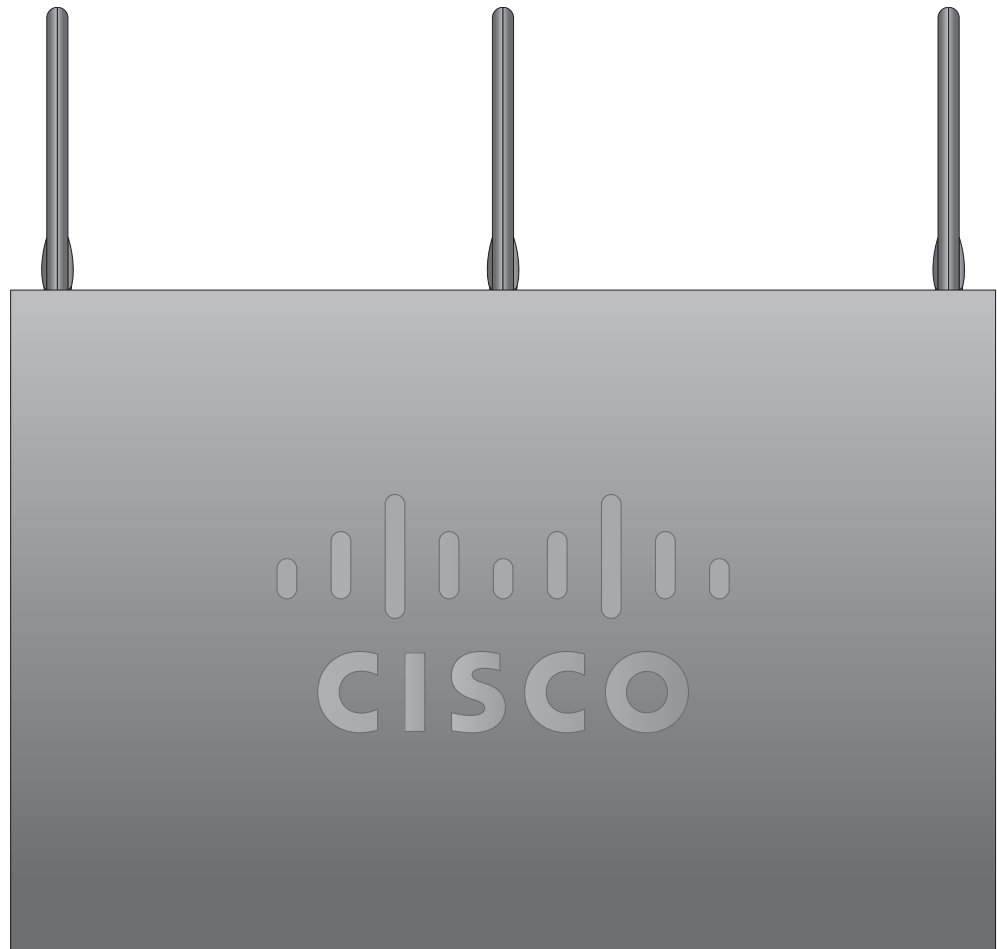

274774



**Figure 2-3**      *Antennas Oriented Vertically Down*

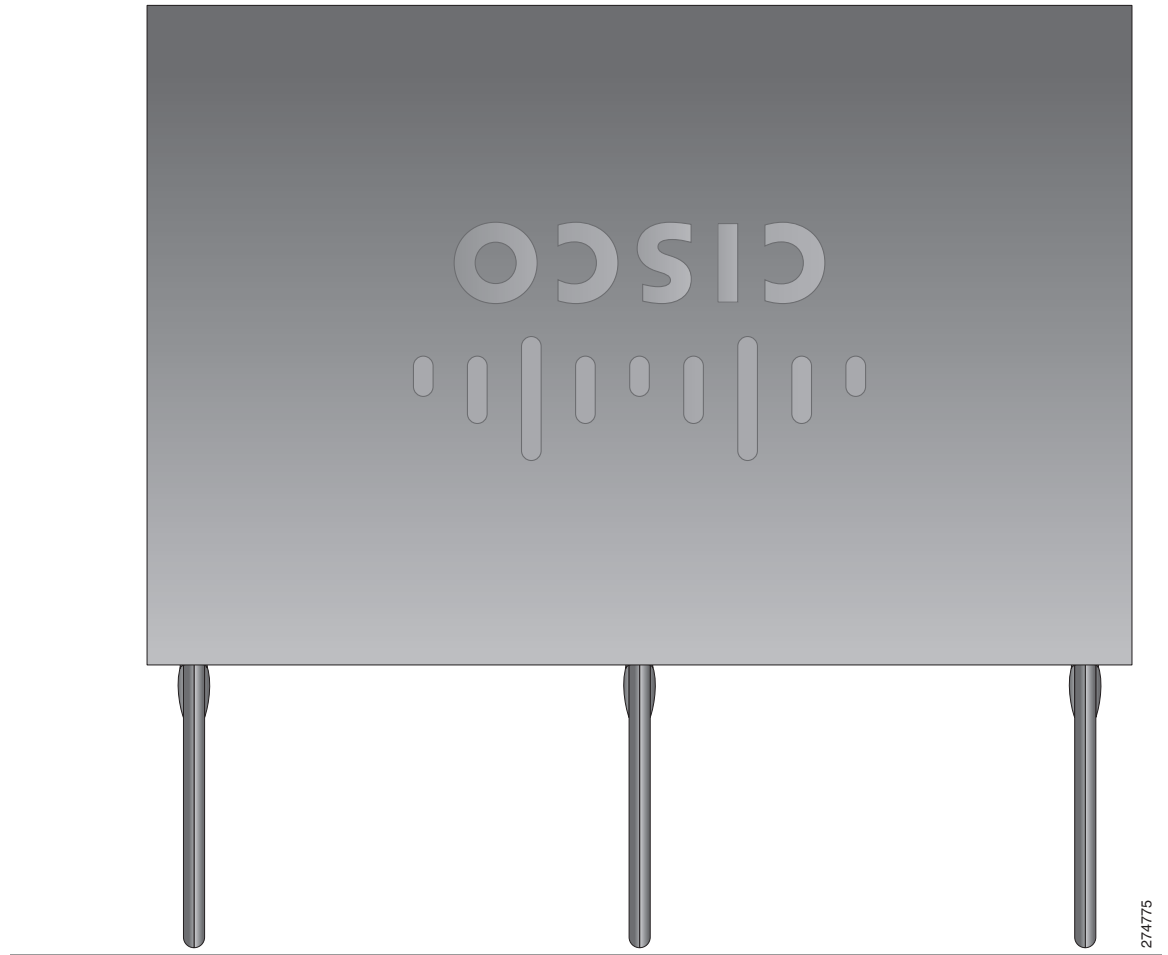

274775

## Installing on a Table

To install the router on a table or other flat horizontal surface, firmly place the router on a table or other horizontal surface. Keep at least 1 inch (2.5 cm) of clear space beside the cooling inlet and exhaust vents.

Connect the chassis to a reliable earth ground. For the chassis ground connection procedures, see the [“Installing the Router Ground Connection”](#) section on page 2-13.

**Note**

Do not place anything on top of the router.

## Mounting on a Wall

The Cisco 860 series, 880 series, and 890 series ISRs have mounting holes on the bottom of the chassis for mounting the unit on a wall or other vertical surface.

The mounting holes are bidirectional. You can hang the router with the front bezel facing upward or downward.

Keep at least 1 inch (2.5 cm) of clear space beside the cooling inlet and exhaust vents.

**Tip**

---

When choosing a location for wall-mounting the router, consider cable limitations and wall structure.

---

To mount the router on a wall, follow these steps:

**Step 1**

---

Determine the required distance between mounting holes on the router. [Figure 2-4](#) shows the wall-mount holes located on the underside of the router.

**Note**

---

For most router models, the distance between mounting holes is 8.2 inches (208 mm), as shown in [Figure 2-4](#). For the Cisco 866 and Cisco 867 models, the distance is 7.85 inches (199 mm). Verify the required distance before drilling the holes.

---

**Figure 2-4** Wall-mount Holes on the Underside of the Router

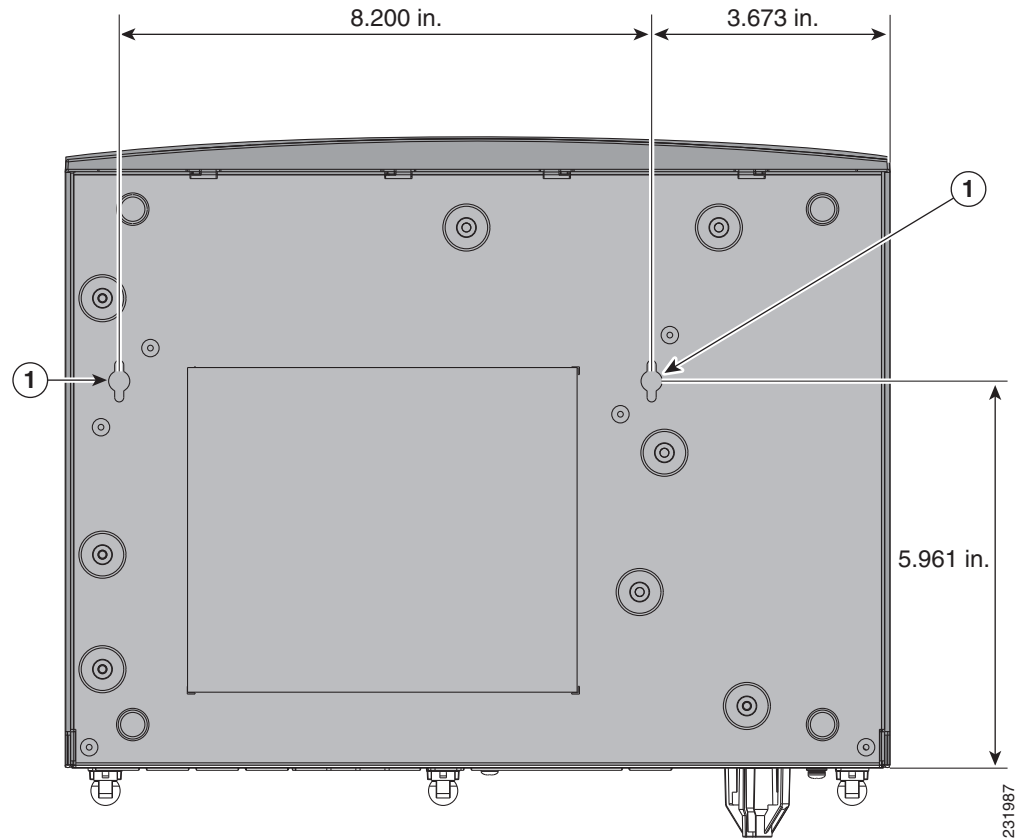

<b>1</b>	Wall-mount holes
----------	------------------

- Step 2** Insert the screws, with anchors, into the wall. Leave 1/8 inch (0.32 cm) between the screw head and the wall. See [Figure 2-5](#).
- Step 3** Hang the router on the screw without forcibly pushing towards the wall side. The screw head may damage the protection wall inside. Place the power adapter on a nearby horizontal surface. See [Figure 2-5](#).

Figure 2-5 Router Mounted on the Wall

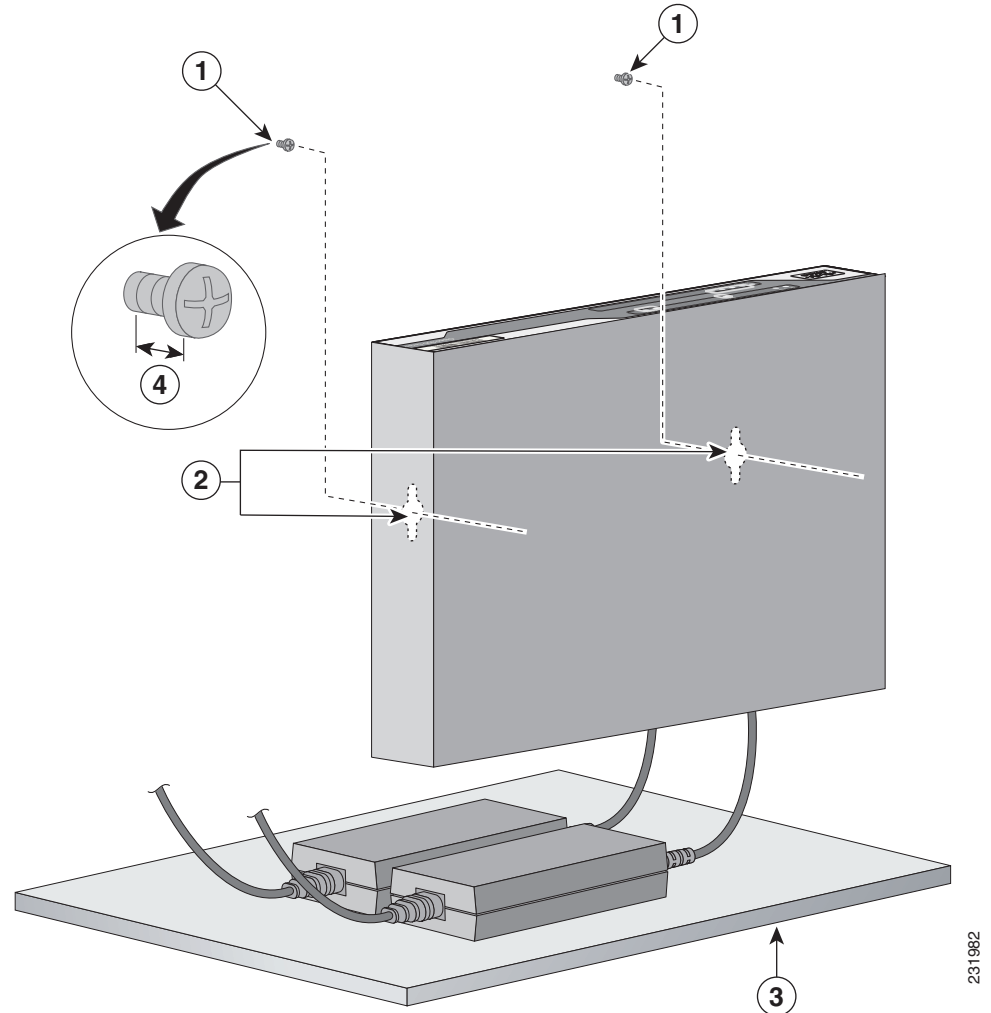

1	Two number-10 wood screws mounted on the wall	3	Horizontal surface on which to place the power adapter
2	Wall-mount holes	4	Distance between the screw head and the wall, 1/8 in. (0.32 cm)

**Step 4** Connect the chassis to a reliable earth ground. For the chassis ground connection procedures, see the [“Installing the Router Ground Connection”](#) section on page 2-13.

## Installing in a Rack

The Cisco 890 series ISRs can be mounted in a rack. To install a Cisco 890 series ISR in a rack, follow these steps:

- Step 1** Remove the screws, as shown in [Figure 2-6](#).

**Figure 2-6** Screw Locations

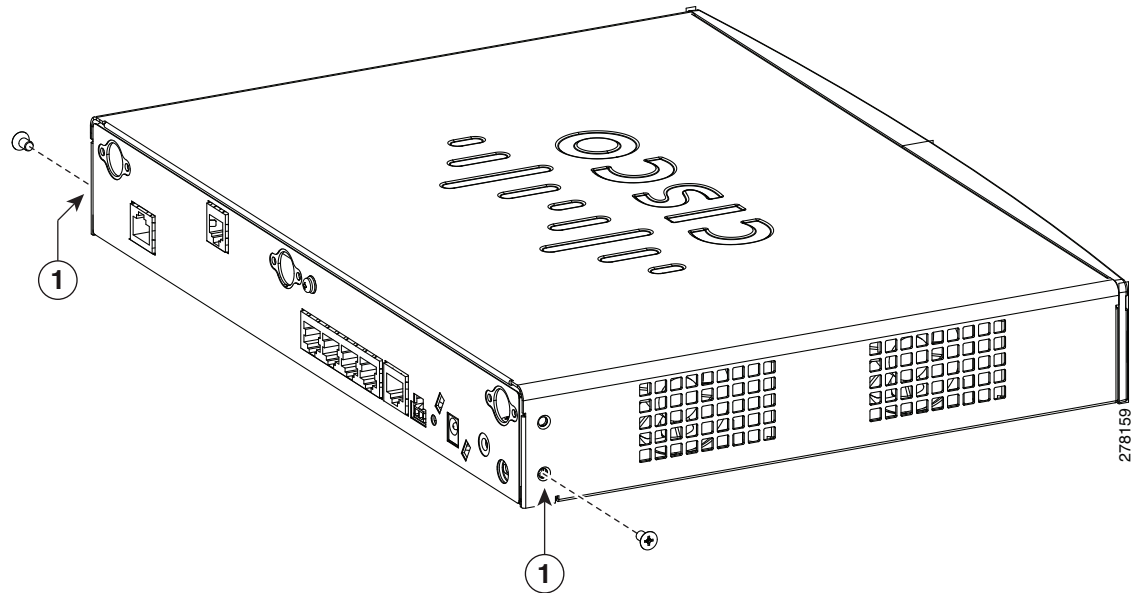

1	Screws
---	--------

- Step 2** Using the screws provided, attach the rack-mount brackets to the Cisco 890 series ISR chassis, as shown in [Figure 2-7](#). Use two screws on each side. Use a number 2 Phillips screwdriver to install the bracket screws on both sides of the chassis.



**Caution**

Do not over torque the screws. The recommended torque is 6 to 8 in-lb (0.7 to 0.9 N-m).

**Figure 2-7** Attaching the Rack-mount Brackets to the Cisco 890 Series ISR

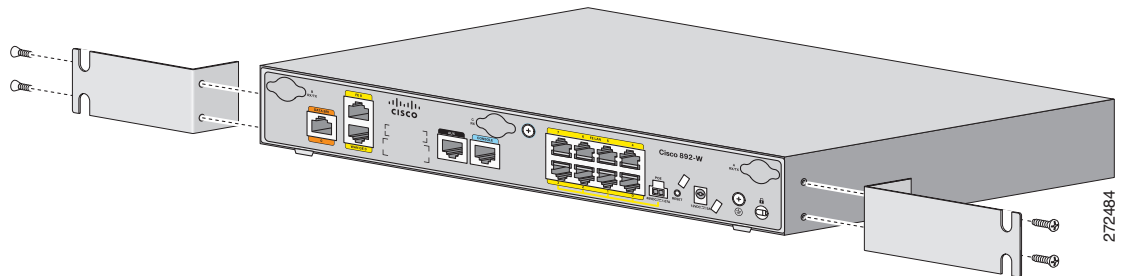

**Caution**

---

Chassis installation must allow unrestricted airflow for chassis cooling.

---

**Warning**

---

**To prevent bodily injury when mounting or servicing this unit in a rack, you must take special precautions to ensure that the system remains stable. The following guidelines are provided to ensure your safety:**

- **This unit should be mounted at the bottom of the rack if it is the only unit in the rack.**
  - **When mounting this unit in a partially filled rack, load the rack from the bottom to the top with the heaviest component at the bottom of the rack.**
  - **If the rack is provided with stabilizing devices, install the stabilizers before mounting or servicing the unit in the rack.** Statement 1006
- 

**Step 3** Using two screws for each side (supplied with the rack), attach the Cisco 890 series ISR with rack-mount brackets to a 19-inch rack. Start with the lower pair of screws first, resting the brackets on the lower screws while you insert the upper pair of screws.

**Note**

---

Be sure to leave space above and below each unit in a rack to allow for cooling air circulation.

---

**Note**

---

Do not stack equipment directly above the router. Keep at least 1 rack unit of space above the router.

---

**Tip**

---

The screw slots in the brackets are spaced to line up with every second pair of screw holes in the rack. When the correct screw holes are used, the small threaded holes in the brackets line up with unused screw holes in the rack. If the small holes do not line up with the rack holes, you must raise or lower the brackets to the next rack hole.

---

**Step 4** Place the power adapter on a nearby horizontal surface.

**Step 5** Connect the chassis to a reliable earth ground. For the chassis ground connection procedures, see the [“Installing the Router Ground Connection” section on page 2-13.](#)

---

## Installing the Router Ground Connection

The router must be connected to a reliable earth ground. Install the ground wire in accordance with local electrical safety standards.

- For NEC-compliant grounding, use size 14 AWG (2 mm<sup>2</sup>) or larger copper wire and a ring terminal with an inner diameter of 1/4 in. (5 to 7 mm).
- For EN/IEC 60950-compliant grounding, use size 18 AWG (1 mm<sup>2</sup>) or larger copper wire.

To install the ground connection, follow these steps:

- 
- Step 1** Strip one end of the ground wire to the length required for the ground lug or terminal.
- Step 2** Crimp the ground wire to the ground lug or ring terminal, using the wire crimper.
- Step 3** Attach the ground lug or ring terminal to the chassis, as shown in [Figure 2-8](#). For a ground lug, use the two provided screws with captive locking washers. For a ring terminal, use one of the screws provided. Tighten the screws to a torque of 8 to 10 in-lb (0.9 to 1.1 N-m).

**Figure 2-8** Chassis Ground Connection Using Ring Terminal

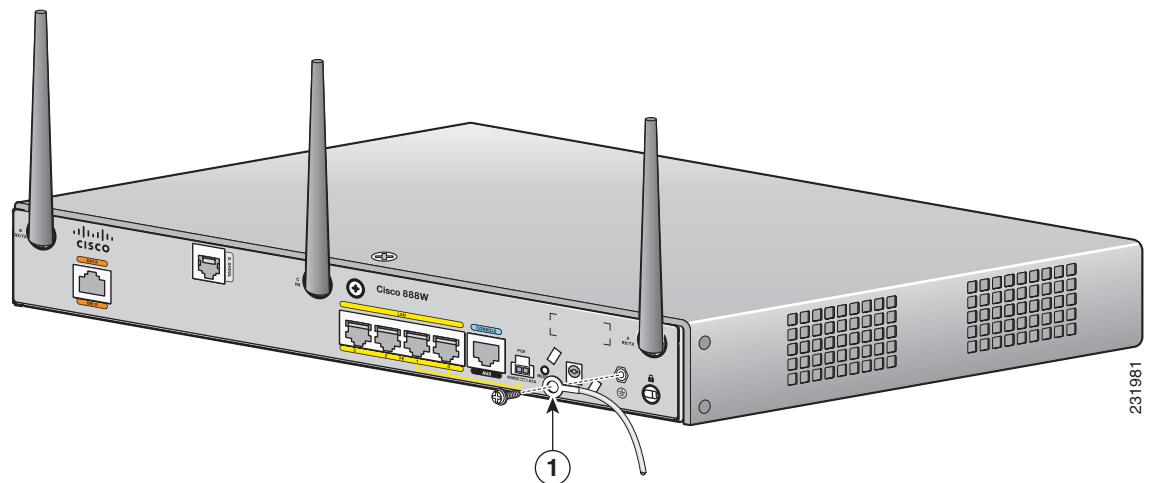

<b>1</b>	Ring terminal
----------	---------------

- 
- Step 4** Connect the other end of the ground wire to a known reliable earth ground point at your site.
- 

After you install and properly ground the router, you can connect the power wiring, the WAN and LAN cables, and the cables for administrative access as required for your installation.

## Installing the FIPS Cover

Perform the following steps to install the FIPS cover in the router:

- Step 1** Remove the four mounting screws of the top cover.

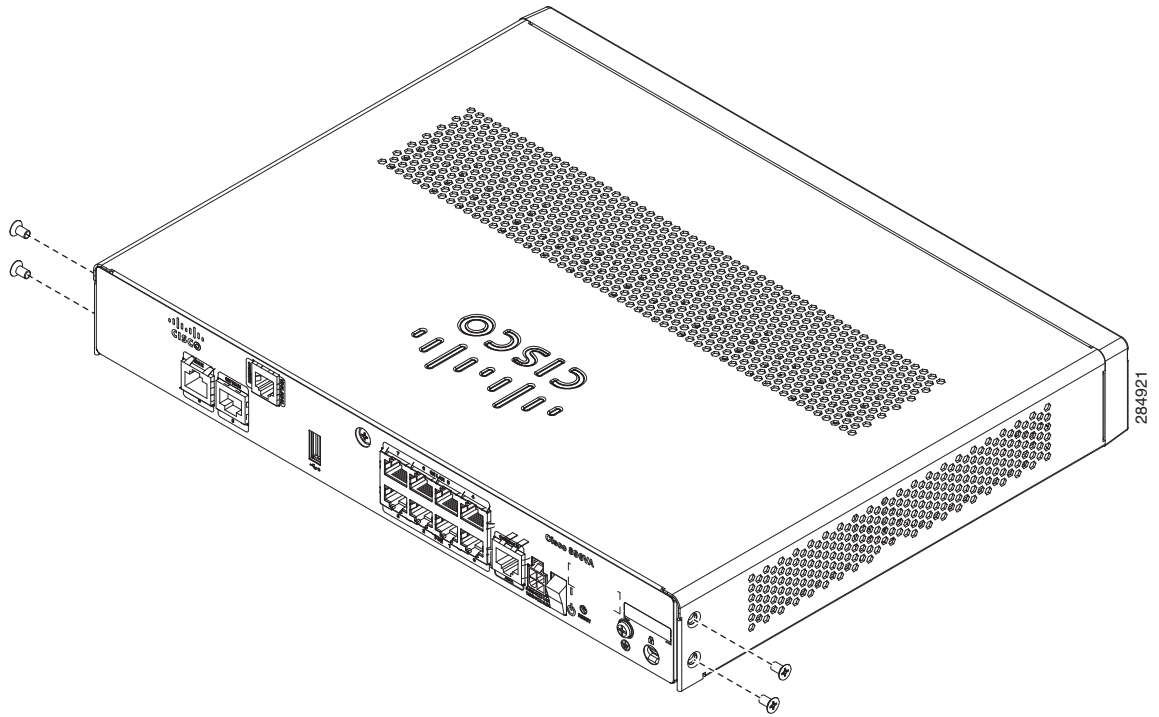



**Step 2** Install the left-side FIPS cover, as shown in detail A.

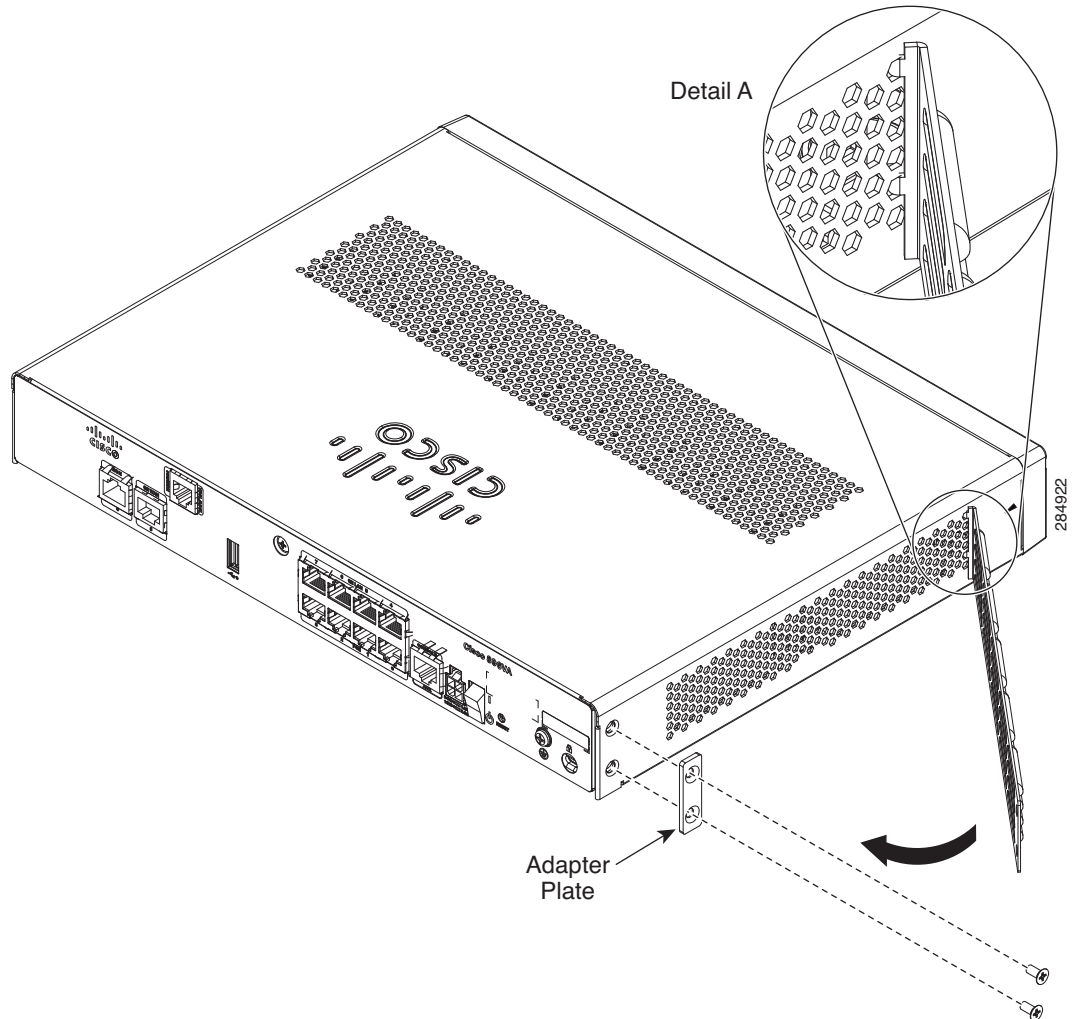

**Step 3** Rotate and bring into the close position to hinge to the correct hexagon.

**Step 4** Place the adapter plate before closing by aligning the mounting holes.

**Step 5** Secure the FIPS cover with two mounting screws.

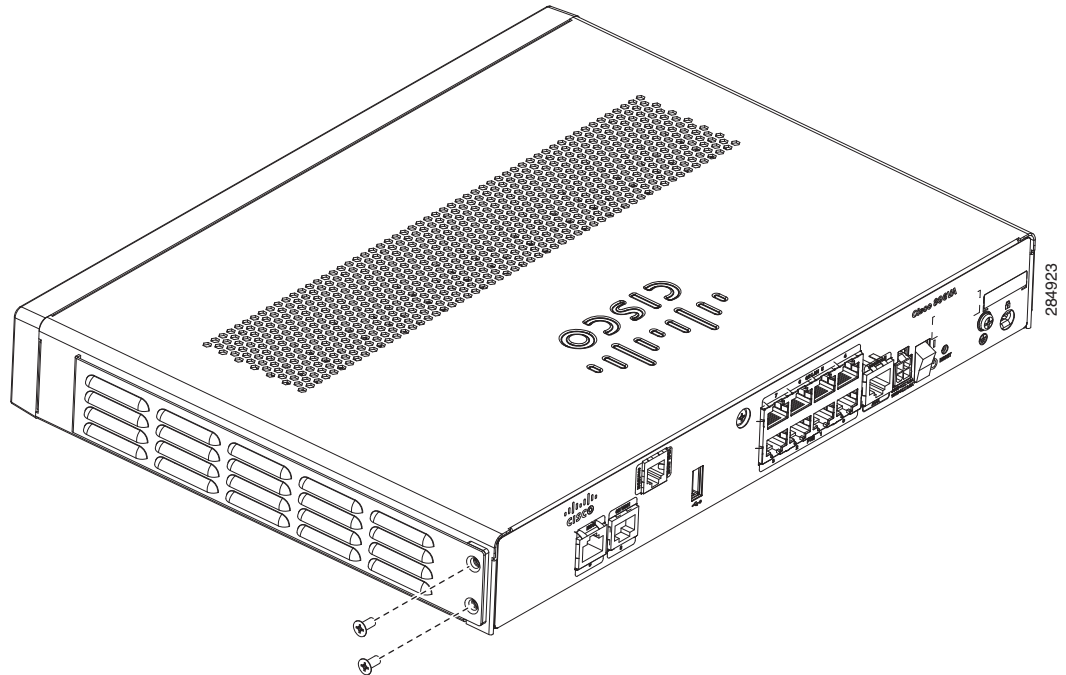

**Step 6** Install the right-side FIPS cover the same way as the left-side FIPS cover.

**Step 7** View after both covers are installed.

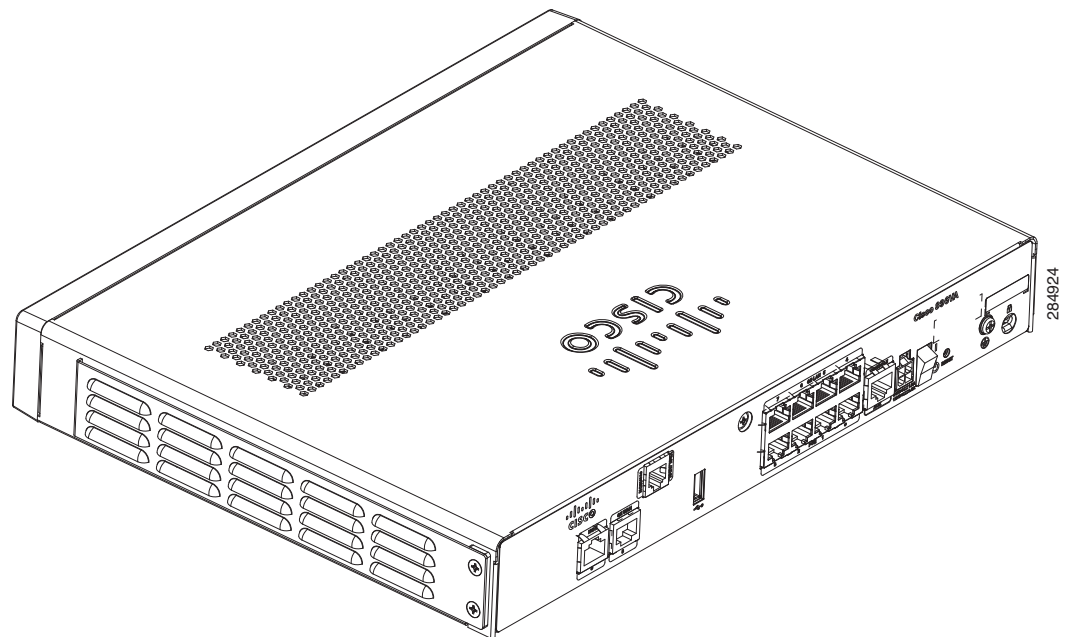

- Step 8** If the FIPS covers are installed with the rack mount brackets, the adapter plates are not required in the installation.

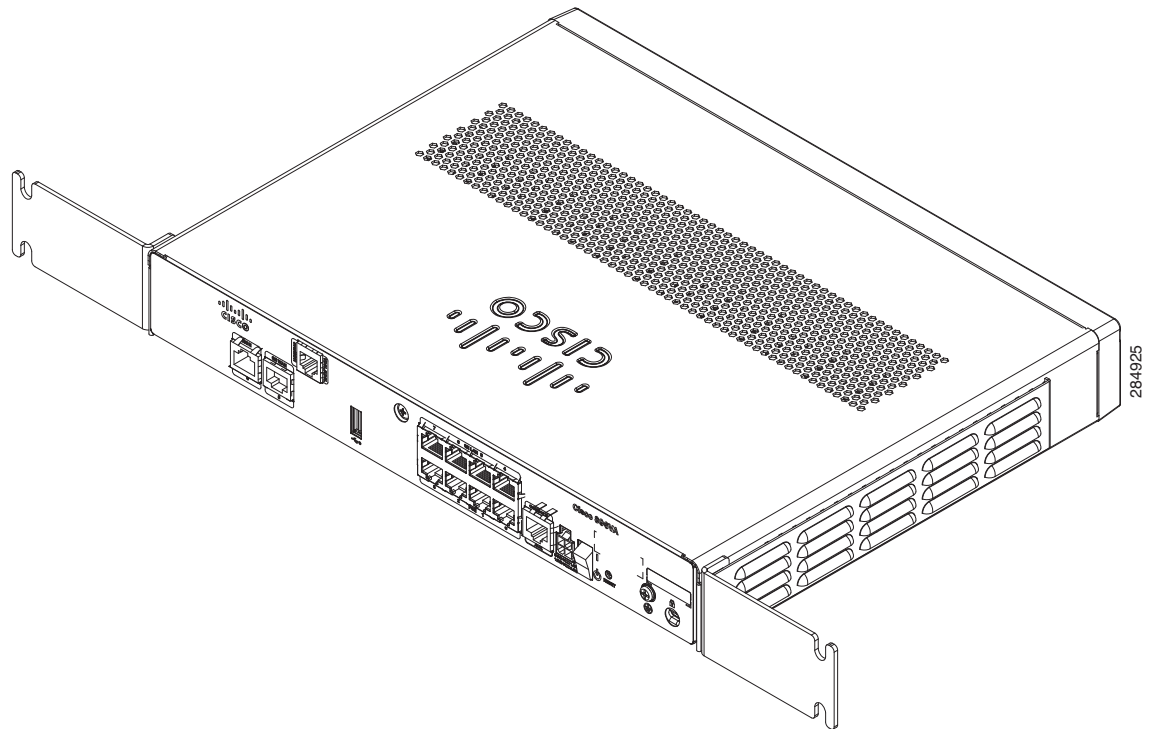





## Connecting the Router

---

This chapter describes how to connect Cisco 860 series, Cisco 880 series, and Cisco 890 series Integrated Services Routers (ISRs) to Ethernet devices, Power over Ethernet (PoE), and a network. The chapter contains the following sections:

- [Safety Warnings, page 3-2](#)
- [Preparing to Connect the Router, page 3-4](#)
- [Connecting a PC, Server, or Workstation, page 3-5](#)
- [Connecting a Phone, page 3-6](#)
- [Connecting an External Ethernet Switch, page 3-7](#)
- [Connecting the V.92 modem Port, page 3-8](#)
- [Connecting a Terminal or PC to the Console Port, page 3-9](#)
- [Connecting a Modem to the Auxiliary Port, page 3-10](#)
- [Connecting the 3G Card, page 3-11](#)
- [Installing the 3G Adapter for Extended Cable/Antenna, page 3-17](#)
- [Connecting a Data BRI Port, page 3-21](#)
- [Connecting an FE Line to an FE WAN Port, page 3-23](#)
- [Connecting a GE Line to an GE WAN Port, page 3-24](#)
- [Connecting an xDSL Line, page 3-25](#)
- [Connecting Power over Ethernet, page 3-27](#)
- [Connecting the AC Adapter, page 3-28](#)
- [Connecting an FXS Line, page 3-32](#)
- [Connecting an FXO Line, page 3-34](#)
- [Connecting a Voice ISDN BRI Line, page 3-35](#)
- [Connecting a Small Form-Factor Pluggable Module, page 3-37](#)
- [Verifying Connections, page 3-40](#)



### Note

For compliance and safety information, see *Regulatory Compliance and Safety Information Roadmap* that ships with the router and *Regulatory Compliance and Safety Information for Cisco 800 Series*.

---

**Note**

The illustrations in this chapter show a wireless router with antennas attached. Non-wireless routers do not have antennas or antenna connectors on the back panel. However, the procedures for connecting devices to the router are the same for both wireless and non-wireless routers.

**Note**

Depending on the features available for your router, some content in this chapter may not apply to your router.

## Safety Warnings

**Warning**

**When installing the product, please use the provided or designated connection cables/power cables/AC adaptors/batteries. Using any other cables/adaptors could cause a malfunction or a fire. Electrical Appliance and Material Safety Law prohibits the use of UL-certified cables (that have the "UL" or "CSA" shown on the cord), not regulated with the subject law by showing "PSE" on the cord, for any other electrical devices than products designated by CISCO.** Statement 371

**Warning**

**Do not work on the system or connect or disconnect cables during periods of lightning activity.** Statement 1001

**Warning**

**This equipment has been designed for connection to TN and IT power systems.** Statement 1007

**Warning**

**There is the danger of explosion if the battery is replaced incorrectly. Replace the battery only with the same or equivalent type recommended by the manufacturer. Dispose of used batteries according to the manufacturer's instructions.** Statement 1015

**Warning**

**Take care when connecting units to the supply circuit so that wiring is not overloaded.** Statement 1018

**Warning**











**To avoid electric shock, do not connect safety extra-low voltage (SELV) circuits to telephone-network voltage (TNV) circuits. LAN ports contain SELV circuits, and WAN ports contain TNV circuits. Some LAN and WAN ports both use RJ-45 connectors. Use caution when connecting cables.** Statement 1021

**Warning**

**Hazardous network voltages are present in WAN ports regardless of whether power to the unit is OFF or ON. To avoid electric shock, use caution when working near WAN ports. When detaching cables, detach the end away from the unit first.** Statement 1026

**Warning**

**Only trained and qualified personnel should be allowed to install, replace, or service this equipment.** Statement 1030

-  **Warning** Do not use this product near water; for example, near a bath tub, wash bowl, kitchen sink or laundry tub, in a wet basement, or near a swimming pool. Statement 1035
-  **Warning** Never install telephone jacks in wet locations unless the jack is specifically designed for wet locations. Statement 1036
-  **Warning** Never touch uninsulated telephone wires or terminals unless the telephone line has been disconnected at the network interface. Statement 1037
-  **Warning** Avoid using a telephone (other than a cordless type) during an electrical storm. There may be a remote risk of electric shock from lightning. Statement 1038
-  **Warning** To report a gas leak, do not use a telephone in the vicinity of the leak. Statement 1039
-  **Warning** Before opening the unit, disconnect the telephone-network cables to avoid contact with telephone-network voltages. Statement 1041
-  **Warning** This equipment contains a ring signal generator (ringer), which is a source of hazardous voltage. Do not touch the RJ-11 (phone) port wires (conductors), the conductors of a cable connected to the RJ-11 port, or the associated circuit-board when the ringer is active. The ringer is activated by an incoming call. Statement 1042
-  **Warning** Do not locate the antenna near overhead power lines or other electric light or power circuits, or where it can come into contact with such circuits. When installing the antenna, take extreme care not to come into contact with such circuits, because they may cause serious injury or death. For proper installation and grounding of the antenna, please refer to national and local codes (for example, U.S.:NFPA 70, National Electrical Code, Article 810, Canada: Canadian Electrical Code, Section 54). Statement 1052
-  **Warning** No user-serviceable parts inside. Do not open. Statement 1073
-  **Warning** Installation of the equipment must comply with local and national electrical codes. Statement 1074

# Preparing to Connect the Router

Before you connect the router to the devices, install the router according to the instructions in [“Installing the Router” section on page 2-1](#)

## Preventing Damage to the Router

To prevent damage to your router, follow these guidelines when connecting devices to your router:

- Turn off power to the devices and to the router until all connections are completed.

**Caution**

---

Do not turn on the devices until after you have completed all connections to the router.

---

- Connect the color-coded cables supplied by Cisco to the color-coded ports on the back panel.
- If you must supply your own cable, see [“Technical Specifications” section on page A-1](#) for cabling specifications. If this appendix does not provide specifications for a particular cable, we strongly recommend ordering the cable from Cisco.



# Connecting a PC, Server, or Workstation

To connect a PC (or other Ethernet devices) to an Ethernet switch port, follow these steps:

- Step 1** Connect one end of the yellow Ethernet cable to an Ethernet switch port on the router. [Figure 3-1](#) shows a Cisco 888W router connected to a PC.

**Figure 3-1** Connecting a Server, PC, or Workstation

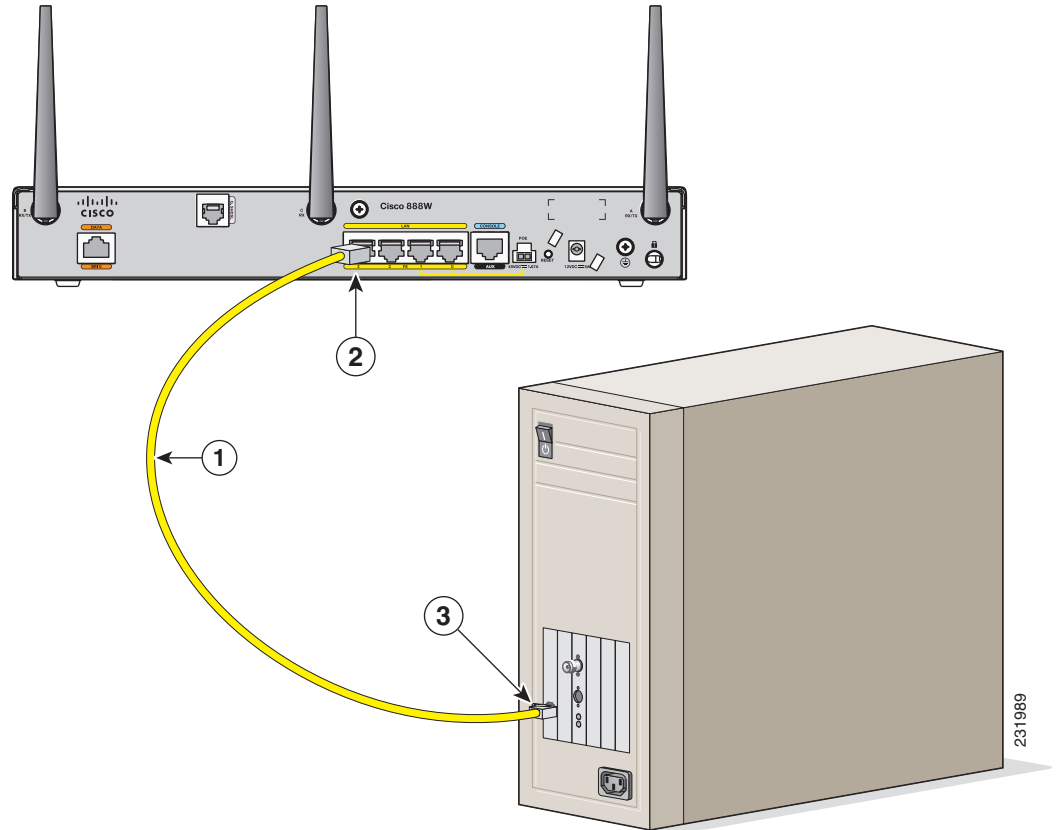

<b>1</b>	Yellow Ethernet cable supplied with the router	<b>3</b>	RJ-45 port on the network interface card
<b>2</b>	Ethernet switch port on the router		

- Step 2** Connect the other end of the cable to the RJ-45 port on the network interface card (NIC) that is installed in the PC, server, or workstation.

- Step 3** (Optional) Connect additional servers, PCs, or workstations to the other Ethernet switch ports.



**Note**

Use the Cisco Configuration Express to configure the Internet connection settings. See [Cisco Configuration Professional Quick Start Guide](#) for more information.

# Connecting a Phone

To connect an 802.3af-compliant phone to an Ethernet switch port, follow these steps:



## Note

A power source must be provided for the phone to function. This can be done in two ways: the phone can be powered via the PoE function using the PoE enabled Ethernet ports, or by using an external AC power source connected to the phone.

- Step 1** Connect one end of the yellow Ethernet cable to Ethernet switch port 0 or port 1 on the router. [Figure 3-2](#) shows a Cisco 888W router connected to a phone.

**Figure 3-2** Connecting a Phone

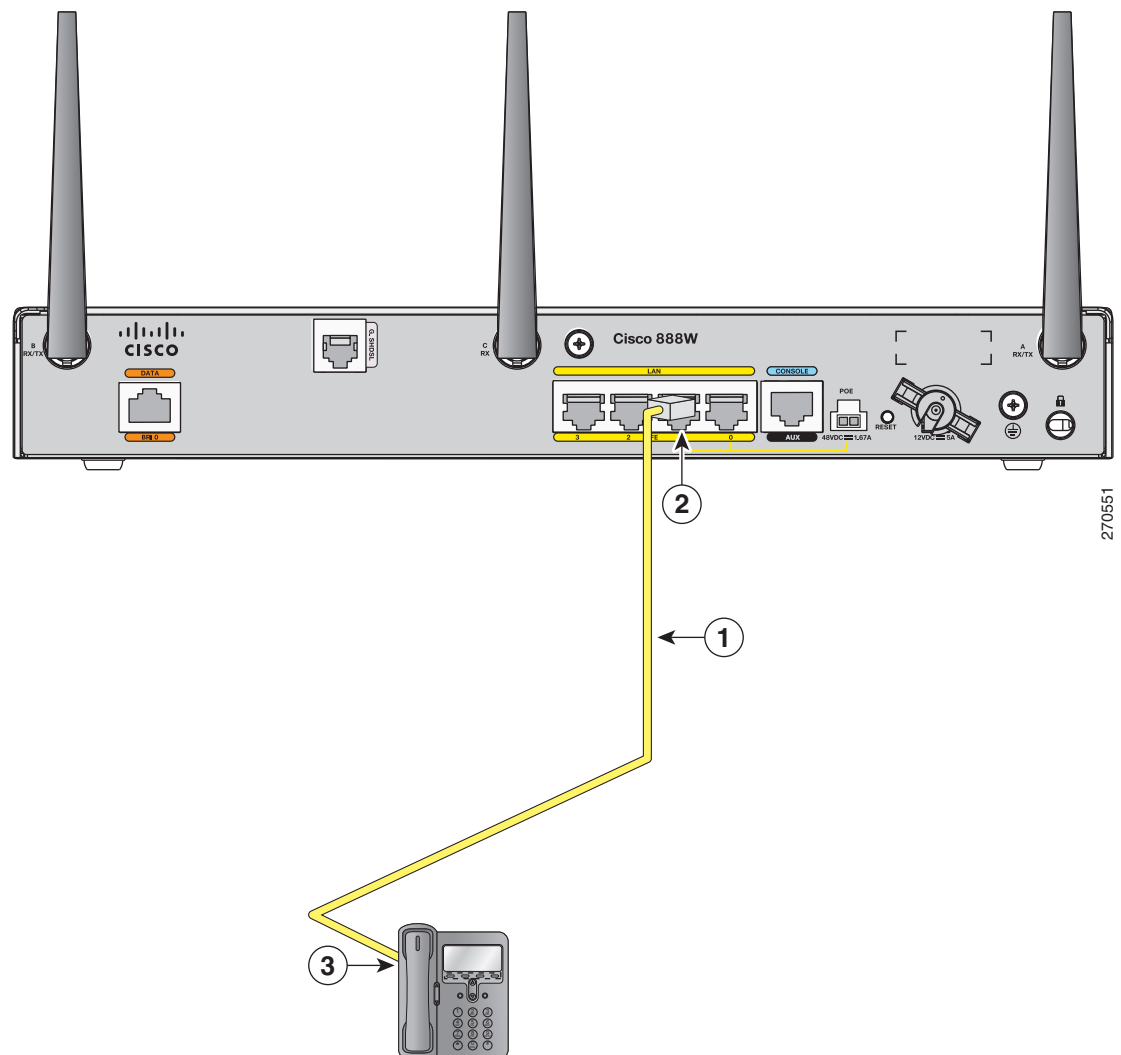

<b>1</b>	Yellow Ethernet cable	<b>3</b>	RJ-45 port on a phone
<b>2</b>	Ethernet switch port 1 on the router		

**Step 2** Connect the other end of the cable to the RJ-45 port on the phone.

## Connecting an External Ethernet Switch

If more than four PCs in an office must be connected to each other, you can add Ethernet connections to the router by connecting an external Ethernet switch to the Ethernet switch on the router.

To connect an external Ethernet switch to an Ethernet switch port on the router, complete the following steps:

**Step 1** Connect one end of the yellow Ethernet cable to an Ethernet switch port on the router. [Figure 3-3](#) shows a Cisco 888W router connected to an Ethernet switch.

**Figure 3-3** Connecting to an Ethernet Switch

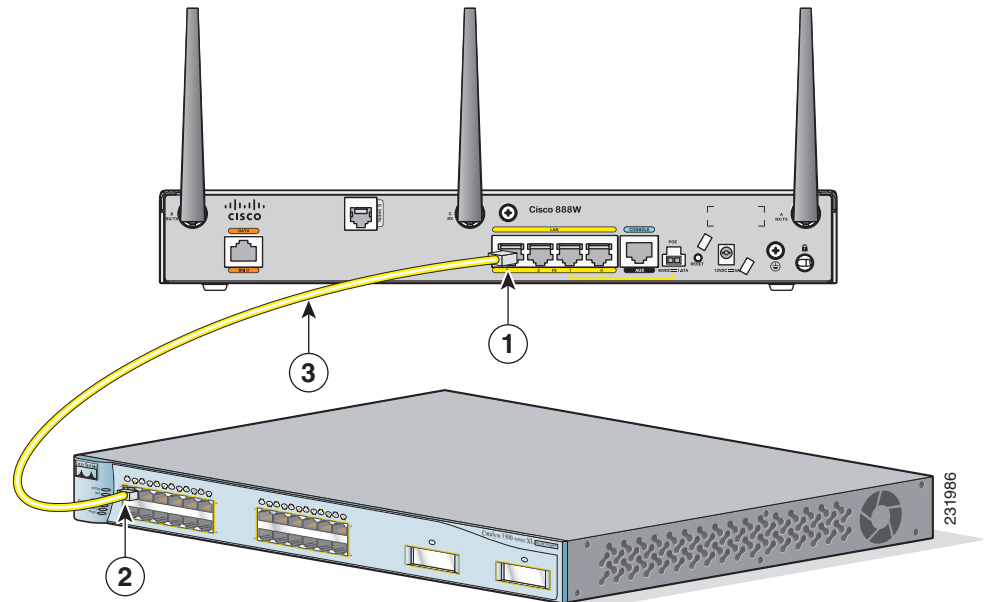

<b>1</b>	Ethernet switch port on the router	<b>3</b>	Yellow CAT5 Ethernet cable, RJ-45-to-RJ-45, connecting to an external Ethernet switch port
<b>2</b>	Available port on the external Ethernet switch		

**Step 2** Connect the other end of the cable to the available port on the Ethernet switch to add additional Ethernet connections.

**Step 3** Turn on the Ethernet switch.

# Connecting the V.92 modem Port



## Warning

Hazardous network voltages are present in WAN ports regardless of whether power to the unit is OFF or ON. To avoid electric shock, use caution when working near WAN ports. When detaching cables, detach the end away from the unit first. Statement 1026

For dialup connection to your service provider network through the V.92 port, follow the steps given after [Figure 3-4](#), which show this connection.

**Figure 3-4** Connecting to Your Service Provider Through the V.92 port

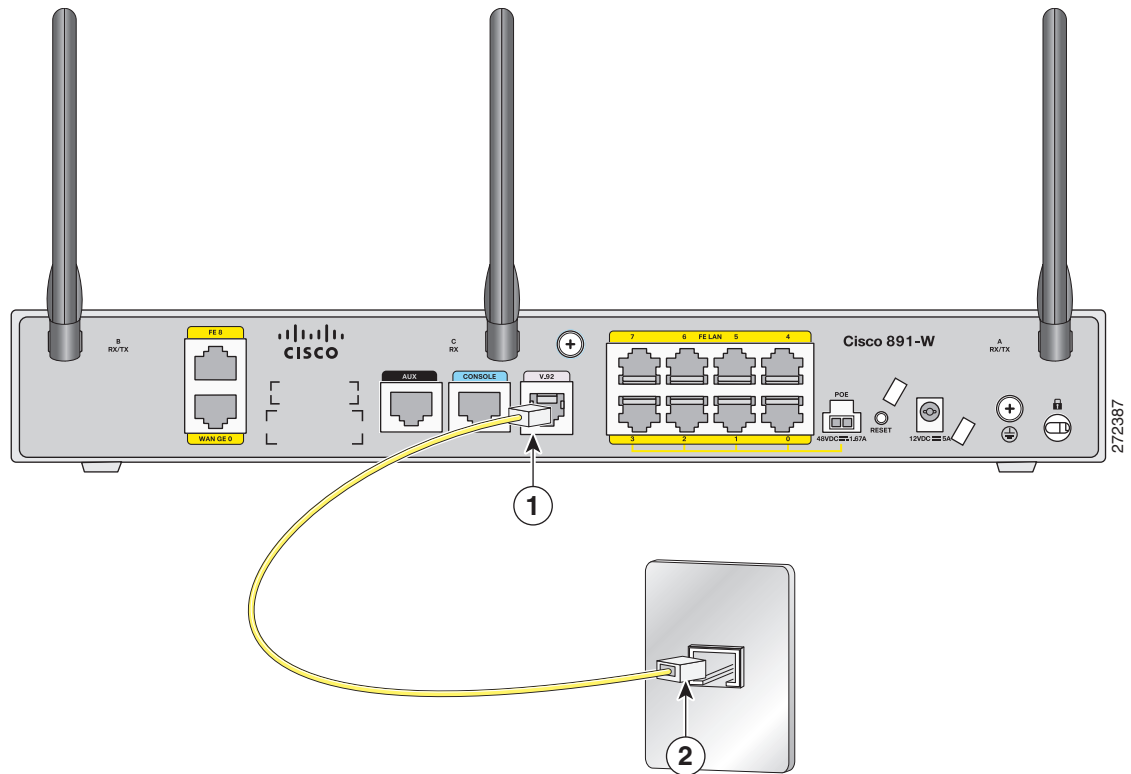

<b>1</b>	V.92 port on the router	<b>2</b>	Telephone wall outlet
----------	-------------------------	----------	-----------------------

To connect the router to your service provide network through the V.92 port, follow these steps:

- Step 1** Connect one end of the straight-through R-J11 cable to the V.92 port.
- Step 2** Connect the other end of the straight through R-J11 cable to an RJ-11 telephone wall outlet.

# Connecting a Terminal or PC to the Console Port

Connect a terminal or PC to the Console Auxiliary (Aux) port either to configure the software by using the CLI or to troubleshoot problems with the router.

To connect a terminal or PC to the console port on the router and access the CLI, follow these steps:

- Step 1** Connect the RJ-45 end of a DB-9-to-RJ-45 serial cable to the RJ-45 Console Aux port on the router. [Figure 3-5](#) shows the RJ-45 end of the serial cable connected to the Console Aux port on the router.

**Figure 3-5** Connecting a Terminal or PC to the Console Port

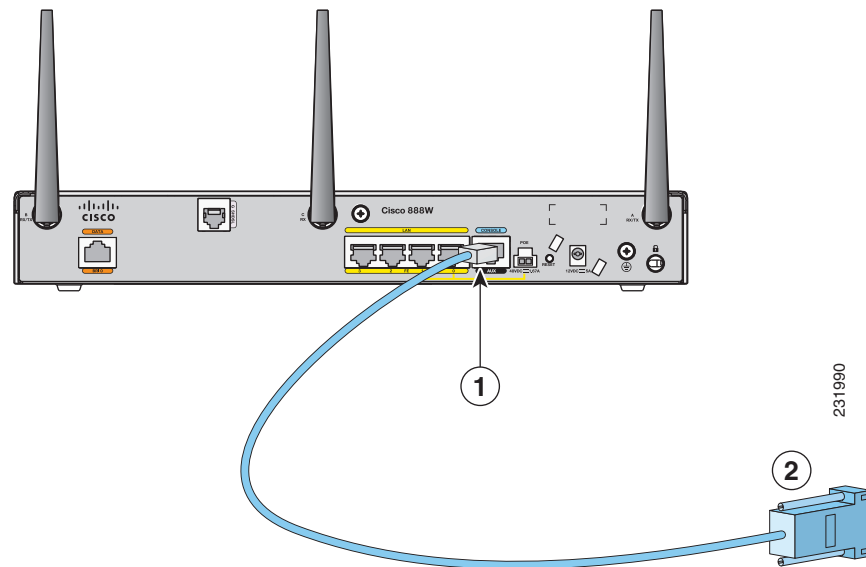

<b>1</b>	RJ-45 connector to the Console Aux port on the router	<b>2</b>	DB-9 connector
----------	---	----------	----------------

- Step 2** Connect the DB-9 end of the DB-9-to-RJ-45 serial cable to the to the COM port on your laptop or PC.



**Note** Some laptops and PCs do not come with DB-9 serial port connectors and may require a USB-to-serial port adapter.

- Step 3** To communicate with the router, start a terminal emulator application.

## Terminal Emulator Settings

Use the following settings for the terminal emulator connection:

- 9600 baud
- 8 data bits, no parity
- 1 stop bit
- No flow control

When the terminal emulator establishes communications, the router prompt is displayed.

For more information on terminal emulation settings, see [Applying Correct Terminal Emulator Settings for Console Connections](#).

## Connecting a Modem to the Auxiliary Port

To connect a modem to the router, follow these steps:

- Step 1** Connect the RJ-45 end of the adapter cable to the Aux port on the router as shown in [Figure 3-6](#).

**Figure 3-6** Connecting a Modem to the Aux Port

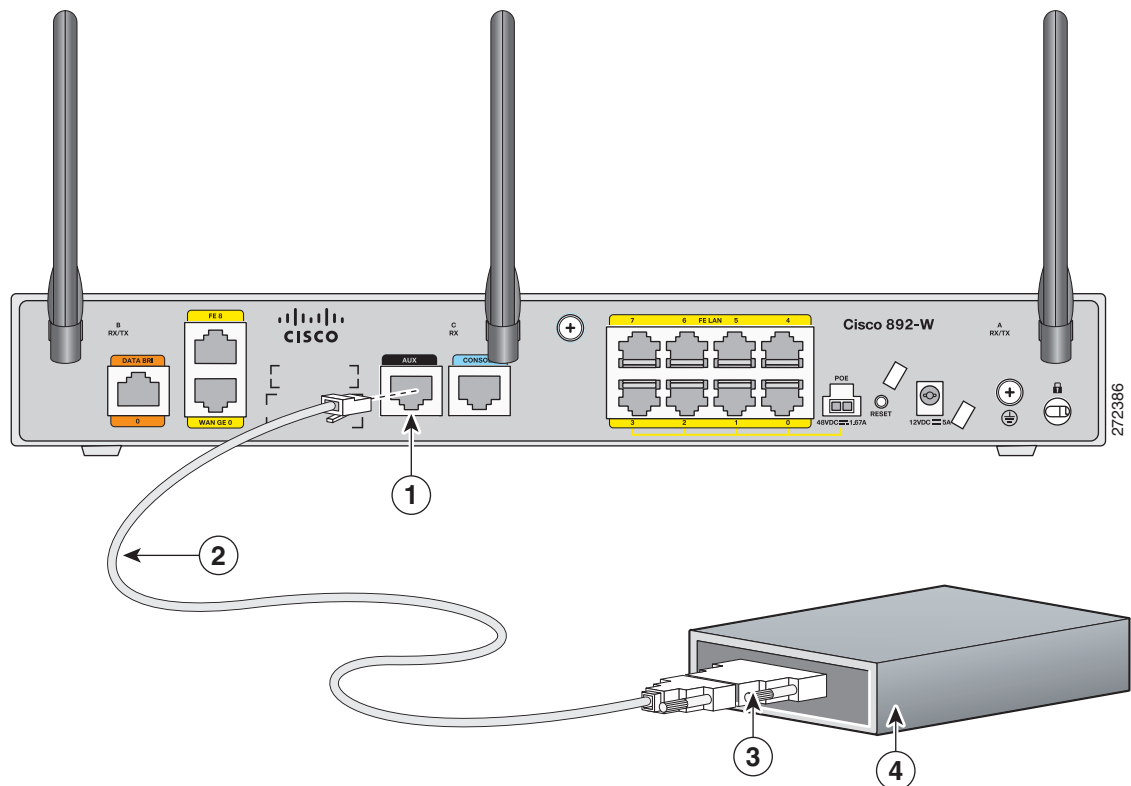

<b>1</b>	Aux port (RJ-45)	<b>3</b>	DB-9 to DB-25 modem adapter (if required)
<b>2</b>	Light blue console cable	<b>4</b>	Modem

- Step 2** Connect the DB-9 end of the console cable to the DB-9 end of the modem adapter.
- Step 3** Connect the DB-25 end of the modem adapter to the modem.
- Step 4** Make sure that your modem and the router auxiliary port are configured for the same transmission speed (up to 115200 bits per second [b/s] is supported) and support mode control with data carrier detect (DCD) and data terminal ready (DTR).
- 

## Connecting the 3G Card

**Note**

For information on embedded multiband, multiservice WAN modems, see [Configuring Cisco EHWIC and 880G for 3G \(EV-DO Rev A\)](#) and [Configuring Cisco EHWIC and 880G for 3.7G \(HSPA+\)/3.5G \(HSPA\)](#).

---

**Note**

The Cisco 880G router does not support online insertion and removal (OIR) of the third-generation (3G) card. You must enter the **shutdown** command on the cellular interface before you remove the 3G card from the router.

---

To connect and secure the 3G card, follow these steps:

- Step 1** Align the 3G card to the 3G express card slot, as shown in [Figure 3-7](#). Keep the card parallel to the surface and firmly push the card into the slot.

**Tip**

Holding the 3G card on the flat metal surface makes it easier to align and insert the 3G card.

---

**Note**

When inserting the card into the 3G express card slot, you may hear a metal-on-metal sound as the 3G card rubs against the internal metal cage. The 3G card is designed to fit tightly into the 3G express card slot. Firm pressure may be required to insert the card.

---

**Note**

Global System for Mobile Communications (GSM) customers need to insert a SIM card, provided by their network carrier, into the 3G card.

---

Figure 3-7 Inserting the 3G Card

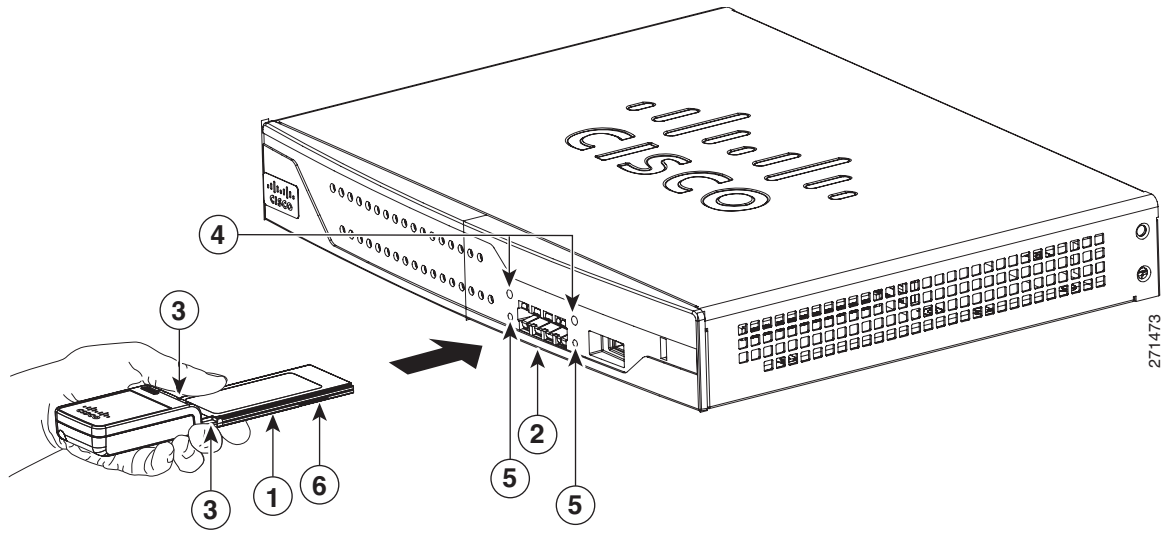

1	3G card with the Cisco logo facing up	4	Screw holes for locking bracket
2	3G express card slot	5	Pin holes for aligning the locking bracket
3	Notches on the 3G card	6	SIM slot (in HSPA <sup>1</sup> cards only)

1. HSPA = High-Speed Packet Access.

**Step 2** Open the top of the anti-theft locking bracket, as shown in [Figure 3-8](#).

Figure 3-8 Opening the Anti-theft Locking Bracket

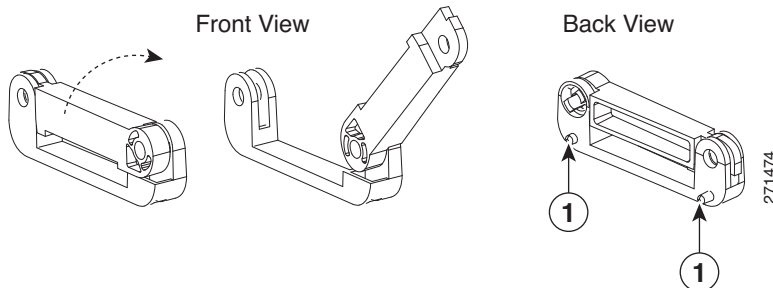

1	Pins on the locking bracket for alignment		
---	---	--	--



**Step 3** Slide the opened locking bracket under the 3G card. The locking bracket should align with the notches on either side of the 3G card, as shown in [Figure 3-9](#), and the pins on the locking bracket should be inserted into the corresponding holes in the router.

**Figure 3-9** *Installing the Locking Bracket*

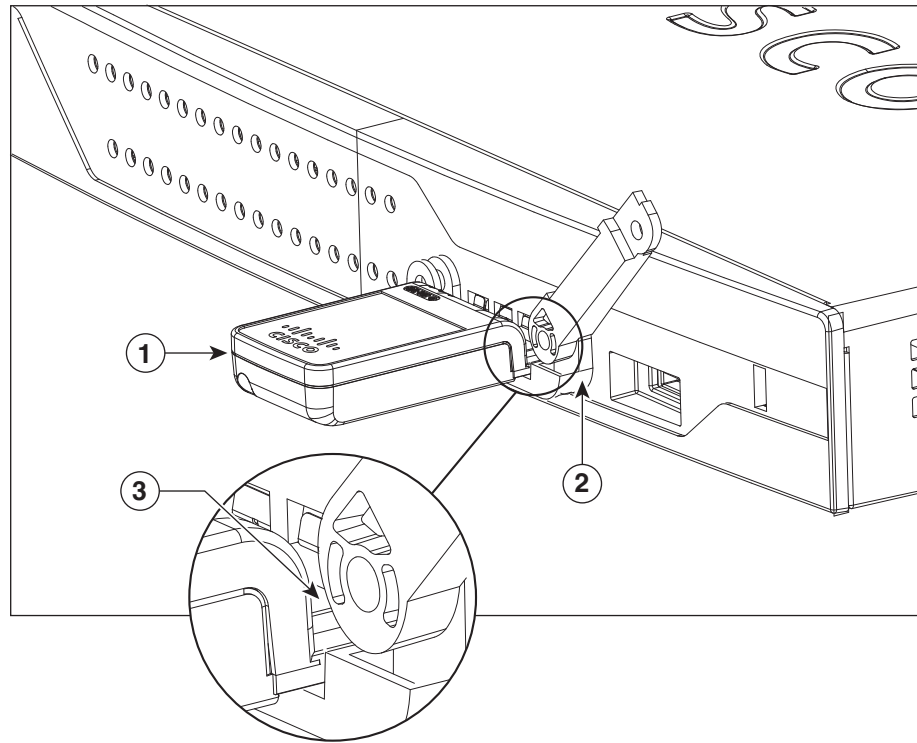

1	3G card	3	Notch on the 3G card
2	Locking bracket		

**Step 4** Close the locking bracket, as shown in [Figure 3-10](#).

**Figure 3-10** Closing the Locking Bracket

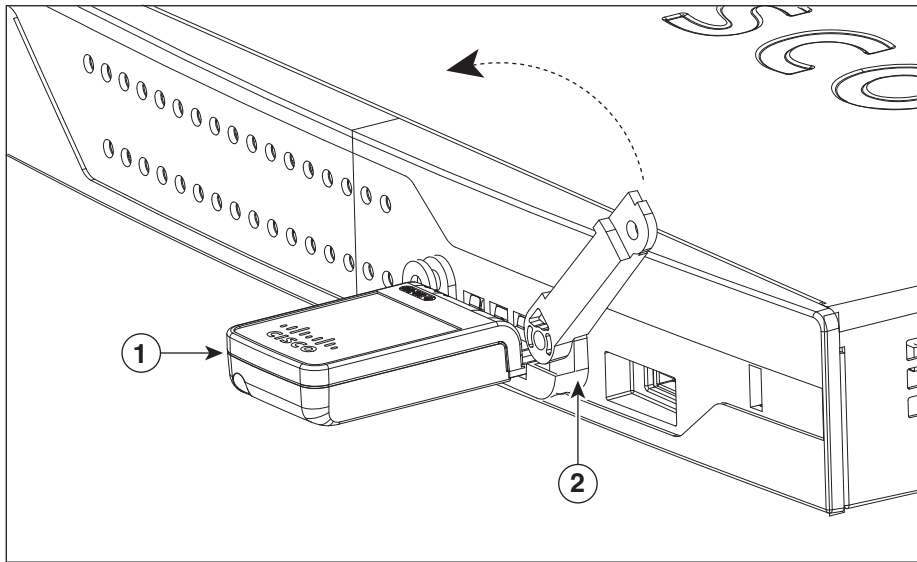

1	3G card	2	Locking bracket
---	---------	---	-----------------

**Step 5** Insert the screws, as shown in [Figure 3-11](#), and tighten with a number 2 Phillips screwdriver.

**Figure 3-11** Inserting the Screws

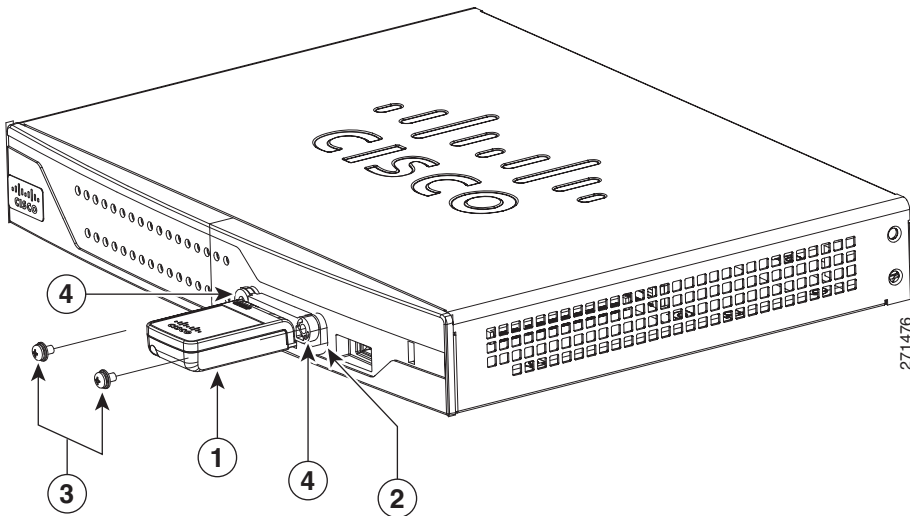

1	3G card	3	Screws
2	Locking bracket	4	Screw holes on the locking bracket

**Step 6** To connect the antenna to the 3G card, insert the antenna connector into the antenna connector receptacle on the 3G card.



**Note**

The antenna connector receptacle may be located on the left, right, or front of the 3G card, depending on your card.

Figure 3-12 shows the antenna connected to the 3G card with an SSMB type plug, and Figure 3-13 shows the antenna with the SMK-TS-9 connector.

**Figure 3-12 Antenna connected to the 3G Card with SSMB connector**

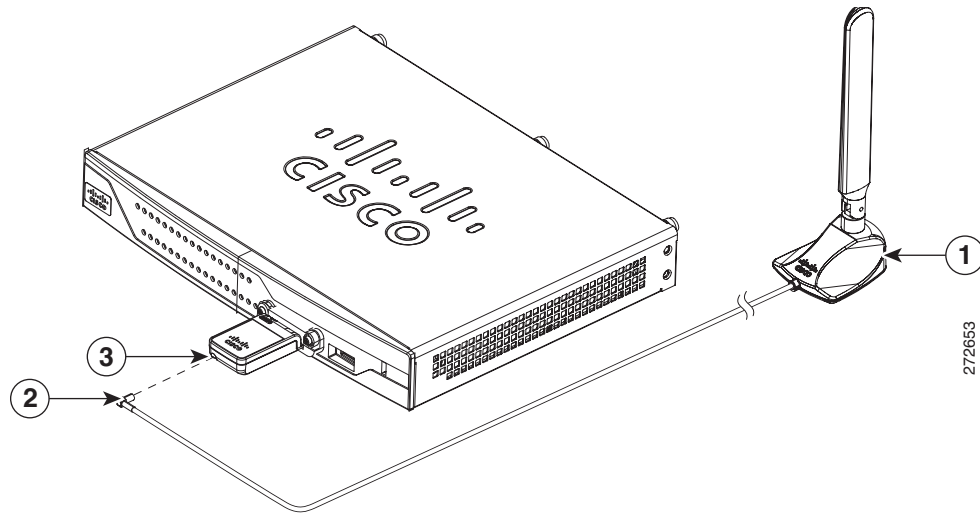

1	Antenna on a cradle	3	Antenna connector receptacle <sup>1</sup>
2	Antenna SSMB connector		

1. The antenna connector receptacle is located on either the left, right or front of the card for different SKUs. Please locate the receptacle of your card before plugging in the cable.

Figure 3-13 Antenna with the SMK-TS-9 Connector

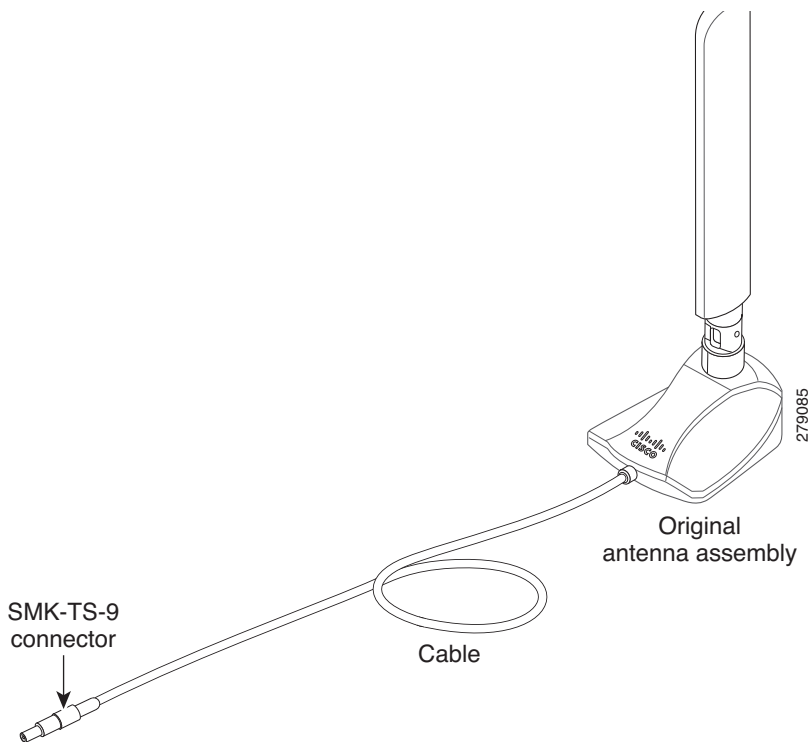

If you are using an extension cable, you must attach the 3G adapter for extended cable antenna to the body of the router. Depending on the SKU ordered, the adapters come with different connectors. Table 3-1 lists the different adapters and SKUs supported by each adapter. For instructions on how to install the adapter, see the “Installing the 3G Adapter for Extended Cable/Antenna” section on page 3-17. Otherwise, follow Step 7.

Table 3-1 3G Adapters and Supported SKUs

3G Adapter SKU	Description	SKUs Supported
3G-ACC-SMKTS9-TNC	3G adapter for extended cable/antenna with an SMK-TS-9 to TNC connector. Use this with the pentaband dipole indoor antenna (3G-ANTM-SMKTS9).	PCEX-3G-HSPA-R6, CISCO881G-G-K9
3G-ACC-SSMB-TNC	3G adapter for extended cable/antenna with an SSMB to TNC connector. Use this with the pentaband dipole indoor antenna shipped with your product.	PCEX-3G-HSPA, PCEX-3G-HSPA-A, PCEX-3G-CDMA-S, PCEX-3G-CDMA-V, PCEX-3G-CDMA-B, CISCO881G-A-K9, CISCO881G-S-K9, CISCO881G-V-K9

Step 7 Clean the flat surface to which you will affix the antenna.

- Step 8** Remove the protective tape from the adhesive on the bottom of the antenna cradle, then firmly press the cradle to the flat surface.

## Installing the 3G Adapter for Extended Cable/Antenna

For better signal and reception, if you are using the Cisco 3G Adapter for Extended Cable/Antenna, 3G-ACC-SMKTS9-TNC, follow these steps to install it:

- Step 1** Locate and remove the Phillips screw on the left side of the router as shown in [Figure 3-14](#). Keep the screw aside for Step 4.

**Figure 3-14** Locating the Phillips Screw

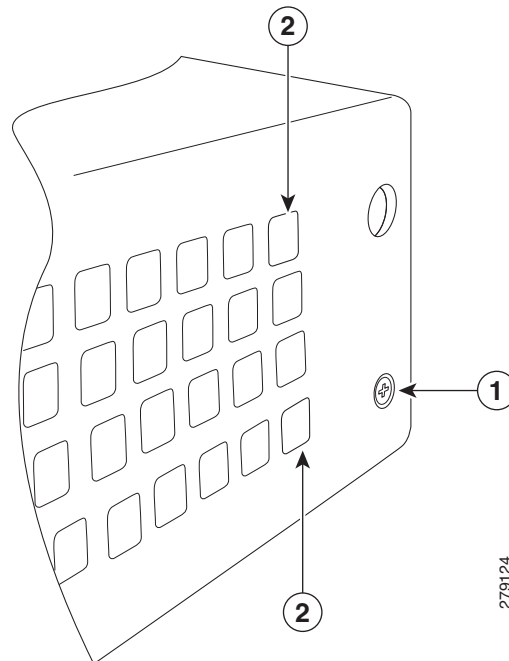

<b>1</b>	Phillips screw on the left side of router	<b>2</b>	Air vent holes to be aligned with adapter
----------	---	----------	---

**Step 2** Locate the hooks on the adapter as shown in [Figure 3-15](#).

**Figure 3-15** Locating the Hooks on the Adapter

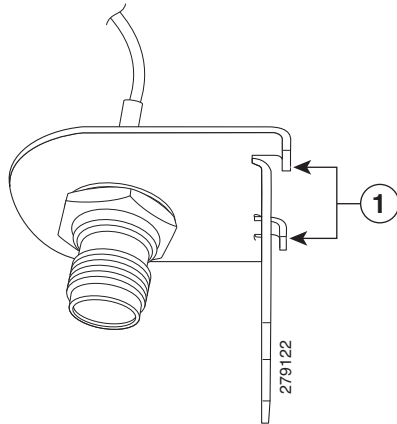



---

**1** Hooks on the adapter

---

**Step 3** Align and insert the hooks of the adapter into the air vent holes on the left side router body as shown in [Figure 3-16](#).

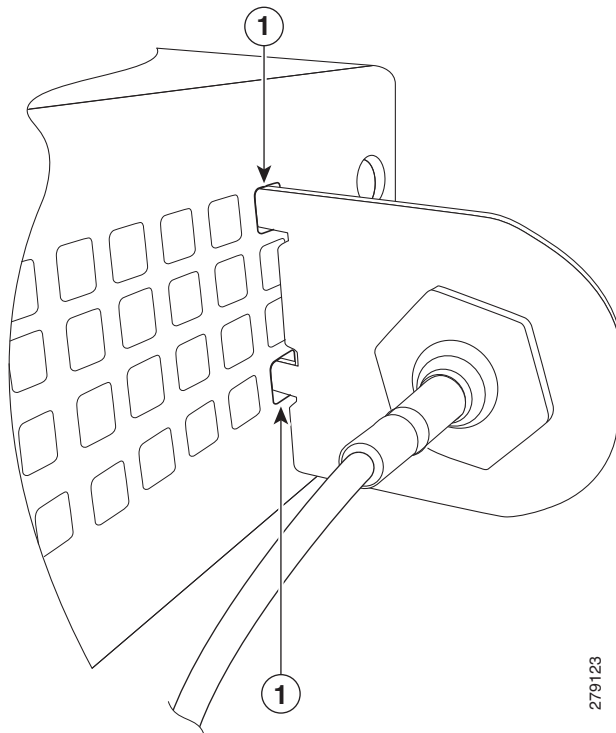
**Figure 3-16** Inserting the Hooks





---

**1** Hooks aligned and inserted into the router.

---

- Step 4** Align the circular adapter hole with the hole on the router chassis from where you removed the screw in [Step 1](#) and use the screw to attach the adapter to the router as shown in [Figure 3-17](#).

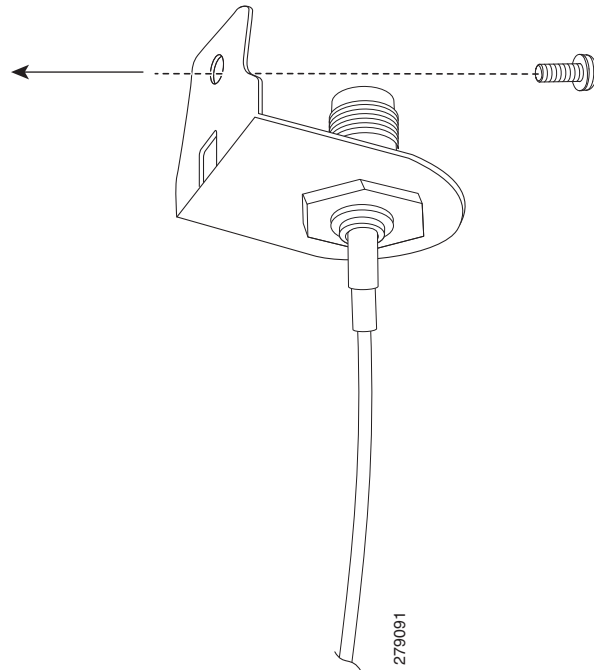
**Figure 3-17** Attaching the Adapter



- Step 5** Connect the extension cable to the 3G card, as described in the “Connecting the 3G Card” section on page 3-11. The complete assembly is shown in Figure 3-18.

**Figure 3-18 Adapter Connected to 3G Card and Router Chassis**

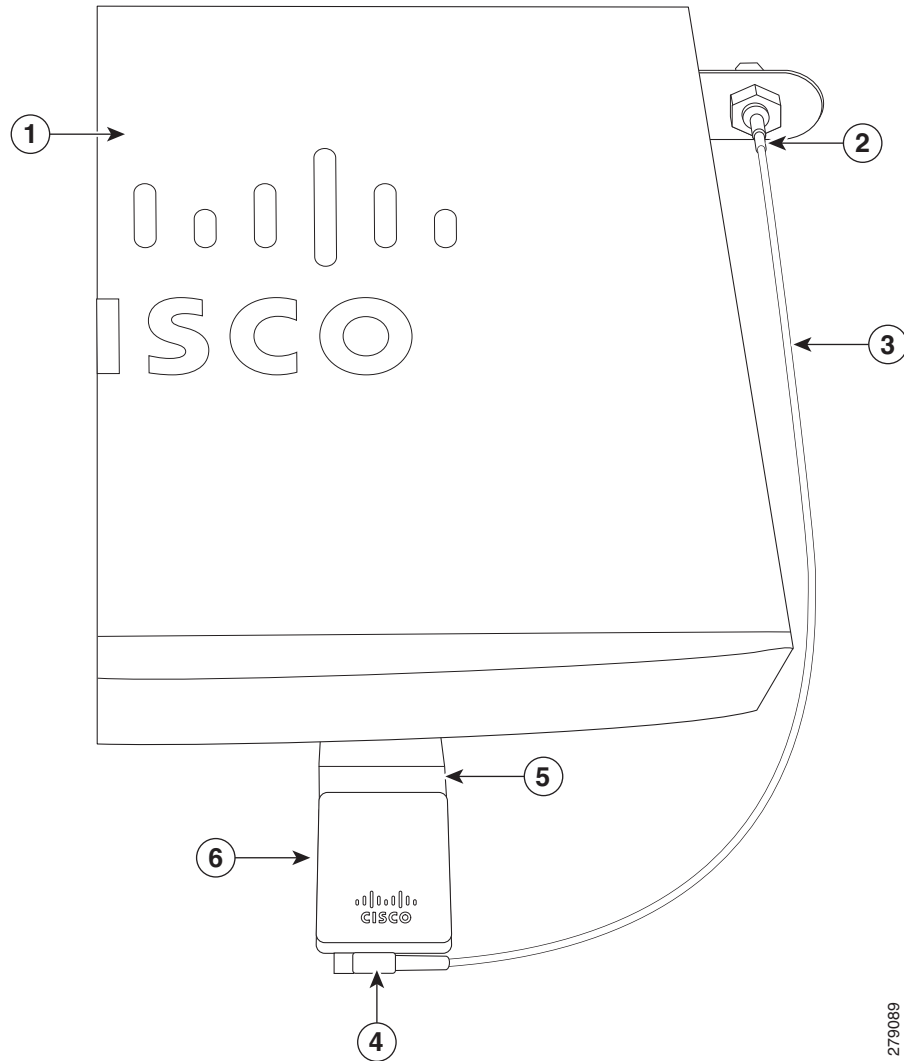

279089

<b>1</b>	Router chassis	<b>4</b>	SSMB or SMK-TS-9 connector
<b>2</b>	3G adapter for extended cable/antenna	<b>5</b>	3G card inserted into the router
<b>3</b>	Cable	<b>6</b>	3G card

Now the adapter is ready for use with the extension cable. Table 3-2 lists the loss information for the ultra-low-loss (ULL) LMR 400 cables available with the adapter for the 3G fixed platforms.



**Table 3-2 Cisco Adapter Cables for Use with 3G Fixed Routers**

Cisco Product Number	Antenna Adapter Length	Insertion Loss	Frequency (MHz)
3G-ACC-SSMB-TNC	14.5 inches	0.66 dB	2100
3G-ACC-TS9-TNC	13.5 inches	0.62 dB	2100

**Note**

Antenna orientation can increase or decrease signal reception due to polarization. Typically, an SP's transmitting antenna on the BTS is a vertically polarized omnidirectional antenna, which means the electromagnetic waves are transmitted from it in a vertical plane. Hence, the receiving antenna needs to be vertically oriented too in order to receive the best signal. As the angle of the antenna orientation is changed from vertical to horizontal, only an angular component of the signal is picked up by the antenna. Therefore, if the antenna orientation is horizontal, the antenna picks up the least signal. The signal is received by the antenna as a result of it bouncing off of reflective surfaces. Hence, depending on where the antenna is placed, it may receive different signal strengths. However, the recommended position is *vertical*.

For additional information on all the available cables and antennas available for 3G, go to:

<http://www.cisco.com/en/US/docs/routers/access/1800/1861/software/feature/guide/mrwlsgsm.html#wp1262730>

## Connecting a Data BRI Port

You can connect the Data BRI port to the ISDN service provider as a backup link to the WAN port in case the primary xDSL (general term referring to various forms of DSL, including global industry standard symmetrical high-speed DSL [G.SHDSL]) WAN service fails. The Data BRI connection is not available on the third-generation (3G) models.

The cabling requirements for the ISDN S/T connection are as follows:

- You must provide two unshielded Category 5 cables. The first cable connects the NT1 box to the splitter, and the second cable connects the splitter to the wall jack.
- There are RJ-45 connectors at both ends of the default orange ISDN S/T cable. However, an RJ-45-to-RJ-11 ISDN S/T cable is available upon request if the wall jack at the site requires an RJ-11 connector. Contact your router reseller for the appropriate cable.

**Caution**

Both LAN and WAN ports use RJ-45 connectors. Use caution when connecting cables to these connectors. To avoid damage to the router, do not connect telephone-network voltage (TNV) circuits (such as ISDN or DSL circuits) to safety extra-low voltage (SELV) circuits (such as LAN circuits).

Although the following procedure shows a Cisco 888W data router, this procedure applies to all Cisco 880 series router with a Data BRI port.

To connect the Data BRI port to the ISDN service provider, follow these steps:

- Step 1** Connect one end of the orange ISDN S/T cable to the Data BRI port on the router. [Figure 3-19](#) shows a Data BRI connection.

**Figure 3-19** Connecting the Data BRI Port to the ISDN Line

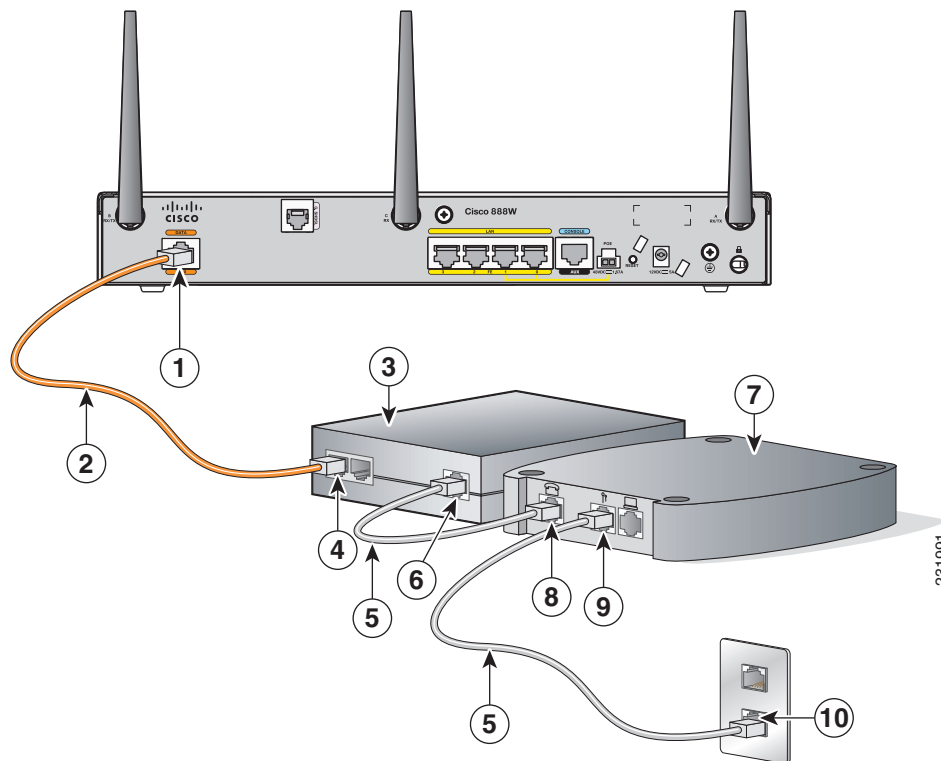

<b>1</b>	Data BRI port on the router	<b>6</b>	U-port on the NT1 box
<b>2</b>	ISDN S/T cable	<b>7</b>	xDSL splitter (provided by the xDSL service provider)
<b>3</b>	Network termination 1 (NT1) box	<b>8</b>	Telephone line port on the splitter
<b>4</b>	S/T port on the NT1 box	<b>9</b>	Telecommunication service port on the splitter
<b>5</b>	Unshielded CAT 5 cable	<b>10</b>	Wall jack

- Step 2** Connect the other end of the orange ISDN S/T cable to the S/T port on the NT1 box.
- Step 3** Connect the first unshielded CAT 5 cable from the U-port on the NT1 box to the telephone line port on the splitter.
- Step 4** Connect the second unshielded Category 5 cable from the telecommunication service port on the splitter to the wall jack to allow a link to the network service provider.

# Connecting an FE Line to an FE WAN Port

To connect the Fast Ethernet (FE) WAN port on the router, follow these steps:

- Step 1** Connect one end of the yellow cable to the FE WAN port as shown in [Figure 3-20](#).

**Figure 3-20** Connecting the FE WAN Port

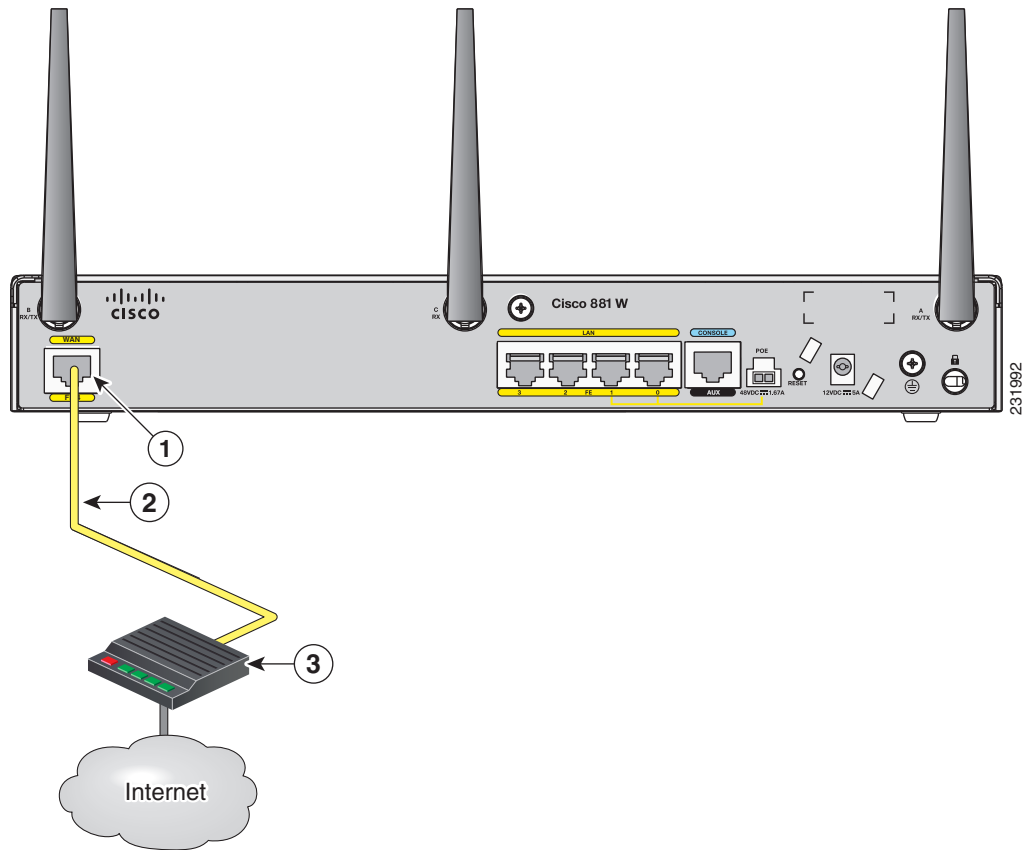

<b>1</b>	FE WAN port	<b>3</b>	Modem connected to the Internet
<b>2</b>	CAT 5 cable		

- Step 2** Connect the other end of cable to an available port on the modem.

# Connecting a GE Line to an GE WAN Port

To connect the Gigabit Ethernet (GE) WAN port on the router, follow these steps:

- Step 1** Connect one end of the yellow cable to the GE WAN port as shown in [Figure 3-21](#).

**Figure 3-21** Connecting the GE WAN Port

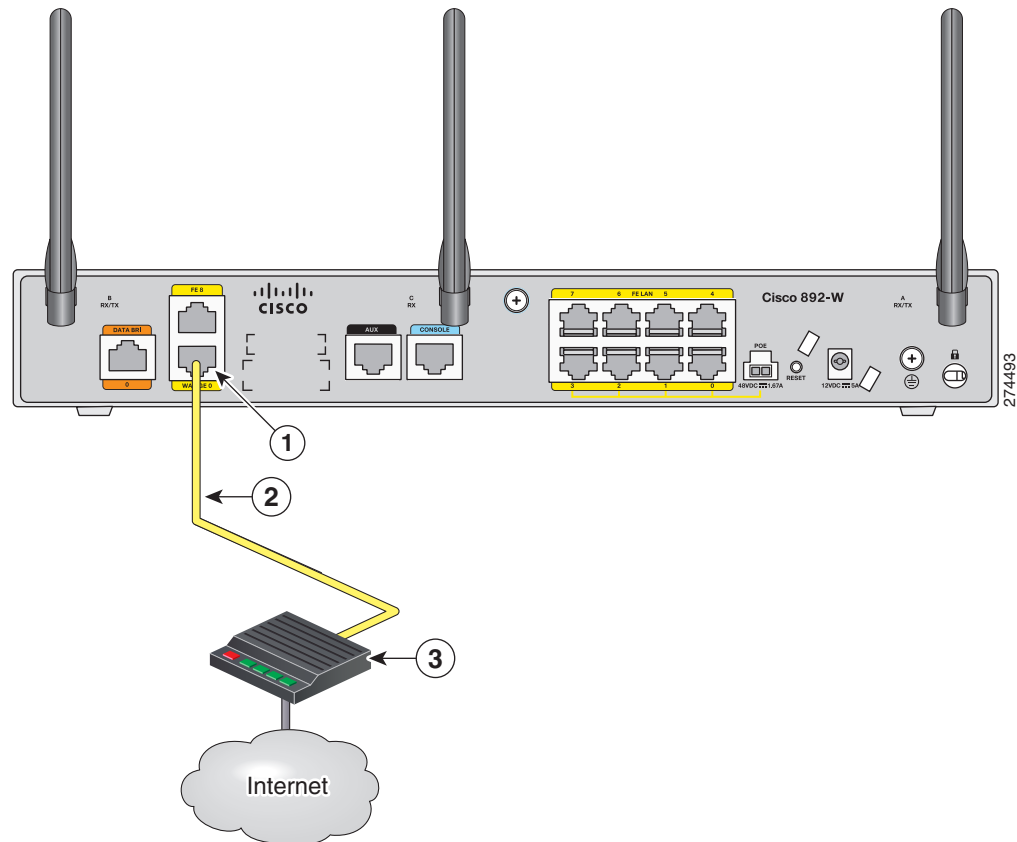

1	GE WAN port	3	Modem connected to the Internet
2	CAT 5 cable		

- Step 2** Connect the other end of cable to an available port on the modem.

# Connecting an xDSL Line

**Warning**

**Hazardous network voltages are present in WAN ports regardless of whether power to the unit is OFF or ON. To avoid electric shock, use caution when working near WAN ports. When detaching cables, detach the end away from the unit first.** Statement 1026

**Caution**

Cisco Systems DSL WAN Interfaces are tested for compliance with regulatory standards such as FCC Part 68, ITU-T K.21, IEC 61000-4-5, and CSA/EN/IEC/UL 60950-1. These standards assume Primary Protection devices protect the Customer Premise Equipment (CPE). These devices are normally installed by the service provider, local exchange carrier or qualified service person and are located at the telecom service provider entrance, network interface box, or demarcation point. See [Figure 3-22](#) for the likely location of the primary protection device. The primary protection device must be suitable for the xDSL interface employed. Please contact your sales team or qualified service person for further information and installation.

**Caution**

To reduce the risk of fire, use only No. 26 AWG or larger (e.g., 24 AWG) UL Listed or CSA Certified Telecommunication Line Cord.

**Warning**

**Do not use this product near water; for example, near a bath tub, wash bowl, kitchen sink or laundry tub, in a wet basement, or near a swimming pool.** Statement 1035

**Warning**

**Avoid using a telephone (other than a cordless type) during an electrical storm. There may be a remote risk of electric shock from lightning.** Statement 1038

**Warning**

**To report a gas leak, do not use a telephone in the vicinity of the leak.** Statement 1039

**Warning**

**There is the danger of explosion if the battery is replaced incorrectly. Replace the battery only with the same or equivalent type recommended by the manufacturer. Dispose of used batteries according to the manufacturer's instructions.** Statement 1015

**Figure 3-22 Primary Protection Device Location**

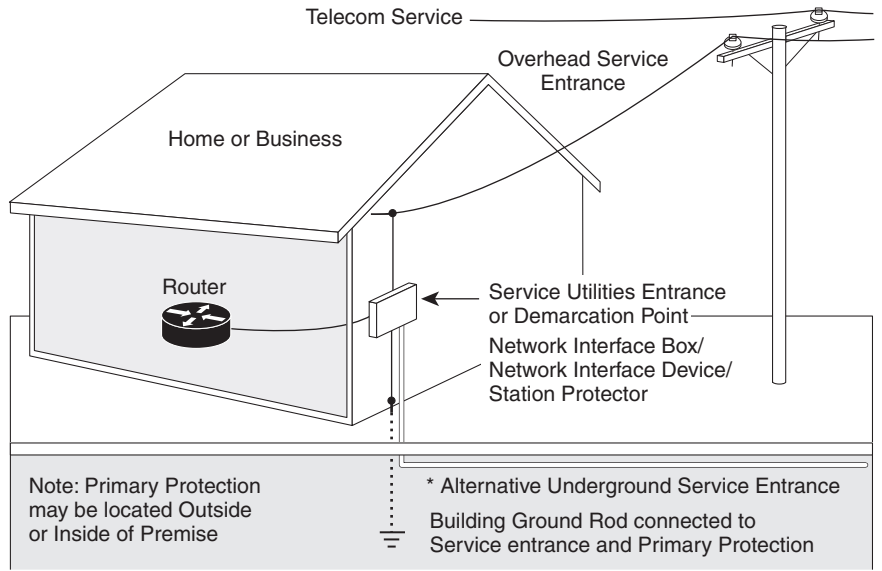

To connect the router to a global industry standard symmetrical high-speed DSL (G.SHDSL) line, very-high-speed digital subscriber line 2 (VDSL2) port, or an ADSL2+ line, follow these steps:

- Step 1** Connect one end of an RJ-11 (RJ-45 on 880 E models) cable to the port on the router. See [Figure 3-23](#).

**Figure 3-23 Connecting the xDSL Line**

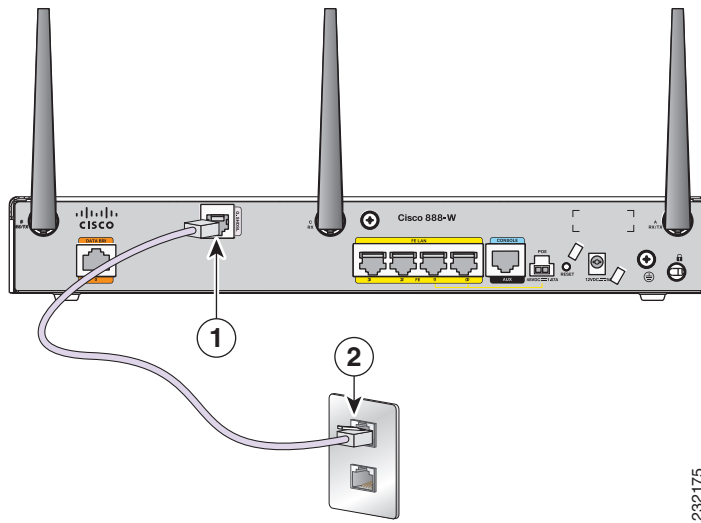

<p><b>1</b> G.SHDSL port, VDSL2oPOTs port, or ADSL2+ port</p>	<p><b>2</b> DSL wall jack</p>
---	-------------------------------

- Step 2** Connect the other end of the cable to the DSL wall jack.

**Caution**

The primary WAN port is designed for an RJ-45 connector only. Damage to the primary WAN port may occur if a non-RJ-45 connector is inserted.

**Note**

The DSL line must be provisioned by your service provider and correctly configured so that the LED shows the carrier detect (CD) status. On Cisco 860VAE routers, check the DSL Link LED.

## Connecting Power over Ethernet

**Warning**

**This unit might have more than one power supply connection. All connections must be removed to de-energize the unit.** Statement 1028

**Warning**

**This product must be connected to a power-over-ethernet (PoE) IEEE 802.3af compliant power source or an IEC60950 compliant limited power source.** Statement 353

Figure 3-24 shows how to connect the 48-VDC Power over Ethernet (PoE) power adapter to your router. The PoE adapter provides power to ports 0 and 1 of the 4-port 10/100 FE switch on the Cisco 880 series routers and ports 0,1, 2, and 3 of the 8-port 10/100 FE switch on the Cisco 890 series routers.

**Note**

The router must also be connected to an AC power outlet through a 12-VDC adapter. To connect the router to an AC outlet, see the [“Connecting the AC Adapter”](#) section on page 3-28.

**Note**

Be sure that the internal PoE is enabled for this connection procedure to work.

Figure 3-24 Connecting PoE for the Cisco 880 and the Cisco 890 Series Routers

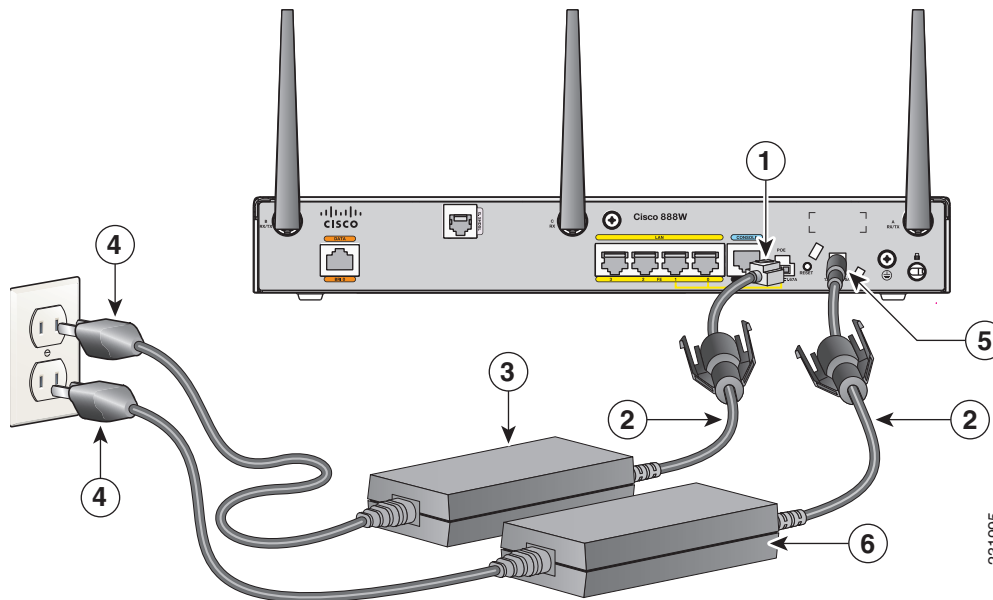

1	48-VDC PoE input jack	4	AC plug
2	Power cord	5	12-VDC input power-jack plug
3	Power adapter—48 VDC	6	Power adapter—12 VDC

The Cisco 880 series ISRs with embedded WLAN antennas require a single external power supply: a 30-W power supply for non-POE-enabled routers or a 60-W power supply for POE-enabled routers. For the back panels of some of these routers, see [Figure 1-19](#) and [Figure 1-21](#).

For more information on configuring PoE, refer to the [Cisco 860 Series, Cisco 880 Series, and Cisco 890 Series Integrated Services Routers Software Configuration Guide](#).

## Connecting the AC Adapter



**Warning**

**The device is designed to work with TN power systems.** Statement 19



**Warning**

**This product relies on the building's installation for short-circuit (overcurrent) protection. Ensure that the protective device is rated not greater than: 120 VAC, 20 A U.S. (240 VAC, 16 to 20 A international).** Statement 1005



**Warning**

**This unit might have more than one power supply connection. All connections must be removed to de-energize the unit.** Statement 1028





**Note** The Cisco 892FSP utilizes a single 4-pin power connector type. [Figure 3-27](#) shows the pin number assignment of the Cisco 892FSP Power Adapter Connector.

To connect your Cisco 860 series, Cisco 880 series, or the Cisco 890FSP ISR to an AC power outlet, follow these steps:

**Step 1** Connect the router to an AC power outlet as shown in [Figure 3-25](#). To connect the Cisco 892FSP router, see [Figure 3-26](#).

**Figure 3-25 Connecting the AC Adapter**

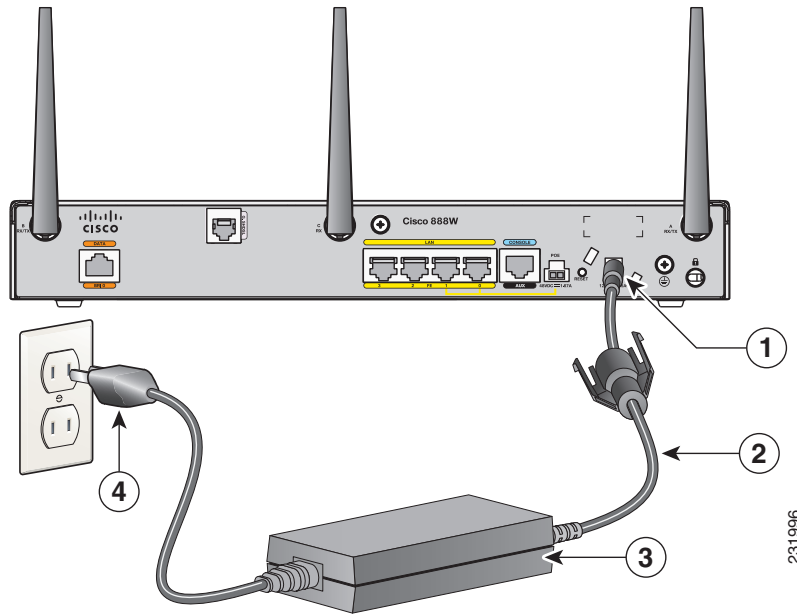

<b>1</b>	12-VDC plug	<b>3</b>	Power adapter—12 VDC
<b>2</b>	Power cord	<b>4</b>	AC plug

Figure 3-26 Connecting the AC Adapter for the Cisco 892FSP

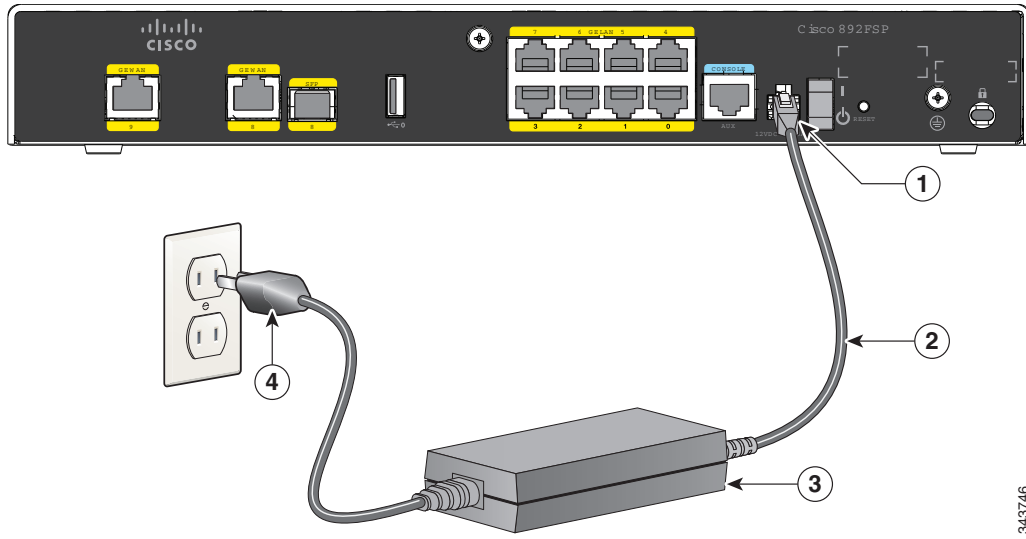

1	12-VDC plug	3	Power adapter—12 VDC
2	Power Adapter Cord	4	AC Plug

Figure 3-27 Cisco 892FSP, 896VA, 897VA, and 898EA Power Adapter Connector Pin Assignment

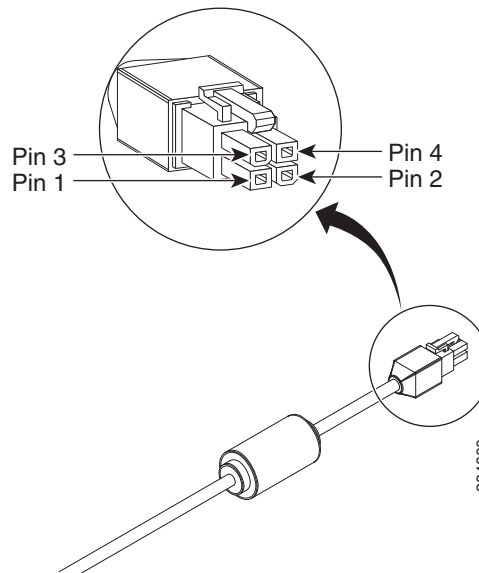

Pin 1	Ground	Pin 3	+12 V
Pin 2	NC <sup>1</sup>	Pin 4	NC

1. NC = No Connection.

**Step 2** To secure the power cord to the router, attach the power lock clip to the power cord, slide the clip to the end of the DC plug, and secure the retaining clip into the router chassis. See [Figure 3-28](#).

**Figure 3-28 Securing the Power Cord**

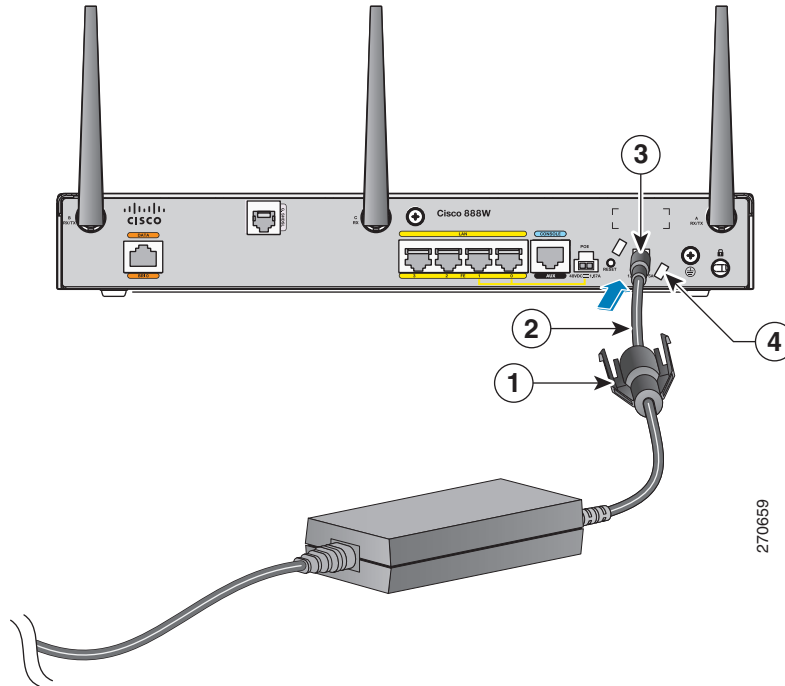

<b>1</b>	Power lock clip	<b>3</b>	DC plug
<b>2</b>	Power cord	<b>4</b>	Lock holes on either side of the power connector

**Step 3** Snap the latches into the holes on either side of the power connector. See [Figure 3-29](#).

**Figure 3-29** Power Lock Clip Latched Into the Holes on Either Side of the Power Connector

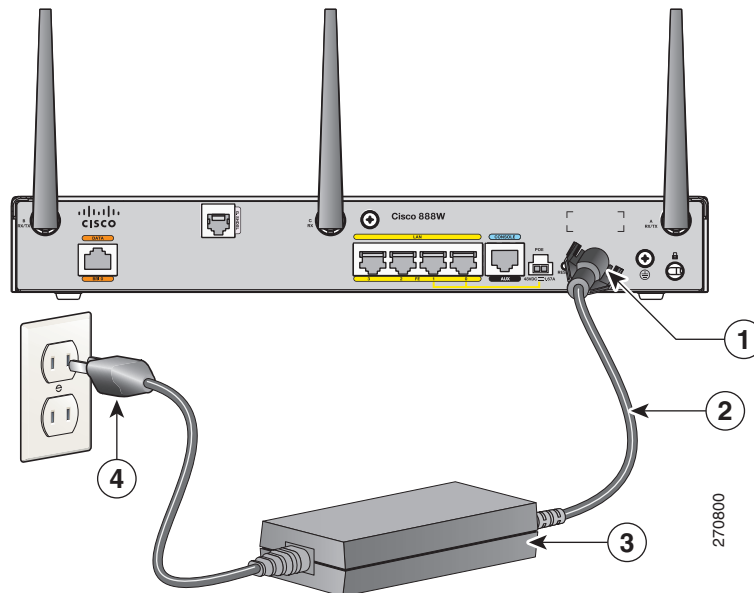

1	Power lock clip	3	Power adapter
2	Power cord	4	AC plug



**Note** [Figure 3-26](#) shows how to connect the AC power outlet for the Cisco 892FSP.

## Connecting an FXS Line

Use a standard straight-through RJ-11 modular telephone cable to connect a Foreign Exchange Service (FXS) port to a telephone or fax machine.



**Warning**

**This equipment contains a ring signal generator (ringer), which is a source of hazardous voltage. Do not touch the RJ-11 (phone) port wires (conductors), the conductors of a cable connected to the RJ-11 port, or the associated circuit-board when the ringer is active. The ringer is activated by an incoming call.** Statement 1042



**Warning**

**Hazardous network voltages are present in WAN ports regardless of whether power to the unit is OFF or ON. To avoid electric shock, use caution when working near WAN ports. When detaching cables, detach the end away from the unit first.** Statement 1026



**Warning**

**For connections outside the building where the equipment is installed, the following ports must be connected through an approved network termination unit with integral circuit protection: FXS.**  
Statement 1044

To connect the FXS line, follow these steps:

- Step 1** Connect one end of the straight-through RJ-11 cable to the FXS port. [Figure 3-30](#) shows an FXS line connection.

**Figure 3-30** Connecting an FXS Line

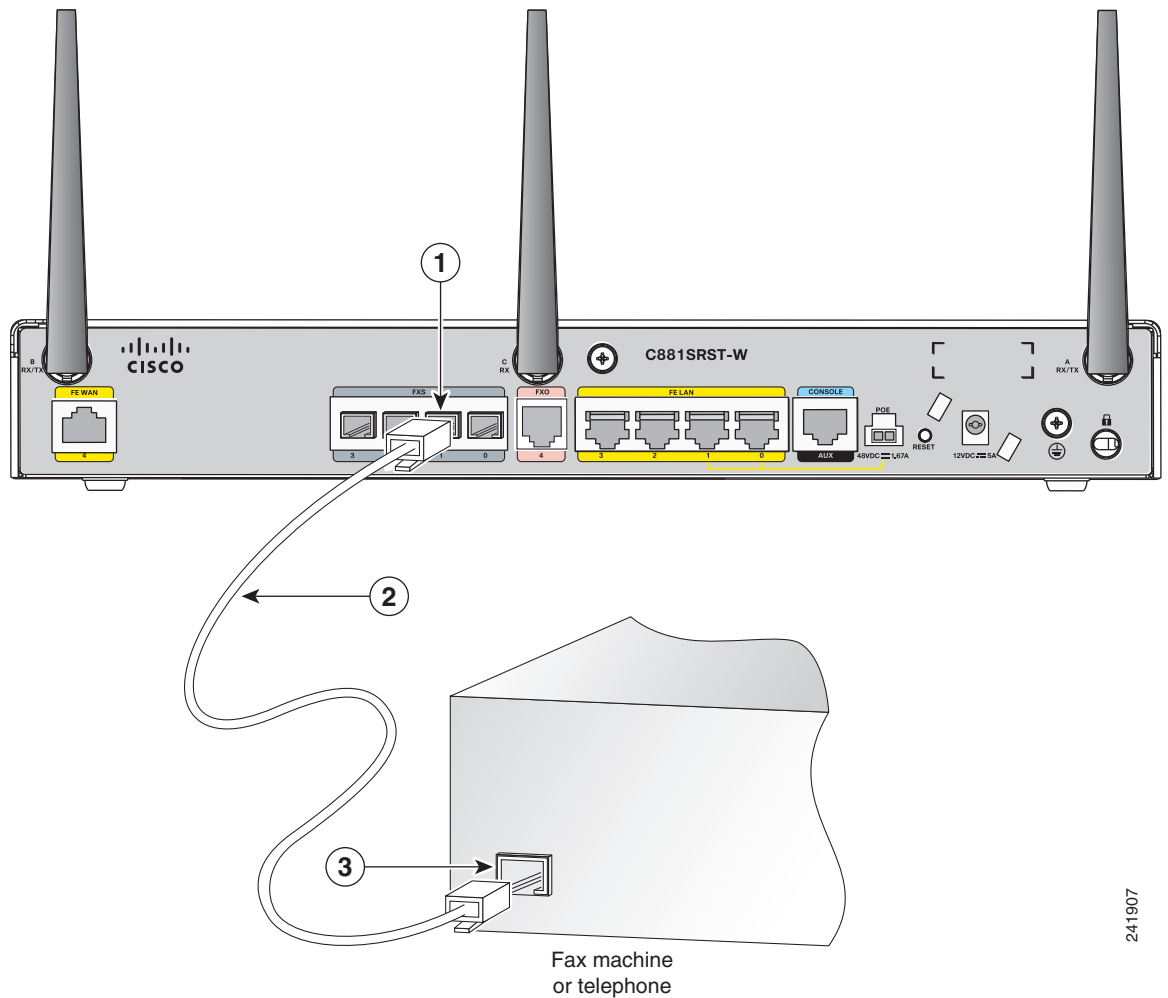

1	FXS port	3	RJ-11 port
2	RJ-11 cable		

- Step 2** Connect the other end of the cable to the RJ-11 port on the fax machine or telephone.

# Connecting an FXO Line

Use a straight-through RJ-11 cable to connect the FXO voice port to the PSTN or PBX through a telephone wall outlet.



## Warning

**Hazardous network voltages are present in WAN ports regardless of whether power to the unit is OFF or ON. To avoid electric shock, use caution when working near WAN ports. When detaching cables, detach the end away from the unit first.** Statement 1026

To connect the FXO line, follow these steps:

- Step 1** Connect one end of the straight-through RJ-11 cable to the FXO port. See [Figure 3-31](#).

**Figure 3-31** Connecting an FXO Line

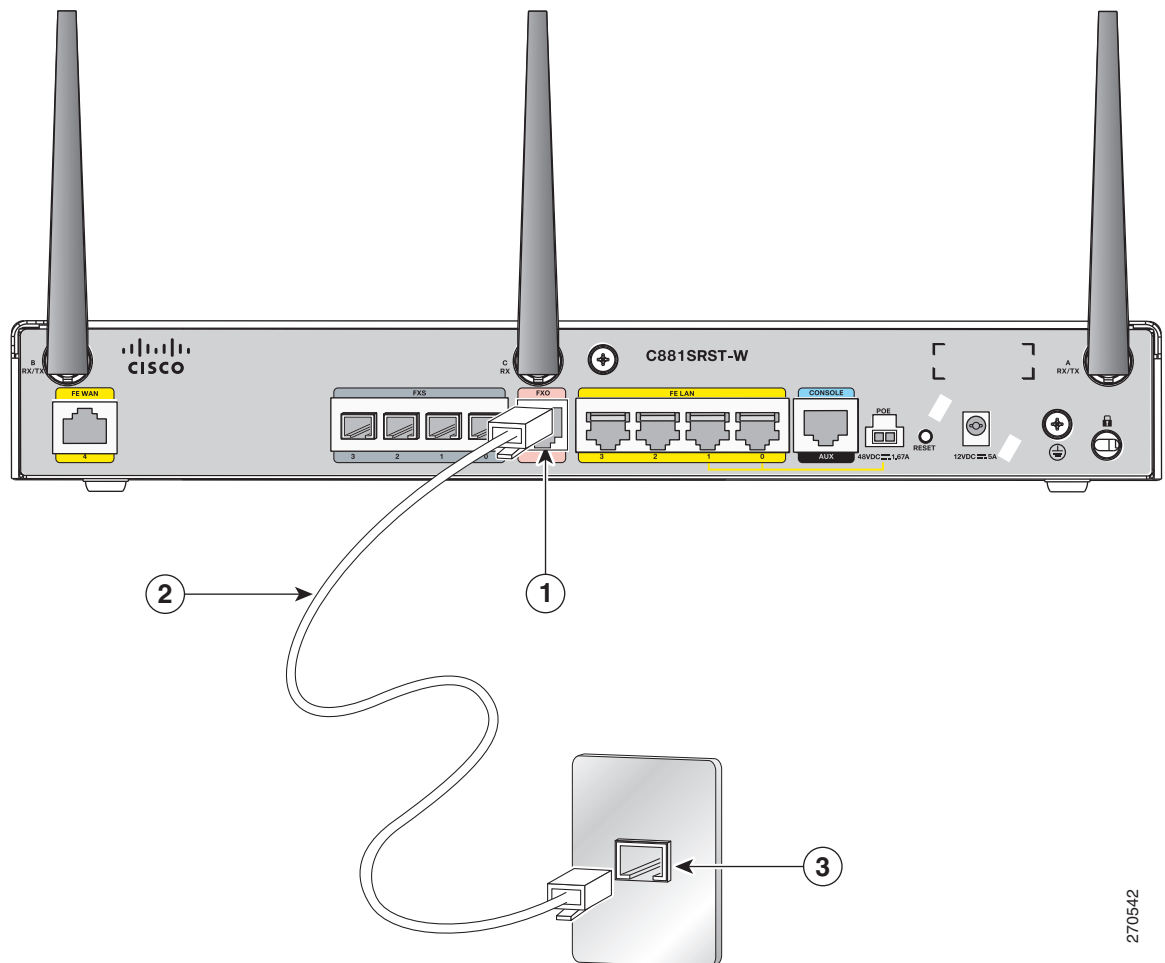

1	FXO port	3	Telephone outlet
2	RJ-11 cable		

- Step 2** Connect the other end of the RJ-11 cable to a telephone wall outlet.

**Note**

If you have specified the use of a private line automatic ringdown (PLAR) off-premises extension (OPX) connection mode for an FXO voice port (with loop resistance less than 8000 Ohm), you must ensure that the soft-offhook option is enabled on the port.

This option allows a stepped offhook resistance during seizure, which avoids overloading the circuit during offhook in the event that ringing voltage is present on the circuit at the same time as the trunk seizure. The stepped offhook resistance is initially set to 800 Ohms, then adjusts to 50 Ohms when ringing voltage is not present.

To enable the **soft-offhook** command on the port, and to access the **connection** command with `plar opx` syntax, see the [Cisco Command Lookup Tool](#).

## Connecting a Voice ISDN BRI Line

Use a straight-through RJ-45 cable to connect the voice BRI port to the ISDN network through a telephone outlet or other device.

**Caution**

To prevent damage to the router, be sure to connect the BRI cable to the BRI connector only and not to any other RJ-45 connector.

To connect the voice BRI line, follow these steps:

**Step 1**

Connect one end of a straight-through RJ-45-to-RJ-45 cable to the Voice BRI port.

**Note**

When the interface is configured as NT and is connecting to a TE device, use a crossover cable. See [Table A-16](#).

Figure 3-32 shows a voice BRI line connection.

**Figure 3-32** Connecting a Voice BRI Line

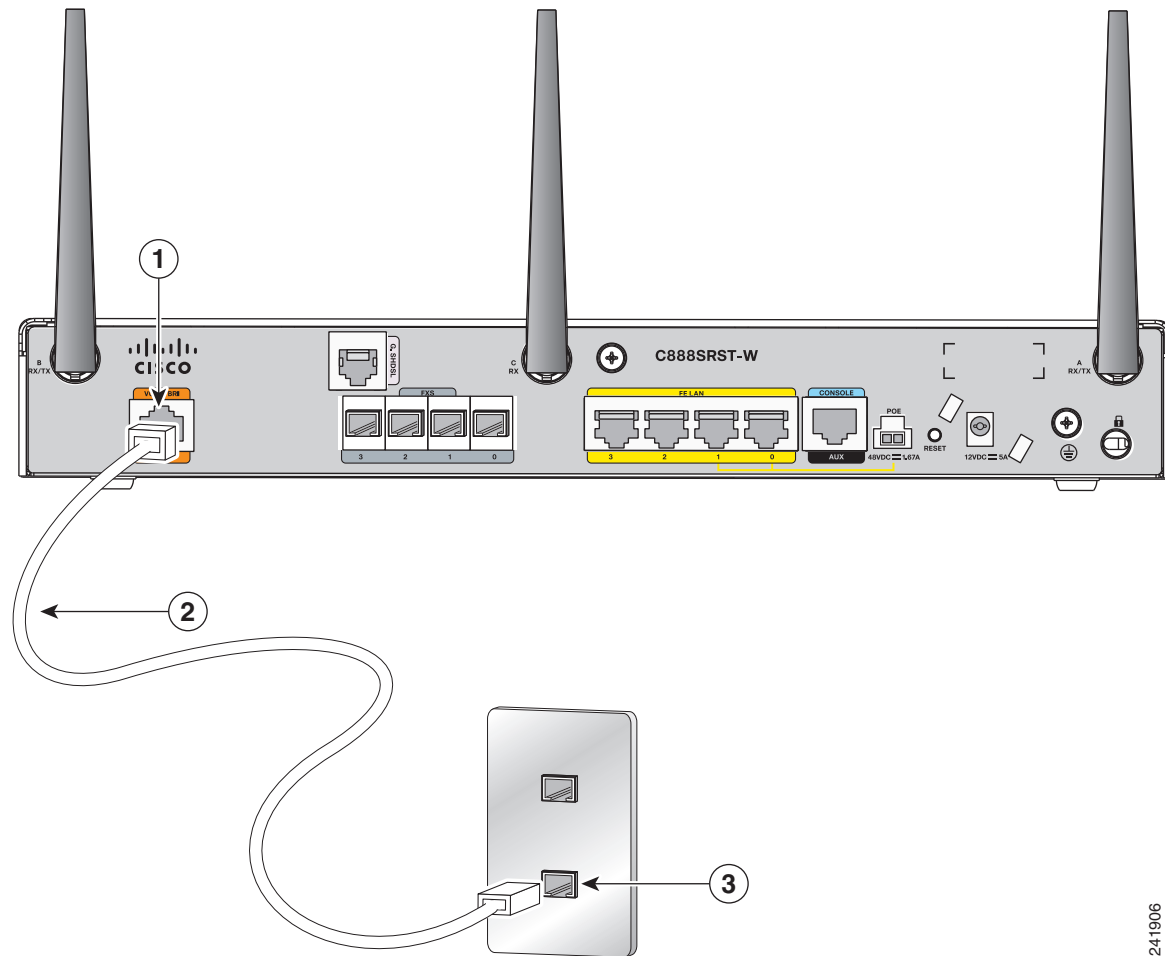

<b>1</b>	Voice BRI port	<b>3</b>	Telephone outlet
<b>2</b>	RJ-45 cable		

**Step 2** Connect the other end of the cable to the RJ-45 telephone outlet or other device.

241906



# Connecting a Small Form-Factor Pluggable Module

This section describes how to connect and remove a small form-factor (SFP) module and contains the following information:

- [Safety Warnings, page 3-37](#)
- [Installing an SFP Module, page 3-38](#)
- [Removing an SFP Module, page 3-38](#)
- [Online Insertion and Removal, page 3-39](#)

## Safety Warnings

### Laser Safety Warnings

Optical SFPs use a small laser to generate the fiber-optic signal. Keep the optical transmit and receive ports covered whenever a cable is not connected to the port.



---

**Invisible laser radiation may be emitted from disconnected fibers or connectors. Do not stare into beams or view directly with optical instruments.** Statement 1051

---



---

**Do not stare into the laser beam.** Statement 1010

---



---

**Invisible laser radiation present.** Statement 1016

---



---

**Ultimate disposal of this product should be handled according to all national laws and regulations.** Statement 1040

---



---

**Invisible laser radiation may be emitted from the end of the unterminated fiber cable or connector. Do not view directly with optical instruments. Viewing the laser output with certain optical instruments (for example, eye loupes, magnifiers, and microscopes) within a distance of 100 mm may pose an eye hazard.** Statement 1056

---



---

**Use of controls, adjustments, or performing procedures other than those specified may result in hazardous radiation exposure.** Statement 1057

---

## Installing an SFP Module

To connect and secure the SFP module, follow these steps:

**Step 1** Slide the SFP into the SFP port connector until it locks into position (see [Figure 3-33](#)).



**Tip**

If the SFP uses a bale-clasp latch (see [Figure 3-33](#)), the handle should be on top of the SFP module.

**Figure 3-33** Installing an SFP Module

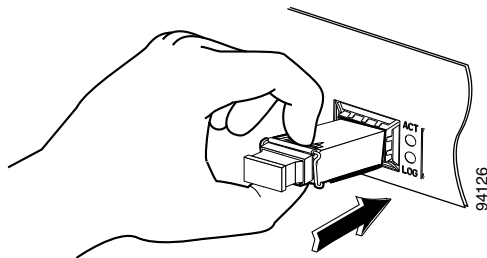

**Caution**

Do not remove the optical port plugs from the SFP until you are ready to connect cabling.

**Step 2** Connect the network cable to the SFP module.

## Removing an SFP Module

Follow these steps to remove the SFP module from a Cisco 892F series router:

**Step 1** Disconnect all cables from the SFP.



**Warning**

**Invisible laser radiation may be emitted from disconnected fibers or connectors. Do not stare into beams or view directly with optical instruments.** Statement 1051



**Caution**

The latching mechanism used on many SFPs locks the SFP into place when cables are connected. Do not pull on the cabling in an attempt to remove the SFP.

**Step 2** Disconnect the SFP latch. See [Figure 3-34](#).



**Note**

SFP modules use various latch designs to secure the module in the SFP port. Latch designs are not linked to SFP model or technology type. For information on the SFP technology type and model, see the label on the side of the SFP.

Figure 3-34 Figure 5-42 Disconnecting SFP Latch Mechanisms

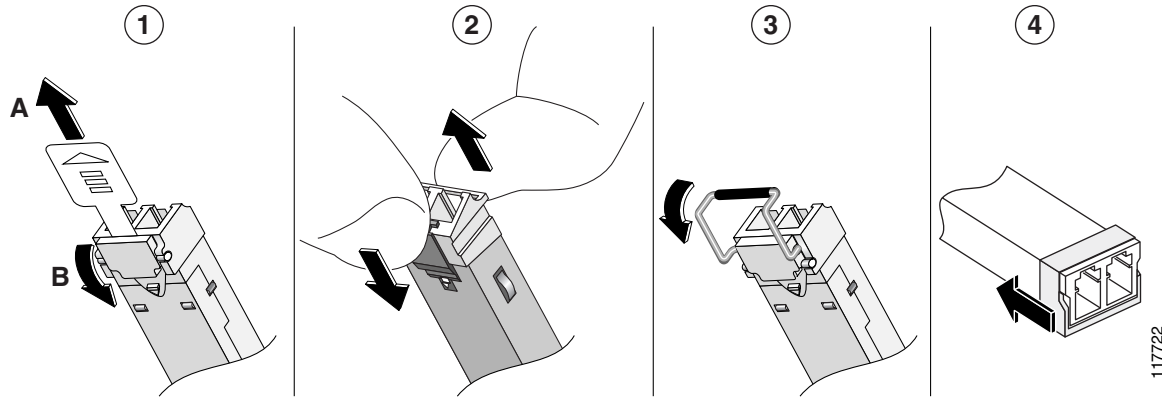

1	Sliding latch	3	Bale-clasp latch
2	Swing and slide latch	4	Plastic collar latch



**Tip**

Use a pen, screwdriver, or other small straight tool to gently release a bale-clasp handle if you cannot reach it with your fingers.

**Step 3**

Grasp the SFP on both sides and remove it from the router.

## Online Insertion and Removal

Online insertion and removal (OIR) of the SFP module is supported on the Cisco 892F ISRs.



**Note**

If an SFP module is inserted with auto-failover or SFP media-type already configured, the port is forced to the speed and duplex capability of the SFP. For a 100 base SFP, the speed is set to 100 and duplex can be configured to either half or full. For a 1000 base SFP, the speed is set to 1000 and duplex is set to full.

# Verifying Connections

To verify that all devices are properly connected to the router, first turn on all the connected devices, then check the LEDs. To verify router operation, refer to [Table 3-3](#).

For the full LED descriptions, see the “LEDs” section on page 1-35.

**Table 3-3 Verifying the Router Operation**

Power and Link	LEDs to Check	Normal Patterns
Power	OK	On when power is supplied to the router.
To servers, PCs, workstations, or an external Ethernet switch connected to the LAN ports (FE0 <sup>1</sup> , FE1, FE2, or FE3)	LAN 0, LAN 1, LAN 2, or LAN 3	On when the FE LAN port is physically connected to a server, PC, workstation, or external Ethernet switch.
To FE WAN line	WAN FE4	On when the WAN Ethernet carrier has detected status. Blinks when receiving or transmitting data.
To xDSL <sup>2</sup> line	xDSL CD	Green when the line is connected to the xDSL DSLAM <sup>3</sup> .
	xDSL Data	Green when receiving or sending data. Blinks when line is in training mode.
ATM	898EA only	Green when ATM mode is selected.
EFM	898EA only	Green when EFM mode is selected.
To ISDN line	Data BRI LNK	Green when the ISDN line is connected.
	Data BRI B1 and B2	Green when the channel is connected.
3G <sup>4</sup>	WWAN <sup>5</sup>	Green when service is established. Slow blinking when searching for service.
	RSSI <sup>6</sup>	Amber when service is not established. Green when signal strength is high. Off or slow blinking when signal strength is low. Fast blinking when signal strength is medium.
	CDMA <sup>7</sup>	Green when service is established.
	GSM <sup>8</sup>	Green when service is established.
To PPP <sup>9</sup> clients	PPP	Green when either a PPPoE <sup>10</sup> or PPPoA <sup>11</sup> client is running.
To VPN <sup>12</sup> tunnel	VPN	Green when a crypto session is running.

**Table 3-3 Verifying the Router Operation (continued)**

Power and Link	LEDs to Check	Normal Patterns
To wireless LAN	WLAN LINK	Wireless LAN link status: <ul style="list-style-type: none"> <li>• Green if at least one client is associated.</li> <li>• Off if no client is associated.</li> </ul>
	WLAN 2.4 GHz	Wireless LAN 2.4-GHz status: <ul style="list-style-type: none"> <li>• Green when radio is connected, SSID<sup>13</sup> is configured, signal is being transmitted, and client is associated.</li> <li>• Slow blinking when radio is connected, SSID is configured, and signal is being transmitted.</li> </ul>
	WLAN 5.0 GHz	Wireless LAN 5.0-GHz status: <ul style="list-style-type: none"> <li>• Green when radio is connected, SSID is configured, signal is being transmitted, and client is associated.</li> <li>• Slow blinking when radio is connected, SSID is configured, and signal is being transmitted.</li> </ul>
PoE <sup>14</sup>	PoE 0 (880 and 890 series only)	PoE power status: <ul style="list-style-type: none"> <li>• Green when connected and powered.</li> <li>• Amber when there is a fault with the inline power supply.</li> </ul>
	PoE 1 (880 and 890 series only)	
	PoE 2 (890 series only)	
	PoE 3 (890 series only)	
SFP <sup>15</sup>	EN	Green when the interface is up.
	S	Blinking green indicates port speed. Slow blinking for 100Base SFPs and fast blinking for 1000Base SFPs.
To LAN GE/FE line (860VAE models only)	LAN	Blinking when there is LAN activity (traffic in either direction). Off when the link is down.

**Table 3-3** Verifying the Router Operation (continued)

Power and Link	LEDs to Check	Normal Patterns
To DSL line (860VAE models only)	DSL LINK	On when DSL WAN mode is selected and DSL training complete.  Blinking when DSL WAN mode is selected but incomplete DSL LinkUp state such as in-training (slow initially, fast when almost connected), or controller "OFF", or no cable attached to DSL connector.  Off when the device is powered off; or GE WAN mode is selected.
	DSL ACT	On when the DSL interface is up.  Blinking when there is DSL WAN activity (traffic in either direction).  Faster blinking when there is heavier traffic.  Off when the device is powered off or the DSL WAN interface is down.
To WAN GE line (860VAE models only)	GE Mode	On when GE WAN mode is selected.  Off when the device is powered off or when DSL WAN mode is selected.
	GE ACT	On when the GE WAN interface is up.  Blinking when there is GE WAN activity (traffic in either direction).  Off when the device is powered off or when the GE WAN interface is down.

1. FE = Fast Ethernet.
2. xDSL = General term referring to various forms of DSL, including ADSL (asymmetric digital subscriber line), VDSL (very-high-data-rate digital subscriber line), and G.SHDSL.
3. DSLAM = digital subscriber line access multiplexer.
4. 3G = Third-Generation.
5. WWAN = wireless WAN.
6. RSSI = Received Signal Strength Indicator.
7. CDMA = code division multiple access.
8. GSM = Global System for Mobile Communications.
9. PPP = Point-to-Point Protocol.
10. PPPoE = PPP over Ethernet.
11. PPPoA = PPP over ATM.
12. VPN = Virtual Private Network.
13. SSID = service set identifier.
14. PoE = Power over Ethernet.
15. SFP = small-form-factor pluggable.



## Initial Configuration

---

This chapter provides instructions for initial configuration of the Cisco 860 series, 880 series, and 890 series Integrated Services Routers (ISRs). For the initial configuration, we recommend using Cisco Configuration Professional (CP) Express. Cisco CP Express is a web-based graphical user interface that guides you through initial configuration.

You may also initially configure your router by using the Cisco IOS command-line interface (CLI) or by using the setup command facility. To create the initial configuration, the setup command facility prompts you for basic information about your router and network.

This chapter contains the following sections:

- [Cisco Configuration Professional Express, page 4-1](#)
- [Cisco IOS CLI, page 4-1](#)
- [Setup Command Facility, page 4-3](#)
- [Verifying the Initial Configuration, page 4-5](#)
- [Initial Configuration of the Wireless Access Point, page 4-6](#)



### Note

---

Some SKUs may not include a default configuration file. If your router does not have a default configuration file, go to the [“Setup Command Facility” section on page 3](#) to configure the initial router settings.

---

## Cisco Configuration Professional Express

After you connect the cables and power up the router, we recommend that you use the Cisco CP Express web-based application to configure the initial router settings.

For instructions on how to use Cisco CP Express to configure the router see [Cisco CP Express User's Guide](#).

## Cisco IOS CLI

To configure the initial router settings by using the Cisco IOS CLI, you must set up a console connection. For instructions on how to set up a console connection, see the [“Connecting a Terminal or PC to the Console Port” section on page 3-9](#).

To configure the initial router settings using the Cisco IOS CLI, follow these steps:

**Step 1** Set up a console connection to your router. The following message is displayed:

```
...
router con0 is now available
```

**Step 2** Press **Return**. The following message is displayed:

```
Cisco Configuration Professional Express (Cisco CP Express) is installed on this device.
This feature requires the one-time use of the username "username1"
with the password "password1." The default username and password have a privilege level of
15.
```

```
Please change these publicly known initial credentials using Cisco CP Express or the Cisco
IOS CLI.
```

```
Here are the Cisco IOS commands.
```

```
username <myuser> privilege 15 secret 0 <mypassword>
no username username1
```

```
Replace <myuser> and <mypassword> with the username and password you want to use.
```

```
For more information about Cisco CP please follow the instructions in the QUICK START
GUIDE for your router...
```

```
...
User Access Verification
Username:
```

**Step 3** Enter the username **username1**, and press **Return** or **Enter**. The following prompt is displayed:

```
Password:
```

**Step 4** Enter the password **password1**, and press **Return** or **Enter**. The following prompt is displayed:

```
Router#
```

A message is displayed that is similar to the first warning message. The message directs you to change the username and password.

You are now in privileged EXEC mode.



**Note** You must change the username and password before you log off the router. You cannot use the username **username1** or password **password1** after you log off from this session.

**Step 5** Enter configuration mode using the following commands.

```
Router#
Router#config t
Router(config)#
Router(config)#username username privilege 15 secret 0 password
```

**Step 6** To change the username and password, enter the following at the prompt:

```
username username privilege 15 secret 0 password
```

The *username* and *password* are the username and password that you determine.

To continue using the Cisco IOS CLI for initial configuration, see the applicable configuration procedures in [Cisco 860 Series, Cisco 880 Series, and Cisco 890 Series Integrated Services Routers Software Configuration Guide](#).





**Note** Save your configuration changes regularly to avoid losing them during resets, power cycles, or power outages. Use the **copy running-config startup-config** command at the privileged EXEC mode prompt (Router#) to save the configuration to NVRAM.

**Step 7** Verify the initial configuration. See the “[Verifying the Initial Configuration](#)” section on page 4-5.

## Setup Command Facility

The setup command facility guides you through the configuration process by prompting you for the specific information that is needed to configure your system. Use the setup command facility to configure a hostname for the router, to set passwords, and to configure an interface for communication with the management network.

To use the setup command facility, you must set up a console connection with the router and enter the privileged EXEC mode.



**Note** For instructions on how to set up a console connection, see the “[Connecting a Terminal or PC to the Console Port](#)” section on page 3-9.

To configure the initial router settings by using the setup command facility, follow these steps:

**Step 1** Set up a console connection to your router, and enter privileged EXEC mode. For instructions on how to enter privileged EXEC mode, see [Step 1](#) through [Step 4](#) in the “[Cisco IOS CLI](#)” section on page 4-1.

**Step 2** In privileged EXEC mode, at the prompt, enter **setup**.

```
yourname# setup
```

The following message is displayed:

```
--- System Configuration Dialog ---
Continue with configuration dialog? [yes/no]:
```

You are now in the setup command facility.

The prompts in the setup command facility vary, depending on your router model, on the installed interface modules, and on the software image. The following steps and the user entries (in **bold**) are shown as examples only.



**Note** If you make a mistake while using the setup command facility, you can exit and run the setup command facility again. Press **Ctrl-C**, and enter the **setup** command at the privileged EXEC mode prompt (Router#). For more information on using the setup command facility, see “[The Setup Command](#)” chapter in *Cisco IOS Configuration Fundamentals Command Reference, Release 12.2T*.

**Step 3** To proceed using the setup command facility, enter **yes**.

```
Continue with configuration dialog? [yes/no]: yes
```

**Step 4** When the following messages appear, enter **yes** to enter basic management setup.

At any point you may enter a question mark '?' for help.  
Use ctrl-c to abort configuration dialog at any prompt.

Default settings are in square brackets '['].

Basic management setup configures only enough connectivity  
for management of the system, extended setup will ask you  
to configure each interface on the system

Would you like to enter basic management setup? [yes/no]: **yes**

**Step 5** Enter a hostname for the router (this example uses Router).

Configuring global parameters:  
Enter host name [Router]: **Router**

**Step 6** Enter an enable secret password. This password is encrypted (more secure) and cannot be seen when viewing the configuration.

The enable secret is a password used to protect access to  
privileged EXEC and configuration modes. This password, after  
entered, becomes encrypted in the configuration.

Enter enable secret: **xxxxxxx**

**Step 7** Enter an enable password that is different from the enable secret password. This password is *not* encrypted (less secure) and can be seen when viewing the configuration.

The enable password is used when you do not specify an  
enable secret password, with some older software versions, and  
some boot images.

Enter enable password: **xxxxxxx**

**Step 8** Enter the virtual terminal password, which prevents unauthenticated access to the router through ports other than the console port.

The virtual terminal password is used to protect  
access to the router over a network interface.

Enter virtual terminal password: **xxxxxxx**

**Step 9** Respond to the following prompts as appropriate for your network.

Configure SNMP Network Management? [yes]:  
Community string [public]:

A summary of the available interfaces is displayed.

**Step 10** Choose one of the available interfaces for connecting the router to the management network.

Enter interface name used to connect to the  
management network from the above interface summary: **fastethernet4**

**Step 11** Respond to the following prompts as appropriate for your network.

Configuring interface FastEthernet4:  
Use the 100 Base-TX (RJ-45) connector? [yes]: **yes**  
Operate in full-duplex mode? [no]: **yes**  
Configure IP on this interface? [yes]: **yes**  
IP address for this interface: **172.1.2.3**  
Subnet mask for this interface [255.255.0.0] : **255.255.0.0**  
Class B network is 172.1.0.0, 26 subnet bits; mask is /16

The configuration is displayed:

The following configuration command script was created:

```
hostname Router
enable secret 5 $1$D5P6$PYx41/lQIASK.HcSbf05q1
enable password xxxxxx
line vty 0 4
password xxxxxx
snmp-server community public
!
no ip routing
!
interface FastEthernet4
no shutdown
speed 100
duplex auto
ip address 172.1.2.3 255.255.0.0
!
```

**Step 12** Respond to the following prompts. Enter **2** to save the initial configuration.

```
[0] Go to the IOS command prompt without saving this config.
[1] Return back to the setup without saving this config.
[2] Save this configuration to nvram and exit.
```

```
Enter your selection [2]: 2
Building configuration...
Use the enabled mode 'configure' command to modify this configuration.
```

```
Press RETURN to get started! RETURN
```

```
The user prompt is displayed.
Router>
```

**Step 13** Verify the initial configuration. See the “[Verifying the Initial Configuration](#)” section on page 4-5 for verification procedures.

---

After the initial configuration file is created, you can use the Cisco IOS CLI to perform additional configuration.

## Verifying the Initial Configuration

To verify that the new interfaces are operating correctly, perform the following tests:

- To verify that the interfaces and line protocol are in the correct state—up or down—enter the **show interfaces** command.
- To display a summary status of the interfaces configured for IP, enter the **show ip interface brief** command.
- To verify that you configured the correct hostname and password, enter the **show configuration** command.

After you complete and verify the initial configuration, you can configure your Cisco router for specific functions.

# Initial Configuration of the Wireless Access Point

The embedded wireless access point (AP) runs its own IOS. You can initially configure the embedded wireless AP by using one of the following methods:

- Cisco Configuration Professional (CP) Express
- Setup command facility on the embedded wireless device

For information on how to do basic wireless configuration on your router see the “[Basic Wireless Device](#)” chapter of the *Cisco 860 Series, Cisco 880, and Cisco 890 Series Integrated Services Routers Software Configuration Guide*.



## Technical Specifications

---

This appendix provides router, port, and cabling specifications for the Cisco 860 series, Cisco 880 series, and Cisco 890 series Integrated Services Routers (ISRs). It contains the following sections:

- [Router Specifications, page A-2](#)
- [Power Supply, page A-5](#)
- [Wireless Access Point, page A-5](#)
- [FE and GE Port Pinouts, page A-6](#)
- [Console and Auxiliary Port Connector Pinouts, page A-7](#)
- [FXS and FXO Port Connector Pinouts, page A-7](#)
- [VDSL2 Port Connector Pinouts, page A-7](#)
- [ADSL2+ Port Connector Pinouts, page A-8](#)
- [V.92 Port Connector Pinouts, page A-8](#)
- [G.SHDSL Port Connector Pinouts, page A-8](#)
- [Data BRI Port Connector Pinouts, page A-9](#)
- [Voice ISDN BRI Interface Pin Numbers and Functions, page A-10](#)
- [SFP Port Connector Pinouts, page A-10](#)
- [Cable Specifications, page A-11](#)



**Warning**

---

**Ultimate disposal of this product should be handled according to all national laws and regulations.**  
Statement 1040

---



**Note**

---

For compliance and safety information, see *Regulatory Compliance and Safety Information Roadmap* that was shipped with the router and [Regulatory Compliance and Safety Information for Cisco 800 Series](#).

---



**Note**

---

The product has some color variation on the Power Pin. This will not impact product performance or reliability.

---

# Router Specifications

## All Models Except Cisco 860VAE Series

Table A-1 lists the system specifications for all models except the Cisco 860VAE series routers.

**Table A-1 Router Specifications**

Description	Design Specification (all models except Cisco 860VAE series)
<b>Physical Dimensions</b>	
Dimensions with antenna and rubber feet (H x W x D)	1.9 x 12.8 x 10.4 in.
Weight (not including desktop power supply)	5.5 lb (2.5 kg), maximum
<b>Environmental Operating Ranges</b>	
Nonoperating temperature	−4 to 149°F (−20 to 65°C)
Nonoperating humidity	5 to 95% relative humidity
Nonoperating altitude	0 to 15,000 ft (4570 m)
Operating temperature	32 to 104°F (0 to 40°C)
Operating humidity	10 to 85% relative humidity
Operating altitude	0 to 10,000 ft (3000 m)
<b>Acoustic</b>	
Acoustic: Sound Pressure (Typical/Maximum) for single fan units	Low speed 31.4 dBA High speed 44.1 dBA
Acoustic: Sound Power (Typical/Maximum) for dual fan units	Low speed 38.9 dBA High speed 51.7 dBA
<b>Router Power Adapter</b>	
Input voltage	100 to 240 VAC Nominal
Input frequency	47 to 63 Hz
Power output	60 W, maximum
Output voltages	+12 VDC
<b>Inline Power-over-Ethernet Adapter</b>	
Input voltage	85 to 264 VAC
Input frequency	47 to 63 Hz
Power output	80 W, maximum
Output voltage	−48 VDC

## Cisco 860VAE Series

Table A-2 lists the system specifications for the Cisco 860VAE series routers.

**Table A-2 Router Specifications**

Description	Design Specification Cisco 860VAE series
<b>Physical Dimensions</b>	
Dimensions with antenna and rubber feet (H x W x D)	1.75 x 9.5 x 9 in.
Weight (not including desktop power supply)	3 lb (1.4 kg) The total weight depends on customer-selected options.
<b>Environmental Operating Ranges</b>	
Nonoperating temperature	-4 to 149°F (-20 to 65°C)
Nonoperating humidity	5 to 95% relative humidity
Nonoperating altitude	0 to 15,000 ft (4570 m)
Operating temperature	32 to 104°F (0 to 40°C)
Operating humidity	10 to 85% relative humidity
Operating altitude	0 to 10,000 ft (3000 m)
<b>Acoustic</b>	
Acoustic: Sound Pressure (Typical/Maximum) for single fan units	N/A, no fan
Acoustic: Sound Power (Typical/Maximum) for dual fan units	N/A, no fan
<b>Router Power Adapter</b>	
Input voltage	100 to 240 VAC Nominal
Input frequency	47 to 63 Hz
Power output	30 W, maximum
Output voltages	+12 VDC
<b>Inline Power-over-Ethernet Adapter</b>	
Input voltage	not supported
Input frequency	
Power output	
Output voltage	
<b>AC Adapter for Cisco 867VAE</b>	
AC Adapter	PWR-30W-AC
<b>Environmental Operating Ranges</b>	
Nonoperating temperature	-40 to 85°C
Nonoperating humidity	10% to 95%, non condensing

**Table A-2 Router Specifications (continued)**

Description	Design Specification Cisco 860VAE series
Operating temperature	-5 to 45° C
Operating humidity	10% to 90%, non condensing

## Cisco 860VAE-W-A-K9, Cisco 860VAE-W-E-K9, and Cisco 860VAE-POE-W-A-K9 Series

Table A-3 lists the system specifications for the Cisco 860VAE-W-A-K9, Cisco 860VAE-W-E-K9, and Cisco 860VAE-POE-W-A-K9 series routers.

**Table A-3 Technical Specifications**

Description	Specification
<b>Physical Dimensions</b>	
Enclosure	9.5 x 9 x 1.75 in. (W x D x H)
<b>Storage Environment</b>	
Temperature	-25 C to +70 C
Altitude	4570 m (15000 ft)
Humidity	5–95% Relative Humidity
<b>Operating Environment</b>	
Temperature	0 C to +40 C
Altitude	3000 m (10000 ft)
Humidity	10–85% Relative Humidity
Maximum temperature of enclosure surface	No higher than 70 C when the ambient temperature is 40 C
<b>Acoustic</b>	
Sound Pressure	N/A—Convection cooled, no fan
<b>Power Supply</b>	
External power supply	C866VAE-W-E-K9, C867VAE-W-A-K9, C867VAE-W-E-K9 models: Input: 100–240 VAC, Frequency range 50–60 Hz Output: 12 VDC, 2.5 A, 30 W C867VAE-POE-W-A-K9 model: Input: 100–240 VAC, Frequency range 50–60 Hz Output: 12 VDC, 5 A, 60 W
<b>Inline Power-over-Ethernet (PoE): C867VAE-POE-W-A-K9 Model Only</b>	
	IEEE 802.3af compliant



**Table A-3** *Technical Specifications*

Description	Specification
<b>Wireless LAN</b>	
Radio technology	IEEE 802.11n draft 2.0 standard compliant. Backward compatible with 802.11b/g.
Operating Frequency	2.4 GHz radio band
Bandwidth	20 MHz
Channels	Country-specific: America SKU(-W-A): Channels 1–11 Europe SKU(-W-E): Channels 1–13

## Power Supply

Table A-4 lists the maximum input values for the power supply used with the Cisco 860, 880, 890 series ISRs.

**Table A-4** *Maximum Input Values for the power supply used with Cisco 860, 880, 890 series ISRs*

Power Supply Unit	100 Volt	240 Volt
30 W	1 Ampere	0.5 Ampere
60 W	1.5 Ampere	0.7 Ampere

## Wireless Access Point

Table A-5 lists the specifications for the wireless access point (AP).

**Table A-5** *Wireless Access Point Specifications*

Description	Design Specification
Radio technology	IEEE 802.11n draft 2.0 standard compliant. 2x3 MIMO <sup>1</sup> radio. Backward compatible with 802.11b/g and 802.11a (Cisco 890 series routers).
Operating frequency	<b>Cisco 860 series and 880 series ISRs</b> 2.4-GHz radio band <b>Cisco 890 series ISRs</b> 2.4 and 5-GH radio bands
Channels	Country-specific 20 and 40 MHz
PHY Data rate	802.11b up to 11 Mb/s 802.11g up to 54 Mb/s 802.11n up to 300 Mb/s

1. MIMO = Multiple Input/Multiple Output.

## FE and GE Port Pinouts

Table A-6 describes the RJ-45 connector pinouts for Fast Ethernet (FE) ports with Power over Ethernet (PoE). Some models support PoE using an optional module, and some models do not support PoE. For ports that do not support PoE, pins 4, 5, 7, and 8 are not connected.

- Cisco 860VAE and 860VAE-K9 ISRs do not support PoE.
- Cisco 880 series ISRs can include an optional PoE module that provides power to 802.3af-compliant devices connected to FE ports 0 and 1.
- Cisco 890 series ISRs can include an optional PoE module that provides power to 802.3af-compliant devices connected to FE ports 0, 1, 2, and 3.

**Table A-6 Ethernet FE LAN Port Pinouts**

Pin	Function
1	RX+ <sup>1</sup>
2	RX-
3	TX+ <sup>2</sup>
4	PoE—optional
5	PoE—optional
6	TX-
7	PoE—optional
8	PoE—optional

1. RX = Receive

2. TX = Transmit

Table A-7 describes the RJ-45 connector pinouts for the Gigabit Ethernet (GE) ports of the Cisco 860VAE and 860VAE-K9 ISRs.

**Table A-7 Ethernet GE Port Pinouts**

Pin	GE Signal (LAN and WAN)
1	Tx A+ <sup>1</sup>
2	Tx A-
3	Rx B+ <sup>2</sup>
4	Tx C+
5	Tx C-
6	Rx B-
7	Rx D+
8	Rx D-

1. TX = Transmit

2. RX = Receive

## Console and Auxiliary Port Connector Pinouts

Table A-8 lists the pinouts for the console and auxiliary port connectors.

**Table A-8** Console and Auxiliary Port Connector Pinouts

RJ-45 Pin	Function
1	RTS
2	DTR
3	TXD
4	GND
5	GND
6	RXD
7	DSR
8	CTS

## FXS and FXO Port Connector Pinouts

Table A-9 lists the FXS and FXO connector pinouts.

**Table A-9** FXS and FXO Connector Pinouts (RJ-11-to-RJ-45)

Pin	Signal
1	NC
2	NC
3	TIP
4	RING
5	NC
6	NC

## VDSL2 Port Connector Pinouts

Table A-10 lists the VDSL2 connector pinouts.

**Table A-10** VDSL2 Connector Pinouts (RJ-11-to-RJ-45)

RJ-11 Pin	Function
1	Unused
2	Unused
3	TIP
4	RING

**Table A-10** VDSL2 Connector Pinouts (RJ-11-to-RJ-45) (continued)

RJ-11 Pin	Function
5	Unused
6	Unused

## ADSL2+ Port Connector Pinouts

Table A-11 lists the ADSL2+ connector pinouts.

**Table A-11** ADSL2+ Connector Pinouts (RJ-11)

RJ-11 Pin	Function
1	Unused
2	Unused
3	TIP
4	RING
5	Unused
6	Unused

## V.92 Port Connector Pinouts

Table A-12 lists the V.92 connector pinouts.

**Table A-12** V.92 Connector Pinouts (RJ-11-to-RJ-45)

RJ-11 Pin	Function
1	Unused
2	Unused
3	TIP
4	RING
5	Unused
6	Unused

## G.SHDSL Port Connector Pinouts

Table A-13 lists the pinouts for the symmetrical high-speed DSL (G.SHDSL) WAN port for two-pair products, including the following router model(s):

- C888

**Table A-13** *G.SHDSL WAN Port Pinouts for Two-Pair Products*

Pin	Function
1	Unused
2	TIP (Port1)
3	TIP (Port0)
4	RING (Port0)
5	RING (Port1)
6	Unused

Table A-14 lists the pinouts for the symmetrical high-speed DSL (G..SHDSL) WAN port for four-pair products, including the following router models:

- C888E
- C888EW
- C888EA

**Table A-14** *G.SHDSL WAN Port Pinouts for Four-Pair Products*

Pin	Function
1	TIP (Port1)
2	RING (Port1)
3	TIP (Port2)
4	TIP (Port0)
5	RING (Port0)
6	RING (Port2)
7	TIP (Port3)
8	RING (Port3)

## Data BRI Port Connector Pinouts

Table A-15 lists the pinouts for the Data BRI port.

**Table A-15** *Data BRI Port Pinouts*

Pin	Function
1	Unused
2	Unused
3	TXP
4	RXP
5	TXN
6	TXN

**Table A-15** Data BRI Port Pinouts (continued)

Pin	Function
7	Unused
8	Unused

## Voice ISDN BRI Interface Pin Numbers and Functions

Table A-16 lists the interface pin numbers and functions for the voice ISDN BRI port.

**Table A-16** Interface Pin Numbers and Functions

ISDN BRI NT/TE Card	NT Interface <sup>1</sup>	TE Interface <sup>2</sup>
Pin 3/T+	Pin 3/R+	Pin 3/T+
Pin 4/R+	Pin 4/T+	Pin 4/R+
Pin 5/R-	Pin 5/T-	Pin 5/R-
Pin 6/T-	Pin 6/R-	Pin 6/T-

1. Use a straight-through cable for NT interfaces.
2. Use a crossover cable for TE interfaces.

## SFP Port Connector Pinouts

Table A-17 lists the pinouts for the SFP port.

**Table A-17** SFP Port Pinouts

Pin	Function
1	TX Ground
2	TX Fault
3	TX disable
4	Module definition 2
5	Module definition 1
6	Module definition 0
7	Rate Select
8	Loss of signal
9	Receiver ground
10	Receiver ground
11	Receiver ground
12	Inverted received data out
13	Received data out
14	Receiver ground

**Table A-17** SFP Port Pinouts (continued)

Pin	Function
15	Receiver power
16	Transmitter power
17	Transmitter ground
18	Transmit data in
19	Inverted transmit data in
20	Transmitter ground

## Cable Specifications

This section provides specifications for the following Ethernet cables:

- Straight-through cable
- Crossover cable

Because of the autocrossover (autosensing) function, both straight-through and crossover cables can be used for the Ethernet LAN port.

## Ethernet Cable Specifications

[Table A-18](#) lists the specifications that apply to both straight-through and crossover Ethernet cables.

**Table A-18** Ethernet Cable Specifications

Type	Category
10BASE-T	Category 3 or 5
100BASE-T	Category 5 or higher
1000BASE-T	Category 5 or higher

## Maximum Cable Length

The maximum length for the Ethernet cables that connect equipment to the router is 328 feet (100 meters). This length is also the maximum distance between the router and the equipment connected to it.





## Free Manuals Download Website

<http://myh66.com>

<http://usermanuals.us>

<http://www.somanuals.com>

<http://www.4manuals.cc>

<http://www.manual-lib.com>

<http://www.404manual.com>

<http://www.luxmanual.com>

<http://aubethermostatmanual.com>

Golf course search by state

<http://golfingnear.com>

Email search by domain

<http://emailbydomain.com>

Auto manuals search

<http://auto.somanuals.com>

TV manuals search

<http://tv.somanuals.com>