



Cisco Aironet Four-Element, MIMO, Dual-Band Ceiling Mount Omnidirectional Antenna (AIR-ANT2524V4C-R)

This document outlines the specifications, describes the AIR-ANT2524V4C-R antenna, and provides instructions for mounting it. The antenna is a four-element, MIMO, dual-band antenna that operates in the 2.4- and 5-GHz frequency ranges. The antenna is designed to be ceiling-mounted in an indoor environment.

The following information is provided in this document.

- [Technical Specifications, page 2](#)
- [System Requirements, page 5](#)
- [Safety Instructions, page 5](#)
- [Installation Notes, page 5](#)
- [Choosing a Mounting Location, page 6](#)
- [Installing the Antenna, page 6](#)
- [Obtaining Documentation, Obtaining Support, and Security Guidelines, page 8](#)



Americas Headquarters:
Cisco Systems, Inc., 170 West Tasman Drive, San Jose, CA 95134-1706 USA

© 2012 Cisco Systems, Inc. All rights reserved.

Technical Specifications

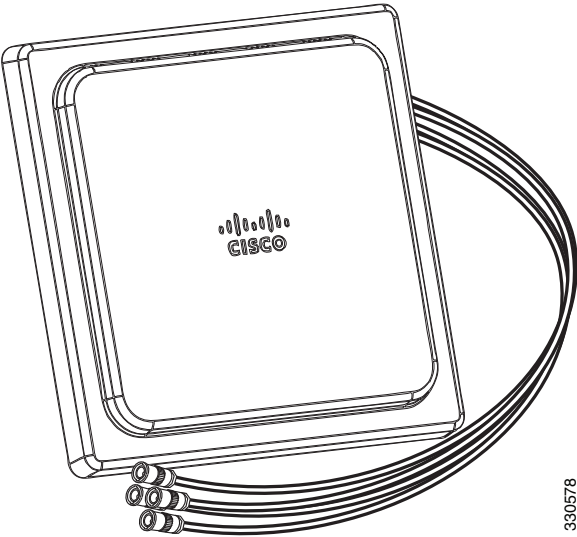
Antenna type	4-Element, Dual-band, Low Profile Omni	
Operating frequency ranges	2400–2484 MHz 5150–5850 MHz	
VSWR	2:1 or less in both bands	
Peak gain	2.4-GHz band: 2 dBi 5-GHz band: 4 dBi	
Polarization	Linear	
Azimuth plane 3 dB beamwidth	Omnidirectional	
Elevation plane 3 dB beamwidth	2.4-GHz band: 69° 5-GHz band: 60°	
Length	7.25 in (18.4 cm)	
Width	7.25 in (18.4 cm)	
Depth	1 in (2.5 cm)	
Weight	1.3 lb (0.59 kg)	
Cable	3 ft (91.4 cm) plenum rated, UV stable	
Connector	RP-TNC	
Environment	Indoor	
Temperature range	32°F to 133°F (0°C to 56°C)	

330578

2.4-GHz Element 1 Azimuth and Elevation Plane Patterns

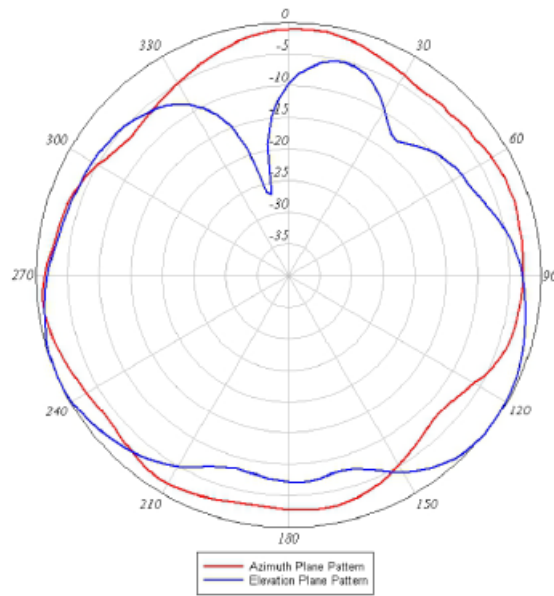

5-GHz Element 1 Azimuth and Elevation Plane Patterns

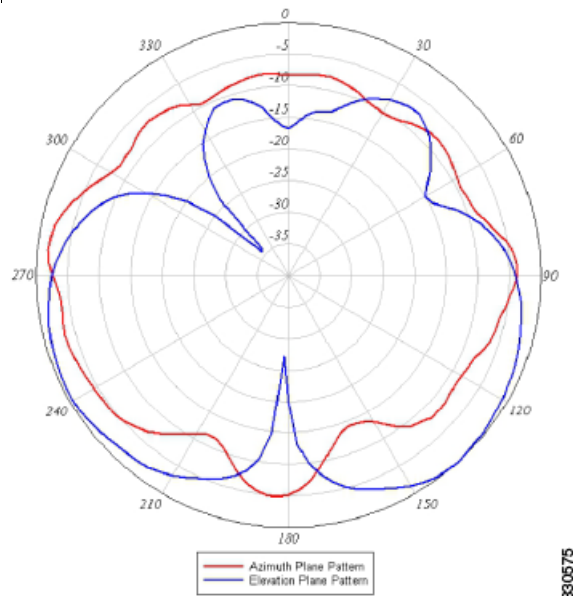

330576

330575

2.4-GHz Element 2 Azimuth and Elevation Plane Patterns

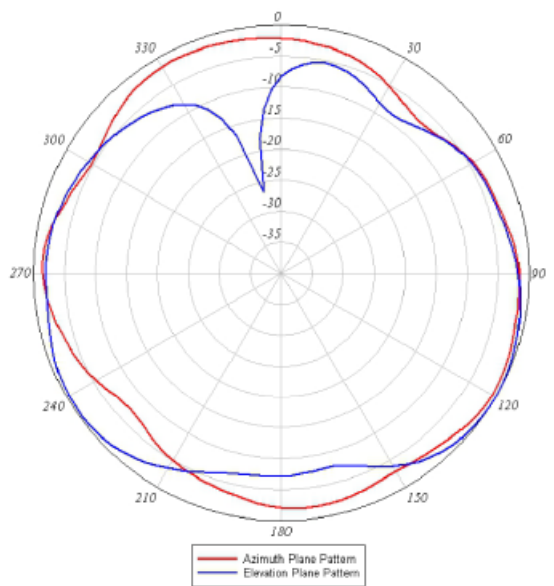

5-GHz Element 2 Azimuth and Elevation Plane Patterns

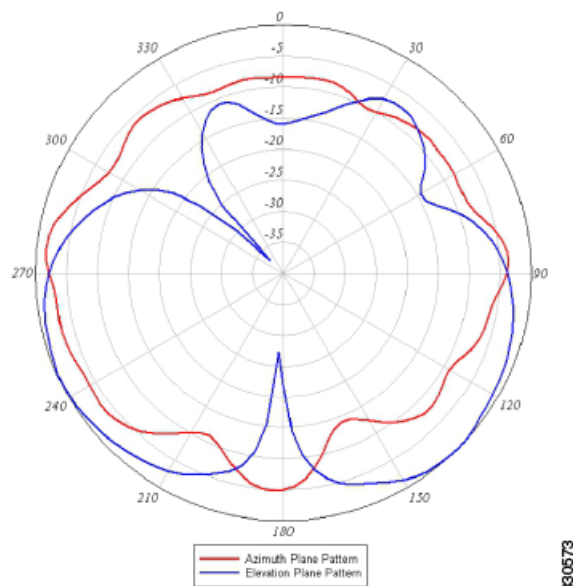

330574

330573

2.4-GHz Element 3 Azimuth and Elevation Plane Patterns

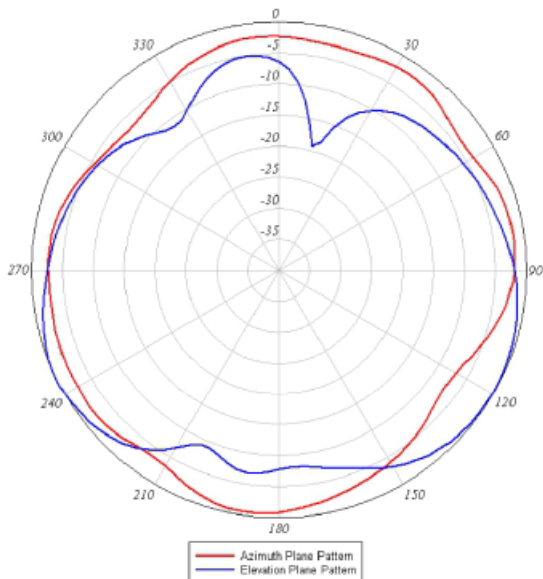

5-GHz Element 3 Azimuth and Elevation Plane Patterns

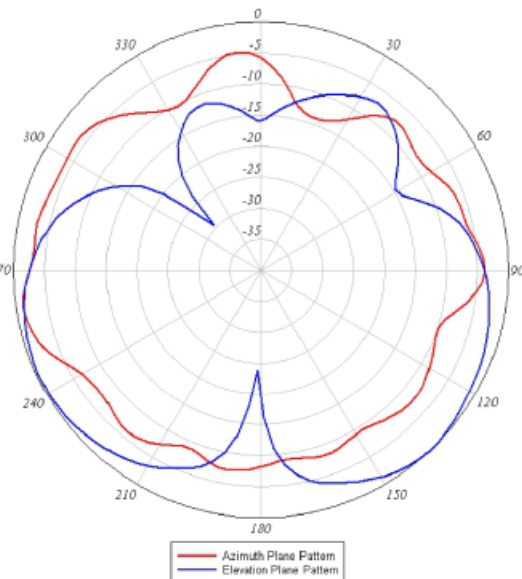

330572

330575

2.4-GHz Element 4 Azimuth and Elevation Plane Patterns

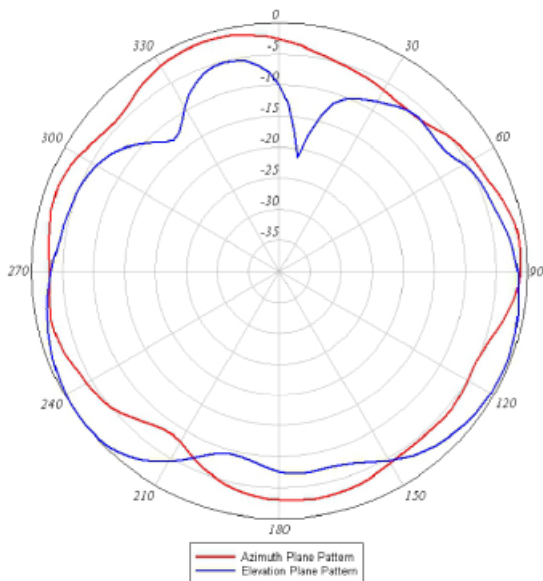

5-GHz Element 4 Azimuth and Elevation Plane Patterns

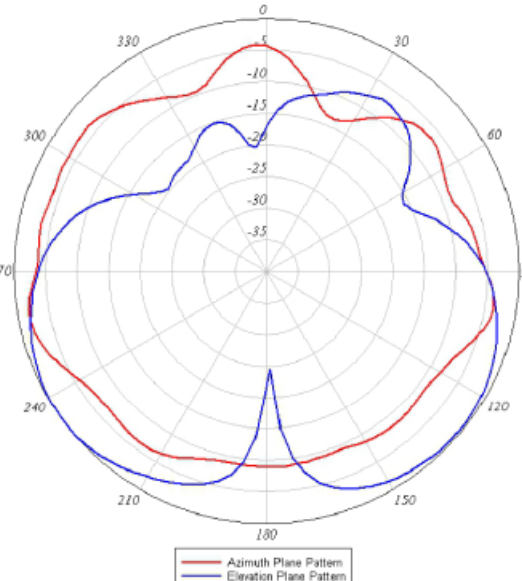

330570

330577

System Requirements

This antenna is designed for indoor use with any Cisco Aironet radio device with dual-band (2.4- and 5-GHz) RP-TNC antenna ports. The antenna can be mounted on suspended ceiling tiles having a thickness between ½ in. (1.27-cm) and 1 in. (2.54-cm).

Safety Instructions

Follow these safety instructions when installing your antenna.

- Plan your installation procedure carefully and completely before you begin.
- If you are installing an antenna for the first time, for your own safety as well as others, seek professional assistance. Consult your dealer, who can explain which mounting method to use for the location where you intend to install the antenna.
- Select your installation site with safety, as well as performance, in mind. Remember that electric power cables and telephone lines look alike. For your safety, assume that any line is an electric power line until determined otherwise.
- Call your local power company or building maintenance organization if you are unsure about cables close to your mounting location.
- When installing your antenna, do not use a metal ladder. Do dress properly: shoes with rubber soles and heels, rubber gloves, and a long sleeved shirt or jacket.
- If an accident or emergency occurs with the power lines, call for qualified emergency help immediately.

Installation Notes

Because antennas transmit and receive radio signals, they are susceptible to RF obstructions and common sources of interference that can reduce throughput and range of the device to which they are connected. Follow these guidelines to ensure the best possible performance:

- Mount the antenna to utilize its propagation characteristics. A way to do this is to orient the antenna horizontally as high as possible at or near the center of its coverage area.
- Keep the antenna away from metal obstructions such as heating and air-conditioning ducts, large ceiling trusses, building superstructures, and major power cabling runs. If necessary, use a rigid conduit to lower the antenna away from these obstructions.
- The density of the materials used in a building's construction determines the number of walls the signal must pass through and still maintain adequate coverage. Consider the following before choosing the location to install your antenna:
 - Paper and vinyl walls have very little affect on signal penetration.
 - Solid and pre-cast concrete walls limit signal penetration to one or two walls without degrading coverage.
 - Concrete and wood block walls limit signal penetration to three or four walls.
 - A signal can penetrate five or six walls constructed of drywall or wood.
 - A thick metal wall causes signals to reflect off, causing poor penetration.

- A wire mesh spaced between 1 and 1 1/2 in. (2.54- and 3.81-cm) acts as a harmonic reflector that blocks a 2.4-GHz radio signal.
- Install the antenna away from microwave ovens and 2-GHz cordless phones. These products can cause signal interference because they operate in the same frequency range as the device to which your antenna is connected.
- Install the antenna horizontally to maximize signal propagation.

Choosing a Mounting Location

The antenna should be mounted clear of any obstructions to the sides of the radiating elements. Generally, the higher an antenna is above the floor, the better it performs. If possible, mount the antenna on the ceiling panel within 12 in. (30.5-cm) of the access point so you can connect its cables directly to the access point. If you must mount the antenna farther away from the access point, try to make the distance as short as possible.

Installing the Antenna

You can install the antenna on a ceiling tile having a thickness between 1/2 in. (1.27-cm) and 1 in. (2.54-cm).

Tools and Equipment Required

You need the following tools and equipment, which are not provided.

- A suitable hole cutter capable of creating a 1-in. (2.54-cm) hole in a suspended ceiling tile.



Note We recommend a hole saw, which is available in most home improvement centers and hardware stores.

- A step ladder high enough to access your ceiling safely.

Installing the Antenna

The antenna is installed to a suspended ceiling tile with a supplied 1 in. (2.54-cm) plastic nut. See [Figure 1](#) for details.

The antenna cables terminate with a straight RP-TNC plug connector after a 36 in. (91.44-cm) cable. The mating connector to the antenna on the access point is an RP-TNC jack.

Mounting the Antenna on a Ceiling Tile

Figure 1 Ceiling Tile Mounting Details

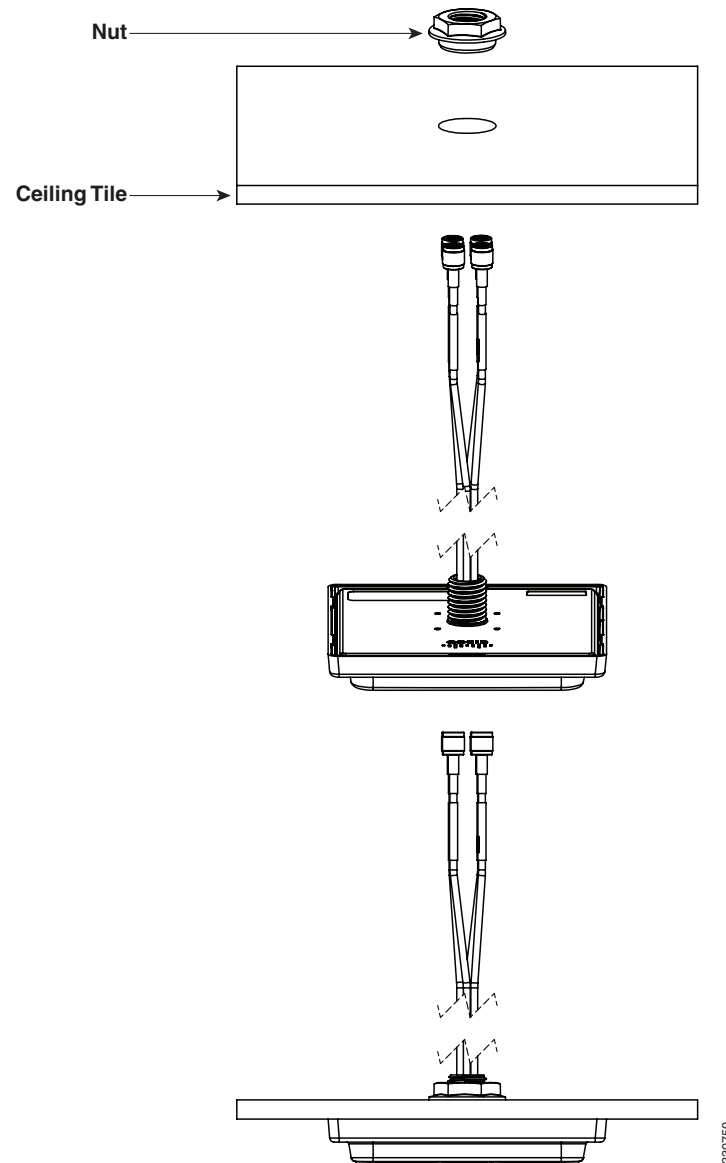

Follow these steps to mount the antenna on a suspended ceiling tile.

- Step 1** Mark the location on the ceiling tile where you will mount the antenna.
- Step 2** Remove the ceiling tile from the ceiling grids.
- Step 3** Use a 1-in. (2.54-cm) hole cutter to create a hole in the ceiling tile.
- Step 4** Insert the antenna cables, one at a time, through the hole in the ceiling tile.
- Step 5** Insert the antenna cables, one at a time, through the hole in the plastic nut as shown in [Figure 1](#).



Note Do not use the rubber gasket when you mount the antenna on a ceiling tile. The gasket is not required for ceiling tile installations.

- Step 6** Make sure that the antenna is properly positioned on the ceiling tile and then tighten the plastic nut hand-tight.
- Step 7** Reinstall the ceiling tile.
- Step 8** Connect the antenna cables to the access point.



Note The 5-GHz antenna cables are identified by an orange collar near the connectors. Make sure that you connect these cables to the 5-GHz antenna connection on the access point.

Suggested Cable

Cisco recommends a high-quality, low-loss cable for use with the antenna.



Note Coaxial cable loses efficiency as the frequency increases, resulting in signal loss. The cable should be kept as short as possible because cable length also determines the amount of signal loss (the longer the run, the greater the loss).

Obtaining Documentation, Obtaining Support, and Security Guidelines

For information on obtaining documentation, obtaining support, providing documentation feedback, security guidelines, and also recommended aliases and general Cisco documents, see the monthly *What's New in Cisco Product Documentation*, which also lists all new and revised Cisco technical documentation, at:

<http://www.cisco.com/en/US/docs/general/whatsnew/whatsnew.html>

CCDE, CCENT, Cisco Eos, Cisco StadiumVision, the Cisco logo, DCE, and Welcome to the Human Network are trademarks; Changing the Way We Work, Live, Play, and Learn is a service mark; and Access Registrar, Aironet, AsyncOS, Bringing the Meeting To You, Catalyst, CCDA, CCDP, CCIE, CCIP, CCNA, CCNP, CCSP, CCVP, Cisco, the Cisco Certified Internetwork Expert logo, Cisco IOS, Cisco Press, Cisco Systems, Cisco Systems Capital, the Cisco Systems logo, Cisco Unity, Collaboration Without Limitation, Enterprise/Solver, EtherChannel, EtherFast, EtherSwitch, Event Center, Fast Step, Follow Me Browsing, FormShare, GigaDrive, HomeLink, Internet Quotient, IOS, iPhone, iQ Expertise, the iQ logo, iQ Net Readiness Scorecard, iQuick Study, IronPort, the IronPort logo, LightStream, Linksys, MediaTone, MeetingPlace, MGX, Networkers, Networking Academy, Network Registrar, PCNow, PIX, PowerPanels, ProConnect, ScriptShare, SenderBase, SMARTnet, Spectrum Expert, StackWise, The Fastest Way to Increase Your Internet Quotient, TransPath, WebEx, and the WebEx logo are registered trademarks of Cisco Systems, Inc. and/or its affiliates in the United States and certain other countries.

All other trademarks mentioned in this document or Website are the property of their respective owners. The use of the word partner does not imply a partnership relationship between Cisco and any other company. (0803R)

Free Manuals Download Website

<http://myh66.com>

<http://usermanuals.us>

<http://www.somanuals.com>

<http://www.4manuals.cc>

<http://www.manual-lib.com>

<http://www.404manual.com>

<http://www.luxmanual.com>

<http://aubethermostatmanual.com>

Golf course search by state

<http://golfingnear.com>

Email search by domain

<http://emailbydomain.com>

Auto manuals search

<http://auto.somanuals.com>

TV manuals search

<http://tv.somanuals.com>