



# **Cisco ASR 901 Series Aggregation Services Router Software Configuration Guide**

November 21, 2013

## **Americas Headquarters**

Cisco Systems, Inc.  
170 West Tasman Drive  
San Jose, CA 95134-1706  
USA  
<http://www.cisco.com>  
Tel: 408 526-4000  
800 553-NETS (6387)  
Fax: 408 527-0883

Text Part Number: OL-23826-09

THE SPECIFICATIONS AND INFORMATION REGARDING THE PRODUCTS IN THIS MANUAL ARE SUBJECT TO CHANGE WITHOUT NOTICE. ALL STATEMENTS, INFORMATION, AND RECOMMENDATIONS IN THIS MANUAL ARE BELIEVED TO BE ACCURATE BUT ARE PRESENTED WITHOUT WARRANTY OF ANY KIND, EXPRESS OR IMPLIED. USERS MUST TAKE FULL RESPONSIBILITY FOR THEIR APPLICATION OF ANY PRODUCTS.

THE SOFTWARE LICENSE AND LIMITED WARRANTY FOR THE ACCOMPANYING PRODUCT ARE SET FORTH IN THE INFORMATION PACKET THAT SHIPPED WITH THE PRODUCT AND ARE INCORPORATED HEREIN BY THIS REFERENCE. IF YOU ARE UNABLE TO LOCATE THE SOFTWARE LICENSE OR LIMITED WARRANTY, CONTACT YOUR CISCO REPRESENTATIVE FOR A COPY.

The following information is for FCC compliance of Class A devices: This equipment has been tested and found to comply with the limits for a Class A digital device, pursuant to part 15 of the FCC rules. These limits are designed to provide reasonable protection against harmful interference when the equipment is operated in a commercial environment. This equipment generates, uses, and can radiate radio-frequency energy and, if not installed and used in accordance with the instruction manual, may cause harmful interference to radio communications. Operation of this equipment in a residential area is likely to cause harmful interference, in which case users will be required to correct the interference at their own expense.

The following information is for FCC compliance of Class B devices: The equipment described in this manual generates and may radiate radio-frequency energy. If it is not installed in accordance with Cisco installation instructions, it may cause interference with radio and television reception. This equipment has been tested and found to comply with the limits for a Class B digital device in accordance with the specifications in part 15 of the FCC rules. These specifications are designed to provide reasonable protection against such interference in a residential installation. However, there is no guarantee that interference will not occur in a particular installation.

Modifying the equipment without Cisco written authorization may result in the equipment no longer complying with FCC requirements for Class A or Class B digital devices. In that event, your right to use the equipment may be limited by FCC regulations, and you may be required to correct any interference to radio or television communications at your own expense.

You can determine whether your equipment is causing interference by turning it off. If the interference stops, it was probably caused by the Cisco equipment or one of its peripheral devices. If the equipment causes interference to radio or television reception, try to correct the interference by using one or more of the following measures:

- Turn the television or radio antenna until the interference stops.
- Move the equipment to one side or the other of the television or radio.
- Move the equipment farther away from the television or radio.
- Plug the equipment into an outlet that is on a different circuit from the television or radio. (That is, make certain the equipment and the television or radio are on circuits controlled by different circuit breakers or fuses.)

Modifications to this product not authorized by Cisco Systems, Inc. could void the FCC approval and negate your authority to operate the product.

The Cisco implementation of TCP header compression is an adaptation of a program developed by the University of California, Berkeley (UCB) as part of UCB's public domain version of the UNIX operating system. All rights reserved. Copyright © 1981, Regents of the University of California.

NOTWITHSTANDING ANY OTHER WARRANTY HEREIN, ALL DOCUMENT FILES AND SOFTWARE OF THESE SUPPLIERS ARE PROVIDED "AS IS" WITH ALL FAULTS. CISCO AND THE ABOVE-NAMED SUPPLIERS DISCLAIM ALL WARRANTIES, EXPRESSED OR IMPLIED, INCLUDING, WITHOUT LIMITATION, THOSE OF MERCHANTABILITY, FITNESS FOR A PARTICULAR PURPOSE AND NONINFRINGEMENT OR ARISING FROM A COURSE OF DEALING, USAGE, OR TRADE PRACTICE.

IN NO EVENT SHALL CISCO OR ITS SUPPLIERS BE LIABLE FOR ANY INDIRECT, SPECIAL, CONSEQUENTIAL, OR INCIDENTAL DAMAGES, INCLUDING, WITHOUT LIMITATION, LOST PROFITS OR LOSS OR DAMAGE TO DATA ARISING OUT OF THE USE OR INABILITY TO USE THIS MANUAL, EVEN IF CISCO OR ITS SUPPLIERS HAVE BEEN ADVISED OF THE POSSIBILITY OF SUCH DAMAGES.

Cisco and the Cisco logo are trademarks or registered trademarks of Cisco and/or its affiliates in the U.S. and other countries. To view a list of Cisco trademarks, go to this URL: [www.cisco.com/go/trademarks](http://www.cisco.com/go/trademarks). Third-party trademarks mentioned are the property of their respective owners. The use of the word partner does not imply a partnership relationship between Cisco and any other company. (1110R)

*Cisco ASR 901 Series Aggregation Services Router Software Configuration Guide*

Copyright © 2011-2013, Cisco Systems, Inc.

All rights reserved. Printed in USA



Document Revision History	xxxvii
Objectives	xlvii
Audience	xlvii
Organization	xlvii
Conventions	i
Related Documentation	ii
Obtaining Documentation, Obtaining Support, and Security Guidelines	ii

---

**CHAPTER 1**

<b>Cisco ASR 901 Router Overview</b>	<b>1-1</b>
Introduction	1-2
Features	1-2
Performance Features	1-2
Management Options	1-3
Manageability Features	1-3
Security Features	1-4
Quality of Service and Class of Service Features	1-4
Layer 3 Features	1-5
Layer 3 VPN Services	1-5
Monitoring Features	1-5

---

**CHAPTER 2**

<b>Licensing</b>	<b>2-1</b>
Finding Feature Information	2-1
Contents	2-1
Feature Overview	2-2
Licenses Supported on Cisco ASR 901 Router	2-2
License Types	2-4
Image Level License	2-4
Features Supported	2-4
Feature Based License	2-4
Port Based/Mode License	2-5
1588BC License	2-5
Port or Interface Behavior	2-5
Port Based License	2-6

- Example: When Port Based License is not Installed 2-6
- Example: When Port Based License is Installed 2-6
- 10gigUpgrade License 2-7
  - Example: When 10gigUpgrade License is not Installed 2-7
  - Example: When 10gigUpgrade License is Installed 2-8
- Flexi License 2-8
  - Example: When Flexi License is not Installed 2-8
  - Example: When Flexi License is Installed 2-9
- 1588BC License 2-9
  - Example: When 1588BC License is not Installed 2-9
  - Example: When 1588BC License is Installed 2-9
  - Removing the 1588BC License 2-10
- Generating the License 2-11
- Installing the License 2-11
- Changing the License 2-12
- Return Materials Authorization License Process 2-13
  - Example: RMA Process 2-13
- Verifying the License 2-14
- Where to Go Next 2-14
- Additional References 2-15
  - Related Documents 2-15
  - Standards 2-15
  - MIBs 2-15
  - RFCs 2-15
  - Technical Assistance 2-16
- Feature Information for Licensing 2-17

**CHAPTER 3**

**First-Time Configuration 3-1**

- Contents 3-1
- Setup Mode 3-1
  - Before Starting Your Router 3-1
  - Using Setup Mode 3-2
    - Configuring Global Parameters 3-2
    - Completing the Configuration 3-4
- Verifying the Cisco IOS Software Version 3-5
- Configuring the Hostname and Password 3-5
  - Verifying the Hostname and Password 3-6

**CHAPTER 4****Managing and Monitoring Network Management Features 4-1**

Finding Feature Information	4-1
Contents	4-1
Network Management Features for the ASR 901	4-2
Cisco Active Network Abstraction (ANA)	4-2
SNMP MIB Support	4-2
Cisco Networking Services (CNS)	4-2
How to Configure Network Management Features on ASR 901	4-2
Configuring SNMP Support	4-3
Configuring Remote Network Management	4-8
Enabling Cisco Networking Services (CNS) and Zero-Touch Deployment	4-10
Zero-Touch Deployment	4-10
Image Download	4-11
Configuring a DHCP Server	4-12
Configuring a TFTP Server	4-13
Creating a Bootstrap Configuration	4-13
Enabling a TFTP Server on the Edge Router	4-14
Configuring the Cisco Configuration Engine	4-14
Configuration Examples	4-15
Example: Configuring SNMP Support	4-15
Example: Configuring Remote Network Management	4-15
Example: Configuring a DHCP Server	4-15
Example: Zero-touch Deployment	4-16
Where to Go Next	4-16
Additional References	4-16
Related Documents	4-16
Standards	4-16
MIBs	4-17
RFCs	4-17
Technical Assistance	4-17
Feature Information for Monitoring and Managing the ASR 901 Router	4-18

**CHAPTER 5****Using the Command-Line Interface 5-1**

Contents	5-1
Understanding Command Modes	5-1
Understanding the Help System	5-3
Understanding Abbreviated Commands	5-4
Understanding no and default Forms of Commands	5-4

- Understanding CLI Error Messages 5-4
- Using Command History 5-5
  - Changing the Command History Buffer Size 5-5
  - Recalling Commands 5-6
  - Disabling the Command History Feature 5-6
- Using Editing Features 5-6
  - Enabling and Disabling Editing Features 5-6
  - Editing Commands through Keystrokes 5-7
  - Editing Command Lines that Wrap 5-8
- Searching and Filtering Output of show and more Commands 5-9
- Accessing the CLI 5-9
  - Accessing the CLI through a Console Connection or through Telnet 5-9
- Saving Configuration Changes 5-10

**CHAPTER 6**

**Software Upgrade 6-1**

- Contents 6-1
- Selecting a Cisco IOS Image 6-1
- Upgrading the Cisco IOS image 6-1
- Auto Upgrading the MCU 6-4
- Manually Upgrading the ROMMON 6-5
- Auto Upgrade of ROMMON 6-6

**CHAPTER 7**

**Configuring Gigabit Ethernet Interfaces 7-1**

- Contents 7-1
- Configuring the Interface 7-1
- Setting the Speed and Duplex Mode 7-2
- Enabling the Interface 7-3
- Modifying MTU Size on the Interface 7-3
  - Verifying the MTU Size 7-4
- MAC Flap Control 7-5
  - Configuring MAC FLap Control 7-5
- Configuring a Combo Port 7-6
  - Restrictions 7-6
  - Verifying the Media Type 7-8

**CHAPTER 8**

**Configuring Ethernet Virtual Connections 8-1**

- Finding Feature Information 8-1

Contents	8-1
Supported EVC Features	8-2
Understanding EVC Features	8-3
Ethernet Virtual Connections	8-3
Service Instances and EFPs	8-3
Encapsulation	8-4
Bridge Domains	8-5
DHCP Client on Switch Virtual Interface	8-6
Split-Horizon	8-6
Rewrite Operations	8-6
Configuring EFPs	8-7
Default EVC Configuration	8-7
Configuration Guidelines	8-7
Creating Service Instances	8-8
Configuration Examples of Supported Features	8-10
Example: Configuring a Service Instance	8-10
Example: Encapsulation Using a VLAN Range	8-10
Example: Two Service Instances Joining the Same Bridge Domain	8-10
Example: Bridge Domains and VLAN Encapsulation	8-10
Example: Rewrite	8-11
Example: Split Horizon	8-11
Configuration Examples of Unsupported Features	8-12
Example: Filtering	8-12
Example: Overlapping Encapsulation	8-12
How to Configure EVC Default Encapsulation	8-13
Configuring EVC Default Encapsulation with Bridge-Domain	8-13
Configuring EVC Default Encapsulation with Xconnect	8-14
Verifying EVC Default Encapsulation with Bridge-Domain	8-15
Verifying EVC Default Encapsulation with Xconnect	8-16
Configuration Examples for EVC Default Encapsulation	8-16
Example: Configuring EVC Default Encapsulation with Bridge-Domain	8-16
Example: Configuring EVC Default Encapsulation with Xconnect	8-16
Configuring Other Features on EFPs	8-16
EFPs and EtherChannels	8-17
MAC Address Forwarding, Learning and Aging on EFPs	8-17
Disabling MAC Address Learning on an Interface or Bridge Domain	8-18
Configuring IEEE 802.1Q Tunneling using EFPs	8-20
802.1Q Tunneling (QinQ)	8-20
Restrictions	8-22

- Configuration Examples 8-22
- Routed QinQ 8-23
  - Restrictions 8-23
  - Configuration Example 8-23
- Bridge Domain Routing 8-24
  - Restrictions 8-24
  - Example: Configuring Bridge-Domain Routing 8-24
- How to Configure DHCP Client on SVI 8-25
  - Configuring DHCP Client on SVI 8-25
  - Verifying DHCP Client on SVI 8-26
  - Configuration Example for DHCP Client on SVI 8-26
- EFPs and Switchport MAC Addresses 8-27
- EFPs and MSTP 8-27
- Monitoring EVC 8-28
- Sample Configuration with Switchport to EVC Mapping 8-29
  - Configuration Example 8-30
- Additional References 8-32
  - Related Documents 8-32
  - Standards 8-32
  - MIBs 8-32
  - RFCs 8-32
  - Technical Assistance 8-32
- Feature Information for Configuring Ethernet Virtual Connections 8-33

**CHAPTER 9**

**Configuring EtherChannels 9-1**

- Contents 9-1
- Understanding How EtherChannels Work 9-1
  - EtherChannel Feature Overview 9-1
  - Understanding How EtherChannels Are Configured 9-2
    - EtherChannel Configuration Overview 9-2
    - Understanding Manual EtherChannel Configuration 9-2
    - Understanding IEEE 802.3ad LACP EtherChannel Configuration 9-2
  - Understanding Port-Channel Interfaces 9-4
  - Understanding Load Balancing 9-4
- EtherChannel Configuration Guidelines and Restrictions 9-4
- Configuring Etherchannels 9-5
  - Configuring Channel Groups 9-5
  - Configuring the LACP System Priority and System ID 9-6
  - Configuring the LACP Transmit Rate 9-7



Verifying the LACP Transmit Rate	9-8
Configuring EtherChannel Load Balancing	9-8
Modifying MTU Size on Port-Channel	9-9
Restrictions	9-9
Verifying the MTU Size on Port-Channel	9-9
EVC On Port-Channel	9-10
Restrictions for EVC EtherChannel	9-10
Configuring EVC on Port-Channel	9-11
Verifying the Configuration	9-11
Troubleshooting	9-12

**CHAPTER 10****Configuring Ethernet OAM 10-1**

Contents	10-1
Understanding Ethernet CFM	10-2
IP SLA Support for CFM	10-2
Configuring Ethernet CFM	10-2
Default Ethernet CFM Configuration	10-3
Ethernet CFM Configuration Restrictions and Guidelines	10-3
Configuring the CFM Domain	10-3
Configuring Multi-UNI CFM MEPs in the Same VPN	10-7
Configuring Ethernet CFM Crosscheck	10-12
Configuring Static Remote MEP	10-13
Configuring a Port MEP	10-14
Configuring SNMP Traps	10-15
Configuring IP SLA CFM Operation	10-16
Manually Configuring an IP SLA CFM Probe or Jitter Operation	10-16
Configuring CFM over EFP with Cross Connect	10-19
Configuring CFM over EFP Interface with Cross Connect	10-20
Configuring CFM over EFP Interface with Cross Connect—Port Channel-Based Cross Connect Tunnel	10-22
Configuring CFM with EVC Default Encapsulation	10-24
Verifying CFM with EVC Default Encapsulation	10-25
Example: Configuring CFM with EVC Default Encapsulation	10-26
Configuring Y.1731 Fault Management	10-26
Default Y.1731 Configuration	10-26
Configuring ETH-AIS	10-27
Configuring ETH-LCK	10-28
Managing and Displaying Ethernet CFM Information	10-30
Understanding the Ethernet OAM Protocol	10-32
OAM Features	10-33

- Setting Up and Configuring Ethernet OAM 10-35
  - Default Ethernet OAM Configuration 10-36
  - Restrictions and Guidelines 10-36
  - Enabling Ethernet OAM on an Interface 10-36
  - Enabling Ethernet OAM Remote Loopback 10-38
  - Configuring Ethernet OAM Link Monitoring 10-38
  - Configuring Ethernet OAM Remote Failure Indications 10-41
  - Configuring Ethernet OAM Templates 10-42
  - Displaying Ethernet OAM Protocol Information 10-45
  - Verifying Ethernet OAM Configuration 10-46
- Understanding E-LMI 10-48
  - Restrictions 10-49
  - Configuring E-LMI 10-49
    - Default E-LMI Configuration 10-49
    - Enabling E-LMI 10-50
  - Displaying E-LMI Information 10-51
- Understanding Ethernet Loopback 10-51
  - Configuring Ethernet Loopback 10-51
    - Restrictions 10-52
    - Enabling Ethernet Loopback 10-52
    - Configuration Example 10-54
  - Configuring Y.1564 to Generate Ethernet Traffic 10-56
    - Configuring IP SLA for Traffic Generation 10-58
    - Configuration Examples 10-60

**CHAPTER 11**

**ITU-T Y.1731 Performance Monitoring 11-1**

- Finding Feature Information 11-1
- Contents 11-1
- Prerequisites for ITU-T Y.1731 Performance Monitoring 11-1
- Restrictions for ITU-T Y.1731 Performance Monitoring 11-2
- Information About ITU-T Y.1731 Performance Monitoring 11-2
  - Frame Delay and Frame-Delay Variation 11-3
  - Frame Loss Ratio 11-4
  - On-Demand and Concurrent Operations 11-4
    - Supported interfaces 11-5
  - Benefits of ITU-T Y.1731 Performance Monitoring 11-5
- How to Configure ITU-T Y.1731 Performance Monitoring 11-5
  - Configuring Two-Way Delay Measurement 11-6
  - Configuring Single-Ended Synthetic Loss Measurement 11-9

Scheduling IP SLAs Operations	11-14
Prerequisites	11-14
Verifying the Frame Delay and Synthetic Loss Measurement Configurations	11-15
Example: Verifying Sender MEP for a Two-Way Delay Measurement Operation	11-16
Example: Verifying Receiver MEP for a Two-Way Delay Measurement Operation	11-16
Example: Verifying Sender MEP for a Synthetic Loss Measurement Operation	11-17
Example: Verifying Ethernet CFM Performance Monitoring	11-17
Example: Verifying History for IP SLAs Operations	11-18
How to Configure IP SLAs Y.1731 On-Demand and Concurrent Operations	11-19
Configuring Direct On-Demand Operation on a Sender MEP	11-19
Prerequisites	11-19
Configuring Referenced On-Demand Operation on a Sender MEP	11-20
Prerequisites	11-20
Configuring IP SLAs Y.1731 Concurrent Operation on a Sender MEP	11-21
Configuration Examples for IP SLAs Y.1731 On-Demand Operations	11-21
Example: On-Demand Operation in Direct Mode	11-21
Example: On-Demand Operation in Referenced Mode	11-22
Additional References	11-23
Related Documents	11-23
Standards	11-23
MIBs	11-23
RFCs	11-23
Technical Assistance	11-24
Feature Information for ITU-T Y.1731 Performance Monitoring	11-25

**CHAPTER 12****Configuring Resilient Ethernet Protocol 12-1**

Contents	12-1
Understanding Resilient Ethernet Protocol (REP)	12-1
Overview	12-1
Restrictions	12-3
Link Integrity	12-4
Fast Convergence	12-4
VLAN Load Balancing (VLB)	12-4
REP Ports	12-6
Configuring Resilient Ethernet Protocol (REP)	12-7
Default REP Configuration	12-7
REP Configuration Guidelines	12-7
Configuring the REP Administrative VLAN	12-9
SUMMARY STEPS	12-9

- DETAILED STEPS 12-9
  - Configuring REP Interfaces 12-10
    - SUMMARY STEPS 12-10
    - DETAILED STEPS 12-11
  - Configuring REP as Dual Edge No-Neighbor Port 12-15
    - SUMMARY STEPS 12-15
    - DETAILED STEPS 12-16
  - Cisco ASR 901 Dual Rep Edge No-Neighbor Topology Example 12-18
  - Setting up Manual Preemption for VLAN Load Balancing 12-20
    - SUMMARY STEPS 12-20
    - DETAILED STEPS 12-20
  - Configuring SNMP Traps for REP 12-21
    - SUMMARY STEPS 12-21
    - DETAILED STEPS 12-21
  - Monitoring REP 12-22
    - SUMMARY STEPS 12-22
    - DETAILED STEPS 12-23
- Configuration Examples for REP 12-24
  - Configuring the REP Administrative VLAN: Example 12-24
  - Configuring a REP Interface: Example 12-24
  - Setting up the Preemption for VLAN Load Balancing: Example 12-25
  - Configuring SNMP Traps for REP: Example 12-25
  - Monitoring the REP Configuration: Example 12-25
  - Cisco ASR 901 Topology Example 12-26

**CHAPTER 13**

**Configuring MST on EVC Bridge Domain 13-1**

- Contents 13-1
  - Overview of MST and STP 13-1
  - Overview of MST on EVC Bridge Domain 13-2
  - Restrictions and Guidelines 13-2
  - Configuring MST on EVC Bridge Domain 13-4
    - Configuration Example for MST on EVC Bridge Domain 13-6
    - Verification 13-6
    - Troubleshooting Tips 13-9

**CHAPTER 14**

**Configuring Multiprotocol Label Switching 14-1**

**CHAPTER 15**

**Configuring EoMPLS 15-1**

- Contents 15-1

Understanding EoMPLS	15-1
Restrictions	15-2
Configuring EoMPLS	15-2
EoMPLS Configuration Example	15-3
Configuring Pseudowire Redundancy	15-4
Configuration Commands	15-4
Port Based EoMPLS	15-5

**CHAPTER 16****Configuring MPLS VPNs 16-1**

Contents	16-1
Understanding MPLS VPNs	16-1
Configuring MPLS VPNs	16-2
Configuration Examples for MPLS VPN	16-2

**CHAPTER 17****Configuring MPLS OAM 17-1**

Contents	17-1
Understanding MPLS OAM	17-1
LSP Ping	17-1
LSP Traceroute	17-2
LSP Ping over Pseudowire	17-2
Configuring MPLS OAM	17-2
Using LSP Ping for LDP IPv4 FEC	17-3
Using LSP Traceroute for LDP IPv4 FEC	17-3
Using LSP Ping for Pseudowire	17-3
Using LSP Traceroute over Pseudowire	17-4
Displaying AToM VCCV capabilities	17-4
	17-4

**CHAPTER 18****Configuring Routing Protocols 18-1**

Changing Default Hashing Algorithm for ECMP	18-1
---	------

**CHAPTER 19****Configuring Bidirectional Forwarding Detection 19-1**

Contents	19-1
Understanding BFD	19-1
Configuring BFD	19-1
BFD Configuration Guidelines and Restrictions	19-2
Configuring BFD for OSPF	19-2
Configuring BFD for OSPF on One of More Interfaces	19-2

- Configuring BFD for OSPF on All Interfaces 19-3
- Configuring BFD for BGP 19-4
- Configuring BFD for IS-IS 19-4
  - Configuring BFD for IS-IS on a Single Interface 19-4
  - Configuring BFD for IS-IS for All Interfaces 19-5
- Configuring BFD for Static Routes 19-6
- Configuration Examples for BFD 19-7
  - BFD with OSPF on All Interfaces 19-7
  - BFD with OSPF on Individual Interfaces 19-7
  - BFD with BGP 19-8
  - BFD with IS-IS on All Interfaces 19-8
  - BFD with IS-IS on Individual Interfaces 19-8
  - BFD with Static Routes 19-9

**CHAPTER 20**

**Configuring T1/E1 Controllers 20-1**

- Contents 20-1
- Configuring the Card Type 20-1
- Configuring E1 Controllers 20-2
- Configuring T1 Controllers 20-4
- Troubleshooting Controllers 20-5
  - Troubleshooting E1 Controllers 20-5
  - Troubleshooting T1 Controllers 20-6

**CHAPTER 21**

**Configuring Pseudowire 21-1**

- Finding Feature Information 21-1
- Contents 21-1
- Understanding Pseudowires 21-2
  - Structure-Agnostic TDM over Packet 21-2
  - Structure-Aware TDM Circuit Emulation Service over Packet-Switched Network 21-3
  - Transportation of Service Using Ethernet over MPLS 21-3
    - Limitations 21-3
- Hot Standby Pseudowire Support for ATM/IMA 21-3
- Configuring Pseudowire 21-4
  - Configuring Pseudowire Classes 21-4
  - Configuring CEM Classes 21-6
  - Configuring a Backup Peer 21-8
  - Configuring Structure-Agnostic TDM over Packet 21-9
    - Configuring a SAToP Pseudowire with UDP Encapsulation 21-11

Configuring Circuit Emulation Service over Packet-Switched Network	21-14
Configuring a CESoPSN Pseudowire with UDP Encapsulation	21-15
QoS for CESoPSN over UDP and SAToP over UDP	21-18
Configuring Transportation of Service Using Ethernet over MPLS	21-18
Configuring L2VPN Pseudowire Redundancy	21-20
Example: Pseudowire Redundancy	21-22
Configuring Hot Standby Pseudowire Support for ATM/IMA	21-22
Configuring ATM/IMA Pseudowire Redundancy in PVC Mode	21-22
Configuring ATM/IMA Pseudowire Redundancy in PVP Mode	21-24
Configuring ATM/IMA Pseudowire Redundancy in Port Mode	21-25
Verifying Hot Standby Pseudowire Support for ATM/IMA	21-26
TDM Local Switching	21-27
Restrictions	21-28
Configuring TDM Local Switching on a T1/E1 Mode	21-28
DETAILED STEPS	21-28
Verifying Local Switching	21-29
Configuration Example for Local Switching	21-29
Configuration Examples of Hot Standby Pseudowire Support for ATM/IMA	21-30
Example: Configuring ATM/IMA Pseudowire Redundancy in PVC Mode	21-30
Example: Configuring ATM/IMA Pseudowire Redundancy in PVP Mode	21-30
Example: Configuring ATM/IMA Pseudowire Redundancy in Port Mode	21-31
Configuration Examples for Pseudowire	21-31
Example: TDM over MPLS Configuration-Example	21-31
Example: CESoPSN with UDP	21-34
Example: Ethernet over MPLS	21-35
Additional References	21-36
Related Documents	21-36
Standards	21-36
MIBs	21-36
RFCs	21-36
Technical Assistance	21-36
Feature Information for Configuring Pseudowire	21-37

**CHAPTER 22****Configuring Clocking 22-1**

Contents	22-1
Restrictions	22-1
Configuring Network Clock for Cisco ASR 901 Router	22-2
Configuring Network Clock in Global Configuration Mode	22-3

Configuring Network Clock in Interface Configuration Mode	22-6
Understanding SSM and ESMC	22-7
Synchronization Status Message	22-7
Ethernet Synchronization Messaging Channel	22-7
Clock Selection Algorithm	22-7
ESMC behavior for Port Channels	22-8
ESMC behavior for STP Blocked Ports	22-8
Configuring ESMC in Global Configuration Mode	22-8
Configuring ESMC in Interface Configuration Mode	22-9
Verifying ESMC Configuration	22-10
Managing Synchronization	22-11
Synchronization Example	22-12
Configuring Synchronous Ethernet for Copper Ports	22-13
Verifying the Synchronous Ethernet configuration	22-13
Troubleshooting Tips	22-16
Troubleshooting ESMC Configuration	22-17
Configuring PTP for the Cisco ASR 901 Router	22-18
Restrictions	22-18
Setting System Time to Current Time	22-19
Configuring PTP Ordinary Clock	22-19
Configuring Master Ordinary Clock	22-19
Configuring Slave Ordinary Clock	22-21
Configuring PTP in Unicast Mode	22-25
Configuring PTP in Unicast Negotiation Mode	22-25
PTP Boundary Clock	22-26
Configuring PTP Boundary Clock	22-27
Verifying PTP modes	22-29
Verifying PTP Configuration on the 1588V2 Slave	22-31
Verifying PTP Configuration on the 1588V2 Master	22-32
PTP Hybrid Clock	22-34
Configuring a Hybrid Ordinary Clock	22-34
Configuring a Hybrid Boundary Clock	22-37
Verifying Hybrid modes	22-38
SSM and PTP Interaction	22-39
ClockClass Mapping	22-40
Telecom Profiles	22-40
PTP Redundancy	22-40
Configuring Telecom Profile in Slave Ordinary Clock	22-41
Configuring Telecom Profile in Master Ordinary Clock	22-43
Verifying Telecom profile	22-44



Setting the TimeProperties	22-46
ASR901 Negotiation Mechanism	22-46
Static Unicast Mode	22-46
Configuring ToD on 1588V2 Slave	22-47
Troubleshooting Tips	22-47

**CHAPTER 23****Cisco IOS IP SLA 23-1**

Contents	23-1
Configuring IPSLA Path Discovery	23-1
Example for IPSLA Path Discovery	23-3
Two-Way Active Measurement Protocol	23-5
Configuring TWAMP	23-6
Configuring the TWAMP Server	23-7
Configuring the TWAMP Reflector	23-8
Configuration Examples for TWAMP	23-8
Example: Configuring the Router as an IP SLA TWAMP server	23-9
Example: Configuring the Router as an IP SLA TWAMP Reflector	23-9

**CHAPTER 24****Configuring QoS 24-1**

Finding Feature Information	24-1
Contents	24-1
Understanding QoS	24-2
Modular QoS CLI	24-4
Input and Output Policies	24-5
Input Policy Maps	24-5
Output Policy Maps	24-6
Access Control Lists	24-6
Restrictions	24-6
Classification	24-7
Class Maps	24-8
The match Command	24-8
Classification Based on Layer 2 CoS	24-9
Classification Based on IP Precedence	24-9
Classification Based on IP DSCP	24-9
Classification Comparisons	24-10
Classification Based on QoS Groups	24-11
Classification Based on VLAN IDs	24-12
Table Maps	24-13
Policing	24-14

Individual Policing	24-15
Unconditional Priority Policing	24-16
Egress Policing	24-17
Marking	24-18
Congestion Management and Scheduling	24-19
Traffic Shaping	24-19
Class-Based Weighted Fair Queuing	24-21
Priority Queuing	24-23
Ingress and Egress QoS Functions	24-24
Configuring Quality of Service (QoS)	24-25
QoS Limitations	24-25
General QoS Limitations	24-26
Statistics Limitations	24-26
Propagation Limitations	24-27
Classification Limitations	24-27
Marking Limitations	24-28
Congestion Management Limitations	24-29
ACL-based QoS Restrictions	24-30
Improving Feature Scalability	24-31
TCAM with QoS	24-31
QoS for MPLS/IP over MLPPP	24-31
QoS for CPU Generated Traffic	24-31
QoS Configuration Guidelines	24-32
Sample QoS Configuration	24-33
Configuring Classification	24-34
Creating a Class Map for Classifying Network Traffic	24-34
Creating a Policy Map for Applying a QoS Feature to Network Traffic	24-35
Attaching the Policy Map to an Interface	24-36
Attaching Policy Map to Cross Connect EVC	24-37
Configuring Marking	24-38
Creating a Class Map for Marking Network Traffic	24-39
Creating a Policy Map for Applying a QoS Feature to Network Traffic	24-39
Attaching the Policy Map to an Interface	24-40
Configuring MPLS Exp Bit Marking using a Pseudowire	24-41
Configuring Congestion Management	24-42
Configuring Low Latency Queueing (LLQ)	24-42
Configuring Multiple Priority Queueing	24-43
Configuration Examples	24-44
Configuring Class-Based Weighted Fair Queuing (CBFQ)	24-45
Weighted Random Early Detection (WRED)	24-46

Configuring Shaping	24-47
Configuring Class-Based Traffic Shaping in a Primary-Level (Parent) Policy Map	24-47
Configuring the Secondary-Level (Child) Policy Map	24-48
Configuring Ethernet Trusted Mode	24-49
Creating IP Extended ACLs	24-49
Using Class Maps to Define a Traffic Class	24-50
Creating a Named Access List	24-52
Restrictions	24-52
What to do Next	24-53
TCAM with ACL	24-54
Verifying Named Access List	24-55
Configuration Example for Named Access List	24-56
QoS Treatment for Performance-Monitoring Protocols	24-62
Cisco IP-SLAs	24-62
QoS Treatment for IP-SLA Probes	24-62
Marking	24-62
Queuing	24-62
QoS Marking for CPU-Generated Traffic	24-62
QoS Queuing for CPU-Generated Traffic	24-63
Extending QoS for MLPPP	24-64
Configuring Class-map for Matching MPLS EXP Bits	24-64
Configuring Class-map for Matching IP DSCP Value	24-65
Configuring Class-map for Matching MPLS EXP Bits or IP DSCP Value	24-66
Configuring a Policy-map	24-67
Attaching the Policy-map to MLPPP Interface	24-70
Re-marking IP DSCP Values of CPU Generated Traffic	24-72
Re-marking MPLS EXP Values of CPU Generated Traffic	24-73
Configuring a Policy-map to Match on CS5 and EXP4	24-74
Attaching the Policy-map to Match on CS5 and EXP4 to MLPPP Interface	24-76
Configuration Examples for Extending QoS for MPLS over MLPPP	24-76
Configuring Class-map for Matching MPLS EXP Bits	24-76
Configuring Class-map for Matching IP DSCP Value	24-77
Configuring Class-map for Matching MPLS EXP Bits or IP DSCP Value	24-77
Configuring a Policy-map	24-77
Configuring a Policy-map to Match on CS5 and EXP 4	24-78
Attaching the Policy-map to MLPPP Interface	24-78
Verifying MPLS over MLPPP Configuration	24-79
Configuration Guidelines	24-80
Troubleshooting Tips	24-81

- Additional References **24-87**
  - Related Documents **24-87**
  - Standards **24-87**
  - MIBs **24-87**
  - RFCs **24-87**
  - Technical Assistance **24-87**
- Feature Information for Configuring QoS **24-88**

**CHAPTER 25**

**Configuring MLPPP 25-1**

- Finding Feature Information **25-1**
- Contents **25-1**
- Prerequisites **25-2**
- Restrictions **25-2**
- MLPPP Optimization Features **25-2**
  - Distributed Multilink Point-to-Point Protocol Offload **25-2**
  - Multiclass MLPPP **25-3**
  - MPLS over MLPPP **25-3**
    - MPLS Features Supported for MLPPP **25-4**
    - MPLS over MLPPP on PE-to-CE Links **25-4**
    - MPLS over MLPPP on Core Links **25-5**
    - MPLS over MLPPP on CE to PE Links **25-5**
- Configuring MLPPP Backhaul **25-6**
  - Configuring the Card Type, E1 and T1 Controllers **25-6**
  - Configuring a Multilink Backhaul Interface **25-6**
    - Creating a Multilink Bundle **25-6**
    - Configuring MRRU **25-7**
    - Configuring PFC and ACFC **25-8**
    - Enabling Multilink and Identifying the Multilink Interface **25-11**
    - Configuring a Serial Interface as a Member Link of a MLPPP Group **25-12**
  - MLPPP Offload **25-13**
    - Configuring Additional MLPPP Settings **25-14**
  - Configuring MPLS over the MLPPP on a Serial Interface **25-14**
  - Configuring MPLS over MLPPP for OSPF **25-16**
  - Configuration Examples for MPLS over MLPPP **25-18**
  - Verifying MPLS over MLPPP Configuration **25-19**
- Additional References **25-21**
  - Related Documents **25-21**
  - Standards **25-21**
  - MIBs **25-21**

RFCs	25-21
Technical Assistance	25-21
Feature Information for MLPPP	25-22

**CHAPTER 26****Onboard Failure Logging 26-1**

Contents	26-1
Understanding OBFL	26-1
Configuring OBFL	26-2
Verifying OBFL Configuration	26-2

**CHAPTER 27****Hot Standby Router Protocol and Virtual Router Redundancy Protocol 27-1**

Finding Feature Information	27-1
Contents	27-1
Information About HSRP and VRRP	27-2
Overview of HSRP and VRRP	27-2
Text Authentication	27-2
Preemption	27-2
How to Configure HSRP	27-3
Configuring HSRP	27-3
Restrictions	27-3
Configuration Examples for HSRP	27-5
Example: Configuring HSRP Active Router	27-5
Example: Configuring HSRP Backup Router	27-5
Example: HSRP Text Authentication	27-6
How to Configure VRRP	27-6
Configuring VRRP	27-6
Restrictions	27-6
Configuration Examples for VRRP	27-8
Example: Configuring a VRRP Master Router	27-8
Example: Configuring a VRRP Backup Router	27-8
Example: VRRP Text Authentication	27-9
Where to Go Next	27-9
Additional References	27-9
Related Documents	27-9
Standards	27-9
MIBs	27-10
RFCs	27-10
Technical Assistance	27-10

Feature Information for HSRP and VRRP 27-11

**CHAPTER 28**

**Configuring Link Layer Discovery Protocol 28-1**

- Finding Feature Information 28-1
- Contents 28-1
- Restrictions for LLDP 28-2
- Overview of LLDP 28-2
- How to Configure LLDP 28-2
  - Configuring LLDP 28-2
  - Verifying LLDP 28-4
- Configuration Example for LLDP 28-4
  - Example: Enabling LLDP Globally 28-4
  - Example: Configuring Hold Time 28-4
  - Example: Configuring **Delay Time** 28-5
  - Example: Configuring Intervals 28-5
- Where to Go Next 28-6
- Additional References 28-7
  - Related Documents 28-7
  - Standards 28-7
  - MIBs 28-7
  - RFCs 28-7
  - Technical Assistance 28-8
- Feature Information for LLDP 28-8

**CHAPTER 29**

**Configuring Multihop Bidirectional Forwarding Detection 29-1**

- Finding Feature Information 29-1
- Contents 29-1
- Restrictions for Multihop BFD 29-2
- Information About Multihop BFD 29-2
  - Overview of Multihop BFD 29-2
- How to Configure Multihop BFD 29-2
  - Configuring Multihop BFD Template 29-2
  - Configuring a Multihop BFD Map 29-4
- Configuration Examples for Multihop BFD 29-4
  - Example : Configuring Multihop BFD 29-4
- Where to Go Next 29-5
- Additional References 29-6

Related Documents	29-6
Standards	29-6
MIBs	29-6
RFCs	29-6
Technical Assistance	29-7
Feature Information for Multihop BFD	29-7

**CHAPTER 30****Bit Error Rate Testing 30-1**

Finding Feature Information	30-1
Contents	30-1
Prerequisites	30-1
Restrictions	30-2
Feature Overview	30-2
How to Configure BERT	30-2
Performing BERT on a T1/E1 Line	30-3
Terminating BERT on a T1/E1 Controller	30-3
Verifying BERT on a T1/E1 Controller	30-4
Configuration Examples	30-5
Additional References	30-5
Related Documents	30-6
Standards	30-6
MIBs	30-6
RFCs	30-6
Technical Assistance	30-6
Feature Information for Bit Error Rate Testing	30-6

**CHAPTER 31****Microwave ACM Signaling and EEM Integration 31-1**

Finding Feature Information	31-1
Contents	31-1
Prerequisites	31-2
Feature Overview	31-2
Benefits	31-3
How to Configure Microwave ACM Signaling and EEM Integration	31-4
Configuring Connectivity Fault Management	31-4
Configuring EEP Applet Using CLIs	31-7
Prerequisites	31-7
Configuring Event Handler	31-9
Verifying Microwave Microwave ACM Signaling and EEM Integration Configuration	31-10

- Configuration Examples for Microwave ACM Signaling and EEM Integration **31-11**
  - Example: Configuring CFM **31-11**
  - Example: Configuring EEP Applet **31-11**
  - Example: Configuring Event Handler **31-15**
- Additional References **31-16**
  - Related Documents **31-16**
  - Standards **31-16**
  - MIBs **31-16**
  - RFCs **31-16**
  - Technical Assistance **31-16**
- Feature Information for Microwave ACM Signaling and EEM Integration **31-17**

**CHAPTER 32**

**IPv6 Support on the Cisco ASR 901 Router 32-1**

- Finding Feature Information **32-1**
- Contents **32-1**
- Prerequisites for IPv6 Support on the Cisco ASR 901 Router **32-2**
- Restrictions for IPv6 Support on the Cisco ASR 901 Router **32-2**
- Information About IPv6 Support on the Cisco ASR 901 Router **32-2**
  - Benefits **32-3**
  - Overview of IPv6 **32-3**
  - IPv6 Address Formats **32-3**
  - IPv6 Addressing and Discovery **32-4**
    - Static Configuration **32-4**
    - Stateless Autoconfiguration **32-5**
    - ICMPv6 **32-5**
    - IPv6 Duplicate Address Detection **32-6**
    - IPv6 Neighbor Discovery **32-6**
    - IPv4 and IPv6 Dual-Stack on an Interface **32-6**
  - Routing Protocols **32-7**
    - IS-IS Enhancements for IPv6 **32-7**
    - OSPFv3 for IPv6 **32-7**
    - Multiprotocol BGP Extensions for IPv6 **32-7**
  - Bidirectional Forwarding Detection for IPv6 **32-7**
  - QoS for IPv6 **32-8**
- How to Configure IPv6 Support on the Cisco ASR 901 Router **32-8**
  - Configuring IPv6 Addressing and Enabling IPv6 Routing **32-8**
  - Configuring a Static IPv6 Route **32-10**
  - Enabling Stateless Auto-Configuration **32-11**
  - Implementing IPv6 on VLAN Interfaces **32-12**



Implementing IPv6 Addressing on Loopback Interfaces	32-13
Configuring ICMPv6 Rate Limiting	32-14
Configuring IPv6 Duplicate Address Detection	32-15
Configuring IPv6 Neighbor Discovery	32-16
Configuring IPv6 and IPv4 Dual-Stack on the Same VLAN	32-17
Prerequisites	32-17
Configuring OSPFv3 for IPv6	32-18
Configuring IS-IS for IPv6	32-19
Configuring Multiprotocol-BGP for IPv6	32-21
Configuring BFD for IPv6	32-22
Specifying a Static BFDv6 Neighbor	32-22
Associating an IPv6 Static Route with a BFDv6 Neighbor	32-23
Configuring BFDv6 and OSPFv3	32-25
Prerequisites	32-25
Configuring BFDv6 for BGP	32-26
Implementing QoS for IPv6	32-27
Verifying the Configuration of IPv6 Support on the Cisco ASR 901 Router	32-27
Verifying IPv6 Addressing Routing	32-27
Verifying a Static IPv6 Route	32-28
Verifying a Stateless Auto-Configuration	32-29
Verifying IPv6 Implementation on VLAN Interfaces	32-29
Verifying IPv6 Implementation on Loopback Interfaces	32-30
Verifying ICMPv6 Configuration	32-30
Verifying IPv6 Duplicate Address Detection Configuration	32-32
Verifying IPv6 Neighbor Discovery Configuration	32-33
Verifying IPv6 and IPv4 Dual-Stack Configuration	32-33
Verifying OSPFv3 for IPv6 Configuration	32-34
Verifying IS-IS for IPv6 Configuration	32-35
Verifying Multiprotocol-BGP for IPv6 Configuration	32-35
Verifying BFD for IPv6 Configuration	32-37
Verifying BFDv6 and OSPFv3 Configuration	32-38
Verifying BFDv6 for BGP Configuration	32-39
Configuration Examples for IPv6 Support on the Cisco ASR 901 Router	32-39
Example: IPv6 Addressing on VLAN Interfaces	32-40
Example: IPv6 Addressing on Loopback Interfaces	32-40
Example: Customizing ICMPv6	32-40
Example: Configuring IPv6 Duplicate Address Detection	32-40
Example: Configuring IPv6 Neighborhood Discovery	32-41
Example: Enabling IPv6 Stateless Address Autoconfiguration	32-41
Example: Configuring the IPv4 and IPv6 Dual-Stack	32-41

- Example: Configuring IPv6 Static Routing 32-41
- Example: Configuring BFD and Static Routing for IPv6 32-42
- Example: Configuring OSPFv3 for IPv6 32-42
- Example: Configuring BFD and OSPFv3 for IPv6 32-42
- Example: Configuring IS-IS for IPv6 32-43
- Example: Configuring Multiprotocol-BGP for IPv6 32-44
- Example: Configuring BFD and Multiprotocol-BGP for IPv6 32-45
- Troubleshooting Tips 32-46
- Where to Go Next 32-46
- Additional References 32-47
  - Related Documents 32-47
  - Standards 32-47
  - MIBs 32-47
  - RFCs 32-47
  - Technical Assistance 32-48
- Feature Information for IPv6 Support on the Cisco ASR 901 Router 32-49

**CHAPTER 33**

**Labeled BGP Support 33-1**

- Finding Feature Information 33-1
- Contents 33-1
  - Prerequisites 33-2
  - Restrictions 33-2
- Overview of Labeled BGP Support 33-2
- How to Configure Labeled BGP Support 33-2
  - Configuration Example for Labeled Support 33-3
  - Verifying Labeled BGP Support 33-4
- Additional References 33-7
  - Related Documents 33-7
  - Standards 33-7
  - MIBs 33-7
  - RFCs 33-7
  - Technical Assistance 33-7
- Feature Information for Labeled BGP Support 33-8

**CHAPTER 34**

**MPLS Traffic Engineering - Fast Reroute Link Protection 34-1**

- Finding Feature Information 34-1
- Contents 34-1
  - Prerequisites 34-2

Restrictions	34-2
Feature Overview	34-2
BFD-triggered Fast Reroute	34-3
BFD	34-4
Fast Reroute	34-4
Link Protection	34-4
How to Configure Traffic Engineering - Fast Reroute Link Protection	34-4
Enabling MPLS TE-FRR on an SVI Interface	34-5
Enabling MPLS TE-FRR for EoMPLS on a Global Interface	34-5
Enabling MPLS TE-FRR for EoMPLS on an Interface	34-7
Enabling MPLS TE-FRR for IS-IS	34-9
Configuring Primary One-hop Auto-Tunnels	34-11
Configuring Backup Auto-Tunnels	34-13
Enabling Targeted LDP session over Primary one-hop Auto-Tunnels	34-14
Enabling BFD Triggered FRR on an SVI Interface	34-15
Enabling BFD Triggered FRR on a Router	34-16
Verification Examples	34-17
Verifying MPLS TE-FRR Configuration	34-17
Verifying Primary One-hop Auto-Tunnels	34-19
Verifying Backup Auto-Tunnels	34-19
Verifying BFD Triggered FRR Configuration	34-20
Configuration Examples	34-24
Example: Configuring MPLS TE-FRR	34-24
Example: Configuring Primary One-hop Auto-Tunnels	34-24
Example: Configuring Backup Auto-Tunnels	34-24
Example: Configuring BFD Triggered FRR	34-24
Additional References	34-25
Related Documents	34-25
Standards	34-25
MIBs	34-25
RFCs	34-25
Technical Assistance	34-26
Feature Information for MPLS Traffic Engineering - Fast Reroute Link Protection	34-27

**CHAPTER 35****Layer 2 Control Protocol Peering, Forwarding, and Tunneling** 35-1

Finding Feature Information	35-1
Contents	35-1
Prerequisites	35-1
Restrictions	35-2

- Layer 2 Control Protocol Forwarding 35-2
- Layer 2 Control Protocol Tunneling 35-2
- How to Configure Layer 2 Control Protocol Peering, Forwarding, and Tunneling 35-3
  - Configuring Layer 2 Peering 35-4
    - Restrictions 35-4
  - Configuring Layer 2 Forwarding 35-5
    - Restrictions 35-5
  - Configuring Layer 2 Tunneling 35-7
    - Restrictions 35-7
  - Verifying Layer 2 Peering 35-9
  - Verifying Layer 2 Forwarding 35-9
  - Verifying Layer 2 Tunneling 35-9
- Configuration Examples 35-10
  - Example: Configuring Layer 2 Peering 35-10
  - Example: Configuring Layer 2 Forwarding 35-10
  - Example: Configuring Layer 2 Tunneling 35-11
- Additional References 35-13
  - Related Documents 35-14
  - Standards 35-14
  - MIBs 35-14
  - RFCs 35-14
  - Technical Assistance 35-14
- Feature Information for Layer 2 Control Protocol Peering, Forwarding, and Tunneling 35-15

**CHAPTER 36**

**Configuring Inverse Multiplexing over ATM 36-1**

- Finding Feature Information 36-1
- Contents 36-1
  - Prerequisites 36-1
  - Restrictions 36-2
- Feature Overview 36-2
- How to Configure IMA 36-2
- Configuring ATM IMA on T1/E1 Interface 36-3
- Configuring ATM IMA over MPLS 36-4
  - Configuring the T1/E1 Controller 36-4
  - Configuring an ATM IMA Interface 36-5
  - Configuring ATM over MPLS Pseudowire Interface 36-6
    - Configuring a Port Mode Pseudowire 36-7
    - Configuring an N-to-1 VCC Cell Mode 36-7

Configuring an N-to-1 vPC Cell Mode	36-8
ATM AAL5 SDU VCC Transport	36-9
Verifying IMA Configurations	36-10
How to Configure ATM Class of Service	36-11
Configuring Constant Bit Rate	36-11
Configuring Unspecified Bit Rate	36-12
Configuring Unspecified Bit Rate Plus	36-13
Configuring Variable Bit Rate for Real/Non-Real Time Traffic	36-14
Configuration Examples	36-15
Example: Creating an IMA Interface	36-15
Example: Configuring a Port Mode Pseudowire	36-15
Example: Configuring an N-to-1 VCC Cell Mode	36-16
Example: Configuring an N-to-1 VPC Cell Mode	36-16
Example: Configuring CBR	36-16
Example: Configuring UBR	36-16
Example: Configuring UBR Plus	36-17
Example: Configuring VBR for Real Time Traffic	36-17
Example: Configuring VBR for Non-Real Time Traffic	36-17
Configuring Marking MPLS Experimental Bits	36-17
Creating a Policy-map for PVP/PVC/ATM IMA Interface	36-17
Applying the Policy-map	36-18
Applying a Policy map on PVC and PVP	36-18
Applying a Policy map on ATM IMA Interface	36-20
Creating a Table-map	36-21
Creating a Policy-map for SVI Interface	36-22
Applying a Service Policy on SVI Interface	36-23
Additional References	36-25
Related Documents	36-25
Standards	36-25
MIBs	36-25
RFCs	36-25
Technical Assistance	36-25
Feature Information for Inverse Multiplexing over ATM	36-26

**CHAPTER 37****IPv6 over MPLS: 6PE and 6VPE** 37-1

Finding Feature Information 37-1

Contents 37-1

Prerequisites 37-2

Restrictions 37-2

- Feature Overview **37-2**
  - Benefits of 6PE and 6VPE **37-3**
  - IPv6 on Provider Edge Routers **37-3**
  - IPv6 on VPN Provider Edge Routers **37-4**
    - Components of MPLS-based 6VPE Network **37-4**
- Supported Features **37-5**
- Scalability Numbers **37-6**
- How to Configure IPv6 over MPLS: 6PE and 6VPE **37-6**
  - Configuring 6PE **37-6**
  - Configuring 6VPE **37-9**
    - Setting up IPv6 Connectivity from PE to CE Routers **37-9**
    - Setting up MP-BGP Peering to the Neighboring PE **37-10**
    - Setting up MPLS/IPv4 Connectivity with LDP **37-12**
    - Creating IPv6 VRFs on PE Routers **37-13**
  - Verifying IPv6 over MPLS: 6PE and 6VPE Configuration **37-15**
- Configuration Examples **37-18**
  - Example: Configuring 6PE **37-18**
  - Example: Configuring 6VPE **37-19**
- Additional References **37-20**
  - Related Documents **37-20**
  - Standards **37-20**
  - MIBs **37-20**
  - RFCs **37-20**
  - Technical Assistance **37-20**
- Feature Information for IPv6 over MPLS: 6PE and 6VPE **37-21**

**CHAPTER 38**

- Storm Control 38-1**
  - Finding Feature Information **38-1**
  - Contents **38-1**
    - Prerequisites **38-2**
    - Restrictions **38-2**
  - Feature Overview **38-2**
  - Configuring Storm Control **38-2**
    - Verifying Storm Control **38-4**
  - Configuring Error Disable Recovery **38-5**
    - Monitoring Error Disable Recovery **38-6**
  - Configuration Example for Storm Control **38-7**
  - Troubleshooting Tips **38-7**

Additional References	38-8
Related Documents	38-8
Standards	38-8
MIBs	38-8
RFCs	38-8
Technical Assistance	38-8
Feature Information for Storm Control	38-9

**CHAPTER 39****Remote Loop-Free Alternate - Fast Reroute 39-1**

Finding Feature Information	39-1
Contents	39-1
Prerequisites	39-2
Restrictions	39-2
Feature Overview	39-3
Benefits of Remote LFA-FRR	39-4
Avoiding Traffic Drops	39-4
Pseudowire Redundancy over FRR	39-4
Conditions for Switchover	39-5
How to Configure Remote Loop-Free Alternate - Fast Reroute	39-5
Configuring Remote LFA-FRR for IS-IS	39-6
Configuring Remote LFA-FRR for OSPF	39-9
Configuring Remote LFA-FRR for Ethernet and TDM Pseudowires	39-11
Configuring Remote LFA-FRR on a Global Interface	39-12
Configuring Remote LFA-FRR on a GigabitEthernet Interface	39-13
Configuring Remote LFA-FRR on an SVI Interface	39-14
Configuring Remote LFA-FRR on IS-IS	39-15
Configuring LFA-FRR for EoMPLS	39-19
Configuring LFA-FRR for ATM/IMA	39-21
Configuring LFA-FRR for CESoPSN	39-23
Configuring LFA-FRR for SAToP	39-25
Verification Examples for Remote LFA-FRR	39-27
Verifying Remote LFA-FRR Configuration	39-28
Verifying Remote LFA-FRR Configuration for EoMPLS on a GigabitEthernet Interface	39-30
Verifying Remote LFA-FRR Configuration for EoMPLS on an EVC Interface	39-32
Verifying Remote LFA-FRR Configuration on IS-IS	39-33
Verifying Remote LFA-FRR Configuration on ATM/IMA	39-33
Verifying Remote LFA-FRR Configuration on CESoPSN	39-34
Verifying Remote LFA-FRR Configuration on SAToP	39-35
Configuration Examples for Remote LFA-FRR	39-35

Example: Configuring Remote LFA-FRR for IS-IS	39-36
Example: Configuring Remote LFA-FRR for OSPF	39-36
Example: Configuring Remote LFA-FRR Globally	39-36
Example: Configuring Remote LFA-FRR on a GigabitEthernet Interface	39-37
Example: Configuring Remote LFA-FRR on an SVI Interface	39-37
Example: Configuring EoMPLS Pseudowire Redundancy over FRR	39-37
Example: Configuring LFA-FRR on ATM/IMA	39-37
Example: Configuring LFA-FRR on CESoPSN	39-38
Example: Configuring LFA-FRR on SAToP	39-38
Additional References	39-39
Related Documents	39-39
Standards	39-39
MIBs	39-39
RFCs	39-39
Technical Assistance	39-39
Feature Information for Remote Loop-Free Alternate - Fast Reroute	39-40

**CHAPTER 40**

**Digital Optical Monitoring 40-1**

Finding Feature Information	40-1
Contents	40-1
Feature Overview	40-1
How to Enable Transceiver Monitoring	40-2
Restrictions	40-2
Examples	40-3
Example: Displaying Transceiver Information	40-3
Example: Displaying Detailed Transceiver Information	40-4
Example: Displaying List of Supported Transceivers	40-5
Example: Displaying Threshold Tables	40-6
Example: Displaying Threshold Violations	40-9
Example: Displaying Threshold Violations on a Specific Interface	40-9
Example: When Transceiver Monitoring is Disabled	40-9
Example: Displaying SPF Details	40-10
Additional References	40-12
Related Documents	40-12
Standards	40-12
MIBs	40-12
RFCs	40-12
Technical Assistance	40-12
Feature Information for Digital Optical Monitoring	40-13



**CHAPTER 41****IPv4 Multicast 41-1**

Finding Feature Information	41-1
Contents	41-1
Prerequisites	41-2
Restrictions	41-2
Feature Overview	41-2
Supported Protocols	41-3
PIM SSM for IPv4	41-3
Source Specific Multicast	41-3
Protocol Independent Multicast	41-3
IGMP	41-4
IGMPv1	41-4
IGMPv2	41-4
IGMPv3	41-4
PIM SSM Mapping	41-5
Static SSM Mapping	41-5
Reverse Path Forwarding	41-5
Configuring IPv4 Multicast	41-6
Enabling IPv4 Multicast Routing	41-6
Configuring PIM SSM	41-7
Configuring PIM SSM Mapping	41-8
Verifying IPv4 Multicast Routing	41-9
Verifying PIM SSM	41-9
Verifying PIM SSM Mapping	41-10
Configuration Examples for IPv4 Multicast	41-11
Example: IPv4 Multicast Routing	41-12
Example: Configuring PIM SSM	41-12
Example: Configuring PIM SSM Mapping	41-12
Example: Configuring Rendezvous Point	41-13
Troubleshooting Tips	41-13
Additional References	41-14
Related Documents	41-14
Standards	41-14
MIBs	41-14
RFCs	41-14
Technical Assistance	41-15
Feature Information for IPv4 Multicast	41-16

**CHAPTER 42**

**IPv6 Multicast 42-1**

- Finding Feature Information 42-1
- Contents 42-1
  - Prerequisites 42-2
  - Restrictions 42-2
- Feature Overview 42-2
  - IPv6 Multicast Groups 42-3
  - IPv6 Multicast Routing Implementation 42-3
  - Multicast Listener Discovery Protocol for IPv6 42-3
  - Protocol Independent Multicast 42-4
    - PIM Source Specific Multicast 42-5
    - Source Specific Multicast Mapping for IPv6 42-5
    - PIM-Sparse Mode 42-5
    - Rendezvous Point 42-6
- Configuring IPv6 Multicast 42-6
  - Enabling IPv6 Multicast Routing 42-6
  - Disabling IPv6 Multicast Forwarding 42-7
  - Disabling MLD Device-Side Processing 42-8
  - Configuring MLD Protocol on an Interface 42-9
  - Configuring a Rendezvous Point 42-10
  - Configuring PIM SSM Options 42-11
  - Disabling PIM SSM Multicast on an Interface 42-12
  - Configuring IPv6 SSM Mapping 42-12
  - Verifying IPv6 Multicast 42-13
- Configuration Examples for IPv6 Multicast 42-21
  - Example: Enabling IPv6 Multicast Routing 42-21
  - Example: Configuring IPv6 SSM Mapping 42-21
  - Example: Configuring Rendezvous Point 42-21
- Troubleshooting Tips 42-21
- Additional References 42-23
  - Related Documents 42-23
  - Standards 42-23
  - MIBs 42-23
  - RFCs 42-23
  - Technical Assistance 42-23
- Feature Information for IPv6 Multicast 42-24

**CHAPTER 43**

<b>Configuring Switched Port Analyzer</b>	<b>43-1</b>
Finding Feature Information	43-1
Contents	43-1
SPAN Limitations and Configuration Guidelines	43-1
Understanding SPAN	43-2
Overview	43-2
SPAN Session	43-3
Source Interface	43-3
Destination Interface	43-4
Traffic Types	43-4
SPAN Traffic	43-4
Configuring SPAN	43-4
Creating a SPAN Session	43-4
SUMMARY STEPS	43-4
DETAILED STEPS	43-5
Removing Sources or Destination from a SPAN Session	43-5
SUMMARY STEPS	43-6
DETAILED STEPS	43-6
Configuration Examples for SPAN	43-6
Verifying Local SPAN	43-6
Additional References	43-8
Related Documents	43-8
Standards	43-8
MIBs	43-8
RFCs	43-8
Technical Assistance	43-8
Feature Information for Switched Port Analyzer	43-9





## About This Guide

---

This section describes the objectives, audience, organization, and conventions of this software configuration guide. It contains the following sections:

- [Document Revision History, page xxxvii](#)
- [Objectives, page xlvii](#)
- [Audience, page xlvii](#)
- [Organization, page xlvii](#)
- [Conventions, page I](#)
- [Related Documentation, page li](#)
- [Obtaining Documentation, Obtaining Support, and Security Guidelines, page li](#)

## Document Revision History

The Document Revision History table records technical changes to this document.

Document Number	Date	Change Summary
OL-23826-01	November 2011	Initial version of the document.
OL-23826-02	January 2012	Following are the updates specific to this release: <ul style="list-style-type: none"><li>• Cisco ASR 901 supports port based licensing. This type of license is applicable to gigabit ethernet ports only. Ports 4 to 7 are enabled by default. For Copper and SFP ports, you need to purchase separate licenses to enable them. For more details see, <a href="#">Chapter 2, “Licensing”</a>.</li><li>• SL-A901-B license supports VRF-Lite. For more details see, <a href="#">Chapter 2, “Licensing”</a>.</li><li>• The minimum time interval supported for BFD is 50 ms. For more details, see <a href="#">Chapter 19, “Configuring Bidirectional Forwarding Detection”</a>.</li><li>• Cisco ASR 901 supports MLPPP configuration. For more details, see <a href="#">Chapter 25, “Configuring MLPPP”</a>.</li></ul>

Document Number	Date	Change Summary
OL-23826-03	May 2012	<ul style="list-style-type: none"> <li>• Structure-Agnostic TDM over Packet (SAToP) is a structure-agnostic protocol for transporting TDM using pseudowires (PW). PW connections using SAToP are supported.</li> <li>• SAToP pseudowire with UDP encapsulation is supported.</li> <li>• CESoPSN pseudowire with UDP encapsulation is supported.</li> <li>• QoS for CESoPSN over UDP and SAToP over UDP—IP DSCP and IP Precedence via service-policy, and Type of Service (ToS) settings are supported in pseudowire class.</li> <li>• L2VPN Pseudowire Redundancy feature: <ul style="list-style-type: none"> <li>– provides backup service for circuit emulation (CEM) pseudowires.</li> <li>– enables the network to detect failure, and reroute the Layer 2 (L2) service to another endpoint that can continue to provide the service.</li> <li>– provides the ability to recover from a failure: either the failure of the remote PE router, or of the link between the PE and the CE routers.</li> </ul> </li> <li>• T1 Local Switching—This feature allows switching of Layer 2 data between two CEM interfaces on the same router.</li> <li>• IEEE 1588-2008 (PTPv2) Ordinary Clock (OC) Master Clock mode is supported.</li> <li>• G.781 QL-enabled mode is supported for synchronization clock selection to avoid timing loops in the network.</li> <li>• ESMC—This feature dynamically distributes clock-quality across synchronous ethernet links and enables selection of the best clock in the network.</li> <li>• Onboard Failure Logging (OBFL)—OBFL provides a mechanism to store hardware, software, and environment related critical data in a non-volatile memory, such as flash EPROM or EEPROM on routers. Stored OBFL data can be retrieved in the event of a crash or failure.</li> <li>• MAC Flap control—A MAC flap occurs when a switch receives packets from two different interfaces, with the same source MAC address. When a MAC flap occurs, Cisco ASR 901 does Err-Disabling in one of the ports that has flapping.</li> </ul>

Document Number	Date	Change Summary
		<ul style="list-style-type: none"> <li>• CFM over EFP Interface with cross connect— This feature allows you to: <ul style="list-style-type: none"> <li>– Forward continuity check messages (CCM) towards the core over cross connect pseudowires.</li> <li>– Receive CFM messages from the core.</li> <li>– Forward CFM messages to the access side (after Continuity Check Database [CCDB] based on maintenance point [MP] filtering rules).</li> </ul> </li> <li>• IPSLA Path Discovery—The LSP path discovery (LPD) feature allows the IP SLA MPLS LSP to automatically discover all the active paths to the forwarding equivalence class (FEC), and configure LSP ping and traceroute operations across various paths between the provide edge (PE) devices.</li> <li>• Routed QinQ—Pop 2 configuration is supported.</li> <li>• Port Based EoMPLS—Port mode allows a frame coming into an interface to be packed into an MPLS packet and transported over the MPLS backbone to an egress interface. The entire ethernet frame without the preamble or FCS is transported as a single packet.</li> <li>• Rommon and MCU upgrade—Upgradable MCU and ROMMON is bundled with the IOS image. Once the IOS image is upgraded, both the MCU and the ROMMON images also get upgraded.</li> <li>• T1.403 remote loopback—Cisco ASR 901 accepts the remote loopback (line and payload) initiated at the far end.</li> <li>• Layer3 VPN over REP/MST is supported.</li> </ul>

Document Number	Date	Change Summary
OL-23826-04	August 2012	<p>Following are the updates specific to this release:</p> <ul style="list-style-type: none"> <li>• DHCP client on SVI—This feature allows you to configure DHCP client on SVI interface.</li> <li>• HSRP/VRRP—This feature allows you to configure the Hot Standby Router Protocol (HSRP) or Virtual Router Redundancy Protocol (VRRP) protocol.</li> <li>• TWAMP Responder—This feature allows you to deploy TWAMP in a simplified network architecture, with the control-client and the session-sender on one device and the server and the session-reflector on another device.</li> <li>• Dying Gasp—This feature allows you to send notifications during power failure, link down, router reload and link administratively down conditions.</li> <li>• Multihop BFD—This feature allows you to do subsecond forwarding failure detection for a destination with more than one hop and up to 255 hops.</li> <li>• Ethernet Loopback—This feature allows you to use per-port and per VLAN Ethernet loopback to test connectivity at initial startup, to test throughput, and to test quality of service in both directions.</li> <li>• LLDP—This feature allows the network devices to advertise information about themselves to other devices in the network.</li> <li>• Bit Error Rate Testing—This feature allows you to test the integrity of the physical layer. For more details, see Bit Error Rate Testing.</li> <li>• IPv6 Support—This feature supports Long Term Evolution (LTE) rollouts that provides high-bandwidth data connection for mobile wireless devices. The Cisco ASR 901 router supports IPv6 addressing on Switch Virtual Interface (SVI), Loopback, and Ethernet interfaces. For more details, see IPv6 Support on the Cisco ASR 901 Router.</li> <li>• Labeled BGP Support—This feature describes how to add label mapping information to the Border Gateway Protocol (BGP) message that is used to distribute the route on the Cisco ASR 901 Series Aggregation Services Routers. For more details, see Labeled BGP Support.</li> <li>• MPLS Traffic Engineering—This feature describes the Fast Reroute (FRR) link protection and Bidirectional Forwarding Detection (BFD)-triggered FRR feature of Multiprotocol Label Switching (MPLS) traffic engineering (TE). The MPLS TE is supported on the Cisco ASR 901 router to enable only the FRR. The traffic engineering aspects of MPLS TE is currently not supported. For more details, see MPLS Traffic Engineering - Fast Reroute Link Protection.</li> </ul>



Document Number	Date	Change Summary
OL-23826-05	October 2012	<p data-bbox="800 300 1344 321">Following are the updates specific to this release:</p> <ul data-bbox="800 342 1507 930" style="list-style-type: none"><li data-bbox="800 342 1414 405">• IMA—This feature allows you to configure Inverse Multiplexing over ATM (IMA).</li><li data-bbox="800 426 1414 510">• TDM Local Switching—This feature allows you to configure Time Division Multiplexing (TDM) local switching on the T1 or E1 mode.</li><li data-bbox="800 531 1463 657">• Licensing—This feature allows you to view the list of licenses available for the Cisco ASR 901 router. The 10gigUpgrade and Gige4portflexi licenses are available from Cisco IOS Release 15.2(2)SNH1 onwards.</li><li data-bbox="800 678 1442 730">• EVC—The restrictions section of the Ethernet Virtual Connections feature is updated.</li><li data-bbox="800 751 1490 804">• L2PT—This feature allows tunneling of Ethernet protocol frames across layer 2 switching domains.</li><li data-bbox="800 825 1507 930">• ACL-based QoS—The Access Control List (ACL) based Qos feature provides classification based on source and destination. The current implementation of this feature supports only named ACLs.</li></ul>

Document Number	Date	Change Summary
OL-23826-06	February 2013	<p>Following are the updates specific to this release:</p> <ul style="list-style-type: none"> <li>• IPv6 over MPLS—Enables the service providers running an MPLS/IPv4 infrastructure to offer IPv6 services without any major changes in the infrastructure, see <a href="#">IPv6 over MPLS: 6PE and 6VPE, page 1</a> for more information.</li> <li>• Remote Loop-Free Alternate—provides local protection for unicast traffic in pure IP and MPLS networks, see <a href="#">Remote Loop-Free Alternate - Fast Reroute, page 1</a> for more information.</li> <li>• MPLS over MLPPP —Allows you to use labeled switch paths (LSPs) over MLPPP links, see <a href="#">Configuring MLPPP, page 1</a> for more information.</li> <li>• Zero Touch Provisioning—Enables the ASR 901 router to auto configure itself, download an updated image, connect to the network, and start the operation as soon as it is cabled and powered up, see <a href="#">Managing and Monitoring Network Management Features, page 1</a> for more information.</li> <li>• Digital Optical Monitoring—Support for Digital Optical Monitoring (DOM) for Gig Optics on ASR 901, see <a href="#">Digital Optical Monitoring, page 1</a> for more information.</li> <li>• BC Licensing—Supports for Precision Time Protocol (PTP) Boundary Clock (BC) is introduced on the ASR 901 routers. ADVANCED TIMING(1588BC) license should be installed to use the BC feature, see <a href="#">Licensing, page 1</a> for more information.</li> <li>• 1588V2 Boundary Clock—Supports for Precision Time Protocol (PTP) Boundary Clock (BC) is introduced on the ASR 901 routers, see <a href="#">Configuring Clocking, page 1</a> for more information.</li> </ul>

Document Number	Date	Change Summary
OL-23826-07	March 2013	<ul style="list-style-type: none"> <li>• Configuring Y.1564 to Generate Ethernet Traffic—Y.1564 is an Ethernet service activation or performance test methodology for turning up, installing, and troubleshooting Ethernet-based services. This test methodology allows for complete validation of Ethernet service-level agreements (SLAs) in a single test. Using traffic generator performance profile, you can create the traffic based on your requirements. The network performance like throughput, loss, and availability are analyzed using Layer 2 traffic with various bandwidth profiles.</li> <li>• Ethernet Synthetic Loss Measurement in Y.1731—Allows to measure the Frame Loss Ratio (FLR) in the network, that is, the ratio of frames lost to frames sent, using synthetic frames.</li> <li>• EVC Default Encapsulation for QinQ and Xconnect—Supports EVC default encapsulation on the Cisco ASR 901 router. This feature matches and forwards all the ingress traffic on the port. The default service instance on a port is configured using the encapsulation default command.</li> <li>• Hot Standby Pseudowire Support for ATM and TDM Access Circuits—Improves the availability of pseudowires by detecting failures and handling them with minimal disruption to the service. This feature allows the backup pseudowire to be in a “hot standby” state, so that it can immediately take over if the primary pseudowire fails.</li> <li>• Microwave ACM Signaling and EEM Integration—Enables the microwave radio transceivers to report link bandwidth information to an upstream Ethernet switch and take action on the signal degradation to provide optimal bandwidth.</li> <li>• Multi-UNI CFM MEPs in the Same VPN—Services are configured such that two or more bridge domains (BDs) are used to achieve UNI isolation and backhauling towards provider edge (PE) device. Local MEPs (with up direction) need to be configured on the UNIs (with the associated BDs) to monitor the service backhaul connection.</li> <li>• OSPFv3 MIBs—The OSPFV3-MIB is supported from Cisco IOS Release 15.3(2)S onwards. This MIB module is for OSPF version 3.</li> <li>• Remote Loop-Free Alternate - Fast Reroute for EoMPLS—The Remote Loop-Free Alternate - Fast Reroute for EoMPLS feature is introduced.</li> </ul>

Document Number	Date	Change Summary
		<ul style="list-style-type: none"> <li>• TCAM in Cisco ASR 901 Router—Effective with Cisco IOS Release 15.3(2)S, the Ternary Content Addressable Memory (TCAM) is allocated and deallocated dynamically, which improves both feature scalability and the efficiency of usage of TCAM.</li> <li>• Traffic Engineering - Fast Reroute for EoMPLS—The Traffic Engineering - Fast Reroute for EoMPLS feature is introduced.</li> <li>• Y.1731 Performance Monitoring—Provides standards-based Ethernet performance monitoring as outlined in the ITU-T Y-1731 specification and interpreted by the Metro Ethernet Forum (MEF).</li> <li>• Combo Port Media Type Select—Starting with Cisco IOS Release 15.3(2)S, the Cisco ASR 901 router supports selection of combo ports as the media type. A combo port is considered as a single interface with dual front ends (an RJ-45 connector and an SFP module connector).</li> <li>• Configurable MTU on Physical Interface—Starting with Cisco IOS Release 15.3(2)S, the Cisco ASR 901 router supports modification of MTU size on physical interface.</li> <li>• Disabling MAC Address Learning on an Interface or Bridge Domain—Starting with Cisco IOS Release 15.3(2)S, you can control MAC address learning on an interface or VLAN to manage the available MAC address table space by controlling which interfaces or VLANs can learn MAC addresses.</li> <li>• Layer 3 Ping in Customer EVC—Starting with Cisco IOS Release 15.3(2)S, pop 2 configuration is supported on layer 2 and layer 3 operations. Additionally, it is supported on GigabitEthernet and port channel interfaces.</li> <li>• Sub-second Link OAM Timers—Starting with Cisco IOS Release 15.3(2)S, the Cisco ASR 901 router supports sub-second OAM timers.</li> </ul>

Document Number	Date	Change Summary
OL-23826-08	July 2013	<ul style="list-style-type: none"> <li>• <b>Autonomic Networking</b>—Autonomic networking is supported from Cisco IOS Release 15.3(2)S onwards. It makes devices more intelligent and simplifies the interface between the operator and Network Management System (NMS) system, by providing a strong abstraction across the network, distributed on each device. It also automatically provides all relevant best practices, and keeps them up to date, without the need for human intervention.</li> <li>• <b>Storm Control</b>—The Storm Control feature prevents traffic on a LAN from being disrupted by a broadcast, multicast, or unknown unicast storm on one of a port.</li> <li>• <b>Egress Policing</b>—Egress policing can be classified based on QoS-groups, DSCP, and precedence value. For QoS-groups to work at egress, you should map the traffic at ingress to a specific QoS-group value.</li> <li>• <b>MPLS Traffic Engineering (TE)—Fast Reroute (FRR) Link Protection</b>—Support for CESoPSN, SAToP, and ATM/IMA was added from Cisco IOS Release 15.3(3)S onwards.</li> <li>• <b>Multiaction Ingress Policer on EVC</b>—Effective with Cisco IOS Release 15.3(3)S, the Cisco ASR 901 supports policing ingress traffic over the cross connect EVC, similar to bridge domain service policy.</li> <li>• <b>Y.1731 Performance Monitoring</b>—Effective with Cisco IOS Release 15.3(3)S, the Cisco ASR 901 router supports ITU-T Y.1731 performance monitoring on the following interfaces: <ul style="list-style-type: none"> <li>– SLM support on the EVC cross connect</li> <li>– SLM support on the Port-Channel EVC cross connect</li> <li>– DMM and SLM support on the EVC BD for both the up and down MEPs</li> <li>– SLM support on the EVC cross connect for both the up and down MEPs</li> </ul> </li> <li>• <b>RFC 3107 Labeled BGP Support for TDM Pseudowire</b>—The RFC 3105 labeled BGP is supported for TDM pseudowire from Cisco IOS Release 15.3(3)S onwards.</li> <li>• <b>Support for Digital Optical Monitoring (DOM) for 10 Gig Optics</b>—Effective with Cisco IOS Release 15.3(3)S, Cisco ASR 901 supports DOM for both 1G and 10G SFPs.</li> </ul>

Document Number	Date	Change Summary
OL-23826-09	November 2013	<ul style="list-style-type: none"> <li>• 1588v2 Hybrid Clock—To improve the clock quality, you can either improve the oscillator class or reduce the number of hops between the master and the slave. In PTP hybrid mode, the oscillator class is improved by using a physical layer clock (sourced from a stratum-1 clock) instead of the available internal oscillator. The PTP hybrid mode is supported for ordinary clock (in slave mode only) and boundary clock.</li> <li>• Dual REP Edge No-Neighbor—Effective with Cisco IOS release 15.4.(1)S, you can configure the non-REP switch facing ports on a single device as dual edge no-neighbor ports. These ports inherit all properties of edge ports, and overcome the limitation of not converging quickly during a failure.</li> <li>• EoMPLS/TDM Pseudowire Redundancy over FRR—Effective with Cisco IOS Release 15.4(1)S, support was added for EoMPLS/TDM pseudowire redundancy over FRR.</li> <li>• Ethernet loopback (NOSTG CLI and terminal loopback )—Effective with Cisco IOS Release 15.4(1)S, the Cisco ASR 901 supports internal loopback on Bridge-domain EFPs.</li> <li>• IPv4 Multicast—Describes how to configure IP multicast in an IPv4 network. IP multicast is an efficient way to use network resources, especially for bandwidth-intensive services such as audio and video.</li> <li>• IPv6 Multicast—Describes how to configure basic IP multicast in an IPv6 network.</li> <li>• Extending QoS over MLPPP Interface—Effective with Cisco IOS Release 15.4(1)S, the QoS functionality on the MLPPP interface is extended to support: <ul style="list-style-type: none"> <li>– QoS for MPLS over MLPPP</li> <li>– QoS for CPU generated traffic</li> </ul> </li> <li>• Redundant PTP instances as per G.8265.1—PTP redundancy is an implementation on different clock nodes by which the PTP slave clock node interacts with multiple master ports such as grand master, boundary clock nodes, and so on. A new servo mode is defined under PTP to support high PDV scenarios (when the PDVs exceed G.8261 standard profiles).</li> </ul>

Document Number	Date	Change Summary
		<ul style="list-style-type: none"> <li>• REP over LAG—Effective with Cisco IOS Release 15.4(1)S, the Cisco ASR 901 supports REP over port-channel.</li> <li>• Switched Port Analyzer (SPAN)—Effective with Cisco IOS Release 15.4(1)S, the Cisco ASR 901 supports Local SPAN. Local SPAN supports a SPAN session entirely within one switch. You can analyze network traffic passing through ports or VLANs by using SPAN to send a copy of the traffic to another port on the switch that has been connected to a network analyzer or other monitoring or security devices. SPAN copies (or mirrors) traffic received or sent (or both) on source ports to a destination port for analysis.</li> <li>• Y.1564 over EVC CrossConnect—Effective with Cisco IOS release 15.4.(01)S, traffic can be generated over cross connect interface. Figure 10-3 shows the Traffic Generator topology over cross connect describing the traffic flow in the external and internal modes.</li> </ul>

## Objectives

This guide explains how to configure software features on the Cisco ASR 901-TDM version and Cisco ASR 901-Ethernet version routers. Unless otherwise stated, the features described in this guide apply to both the routers.

## Audience

This guide is for the person responsible for configuring the router. This guide is intended for the following audiences:

- Customers with technical networking background and experience.
- System administrators who are familiar with the fundamentals of router-based internetworking, but who may not be familiar with Cisco IOS software.
- System administrators who are responsible for installing and configuring internetworking equipment, and who are familiar with Cisco IOS software.

## Organization

The major sections of this software configuration guide are listed in the following table:

Chapter	Description
<a href="#">Chapter 1, “Cisco ASR 901 Router Overview”</a>	Provides an overview of the Cisco ASR 901 router.
<a href="#">Chapter 2, “Licensing”</a>	Describes the licensing aspects of the router.

<b>Chapter</b>	<b>Description</b>
Chapter 3, “First-Time Configuration”	Describes the first time configuration of the router.
Chapter 4, “Managing and Monitoring Network Management Features”	Describes how to monitor, manage and deploy a variety of network management features.
Chapter 5, “Using the Command-Line Interface”	Describes the CLI of the router.
Chapter 6, “Software Upgrade”	Describes how to upgrade the Cisco IOS image on the router.
Chapter 7, “Configuring Gigabit Ethernet Interfaces”	Describes how to configure gigabit ethernet interfaces on the router.
Chapter 8, “Configuring Ethernet Virtual Connections”	Describes how to configure EVCs on the router.
Chapter 9, “Configuring EtherChannels”	Describes how to configure EtherChannels on the router.
Chapter 10, “Configuring Ethernet OAM”	Describes how to configure ethernet OAM on the router.
Chapter 11, “ITU-T Y.1731 Performance Monitoring”	Displays information on the ITU-T Y.1731 Performance Monitoring for the Cisco ASR 901 Series Aggregation Services Router.
Chapter 12, “Configuring Resilient Ethernet Protocol”	Describes how to configure REP on the router.
Chapter 13, “Configuring MST on EVC Bridge Domain”	Describes how to configure MSTP on the router.
Chapter 14, “Configuring Multiprotocol Label Switching”	Describes how to configure MPLS on the router.
Chapter 15, “Configuring EoMPLS”	Describes how to configure EoMPLS on the router.
Chapter 16, “Configuring MPLS VPNs”	Describes how to configure MPLS VPNs on the router.
Chapter 17, “Configuring MPLS OAM”	Describes how to configure MPLS OAM on the router.
Chapter 18, “Configuring Routing Protocols”	Describes how to configure the routing protocols on the router.
Chapter 19, “Configuring Bidirectional Forwarding Detection”	Describes how to configure BFD on the router.
Chapter 20, “Configuring T1/E1 Controllers”	Describes how to configure T1/E1 controllers on the router.



Chapter	Description
Chapter 21, “Configuring Pseudowire”	Describes how to configure pseudowire on the router.
Chapter 22, “Configuring Clocking”	Describes how to configure clocking on the router.
Chapter 23, “Cisco IOS IP SLA”	Describes the IPSLA aspects of the router.
Chapter 24, “Configuring QoS”	Describes how to configure QoS on the router.
Chapter 25, “Configuring MLPPP”	Describes how to configure MLPPP on the router.
Chapter 26, “Onboard Failure Logging”	Describes how to configure OBFL on the router.
Chapter 27, “Hot Standby Router Protocol and Virtual Router Redundancy Protocol”	Describes how to configure HSRP and VSRP.
Chapter 28, “Configuring Link Layer Discovery Protocol”	Describes how to configure LLDP.
Chapter 29, “Configuring Multihop Bidirectional Forwarding Detection”	Describes how to configure multihop BFD
Chapter 30, “Bit Error Rate Testing”	Describes how to configure Bit Error Rate testing.
Chapter 31, “Microwave ACM Signaling and EEM Integration”	Describes how the Microwave Adaptive Code Modulation (ACM) Signaling and Embedded Event Manager (EEM) integration that enables the microwave radio transceivers to report link bandwidth information to an upstream Ethernet switch and take action on the signal degradation to provide optimal bandwidth.
Chapter 32, “IPv6 Support on the Cisco ASR 901 Router”	Describes how to support Long Term Evolution (LTE) rollouts that provides high-bandwidth data connection for mobile wireless devices.
Chapter 33, “Labeled BGP Support”	Describes how to add label mapping information to the Border Gateway Protocol
Chapter 34, “MPLS Traffic Engineering - Fast Reroute Link Protection”	Describes how to add Fast Reroute (FRR) link protection and Bidirectional Forwarding Detection (BFD)-triggered FRR feature of Multiprotocol Label Switching (MPLS) traffic engineering (TE).
Chapter 35, “Layer 2 Control Protocol Peering, Forwarding, and Tunneling”	Describes how to configure Layer 2 (L2) Control Protocol Peering, Forwarding, and Tunneling feature on the Cisco ASR 901 Series Aggregation Services Routers.
Chapter 36, “Configuring Inverse Multiplexing over ATM”	Describes how to configure Inverse Multiplexing over ATM (IMA) technology that is used to transport ATM traffic over a bundle of T1 or E1 cables, known as IMA group in the Cisco ASR 901 Series Aggregation Services Routers.

Chapter	Description
<a href="#">Chapter 37, “IPv6 over MPLS: 6PE and 6VPE”</a>	Describes how to implement IPv6 VPN Provider Edge Transport over MPLS (IPv6 on Provider Edge Routers [6PE] and IPv6 on ASR 901.
<a href="#">Chapter 38, “Storm Control”</a>	Describes how to monitor the incoming broadcast, multicast, and unknown unicast packets and prevent them from flooding the LAN ports.
<a href="#">Chapter 39, “Remote Loop-Free Alternate - Fast Reroute”</a>	Describes the Remote Loop-free Alternate (LFA) - Fast Reroute (FRR) feature that uses a backup route, computed using dynamic routing protocol during a node failure, to avoid traffic loss.
<a href="#">Chapter 40, “Digital Optical Monitoring”</a>	Provides information on the digital optical monitoring (DOM) feature for the Cisco ASR 901 Series Aggregation Services Router.
<a href="#">Chapter 41, “Autonomic Networking Infrastructure”</a>	Describes how the Autonomic Networking Infrastructure feature makes new and unconfigured devices securely reachable by an operator or network management system.
<a href="#">Chapter 41, “IPv4 Multicast”</a>	Describes how to configure IP multicast in an IPv4 network.
<a href="#">Chapter 42, “IPv6 Multicast”</a>	Describes how to configure basic IP multicast in an IPv6 network.
<a href="#">Chapter 43, “Configuring Switched Port Analyzer”</a>	Describes how to configure a switched port analyzer (SPAN) on the Cisco ASR 901 Router.

## Conventions

This publication uses the following conventions to convey instructions and information.

Convention	Description
<b>boldface font</b>	Commands and keywords.
<i>italic font</i>	Variables for which you supply values.
[ ]	Keywords or arguments that appear within square brackets are optional.
{ x   y   z }	A choice of required keywords appears in braces separated by vertical bars. You must select one.
screen font	Examples of information displayed on the screen.
<b>boldface screen font</b>	Examples of information the user enters.
< >	Nonprinting characters, for example passwords, appear in angle brackets.
[ ]	Default responses to system prompts appear in square brackets.



### Note

Means *reader take note*. Notes contain helpful suggestions or references to material not covered in the manual.



### Timesaver

Means *the described action saves time*.

**Tip**

---

Means *the following information will help you solve a problem*. The tips information might not be troubleshooting or even an action, but could be useful information, similar to a Timesaver.

---

**Caution**

---

Means *reader be careful*. In this situation, you might do something that could result in equipment damage or loss of data.

---

## Related Documentation

The following list includes documentation related to your product by implementation.

- Cisco ASR 901 Series Aggregation Services Router Documents
  - *Cisco ASR 901 Series Aggregation Services Router Command Reference*
  - *Cisco ASR 901 Series Aggregation Services Router Hardware Installation Guide*
  - *Cisco Regulatory Compliance and Safety Information for Cisco ASR 901 Series Aggregation Services Router*
- Release Notes
  - *Release Notes for Cisco ASR 901 Series Aggregation Services Router*

To access the related documentation on Cisco.com, go to:

[http://www.cisco.com/en/US/partner/products/ps12077/tsd\\_products\\_support\\_series\\_home.html](http://www.cisco.com/en/US/partner/products/ps12077/tsd_products_support_series_home.html)

**Note**

---

To obtain the latest information, access the online documentation.

---

## Obtaining Documentation, Obtaining Support, and Security Guidelines

For information on obtaining documentation, obtaining support, providing documentation feedback, security guidelines, and also recommended aliases and general Cisco documents, see the monthly *What's New in Cisco Product Documentation*, which also lists all new and revised Cisco technical documentation, at:

<http://www.cisco.com/en/US/docs/general/whatsnew/whatsnew.html>





# Cisco ASR 901 Router Overview

---

Cisco ASR 901 Mobile Wireless Router is a cell-site access platform specifically designed to aggregate and transport mixed-generation radio access network (RAN) traffic. The router is used at the cell site edge as a part of a 2G, 3G, or 4G radio access network (RAN). The Cisco ASR 901 is available in the following models:

- Cisco ASR 901-TDM version (A901-12C-FT-D, A901-4C-FT-D, A901-6CZ-FT-D, A901-6CZ-FT-A)
- Cisco ASR 901-Ethernet version (A901-12C-F-D, A901-4C-F-D, A901-6CZ-F-D, A901-6CZ-F-A)

The Cisco ASR 901 router helps enable a variety of RAN solutions by extending IP connectivity to devices using Global System for Mobile Communications (GSM), General Packet Radio Service (GPRS), Node Bs using HSPA or LTE, Base Transceiver Stations (BTSS) using Enhanced Data Rates for GSM Evolution (EDGE), Code Division Multiple Access (CDMA), CDMA-2000, EVDO, or WiMAX, and other cell-site equipment.

The Cisco ASR 901 router transparently and efficiently transports cell-site voice, data, and signaling traffic over IP using traditional T1/E1 circuits, including leased line, microwave, and satellite. It also supports alternative backhaul networks, including Carrier Ethernet and Ethernet in the First Mile (EFM).

The Cisco ASR 901 router also supports standards-based Internet Engineering Task Force (IETF) Internet protocols over the RAN transport network, including those standardized at the Third-Generation Partnership Project (3GPP) for IP RAN transport.

Custom designed for the cell site, the Cisco ASR 901 features a small form factor, extended operating temperature, and cell-site DC input voltages.

The Cisco ASR 901 TDM version provides 12 Gigabit Ethernet ports, 16 T1/E1 ports and one Management port. Whereas, the Cisco ASR 901 Ethernet version does not contain the 16 T1/E1 ports. It has only 12 Gigabit Ethernet ports and one management port.

The Cisco ASR 901 router supports Ethernet Virtual Circuits (EVC) only. Metro-Ethernet Forum (MEF) defines an Ethernet Virtual Connection as an association between two or more user network interfaces identifying a point-to-point or multipoint-to-multipoint path within the service provider network. An EVC is a conceptual *service pipe* within the service provider network.

For more information on EVCs, see [Configuring Ethernet Virtual Connections, page 8-1](#).

# Introduction

A RAN is typically composed of thousands of BTSs or Node Bs, hundreds of base station controllers or radio network controllers (BSCs or RNCs), and several mobile switching centers (MSCs). The BTS or Node Bs and BSC or RNC are often separated by large geographic distances, with the BTSs or Node Bs located in cell sites uniformly distributed throughout a region, and the BSCs, RNCs, and MSCs located at suitably chosen Central Offices (CO) or mobile telephone switching offices (MTSO).

The traffic generated by a BTS or Node B is transported to the corresponding BSC or RNC across a network, referred to as the backhaul network, which is often a hub-and-spoke topology with hundreds of BTS or Node Bs connected to a BSC or RNC by point-to-point time division multiplexing (TDM) trunks. These TDM trunks may be leased-line T1/E1s or their logical equivalents, such as microwave links or satellite channels.

The Cisco ASR 901 has two different types of interfaces by default: network node interfaces (NNIs) to connect to the service provider network and user network interfaces (UNIs) to connect to customer networks. Some features are supported only on one of these port types. You can also configure enhanced network interfaces (ENIs). An ENI is typically a user-network facing interface and has the same default configuration and functionality as UNIs, but can be configured to support protocol control packets for Cisco Discovery Protocol (CDP), Spanning-Tree Protocol (STP), EtherChannel Link Aggregation Control Protocol (LACP).

## Features

This section contains the following topics:

- [Performance Features, page 1-2](#)
- [Management Options, page 1-3](#)
- [Manageability Features, page 1-3](#)
- [Security Features, page 1-4](#)
- [Quality of Service and Class of Service Features, page 1-4](#)
- [Layer 3 Features, page 1-5](#)
- [Layer 3 VPN Services, page 1-5](#)
- [Monitoring Features, page 1-5](#)

## Performance Features

- Autosensing of port speed and autonegotiation of duplex mode on all ports for optimizing bandwidth.
- Automatic-medium-dependent interface crossover (auto-MDIX) capability on 100 and 100/1000 Mbps interfaces and on 100/1000 BASE-T/TX small form-factor pluggable (SFP) module interfaces that enables the interface to automatically detect the required cable connection type (straight-through or crossover) and to configure the connection appropriately.
- EtherChannel for enhanced fault tolerance and for providing up to 8 Gbps (Gigabit EtherChannel) or 800 Mbps (Fast EtherChannel) full duplex of bandwidth between switches, routers, and servers.
- Link Aggregation Control Protocol (LACP) for automatic creation of EtherChannel links (supported only on NNIs or ENIs).

- Forwarding of Layer 2 and Layer 3 packets at Gigabit line rate.

## Management Options

- CLI—You can access the CLI either by connecting your management station directly to the router console port or by using Telnet from a remote management station. For more information about the CLI, see [Chapter 5, “Using the Command-Line Interface.”](#)
- Cisco Configuration Engine—The Cisco Configuration Engine is a network management device that works with embedded Cisco IOS CNS Agents in the Cisco ASR 901 Series Aggregation Services Router software. You can automate initial configurations and configuration updates by generating router-specific configuration changes, sending them to the router, executing the configuration change, and logging the results.
- SNMP—SNMP management applications such as CiscoWorks2000 LAN Management Suite (LMS) and HP OpenView. You can manage from an SNMP-compatible management station that is running platforms such as HP OpenView or SunNet Manager.

For information about configuring SNMP, see

[http://www.cisco.com/en/US/docs/ios/12\\_2/configfun/configuration/guide/fc014.html](http://www.cisco.com/en/US/docs/ios/12_2/configfun/configuration/guide/fc014.html).

For the list of MIBs that Cisco ASR 901 router supports, see the Release Notes for Cisco ASR 901 router.

## Manageability Features

- Address Resolution Protocol (ARP) for identifying a router through its IP address and its corresponding MAC address
- Cisco Discovery Protocol (CDP) Versions 1 and 2 for network topology discovery and mapping between the router and other Cisco devices on the network (supported on NNIs by default, can be enabled on ENIs, not supported on UNIs)
- Network Time Protocol (NTP) for providing a consistent time stamp to all routers from an external source
- Cisco IOS File System (IFS) for providing a single interface to all file systems that the Cisco ASR 901 Series Aggregation Services Router uses.
- In-band management access for up to 5 simultaneous Telnet connections for multiple CLI-based sessions over the network. Effective with Cisco IOS Release 15.3(2)S1, in-band management access for up to 98 simultaneous Telnet connections for multiple CLI-based sessions over the network.
- In-band management access for up to five simultaneous, encrypted Secure Shell (SSH) connections for multiple CLI-based sessions over the network.
- In-band management access through SNMP Versions 1 and 2c get and set requests.
- Out-of-band management access through the router console port to a directly attached terminal or to a remote terminal through a serial connection or a modem
- User-defined command macros for creating custom router configurations for simplified deployment across multiple routers
- Support for metro Ethernet operation, administration, and maintenance (OAM) IEEE 802.1ag Connectivity Fault Management (CFM), Ethernet Line Management Interface (E-LMI) on customer-edge and provider-edge devices, and IEEE 802.3ah Ethernet OAM discovery, link

monitoring, remote fault detection, and remote loopback, and IEEE 802.3ah Ethernet OAM discovery, link monitoring, remote fault detection, and remote loopback (requires the metro IP access or metro access image)

- Configuration replacement and rollback to replace the running configuration on a router with any saved Cisco IOS configuration file
- CPU utilization threshold logs.

## Security Features

- Password-protected access (read-only and read-write access) to management interfaces for protection against unauthorized configuration changes
- Configuration file security so that only authenticated and authorized users have access to the configuration file, preventing users from accessing the configuration file by using the password recovery process
- Multilevel security for a choice of security level, notification, and resulting actions
- Automatic control-plane protection to protect the CPU from accidental or malicious overload due to Layer 2 control traffic on UNIs or ENIs
- TACACS+, a proprietary feature for managing network security through a TACACS server
- RADIUS for verifying the identity of, granting access to, and tracking the actions of remote users through authentication, authorization, and accounting (AAA) services
- Extended IP access control lists for defining security policies in the inbound direction on physical ports.
- Extended IP access control lists for defining security policies in the inbound and outbound direction on SVIs.

## Quality of Service and Class of Service Features

- Configurable control-plane queue assignment to assign control plane traffic for CPU-generated traffic to a specific egress queue.
- Cisco modular quality of service (QoS) command-line (MQC) implementation
- Classification based on IP precedence, Differentiated Services Code Point (DSCP), and IEEE 802.1p class of service (CoS) packet fields, or assigning a QoS label for output classification
- Policing
  - One-rate policing based on average rate and burst rate for a policer
  - Two-color policing that allows different actions for packets that conform to or exceed the rate
  - Aggregate policing for policers shared by multiple traffic classes
- Table maps for mapping CoS, and IP precedence values
- Queuing and Scheduling
  - Class-based traffic shaping to specify a maximum permitted average rate for a traffic class
  - Port shaping to specify the maximum permitted average rate for a port
  - Class-based weighted queuing (CBWFQ) to control bandwidth to a traffic class
  - Low-latency priority queuing to allow preferential treatment to certain traffic



- Per-port, per-VLAN QoS to control traffic carried on a user-specified VLAN for a given interface.

## Layer 3 Features

- IP routing protocols for load balancing and for constructing scalable, routed backbones:
  - OSPF
  - BGP Version 4
  - IS-IS dynamic routing
  - BFD protocol Bidirectional Forwarding Detection (BFD) Protocol to detect forwarding-path failures for OSPF, IS-IS, and BGP routing protocols
- IP routing between VLANs (inter-VLAN routing) for full Layer 3 routing between two or more VLANs, allowing each VLAN to maintain its own autonomous data-link domain
- Static IP routing for manually building a routing table of network path information
- Equal-cost routing for load balancing and redundancy
- Internet Control Message Protocol (ICMP) and ICMP Router Discovery Protocol (IRDP) for using router advertisement and router solicitation messages to discover the addresses of routers on directly attached subnets

## Layer 3 VPN Services

These features are available only when the Cisco ASR 901 router is running the Advance Metro IP services.

- Multiple VPN routing/forwarding (multi-VRF) instances in customer edge devices (multi-VRF CE) to allow service providers to support multiple virtual private networks (VPNs) and overlap IP addresses between VPNs
- MPLS VPN is supported.

## Monitoring Features

- Router LEDs that provide port- and router-level status
- Syslog facility for logging system messages about authentication or authorization errors, resource issues, and time-out events
- Enhanced object tracking for HSRP clients (requires metro IP access image)
- IP Service Level Agreements (IP SLAs) support to measure network performance by using active traffic monitoring (requires metro IP access or metro access image)
- IP SLAs EOT to use the output from IP SLAs tracking operations triggered by an action such as latency, jitter, or packet loss for a standby router failover takeover (requires metro IP access or metro access image)
- EOT and IP SLAs EOT static route support to identify when a preconfigured static route or a DHCP route goes down (requires metro IP access or metro access image)
- Embedded event manager (EEM) for device and system management to monitor key system events and then act on them through a policy (requires metro IP access or metro access image)





# Licensing

---

This feature module describes the licensing aspects of the Cisco ASR 901 Series Aggregation Services Router.

## Finding Feature Information

Your software release may not support all the features documented in this module. For the latest feature information and caveats, see the release notes for your platform and software release. To find information about the features documented in this module, and to see a list of the releases in which each feature is supported, see the [“Feature Information for Licensing” section on page 2-17](#).

Use Cisco Feature Navigator to find information about platform support and Cisco software image support. To access Cisco Feature Navigator, go to <http://www.cisco.com/go/cfn>. An account on Cisco.com is not required.

## Contents

- [Feature Overview, page 2-2](#)
- [Licenses Supported on Cisco ASR 901 Router, page 2-2](#)
- [License Types, page 2-4](#)
- [Port or Interface Behavior, page 2-5](#)
- [Generating the License, page 2-11](#)
- [Installing the License, page 2-11](#)
- [Changing the License, page 2-12](#)
- [Return Materials Authorization License Process, page 2-13](#)
- [Verifying the License, page 2-14](#)
- [Where to Go Next, page 2-14](#)
- [Additional References, page 2-15](#)
- [Feature Information for Licensing, page 2-17](#)

## Feature Overview

The Cisco ASR 901 router license is similar to any other software license in Cisco. It is tied to the Unique Device Identifier (UDI)—where the license is integrated to the PID (Product Identifier) and SN (Serial Number). A license generated for one router cannot be shared or installed in any other router.

Complete these steps to obtain the license file:

1. Purchase the required Product Authorization Key (PAK).
2. Get the UDI from the device.
3. Enter the UDI and PAK in the Cisco's licensing portal.  
You will receive a license file through email.
4. Install the licenses on the device. For more information on how to install the license, see [Installing the License, page 2-11](#).

In addition to using the router CLI, you can install the license using the Cisco License Manager (CLM) or the Callhome interface.

## Licenses Supported on Cisco ASR 901 Router

The following licenses are supported:

Sl.No.	Chassis PID	License PID	License Description	License Type (Image or Feature)
1	A901-12C-FT-D A901-12C-F-D A901-4C-FT-D A901-4C-F-D A901-6CZ-FT-A A901-6CZ-FT-D A901-6CZ-F-A A901-6CZ-F-D	SL-A901-A	AdvancedMetroIP Access	Image
2	A901-12C-F-D A901-12C-FT-D A901-4C-FT-D A901-4C-F-D A901-6CZ-FT-A A901-6CZ-FT-D A901-6CZ-F-A A901-6CZ-F-D	SL-A901-B	IPBase	Image (by default gets enabled)

SI.No.	Chassis PID	License PID	License Description	License Type (Image or Feature)
3	A901-4C-FT-D A901-4C-F-D	FLS-A901-4S FLS-A901-4S= <sup>1</sup> L-FLS-A901-4S= <sup>1</sup>	Gige4SfpUpgrade	Feature
4	A901-4C-FT-D A901-4C-F-D	FLS-A901-4T FLS-A901-4T= <sup>1</sup> L-FLS-A901-4T= <sup>1</sup>	Gige4CuUpgrade	Feature
5	A901-6CZ-FT-A A901-6CZ-FT-D A901-6CZ-F-A A901-6CZ-F-D	FLS-A901-2Z FLS-A901-2Z= <sup>1</sup> L-FLS-A901-2Z= <sup>1</sup>	10gigUpgrade	Feature
6	A901-6CZ-FT-A A901-6CZ-FT-D A901-6CZ-F-A A901-6CZ-F-D	FLS-A901-4 FLS-A901-4= <sup>1</sup> L-FLS-A901-4= <sup>1</sup>	Gige4portflexi	Feature
7	A901-12C-FT-D A901-12C-F-D A901-4C-FT-D A901-4C-F-D A901-6CZ-FT-A A901-6CZ-FT-D A901-6CZ-F-A A901-6CZ-F-D	SL-A901-T	1588BC	Feature

<sup>1</sup> = variants are spares or represent the e-paper form.

The Cisco ASR 901 software uses the license description to resolve errors related to license availability. You need to map the proper license PID as per the table above and purchase the licenses. The Cisco ASR 901 router supports permanent licenses only.

You should install only a supported license for the proper chassis PID. You will get a “Not Supported” message while trying to install a wrong license. However, license installation process will go through and a confirmation message is displayed. When you run the **show license** command to display the details of this license, the output shows license state as “NOT IN USE”, and you cannot make it “IN USE”.

The following is a sample confirmation message that is displayed on the router when you try to install a wrong license.

```
Install FLS-A901-4S license on A901-6CZ-F-A (10g) boards,
10G-Router#license install flash:CAT1625U0EP_201307231358341640.lic
Installing licenses from "flash:CAT1625U0EP_201307231358341640.lic"
Installing...Feature:Gige4SfpUpgrade...Successful:Not Supported
1/1 licenses were successfully installed
0/1 licenses were existing licenses
0/1 licenses were failed to install
```

# License Types

Cisco ASR 901 router supports the following types of licenses:

- Image Level License
- Feature Based License

## Image Level License

An Image level license corresponds to the level of the IOS image that comes up based on the licenses present on the router. This license is enforced while booting and it uses a universal image. It activates all the subsystems corresponding to the license that you purchased. Image based licenses (SL-A901-A and SL-A901-B) need rebooting of the router.

## Features Supported

In Cisco ASR 901, IPBase (SL-A901-B) and AdvancedMetroIPAccess (SL-A901-A) are permanent; once installed they do not expire. Trial or temporary licenses are not supported on the Cisco ASR 901 router.

License	Features
IPBase / SL-A901-B	<ul style="list-style-type: none"> <li>• L2, EVC, 802.1Q, 802.1ad, QinQ, 802.3ah, H-Qos, IPv4 static routes, routing protocols, host connectivity, ACL, REP, VRF-Lite</li> <li>• E-OAM—CFM (BD, port level), IPSLA (barring LSP)</li> <li>• Clocking—SyncE, 1588-OC Slave, 10M, 1PPS/ToD, G.781 Priority based Clock Selection (no ESMC/SSM)</li> </ul> <p><b>Note</b> Time-division multiplexing (TDM) is unavailable.</p>
AdvancedMetroIPAccess / SL-A901-A	<ul style="list-style-type: none"> <li>• All IPBase license features</li> <li>• MPLS—MPLS, L2VPN (EoMPLS), L3VPN, MPLS OAM, PW redundancy</li> <li>• E-OAM—IPSLA(LSP)</li> <li>• TDM —IPoPPP/HDLC, QoS, CESoPSNoMPLS, PPP/HDLCoMPLS, Clock Recovery from TDM interfaces, Y.1731PM</li> </ul>

## Feature Based License

Feature based licenses are licenses used to activate individual features once the image level licenses are used. Once the image level license is used and the appropriate subsystems are activated. Individual feature licenses are used to activate individual features. These include:

- Port based license

- Port mode license
- 1588BC license

**Note**

Copper (FLS-A901-4T), SFP (SL-A901-B), and 1588BC (SL-A901-T) licenses are feature-based licenses. Once they are installed, the licenses become active and there is no need to reboot the router.

## Port Based/Mode License

The following table lists the port number, type, and the required license for those ports:

Port Number	Port Type	Chassis PID	License Required
0-3	Copper	A901-4C-FT-D A901-4C-F-D	FLS-A901-4T
4-7	Combo		No license is required. These ports are enabled by default.
8-11	Small Form-Factor Pluggable(SFP)	A901-4C-FT-D A901-4C-F-D	FLS-A901-4S
0-3 and 8-11	Copper and Combo	A901-6CZ-FT-A A901-6CZ-FT-D A901-6CZ-F-A A901-6CZ-F-D	FLS-A901-4
TenGig0/1, TenGig0/2	SFP+	A901-6CZ-FT-A A901-6CZ-FT-D A901-6CZ-F-A A901-6CZ-F-D	FLS-A901-2Z

By default, ports 4 to 7 are enabled on the router. When you purchase the copper or SFP port license, the corresponding ports are only enabled. Copper and SFP port licenses can co-exist.

## 1588BC License

1588BC (SL-A901-T) license is a feature based license. This license does not need rebooting of the router for activation. The following table lists the features supported

License	Features
1588BC / SL-A901-T	Clocking—1588V2 PTP boundary clock

## Port or Interface Behavior

The following sections describe the port or interface behavior of the licenses:

- [Port Based License, page 2-6](#)
- [10GigUpgrade License, page 2-7](#)
- [Flexi License, page 2-8](#)
- [1588BC License, page 2-9](#)

## Port Based License

When a port based license is not present, ports 4 to 7 are enabled. Ports 0 to 3, and ports 8 to 11 are disabled. This is the expected behavior. Interfaces that are disabled are in the administrative down state.

### Example: When Port Based License is not Installed

The following error message appears when the port based license is not installed and you use the **no shutdown** command on the interface:

```
Router# show ip interface brief
Interface                IP-Address      OK? Method Status          Protocol
GigabitEthernet0/0      unassigned     YES unset  administratively down down
GigabitEthernet0/1      unassigned     YES unset  administratively down down
GigabitEthernet0/2      unassigned     YES unset  administratively down down
GigabitEthernet0/3      unassigned     YES unset  administratively down down
GigabitEthernet0/4      unassigned     YES unset  down            down
GigabitEthernet0/5      unassigned     YES unset  down            down
GigabitEthernet0/6      unassigned     YES unset  down            down
GigabitEthernet0/7      unassigned     YES unset  down            down
GigabitEthernet0/8      unassigned     YES unset  administratively down down
GigabitEthernet0/9      unassigned     YES unset  administratively down down
GigabitEthernet0/10     unassigned     YES unset  administratively down down
GigabitEthernet0/11     unassigned     YES unset  administratively down down
FastEthernet0/0         unassigned     YES NVRAM  administratively down down
Vlan1                   unassigned     YES unset  down            down
Router#

Router(config-if)# interface gig 0/0
Router(config-if)# no shutdown
Router(config-if)#
*Oct  5 14:22:27.743: %LICENSE-1-REQUEST_FAILED: License request for feature fls-a901-4t
1.0 failed. UDI=MWR-3941:FHAK13101A1

Router# show interface gigabitEthernet 0/0
GigabitEthernet0/0 is administratively down, line protocol is down (disabled)
.....
reliability 255/255, txload 1/255, rxload 1/255
  Encapsulation ARPA, loopback not set
  Keepalive set (10 sec)
  Full Duplex, 1000Mbps, link type is force-up, media type is RJ45
  output flow-control is unsupported, input flow-control is unsupported
  LICENSE not available! Interface disabled
  ARP type: ARPA, ARP Timeout 04:00:00
  Last input never, output never, output hang never
```

### Example: When Port Based License is Installed

The following example shows how to install the port based license:

```
Router# license install flash:FHAK13101A1_20110811190230024_fls-a901-4t.lic
```



```

Installing licenses from "flash:FHAK13101A1_20110811190230024_flis-a901-4t.lic"
Installing...Feature:Fls-a901-4t...Successful:Supported
1/1 licenses were successfully installed
0/1 licenses were existing licenses
0/1 licenses were failed to install
Router#*Oct  5 17:23:14.487: %LICENSE-6-INSTALL: Feature Fls-a901-4t 1.0 was installed in
this device. UDI=MWR-3941-TEST:FHAK13101A1; StoreIndex=2:Primary License Storage

Router(config)# interface gig 0/0
Router(config-if)# no shutdown

```

When the port based license is installed for copper or SFP ports, the corresponding ports are enabled. Following is a sample output from the **show ip interface** command:

```

Router# show ip interface brief
Interface                IP-Address      OK? Method Status        Protocol
GigabitEthernet0/0      unassigned      YES unset    up            up
GigabitEthernet0/1      unassigned      YES unset    administratively down down
GigabitEthernet0/2      unassigned      YES unset    administratively down down
....

```

**Note**

Combo ports are either copper or SFP ports depending on the configuration specified in the **media-type** command.

## 10gigUpgrade License

When you do not have the 10gigUpgrade license, the 10 Gigabit Ethernet ports are enabled in 1 Gigabit Ethernet mode. Install the 10gigUpgrade license to enable new 10 Gigabit Ethernet ports in 10Gigabit Ethernet mode. To enable 1 Gigabit Ethernet mode, 1 Gigabit Ethernet SFPs have to be used on both the ends. There is no speed command to control the speed and this depends on the type of the SFP. The 10 Gigabit Ethernet ports does not support 100M speed. You can connect 10 Gigabit Ethernet SFP+ to 10 Gigabit Ethernet ports only.

### Example: When 10gigUpgrade License is not Installed

The following error message appears when the 10gigUpgrade license is not installed and you use the **show interface** command:

```

Router# show interface Ten0/1

TenGigabitEthernet0/1 is down, line protocol is down (notconnect)
  Hardware is TenGigabit Ethernet, address is 2c54.2dd6.c10e (bia 2c54.2dd6.c10e)
  MTU 9216 bytes, BW 10000000 Kbit/sec, DLY 10 usec,
    reliability 255/255, txload 1/255, rxload 1/255
  Encapsulation ARPA, loopback not set
  Keepalive set (10 sec)
  Unknown, Unknown, media type is H10GB-CU3M
  output flow-control is unsupported, input flow-control is unsupported
  LICENSE not available or 1G SFP ( Interface in 1G mode )
  ARP type: ARPA, ARP Timeout 04:00:00
  Last input never, output never, output hang never
  Last clearing of "show interface" counters never
  Input queue: 0/75/0/0 (size/max/drops/flushes); Total output drops: 0
  Queueing strategy: fifo
  Output queue: 0/40 (size/max)
  5 minute input rate 0 bits/sec, 0 packets/sec
  5 minute output rate 0 bits/sec, 0 packets/sec
    0 packets input, 0 bytes, 0 no buffer

```

```

Received 0 broadcasts (0 multicasts)
0 runts, 0 giants, 0 throttles
0 input errors, 0 CRC, 0 frame, 0 overrun, 0 ignored
0 watchdog, 0 multicast, 0 pause input
0 packets output, 0 bytes, 0 underruns
0 output errors, 0 collisions, 0 interface resets
0 unknown protocol drops
0 babbles, 0 late collision, 0 deferred
0 lost carrier, 0 no carrier, 0 pause output
0 output buffer failures, 0 output buffers swapped out

```

## Example: When 10gigUpgrade License is Installed

The following example shows how to install the 10gigUpgrade license:

```

Router# license install flash:10G-ac.lic
Installing licenses from "flash:10G-ac.lic"
Installing...Feature:10gigUpgrade...Successful:Supported

1/1 licenses were successfully installed
0/1 licenses were existing licenses
0/1 licenses were failed to install

```

Following is a sample output from the **show license** command:

```

Router# show license
Index 1 Feature: AdvancedMetroIPAccess
      Period left: Life time
      License Type: Permanent
      License State: Active, In Use
      License Count: Non-Counted
      License Priority: Medium
Index 2 Feature: IPBase
Index 3 Feature: Gige4portflexi
Index 4 Feature: 10gigUpgrade
      Period left: Life time
      License Type: Permanent
      License State: Active, In Use
      License Count: Non-Counted
      License Priority: Medium

```

## Flexi License

When a flexi license is not present, ports 4 to 7 are enabled. Ports 0 to 3, and ports 8 to 11 are disabled. This is the expected behavior. Interfaces that are disabled are in the administrative down state.

FLS-A901-4 flexi license is a combination of copper and SFP ports. This license is not tied to any port types. If you purchase a single FL-A901-4 license and install it, four ports are enabled and if you have two licenses, all the eight ports are enabled. You can purchase and install two flexi licenses in a router.



**Note**

---

Flexi license is supported only on the Cisco ASR 901 10G router.

---

## Example: When Flexi License is not Installed

The following error message appears when the flexi license is not installed and you use the **show ip interface** command on the interface:

```

Router# show ip interface brief
Interface          IP-Address      OK? Method Status          Protocol
GigabitEthernet0/0 unassigned      YES unset  administratively down  down
GigabitEthernet0/1 unassigned      YES unset  administratively down  down
GigabitEthernet0/2 unassigned      YES unset  administratively down  down
GigabitEthernet0/3 unassigned      YES unset  administratively down  down
GigabitEthernet0/4 unassigned      YES unset  down              down
GigabitEthernet0/5 unassigned      YES unset  down              down
GigabitEthernet0/6 unassigned      YES unset  down              down
GigabitEthernet0/7 unassigned      YES unset  down              down
GigabitEthernet0/8 unassigned      YES unset  administratively down  down
GigabitEthernet0/9 unassigned      YES unset  administratively down  down
GigabitEthernet0/10 unassigned      YES unset  administratively down  down
GigabitEthernet0/11 unassigned      YES unset  administratively down  down
FastEthernet0/0    unassigned      YES NVRAM  administratively down  down
Vlan1              unassigned      YES unset  down              down

```

## Example: When Flexi License is Installed

Following is a sample output from the **show license** command:

```

Router# show license
Index 1 Feature: AdvancedMetroIPAccess
      Period left: Life time
      License Type: Permanent
      License State: Active, In Use
      License Count: Non-Counted
      License Priority: Medium
Index 2 Feature: IPBase
Index 3 Feature: Gige4portflexi

```

## 1588BC License

When the SL-A901-T 1588BC license is not installed, the PTP boundary clock cannot be configured. For more information on configuring the PTP boundary clock, see [PTP Boundary Clock](#).

## Example: When 1588BC License is not Installed

The following error message appears on configuring the PTP boundary clock, when the 1588BC license is not installed:



### Note

Though an error message appears on configuring the PTP boundary clock, the running-config file accepts the PTP boundary clock configuration. This configuration can be saved. However, the PTP boundary clock is not configured in the hardware, and is inactive.

```

Router(config)# ptp clock boundary domain 0
%ERROR: Boundary Clock needs a separate license. Please install license and reconfigure PTP.
Router(config-ptp-clk)#

```

## Example: When 1588BC License is Installed

The following example shows how to install the 1588BC license:

```

Router# license install flash:CAT1632U029_20121005013805577.lic

```

```
Installing licenses from "flash:CAT1632U029_20121005013805577.lic"
Installing...Feature:1588BC...Successful:Supported

1/1 licenses were successfully installed
0/1 licenses were existing licenses
0/1 licenses were failed to install
```

Following is a sample output from the **show license** command:

**Note**

When the 1588BC license is installed and PTP boundary clock is not configured, the license state is displayed as *Active, Not in Use*. When the 1588BC license is installed and PTP boundary clock is configured, the license state is displayed as *Active, In Use*.

```
Router# show license
Index 1 Feature: AdvancedMetroIPAccess
Index 2 Feature: IPBase
Index 3 Feature: Gige4portflexi
Index 4 Feature: 10gigUpgrade
Index 5 Feature: 1588BC
      Period left: Life time
      License Type: Permanent
      License State: Active, In Use
      License Count: Non-Counted
      License Priority: Medium
```

## Removing the 1588BC License

If PTP boundary clock is configured, then the following error message appears when removing the 1588BC license:

```
Router# license clear 1588BC
Feature: 1588BC
      License Type: Permanent
      License State: Active, In Use
      License Addition: Exclusive
      License Count: Non-Counted
      Comment:
      Store Index: 2
      Store Name: Primary License Storage

Are you sure you want to clear? (yes/[no]): yes

Handling Event, Unknown event type: 3
% Error: Could not delete in-use license
```

Complete the following steps to remove the 1588BC license.

**Step 1** Use the **no ptp clock** command to remove the PTP boundary clock configuration.

```
Router(config-ptp-clk)# no ptp clock boundary domain 0
```

**Step 2** Use the **license clear** command to remove the 1588BC license.

```
Router# license clear 1588BC
Feature: 1588BC
      License Type: Permanent
      License State: Active, Not in Use
      License Addition: Exclusive
```

```
License Count: Non-Counted
Comment:
Store Index: 3
Store Name: Primary License Storage
```

```
Are you sure you want to clear? (yes/[no]): yes
```

---

## Generating the License

Complete the following steps to generate the license:

- 
- Step 1** Use the **show license udi** command on the router
  - Step 2** Save the output.  
The output contains the UDI with the Product Identifier (PID) and Serial Number (SN).
  - Step 3** Go to the SWIFT tool at <https://tools.cisco.com/SWIFT/Licensing/PrivateRegistrationServlet>.
  - Step 4** Enter the PAK and UDI.
  - Step 5** Click **Submit**.  
You will receive the license file through email.
- 

## Installing the License

Complete the following steps to install the license:

### SUMMARY STEPS

1. **enable**
2. **license install**
3. **copy tftp: flash:**
4. **show flash:**
5. **license install** *license-file-name*
6. **reload**
7. **end**

## DETAILED STEPS

	Command	Purpose
Step 1	<b>enable</b>  <b>Example:</b> Router> enable	Enables privileged EXEC mode.  • Enter your password if prompted.
Step 2	<b>license install ?</b>  <b>Example:</b> Router# license install ?	(Optional) License can be installed either by placing the license file in the tftp boot directory or by copying the license to the flash: directory.
Step 3	<b>copy tftp: flash:</b>  <b>Example:</b> Router# copy tftp: flash:	Copies the license file to the flash: directory.
Step 4	<b>show flash:</b>  <b>Example:</b> Router# show flash:	Displays the contents of the flash: directory.
Step 5	<b>license install license-file-name</b>  <b>Example:</b> Router# license install FHK10LLL021_20110530015634482.lic	Installs the license from the flash: directory.
Step 6	<b>reload</b>  <b>Example:</b> Router# reload	Reboots the system to activate the new license.  <b>Note</b> The 1588BC license is activated after installation. Rebooting the router is not necessary.

## Changing the License

Use the **license boot level** command in the global configuration mode, to change the license. Reboot the system to activate the new license.

**Note**

If you do not install a license, the router starts with the lowest level license by default.

# Return Materials Authorization License Process

A Return Materials Authorization (RMA) license transfer enables moving all the licenses from the failed device to the replacement device. Complete the following steps to transfer the license to an RMA equipment:

- 
- Step 1** Go to the license portal <https://tools.cisco.com/SWIFT/Licensing/LicenseAdminServlet/getProducts>
- Step 2** Enter the old (failed box) UDI and the new (replacement box) UDI.  
The portal sends the new license file for transferring to the new device.
- 

For more information, see the [RMA License Transfer Between a Failed and a Working Device](#) section in the Cisco IOS Software Activation Conceptual Overview Guide.

Alternatively, you can use the Cisco License Manager (CLM) for the RMA license transfer. For more information, see [http://www.cisco.com/en/US/products/ps7138/products\\_user\\_guide\\_list.html](http://www.cisco.com/en/US/products/ps7138/products_user_guide_list.html).

## Example: RMA Process

```
Router# license install ?
      flash:          Install from flash: file system
      tftp:           Install from tftp: file system

Router# copy tftp: flash:

Address or name of remote host []? 10.105.33.135
Source filename []? /tftpboot/arulpri/FHK10LLL021_20110530015634482.lic
Destination filename [FHK10LLL021_20110530015634482.lic]?
Accessing tftp://10.105.33.135//tftpboot/arulpri/FHK10LLL021_20110530015634482.lic...
Erase flash: before copying? [confirm]
Erasing the flash filesystem will remove all files! Continue? [confirm]
Erasing device... eeeeeeeeeeeeeeeeeeeeeeeeeeeeeeeeeeeeeeeeeee...
Erased
Erase of flash: complete
Loading /tftpboot/arulpri/FHK10LLL021_20110530015634482.lic from 10.105.33.135 (via
FastEthernet0/0): !
[OK - 1237 bytes]

Verifying checksum... OK (0x7403)
1237 bytes copied in 0.132 secs (9371 bytes/sec)

Router# license install flash:FHK10LLL021_20110530015634482.lic

Installing licenses from "flash:FHK10LLL021_20110530015634482.lic"

Extension licenses are being installed in the device with
UDI "ASR901:FHK10LLL021" for the following features:

      Feature Name: AdvancedMetroIPAccess

PLEASE READ THE FOLLOWING TERMS CAREFULLY. INSTALLING THE LICENSE OR
LICENSE KEY PROVIDED FOR ANY CISCO PRODUCT FEATURE OR USING SUCH
PRODUCT FEATURE CONSTITUTES YOUR FULL ACCEPTANCE OF THE FOLLOWING
TERMS. YOU MUST NOT PROCEED FURTHER IF YOU ARE NOT WILLING TO BE BOUND
BY ALL THE TERMS SET FORTH HEREIN.
```

You hereby acknowledge and agree that the product feature license is terminable and that the product feature enabled by such license may be shut down or terminated by Cisco after expiration of the applicable term of the license (e.g., 30-day trial period). Cisco reserves the right to terminate or shut down any such product feature electronically or by any other means available. While alerts or such messages may be provided, it is your sole responsibility to monitor your terminable usage of any product feature enabled by the license and to ensure that your systems and networks are prepared for the shut down of the product feature. You acknowledge and agree that Cisco will not have any liability whatsoever for any damages, including, but not limited to, direct, indirect, special, or consequential damages related to any product feature being shutdown or terminated. By clicking the "accept" button or typing "yes" you are indicating you have read and agree to be bound by all the terms provided herein.

**ACCEPT? (yes/[no]):** *yes*

```
Installing...Feature:AdvancedMetroIPAccess...Successful:Supported
1/1 licenses were successfully installed
0/1 licenses were existing licenses
0/1 licenses were success to install
```

## Verifying the License

To verify the new license, use the **show license** command.

```
Router# show license
```

```
Index 1 Feature: AdvancedMetroIPAccess
  Period left: Lifetime
  License Type: Permanent
  License State: Active, In Use
  License Priority: High
  License Count: 1/1/0 (Active/In-use/Violation)
```

```
Index 2 Feature:...
  Period left: 0 minute 0 second
```

## Where to Go Next

For additional information on Licensing, see the documentation listed in the [“Related Documents” section on page 2-15](#).



# Additional References

## Related Documents

Related Topic	Document Title
Cisco IOS commands	<i>Cisco IOS Master Commands List, All Releases</i>
ASR 901 Command Reference	<i>Cisco ASR 901 Series Aggregation Services Router Command Reference</i>
Cisco IOS Interface and Hardware Component Commands	<i>Cisco IOS Interface and Hardware Component Command Reference</i>
Cisco Software Licensing Concepts	<i>Cisco IOS Software Activation Conceptual Overview</i>
Cisco ASR 901 Software Configuration Guide	<i>Cisco ASR 901 Series Aggregation Services Router Software Configuration Guide</i>

## Standards

Standard	Title
None	—

## MIBs

MIB	MIBs Link
None	To locate and download MIBs for selected platforms, Cisco software releases, and feature sets, use Cisco MIB Locator found at the following URL: <a href="http://www.cisco.com/go/mibs">http://www.cisco.com/go/mibs</a>

## RFCs

RFC	Title
No new or modified RFCs are supported by this feature, and support for existing RFCs has not been modified by this feature.	

## Technical Assistance

Description	Link
<p>The Cisco Support and Documentation website provides online resources to download documentation, software, and tools. Use these resources to install and configure the software and to troubleshoot and resolve technical issues with Cisco products and technologies. Access to most tools on the Cisco Support and Documentation website requires a Cisco.com user ID and password.</p>	<p><a href="http://www.cisco.com/cisco/web/support/index.html">http://www.cisco.com/cisco/web/support/index.html</a></p>

# Feature Information for Licensing

Table 2-1 lists the release history for this feature and provides links to specific configuration information.

Use Cisco Feature Navigator to find information about platform support and software image support. Cisco Feature Navigator enables you to determine which software images support a specific software release, feature set, or platform. To access Cisco Feature Navigator, go to <http://www.cisco.com/go/cfn>. An account on Cisco.com is not required.

**Note**

Table 2-1 lists only the software release that introduced support for a given feature in a given software release train. Unless noted otherwise, subsequent releases of that software release train also support that feature.

**Table 2-1** Feature Information for Licensing

Feature Name	Releases	Feature Information
Licensing	15.2(2)SNH1	The following sections provide information about this feature: <ul style="list-style-type: none"> <li>• <a href="#">Licenses Supported on Cisco ASR 901 Router</a></li> <li>• <a href="#">License Types</a></li> <li>• <a href="#">Port or Interface Behavior</a></li> <li>• <a href="#">Generating the License</a></li> <li>• <a href="#">Installing the License</a></li> <li>• <a href="#">Changing the License</a></li> <li>• <a href="#">Return Materials Authorization License Process</a></li> </ul>
1588BC Licensing	15.2(2)SNI	The following sections provide information about this feature: <ul style="list-style-type: none"> <li>• <a href="#">Licenses Supported on Cisco ASR 901 Router</a></li> <li>• <a href="#">License Types</a></li> <li>• <a href="#">Port or Interface Behavior</a></li> </ul>





# First-Time Configuration

---

This chapter describes the actions to take before turning on your router for the first time.

## Contents

- [Setup Mode, page 3-1](#)
- [Verifying the Cisco IOS Software Version, page 3-5](#)
- [Configuring the Hostname and Password, page 3-5](#)



**Note**

---

To understand the router interface numbering, see the [Cisco ASR 901 Series Aggregation Services Router Hardware Installation Guide](#).

---

## Setup Mode

The **setup** mode guides you through creating a basic router configuration. If you prefer to configure the router manually or to configure a module or interface that is not included in **setup** mode, go to [Using the Command-Line Interface, page 5-1](#) to familiarize yourself with the command-line interface (CLI).

## Before Starting Your Router

Complete the following steps before you power on your router and begin using the **setup** mode:

- 
- Step 1** Set up the hardware and connect the console and network cables as described in the “Connecting Cables” section of the [Cisco ASR 901 Series Aggregation Services Router Hardware Installation Guide](#).
  - Step 2** Configure your PC terminal emulation program for 9600 baud, 8 data bits, no parity, and 1 stop bit.
-

## Using Setup Mode

The **setup** command facility appears in your PC terminal emulation program window. To create a basic configuration for your router, perform the following:

- Complete the steps in the “[Configuring Global Parameters](#)” section on page 3-2
- Complete the steps in the “[Completing the Configuration](#)” section on page 3-4



**Note** If you made a mistake while using the setup command facility, exit the facility and run it again. Press **Ctrl-C**, and type **setup** at the enable mode prompt (1900#).

## Configuring Global Parameters

Complete the following steps to configure global parameters.

**Step 1** Power on the router. Messages appear in the terminal emulation program window.



**Caution**

*Do not press any keys on the keyboard until the messages stop. Any keys that you press during this time are interpreted as the first command entered after the messages stop, which might cause the router to power off and start over. Wait a few minutes. The messages stop automatically.*

The messages look similar to the following:

```
System Bootstrap, Version 15.1(2r)SNG, RELEASE SOFTWARE (fc1)
Technical Support: http://www.cisco.com/techsupport
Copyright (c) 2011 by cisco Systems, Inc.
Compiled Tue 25-Oct-11 12:09 by tinhuang
P2020 platform with 524288 Kbytes of main memory

program load complete, entry point: 0x2000000, size: 0x1d29954
Self decompressing the image :
#####
#####
#####
#####
#####
#####
##### [OK]

Restricted Rights Legend

Use, duplication, or disclosure by the Government is
subject to restrictions as set forth in subparagraph
(c) of the Commercial Computer Software - Restricted
Rights clause at FAR sec. 52.227-19 and subparagraph
(c) (1) (ii) of the Rights in Technical Data and Computer
Software clause at DFARS sec. 252.227-7013.

cisco Systems, Inc.
170 West Tasman Drive
San Jose, California 95134-1706
```

```
Cisco IOS Software, 901 Software (ASR901-UNIVERSALK9-M), Version 15.1(2)SNG, RELEASE
SOFTWARE (fc2)
Technical Support: http://www.cisco.com/techsupport
Copyright (c) 1986-2011 by Cisco Systems, Inc.
Compiled Tue 25-Oct-11 13:13 by prod_rel_team
```

This product contains cryptographic features and is subject to United States and local country laws governing import, export, transfer and use. Delivery of Cisco cryptographic products does not imply third-party authority to import, export, distribute or use encryption. Importers, exporters, distributors and users are responsible for compliance with U.S. and local country laws. By using this product you agree to comply with applicable laws and regulations. If you are unable to comply with U.S. and local laws, return this product immediately.

A summary of U.S. laws governing Cisco cryptographic products may be found at: <http://www.cisco.com/wwl/export/crypto/tool/stqrg.html>

If you require further assistance please contact us by sending email to [export@cisco.com](mailto:export@cisco.com).

```
Cisco ASR901-E (P2020) processor (revision 1.0) with 393216K/131072K bytes of memory.
Processor board ID CAT1529U01P
P2020 CPU at 792MHz, E500v2 core, 512KB L2 Cache
1 FastEthernet interface
12 Gigabit Ethernet interfaces
1 terminal line
256K bytes of non-volatile configuration memory.
98304K bytes of processor board System flash (Read/Write)
65536K bytes of processor board RAM Disk (Read/Write)
```

--- System Configuration Dialog ---

Would you like to enter the initial configuration dialog? [yes/no]:



---

**Note** The messages vary, depending on the Cisco IOS software image and interface modules in your router. This section is for reference only, and output might not match the messages on your console.

---

**Step 2** To begin the initial configuration dialog, enter **yes** when the following message appears:

```
Would you like to enter the initial configuration dialog? [yes/no]: yes
Would you like to enter basic management setup? [yes/no]: yes
Configuring global parameters:
```

**Step 3** Enter a hostname for the router (this example uses 901-1).

```
Configuring global parameters:

Enter host name [Router]: 901-1
```

**Step 4** Enter an enable secret password. This password is encrypted (more secure) and cannot be seen when viewing the configuration.

```
The enable secret is a password used to protect access to
privileged EXEC and configuration modes. This password, after
entered, becomes encrypted in the configuration.
Enter enable secret: ciscoenable
```



**Note** When you enter the enable secret password, the password is visible as you type it. Once you enter the password, it becomes encrypted in the configuration.

- Step 5** Enter an enable password that is different from the enable secret password. This password is *not* encrypted (less secure) and can be seen when viewing the configuration.
- The enable password is used when you do not specify an enable secret password, with some older software versions, and some boot images.
- Enter enable password: **ciscoenable**
- Step 6** To prevent unauthenticated access to the router through ports other than the console port, enter the virtual terminal password.
- The virtual terminal password is used to protect access to the router over a network interface.
- Enter virtual terminal password: **ciscoterminal**
- Step 7** Respond to the following prompts as appropriate for your network:
- ```
Configure System Management? [yes/no]: no
Configure SNMP Network Management? [yes]:
  Community string [public]: public
```
- Step 8** The summary of interfaces appears. This list varies, depending on the network modules installed in your router.
- Step 9** Specify the interface to be used to connect to the network management system.
- Step 10** Configure the specified interface as prompted.

## Completing the Configuration

When you have provided all of the information prompted for by the setup command facility, the configuration appears. Messages similar to the following appear:

The following configuration command script was created:

```
!
hostname 901-1
enable secret 5 $1$5fH0$Z6Pr5Egtr5iNJ2nBg3i6y1 enable password ciscoenable line vty 0 98
password ciscoenablesnmp-server community public !
no ip routing

!
interface GigabitEthernet0/1
shutdown
!
end
```

Complete the following steps to configure the router:

- Step 1** The setup command facility displays the following prompt.
- ```
[0] Go to the IOS command prompt without saving this config.
[1] Return back to the setup without saving this config.
[2] Save this configuration to nvram and exit.
```



```
Enter your selection [2]: 2
Building configuration...
[OK]
```

Use the enabled mode 'configure' command to modify this configuration.

Press RETURN to get started!

If you answer:

- **0**—The configuration information that you entered is *not* saved, and you return to the router enable prompt. To return to the system configuration dialog, enter **setup**.
- **1**—The configuration is not saved, and you return to the EXEC prompt.

**Step 2** When the messages stop displaying in your window, press **Return** to view the command line prompt.

The 901-1> prompt appears indicating that you are at the CLI and you completed a basic router configuration.



**Note**

The basic configuration is *not* a complete configuration.

## Verifying the Cisco IOS Software Version

To verify the version of Cisco IOS software, use the **show version** command. The **show version** command displays the configuration of the system hardware, the software version, the names and sources of the configuration files, and the boot images.

## Configuring the Hostname and Password

First configure the hostname and set an encrypted password. Configuring a hostname allows you to distinguish multiple Cisco routers from each other. Setting an encrypted password allows you to prevent unauthorized configuration changes.



**Note**

In the following procedure, press the **Return** key after each step unless otherwise noted. At any time, you can exit the privileged level and return to the user level by entering **disable** at the Router# prompt.

Complete the following steps to configure a hostname and to set an encrypted password:

**Step 1** Enter enable mode.

```
Router> enable
```

The Password prompt appears. Enter your password.

```
Password: password
```

When the prompt changes to Router, you have entered enable mode.

**Step 2** Enter global configuration mode.

```
Router# configure terminal
```

Enter configuration commands, one per line. End with CNTL/Z.

When the prompt changes to Router(config), you have entered global configuration mode.

```
Router(config)#
```

- Step 3** Change the name of the router to a meaningful name. Substitute your hostname for Router.

```
Router(config)# hostname Router
```

```
Router(config)#
```

- Step 4** Enter an enable secret password. This password provides access to privileged EXEC mode. When you type **enable** at the EXEC prompt (Router>), you must enter the enable secret password to access configuration mode. Enter your secret password.

```
Router(config)# enable secret secret password
```

- Step 5** Exit back to global configuration mode.

```
Router(config)# exit
```

---

## Verifying the Hostname and Password

Complete the following steps to verify that you have correctly configured the hostname and password:

---

- Step 1** Enter the **show config** command:

```
Router# show config
Using 1888 out of 126968 bytes
!
version XX.X
.
.
.
!
hostname Router
!
enable secret 5 $1$60L4$X2JY0woDc0.kqa1lo0/w8/
.
.
.
```

- Step 2** Check the hostname and encrypted password, which appear near the top of the command output.

- Step 3** Exit global configuration mode and attempt to re-enter it using the new enable password:

```
Router# exit
.
.Router con0 is now available
Press RETURN to get started.
Router> enable
Password: password
Router#
```

---



# Managing and Monitoring Network Management Features

---

This feature module describes how to monitor, manage and deploy a variety of network management features, including Cisco Active Network Abstraction (ANA), Simple Network Management Protocol (SNMP) and Cisco Networking Services (CNS). The CNS software agent on the ASR 901 can communicate with a Cisco Configuration Engine to allow the ASR 901 to be deployed in the field without having to pre-stage it for configuration or image upgrade. The Zero-touch deployment capability enables the ASR 901 router to auto configure itself, download an updated image, connect to the network, and start the operation as soon as it is cabled and powered up.

For more information about the Cisco Configuration Engine, see [http://www.cisco.com/en/US/prod/collateral/netmgtsw/ps6504/ps4617/qa\\_c67\\_598467.html](http://www.cisco.com/en/US/prod/collateral/netmgtsw/ps6504/ps4617/qa_c67_598467.html)

## Finding Feature Information

Your software release may not support all the features documented in this module. For the latest feature information and caveats, see the release notes for your platform and software release. To find information about the features documented in this module, and to see a list of the releases in which each feature is supported, see the “[Feature Information for Monitoring and Managing the ASR 901 Router](#)” section on [page 4-18](#).

Use Cisco Feature Navigator to find information about platform support and Cisco software image support. To access Cisco Feature Navigator, go to <http://www.cisco.com/go/cfn>. An account on Cisco.com is not required.

## Contents

- [Network Management Features for the ASR 901, page 4-2](#)
- [How to Configure Network Management Features on ASR 901, page 4-2](#)
- [Where to Go Next, page 4-16](#)
- [Additional References, page 4-16](#)
- [Feature Information for Monitoring and Managing the ASR 901 Router, page 4-18](#)

# Network Management Features for the ASR 901

The following sections describe the network management features available on the ASR 901.

- [Cisco Active Network Abstraction \(ANA\)](#)
- [SNMP MIB Support](#)
- [Cisco Networking Services \(CNS\)](#)

## Cisco Active Network Abstraction (ANA)

Cisco ANA is a powerful, next-generation network resource management solution designed with a fully distributed OSS mediation platform that abstracts the network, its topology and its capabilities from the physical elements. Its virtual nature provides customers with a strong and reliable platform for service activation, service assurance and network management. For more information about ANA, see [http://www.cisco.com/en/US/products/ps6776/tsd\\_products\\_support\\_series\\_home.html](http://www.cisco.com/en/US/products/ps6776/tsd_products_support_series_home.html).

## SNMP MIB Support

To view the current MIBs that the ASR 901 supports, see <http://www.cisco.com/go/mibs>.

## Cisco Networking Services (CNS)

Cisco Networking Services (CNS) is a collection of services that can provide remote configuration of Cisco IOS networking devices, remote execution of command-line interface (CLI) commands, and image downloads by communicating with a Cisco Configuration Engine application running on a server. CNS enables the zero-touch deployment for the ASR 901 router by automatically downloading its configuration and upgrading its image if needed.

**Note**

---

The ASR 901 only supports CNS over motherboard Ethernet interfaces.

---

For more information about CNS configuration, see [Enabling Cisco Networking Services \(CNS\) and Zero-Touch Deployment](#).

# How to Configure Network Management Features on ASR 901

This section contains the following procedures:

- [Configuring SNMP Support](#)
- [Configuring Remote Network Management](#)
- [Enabling Cisco Networking Services \(CNS\) and Zero-Touch Deployment](#)

## Configuring SNMP Support

Use the following to configure SNMP support for

- Setting up the community access
- Establishing a message queue for each trap host
- Enabling the router to send SNMP trap messages
- Enabling SNMP trap messages for alarms
- Enabling trap messages for a specific environment.



### Note

In the following procedure, press the **Return** key after each step unless otherwise noted. At any time, you can exit the privileged level and return to the user level by entering **disable** at the `Router#` prompt.

Complete the following steps to configure SNMP:

### SUMMARY STEPS

1. **enable**
2. **configure terminal**
3. **snmp-server community** *string* [**view** *view-name*] [**ro** | **rw**] [*number*]
4. **snmp-server queue-length** *length*
5. **snmp-server enable traps** [*notification-type*] [*notification-option*]
6. **snmp-server enable traps ipran**
7. **snmp-server enable traps envmon**
8. **snmp-server host** *host-address* [**traps** | **informs**] [**version** {**1** | **2c** | **3** [**auth** | **noauth** | **priv**]}] **community-string** [**udp-port** *port*] [*notification-type*]
9. **end**

### DETAILED STEPS

	Command	Purpose
Step 1	<b>enable</b>  <b>Example:</b> Router> enable	Enables privileged EXEC mode. <ul style="list-style-type: none"> <li>• Enter your password if prompted.</li> </ul>
Step 2	<b>configure terminal</b>  <b>Example:</b> Router# configure terminal	Enters global configuration mode.

Command	Purpose
<p><b>Step 3</b></p> <pre>Router(config)# <b>snmp-server</b> <b>community</b> <i>string</i> [<b>view</b> <i>view-name</i>] [<b>ro</b>   <b>rw</b>] [<i>number</i>]</pre> <p><b>Example:</b></p> <pre>Router(config)# snmp-server community xxxxx RO</pre>	<p>Sets up the community access string to permit access to SNMP. The <b>no</b> form of this command removes the specified community string.</p> <ul style="list-style-type: none"> <li>• <i>string</i>—Community string is the password to access the SNMP protocol.</li> <li>• <b>view</b> <i>view-name</i>—(Optional) Previously defined view. The view defines the objects available to the community.</li> <li>• <b>ro</b>—(Optional) Specifies read-only access. Authorized management stations are able only to retrieve MIB objects.</li> <li>• <b>rw</b>—(Optional) Specifies read-write access. Authorized management stations are able to both retrieve and modify MIB objects.</li> <li>• <i>number</i>—(Optional) Specifies an access list of IP addresses allowed to use the community string to gain access to the SNMP agent. Values range from 1 to 99.</li> </ul>
<p><b>Step 4</b></p> <pre>Router(config)# <b>snmp-server</b> <b>queue-length</b> <i>length</i></pre> <p><b>Example:</b></p> <pre>Router(config)# snmp-server queue-length 100</pre>	<p>Establishes the message queue length for each trap host.</p> <ul style="list-style-type: none"> <li>• <i>length</i>—Specifies the number of trap events that can be held before the queue must be emptied.</li> </ul>

Command	Purpose
<p><b>Step 5</b></p> <pre>Router(config)# <b>snmp-server enable traps</b> [notification-type] [notification-option]</pre> <p><b>Example:</b></p> <pre>Router(config)# snmp-server enable traps snmp linkdown linkup coldstart warmstart</pre>	<p>Enables the router to send SNMP traps messages. Use the <b>no</b> form of this command to disable SNMP notifications.</p> <ul style="list-style-type: none"> <li>• <b>notification-type—snmp [authentication]</b>—Enables RFC 1157 SNMP notifications. Note that use of the <b>authentication</b> keyword produces the same effect as not using the <b>authentication</b> keyword. Both the <b>snmp-server enable traps snmp</b> and <b>snmp-server enable traps snmp authentication</b> forms of this command globally enable (or, if using the <b>no</b> form, disable) the following SNMP traps: <ul style="list-style-type: none"> <li>– authentication failure</li> <li>– linkup</li> <li>– linkdown</li> <li>– coldstart</li> <li>– warmstart</li> </ul> </li> <li>• <b>notification-option</b>—(Optional) <b>atm pvc [interval seconds] [fail-interval seconds]</b>—The optional interval seconds keyword/argument combination specifies the minimum period between successive traps, in the range from 1 to 3600. Generation of PVC traps is dampened by the notification interval to prevent trap storms. No traps are sent until the interval lapses. The default interval is 30. <p>The optional fail-interval seconds keyword/argument combination specifies the minimum period for storing the failed time stamp, in the range from 0 to 3600. The default fail-interval is 0.</p> </li> <li>• <b>envmon [voltage   shutdown   supply   fan   temperature]</b>—When the <b>envmon</b> keyword is used, you can enable a specific environmental notification type, or accept all notification types from the environmental monitor system. If no option is specified, all environmental notifications are enabled. The option can be one or more of the following keywords: <b>voltage</b>, <b>shutdown</b>, <b>supply</b>, <b>fan</b>, and <b>temperature</b>.</li> <li>• <b>isdn [call-information   isdn u-interface]</b>—When the <b>isdn</b> keyword is used, you can specify the <b>call-information</b> keyword to enable an SNMP ISDN call information notification for the ISDN MIB subsystem, or you can specify the <b>isdnu-interface</b> keyword to enable an SNMP ISDN U interface notification for the ISDN U interface MIB subsystem.</li> <li>• <b>repeater [health   reset]</b>—When the <b>repeater</b> keyword is used, you can specify a repeater option. If no option is specified, all repeater notifications are enabled. The option can be one or more of the following keywords: <ul style="list-style-type: none"> <li>– <b>health</b>—Enables IETF Repeater Hub MIB (RFC 1516) health notification.</li> <li>– <b>reset</b>—Enables IETF Repeater Hub MIB (RFC 1516) reset notification.</li> </ul> </li> </ul>

	Command	Purpose
Step 6	<pre>Router(config)# snmp-server enable traps ipran</pre> <p><b>Example:</b></p> <pre>Router(config)# snmp-server enable traps ipran</pre>	<p>Enables SNMP trap messages for all IP-RAN notifications.</p> <p><b>Note</b> Besides enabling SNMP trap messages for all IP-RAN notifications, you can also enable the messages for IP-RAN GSM alarms, UMTS alarms, and general information about the backhaul utilization.</p>
Step 7	<pre>Router(config)# snmp-server enable traps envmon</pre> <p><b>Example:</b></p> <pre>Router(config)# snmp-server enable traps envmon</pre>	<p>Enables SNMP trap messages for a specific environment.</p>
Step 8	<pre>Router(config)# snmp-server host host-address [traps   informs] [version {1   2c   3 [auth   noauth   priv]}] community-string [udp-port port] [notification-type]</pre> <p><b>Example:</b></p> <pre>Router(config)# snmp-server host 10.20.30.40 version 2c</pre>	<p>Specifies the recipient of an SNMP trap messages. To remove the specified host, use the <b>no</b> form of this command.</p> <ul style="list-style-type: none"> <li>• <i>host-address</i>—Name or Internet address of the host (the targeted recipient).</li> <li>• <b>traps</b>—Sends SNMP trap messages to this host. This is the default.</li> <li>• <b>informs</b>—(Optional) Sends SNMP informs to this host.</li> <li>• <b>version</b>—(Optional) Version of the SNMP used to send the traps. Version 3 is the most secure model because allows packet encryption with the <b>priv</b> keyword. If you use the version keyword, one of the following must be specified: <ul style="list-style-type: none"> <li>– <b>1</b>—SNMP version 1. This option is not available with informs.</li> <li>– <b>2c</b>—SNMP version 2C.</li> <li>– <b>3</b>—SNMP version 3. The following three optional keywords can follow the version 3 keyword: <ul style="list-style-type: none"> <li>–<b>auth</b> (Optional). Enables Message Digest 5 (MD5) and Secure Hash Algorithm (SHA) packet authentication</li> <li>–<b>noauth</b> (Default). The no authentication-no privileges security level is the default if the auth   noauth   priv] keyword choice is not specified.</li> <li>–<b>priv</b> (Optional). Enables Data Encryption Standard (DES) packet encryption.</li> </ul> </li> </ul> </li> <li>• <i>community-string</i>—Password-like community string sent with the notification operation. Though you can set this string using the <b>snmp-server host</b> command by itself, we recommend you define this string using the <b>snmp-server community</b> command before using the <b>snmp-server host</b> command.</li> <li>• <b>udp-port port</b>—UDP port of the host. The default value is 162.</li> </ul>



Command	Purpose
	<ul style="list-style-type: none"> <li>• <i>notification-type</i>—(Optional) Type of notification to be sent to the host. If no type is specified, all notifications are sent. The notification type can be one or more of the following keywords: <ul style="list-style-type: none"> <li>– <b>aaa_server</b>—Enables SNMP AAA Server traps.</li> <li>– <b>atm</b>—Enables SNMP ATM Server traps.</li> <li>– <b>ccme</b>—Enables SNMP CCME traps.</li> <li>– <b>cnpd</b>—Enables NBAR Protocol Discovery traps.</li> <li>– <b>config</b>—Enables SNMP config traps.</li> <li>– <b>config-copy</b>—Enables SNMP config-copy traps.</li> <li>– <b>cpu</b>—Allow cpu related traps.</li> <li>– <b>dial</b>—Enables SNMP dial control traps.</li> <li>– <b>dnis</b>—Enables SNMP DNIS traps.</li> <li>– <b>ds0-busyout</b>—Enables ds0-busyout traps.</li> <li>– <b>ds1</b>—Enables SNMP DS1 traps.</li> <li>– <b>ds1-loopback</b>—Enables ds1-loopback traps.</li> <li>– <b>ds3</b>—Enables SNMP DS3 traps.</li> <li>– <b>dsp</b>—Enables SNMP dsp traps.</li> <li>– <b>eigrp</b>—Enables SNMP EIGRP traps.</li> <li>– <b>entity</b>—Enables SNMP entity traps.</li> <li>– <b>envmon</b>—Enables SNMP environmental monitor traps.</li> <li>– <b>flash</b>—Enables SNMP FLASH notifications.</li> <li>– <b>frame-relay</b>—Enables SNMP frame-relay traps.</li> <li>– <b>hsrp</b>—Enables SNMP HSRP traps.</li> <li>– <b>icsudsu</b>—Enables SNMP ICSUDSU traps.</li> <li>– <b>ipmulticast</b>—Enables SNMP ipmulticast traps.</li> <li>– <b>ipran</b>—Enables IP-RAN Backhaul traps.</li> <li>– <b>ipsla</b>—Enables SNMP IP SLA traps.</li> <li>– <b>isdn</b>—Enables SNMP isdn traps.</li> <li>– <b>12tun</b>—Enables SNMP L2 tunnel protocol traps.</li> <li>– <b>mpls</b>—Enables SNMP MPLS traps.</li> <li>– <b>msdp</b>—Enables SNMP MSDP traps.</li> <li>– <b>mvpn</b>—Enables Multicast Virtual Private Networks traps.</li> <li>– <b>ospf</b>—Enables OSPF traps.</li> <li>– <b>pim</b>—Enables SNMP PIM traps.</li> </ul> </li> </ul>

Command	Purpose
	<ul style="list-style-type: none"> <li>- <b>pppoe</b>—Enables SNMP pppoe traps.</li> <li>- <b>pw</b>—Enables SNMP PW traps.</li> <li>- <b>rsvp</b>—Enables RSVP flow change traps.</li> <li>- <b>snmp</b>—Enables SNMP traps.</li> <li>- <b>srst</b>—Enables SNMP srst traps.</li> <li>- <b>syslog</b>—Enables SNMP syslog traps.</li> <li>- <b>tty</b>—Enables TCP connection traps.</li> <li>- <b>voice</b>—Enables SNMP voice traps.</li> <li>- <b>vrrp</b>—Enables SNMP vrrp traps.</li> <li>- <b>vtp</b>—Enables SNMP VTP traps.</li> <li>- <b>xgcp</b>—Enables XGCP protocol traps.</li> </ul>
<b>Step 9</b> <b>end</b>  <b>Example:</b> Router(config)# end	Exits global configuration mode.

## Configuring Remote Network Management

Complete the following steps to configure remote network management of ASR 901:

### SUMMARY STEPS

1. **enable**
2. **configure terminal**
3. **ip host** *host-name ip-address*
4. **interface loopback** *number*
5. **ip-address** *ip-address subnet-mask*
6. **end**
7. **snmp-server host** *hostname* [**traps** | **informs**] [**version** {1 | 2c | 3 [**auth** | **noauth** | **priv**]}] *community-string* [**udp-port** *port*] [*notification-type*]
8. **snmp-server community** *public ro*
9. **snmp-server community** *private rw*
10. **snmp-server enable traps**
11. **snmp-server trap-source loopback** *number*
12. **end**

## DETAILED STEPS

	Command or Action	Purpose
Step 1	<p><b>enable</b></p> <p><b>Example:</b> Router&gt; enable</p>	<p>Enables privileged EXEC mode.</p> <ul style="list-style-type: none"> <li>Enter your password if prompted.</li> </ul>
Step 2	<p><b>configure terminal</b></p> <p><b>Example:</b> Router# configure terminal</p>	<p>Enters global configuration mode.</p>
Step 3	<p><b>ip host</b> <i>host-name ip-address</i></p> <p><b>Example:</b> Router(config)# ip host om-work 10.0.0.1</p>	<p>Assigns a host name to each of the network management workstations, where <i>hostname</i> is the name assigned to the Operations and Maintenance (O&amp;M) workstation and <i>ip_address</i> is the address of the network management workstation.</p>
Step 4	<p><b>interface loopback</b> <i>number</i></p> <p><b>Example:</b> Router(config-if)# interface loopback 5005</p>	<p>Creates a loopback interface for O&amp;M.</p>
Step 5	<p><b>ip-address</b> <i>ip-address subnet-mask</i></p> <p><b>Example:</b> Router(config-if)# ip-address 10.10.12.10 23</p>	<p>Configures the interval at which packets are sent to refresh the MAC cache when HSRP is running.</p>
Step 6	<p><b>end</b></p> <p><b>Example:</b> Router(config-if)# end</p>	<p>Exits interface configuration mode.</p>
Step 7	<p><b>snmp-server host</b> <i>hostname [traps   informs] [version {1   2c   3 [auth   noauth   priv]] community-string [udp-port port] [notification-type]</i></p> <p><b>Example:</b> Router(config-if)# snmp-server host snmp1 version 3 auth</p>	<p>Specifies the recipient of a Simple Network Management Protocol (SNMP) notification operation.</p> <p>The <i>hostname</i> is the name assigned to the Cisco Info Center workstation with the <i>ip host</i> command in <a href="#">Step 3</a>.</p>
Step 8	<p><b>snmp-server community</b> <i>public ro</i></p> <p><b>Example:</b> Router(config-if)# snmp-server community snmppubliccom RO</p>	<p>Specifies the public SNMP community name.</p>
Step 9	<p><b>snmp-server community</b> <i>private rw</i></p> <p><b>Example:</b> Router(config-if)# snmp-server community snmpprivatecom RW</p>	<p>Specifies the private SNMP community name.</p>

	Command or Action	Purpose
Step 10	<code>snmp-server enable traps</code>  <b>Example:</b> Router(config-if)# snmp-server enable traps	Enables the transmission of SNMP traps messages.
Step 11	<code>snmp-server trap-source loopback number</code>  <b>Example:</b> Router(config-if)# snmp-server trap-source loopback 5005	Specifies the loopback interface from which SNMP traps messages originate, where number is the number of the loopback interface you configured for the O&M in <a href="#">Step 4</a> .
Step 12	<code>end</code>  <b>Example:</b> Router(config-if)# end	Exits global configuration mode.

## Enabling Cisco Networking Services (CNS) and Zero-Touch Deployment

To enable CNS and Zero-Touch deployment, you need the following servers:

- A DHCP server (standalone or enabled on the carrier edge router)
- A TFTP server (standalone or enabled on the carrier edge router)
- A server running the Cisco Configuration Engine (formerly known as the CNS-CE server)



### Note

The ASR 901 only supports CNS over motherboard Ethernet interfaces.

This section contains the following procedures:

- [Zero-Touch Deployment, page 4-10](#)
- [Configuring a DHCP Server, page 4-12](#)
- [Configuring a TFTP Server, page 4-13](#)
- [Configuring the Cisco Configuration Engine, page 4-14](#)

## Zero-Touch Deployment

Zero-touch deployment feature gives the router the ability to retrieve its configuration file from the remote server during initial router deployment with no end-user intervention.

Figure 4-1 Zero-touch Deployment

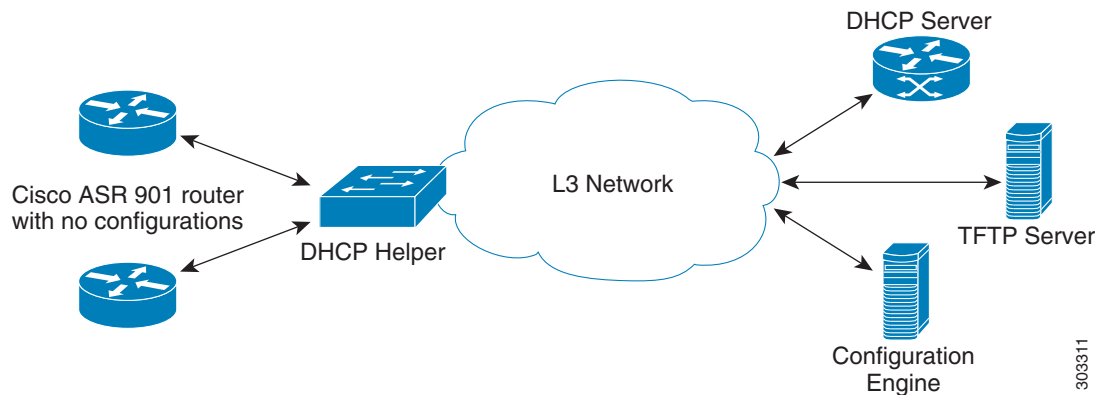

The following steps provide an overview of events that take place during ASR 901 zero-touch deployment.

- 
- Step 1** Connect the Cisco ASR 901 without any configurations to an upstream router.
  - Step 2** The ASR 901 auto-senses the management vlan of the upstream router for IP connectivity by listening to the traffic it receives on the connected interface.
  - Step 3** The ASR 901 sends DHCP discover messages using the discovered VLAN tag. If the upstream router is not using a management VLAN, untagged DHCP discover messages are sent.
  - Step 4** The DHCP server responds with a DHCP offer.
  - Step 5** The ASR 901 sends a DHCP request message to the DHCP server. The DHCP server then sends the DHCP ACK message.



**Note** Step 6 and 7 are used only when Option 43 is not configured.

- 
- Step 6** The ASR 901 requests **network-config** file via TFTP.
  - Step 7** The TFTP server sends the ASR 901 a **network-config** file.
  - Step 8** The ASR 901 sends an HTTP request to the CNS-CE server.
  - Step 9** The CNS-CE server sends a configuration template to the ASR 901.
  - Step 10** Publish success event.
- 

## Image Download

The following events take place when a CNS-enabled ASR 901 downloads a new image:

- 
- Step 1** The CNS-CE server requests inventory (disk/flash info) from the ASR 901-DC.
  - Step 2** The ASR 901-DC sends an inventory.
  - Step 3** The CNS-CE server sends an image location.

- Step 4** The ASR 901-DC sends a TFTP image request.
- Step 5** The ASR 901-DC downloads an image from the TFTP server.
- Step 6** Refresh the CNS-CE server to check whether the image download is complete.
- Step 7** Associate the .inv template in the CNS-CE server. Based on the boot variable, the ASR 901 reboots with the copied image.
- Step 8** The CNS-CE server reboots the ASR 901-DC router.
- 

## Configuring a DHCP Server

The Cisco ASR 901 requires a DHCP server for zero-touch deployment. Complete the following steps to configure a Cisco router as a DHCP server.

### SUMMARY STEPS

1. **enable**
2. **configure terminal**
3. **ip dhcp excluded-address** *dhcp-server-ip-address*
4. **ip dhcp excluded-address** *ip-address subnet-mask*
5. **ip dhcp pool** *pool-name*
6. **network** *ip-address subnet-mask*
7. **default-router** *ip-address*
8. **option 43 ascii** *string* or **option 150 ascii** *string*
9. **end**

### DETAILED STEPS

	Command or Action	Purpose
Step 1	<b>enable</b>  <b>Example:</b> Router> enable	Enables privileged EXEC mode. <ul style="list-style-type: none"> <li>• Enter your password if prompted.</li> </ul>
Step 2	<b>configure terminal</b>  <b>Example:</b> Router# configure terminal	Enters global configuration mode.
Step 3	<b>ip dhcp excluded-address</b> <i>dhcp-server-ip-address</i>  <b>Example:</b> Router# ip dhcp excluded-address 30.30.1.6	Specifies to exclude IP address of the DHCP server.

	Command or Action	Purpose
Step 4	<b>ip dhcp excluded-address</b> <i>ip-address subnet-mask</i>  <b>Example:</b> Router# ip dhcp excluded-address 30.30.1.20 30.30.1.255	Assigns IP addresses with an exception of 30.30.1.6, which is the IP address of the DHCP server.
Step 5	<b>ip dhcp pool</b> <i>pool-name</i>  <b>Example:</b> Router# ip dhcp pabudhcp2	Specifies the DHCP pool name.
Step 6	<b>network</b> <i>ip-address subnet-mask</i>  <b>Example:</b> Router# network 160.100.100.0 255.255.255.252	Specifies the IP address and subnet mask of the network.
Step 7	<b>default-router</b> <i>ip-address</i>  <b>Example:</b> Router# default-router 30.30.1.6	Specifies the IP address of the default router.
Step 8	<b>option 43 ascii</b> <i>string</i> <b>or</b> <b>option 150 ip</b> <i>&lt;TFTP-server-ip-address&gt;</i>  <b>Example:</b> Router# option 43 ascii 3A1D;A3;B161.100.100.2	Specifies Option 43 and a string value that has the CNS details, serial number of the hardware, and the code for CE IP address or Option 150 and the IP address of the TFTP server.  For more information on Option 43, see <a href="http://www.cisco.com/en/US/docs/ios-xml/ios/cns/configuration/15-mt/cns-dhcp.html#GUID-CA88C33A-D81B-41D3-A1F4-F276DA11C8B5">http://www.cisco.com/en/US/docs/ios-xml/ios/cns/configuration/15-mt/cns-dhcp.html#GUID-CA88C33A-D81B-41D3-A1F4-F276DA11C8B5</a> . ASR 901 supports only few letter code options mentioned in this link.
Step 9	<b>end</b>  <b>Example:</b> Router(config-if)# end	Exits configuration mode.

## Configuring a TFTP Server

You need to set up a TFTP server to provide a bootstrap configuration to the ASR 901 routers when they boot using option 150.

### Creating a Bootstrap Configuration

Create or download a file with the initial bootstrap configuration on the TFTP server. An example of the configuration file is shown below:

```
hostname test-router
!
cns trusted-server all-agents 30.30.1.20
cns event 30.30.1.20 11011 keepalive 60 3
cns config initial 30.30.1.20 80
cns config partial 30.30.1.20 80
cns id hostname
```

```
cns id hostname event
cns id hostname image
!
end
```

## Enabling a TFTP Server on the Edge Router

The Cisco ASR 901 requires a TFTP server for zero-touch deployment while using option 150. The TFTP server is typically implemented on the carrier edge router. You can use the following global configuration commands to enable a TFTP server on the edge router that can send the initial configuration to the Cisco ASR 901 router.

```
tftp-server sup-bootflash:network-config
```

Once the Cisco ASR 901 boots with this configuration, it can connect to the CNS-CE server.

## Configuring the Cisco Configuration Engine

The Cisco Configuration Engine (formerly known as the Cisco CNS Configuration Engine) allows you to remotely manage configurations and IOS software images on Cisco devices including the Cisco ASR 901.

Once the Cisco ASR 901 downloads the bootstrap configuration and connects to the Cisco Configuration Engine server, you can use the server to download a full configuration to the router. You can also use the CNS-CE server to complete any of the following tasks:

- Manage configuration templates—The CNS-CE server can store and manage configuration templates.
- Download a new image—You can use the CNS-CE server to load a new IOS image on a Cisco ASR 901 router.
- Loading a new config—You can use the CNS-CE server to load a new configuration file on a Cisco ASR 901 router.
- Enable identification—You can use a unique CNS agent ID to verify the identity of a host device prior to communication with the CNS-CE server.
- Enable authentication—You can configure the CNS-CE server to require a unique password from the ASR 901 router as part of any communication handshake.
- Enable encryption—You can enable Secure Socket Layer (SSL) encryption for the HTTP sessions between the CNS agent devices (Cisco ASR 901 routers) and the CNS-CE server.

For instructions about how to use the CNS-CE server, see the *Cisco Configuration Engine Installation & Configuration Guide* at

[http://www.cisco.com/en/US/products/sw/netmgtsw/ps4617/tsd\\_products\\_support\\_series\\_home.html](http://www.cisco.com/en/US/products/sw/netmgtsw/ps4617/tsd_products_support_series_home.html).



# Configuration Examples

This section provides the following configuration examples:

- [Example: Configuring SNMP Support](#)
- [Example: Configuring Remote Network Management](#)
- [Example: Configuring a DHCP Server](#)
- [Example: Zero-touch Deployment](#)

## Example: Configuring SNMP Support

```
!  
snmp-server community xxxxx RO  
snmp-server queue-length 100  
snmp-server enable traps snmp linkdown linkup coldstart warmstart  
snmp-server enable traps ipran  
snmp-server enable traps envmonsnmp-server host 10.20.30.40 version 2c  
!
```

## Example: Configuring Remote Network Management

```
cns trusted-server all-agents 30.30.1.20  
cns event 30.30.1.20 11011 keepalive 60 3  
cns config initial 30.30.1.20 80  
cns config partial 30.30.1.20 80  
cns id hostname  
cns id hostname event  
cns id hostname image  
cns exec 80  
logging buffered 20000  
!  
end
```

## Example: Configuring a DHCP Server

```
ip dhcp excluded-address 30.30.1.6  
ip dhcp excluded-address 30.30.1.20 30.30.1.255  
!  
ip dhcp pool asrdhcp  
network 30.30.1.0 255.255.255.0  
default-router 30.30.1.6  
Option 43 ascii 3A1D;A3;B161.100.100.2  
!  
end
```

## Example: Zero-touch Deployment

The following configuration example sets the Cisco ASR 901 to boot using configurations stored on a CNS-CE server with the IP address 30.30.1.20.

**Note**

This section provides partial configurations intended to demonstrate a specific feature.

```
hostname 901
!
cns trusted-server all-agents 30.30.1.20
cns event 30.30.1.20 11011 keepalive 60 3
cns config initial 30.30.1.20 80
cns config partial 30.30.1.20 80
cns id hostname
cns id hostname event
cns id hostname image
!
end
```

## Where to Go Next

For additional information on monitoring and managing the ASR 901 router, see the documentation listed in the [“Related Documents”](#) section on page 4-16.

## Additional References

### Related Documents

Related Topic	Document Title
Cisco IOS commands	<a href="#">Cisco IOS Master Commands List, All Releases</a>
ASR 901 Command Reference	<a href="#">Cisco ASR 901 Series Aggregation Services Router Command Reference</a>
Cisco IOS Interface and Hardware Component Commands	<a href="#">Cisco IOS Interface and Hardware Component Command Reference</a>

### Standards

Standard	Title
None	—

## MIBs

MIB	MIBs Link
None	To locate and download MIBs for selected platforms, Cisco software releases, and feature sets, use Cisco MIB Locator found at the following URL: <a href="http://www.cisco.com/go/mibs">http://www.cisco.com/go/mibs</a>

## RFCs

RFC	Title
No new or modified RFCs are supported by this feature, and support for existing RFCs has not been modified by this feature.	

## Technical Assistance

Description	Link
The Cisco Support and Documentation website provides online resources to download documentation, software, and tools. Use these resources to install and configure the software and to troubleshoot and resolve technical issues with Cisco products and technologies. Access to most tools on the Cisco Support and Documentation website requires a Cisco.com user ID and password.	<a href="http://www.cisco.com/cisco/web/support/index.html">http://www.cisco.com/cisco/web/support/index.html</a>

# Feature Information for Monitoring and Managing the ASR 901 Router

Table 1 lists the release history for this feature and provides links to specific configuration information.

Use Cisco Feature Navigator to find information about platform support and software image support. Cisco Feature Navigator enables you to determine which software images support a specific software release, feature set, or platform. To access Cisco Feature Navigator, go to <http://www.cisco.com/go/cfn>. An account on Cisco.com is not required.

**Note**

Table 1 lists only the software release that introduced support for a given feature in a given software release train. Unless noted otherwise, subsequent releases of that software release train also support that feature.

**Table 1** Feature Information for Monitoring and Managing the ASR 901 Router

Feature Name	Releases	Feature Information
Monitoring and Managing the ASR 901 Router	15.2(2)SNI	<p>The following sections provide information about this feature:</p> <ul style="list-style-type: none"> <li><a href="#">Network Management Features for the ASR 901</a></li> <li><a href="#">How to Configure Network Management Features on ASR 901</a></li> </ul>



# Using the Command-Line Interface

---

This chapter describes the Cisco IOS command-line interface (CLI) and how to use it to configure the Cisco ASR 901 router.

## Contents

- [Understanding Command Modes, page 5-1](#)
- [Understanding the Help System, page 5-3](#)
- [Understanding Abbreviated Commands, page 5-4](#)
- [Understanding no and default Forms of Commands, page 5-4](#)
- [Understanding CLI Error Messages, page 5-4](#)
- [Using Command History, page 5-5](#)
- [Using Editing Features, page 5-6](#)
- [Searching and Filtering Output of show and more Commands, page 5-9](#)
- [Accessing the CLI, page 5-9](#)
- [Saving Configuration Changes, page 5-10](#)

## Understanding Command Modes

The Cisco IOS user interface is divided into different modes. The commands depend on which mode you are currently in. Enter a question mark (?) at the system prompt to obtain a list of commands for each command mode.

When you start a session on the router, you begin in the user mode, often called user EXEC mode. Only a limited subset of the commands are available in user EXEC mode. For example, most of the user EXEC commands are one-time commands, such as **show** commands, which show the current configuration status, and **clear** commands, which clear counters or interfaces. The user EXEC commands are not saved when the router reboots.

To gain access to all the commands, enter privileged EXEC mode. You need to enter a password to enter privileged EXEC mode. From this mode, you can enter any privileged EXEC command or enter global configuration mode.

Using the configuration modes (global, interface, and line), you can make changes to the running configuration. When you save the configuration, these commands are stored and used for router reboots. To access the various configuration modes, you must start at global configuration mode. From global configuration mode, you can enter interface configuration mode and line configuration mode.

Table 5-1 describes the main command modes, how to access each one, the prompt you see in that mode, and how to exit the mode. The examples in the table use the hostname *Router*.

For more detailed information on the command modes, see the command reference guide for this release.

**Table 5-1 Command Mode Summary**

Command Mode	Access Method	Router Prompt Displayed	Exit Method	About This Mode
User EXEC	Log in.	Router>	Use the <b>logout</b> command.	Use this mode to: <ul style="list-style-type: none"> <li>• Change terminal settings.</li> <li>• Perform basic tests.</li> <li>• Display system information.</li> </ul>
Privileged EXEC	From user EXEC mode, use the <b>enable</b> command.	Router#	To go to user EXEC mode, use the <b>disable</b> , <b>exit</b> , or <b>logout</b> command.	Use this mode to verify commands that you have entered. Use a password to protect access to this mode.
Global configuration	From the privileged EXEC mode, use the <b>configure terminal</b> command.	Router (config)#	To go to privileged EXEC mode, use the <b>exit</b> or <b>end</b> command, or press <b>Ctrl-Z</b> .	Use this mode to configure parameters that apply to the entire router.
Interface configuration	From the global configuration mode, use the <b>interface</b> command (with a specific interface).	Router (config-if)#	To go to global configuration mode, use the <b>exit</b> command.  To return directly to privileged EXEC mode, press <b>Ctrl-Z</b> .	Use this mode to configure parameters for the Ethernet ports.

Table 5-1 Command Mode Summary

Command Mode	Access Method	Router Prompt Displayed	Exit Method	About This Mode
VLAN configuration	While in global configuration mode, enter the <b>vlan</b> <i>vlan-id</i> command.	Router(config-vlan) #	To go to global configuration mode, enter the <b>exit</b> command.  To return to privileged EXEC mode, press <b>Ctrl-Z</b> or use the <b>end</b> command.	Use this mode to configure VLAN parameters.
Line configuration	While in global configuration mode, specify a line by using the <b>line vty</b> or <b>line console</b> command.	Router(config-line) #	To go to global configuration mode, use the <b>exit</b> command.  To return to privileged EXEC mode, press <b>Ctrl-Z</b> or enter <b>end</b> .	Use this mode to configure parameters for the terminal line.

## Understanding the Help System

Enter a question mark (?) at the system prompt to display a list of commands available for each command mode. You can also obtain a list of associated keywords and arguments for any command, as shown in [Table 5-2](#).

Table 5-2 Help Summary

Command	Purpose
<b>help</b>	Obtain a brief description of the help system in any command mode.
<i>abbreviated-command-entry?</i>	Obtain a list of commands that begin with a particular character string.  For example: Router# <b>di?</b> dir disable disconnect
<i>abbreviated-command-entry&lt;Tab&gt;</i>	Complete a partial command name.  For example: Router# <b>sh conf</b> <tab> Router# <b>show configuration</b>
<b>?</b>	List all commands available for a particular command mode.  For example: Router> <b>?</b>

Table 5-2 Help Summary (continued)

Command	Purpose
<i>command ?</i>	List the associated keywords for a command. For example: Router> <b>show ?</b>
<i>command keyword ?</i>	List the associated arguments for a keyword. For example: Router(config)# <b>cdp holdtime ?</b> <10-255> Length of time (in sec) that receiver must keep this packet

## Understanding Abbreviated Commands

You need to enter only enough characters for the router to recognize the command as unique.

This example shows how to use the **show configuration** privileged EXEC command in an abbreviated form:

```
Router# show conf
```

## Understanding no and default Forms of Commands

Almost every configuration command also has a **no** form. In general, use the **no** form to disable a feature or function, or reverse the action of a command. For example, the **no shutdown** interface configuration command reverses the shutdown of an interface. Use the command without the keyword **no** to re-enable a disabled feature or to enable a feature that is disabled by default.

Configuration commands can also have a **default** form. The **default** form of a command returns the command setting to its default. Most commands are disabled by default, so the **default** form is the same as the **no** form. However, some commands are enabled by default and have variables set to certain default values. In these cases, the **default** command enables the command and sets variables to their default values.

## Understanding CLI Error Messages

Table 5-3 lists some error messages that you might encounter while using the CLI to configure your router.



**Table 5-3 Common CLI Error Messages**

Error Message	Meaning	How to Get Help
% Ambiguous command: "show con"	You did not enter enough characters for your router to recognize the command.	Re-enter the command followed by a question mark (?) with a space between the command and the question mark.  The possible keywords that you can enter with the command appear.
% Incomplete command.	You did not enter all the keywords or values required by this command.	Re-enter the command followed by a question mark (?) with a space between the command and the question mark.  The possible keywords that you can enter with the command appear.
% Invalid input detected at '^' marker.	You entered the command incorrectly. The caret (^) marks the point of the error.	Enter a question mark (?) to display all the commands that are available in this command mode.  The possible keywords that you can enter with the command appear.

## Using Command History

The software provides a history or record of commands that you entered. The command history feature is particularly useful for recalling long or complex commands or entries, including access lists. You can customize this feature to suit your needs as described in these sections:

- [Changing the Command History Buffer Size, page 5-5](#) (optional)
- [Recalling Commands, page 5-6](#) (optional)
- [Disabling the Command History Feature, page 5-6](#) (optional)

## Changing the Command History Buffer Size

By default, the router records ten command lines in its history buffer. You can alter this number for a current terminal session or for all sessions on a particular line. These procedures are optional.

Beginning in privileged EXEC mode, enter this command to change the number of command lines that the router records during the current terminal session:

```
Router# terminal history [size number-of-lines]
```

The range is from 0 to 256.

Beginning in line configuration mode, enter this command to configure the number of command lines the router records for all sessions on a particular line:

```
Router(config-line)# history [size number-of-lines]
```

The range is from 0 to 256.

## Recalling Commands

To recall commands from the history buffer, perform one of the actions listed in [Table 5-4](#). These actions are optional.

**Table 5-4** *Recalling Commands*

Action <sup>1</sup>	Result
Press <b>Ctrl-P</b> or the up arrow key.	Recall commands in the history buffer, beginning with the most recent command. Repeat the key sequence to recall successively older commands.
Press <b>Ctrl-N</b> or the down arrow key.	Return to more recent commands in the history buffer after recalling commands with <b>Ctrl-P</b> or the up arrow key. Repeat the key sequence to recall successively more recent commands.
<b>show history</b>	While in privileged EXEC mode, list the last several commands that you just entered. The number of commands that appear is controlled by the setting of the <b>terminal history</b> global configuration command and the <b>history</b> line configuration command.

1. The arrow keys function only on ANSI-compatible terminals such as VT100s.

## Disabling the Command History Feature

The command history feature is automatically enabled. You can disable it for the current terminal session or for the command line. These procedures are optional.

To disable the feature during the current terminal session, use the **terminal no history** privileged EXEC command.

To disable command history for the line, use the **no history** line configuration command.

## Using Editing Features

This section contains the following the editing features that can help you manipulate the command line.

- [Enabling and Disabling Editing Features, page 5-6](#) (optional)
- [Editing Commands through Keystrokes, page 5-7](#) (optional)
- [Editing Command Lines that Wrap, page 5-8](#) (optional)

## Enabling and Disabling Editing Features

Although the enhanced editing mode is automatically enabled, you can disable it, re-enable it, or configure a specific line to have enhanced editing. These procedures are optional.

To globally disable enhanced editing mode, enter this command in line configuration mode:

```
Router (config-line)# no editing
```

To re-enable the enhanced editing mode for the current terminal session, enter this command in privileged EXEC mode:

```
Router# terminal editing
```

To reconfigure a specific line to have enhanced editing mode, enter this command in line configuration mode:

```
Router(config-line)# editing
```

## Editing Commands through Keystrokes

Table 5-5 shows the keystrokes that you need to edit command lines. These keystrokes are optional.

**Table 5-5** *Editing Commands through Keystrokes*

Capability	Keystroke <sup>1</sup>	Purpose
Move around the command line to make changes or corrections.	Press <b>Ctrl-B</b> , or press the left arrow key.	Move the cursor back one character.
	Press <b>Ctrl-F</b> , or press the right arrow key.	Move the cursor forward one character.
	Press <b>Ctrl-A</b> .	Move the cursor to the beginning of the command line.
	Press <b>Ctrl-E</b> .	Move the cursor to the end of the command line.
	Press <b>Esc B</b> .	Move the cursor back one word.
	Press <b>Esc F</b> .	Move the cursor forward one word.
Recall commands from the buffer and paste them in the command line. The router provides a buffer with the last ten items that you deleted.	Press <b>Ctrl-Y</b> .	Recall the most recent entry in the buffer.
	Press <b>Esc Y</b> .	Recall the next buffer entry. The buffer contains only the last 10 items that you have deleted or cut. If you press <b>Esc Y</b> more than ten times, you cycle to the first buffer entry.
Delete entries if you make a mistake or change your mind.	Press the <b>Delete</b> or <b>Backspace</b> key.	Erase the character to the left of the cursor.
	Press <b>Ctrl-D</b> .	Delete the character at the cursor.
	Press <b>Ctrl-K</b> .	Delete all characters from the cursor to the end of the command line.
	Press <b>Ctrl-U</b> or <b>Ctrl-X</b> .	Delete all characters from the cursor to the beginning of the command line.
	Press <b>Ctrl-W</b> .	Delete the word to the left of the cursor.
Capitalize or lower the case or capitalize a set of letters.	Press <b>Esc D</b> .	Delete from the cursor to the end of the word.
	Press <b>Esc C</b> .	Capitalize at the cursor.
	Press <b>Esc L</b> .	Change the word at the cursor to lowercase.
	Press <b>Esc U</b> .	Capitalize letters from the cursor to the end of the word.

Table 5-5 Editing Commands through Keystrokes (continued)

Capability	Keystroke <sup>1</sup>	Purpose
Designate a particular keystroke as an executable command, perhaps as a shortcut.	Press <b>Ctrl-V</b> or <b>Esc Q</b> .	
Scroll down a line or screen on displays that are longer than the terminal screen can display.  <b>Note</b> The More prompt is used for any output that has more lines than can be displayed on the terminal screen, including <b>show</b> command output. You can use the <b>Return</b> and <b>Space</b> bar keystrokes whenever you see the More prompt.	Press the <b>Return</b> key.	Scroll down one line.
	Press the <b>Space</b> bar.	Scroll down one screen.
Redisplay the current command line if the router suddenly sends a message to your screen.	Press <b>Ctrl-L</b> or <b>Ctrl-R</b> .	Redisplay the current command line.

1. The arrow keys function only on ANSI-compatible terminals such as VT100s.

## Editing Command Lines that Wrap

You can use a wraparound feature for commands that extend beyond a single line on the screen. When the cursor reaches the right margin, the command line shifts ten spaces to the left. You cannot see the first ten characters of the line, but you can scroll back and check the syntax at the beginning of the command. The keystroke actions are optional.

To scroll back to the beginning of the command entry, press **Ctrl-B** or the left arrow key repeatedly. You can also press **Ctrl-A** to immediately move to the beginning of the line.



### Note

The arrow keys function only on ANSI-compatible terminals such as VT100s.

In this example, the **access-list** global configuration command entry extends beyond one line. When the cursor first reaches the end of the line, the line is shifted ten spaces to the left and redisplayed. The dollar sign (\$) shows that the line has been scrolled to the left. Each time the cursor reaches the end of the line, the line is again shifted ten spaces to the left.

```
Router(config)# access-list 101 permit tcp 131.108.2.5 255.255.255.0 131.108.1
Router(config)# $ 101 permit tcp 131.108.2.5 255.255.255.0 131.108.1.20 255.25
Router(config)# $t tcp 131.108.2.5 255.255.255.0 131.108.1.20 255.255.255.0 eq
Router(config)# $108.2.5 255.255.255.0 131.108.1.20 255.255.255.0 eq 45
```

After you complete the entry, press **Ctrl-A** to check the complete syntax before pressing the **Return** key to execute the command. The dollar sign (\$) appears at the end of the line to show that the line has been scrolled to the right:

```
Router(config)# access-list 101 permit tcp 131.108.2.5 255.255.255.0 131.108.1$
```

The software assumes you have a terminal screen that is 80 columns wide. If you have a width other than that, use the **terminal width** privileged EXEC command to set the width of your terminal.

Use line wrapping with the command history feature to recall and modify previous complex command entries. For information about recalling previous command entries, see the “[Editing Commands through Keystrokes](#)” section on page 5-7.

## Searching and Filtering Output of show and more Commands

You can search and filter the output for **show** and **more** commands. This is useful when you need to sort through large amounts of output or if you want to exclude output that you do not need to see. Using these commands is optional.

To use this functionality, use **show** or **more** command followed by the *pipe* character (`|`), one of the keywords **begin**, **include**, or **exclude**, and an expression that you want to search for or filter out:

```
command | {begin | include | exclude} regular-expression
```

Expressions are case sensitive. For example, if you use **exclude output** command, the lines that contain *output* are not displayed, but the lines that contain *Output* appear.

This example shows how to include in the output display only lines where the expression *protocol* appears:

```
Router# show interfaces | include protocol
Vlan1 is up, line protocol is up
Vlan10 is up, line protocol is down
GigabitEthernet0/1 is up, line protocol is down
GigabitEthernet0/2 is up, line protocol is up
```

## Accessing the CLI

You can access the CLI through a console connection, through Telnet, or by using the browser.

### Accessing the CLI through a Console Connection or through Telnet

Before accessing the CLI, you must connect a terminal or PC to the router console port and power on the router as described in the hardware installation guide that shipped with your router.

If your router is already configured, you can access the CLI through a local console connection or through a remote Telnet session, but your router must first be configured for this type of access..

You can use one of these methods to establish a connection with the router:

- Connect the router console port to a management station or dial-up modem. For information about connecting to the console port, see the router hardware installation guide.
- Use any Telnet TCP/IP or encrypted Secure Shell (SSH) package from a remote management station. The router must have network connectivity with the Telnet or SSH client, and the router must have an enable secret password configured.

The router supports up to 16 simultaneous Telnet sessions. Changes made by one Telnet user are reflected in all other Telnet sessions.

The router supports up to five simultaneous secure SSH sessions.

After you connect through the console port, through a Telnet session or through an SSH session, the user EXEC prompt appears on the management station.

## Saving Configuration Changes

To save your configuration changes to NVRAM, so that the changes are not lost during a system reload or power outage, enter the **copy running-config startup-config** command. For example:

```
Router# copy running-config startup-config  
Router# write memory  
Building configuration...
```

It might take a few minutes to save the configuration to NVRAM. After the configuration has been saved, the following message appears:

```
[OK]  
Router#
```

For additional information about using the Cisco IOS Release 15.1SNG, see the guides listed at:

[http://www.cisco.com/en/US/products/ps11280/tsd\\_products\\_support\\_series\\_home.html](http://www.cisco.com/en/US/products/ps11280/tsd_products_support_series_home.html)



# Software Upgrade

---

This chapter explains how to upgrade the Cisco IOS image installed on the Cisco ASR 901 router.

## Contents

- [Selecting a Cisco IOS Image](#)
- [Upgrading the Cisco IOS image](#)
- [Auto Upgrading the MCU](#)
- [Manually Upgrading the ROMMON](#)
- [Auto Upgrade of ROMMON](#)

## Selecting a Cisco IOS Image

When you select the Cisco IOS image for upgrade, consider the following:

- **Memory requirement**—The router should have sufficient disk or flash memory to store the Cisco IOS. The router should also have sufficient memory (DRAM) to run the Cisco IOS. The recommended logging buffer in DRAM ranges from 8 kilobytes to 64 kilobytes. If the router does not have sufficient memory (DRAM), the router will have boot problems when it boots through the new Cisco IOS.
- **Interfaces and modules support**—You must ensure that the new Cisco IOS supports all the interfaces and modules in the router.
- **Software feature support**—You must ensure that the new Cisco IOS supports the features used with the old Cisco IOS.

## Upgrading the Cisco IOS image

Complete the following steps to upgrade the Cisco IOS image:

---

- Step 1** Download the Cisco IOS software image to the TFTP server.
- Download the Cisco IOS software image onto your workstation or PC from the Download Software Area (registered customers only).

**Step 2** Identify the file system to copy the image.

The file system type 'flash' or 'disk' is used to store the Cisco IOS image. The **show file system** command lists the file systems available on the router. The file system should have sufficient space to store the Cisco IOS image. You can use the **show file system** or the **dir file\_system** command in order to find the free space.

```
Router# show file system
File Systems:
Size(b)      Free(b)      Type  Flags  Prefixes
          262144      240157  nvram  rw    nvram:
          -          -      opaque rw    system:
          -          -      opaque rw    tmpsys:
          -          -      opaque rw    null:
          -          -      opaque ro    tar:
          -          -      network rw    tftp:
          -          -      opaque wo    syslog:
* 100401148    39104096    flash rw    flash:
  67108860    67108860    flash rw    ramdisk:
          -          -      network rw    rcp:
          -          -      network rw    ftp:
          -          -      network rw    http:
          -          -      network rw    scp:
          -          -      opaque ro    cns:
```

**Step 3** Prepare for the upgrade.

You should consider these items before you upgrade the Cisco IOS:

- Store both the old Cisco IOS and the new Cisco IOS, if the router has sufficient memory. You can boot the router in the ROMMON mode and boot the old Cisco IOS, in case of boot failure with new Cisco IOS. This method saves time if you want to roll back the Cisco IOS.
- Backup the configuration from the router because some of the Cisco IOS releases add default configurations. This newly added configuration may conflict with your current configuration. Compare the configuration of the router after the Cisco IOS upgrade with the configuration backed up before the upgrade. If there are differences in the configuration, you must ensure they do not affect your requirements.

**Step 4** Verify that the TFTP server has IP connectivity to the router.

The TFTP server must have a network connection to the router and must be able to ping the IP address of the router targeted for a TFTP software upgrade. In order to achieve this connection, the router interface and the TFTP server must have an IP address in the same range or a default gateway configured. Check the IP address of the TFTP server in order to verify this configuration.

**Step 5** Copy the IOS Image from the TFTP server.

Before you copy the image, ensure that you have started the TFTP server software on your PC, and that you have the file name mentioned in the TFTP server root directory. Cisco recommends that you keep a backup of the router and access server configuration before you upgrade. The upgrade does not affect the configuration, which is stored in nonvolatile RAM [NVRAM]. However, this situation might happen if the right steps are not followed properly.

```
Router# copy tftp: flash:
Address or name of remote host []? 10.105.33.135
Source filename []? asr901-universalk9-mz.151-2.SNG
Destination filename [asr901-universalk9-mz.151-2.SNG]?
Accessing tftp://10.105.33.135/asr901-universalk9-mz.151-2.SNG...
Erase flash: before copying? [confirm]n
Loading asr901-universalk9-mz.151-2.SNG from 10.105.33.135 (via FastEthernet0/0):
!!!!!!!!!!!!!!!!!!!!!!!!!!!!!!!!!!!!!!!!!!!!!!!!!!!!!!!!!!!!!!!!!!!!!!!!!!!!!!!!!!!!!!!!!!!!!!!!!!!!!!!!!!!!!!!!!!!!!!!!
!!!!!!!!!!!!!!!!!!!!!!!!!!!!!!!!!!!!!!!!!!!!!!!!!!!!!!!!!!!!!!!!!!!!!!!!!!!!!!!!!!!!!!!!!!!!!!!!!!!!!!!!!!!!!!!!!!!!!!!!
[OK - 30551884 bytes]
```



```
Verifying checksum... OK (0xC7E6)
30551884 bytes copied in 199.636 secs (153038 bytes/sec)
Router#
```

**Step 6** Verify the Cisco IOS image in the file system.

```
Router# dir flash:
Directory of flash:/

 1  -rw-   30551884                <no date>  asr901-universalk9-mz.151-2.SNG

100401148 bytes total (69849200 bytes free)
Router#
```

```
Router# verify flash:asr901-universalk9-mz.151-2.SNG

File system hash verification successful.
```

**Step 7** Verify the Configuration Register.

Use the **show version** command to check the config-register value. The value is displayed in the last line of the show version output. It should be set to 0x2102.

```
Router# configure terminal
Enter configuration commands, one per line. End with CNTL/Z.

Router(config)# config-register 0x2102
Router(config)#^Z
```

**Step 8** Verify the Boot Variable

The router tries to boot with the first file in the Flash. If the first file is not the Cisco IOS Software image, you need to configure a boot system statement in order to boot the specified image. If there is only one file in Flash and it is the Cisco IOS Software image, this step is not necessary.

```
Router#show run | inc boot
boot-start-marker
boot system flash asr901-universalk9-mz.151-2.SNG.fc1
boot-end-marker
Router#
Router#conf t
Enter configuration commands, one per line. End with CNTL/Z.
Router(config)#no boot system
Router(config)#boot system flash asr901-universalk9-mz.151-2.SNG
Router(config)#end
Router#
Router#show run | inc boot
boot-start-marker
boot system flash asr901-universalk9-mz.151-2.SNG
boot-end-marker
Router#
```

**Step 9** Save the configuration and reload the router.

```
Router# write memory
Router# reload
Proceed with reload? [confirm]
Jul 24 20:17:07.787: %SYS-5-RELOAD: Reload requested by console. Reload Reason:
Reload Command.
```

**Step 10** Verify the Cisco IOS upgrade.

After the reload is complete, the router should run the desired Cisco IOS Software image. Use the **show version** command in order to verify the Cisco IOS software.

```
Router# show version
Cisco IOS Software, 901 Software (ASR901-UNIVERSALK9-M), Version 15.1(2)SNG, RELEASE
SOFTWARE (fc3)
Technical Support: http://www.cisco.com/techsupport
Copyright (c) 1986-2011 by Cisco Systems, Inc.
Compiled Thu 27-Oct-11 15:52 by prod_rel_team

ROM: System Bootstrap, Version 15.1(2r)SNG, RELEASE SOFTWARE (fc1)

ASR901 uptime is 4 minutes
System returned to ROM by reload at 13:11:07 UTC Wed Apr 19 2000
System image file is "tftp://10.105.33.135/rajuvenk/asr901-universalk9-mz.151-2.SNG.bin"
Last reload type: Normal Reload
Last reload reason: Reload Command
```

This product contains cryptographic features and is subject to United States and local country laws governing import, export, transfer and use. Delivery of Cisco cryptographic products does not imply third-party authority to import, export, distribute or use encryption. Importers, exporters, distributors and users are responsible for compliance with U.S. and local country laws. By using this product you agree to comply with applicable laws and regulations. If you are unable to comply with U.S. and local laws, return this product immediately.

A summary of U.S. laws governing Cisco cryptographic products may be found at: <http://www.cisco.com/wwl/export/crypto/tool/stqrg.html>

If you require further assistance please contact us by sending email to [export@cisco.com](mailto:export@cisco.com).

```
License Level: AdvancedMetroIPAccess
License Type: Permanent
Next reload license Level: AdvancedMetroIPAccess
```

```
Cisco ASR901-E (P2020) processor (revision 1.0) with 393216K/131072K bytes of memory.
Processor board ID CAT1529U01P
P2020 CPU at 792MHz, E500v2 core, 512KB L2 Cache
1 FastEthernet interface
12 Gigabit Ethernet interfaces
1 terminal line
256K bytes of non-volatile configuration memory.
98304K bytes of processor board System flash (Read/Write)
65536K bytes of processor board RAM Disk (Read/Write)
```

```
Configuration register is 0x2102
```

## Auto Upgrading the MCU

Upgradable MCU is bundled with the IOS image. You can upgrade the MCU using one of the following ways:

- MCU Auto upgrade can be enabled or disabled by setting the ROMMON variable `AUTO_UPGRADE_ROMMON` to `TRUE` or `FALSE`:

- From the ROMMON:  
rommon> **AUTO\_UPGRADE\_MCU=TRUE | FALSE**
- From the IOS:  
Router# **upgrade mcu preference [enable | disable]**

Once the MCU is upgraded, the router is not reloaded. Subsequent reload versions are compared; if the versions are same, then the MCU is not upgraded.

- If the `AUTO_UPGRADE_ROMMON` variable is set to `FALSE`, then the MCU can be upgraded as follows:

Router# **upgrade mcu file flash:image.hex**

## Manually Upgrading the ROMMON

Complete the following steps to manually upgrade the router ROMMON:

- 
- Step 1** Load the IOS image.
- Step 2** Copy the upgradable ROMMON file `ASR901_RM2.srec`, to the flash memory.
- Step 3** Upgrade the ROMMON using the following command:  
Router# **upgrade rom-monitor file flash:ASR901\_RM2.srec**  
The router reloads and comes up with upgradable ROMMON.
- Step 4** Check the status of the currently running ROMMON using any one of the following commands:
- From the ROMMON:  
rommon> **showmon**
  - From the IOS:  
router> **show rom-monitor**



---

**Note** While upgrade is in progress, if something goes wrong like power-off or power cyclers removed, or if the erase program is not done properly, you can reset the board. It falls back to the read-only rommon.

---

After the ROMMON upgrade, if you need to fall back to either the read-only ROMMON, or the upgrade ROMMON, use any one of the following commands:

- From the IOS:  
Router# **upgrade rom-monitor preference readonly | upgrade**
- From the ROMMON:  
rommon> **rommon-pref readonly**

# Auto Upgrade of ROMMON

Upgradable rommon is bundled with the IOS image. You can do an auto upgrade of the ROMMON using one of the following ways:

- Rommon Auto upgrade can be enabled or disabled with by setting the rommon variable `AUTO_UPGRADE_ROMMON` to `TRUE` or `FALSE` using the following commands:

- From the ROMMON:

```
rommon> AUTO_UPGRADE_ROMMON=TRUE | FALSE
```

- From the IOS:

```
Router# upgrade rom-monitor preference autoupgrade enable | disable
```

By default, the upgrade variable is set to be `TRUE`.

Once the ROMMON is upgraded, the IOS falls back to the ROMMON. Subsequent reload versions are compared; if the version is the same, then the ROMMON will not be upgraded.

- If the `AUTO_UPGRADE_ROMMON` variable is set to `FALSE`, use the following command in IOS, to upgrade:

```
Router# upgrade rom-monitor internal
```



# Configuring Gigabit Ethernet Interfaces

This chapter explains how to configure the Gigabit Ethernet (GE) interface on the Cisco ASR 901 router.

## Contents

- [Configuring the Interface, page 7-1](#)
- [Setting the Speed and Duplex Mode, page 7-2](#)
- [Enabling the Interface, page 7-3](#)
- [Modifying MTU Size on the Interface, page 7-3](#)
- [MAC Flap Control, page 7-5](#)
- [Configuring a Combo Port, page 7-6](#)

## Configuring the Interface

To configure the GE interface, complete the following steps:



**Note**

In the following procedure, press the **Return** key after each step unless otherwise noted. At any time, you can exit the privileged level and return to the user level by entering **disable** at the Router# prompt.

	Command	Purpose
Step 1	<code>enable</code>  <b>Example:</b> Router> <code>enable</code> Router#	Enters enable mode.
Step 2	<code>configure terminal</code>  <b>Example:</b> Router# <code>configure terminal</code> Router(config)#	Enters configuration mode.

	Command	Purpose
Step 3	<code>interface gigabitethernet slot/port</code>  <b>Example:</b> Router(config)# <code>interface gigabitethernet 0/1</code>	Specifies the port adapter type and the location of the interface to be configured. The <i>slot</i> is always 0 and the <i>port</i> is the number of the port.
Step 4	<code>cdp enable</code>  <b>Example:</b> Router(config-if)# <code>cdp enable</code>	Enables Cisco Discovery Protocol on the router, use the <code>cdp enable</code> command.
Step 5	<code>end</code>  <b>Example:</b> Router(config-if)# <code>end</code>  Router#	Exits configuration mode.

## Setting the Speed and Duplex Mode

The Gigabit Ethernet ports of the Cisco ASR 901 router can run in full or half- duplex mode—100 Mbps or 1000 Mbps (1 Gbps). The Cisco ASR 901 router has an autonegotiation feature that allows the router to negotiate the speed and duplex mode with the corresponding interface at the other end of the connection.

Autonegotiation is the default setting for the speed and transmission mode.

When you configure an interface speed and duplex mode, follow these guidelines:

- If both ends of the line support autonegotiation, use the default autonegotiation settings.
- When autonegotiation is turned on, it autonegotiates both speed and the duplex mode.
- If one interface supports autonegotiation, and the interface at the other end does not, configure the duplex mode and speed on both interfaces. If you use the autonegotiation setting on the supported side, the duplex mode setting is set at half-duplex.
- For Giga Ethernet ports with copper cable, autonegotiation should always be enabled for operating at 1000Mbps speed.
- Auto-negotiation must be enabled for 1000M full duplex Gigabit Ethernet devices; otherwise behavior is unpredictable.



### Note

Speed and duplex can be configured only on the following interfaces:

- Copper gigabitethernet interfaces (0/0-3)
- Combo gigabitethernet interface (0/4-7), when the media type is configured as RJ-45



### Note

In the following procedure, press the **Return** key after each step unless otherwise noted. At any time, you can exit the privileged level and return to the user level by entering **disable** at the Router# prompt.

To configure speed and duplex operation, complete these steps in the interface configuration mode:

	Command	Purpose
Step 1	<code>duplex [auto   half   full]</code>  <b>Example:</b> Router(config-if)# <code>duplex auto</code>	Specify the duplex operation.
Step 2	<code>speed [auto   1000   100]</code>  <b>Example:</b> Router(config-if)# <code>speed auto</code>	Specify the speed.

## Enabling the Interface

To enable the interface, complete these steps:



### Note

In the following procedure, press the **Return** key after each step unless otherwise noted. At any time, you can exit the privileged level and return to the user level by entering **disable** at the Router# prompt.

	Command	Purpose
Step 1	<code>interface gigabitethernet slot/port</code>  <b>Example:</b> Router(config)# <code>interface gigabitethernet 0/1</code>	Specify the port adapter type and the location of the interface to be configured. The <i>slot</i> is always 0 and the <i>port</i> is the number of the port.
Step 2	<code>no shutdown</code>	Enable the gigabit Ethernet interface using the <b>no shutdown</b> command.

## Modifying MTU Size on the Interface

Complete the following steps to modify the MTU size on Gigabit Ethernet interface:

### SUMMARY STEPS

1. `enable`
2. `configure terminal`
3. `interface gigabitethernet slot/port`
4. `mtu bytes`

## DETAILED STEPS

	Command	Purpose
Step 1	<b>enable</b>  <b>Example:</b> Router> enable	Enables privileged EXEC mode. <ul style="list-style-type: none"> <li>Enter your password if prompted.</li> </ul>
Step 2	<b>configure terminal</b>  <b>Example:</b> Router# configure terminal	Enters global configuration mode.
Step 3	<b>interface gigabitethernet slot/port</b>  <b>Example:</b> Router(config)# interface gigabitethernet 0/1	Selects a Gigabit Ethernet interface and enters interface configuration mode. <ul style="list-style-type: none"> <li><i>slot/port</i>—Specifies the slot and port number.</li> </ul>
Step 4	<b>mtu bytes</b>  <b>Example:</b> Router(config-if)# mtu 6000	Configures the MTU size for Gigabit Ethernet interface. <ul style="list-style-type: none"> <li><i>bytes</i>—The range is from 1500 to 9216. The default is 9216.</li> </ul> <p><b>Note</b> To set the MTU size to its default value, use the <b>no mtu</b> or <b>default mtu</b> command.</p>

## Verifying the MTU Size

To verify the MTU size, use the **show interface gigabitethernet** and **show interface mtu** commands.

```
Router# show interface gigabitethernet 0/1
GigabitEthernet0/1 is up, line protocol is up (connected)
  Hardware is Gigabit Ethernet, address is 4055.398d.bd05 (bia 4055.398d.bd05)
  MTU 6000 bytes, BW 1000000 Kbit/sec, DLY 10 usec,
    reliability 255/255, txload 1/255, rxload 1/255
  Encapsulation ARPA, loopback not set
  Keepalive set (10 sec)
  Full Duplex, 1000Mbps, link type is auto, media type is RJ45
  output flow-control is unsupported, input flow-control is unsupported
  ARP type: ARPA, ARP Timeout 04:00:00
  Last input never, output never, output hang never
  Last clearing of "show interface" counters 21:01:41
  Input queue: 0/200/0/0 (size/max/drops/flushes); Total output drops: 0
  Queueing strategy: fifo
  Output queue: 0/40 (size/max)
  5 minute input rate 0 bits/sec, 0 packets/sec
  5 minute output rate 0 bits/sec, 0 packets/sec
    0 packets input, 0 bytes, 0 no buffer
    Received 0 broadcasts (0 IP multicasts)
    0 runts, 0 giants, 0 throttles
    0 input errors, 0 CRC, 0 frame, 0 overrun, 0 ignored
    0 watchdog, 0 multicast, 0 pause input
    0 packets output, 0 bytes, 0 underruns
```

```
Router# show interface mtu
Port      Name          MTU
```



Gi0/0	9216
Gi0/1	6000
Gi0/2	3000
Gi0/3	9216
Gi0/4	9216
Gi0/5	9216
Gi0/6	9216
Gi0/7	9216
Gi0/8	9216
Gi0/9	9216
Gi0/10	9216
Gi0/11	9216

## MAC Flap Control

A MAC flap occurs when a switch receives packets from two different interfaces, with the same source MAC address. This happens when wrong configurations such as loops are introduced in networks. MAC flapping can cause CPU hogs and software induced crashes, if preventive action is not taken.

The two main aspects of MAC flap control feature are:

- Identification of MAC Flapping—Identified when MAC movement counter threshold is hit at specified time intervals.
- Preventive Action—Err-Disabling is done in one of the ports that has MAC flapping.

This feature is disabled by default and can be enabled or disabled through the CLI. You can configure the maximum number of MAC movements that are allowed in a specified time interval, beyond which the MAC movement is termed as flapping.

Once the port is err-disabled, it can be administratively brought up using the **shut** and **no shut** commands.

### Restrictions and Limitations

- If MAC learning is done in tens of thousands, the CPU may slow down. This feature does not address the slow down or CPU hog due to MAC learning.
- When the router is learning tens of thousands of MACs, and there are a couple of genuine MAC movements (not due to a loop), they are not tagged as MAC flapping since these are valid MAC movements.
- Average MAC Movement issue

For example, let us assume that MAC movement counter is configured for a maximum of 5 MAC movements in 10 seconds.

If 2000 MACs have contributed for 4 MAC movements each in 10 seconds, the total number of AC movements will be 8000. Since the individual MAC threshold is not hit in this case, the router does not take any preventive action. However, this condition may not really occur in practice.

## Configuring MAC Flap Control

Complete the following steps to configure MAC Flap control:

	Command	Purpose
Step 1	<b>configure terminal</b>	Enter global configuration mode.
	<b>Example:</b> Router# <b>configure terminal</b>	
Step 2	<b>mac-flap-ctrl on per-mac</b> <mac-movement> <time-interval>	Enable MAC flap control. <ul style="list-style-type: none"> <li>• mac-movement—Maximum number of MAC movements that are allowed in the specified time.</li> <li>• time-interval—Time interval that can elapse before the MAC movements are tagged as flapping.</li> </ul> <p>If values are not specified for the above parameters, the default values are taken by the router. The default values for the counters are five and ten; that is five movements in ten seconds.</p> <p>The <b>no</b> form of the command disables this feature.</p>
	<b>Example:</b> Router(config)# <b>mac-flap-ctrl on per-mac</b> <b>20 10</b>	

## Configuring a Combo Port

A combo port is considered as a single interface with dual front ends (an RJ-45 connector and an SFP module connector). The dual front ends of a combo port are non-redundant interfaces; the Cisco ASR 901 router activates only one connector of the pair. Combo ports can be configured as copper ports or small form-factor pluggable (SFP) module ports.

By default, the Cisco ASR 901 router selects the RJ-45 connector. However, you can use the **media-type** command to manually select the media type. When the media type is auto-select, the router gives preference to SFP module if both copper and fiber-optic signals are simultaneously detected.

### Restrictions

- When you configure SFP or RJ-45 media type, the non-configured media type is disabled even if there is a connector installed on the interface and no connector on the configured media type.
- When the media type is auto-select, the Cisco ASR 901 router configures both types with auto negotiation of speed and duplex.
- When the media type is auto-select, you cannot use 100M SFPs.
- When the media type is auto-select, you cannot use the **speed** and **duplex** commands.
- When the media type is auto-select, the Cisco ASR 901 router uses the following criteria to select the type:
  - If only one connector is installed, that interface is active and remains active until the media is removed or the router is reloaded.
  - If both media are installed in the combo port, the router gives preference to the SFP module interface.
  - If both media are installed in the combo port, when the SFP module interface is inactive, the RJ-45 connector is selected. When the SFP module interface recovers and becomes active, the RJ-45 connector is disabled and the router gives preference to the SFP module interface.

- If both media are installed in the combo port, and the router is reloaded or the port is disabled and then re-enabled through the **shutdown** and the **no shutdown** interface configuration commands, the router gives preference to the SFP module interface.

## SUMMARY STEPS

1. **enable**
2. **configure terminal**
3. **interface gigabitethernet *slot/port***
4. **media-type {auto-select | rj45 | sfp}**
5. **end**

## DETAILED STEPS

	Command	Purpose
Step 1	<b>enable</b>  <b>Example:</b> Router> enable	Enables privileged EXEC mode. <ul style="list-style-type: none"> <li>• Enter your password if prompted.</li> </ul>
Step 2	<b>configure terminal</b>  <b>Example:</b> Router# configure terminal	Enters global configuration mode.
Step 3	<b>interface gigabitethernet <i>slot/port</i></b>  <b>Example:</b> Router(config)# interface gigabitethernet 0/1	Selects a Gigabit Ethernet interface and enters interface configuration mode. <ul style="list-style-type: none"> <li>• <i>slot/port</i>—Specifies the slot and port number.</li> </ul>
Step 4	<b>media-type {auto-select   rj45   sfp}</b>  <b>Example:</b> Router(config-if)# media-type rj45	Configures the media type. <ul style="list-style-type: none"> <li>• <b>auto-select</b>—Specifies dynamic selection of the physical connection.</li> <li>• <b>rj45</b>—Specifies an RJ-45 physical connection.</li> <li>• <b>sfp</b>—Specifies an SFP physical connection for fiber media.</li> </ul>
Step 5	<b>end</b>  <b>Example:</b> Router(config-if)# end	Exits interface configuration mode and enters privileged EXEC mode.

## Verifying the Media Type

To verify the media type, use the **show interface gigabitethernet** command.

Following is a sample output when the media type is RJ-45:

```
Router# show interface gigabitethernet 0/1
GigabitEthernet0/1 is up, line protocol is up (connected)
  Hardware is Gigabit Ethernet, address is 4055.398d.bd05 (bia 4055.398d.bd05)
  MTU 9216 bytes, BW 1000000 Kbit/sec, DLY 10 usec,
    reliability 255/255, txload 1/255, rxload 1/255
  Encapsulation ARPA, loopback not set
  Keepalive set (10 sec)
  Full Duplex, 1000Mbps, link type is auto, media type is RJ45
  output flow-control is unsupported, input flow-control is unsupported
```

Following is a sample output when fiber-optic is selected as the physical connection:

```
Router# show interface gigabitethernet 0/7
GigabitEthernet0/7 is up, line protocol is up (connected)
  Hardware is Gigabit Ethernet, address is 4055.398d.bd0b (bia 4055.398d.bd0b)
  MTU 9216 bytes, BW 1000000 Kbit/sec, DLY 10 usec,
    reliability 255/255, txload 1/255, rxload 1/255
  Encapsulation ARPA, loopback not set
  Keepalive set (10 sec)
  Full Duplex, 1000Mbps, link type is auto, media type is SX
  output flow-control is unsupported, input flow-control is unsupported
```

Following is a sample output when the media type is auto-select and the interface is down:

```
Router# show interface gigabitethernet 0/7
GigabitEthernet0/7 is down, line protocol is down (notconnect)
  Hardware is Gigabit Ethernet, address is 0000.0000.0000 (bia 0000.0000.0000)
  MTU 9216 bytes, BW 1000000 Kbit/sec, DLY 10 usec,
    reliability 255/255, txload 1/255, rxload 1/255
  Encapsulation ARPA, loopback not set
  Keepalive set (10 sec)
  Full Duplex, 1000Mbps, link type is auto, media type is unknown
  output flow-control is unsupported, input flow-control is unsupported
```



# Configuring Ethernet Virtual Connections

Metro-Ethernet Forum (MEF) defines Ethernet Virtual Connection (EVC) as an association between two or more user network interfaces that identifies a point-to-point or multipoint-to-multipoint path within the service provider network. An EVC is a conceptual *service pipe* within the service provider network. A *bridge domain* is a local broadcast domain that is VLAN-ID-agnostic. An ethernet flow point (EFP) service instance is a logical interface that connects a bridge domain to a physical port or to an EtherChannel group in a router.

An EVC broadcast domain is determined by a bridge domain and the EFPs connected to it. You can connect multiple EFPs to the same bridge domain on the same physical interface, and each EFP can have its own matching criteria and rewrite operation. An incoming frame is matched against EFP matching criteria on the interface, learned on the matching EFP, and forwarded to one or more EFPs in the bridge domain. If there are no matching EFPs, the frame is dropped.

You can use EFPs to configure VLAN translation. For example, if there are two EFPs egressing the same interface, each EFP can have a different VLAN rewrite operation, which is more flexible than the traditional switchport VLAN translation model.



**Note** Cisco ASR 901 router does not support switch port configuration.

## Finding Feature Information

Your software release may not support all the features documented in this module. For the latest feature information and caveats, see the release notes for your platform and software release. To find information about the features documented in this module, and to see a list of the releases in which each feature is supported, see the “[Feature Information for Configuring Ethernet Virtual Connections](#)” section on page 8-33.

Use Cisco Feature Navigator to find information about platform support and Cisco software image support. To access Cisco Feature Navigator, go to <http://www.cisco.com/go/cfn>. An account on Cisco.com is not required.

## Contents

- [Supported EVC Features, page 8-2](#)
- [Understanding EVC Features, page 8-3](#)
- [Configuring EFPs, page 8-7](#)

- [Configuration Examples of Supported Features, page 8-10](#)
- [Configuration Examples of Unsupported Features, page 8-12](#)
- [How to Configure EVC Default Encapsulation, page 8-13](#)
- [Configuring Other Features on EFPs, page 8-16](#)
- [Monitoring EVC, page 8-28](#)
- [Sample Configuration with Switchport to EVC Mapping, page 8-29](#)

## Supported EVC Features

This section contains the following supported EVC features:

- Service instance—create, delete, and modify EFP service instances on Ethernet interfaces.
- Encapsulation—map traffic to EFPs based on:
  - 802.1Q VLANs (a single VLAN or a list or range of VLANs)
  - 802.1Q tunneling (QinQ) VLANs (a single outer VLAN and a list or range of inner VLANs)
  - Double-tagged frames mapped to EVC based on C-tags (wildcard S-Tags)
  - Cisco QinQ ethertype for S-tags
- Bridge domains—configure EFPs as members of a bridge domain (up to 64 EFPs per bridge domain).
- DHCP client—retrieves the host information from the DHCP server.
- Rewrite (VLAN translation)
  - Pop symmetric only—the supported rewrite configuration implies egress pushing (adding a tag)
    1. **pop 1** removes the outermost tag
    2. **pop symmetric** adds a tag on egress for a push operation
  - QinQ with rewrite
  - Ingress rewrite is not supported
- EVC forwarding
- MAC address learning and aging
- EVCs on EtherChannels
- Split horizon
- EVC MAC address security
- MSTP (MST on EVC bridge domain)
- EFP statistics (packets and bytes)
- QoS aware EVC/EFP per service instance
- Pop 2 configuration supports layer 2 and layer 3 operations. Additionally, it supports GigabitEthernet and port channel interfaces.

These Layer 2 port-based features can run with EVC configured on the port:

- LACP
- CDP
- MSTP

## Understanding EVC Features

This section contains the following topics:

- [Ethernet Virtual Connections, page 8-3](#)
- [Service Instances and EFPs, page 8-3](#)
- [Encapsulation, page 8-4](#)
- [Bridge Domains, page 8-5](#)
- [DHCP Client on Switch Virtual Interface](#)
- [Configuring Other Features on EFPs, page 8-16](#)
- [Rewrite Operations, page 8-6](#)

## Ethernet Virtual Connections

Use the **ethernet evc** *evc-id* global configuration command to create an EVC. The *evc-id* or name is a text string from 1 to 100 bytes. Using this command moves the device into service configuration mode (config-srv) where you configure all parameters that are common to an EVC.

In this mode you can use these commands:

- **default**—Sets a command to its defaults
- **exit**—Exits EVC configuration mode
- **no**—Negates a command or sets its defaults
- **oam**—Specifies the OAM Protocol
- **uni**—Configures a count UNI under EVC

## Service Instances and EFPs

Configuring a service instance on a Layer 2 port or EtherChannel creates an EFP on which you configure EVC features. Each service instance has a unique number per interface, but you can use the same number on different interfaces because service instances on different ports are not related.

If you defined an EVC by using the **ethernet evc** *evc-id* global configuration command, you can associate the EVC with the service instance (optional). There is no default behavior for a service instance. You can configure a service instance only on trunk ports with no allowed VLANs. Any other configuration is not allowed. After you have configured a service instance on an interface, switchport commands are not allowed on the interface. You can also configure a service instance on an EtherChannel group.

Use the **service instance** *number* **ethernet** [*name*] interface configuration command to create an EFP on a Layer 2 interface or EtherChannel and to enter service instance configuration mode. You use service instance configuration mode to configure all management and control data plane attributes and parameters that apply to the service instance on a per-interface basis.

- The **service instance** *number* is the EFP identifier, an integer from 1 to 8000.
- The optional **ethernet** *name* is the name of a previously configured EVC. You do not need to enter an EVC *name*, but you must enter **ethernet**. Different EFPs can share the same name when they correspond to the same EVC. EFPs are tied to a global EVC through the common name.

When you enter service instance configuration mode, you can configure these options:

- **default**—Sets a command to its defaults
- **description**—Adds a service instance specific description
- **encapsulation**—Configures Ethernet frame match criteria
- **ethernet**—Configures Ethernet-lmi parameters
- **exit**— Exits from service instance configuration mode
- **no**—Negates a command or sets its defaults
- **service-policy** —Attaches a policy-map to an EFP
- **shutdown**—Takes the service instance out of service

Enter the [**no**] **shutdown** service-instance configuration mode to shut down or bring up a service instance.

On a Layer 2 port with no service instance configured, multiple **switchport** commands are available (**access**, **backup**, **block**, **host**, **mode**, and **trunk**). When one or more service instances are configured on a Layer 2 port, no **switchport** commands are accepted on that interface.

## Encapsulation

Encapsulation defines the matching criteria that maps a VLAN, a range of VLANs, Ethertype, or a combination of these to a service instance. Configure encapsulation in the service instance configuration mode. You must configure one encapsulation command per EFP (service instance).

Use the **encapsulation** command in service-instance configuration mode to set the encapsulation criteria. Different types of encapsulations are dot1q, dot1ad, and untagged. Valid Ethertypes (type) are IPv4, PPPOE-All, PPPOE-Discover, and PPPOE-Session.

Encapsulation classification options also include:

- outer tag VLAN
- inner tag VLAN
- payload ethertype—any ethertype tag after the VLAN tag

After you enter an encapsulation method, these keyword options are available in service instance configuration mode:

- **bridge-domain**—Configures a bridge domain
- **rewrite**—Configures Ethernet rewrite criteria



**Table 8-1 Supported Encapsulation Types**

Command	Description
<b>encapsulation dot1q</b> <i>vlan-id</i> [, <i>vlan-id</i> [- <i>vlan-id</i> ]]	Defines the matching criteria to be used to map 802.1Q frames ingress on an interface to the appropriate EFP. The options are a single VLAN, a range of VLANs, or lists of VLANs or VLAN ranges. VLAN IDs are 1 to 4094. <ul style="list-style-type: none"> <li>Enter a single VLAN ID for an exact match of the outermost tag.</li> <li>Enter a VLAN range for a ranged outermost match.</li> </ul> <b>Note</b> VLAN IDs 4093, 4094, and 4095 are reserved for internal usage.
<b>encapsulation dot1q</b> <i>vlan-id</i> <b>second-dot1q</b> <i>vlan-id</i> [, <i>vlan-id</i> [- <i>vlan-id</i> ]]	Double-tagged 802.1Q encapsulation. Matching criteria to be used to map QinQ frames ingress on an interface to the appropriate EFP. The outer tag is unique and the inner tag can be a single VLAN, a range of VLANs or lists of VLANs or VLAN ranges. <ul style="list-style-type: none"> <li>Enter a single VLAN ID in each instance for an exact match of the outermost two tags.</li> <li>Enter a VLAN range for <b>second-dot1q</b> for an exact outermost tag and a ranged second tag.</li> </ul>
<b>encapsulation dot1ad</b> <i>vlan-id</i> [, <i>vlan-id</i> [- <i>vlan-id</i> ]] [ <i>native</i> ]	Defines the matching criteria to be used in order to map single-tagged 802.1ad frames ingress on an interface to the appropriate service instance. The criteria for this command are: single VLAN, range of VLANs and lists of the previous two.
<b>encapsulation untagged</b>	Matching criteria to be used to map untagged (native) Ethernet frames entering an interface to the appropriate EFP.  Only one EFP per port can have untagged encapsulation. However, a port that hosts EFP matching untagged traffic can also host other EFPs that match tagged frames.
<b>encapsulation default</b>	Configures default encapsulation.

If a packet entering or leaving a port does not match any of the encapsulations on that port, the packet is dropped, resulting in *filtering* on both ingress and egress. The encapsulation must match the packet *on the wire* to determine filtering criteria. *On the wire* refers to packets ingressing the router before any rewrites and to packets egressing the router after all rewrites.

**Note**

The router does not allow overlapping encapsulation configurations. See the “[Configuration Examples of Unsupported Features](#)” section on page 8-12.

## Bridge Domains

A service instance must be attached to a bridge domain. Flooding and communication behavior of a bridge domain is similar to that of a VLAN domain. Bridge-domain membership is determined by which service instances have joined it (based on encapsulation criteria), while VLAN domain membership is determined by the VLAN tag in the packet.

**Note**

You must configure encapsulation before you can configure the bridge domain.

Use the **bridge-domain** *bridge-id* service-instance command in the configuration mode to bind the EFP to a bridge domain instance. The *bridge-id* is the identifier for the bridge domain instance, a number ranging from 1 to 4094.

## DHCP Client on Switch Virtual Interface

The DHCP client retrieves the host information from the DHCP server and configures the SVI interface of the Cisco ASR 901 router. If the DHCP server is unable to provide the requested configuration parameters from its database to the DHCP client, it forwards the request to one or more secondary DHCP servers defined by the network administrator. DHCP helps you to dynamically assign reusable IP addresses to clients.

Hosts are connected to secondary VLANs, and the DHCP server assigns them IP addresses from the block of addresses assigned to the primary VLAN. When new devices are added, the DHCP server assigns them the next available address from a large pool of subnet addresses. In Cisco ASR 901 router, the DHCP client is supported only on SVI interfaces and for IPv4 addresses.

## Split-Horizon

The split-horizon feature allows service instances in a bridge domain to join groups. Service instances in the same bridge domain and split-horizon group cannot forward data between each other, but can forward data between other service instances that are in the same bridge domain, but not in the same split-horizon group.

Service instances do not have to be in a split-horizon group. If a service instance does not belong to a group, it can send and receive from all ports within the bridge domain. A service instance cannot join more than one split-horizon group.

Use the **bridge-domain *bridge-id* split-horizon group *group\_id*** service-instance command in the configuration mode to configure a split-horizon group. The *group\_id* is a number from 0 to 31. All members of the bridge-domain configured with the same *group\_id* are part of the same split-horizon group. EFPs that are not configured with an explicit *group\_id* do not belong to any group.

You can configure no more than 12 service instances per bridge domain. When a bridge domain contains a service instance that is part of a split-horizon group, this decreases the number of service instances allowed to be configured in that split-horizon group. The router supports up to 32 split-horizon groups plus the default (no group).

If a service instance joins split-horizon group, it can have no more than 12 members in split horizon group in the same bridge domain. We recommend that you add split horizon groups in numerical order to maximize the number of service instances that can belong to a group.

## Rewrite Operations

Use the **rewrite** command to modify packet VLAN tags. You can also use this command to emulate traditional 802.1Q tagging, where packets enter a router on the native VLAN and VLAN tagging properties are added on egress. You can also use the **rewrite** command to facilitate VLAN translation and QinQ.

Use the **rewrite ingress tag pop 1symmetric** service-instance configuration mode command to specify the encapsulation adjustment to be performed on the frame ingress to the EFP. Entering **pop 1** pops (removes) the outermost tag.



**Note**

---

The **symmetric** keyword is required to complete the **rewrite** configuration.

---

When you enter the **symmetric** keyword, the egress counterpart performs the inverse action and pushes (adds) the encapsulation VLAN. You can use the **symmetric** keyword only with ingress rewrites and only when single VLANs are configured in encapsulation. If you configure a list of VLANs or a VLAN range or **encapsulation default**, the **symmetric** keyword is not accepted for rewrite operations.

The Cisco ASR 901router supports only the following **rewrite** command.

```
rewrite ingress tag pop 1 symmetric
```

```
rewrite ingress tag pop 2 symmetric
```

The router does not support **rewrite** commands for **ingress push** and **translate** in this release. However, you can use the **rewrite ingress tag pop symmetric** command to achieve translation. Possible translation combinations are 1-to-1, 1-to-2, and 2-to-1.

The Cisco ASR 901 Series Aggregation Services Router does not support egress rewrite operations beyond the second VLAN that a packet carries into a router. See the “[Configuring Other Features on EFPs](#)” section on page 8-16.

## Configuring EFPs

This section contains the following topics:

- [Default EVC Configuration, page 8-7](#)
- [Configuration Guidelines, page 8-7](#)
- [Creating Service Instances, page 8-8](#)
- [Configuration Examples of Supported Features, page 8-10](#)
- [Configuration Examples of Unsupported Features, page 8-12](#)

## Default EVC Configuration

Cisco IOS Release 15.3(2)S introduces support for EVC default encapsulation on the Cisco ASR 901 routers. This feature matches and forwards all the ingress traffic on the port. The default service instance on a port is configured using the **encapsulation default** command.

All traffic coming to the interface with default encapsulation is matched and forwarded. This includes untagged, single tagged, and double tagged traffic. For example, when an untagged EFP is configured, all the traffic except the untagged traffic matches the default EFP.

All Layer 2 features are supported on the default EVC.

**Note**

Before Cisco IOS Release 15.3(2)S, EFPs or service instances or bridge domains were not configured.

## Configuration Guidelines

- You can configure up to 4000 bridge domains on the Cisco ASR 901 router.
- The number of bridge domains that you can configure depends on the license that is installed:
  - The metro services licenses support 4000 bridge domains.
  - The metro IP services licenses support 4000 bridge domains.

- All licenses support a maximum of 16 EFPs per bridge domain.
- You must configure encapsulation on a service instance before configuring bridge domain.
- When you configure a bridge domain between 1 and 4094, IGMP snooping is automatically disabled on the VLAN.
- ISL trunk encapsulation is not supported.
- When an EFP encapsulation is the default (matching or allowing all ingress frames), you cannot configure any other encapsulation on an EFP on the same port and bridge-domain as the default encapsulation. There can be only one default encapsulation per port.
- The router does not support overlapping configurations on the same interface and same bridge domain. If you have configured a VLAN range encapsulation, or encapsulation default on service instance 1, you cannot configure any other encapsulations that also match previous encapsulations in the same interface and bridge domain. See the “[Configuration Examples of Unsupported Features](#)” section on page 8-12.
- Default encapsulation is supported only on the physical interface and port channel interface.
- The **default encapsulation command** is accepted only for untagged EFP.
- If default encapsulation EVC is configured on the interface, only the untagged encapsulation is accepted and all other encapsulation commands are rejected.
- Default EFP under xconnect and untagged EFP under bridge-domain on the same interface is not supported.
- The **rewrite** command on encapsulation default EVC is rejected.
- Supports encapsulation only on bridge-domain and Xconnect.
- Supports only untagged EFPs on the port with default encapsulation.
- Egress filtering is not supported. All unlearned traffic ingresses on the default encapsulation interface is flooded to other interfaces that are part of the same bridge-domain.
- Layer 3 routing is not supported. Layer 2 VPN is supported on the default encapsulation EFP.
- QinQ configuration for Layer3 is not possible with pop1 rewrite. However pop2 configured routed QinQ is supported.
- Default xconnect MTU is 9216.
- For interoperability with other routers for an xconnect session, ensure that the MTU on both PE routers is same before the xconnect session is established.
- MPLS is not supported over routed QinQ.
- VLAN IDs 4093, 4094, and 4095 are reserved for internal usage.

## Creating Service Instances

Complete the following steps to create an EFP service instance:



### Note

The **dot1q** and **dot1ad** range configuration is not supported on the port channel interface on Cisco IOS Release 15.2(2)SNI.

	Command	Purpose
Step 1	<b>configure terminal</b>	Enter global configuration mode.
Step 2	<b>interface</b> <i>interface-id</i>	Specify the interface, and enter interface configuration mode. Valid interfaces are physical ports.
Step 3	<b>service instance</b> <i>number</i> <b>ethernet</b> [ <i>name</i> ]	Configure an EFP (service instance) and enter service instance configuration) mode. <ul style="list-style-type: none"> <li>The <i>number</i> is the EFP identifier, an integer from 1 to 4000.</li> <li>(Optional) <b>ethernet</b> <i>name</i> is the name of a previously configured EVC. You do not need to use an EVC name in a service instance.</li> </ul>
Step 4	<b>encapsulation</b> { <b>dot1q</b>   <b>dot1ad</b>   <b>untagged</b>   <b>default</b> }	Configure encapsulation type for the service instance. <ul style="list-style-type: none"> <li><b>dot1q</b>—Configure 802.1Q encapsulation. See <a href="#">Table 8-1</a> for details about options for this keyword.</li> <li><b>dot1ad</b>—Configure 802.1ad encapsulation.</li> <li><b>untagged</b>—Map to untagged VLANs. Only one EFP per port can have untagged encapsulation.</li> <li><b>default</b>—Configures default encapsulation.</li> </ul>
Step 5	<b>bridge-domain</b> <i>bridge-id</i> [ <b>split-horizon</b> <b>group</b> <i>group-id</i> ]	Configure the bridge domain ID. The range is from 1 to 4094. <ul style="list-style-type: none"> <li>(Optional) <b>split-horizon</b> <b>group</b> <i>group-id</i>—Configure a split-horizon group. The group ID is from 0 to 31. EFPs in the same bridge domain and split-horizon group cannot forward traffic between each other, but can forward traffic between other EFPs in the same bridge domain but not in the same split-horizon group.</li> </ul> <p><b>Note</b> You must configure encapsulation before the <b>bridge-domain</b> keyword is available.</p>
Step 6	<b>rewrite ingress tag pop 1 symmetric</b>	(Optional) Specify that encapsulation modification to occur on packets at ingress. <ul style="list-style-type: none"> <li><b>pop 1</b>—Pop (remove) the outermost tag.</li> <li><b>symmetric</b>—Configure the packet to undergo the reverse of the ingress action at egress. If a tag is popped at ingress, it is pushed (added) at egress.</li> </ul> <p><b>Note</b> Although the <b>symmetric</b> keyword appears to be optional, you must enter it for <b>rewrite</b> to function correctly.</p>
Step 7	<b>end</b>	Return to privileged EXEC mode.
Step 8	<b>show ethernet service instance</b> <b>show bridge-domain</b> [ <i>n</i>   <b>split-horizon</b> ]	Verify your entries.
Step 9	<b>copy running-config startup-config</b>	(Optional) Save your entries in the configuration file.

**Note**

Use the **no** forms of the commands to remove the service instance, encapsulation type, or bridge domain or to disable the rewrite operation.

# Configuration Examples of Supported Features

- [Example: Configuring a Service Instance](#)
- [Example: Encapsulation Using a VLAN Range](#)
- [Example: Two Service Instances Joining the Same Bridge Domain](#)
- [Example: Bridge Domains and VLAN Encapsulation](#)
- [Example: Rewrite](#)
- [Example: Split Horizon](#)

## Example: Configuring a Service Instance

```
Router (config)# interface gigabitethernet0/1
Router (config-if)# service instance 22 Ethernet [name]
Router (config-if-srv)# encapsulation dot1q 10
Router (config-if-srv)# bridge-domain 10
```

## Example: Encapsulation Using a VLAN Range

```
Router (config)# interface gigabitethernet0/1
Router (config-if)# service instance 22 Ethernet
Router (config-if-srv)# encapsulation dot1q 22-44
Router (config-if-srv)# bridge-domain 10
```

## Example: Two Service Instances Joining the Same Bridge Domain

In this example, service instance 1 on interfaces Gigabit Ethernet 0/1 and 0/2 can bridge between each other.

```
Router (config)# interface gigabitethernet0/1
Router (config-if)# service instance 1 Ethernet
Router (config-if-srv)# encapsulation dot1q 10
Router (config-if-srv)# bridge-domain 10
```

```
Router (config)# interface gigabitethernet0/2
Router (config-if)# service instance 1 Ethernet
Router (config-if-srv)# encapsulation dot1q 10
Router (config-if-srv)# bridge-domain 10
```

## Example: Bridge Domains and VLAN Encapsulation

Unlike VLANs, the bridge-domain number does not need to match the VLAN encapsulation number.

```
Router (config)# interface gigabitethernet0/1
Router (config-if)# service instance 1 Ethernet
Router (config-if-srv)# encapsulation dot1q 10
Router (config-if-srv)# bridge-domain 4000
```

```
Router (config)# interface gigabitethernet0/2
Router (config-if)# service instance 1 Ethernet
Router (config-if-srv)# encapsulation dot1q 10
Router (config-if-srv)# bridge-domain 4000
```

However, when encapsulations do not match in the same bridge domain, traffic cannot be forwarded. In this example, the service instances on Gigabit Ethernet 0/1 and 0/2 can not forward between each other, since the encapsulations don't match (filtering criteria). However, you can use the **rewrite** command to allow communication between these two.

```
Router (config)# interface gigabitethernet0/1
Router (config-if)# service instance 1 Ethernet
Router (config-if-srv)# encapsulation dot1q 10
Router (config-if-srv)# bridge-domain 4000
```

```
Router (config)# interface gigabitethernet0/2
Router (config-if)# service instance 1 Ethernet
Router (config-if-srv)# encapsulation dot1q 99
Router (config-if-srv)# bridge-domain 4000
```

## Example: Rewrite

In this example, a packet that matches the encapsulation will have one tag removed (popped off). The **symmetric** keyword allows the reverse direction to have the inverse action: a packet that egresses out this service instance will have the encapsulation (VLAN 10) added (pushed on).

```
Router (config)# interface gigabitethernet0/1
Router (config-if)# service instance 1 Ethernet
Router (config-if-srv)# encapsulation dot1q 10
Router (config-if-srv)# rewrite ingress tag pop 1 symmetric
Router (config-if-srv)# bridge-domain 4000
```

## Example: Split Horizon

In this example, service instances 1 and 2 cannot forward and receive packets from each other. Service instance 3 can forward traffic to any service instance in bridge domain 4000 since it has not joined any split-horizon groups.

```
Router (config)# interface gigabitethernet0/1
Router (config-if)# service instance 1 Ethernet
Router (config-if-srv)# encapsulation dot1q 10
Router (config-if-srv)# rewrite ingress pop 1 symmetric
Router (config-if-srv)# bridge-domain 4000 split-horizon group 1
Router (config-if-srv)# exit
```

```
Router (config)# interface gigabitethernet0/2
Router (config-if)# service instance 2 Ethernet
Router (config-if-srv)# encapsulation dot1q 99
Router (config-if-srv)# rewrite ingress pop 1 symmetric
Router (config-if-srv)# bridge-domain 4000 split-horizon group 1
Router (config-if-srv)# exit
```

```
Router (config)# interface gigabitethernet0/3
Router (config-if)# service instance 3 Ethernet
Router (config-if-srv)# encapsulation dot1q 99
Router (config-if-srv)# rewrite ingress pop 1 symmetric
Router (config-if-srv)# bridge-domain 4000
Router (config-if-srv)# exit
```

# Configuration Examples of Unsupported Features

- [Example: Filtering](#)
- [Example: Overlapping Encapsulation](#)

## Example: Filtering

In EVC switching, egress filtering is performed before the frame is sent on the egress EFP. Egress filtering ensures that when a frame is sent, it conforms to the matching criteria of the service instance applied on the ingress direction. EFP does not require egress filtering if the number of pops is the same as the number of VLANs specified in the **encapsulation** command.



### Note

Specifying the **cos** keyword in the encapsulation command is relevant only in the ingress direction. For egress filtering, **cos** is ignored.

```
Router (config)# interface gigabitethernet0/1
Router (config-if)# service instance 1 Ethernet
Router (config-if-srv)# encapsulation dot1q 20
Router (config-if-srv)# bridge-domain 19

Router (config)# interface gigabitethernet0/2
Router (config-if)# service instance 2 Ethernet
Router (config-if-srv)# encapsulation dot1q 30
Router (config-if-srv)# bridge-domain 19

Router (config)# interface gigabitethernet0/3
Router (config-if)# service instance 3 Ethernet
Router (config-if-srv)# encapsulation dot1q 10 second-dot1q 20
Router (config-if-srv)# rewrite ingress pop 1 symmetric
Router (config-if-srv)# bridge-domain 19
```

If a packet with VLAN tag 10 or 20 is received on Gigabit Ethernet 0/3, the ingress logical port would be service instance 3. For the frame to be forwarded on a service instance, the egress frame must match the encapsulation defined on that service instance after the rewrite is done. Service instance 1 checks for outermost VLAN 20; service instance 2 checks for VLAN 30. In this example, the frame with VLAN tags 10 and 20 can be sent to service instance 1 but not to service instance 2.

## Example: Overlapping Encapsulation

The router does not allow overlapping encapsulation. Overlapping encapsulation configuration occurs when two EFPs are configured on the same port and the same bridge domain and the set of encapsulations on one EFP is a subset of the encapsulations on the other EFP.

Service instance 2 configuration is rejected because service instance 1 **encapsulation dot1q any** is superset of service instance 2 **encapsulation dot1q 10**.

```
Router (config)# interface gigabitethernet 0/1
Router (config-if)# service instance 1 ethernet
Router (config-if-srv)# encapsulation dot1q any
Router (config-if-srv)# bridge-domain 10
Router (config-if-srv)# exit
Router (config-if)# service instance 2 ethernet
Router (config-if-srv)# encapsulation dot1q 10
Router (config-if-srv)# bridge-domain 10
```



# How to Configure EVC Default Encapsulation

- [Configuring EVC Default Encapsulation with Bridge-Domain](#)
- [Configuring EVC Default Encapsulation with Xconnect](#)
- [Verifying EVC Default Encapsulation with Bridge-Domain](#)
- [Verifying EVC Default Encapsulation with Xconnect](#)
- [Configuration Examples for EVC Default Encapsulation](#)

## Configuring EVC Default Encapsulation with Bridge-Domain

Complete the following steps to configure EVC default encapsulation for a bridge-domain.

### SUMMARY STEPS

1. **enable**
2. **configure terminal**
3. **interface** *type number*
4. **service instance** *instance-id* **ethernet**
5. **encapsulation default**
6. **bridge-domain** *bridge-id*

### DETAILED STEPS

	Command or Action	Purpose
Step 1	<b>enable</b>  <b>Example:</b> Router> enable	Enables privileged EXEC mode. <ul style="list-style-type: none"> <li>• Enter your password if prompted.</li> </ul>
Step 2	<b>configure terminal</b>  <b>Example:</b> Router# configure terminal	Enters global configuration mode.
Step 3	<b>interface</b> <i>type number</i>  <b>Example:</b> Router(config)# interface GigabitEthernet0/4	Specifies an interface type and number, and enters interface configuration mode.
Step 4	<b>service instance</b> <i>instance-id</i> <b>ethernet</b>  <b>Example:</b> Router(config-if)# service instance 10 ethernet	Creates a service instance on an interface and defines the matching criteria. <ul style="list-style-type: none"> <li>• <i>instance-id</i>—Integer that uniquely identifies a service instance on an interface.</li> </ul>

	Command or Action	Purpose
Step 5	<b>encapsulation default</b>  <b>Example:</b> Router(config-if-srv)# encapsulation default	Configures the default service instance.
Step 6	<b>bridge-domain <i>bridge-id</i></b>  <b>Example:</b> Router(config-if-srv)# bridge-domain 15	Binds the service instance to a bridge domain instance using an identifier.

## Configuring EVC Default Encapsulation with Xconnect

Complete the following steps to configure EVC default encapsulation for xconnect.



### Note

When default encapsulation is configured on xconnect, the Cisco ASR 901 router does not support untagged encapsulation on the bridge-domain of the same interface.

### SUMMARY STEPS

1. **enable**
2. **configure terminal**
3. **interface *type number***
4. **service instance *instance-id* ethernet**
5. **encapsulation default**
6. **xconnect *peer-ip-address* *vc-id* encapsulation mpls**

### DETAILED STEPS

	Command or Action	Purpose
Step 1	<b>enable</b>  <b>Example:</b> Router> enable	Enables privileged EXEC mode. <ul style="list-style-type: none"> <li>• Enter your password if prompted.</li> </ul>
Step 2	<b>configure terminal</b>  <b>Example:</b> Router# configure terminal	Enters global configuration mode.

	Command or Action	Purpose
Step 3	<b>interface</b> <i>type number</i>  <b>Example:</b> Router(config)# interface GigabitEthernet0/4	Specifies an interface type and number, and enters interface configuration mode.
Step 4	<b>service instance</b> <i>instance-id</i> <b>ethernet</b>  <b>Example:</b> Router(config-if)# service instance 10 ethernet	Creates a service instance on an interface and defines the matching criteria. <ul style="list-style-type: none"> <li>• <i>instance-id</i>—Integer that uniquely identifies a service instance on an interface.</li> </ul>
Step 5	<b>encapsulation default</b>  <b>Example:</b> Router(config-if)# encapsulation default	Configures the default service instance.
Step 6	<b>xconnect</b> <i>peer-ip-address</i> <i>vc-id</i> <b>encapsulation mpls</b>  <b>Example:</b> Router(config-if-srv)# xconnect 1.1.1.1 100 encapsulation mpls	Binds an attachment circuit to a pseudowire, and to configure an Any Transport over MPLS (AToM) static pseudowire. <ul style="list-style-type: none"> <li>• <i>peer-ip-address</i>—IP address of the remote provider edge (PE) peer. The remote router ID can be any IP address, as long as it is reachable.</li> <li>• <i>vc-id</i>—The 32-bit identifier of the virtual circuit (VC) between the PE routers.</li> <li>• <b>encapsulation</b>—Specifies the tunneling method to encapsulate the data in the pseudowire.</li> <li>• <b>mpls</b>—Specifies MPLS as the tunneling method.</li> </ul>

## Verifying EVC Default Encapsulation with Bridge-Domain

To verify the configuration of EVC default encapsulation with bridge-domain, use the **show** command shown below.

```
Router# show running-config interface gigabitEthernet 0/9

Building configuration...

Current configuration : 210 bytes
!
interface GigabitEthernet0/9
no ip address
negotiation auto
service instance 1 ethernet
  encapsulation default
  bridge-domain 99
!
end
```

## Verifying EVC Default Encapsulation with Xconnect

To verify the configuration of EVC default encapsulation with xconnect, use the **show** command shown below.

```
Router# show running-config interface gigabitEthernet 0/4

Building configuration...

Current configuration : 181 bytes
!
interface GigabitEthernet0/4
no ip address
negotiation auto
no keepalive
service instance 1 ethernet
  encapsulation default
  xconnect 2.2.2.2 100 encapsulation mpls
!
end
```

## Configuration Examples for EVC Default Encapsulation

- [Example: Configuring EVC Default Encapsulation with Bridge-Domain](#)
- [Example: Configuring EVC Default Encapsulation with Xconnect](#)

### Example: Configuring EVC Default Encapsulation with Bridge-Domain

```
!
interface GigabitEthernet0/9
service instance 1 ethernet
  encapsulation default
  bridge-domain 99
!
```

### Example: Configuring EVC Default Encapsulation with Xconnect

```
!
interface GigabitEthernet0/4
  service instance 10 ethernet
  encapsulation default
  xconnect 1.1.1.1 100 encapsulation mpls
!
```

## Configuring Other Features on EFPs

This section contains the following topics:

- [EFPs and EtherChannels, page 8-17](#)
- [MAC Address Forwarding, Learning and Aging on EFPs, page 8-17](#)
- [Configuring IEEE 802.1Q Tunneling using EFPs, page 8-20](#)

- [Bridge Domain Routing, page 8-24](#)
- [How to Configure DHCP Client on SVI, page 8-25](#)
- [EFPs and MSTP, page 8-27](#)

## EFPs and EtherChannels

You can configure EFP service instances on EtherChannel port channels, but EtherChannels are not supported on ports configured with service instances. Load-balancing on port channels is based on the MAC address or IP address of the traffic flow on the EtherChannel interface.

### Configuration Example

This example configures a service instance on an EtherChannel port channel. Configuration on the ports in the port channel are independent from the service instance configuration.

```
Router (config)# interface port-channel 4
Router (config-if)# service instance 2 ethernet
Router (config-if-srv)# encapsulation dot1q 20
Router (config-if-srv)# bridge-domain 2
```

## MAC Address Forwarding, Learning and Aging on EFPs

- Layer 2 forwarding is based on the bridge domain ID and the destination MAC address. The frame is forwarded to an EFP if the binding between the bridge domain, destination MAC address, and EFP is known. Otherwise, the frame is flooded to all the EFPs or ports in the bridge domain.
- MAC address learning is based on bridge domain ID, source MAC addresses, and logical port number. MAC addresses are managed per bridge domain when the incoming packet is examined and matched against the EFPs configured on the interface. If there is no EFP configured, the bridge domain ID equal to the outer-most VLAN tag is used as forwarding and learning look-up key. For native VLAN frames, the bridge domain equal to the access VLAN configured in the interface is used.

If there is no matching entry in the Layer 2 forwarding table for the ingress frame, the frame is flooded to all the ports within the bridge domain. Flooding within the bridge domain occurs for unknown unicast, and broadcast.

- Dynamic addresses are addresses learned from the source MAC address when the frame enters the router. All unknown source MAC addresses are sent to the CPU along with ingress logical port number and bridge domain ID for learning. Once the MAC address is learned, the subsequent frame with the destination MAC address is forwarded to the learned port. When a MAC address moves to a different port, the Layer 2 forwarding entry is updated with the corresponding port.
- Dynamic addresses are aged out if there is no frame from the host with the MAC address. If the aged-out frame is received by the router, it is flooded to the EFPs in the bridge domain and the Layer 2 forwarding entry is created again. The default for aging dynamic addresses is 5 minutes.

You can configure dynamic address aging time by entering the **mac address-table aging time [0 | 10-1000000]**. The range is in seconds. An aging time of 0 means that the address aging is disabled.

- MAC address movement is detected when the host router moves from one port to another. If a host moves to another port or EFP, the learning lookup for the installed entry fails because the ingress logical port number does not match and a new learning cache entry is created. The detection of MAC address movement is disabled for static MAC addresses where the forwarding behavior is configured by the user.

## Disabling MAC Address Learning on an Interface or Bridge Domain

By default, MAC address learning is enabled on all interfaces and bridge domains or VLANs on the router. You can control MAC address learning on an interface or VLAN to manage the available MAC address table space by controlling which interfaces or VLANs can learn MAC addresses. When you disable MAC address learning for a BD/VLAN or interface, the router that receives packet from any source on the BD, VLAN or interface, the addresses are not learned. Since addresses are not learned, all IP packets floods into the Layer 2 domain.

### Prerequisites

You can disable MAC address learning on a single VLAN ID from 2 to 4092 (for example, **no mac-address-table learning vlan 10**). If the MAC address learning is disabled for a VLAN or interface, the already learnt addresses for that VLAN or interface are immediately removed from the MAC address table. However, you cannot disable MAC learning for the reserved 4093, 4094, and 4095 VLAN IDs. If the VLAN ID that you enter is a reserved VLAN, the switch generates an error message and rejects the command.

- We recommend that you disable MAC address learning only in VLANs with two ports. If you disable MAC address learning on a VLAN with more than two ports, every packet entering the switch is flooded in that VLAN domain.

### Restrictions

- You cannot disable MAC address learning on a VLAN that is used internally by the router. VLAN ID 1 is used internally by the router. If the VLAN ID that you enter is an internal VLAN, the switch generates an error message and rejects the command.

Complete the following steps to disable MAC address learning on a VLAN:

### SUMMARY STEPS

- configure terminal
- no mac-address-table learning {vlan *vlan-id* | interface *interface slot/port*}
- end
- copy running-config startup-config

### DETAILED STEPS

	Command or Action	Purpose
Step 1	<code>configure terminal</code>  <b>Example:</b> Router# configure terminal	Enters global configuration mode.
Step 2	<code>no mac-address-table learning {vlan <i>vlan-id</i>   interface <i>type slot/port</i>}</code>  <b>Example:</b> Router(config)# no mac-address-table learning vlan 10	Disable MAC address learning on an interface or on a specified VLAN.  <b>vlan <i>vlan-id</i></b> —Specifies the VLAN ID which ranges from 2 to 4094. It cannot be an internal VLAN or reserved VLAN.  <b>interface <i>type slot/port</i></b> —Specifies the location of the interface and its type.

	Command or Action	Purpose
Step 3	<b>end</b>	Return to privileged EXEC mode.
Step 4	<b>copy running-config startup-config</b>	(Optional) Save your entries in the configuration file.

To reenabling MAC address learning, use the **mac-address-table learning** global configuration command. The command causes the configuration to appear in the **show running-config** privileged EXEC command display.

## Configuration Examples

This example shows how to disable MAC address learning on VLAN 10:

```
Router(config)# no mac-address-table learning vlan 10
```

This example shows how to disable MAC-address learning for all modules on a specific routed interface:

```
Router(config)# no mac-address-table learning interface GigabitEthernet 0/5
Router(config)#
```

This example shows how to disable MAC address learning for port-channel interface:

```
Router(config)# no mac-address-table learning interface port-channel 1
```

## Verification

The following are the examples of the outputs using the **show** commands.

```
Router# show mac-address-table
      Mac Address Table
-----
Vlan    Mac Address      Type        Ports
----    -
  20    2222.2222.2222   STATIC     Gi0/2
  10    0000.0700.0a00   DYNAMIC     Gi0/9
  10    0000.0700.0b00   DYNAMIC     Gi0/1
Total Mac Addresses for this criterion: 3
```

In the above example, the **show mac-address-table** command displays both the dynamically and statically learned addresses.

Following is an example for **show mac-address-table dynamic** command which displays only dynamically learned addresses.

```
Router# show mac-address-table dynamic
      Mac Address Table
-----
Vlan    Mac Address      Type        Ports
----    -
  10    0000.0700.0a00   DYNAMIC     Gi0/9
  10    0000.0700.0b00   DYNAMIC     Gi0/1
Total Mac Addresses for this criterion: 2
```

Following is an example for **show mac-address-table vlan 10** command which displays only the addresses learned on a particular VLAN/BD.

```
Router# show mac-address-table vlan 10
      Mac Address Table
-----
```

```

Vlan      Mac Address      Type      Ports
----      -
10        0000.0700.0a00   DYNAMIC   Gi0/9
10        0000.0700.0b00   DYNAMIC   Gi0/1
Total Mac Addresses for this criterion: 2

```

Following is an example for **show mac-address-table interface g0/9** command which displays only the addresses learned on a particular VLAN/BD interface.

```

Router# show mac-address-table interface 0/9
Mac Address Table
-----
Vlan      Mac Address      Type      Ports
----      -
10        0000.0700.0a00   DYNAMIC   Gi0/9
Total Mac Addresses for this criterion: 1

```

Following is an example for **show mac-address-table interface port-channel** command which displays only the addresses learned on a particular port-channel interface.

```

Router# show mac-address-table interface port-channel 1
Mac Address Table
-----
Vlan      Mac Address      Type      Ports
----      -
10        0000.0700.0b00   DYNAMIC   Po1
Total Mac Addresses for this criterion: 1

```

## Configuring IEEE 802.1Q Tunneling using EFPs

Tunneling is a feature used by service providers whose networks carry traffic of multiple customers and who are required to maintain the VLAN and Layer 2 protocol configurations of each customer without impacting the traffic of other customers. The Cisco ASR 901 router uses EFPs to support QinQ and Layer 2 protocol tunneling.

This section contains the following topics:

- [802.1Q Tunneling \(QinQ\), page 8-20](#)
- [Routed QinQ, page 8-23](#)

### 802.1Q Tunneling (QinQ)

Service provider customers often have specific requirements for VLAN IDs and the number of VLANs to be supported. The VLAN ranges required by different customers in the same service-provider network might overlap, and traffic of customers through the infrastructure might be mixed. Assigning a unique range of VLAN IDs to each customer would restrict customer configurations and could easily exceed the VLAN limit (4096) of the 802.1Q specification.

Using the EVCs, service providers can encapsulate packets that enter the service-provider network with multiple customer VLAN IDs (C-VLANs) and a single 0x8100 Ethertype VLAN tag with a service provider VLAN (S-VLAN). Within the service provider network, packets are switched based on the S-VLAN. When the packets egress the service provider network onto the customer network, the S-VLAN tag is decapsulated and the original customer packet is restored.



Figure 8-1 shows the tag structures of the double-tagged packets.

**Figure 8-1** Original (Normal), 802.1Q, and Double-Tagged Ethernet Packet Formats

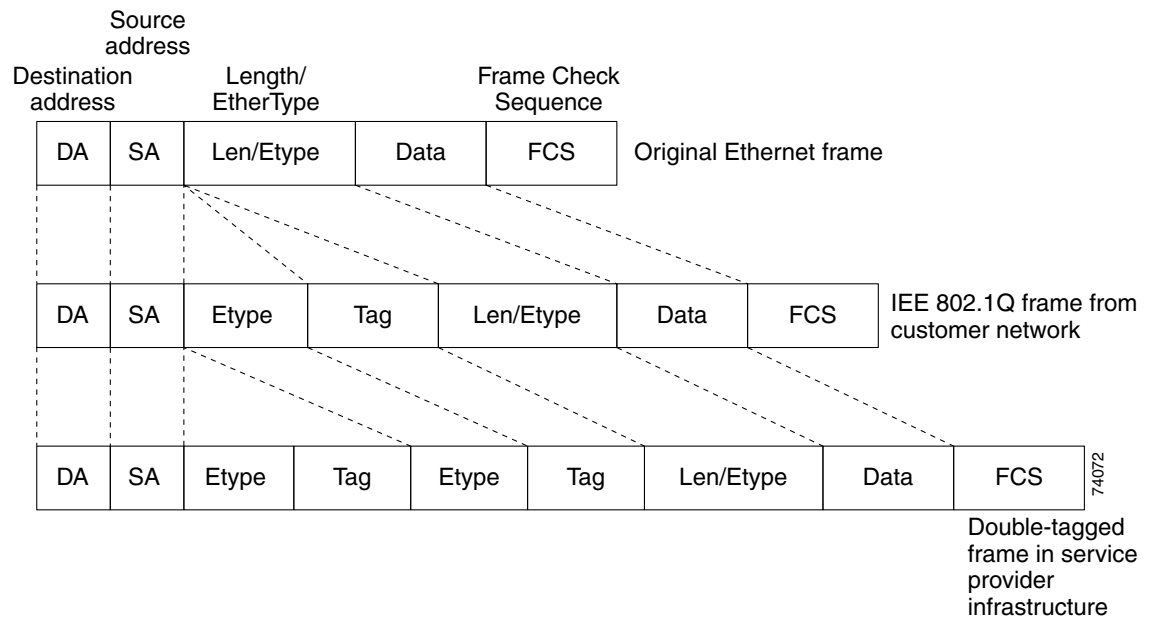

In Figure 8-2, Customer A is assigned VLAN 30, and Customer B is assigned VLAN 40. Packets entering the edge routers with 802.1Q tags are double-tagged when they enter the service-provider network, with the outer tag containing VLAN ID 30 or 40, appropriately, and the inner tag containing the original VLAN number, for example, VLAN 100. Even if both Customers A and B have VLAN 100 in their networks, the traffic remains segregated within the service-provider network because the outer tag is different. Each customer controls its own VLAN numbering space, which is independent of the VLAN numbering space used by other customers and the VLAN numbering space used by the service-provider network. At the outbound port, the original VLAN numbers on the customer's network are recovered.

Figure 8-2 802.1Q Tunnel Ports in a Service-Provider Network

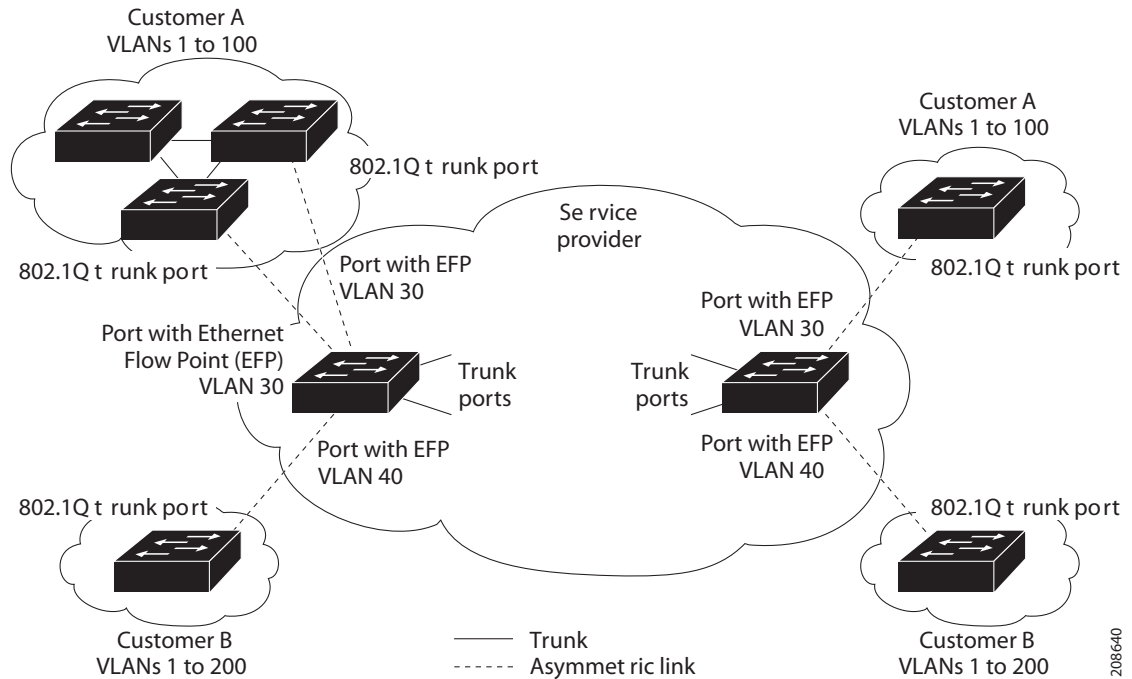

You can use EFPs to configure 802.1Q tunneling in two ways:

## Restrictions

- Inner VLAN range filtering for QinQ traffic from Network-to-Network Interface (NNI) to User-to-Network Interface (UNI) is not enforced if the range is more than 1000.
- Egress VLAN range filtering for traffic coming from NNI to UNI, is not supported on UNI.
- Single-tagged EVC with VLAN range is not supported on the port channel.

## Configuration Examples

In this example, for Customer A, interface Gigabit Ethernet 0/1 is the customer-facing port, and Gigabit Ethernet 0/2 is a trunk port facing the service provider network. For Customer B, Gigabit Ethernet 0/3 is the customer-facing port, and Gigabit Ethernet 0/4 is the trunk port facing the service provider network.

### Customer A

```
Router (config)# interface gigabitethernet0/1
Router (config-if)# service instance 1 Ethernet
Router (config-if-srv)# encapsulation dot1q 1-100
Router (config-if-srv)# bridge-domain 500

Router (config)# interface gigabitethernet0/2
Router (config-if)# service instance 2 Ethernet
Router (config-if-srv)# encapsulation dot1q 30 second-dot1q 1-100
Router (config-if-srv)# rewrite ingress pop 1 symmetric
Router (config-if-srv)# bridge-domain 500
```

For Customer A, service instance 1 on Gigabit Ethernet port 0/1 is configured with the VLAN encapsulations used by the customer: C-VLANs 1–100. These are forwarded on bridge-domain 500. The service provider facing port is configured with a service instance on the same bridge-domain and with an **encapsulation dot1q** command matching the S-VLAN. The **rewrite ingress pop 1 symmetric** command also implies a push of the configured encapsulation on egress packets. Therefore, the original packets with VLAN tags between 1 and 100 are encapsulated with another S-VLAN (VLAN 30) tag when exiting Gigabit Ethernet port 0/2.

Similarly, for double-tagged (S-VLAN = 30, C-VLAN = 1–100) packets coming from the provider network, using the **rewrite ingress pop 1 symmetric** command enables the outer S-VLAN tag and forwards the original C-VLAN tagged frame over bridge-domain 500 out to Gigabit Ethernet port 0/1.

#### Customer B

```
Router (config)# interface gigabitethernet0/3
Router (config-if)# service instance 1 Ethernet
Router (config-if-srv)# encapsulation dot1q 1-200
Router (config-if-srv)# bridge-domain 500

Router (config)# interface gigabitethernet0/4
Router (config-if)# service instance 2 Ethernet
Router (config-if-srv)# encapsulation dot1q 40 second-dot1q 1-200
Router (config-if-srv)# rewrite ingress pop 1 symmetric
Router (config-if-srv)# bridge-domain 500
```

## Routed QinQ

Cisco ASR 901 router supports pop 2 configuration.

### Restrictions

- Pop 2 is not supported for MPLS, L2VPN, and MPLS VPN deployments.
- ACL and QOS configurations for pop2 EVC scenarios are not supported.

### Configuration Example

This section provides the following sample configuration examples for routed QinQ on the Cisco ASR 901 Router:

#### Example: User to Network Interface

```
Gig 0/1 (Connected to BTS)

interface GigabitEthernet0/1
service instance 1 ethernet
encapsulation dot1q 10
rewrite ingress tag pop 1 symmetric
bridge-domain 100

int vlan 100
ip address 1.1.1.1 255.255.255.0
```

#### Example: Network to Network Interface/Core Router

```
interface GigabitEthernet0/2
service instance 2 ethernet
```

```

encapsulation dot1q 20 second-dot1q 30
rewrite ingress tag pop 2 symmetric
bridge-domain 101

int vlan 101
ip address 2.2.2.2 255.255.255.0

```

In the above example:

- The traffic coming from the Base Transceiver Station (BTS) through the GigabitEthernet interface 0/1 has the VLAN tag 10, which is popped and hits the Switch Virtual Interface (SVI) 100. This gets routed to SVI 101 depending on the destination address.
- At the egress on the core interface, two tags (20 and 30) are pushed and sent out of GigabitEthernet interface 0/2, for SVI 101.
- The traffic coming from the core router through GigabitEthernet interface 0/2, is destined to the BTS and has two tags (20,30); both tags get popped and hit SVI 101. This gets routed to SVI 100, which sends the traffic out of GigabitEthernet interface 0/1 with VLAN 10.
- GigabitEthernet interface 0/2 can have multiple service instances and the traffic egresses out of the corresponding service instance depending on the SVI it gets routed to.

## Bridge Domain Routing

The router supports IP routing for bridge domains, including Layer 3 and Layer 2 VPNs, using the SVI model.

### Restrictions

- You must configure SVIs for bridge-domain routing.
- The bridge domain must be in the range of 1 to 4094 to match the supported VLAN range.
- There can be only one EFP in the bridge domain.
- You cannot have any Layer 2 switchports in the VLAN (bridge domain) used for routing.
- You can use bridge domain routing with only native packets.
- MPLS is supported on EFP with SVI.
- Scale limit for EFPs reduces if you use the **second-dot1q** command. Use the **second-dot1q any** command to maintain this limit.

### Example: Configuring Bridge-Domain Routing

This is an example of configuring bridge-domain routing with a single tag EFP:

```

Router (config)# interface gigabitethernet0/2
Router (config-if)# service instance 1 Ethernet
Router (config-if-srv)# encapsulation dot1q 10
Router (config-if-srv)# rewrite ingress tag pop 1 symmetric
Router (config-if-srv)# bridge-domain 100

Router (config)# interface vlan 100
Router (config-if)# ip address 20.1.1.1 255.255.255.255

```

## How to Configure DHCP Client on SVI

This section contains the following topics:

- [Configuring DHCP Client on SVI](#)
- [Verifying DHCP Client on SVI](#)
- [Configuration Example for DHCP Client on SVI](#)

### Configuring DHCP Client on SVI

To configure the DHCP client, the IP address, mask, broadcast address, and default gateway address of the SVI are retrieved from the server.

Complete the following steps to configure the DHCP client on SVI.

#### SUMMARY STEPS

1. **enable**
2. **configure terminal**
3. **interface vlan** *vlan-id*
4. **ip address dhcp**
5. **interface** *type-number*
6. **service instance** *instance-id* **ethernet encapsulation dot1q** *vlan-id*
7. **rewrite ingress tag pop** [*I12*] **symmetric**
8. **bridge-domain** *bridge-id*
9. **end**

#### DETAILED STEPS

	Command or Action	Purpose
Step 1	<b>enable</b>  <b>Example:</b> Router> enable	Enables privileged EXEC mode. <ul style="list-style-type: none"> <li>• Enter your password if prompted.</li> </ul>
Step 2	<b>configure terminal</b>  <b>Example:</b> Router# configure terminal	Enters global configuration mode.
Step 3	<b>interface vlan</b> <i>vlan-id</i>  <b>Example:</b> Router(config)# interface vlan 15	Configures the VLAN interface and enters interface configuration mode.

	Command or Action	Purpose
Step 4	<b>ip address dhcp</b>  <b>Example:</b> Router(config-if)# ip address dhcp	Specifies an IP address through DHCP.
Step 5	<b>interface type-number</b>  <b>Example:</b> Router(config-if)# interface GigabitEthernet0/7	Specifies an interface type number.
Step 6	<b>service instance instance-id ethernet encapsulation dot1q vlan-id</b>  <b>Example:</b> Router(config-if)# service instance 10 ethernet encapsulation dot1q 15	Creates a service instance on an interface and defines the matching criteria to be used in order to map the ingress dot1q frames to the appropriate service instance. <ul style="list-style-type: none"> <li><i>instance-id</i>—Integer that uniquely identifies a service instance on an interface.</li> <li><i>vlan-id</i>—VLAN range is between 1 to 4094. You cannot use the same VLAN ID for more than one domain at the same level.</li> </ul>
Step 7	<b>rewrite ingress tag pop [1/2] symmetric</b>  <b>Example:</b> Router(config-if)# rewrite ingress tag pop 1 symmetric	Specifies the encapsulation adjustment to be performed on the frame ingress to the EFP. The symmetric keyword is required to complete the rewrite configuration.
Step 8	<b>bridge-domain bridge-id</b>  <b>Example:</b> Router(config-if)# bridge-domain 15	Binds the service instance to a bridge domain instance using an identifier.

## Verifying DHCP Client on SVI

To verify the configuration of DHCP client on SVI, use the show command described below.

```
Router# show ip-address interface brief | include vlan15
```

```
Interface IP-Address OK Method Status Protocol
Vlan15 15.0.0.2 YES DHCP up up
```

## Configuration Example for DHCP Client on SVI

```
Router(config)# interface Vlan 15
Router(config-if)# ip address dhcp
Router(config-if)# interface GigabitEthernet0/7
Router(config-if)# negotiation auto
Router(config-if)# service instance 10 ethernet
Router(config-if-srv)# encapsulation dot1q 15
Router(config-if-srv)# rewrite ingress tag pop 1 symmetric
Router(config-if-srv)# bridge-domain 15
```

## EFPs and Switchport MAC Addresses

Because forwarding can occur between EFPs and switchports, MAC address movement can occur on learned addresses. Addresses learned on EFPs will have the format of interface + EFP ID, for example gigabitethernet 0/1 + EFP 1. When an address moves between a non-secured EFP and a switchport, the behavior is similar to that of moving between switchports.

To see MAC address information for VLANs 1 to 4094, use the **show mac address-table vlan** privileged EXEC command. For VLANs 4096 to 8000, use the **show mac address-table bridge-domain** privileged EXEC command. All other **show mac address-table** commands also support bridge domains as well as VLANs.

When an EFP property changes (bridge domain, rewrite, encapsulation, split-horizon, secured or unsecured, or a state change), the old dynamic MAC addresses are removed from their existing tables. This is to prevent old invalid entries from getting retained.

## EFPs and MSTP

EFP bridge domains are supported by the Multiple Spanning Tree Protocol (MSTP). These restrictions apply when running MSTP with bridge domains.

- All incoming VLANs (outer-most or single) mapped to a bridge domain must belong to the same MST instance or loops could occur.
- For all EFPs that are mapped to the same MST instance, you must configure backup EFPs on every redundant path to prevent loss of connectivity due to STP blocking a port.
- When STP mode is PVST+ or PVRST, EFP information is not passed to the protocol. EVC only supports only MSTP.

# Monitoring EVC

**Note**

Statistics are not available in the service instance command. To look at flow statistics, you need to configure a class default policy on the service instance.

**Table 8-2 Supported show Commands**

Command	Description
<b>show ethernet service evc</b> [ <b>id</b> <i>evc-id</i>   <b>interface</b> <i>interface-id</i> ] [ <b>detail</b> ]	Displays information about all EVCs, or a specific EVC when you enter an EVC ID, or all EVCs on an interface when you enter an interface ID. The <b>detail</b> option provides additional information about the EVC.
<b>show ethernet service instance</b> [ <b>id</b> <i>instance-id</i>   <b>interface</b> <i>interface-id</i>   <b>interface</b> <i>interface-id</i> ] {[ <b>detail</b> ]   [ <b>stats</b> ]}	Displays information about one or more service instance (EFPs). If you specify an EFP ID and interface, only data pertaining to that particular EFP is displayed. If you specify only an interface ID, data is displayed for all EFPs on the interface.
<b>show bridge-domain</b> [ <i>n</i> ]	Displays all the members of the specified bridge-domain, if a bridge-domain with the specified number exists.  If you do not enter <i>n</i> , the command displays all the members of all bridge-domains in the system.
<b>show bridge-domain n split-horizon</b> [ <b>group</b> { <i>group-id</i>   <b>all</b> }]	Displays all the members of bridge-domain <i>n</i> that belong to split horizon group 0, when you do not specify a <b>group</b> <i>group-id</i> with this command.  If you specify a numerical <i>group-id</i> , this command displays all the members of the specified group id.  When you enter <b>group all</b> , the command displays all members of any split horizon group.
<b>show ethernet service instance detail</b>	This command displays detailed service instance information, including Layer 2 protocol information. This is an example of the output:  <pre>Router# show ethernet service instance detail Service Instance ID: 1 Associated Interface: Ethernet0/0 Associated EVC: L2protocol tunnel lacp CE-Vlans: State: Up EFP Statistics:   Pkts In   Bytes In   Pkts Out   Bytes Out       0         0         0         0</pre>
<b>show mac address-table</b>	This command displays dynamically learned or statically configured MAC security addresses.
<b>show mac address-table bridge-domain</b> <i>bridge-domain id</i>	This command displays MAC address table information for the specified bridge domain.
<b>show mac address-table count</b> <b>bridge-domain</b> <i>bridge-domain id</i>	This command displays the number of addresses present for the specified bridge domain.
<b>show mac address-table learning</b> <b>bridge-domain</b> <i>bridge-domain id</i>	This command displays the learning status for the specified bridge domain.



**Example**

This is an example of output from the **show ethernet service instance detail** command:

```
Router# show ethernet service instance id 1 interface gigabitEthernet 0/1 detail

Service Instance ID: 1
Associated Interface: GigabitEthernet0/13
Associated EVC: EVC_P2P_10
L2protocol drop
CE-Vlans:
Encapsulation: dot1q 10 vlan protocol type 0x8100
Interface Dot1q Tunnel Ethertype: 0x8100
State: Up
EFP Statistics:
  Pkts In   Bytes In   Pkts Out  Bytes Out
    214     15408     97150    6994800
EFP Microblocks:
*****
Microblock type: Bridge-domain
Bridge-domain: 10
```

This is an example of output from the **show ethernet service instance statistics** command:

```
Router# show ethernet service instance id 1 interface gigabitEthernet 0/13 stats
Service Instance 1, Interface GigabitEthernet0/13
Pkts In   Bytes In   Pkts Out  Bytes Out
    214     15408     97150    6994800
```

This is an example of output from the **show mac-address table count** command:

```
Router# show mac address-table count bridge-domain 10

Mac Entries for BD 10:
-----
Dynamic Address Count : 20
Static Address Count  : 0
Total Mac Addresses  : 20
```

## Sample Configuration with Switchport to EVC Mapping

This example illustrates EVC in a UNI layer, 802.1q tunnelling towards aggregation and QoS classification with marking and policing at ingress port. A two level HQOS policy is applied on the ingress.

In this example, all the switchport configurations of the ME3400/MWR2941 have been converted into EVC based equivalent configuration for GigabitEthernet interface 0/0. This is the ingress port connected to the nodes. So, instead of **switchport access vlan** there is an EVC configured using the **service instance** command under the physical interface.

The GigabitEthernet interface 0/9 has the egress port configuration which has 802.1q tunnelling configured. This port is connected to the aggregation device. This is the fundamental difference in configuration between the Cisco ME34xx devices and the Cisco ASR 901 router. All configurations can be modelled along this sample working configuration.

## Configuration Example

```

class-map match-any CELL-TRFC
  match vlan 2615 3615
!
policy-map INPUT-SUBMAP
  class CELL-TRFC
    police cir 60000000 bc 1875000
    conform-action transmit
    exceed-action drop
policy-map INPUT-TOPMAP
  class class-default
    police cir 90000000 conform-action transmit exceed-action drop
    service-policy INPUT-SUBMAP
policy-map INPUT-MAP
  class class-default
    police cir 60000000 bc 1875000
    conform-action transmit
    exceed-action drop
!
!
interface GigabitEthernet0/0
  no negotiation auto
  service instance 2615 ethernet
  encapsulation dot1q 2615
  service-policy input INPUT-TOPMAP
  bridge-domain 2615
!
  service instance 3615 ethernet
  encapsulation dot1q 3615
  service-policy input INPUT-MAP
  bridge-domain 3615
!
!
interface GigabitEthernet0/1
  no negotiation auto
!
interface GigabitEthernet0/2
  no negotiation auto
!
interface GigabitEthernet0/3
  no negotiation auto
!
interface GigabitEthernet0/4
  no negotiation auto
!
interface GigabitEthernet0/5
  no negotiation auto
!
interface GigabitEthernet0/6
  no negotiation auto
!
interface GigabitEthernet0/7
  no negotiation auto
!
interface GigabitEthernet0/8
  no negotiation auto
!
interface GigabitEthernet0/9
  no negotiation auto
  service instance 2615 ethernet
  encapsulation dot1q 100 second-dot1q 2615

```

```
rewrite ingress tag pop 1 symmetric
bridge-domain 2615
!
service instance 3615 ethernet
encapsulation dot1q 100 second-dot1q 3615
rewrite ingress tag pop 1 symmetric
bridge-domain 3615
!
!
interface GigabitEthernet0/10
no negotiation auto
!
interface GigabitEthernet0/11
no negotiation auto
!
interface ToP0/12
no negotiation auto
!
interface FastEthernet0/0
full-duplex
!
interface Vlan1
!
ip forward-protocol nd
!
!
no ip http server
!
logging esm config
!
!
control-plane
!
!
line con 0
line con 1
transport preferred lat pad telnet rlogin udptn mop ssh
transport output lat pad telnet rlogin udptn mop ssh
line vty 0 4
login
!
exception data-corruption buffer truncate
exception crashinfo buffersize 128
!
end
```

## Additional References

The following sections provide references related to Configuring EVC feature.

### Related Documents

Related Topic	Document Title
Cisco IOS Commands	<i>Cisco IOS Master Commands List, All Releases</i>
ASR 901 Command Reference	<i>Cisco ASR 901 Series Aggregation Services Router Command Reference</i>
Cisco IOS Interface and Hardware Component Commands	<i>Cisco IOS Interface and Hardware Component Command Reference</i>

### Standards

Standard	Title
None	—

### MIBs

MIB	MIBs Link
None	To locate and download MIBs for selected platforms, Cisco IOS releases, and feature sets, use Cisco MIB Locator found at the following URL: <a href="http://www.cisco.com/go/mibs">http://www.cisco.com/go/mibs</a>

### RFCs

RFC	Title
None	—

### Technical Assistance

Description	Link
The Cisco Technical Support website contains thousands of pages of searchable technical content, including links to products, technologies, solutions, technical tips, and tools. Registered Cisco.com users can log in from this page to access even more content.	<a href="http://www.cisco.com/techsupport">http://www.cisco.com/techsupport</a>

# Feature Information for Configuring Ethernet Virtual Connections

Table 8-3 lists the features in this module and provides links to specific configuration information.

Use Cisco Feature Navigator to find information about platform support and software image support. Cisco Feature Navigator enables you to determine which software images support a specific software release, feature set, or platform. To access Cisco Feature Navigator, go to <http://www.cisco.com/go/cfn>. An account on Cisco.com is not required.



**Note**

Table 8-3 lists only the software release that introduced support for a given feature in a given software release train. Unless noted otherwise, subsequent releases of that software release train also support that feature.

**Table 8-3** Feature Information for Configuring Ethernet Virtual Connections

Feature Name	Releases	Feature Information
Configuring Ethernet Virtual Connections	15.2(2)SNH1	See the following links for more information about this feature: <ul style="list-style-type: none"> <li>• <a href="#">Supported EVC Features</a></li> <li>• <a href="#">Understanding EVC Features</a></li> <li>• <a href="#">Configuring EFPs</a></li> <li>• <a href="#">Configuring Other Features on EFPs</a></li> <li>• <a href="#">Monitoring EVC</a></li> <li>• <a href="#">Sample Configuration with Switchport to EVC Mapping</a></li> </ul>
EVC Default Encapsulation	15.3(2)S	See the following links for more information about this feature: <ul style="list-style-type: none"> <li>• <a href="#">Default EVC Configuration</a></li> <li>• <a href="#">How to Configure EVC Default Encapsulation</a></li> <li>• <a href="#">Configuring EVC Default Encapsulation with Xconnect</a></li> </ul>





# Configuring EtherChannels

---

This chapter describes how to configure EtherChannels on the Cisco ASR 901 router Layer 2 or Layer 3 LAN ports.

## Contents

- [Understanding How EtherChannels Work, page 9-1](#)
- [EtherChannel Configuration Guidelines and Restrictions, page 9-4](#)
- [Configuring Etherchannels, page 9-5](#)
- [EVC On Port-Channel, page 9-10](#)

## Understanding How EtherChannels Work

This section contains the following topics:

- [EtherChannel Feature Overview, page 9-1](#)
- [Understanding How EtherChannels Are Configured, page 9-2](#)
- [Understanding Port-Channel Interfaces, page 9-4](#)
- [Understanding Load Balancing, page 9-4](#)

## EtherChannel Feature Overview

An EtherChannel bundles individual Ethernet links into a single logical link that provides the aggregate bandwidth of up to eight physical links.

The Cisco ASR 901 router supports a maximum of eight EtherChannels with a maximum eight member links in each EtherChannel.

You can form an EtherChannel with up to eight compatibly configured LAN ports in a Cisco ASR 901. All LAN ports in each EtherChannel must be of the same speed and must all be configured as Layer 2 LAN ports.



### Note

---

The network device to which a Cisco ASR 901 is connected may impose its own limits on the number of ports in an EtherChannel.

---

If a segment within an EtherChannel fails, traffic previously carried over the failed link switches to the remaining segments within the EtherChannel. When a failure occurs, the EtherChannel feature sends a trap that identifies the router, the EtherChannel, and the failed link. Inbound broadcast packets on one segment in an EtherChannel are blocked from returning on any other segment of the EtherChannel.

## Understanding How EtherChannels Are Configured

This section contains the following topics:

- [EtherChannel Configuration Overview, page 9-2](#)
- [Understanding Manual EtherChannel Configuration, page 9-2](#)
- [Understanding IEEE 802.3ad LACP EtherChannel Configuration, page 9-2](#)

### EtherChannel Configuration Overview

You can configure EtherChannels manually or use the Link Aggregation Control Protocol (LACP) to form EtherChannels. The EtherChannel protocols allow ports with similar characteristics to form an EtherChannel through dynamic negotiation with connected network devices. LACP is defined in IEEE 802.3ad.

Table 9-1 lists the user-configurable EtherChannel modes.

**Table 9-1 EtherChannel Modes**

Mode	Description
<b>on</b>	This is the mode that forces the LAN port to channel unconditionally. In the <b>on</b> mode, a usable EtherChannel exists only when a LAN port group in the <b>on</b> mode is connected to another LAN port group in the <b>on</b> mode. Because ports configured in the <b>on</b> mode do not negotiate, there is no negotiation traffic between the ports. You cannot configure the <b>on</b> mode with an EtherChannel protocol.
<b>passive</b>	(Default for LACP) LACP mode that places a port into a passive negotiating state, in which the port responds to LACP packets it receives but does not initiate LACP negotiation.
<b>active</b>	LACP mode that places a port into an active negotiating state, in which the port initiates negotiations with other ports by sending LACP packets.

### Understanding Manual EtherChannel Configuration

Manually configured EtherChannel ports do not exchange EtherChannel protocol packets. A manually configured EtherChannel forms only when you enter configure all ports in the EtherChannel compatibly.

### Understanding IEEE 802.3ad LACP EtherChannel Configuration

LACP supports the automatic creation of EtherChannels by exchanging LACP packets between LAN ports. LACP packets are exchanged only between ports in **passive** and **active** modes.

The protocol learns the capabilities of LAN port groups dynamically and informs the other LAN ports. Once LACP identifies correctly matched Ethernet links, it facilitates grouping the links into an EtherChannel. The EtherChannel is then added to the spanning tree as a single bridge port.



Both the **passive** and **active** modes allow LACP to negotiate between LAN ports to determine if they can form an EtherChannel, based on criteria such as port speed and trunking state. Layer 2 EtherChannels also use VLAN numbers.

LAN ports can form an EtherChannel when they are in different LACP modes as long as the modes are compatible. For example:

- A LAN port in **active** mode can form an EtherChannel successfully with another LAN port that is in **active** mode.
- A LAN port in **active** mode can form an EtherChannel with another LAN port in **passive** mode.
- A LAN port in **passive** mode cannot form an EtherChannel with another LAN port that is also in **passive** mode, because neither port will initiate negotiation.

Table 9-2 provides a summary of these combinations.

**Table 9-2 LACP EtherChannel Modes**

Router A	Router B	Result
passive mode	passive mode	No EtherChannel group is created.
passive mode	active mode	EtherChannel group is created.
active mode	passive mode	EtherChannel group is created.
active mode	active mode	EtherChannel group is created.

LACP uses the following parameters:

- LACP system priority—You must configure an LACP system priority on each router running LACP. The system priority can be configured automatically or through the command line interface (CLI) (see the “[Configuring the LACP System Priority and System ID](#)” section on page 9-6). LACP uses the system priority with the router MAC address to form the system ID and also during negotiation with other systems.



**Note** The LACP system ID is the combination of the LACP system priority value and the MAC address of the router.

- LACP port priority—You must configure an LACP port priority on each port configured to use LACP. The port priority can be configured automatically or through the CLI (see the “[Configuring Channel Groups](#)” section on page 9-5). LACP uses the port priority with the port number to form the port identifier. LACP uses the port priority to decide which ports should be put in standby mode when there is a hardware limitation that prevents all compatible ports from aggregating.



**Note** Port priority is only effective when it is configured on a device with an LACP system priority higher than the peer.

- LACP administrative key—LACP automatically configures an administrative key value equal to the channel group identification number on each port configured to use LACP. The administrative key defines the ability of a port to aggregate with other ports. A port’s ability to aggregate with other ports is determined by these factors:
  - Port physical characteristics, such as data rate, duplex capability, and point-to-point or shared medium
  - Configuration restrictions that you establish

On ports configured to use LACP, LACP tries to configure the maximum number of compatible ports in an EtherChannel, up to the maximum allowed by the hardware (eight ports). If LACP cannot aggregate all the ports that are compatible (for example, the remote system might have more restrictive hardware limitations), then all the ports that cannot be actively included in the channel are put in hot standby state and are used only if one of the channeled ports fails. You can configure an additional 8 standby ports (total of 16 ports associated with the EtherChannel).

## Understanding Port-Channel Interfaces

Each EtherChannel has a numbered port-channel interface. The configuration that you apply to the port-channel interface affects all LAN ports assigned to the port-channel interface.

After you configure an EtherChannel, the configuration that you apply to the port-channel interface affects the EtherChannel; the configuration that you apply to the LAN ports affects only the LAN port to which you apply the configuration. To change the parameters of all ports in an EtherChannel, apply the configuration commands to the port-channel interface, for example, Spanning Tree Protocol (STP) commands or commands to configure a Layer 2 EtherChannel as a trunk.

## Understanding Load Balancing

An EtherChannel balances the traffic load across the links in an EtherChannel by reducing part of the binary pattern formed from the addresses in the frame to a numerical value that selects one of the links in the channel.

EtherChannel load balancing can use MAC addresses or IP addresses. EtherChannel load balancing can use either source or destination or both source and destination addresses or ports. The selected mode applies to all EtherChannels configured on the router. EtherChannel load balancing can use MPLS Layer 2 information.

Use the option that provides the balance criteria with the greatest variety in your configuration. For example, if the traffic on an EtherChannel is going only to a single MAC address and you use the destination MAC address as the basis of EtherChannel load balancing, the EtherChannel always chooses the same link in the EtherChannel; using source addresses or IP addresses might result in better load balancing.

## EtherChannel Configuration Guidelines and Restrictions



### Note

When EtherChannel interfaces are configured improperly, they are disabled automatically to avoid network loops and other problems.

- The commands in this chapter can be used on all LAN ports in the Cisco ASR 901.
- Configure all LAN ports in an EtherChannel to use the same EtherChannel protocol; you cannot run two EtherChannel protocols in one EtherChannel.
- Configure all LAN ports in an EtherChannel to operate at the same speed and in the same duplex mode.
- LACP does not support half-duplex. Half-duplex ports in an LACP EtherChannel are put in the suspended state.

- Enable all LAN ports in an EtherChannel. If you shut down a LAN port in an EtherChannel, it is treated as a link failure and its traffic is moved to one of the remaining ports in the EtherChannel.
- An EtherChannel will not form if one of the LAN ports is a Switched Port Analyzer (SPAN) destination port.
- For Layer 2 EtherChannels:
  - Assign all LAN ports in the EtherChannel to the same VLAN or configure them as trunks.
  - If you configure an EtherChannel from trunking LAN ports, verify that the trunking mode is the same on all the trunks. LAN ports in an EtherChannel with different trunk modes can operate unpredictably.
  - An EtherChannel supports the same allowed range of VLANs on all the LAN ports in a trunking Layer 2 EtherChannel. If the allowed range of VLANs is not the same, the LAN ports do not form an EtherChannel.
  - LAN ports with different STP port path costs can form an EtherChannel as long they are compatibly configured with each other. If you set different STP port path costs, the LAN ports are still compatible for the formation of an EtherChannel.
  - An EtherChannel will not form if protocol filtering is set differently on the LAN ports.
- You can configure a maximum of eight port-channel interfaces, numbered from 1 to 8.
- After you configure an EtherChannel, the configuration that you apply to the port-channel interface affects the EtherChannel. The configuration that you apply to the LAN ports affects only those LAN ports to which you apply the configuration.

## Configuring Etherchannels

This section contains the following topics:

- [Configuring Channel Groups, page 9-5](#)
- [Configuring the LACP System Priority and System ID, page 9-6](#)
- [Configuring the LACP Transmit Rate, page 9-7](#)
- [Configuring EtherChannel Load Balancing, page 9-8](#)
- [Modifying MTU Size on Port-Channel, page 9-9](#)
- [EVC On Port-Channel, page 9-10](#)



### Note

Ensure that the LAN ports are configured correctly (see the “[EtherChannel Configuration Guidelines and Restrictions](#)” section on page 9-4).

## Configuring Channel Groups



### Note

- When configuring Layer 2 EtherChannels, configure the LAN ports with the **channel-group** command as described in this section, which automatically creates the port-channel logical interface. You cannot add Layer 2 LAN ports into a manually created port-channel interface.

- To create port-channel interfaces for Layer 2 EtherChannels, the Layer 2 LAN ports must be connected and functioning.

To configure channel groups, complete the following steps for each LAN port in interface configuration mode:

	Command	Purpose
Step 1	Router(config)# <b>interface</b> <i>type slot/port</i>	Selects a LAN port to configure.
Step 2	Router(config-if)# <b>no ip address</b>	Ensures that there is no IP address assigned to the LAN port.
Step 3	Router(config-if)# <b>channel-protocol</b> <b>lacp</b>	(Optional) On the selected LAN port, restricts the <b>channel-group</b> command to the EtherChannel protocol configured with the <b>channel-protocol</b> command.
Step 4	Router(config-if)# <b>channel-group</b> <i>number mode</i> { <b>active</b>   <b>on</b>   <b>passive</b> }	Configures the LAN port in a port-channel and specifies the mode (see <a href="#">Table 9-1 on page 9-2</a> ). LACP supports the active and passive modes.
Step 5	Router(config-if)# <b>lacp port-priority</b> <i>priority_value</i>	(Optional for LACP) Valid values are 1 through 65535. Higher numbers have lower priority. The default is 32768.
Step 6	Router(config-if)# <b>end</b>	Exits configuration mode.
Step 7	Router# <b>show running-config interface</b> <i>type slot/port</i> Router# <b>show interfaces</b> <i>type slot/port etherchannel</i>	Verifies the configuration. <i>type</i> — <b>gigabitethernet</b> .

## Configuring the LACP System Priority and System ID

The LACP system ID is the combination of the LACP system priority value and the MAC address of the router. To configure the LACP system priority and system ID, complete the following tasks:

	Command	Purpose
Step 1	Router(config)# <b>lacp system-priority</b> <i>priority_value</i>	(Optional for LACP) Valid values are 1 through 65535. Higher numbers have lower priority. The default is 32768.
Step 2	Router(config)# <b>end</b>	Exits configuration mode.
Step 3	Router# <b>show lacp sys-id</b>	Verifies the configuration.

### Configuration examples for LACP system priority

This example shows how to configure the LACP system priority:

```
Router# configure terminal
Router(config)# lacp system-priority 23456
Router(config)# end
```

This example shows how to verify the configuration:

```
Router# show lacp sys-id
23456,0050.3e8d.6400
```

The system priority is displayed first, followed by the MAC address of the router.

## Configuring the LACP Transmit Rate

To configure the rate at which Link Aggregation Control Protocol (LACP) control packets are transmitted to an LACP-supported interface, complete the following tasks:

### SUMMARY STEPS

1. **enable**
2. **configure terminal**
3. **interface** *type number*
4. **lacp rate** {**fast** | **normal**}
5. **end**

### DETAILED STEPS

	Command	Purpose
Step 1	<b>enable</b>  <b>Example:</b> Router> enable	Enables privileged EXEC mode. <ul style="list-style-type: none"> <li>• Enter your password if prompted.</li> </ul>
Step 2	<b>configure terminal</b>  <b>Example:</b> Router# configure terminal	Enters global configuration mode.
Step 3	<b>interface</b> <i>type number</i>  <b>Example:</b> Router(config)# interface gigabitethernet 0/1	Specifies an interface type and number, and enters interface configuration mode.
Step 4	<b>lacp rate</b> { <b>fast</b>   <b>normal</b> }  <b>Example:</b> Router(config-if)# lacp rate fast	Configures the transmission rate of LACP control packets to an LACP-supported interface. <ul style="list-style-type: none"> <li>• <b>fast</b>—Specifies that LACP control packets are transmitted at the fast rate, once every second.</li> <li>• <b>normal</b>—Specifies that LACP control packets are transmitted at the normal rate, every 30 seconds after the link is bundled.</li> </ul>
Step 5	<b>end</b>  <b>Example:</b> Router(config-if)# end	Exits the interface configuration mode and enters the privileged EXEC mode.

## Verifying the LACP Transmit Rate

To verify the LACP control packet transmission rate, use the following **show** command:

```
Router# show lacp internal

Flags: S - Device is requesting Slow LACPDUs
       F - Device is requesting Fast LACPDUs
       A - Device is in Active mode           P - Device is in Passive mode

Channel group 5

Port      Flags  State  LACP port  Admin  Oper  Port  Port
Gi0/1    FA    bndl   32768      0xA    0xA   0x102 0x7D
```

## Configuring EtherChannel Load Balancing

To configure EtherChannel load balancing, complete the following steps:

	Command	Purpose
Step 1	Router(config)# <b>port-channel load-balance</b> { <b>src-mac</b>   <b>dst-mac</b>   <b>src-dst-mac</b>   <b>src-ip</b>   <b>dst-ip</b>   <b>src-dst-ip</b>   <b>src-port</b>   <b>dst-port</b>   <b>src-dst-port</b> }	Configures EtherChannel load balancing. The load-balancing keywords indicate the following information: <ul style="list-style-type: none"> <li>• <b>dst-ip</b>—Destination IP addresses</li> <li>• <b>dst-mac</b>—Destination MAC addresses</li> <li>• <b>dst-port</b>—Destination Layer 4 port</li> <li>• <b>src-dst-ip</b>—Source and destination IP addresses</li> <li>• <b>src-dst-mac</b>—Source and destination MAC addresses</li> <li>• <b>src-dst-port</b>—Source and destination Layer 4 port</li> <li>• <b>src-ip</b>—Source IP addresses</li> <li>• <b>src-mac</b>—Source MAC addresses</li> <li>• <b>src-port</b>—Source Layer 4 port</li> </ul>
Step 2	Router(config)# <b>end</b>	Exits configuration mode.
Step 3	Router# <b>show etherchannel load-balance</b>	Verifies the configuration.

### Configuration Examples

This example shows how to configure EtherChannel to use source and destination IP addresses:

```
Router# configure terminal
Router(config)# port-channel load-balance src-dst-ip
Router(config)# end
Router(config)#
```

This example shows how to verify the configuration:

```
Router# show etherchannel load-balance
Source XOR Destination IP address
Router#
```

## Modifying MTU Size on Port-Channel

Complete the following steps to modify MTU size on the port-channel interface:

### Restrictions

If the MTU size of a port-channel member link is different from the MTU size of the port-channel interface, the member link is not bundled.

### SUMMARY STEPS

1. **enable**
2. **configure terminal**
3. **interface port-channel** *number*
4. **mtu** *bytes*

### DETAILED STEPS

	Command	Purpose
Step 1	<b>enable</b>  <b>Example:</b> Router> enable	Enables privileged EXEC mode. <ul style="list-style-type: none"> <li>• Enter your password if prompted.</li> </ul>
Step 2	<b>configure terminal</b>  <b>Example:</b> Router# configure terminal	Enters global configuration mode.
Step 3	<b>interface port-channel</b> <i>number</i>  <b>Example:</b> Router(config)# interface port-channel 1	Selects a port-channel interface and enters interface configuration mode. <ul style="list-style-type: none"> <li>• <i>number</i>—Specifies the port-channel interface number. The range is from 1 to 8.</li> </ul>
Step 4	<b>mtu</b> <i>bytes</i>  <b>Example:</b> Router(config-if)# mtu 4000	Configures the MTU size for port-channel interface. <ul style="list-style-type: none"> <li>• <i>bytes</i>—The range is from 1500 to 9216. The default is 9216.</li> </ul> <p><b>Note</b> To set the MTU size to its default value, use the <b>no mtu</b> or <b>default mtu</b> command.</p>

### Verifying the MTU Size on Port-Channel

To verify the MTU size on port-channel interface, use the **show interface port-channel** command.

```
Router# show interface port-channel 1
Port-channel1 is up, line protocol is up (connected)
Hardware is EtherChannel, address is 4055.3989.4a15 (bia 4055.3989.4a15)
MTU 4000 bytes, BW 2000000 Kbit/sec, DLY 1000 usec,
reliability 255/255, txload 1/255, rxload 0/255
Encapsulation ARPA, loopback not set
```

```

Keepalive set (10 sec)
ARP type: ARPA, ARP Timeout 04:00:00
Last input never, output never, output hang never
Last clearing of "show interface" counters never
Input queue: 0/75/0/0 (size/max/drops/flushes); Total output drops: 0
Queueing strategy: fifo
Output queue: 0/40 (size/max)
5 minute input rate 0 bits/sec, 0 packets/sec
5 minute output rate 0 bits/sec, 0 packets/sec
  0 packets input, 0 bytes, 0 no buffer
    Received 0 broadcasts (0 IP multicasts)
  0 runts, 0 giants, 0 throttles
  0 input errors, 0 CRC, 0 frame, 0 overrun, 0 ignored
  0 watchdog, 0 multicast, 0 pause input
  0 packets output, 0 bytes, 0 underruns
  0 output errors, 0 collisions, 1 interface resets
  0 unknown protocol drops

```

## EVC On Port-Channel

An EtherChannel bundles individual Ethernet links into a single logical link that provides the aggregate bandwidth of up to eight physical links. The EVC EtherChannel feature provides support for EtherChannels on Ethernet Virtual Connection Services (EVCS) service instances.

The EVC EtherChannel feature supports MPBE, local connect, and xconnect service types.

Load balancing is accomplished on a Ethernet flow point (EFP) basis where a number of EFPs exclusively pass traffic through member links. In a default load balancing, you have no control over how the EFPs are grouped together, and sometimes the EFP grouping may not be ideal. To avoid this, use manual load balancing to control the EFP grouping.

## Restrictions for EVC EtherChannel

The following restrictions apply to EVC EtherChannel:

- Bridge-domains, EVCs, and IP subinterfaces are allowed over the port-channel interface and the main interface.
- If you configure a physical port as part of a channel group, you cannot configure EVCs under that physical port.
- If port-channel is configured on an MPLS core, the encapsulation ID should be the same as the bridge domain.
- A physical port that is part of an EVC port-channel cannot have EVC configuration.
- Statically configuring port-channel membership with LACP is not supported.
- You can apply QoS policies under EVCs on a port-channel.
- You cannot use the **police percent** commands on EVC port-channels in flat policy-maps or in parent of HQoS policy-maps.



## Configuring EVC on Port-Channel

To configure the EVC on port-channel, complete these steps in the interface configuration mode:

	Command	Purpose
<b>Step 1</b>	<code>interface port-channel <i>number</i></code>  <b>Example:</b> Router(config)# interface port-channel 11	Creates the port-channel interface.
<b>Step 2</b>	<code>[no] service instance <i>id</i> Ethernet [<i>service-name</i>]</code>  <b>Example:</b> Router(config-if)# service instance 101 ethernet	Creates a service instance (an instantiation of an EVC) on an interface and sets the device into the config-if-srv submenu.
<b>Step 3</b>	<code>encapsulation {untagged dot1q <i>vlan-id</i> [second-dot1q <i>vlan-id</i>]}</code>  <b>Example:</b> Router(config-if-srv)# encapsulation dot1q 13	Defines the matching criteria to be used in order to map ingress dot1q frames on an interface to the appropriate service instance.
<b>Step 4</b>	<code>rewrite ingress tag pop 1 symmetric</code>  <b>Example:</b> Router(config-if-srv)# rewrite ingress tag pop 1 symmetric	Specifies the tag manipulation that is to be performed on the frame ingress to the service instance.
<b>Step 5</b>	<code>[no] bridge-domain <i>bridge-id</i></code>  <b>Example:</b> Router(config-if-srv)# bridge-domain 12	The bridge-domain command binds the service instance to a bridge domain instance where <i>bridge-id</i> is the identifier for the bridge domain instance.

## Verifying the Configuration

Use the following commands to verify the configuration:

Command	Purpose
Router# <code>show ethernet service evc [<i>id evc-id</i>   interface <i>interface-id</i>] [detail]</code>	Displays information pertaining to a specific EVC if an EVC ID is specified, or pertaining to all EVCs on an interface if an interface is specified. The <b>detailed</b> option provides additional information on the EVC.
Router# <code>show ethernet service instance interface <i>port-channel number</i> [summary]</code>	Displays the summary of all the configured EVCs within the interface.

Command	Purpose
Router# <b>show ethernet service instance</b> [ <i>id instance-id</i> <b>interface</b> <i>interface-id</i>   <b>interface</b> <i>interface-id</i> ] [ <b>detail</b> ]	Displays information about one or more service instances. If a service instance ID and interface are specified, only data pertaining to that particular service instance is displayed. If only an interface ID is specified, displays data for all service instances s on the given interface.
Router# <b>show mpls l2 transport vc detail</b>	Displays detailed information related to the virtual connection (VC).
Router# <b>show mpls forwarding</b>	Displays the contents of the Multiprotocol Label Switching (MPLS) Label Forwarding Information Base (LFIB). <b>Note</b> Output should have the label entry l2ckt.
Router# <b>show etherchannel summary</b>	Displays view all EtherChannel groups states and ports.
Router# <b>show policy-map interface service instance</b>	Displays the policy-map information for a given service instance.

## Troubleshooting

**Table 9-3 Troubleshooting Scenarios for EVC on a Port-Channel**

Problem	Solution
Port data block issues in port-channel	Use the <b>show ethernet service interface</b> [ <i>interface-id</i> ] [ <b>detail</b> ] command to view information on the port data. Share the output with TAC for further investigation.
Issues with platform events or errors	Use the <b>debug platform npc custom-ether client</b> [ <i>event, error</i> ] command to debug and trace platform issues. Share the output with TAC for further investigation.



## Configuring Ethernet OAM

Ethernet Operations, Administration, and Maintenance (OAM) is a protocol for installing, monitoring, and troubleshooting ethernet networks, to increase management capability within the context of the overall Ethernet infrastructure.

The Cisco ASR 901 router supports:

- IEEE 802.3ah Ethernet OAM discovery, link monitoring, remote fault detection, and remote loopback.
- IEEE 802.1ag Connectivity Fault Management (CFM)
- Ethernet Local Management Interface (E-LMI)
- IP Service Level Agreements (SLAs) for CFM
- ITU-T Y.1731 fault management

This chapter provides information about configuring the Ethernet OAM, CFM and E-LMI and also enabling Ethernet Loopback.

For complete command and configuration information for Ethernet OAM see the *Cisco IOS Carrier Ethernet Configuration Guide* at this URL:

<http://www.cisco.com/en/US/docs/ios-xml/ios/cether/configuration/12-2sr/ce-12-2sr-book.html>



**Note**

The Cisco ASR 901 router does not necessarily support all of the commands listed in the Cisco IOS Carrier Ethernet documentation.



**Note**

Cisco ASR 901 does not support CFM pre-draft version.

## Contents

- [Understanding Ethernet CFM, page 10-2](#)
- [Configuring Ethernet CFM, page 10-2](#)
- [Configuring CFM over EFP with Cross Connect, page 10-19](#)
- [Configuring Y.1731 Fault Management, page 10-26](#)
- [Managing and Displaying Ethernet CFM Information, page 10-30](#)
- [Understanding the Ethernet OAM Protocol, page 10-32](#)
- [Setting Up and Configuring Ethernet OAM, page 10-35](#)

- [Displaying Ethernet OAM Protocol Information, page 10-45](#)
- [Understanding E-LMI, page 10-48](#)
- [Configuring E-LMI, page 10-49](#)
- [Displaying E-LMI Information, page 10-51](#)
- [Configuring Ethernet Loopback, page 10-51](#)
- [Configuring Y.1564 to Generate Ethernet Traffic, page 10-56](#)

## Understanding Ethernet CFM

Ethernet CFM is an end-to-end per-service-instance (per VLAN) Ethernet layer OAM protocol that includes proactive connectivity monitoring, fault verification, and fault isolation. End-to-end can be provider-edge-to-provider-edge (PE-to-PE) device. Ethernet CFM, as specified by IEEE 802.1ag, is the standard for Layer 2 ping, Layer 2 traceroute, and end-to-end connectivity check of the Ethernet network.

For more information about ethernet CFM, see [Ethernet Connectivity Fault Management](#).

## IP SLA Support for CFM

The router supports CFM with IP Service Level Agreements (SLA), which provides the ability to gather Ethernet layer network performance metrics. Available statistical measurements for the IP SLA CFM operation include round-trip time, jitter (interpacket delay variance), and packet loss. You can schedule multiple IP SLA operations and use Simple Network Management Protocol (SNMP) trap notifications and syslog messages for proactive threshold violation monitoring.

IP SLA integration with CFM gathers Ethernet layer statistical measurements by sending and receiving Ethernet data frames between CFM MEPs. Performance is measured between the source MEP and the destination MEP. Unlike other IP SLA operations that provide performance metrics for only the IP layer, IP SLA with CFM provides performance metrics for Layer 2.

You can manually configure individual Ethernet ping or jitter operations. You can also configure an IP SLA automatic Ethernet operation that queries the CFM database for all MEPs in a given maintenance domain and VLAN. The operation then automatically creates individual Ethernet ping or jitter operations based on the discovered MEPs.

Because IP SLA is a Cisco proprietary feature, interoperability between CFM draft 1 and CFM 802.1ag is handled automatically by the router.

For more information about IP SLA operation with CFM, see the *IP SLAs for Metro-Ethernet* feature module at this URL:

[http://www.cisco.com/en/US/docs/ios/12\\_2sr/12\\_2srb/feature/guide/sr\\_meth.html](http://www.cisco.com/en/US/docs/ios/12_2sr/12_2srb/feature/guide/sr_meth.html)

## Configuring Ethernet CFM

Configuring Ethernet CFM requires configuring the CFM domain. You can optionally configure and enable other CFM features such as crosschecking, remote MEP, port MEPs, SNMP traps, and fault alarms. Note that some of the configuration commands and procedures differ from those used in CFM draft 1.

This section contains the following topics:

- [Default Ethernet CFM Configuration, page 10-3](#)

- [Ethernet CFM Configuration Restrictions and Guidelines, page 10-3](#)
- [Configuring the CFM Domain, page 10-3](#)
- [Configuring Multi-UNI CFM MEPs in the Same VPN, page 10-7](#)
- [Configuring Ethernet CFM Crosscheck, page 10-12](#)
- [Configuring Static Remote MEP, page 10-13](#)
- [Configuring a Port MEP, page 10-14](#)
- [Configuring SNMP Traps, page 10-15](#)
- [Configuring IP SLA CFM Operation, page 10-16](#)

## Default Ethernet CFM Configuration

- CFM is globally disabled.
- CFM is enabled on all interfaces when CFM is globally enabled.
- A port can be configured as a flow point (MIP/MEP), a transparent port, or disabled (CFM disabled). By default, ports are transparent ports until configured as MEP, MIP, or disabled.
- There are no MEPs or MIPs configured.
- When configuring a MEP, if you do not configure direction, the default is up (inward facing).
- For Multi-UNI CFM MEPs (with up direction), port-based model for MAC address assignment is used instead of bridge brain model.

## Ethernet CFM Configuration Restrictions and Guidelines

- You cannot configure CFM on VLAN interfaces.
- CFM is configurable only under EVC and physical or port channel interfaces.
- CFM is supported on ports running MSTP.
- You must configure a port MEP at a lower level than any service (VLAN) MEPs on an interface.

## Configuring the CFM Domain

Complete the following steps to configure the Ethernet CFM domain, configure a service to connect the domain to a VLAN, or configure a port to act as a MEP. You can also enter the optional commands to configure other parameters, such as continuity checks.



### Note

You do not need to enter the **ethernet cfm ieee** global configuration command to configure the CFM version as IEEE 802.1ag; the CFM version is always 802.1ag and the command is automatically generated when you enable CFM.

	Command	Purpose
Step 1	<b>configure terminal</b>	Enter global configuration mode.
Step 2	<b>ethernet cfm global</b>	Globally enable Ethernet CFM on the router.

	Command	Purpose
Step 3	<b>ethernet cfm traceroute cache</b> [ <i>size entries</i>   <i>hold-time minutes</i> ]	(Optional) Configure the CFM traceroute cache. You can set a maximum cache size or hold time. <ul style="list-style-type: none"> <li>(Optional) For <b>size</b>, enter the cache size in number of entry lines. The range is from 1 to 4095; the default is 100 lines.</li> <li>(Optional) For <b>hold-time</b>, enter the maximum cache hold time in minutes. The range is from 1 to 65535; the default is 100 minutes.</li> </ul>
Step 4	<b>ethernet cfm mip auto-create level</b> <i>level-id</i> <b>vlan</b> <i>vlan-id</i>	(Optional) Configure the router to automatically create MIPs for VLAN IDS that are not associated with specific maintenance associations at the specified level. The level range is 0 to 7. <p><b>Note</b> Configure MIP auto-creation only for VLANs that MIPs should monitor. Configuring for all VLANs can be CPU and memory-intensive.</p>
Step 5	<b>ethernet cfm mip filter</b>	(Optional) Enable MIP filtering, which means that all CFM frames at a lower level are dropped. The default is disabled.
Step 6	<b>ethernet cfm domain</b> <i>domain-name</i> <b>level</b> <i>level-id</i>	Define a CFM domain, set the domain level, and enter ethernet-cfm configuration mode for the domain. The maintenance level number range is 0 to 7.
Step 7	<b>id</b> { <i>mac-address domain_number</i>   <b>dns name</b>   <b>null</b> }	(Optional) Assign a maintenance domain identifier. <ul style="list-style-type: none"> <li><i>mac-address domain_number</i>—Enter the MAC address and a domain number. The number can be from 0 to 65535.</li> <li><b>dns name</b>—Enter a DNS name string. The name can be a maximum of 43 characters.</li> <li><b>null</b>—Assign no domain name.</li> </ul>
Step 8	<b>service</b> { <i>ma-name</i>   <i>ma-number</i>   <i>vpn-id vpn</i> } { <b>vlan</b> <i>vlan-id</i> [ <b>direction down</b> ]   <b>port</b> }	Define a customer service maintenance association (MA) name or number or VPN ID to be associated with the domain, a VLAN ID or port MEP, and enter ethernet-cfm-service configuration mode. <ul style="list-style-type: none"> <li><i>ma-name</i>—a string of no more than 100 characters that identifies the MAID.</li> <li><i>ma-number</i>—a value from 0 to 65535.</li> <li><i>vpn-id vpn</i>—enter a VPN ID as the <i>ma-name</i>.</li> <li><b>vlan</b> <i>vlan-id</i>—VLAN range is from 1 to 4094. You cannot use the same VLAN ID for more than one domain at the same level.</li> <li>(Optional) <b>direction down</b>—specify the service direction as down.</li> <li><b>port</b>—Configure port MEP, a down MEP that is untagged and not associated with a VLAN.</li> </ul>
Step 9	<b>continuity-check</b>	Enable sending and receiving of continuity check messages.

	Command	Purpose
Step 10	<b>continuity-check interval</b> <i>value</i>	(Optional) Set the interval at which continuity check messages are sent. The available values are 100 ms, 1 second, 10 seconds, 1 minute and 10 minutes. The default is 10 seconds.  <b>Note</b> Because faster CCM rates are more CPU-intensive, we do not recommend configuring a large number of MEPs running at 100 ms intervals.
Step 11	<b>continuity-check loss-threshold</b> <i>threshold-value</i>	(Optional) Set the number of continuity check messages to be missed before declaring that an MEP is down. The range is 2 to 255; the default is 3.
Step 12	<b>maximum meps</b> <i>value</i>	(Optional) Configure the maximum number of MEPs allowed across the network. The range is from 1 to 65535. The default is 100.
Step 13	<b>sender-id</b> { <i>chassis</i>   <i>none</i> }	(Optional) Include the sender ID TLVs, attributes containing type, length, and values for neighbor devices. <ul style="list-style-type: none"> <li>• <b>chassis</b>—Send the chassis ID (host name).</li> <li>• <b>none</b>—Do not include information in the sender ID.</li> </ul>
Step 14	<b>mip auto-create</b> [ <i>lower-mep-only</i>   <i>none</i> ]	(Optional) Configure auto creation of MIPs for the service. <ul style="list-style-type: none"> <li>• <b>lower-mep-only</b>—Create a MIP only if there is a MEP for the service in another domain at the next lower active level.</li> <li>• <b>none</b> —No MIP auto-create.</li> </ul>
Step 15	<b>exit</b>	Return to ethernet-cfm configuration mode.
Step 16	<b>mip auto-create</b> [ <i>lower-mep-only</i> ]	(Optional) Configure auto creation of MIPs for the domain. <ul style="list-style-type: none"> <li>• <b>lower-mep-only</b>—Create a MIP only if there is a MEP for the service in another domain at the next lower active level.</li> </ul>
Step 17	<b>mep archive-hold-time</b> <i>minutes</i>	(Optional) Set the number of minutes that data from a missing maintenance end point is kept before it is purged. The range is 1 to 65535; the default is 100 minutes.
Step 18	<b>exit</b>	Return to global configuration mode.
Step 19	<b>interface</b> <i>interface-id</i>	Specify an interface to configure, and enter interface configuration mode.
Step 20	<b>service instance</b> <i>number ethernet name</i>	Specify the service instance number and the name of the EVC.
Step 21	<b>cfm mip level</b> <i>level-id</i>	(Optional) Configure a customer level or service-provider level maintenance intermediate point (MIP) for the interface. The MIP level range is 0 to 7.  <b>Note</b> This step is not required if you have entered the <b>ethernet cfm mip auto-create</b> global configuration command or the <b>mip auto-create</b> ethernet-cfm or ethernet-cfm-srv configuration mode.

	Command	Purpose
Step 22	<b>cfm mep domain</b> <i>domain-name</i> <b>mpid</b> <i>identifier</i>	Configure maintenance end points for the domain, and enter Ethernet cfm mep mode. <ul style="list-style-type: none"> <li>• <b>domain</b> <i>domain-name</i>—Specify the name of the created domain.</li> <li>• <b>mpid</b> <i>identifier</i>—Enter a maintenance end point identifier. The identifier must be unique for each VLAN (service instance). The range is 1 to 8191.</li> </ul>
Step 23	<b>cos</b> <i>value</i>	(Optional) Specify the class of service (CoS) value to be sent with the messages. The range is 0 to 7.
Step 24	<b>end</b>	Return to privileged EXEC mode.
Step 25	<b>show ethernet cfm maintenance-points</b> { <b>local</b>   <b>remote</b> }	Verify the configuration.
Step 26	<b>show ethernet cfm errors</b> [ <b>configuration</b> ]	(Optional) Display the configuration error list.
Step 27	<b>copy running-config startup-config</b>	(Optional) Save your entries in the configuration file.



**Note** Use the **no** form of each command to remove the configuration or return to the default configurations.

#### Example for Basic CFM configuration

```

Router(config)# ethernet cfm ieee
Router(config)# ethernet cfm global
Router(config)# ethernet cfm domain abc level 3
Router(config-ecfm)# service test evc EVC1 vlan 5
Router(config-ecfm-srv)# continuity-check
Router(config-ecfm-srv)# exit
Router(config-ecfm)# exit
Router(config)# ethernet evc EVC1
Router(config)# interface gigabitethernet 0/1
Router(config-if)# service instance 1 ethernet EVC1
Router(config-if-srv)# encapsulation dot1q 5
Router(config-if-srv)# rewrite ingress tag pop 1 symmetric
Router(config-if-srv)# bridge domain 5
Router(config-if-srv)# cfm mep domain abc mpid 100
Router(config-if-ecfm-mep)# exit

```



## Configuring Multi-UNI CFM MEPs in the Same VPN

Effective with Cisco IOS Release 15.3(2)S, services are configured such that two or more bridge domains (BDs) are used to achieve UNI isolation and backhauling towards provider edge (PE) device. Local MEPs (with up direction) need to be configured on the UNIs (with the associated BDs) to monitor the service backhaul connection. To achieve this, use the **alias** command to configure a CFM MA, MA2, as an alias to another MA, MA1. As a result, MA1 behaves as though it is configured as MA2 on a different Bridge Domain (BD) associated with it. MA1 and MA2 function as if they are part of the same service, thus associating the same CFM MA to two different BDs and UNI isolation.

Figure 10-1 shows the configuring Multi-NNI CFM in the same VPN.

**Figure 10-1** Configuring Multi-NNI CFM in the Same VPN

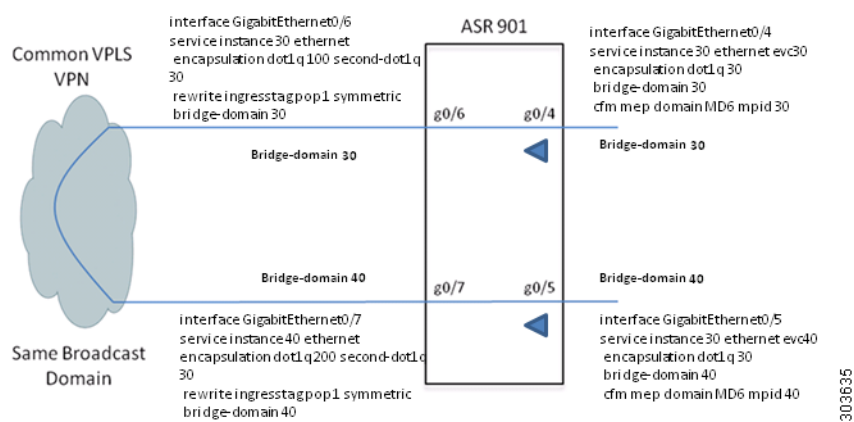

### Restrictions:

- Two MAs can be configured such that MA2 connected with different BD will act as a proxy (alias) for MA1 only for the MEPs which have the service direction as Up.
- Y1731-PM is not supported with Multi-NNI CFM.

Complete these steps to configure Multi-UNI CFM MEPs in the same VPN.

### SUMMARY STEPS

1. **configure terminal**
2. **ethernet cfm global**
3. **ethernet cfm domain *domain-name* level *level-id***
4. **service {*ma-name* | *ma-number* | **vpn-id** *vpn*} {**vlan** *vlan-id* [**direction down**] | **port**}**
5. **continuity-check**
6. **continuity-check interval *value***
7. **continuity-check loss-threshold *threshold-value***
8. **alias{*alias-short-ma-name* | **icc** *icc-code* *meg-id* | **number** *ma-number* | **vlan-id** *vlan-id* | **vpn-id** *vpn-id*}**
9. **exit**

10. **exit**
11. **interface** *interface-id*
12. **service instance** *number* **ethernet** *name*
13. **cfm mep domain** *domain-name* **mpid** *identifier*
14. **end**
15. **show ethernet cfm maintenance-points** {**local** | **remote**}
16. **show ethernet cfm errors** [**configuration**]
17. **copy running-config startup-config**

## DETAILED STEPS

	Command	Purpose
Step 1	<b>configure terminal</b>	Enter global configuration mode. Enter your password if prompted.
Step 2	<b>ethernet cfm global</b>  <b>Example:</b> Router(config)# ethernet cfm global	Globally enable Ethernet CFM on the router.
Step 3	<b>ethernet cfm domain</b> <i>domain-name</i> <b>level</b> <i>level-id</i>  <b>Example:</b> Router(config)# ethernet cfm domain MD6 level 6	Define a CFM domain, set the domain level, and enter ethernet-CFM configuration mode for the domain. The maintenance level number range is 0 to 7.
Step 4	<b>service</b> { <i>ma-name</i>   <i>ma-number</i>   <i>vpn-id</i> <i>vpn</i> } { <b>vlan</b> <i>vlan-id</i> [ <b>direction</b> <b>down</b> ]   <b>port</b> }  <b>Example:</b> Router(config-ecfm)# service MA6 evc evc30 vlan 30	<p>Define a customer service maintenance association (MA) name or number or VPN ID to be associated with the domain, a VLAN ID or port MEP, and enter ethernet-cfm-service configuration mode.</p> <ul style="list-style-type: none"> <li>• <i>ma-name</i>—a string of no more than 100 characters that identifies the MAID.</li> <li>• <i>ma-number</i>—a value from 0 to 65535.</li> <li>• <i>vpn-id</i> <i>vpn</i>—enter a VPN ID as the <i>ma-name</i>.</li> <li>• <b>vlan</b> <i>vlan-id</i>—VLAN range is from 1 to 4094. You cannot use the same VLAN ID for more than one domain at the same level.</li> <li>• (Optional) <b>direction down</b>—specify the service direction as down.</li> </ul> <p> <b>Note</b> Two MAs can be configured such that MA2 connected with different BD will act as a proxy (alias) for MA1 only for the MEPs which have the service direction as Up.</p> <ul style="list-style-type: none"> <li>• <b>port</b>—Configure port MEP, a down MEP that is untagged and not associated with a VLAN.</li> </ul>

	Command	Purpose
Step 5	<b>continuity-check</b>  <b>Example:</b> Router(config-ecfm-srv)# continuity-check	Enable sending and receiving of continuity check messages.
Step 6	<b>continuity-check interval</b> <i>value</i>  <b>Example:</b> Router(config-ecfm-srv)# continuity-check interval 1s	(Optional) Set the interval at which continuity check messages are sent. The available values are 100 ms, 1 second, 10 seconds, 1 minute and 10 minutes. The default is 10 seconds.  <b>Note</b> Because faster CCM rates are more CPU-intensive, we do not recommend configuring a large number of MEPs running at 100 ms intervals.
Step 7	<b>continuity-check loss-threshold</b> <i>threshold-value</i>  <b>Example:</b> Router(config-ecfm-srv)# continuity-check loss-threshold 4	(Optional) Set the number of continuity check messages to be missed before declaring that an MEP is down. The range is 2 to 255; the default is 3.
Step 8	<b>alias</b> { <i>alias-short-ma-name</i>   <b>icc</b> <i>icc-code meg-id</i>   <b>number</b> <i>ma-number</i>   <b>vlan-id</b> <i>vlan-id</i>   <b>vpn-id</b> <i>vpn-id</i> }  <b>Example:</b> Router(config-ecfm-srv)# alias MA6	Define a customer alias maintenance association (MA) name or number or VPN ID to be associated with the domain, a VLAN ID or port MEP, and enter ethernet-cfm-service configuration mode.  <ul style="list-style-type: none"> <li>• <i>alias-short-ma-name</i>—a string of no more than 100 characters that identifies the MAID.</li> <li>• <b>icc</b> <i>icc-code meg-id</i>—specify the ITU Carrier Code (ICC) (maximum: 6 characters) and Unique Maintenance Entity Group (MEG) ID Code (UMC). The maximum characters allowed is 12.</li> <li>• <b>number</b> <i>ma-number</i>—a value from 0 to 65535.</li> <li>• <b>vlan-id</b> <i>vlan-id</i>—VLAN range is from 1 to 4094. You cannot use the same VLAN ID for more than one domain at the same level.</li> <li>• <b>vpn-id</b> <i>vpn-id</i>—enter a VPN ID as the <i>ma-name</i>.</li> </ul>
Step 9	<b>exit</b>	Return to ethernet-CFM configuration mode.
Step 10	<b>exit</b>	Return to global configuration mode.
Step 11	<b>interface</b> <i>interface-id</i>  <b>Example:</b> Router(config)# interface gigabitethernet 0/4	Specify an interface to configure, and enter interface configuration mode.
Step 12	<b>service instance</b> <i>number ethernet name</i>  <b>Example:</b> Router(config-if)# service instance 30 ethernet EVC30	Specify the service instance number and the name of the EVC.

	Command	Purpose
Step 13	<b>cfm mep domain</b> <i>domain-name</i> <b>mpid</b> <i>identifier</i>  <b>Example:</b> Router(config-if-srv)# cfm mep domain MD6 mpid 30	Configure maintenance end points for the domain, and enter Ethernet cfm mep mode. <ul style="list-style-type: none"> <li><b>domain</b> <i>domain-name</i>—Specify the name of the created domain.</li> <li><b>mpid</b> <i>identifier</i>—Enter a maintenance end point identifier. The identifier must be unique for each VLAN (service instance). The range is 1 to 8191.</li> </ul>
Step 14	<b>end</b>	Return to privileged EXEC mode.
Step 15	<b>show ethernet cfm maintenance-points</b> {local   remote}	Verify the configuration.
Step 16	<b>show ethernet cfm errors</b> [configuration]	(Optional) Display the configuration error list.
Step 17	<b>copy running-config startup-config</b>	(Optional) Save your entries in the configuration file.

### Configuration Examples for Multi-UNI CFM MEPS

#### Example Configuration for Multi-UNI CFM MEPS in the same VPN

```

Router(config)# ethernet cfm ieee
Router(config)# ethernet cfm global
Router(config)# ethernet cfm domain MD6 level 6
Router(config-ecfm)# service MA6 evc evc30 vlan 30
Router(config-ecfm-srv)# continuity-check
Router(config-ecfm-srv)# continuity-check interval 1s
Router(config-ecfm-srv)# service MA6_alias evc evc40 vlan 40
Router(config-ecfm-srv)# continuity-check
Router(config-ecfm-srv)# continuity-check interval 1s
Router(config-ecfm-srv)# alias MA6
Router(config-ecfm-srv)# exit
Router(config-ecfm)# exit
Router(config)# ethernet evc EVC30
Router(config)# interface gigabitethernet 0/4
Router(config-if)# service instance 30 ethernet EVC30
Router(config-if-srv)# encapsulation dot1q 30
Router(config-if-srv)# bridge domain 30
Router(config-if-srv)# cfm mep domain MD6 mpid 30
Router(config-if-srv)# exit
Router(config-if)# exit
Router(config)# ethernet evc EVC40
Router(config)# interface gigabitethernet 0/5
Router(config-if)# service instance 30 ethernet EVC40
Router(config-if-srv)# encapsulation dot1q 30
Router(config-if-srv)# bridge domain 40
Router(config-if-srv)# cfm mep domain MD6 mpid 40
Router(config-if-srv)# exit
Router(config-if)# exit
Router(config)# interface gigabitethernet 0/6
Router(config-if)# service instance 30 ethernet
Router(config-if-srv)# encapsulation dot1q 100 second-dot1q 30
Router(config-if-srv)# rewrite ingress tag pop 1 symmetric
Router(config-if-srv)# bridge domain 30
Router(config-if-srv)# exit
Router(config-if)# exit
Router(config)# interface gigabitethernet 0/7
Router(config-if)# service instance 40 ethernet
Router(config-if-srv)# encapsulation dot1q 200 second-dot1q 30
Router(config-if-srv)# rewrite ingress tag pop 1 symmetric

```

```
Router(config-if-srv)# bridge domain 40
Router(config-if-srv)# exit
Router(config-if)# exit
```

## Verification

Use the following commands to verify a configuration:

- Use the **show ethernet cfm maintenance-point local** command to verify the Multi-UNI CFMs over EVC configuration. This command shows the basic configuration information for Multi-UNI CFM.

```
Router# show ethernet cfm maintenance-points local
Local MEPs:
```

MPID	Domain Name	Lvl	MacAddress	Type	CC
Ofld	Domain Id	Dir	Port	Id	
	MA Name		SrvcInst	Source	
	EVC name				
30	MD6	6	4055.3989.7868	BD-V	Y
No	MD6	Up	Gi0/4	30	
	MA6		30	Static	
	evc30				
40	MD6	6	4055.3989.7869	BD-V	Y
No	MD6	Up	Gi0/5	40	
	MA6_alias (MA6)		40	Static	
	evc40				

```
Total Local MEPs: 2
```

```
Local MIPs: None
```

- Use the **show ethernet cfm maintenance-point remote** to verify the MEP configuration:

```
Router# show ethernet cfm maintenance-points remote
```

MPID	Domain Name	MacAddress	IfSt	PtSt
Lvl	Domain ID	Ingress		
RDI	MA Name	Type Id	SrvcInst	
	EVC Name		Age	
	Local MEP Info			
40	MD6	4055.3989.7869	Up	Up
6	MD6	Gi0/6		
-	MA6	BD-V 30	30	
	evc30		0s	
	MPID: 30 Domain: MD6 MA: MA6			
30	MD6	4055.3989.7868	Up	Up
6	MD6	Gi0/7		
-	MA6_alias (MA6)	BD-V 40	40	
	evc40		1s	
	MPID: 40 Domain: MD6 MA: MA6_alias (MA6)			

```
Total Remote MEPs: 2
```

## Configuring Ethernet CFM Crosscheck

Complete the following steps to configure Ethernet CFM crosscheck:

	Command	Purpose
Step 1	<code>configure terminal</code>	Enter global configuration mode.
Step 2	<code>ethernet cfm mep crosscheck start-delay delay</code>	Configure the number of seconds that the device waits for remote MEPs to come up before the crosscheck is started. The range is 1 to 65535; the default is 30 seconds.
Step 3	<code>ethernet cfm domain domain-name level level-id</code>	Define a CFM domain, set the domain level, and enter ethernet-cfm configuration mode for the domain. The maintenance level number range is 0 to 7.
Step 4	<code>service {ma-name   ma-number   vpn-id vpn} {vlan vlan-id}</code>	Define a customer service maintenance association name or number or VPN ID to be associated with the domain, and a VLAN ID, and enter ethernet-cfm-service configuration mode. <ul style="list-style-type: none"> <li><i>ma-name</i>—a string of no more than 100 characters that identifies the MAID.</li> <li><i>ma-number</i>—a value from 0 to 65535.</li> <li><i>vpn-id vpn</i>—enter a VPN ID as the <i>ma-name</i>.</li> <li><b>vlan</b> <i>vlan-id</i>—VLAN range is from 1 to 4094. You cannot use the same VLAN ID for more than one domain at the same level.</li> </ul>
Step 5	<code>mep mpid identifier</code>	Define the MEP maintenance end point identifier in the domain and service. The range is 1 to 8191
Step 6	<code>end</code>	Return to privileged EXEC mode.
Step 7	<code>ethernet cfm mep crosscheck {enable   disable} domain domain-name {vlan {vlan-id   any}   port}</code>	Enable or disable CFM crosscheck for one or more VLANs or a port MEP in the domain. <ul style="list-style-type: none"> <li><b>domain</b> <i>domain-name</i>—Specify the name of the created domain.</li> <li><b>vlan</b> {<i>vlan-id</i>   <b>any</b>}—Enter the service provider VLAN ID or IDs as a VLAN-ID (1 to 4094), a range of VLAN-IDs separated by a hyphen, or a series of VLAN IDs separated by comma. Enter <b>any</b> for any VLAN.</li> <li><b>port</b>—Identify a port MEP.</li> </ul>
Step 8	<code>show ethernet cfm maintenance-points remote crosscheck</code>	Verify the configuration.
Step 9	<code>show ethernet cfm errors [configuration]</code>	Enter this command after you enable CFM crosscheck to display the results of the crosscheck operation. Enter the <b>configuration</b> keyword to display the configuration error list.
Step 10	<code>copy running-config startup-config</code>	(Optional) Save your entries in the configuration file.



**Note** Use the **no** form of each command to remove a configuration or to return to the default settings.

## Configuring Static Remote MEP

Complete the following steps to configure Ethernet CFM static remote MEP:

	Command	Purpose
Step 1	<b>configure terminal</b>	Enter global configuration mode.
Step 2	<b>ethernet cfm domain</b> <i>domain-name</i> <b>level</b> <i>level-id</i>	Define a CFM domain, set the domain level, and enter ethernet-cfm configuration mode for the domain. The maintenance level number range is 0 to 7.
Step 3	<b>service</b> { <i>short-ma-name</i>   <b>number</b> <i>MA-number</i>   <b>vlan-id</b> <i>primary-vlan-id</i>   <b>vpn-id</b> <i>vpn-id</i> } { <b>vlan</b> <i>vlan-id</i>   <b>port</b>   <b>evc</b> <i>evc-name</i> }	Configure the maintenance association and set a universally unique ID for a customer service instance (CSI) or the maintenance association number value, primary VLAN ID and VPN ID within a maintenance domain in Ethernet connectivity fault management (CFM) configuration mode.
Step 4	<b>continuity-check</b>	Enable sending and receiving of continuity check messages.
Step 5	<b>mep mpid</b> <i>identifier</i>	Define the static remote maintenance end point identifier. The range is 1 to 8191
Step 6	<b>continuity-check static rmep</b>	Enable checking of the incoming continuity check message from a remote MEP that is configured in the MEP list.
Step 7	<b>end</b>	Return to privileged EXEC mode.
Step 8	<b>show ethernet cfm maintenance-points remote static</b>	Verify the configuration.
Step 9	<b>show ethernet cfm errors [configuration]</b>	Enter this command after you enable CFM crosscheck to display the results of the crosscheck operation. Enter the <b>configuration</b> keyword to display the configuration error list.
Step 10	<b>copy running-config startup-config</b>	(Optional) Save your entries in the configuration file.



**Note** Use the **no** form of each command to remove a configuration or to return to the default settings.

## Configuring a Port MEP

A port MEP is a down MEP that is not associated with a VLAN and that uses untagged frames to carry CFM messages. You configure port MEPs on two connected interfaces. Port MEPs are always configured at a lower domain level than native VLAN MEPs.

Complete the following steps to configure Ethernet CFM port MEPs:

	Command	Purpose
Step 1	<b>configure terminal</b>	Enter global configuration mode.
Step 2	<b>ethernet cfm domain</b> <i>domain-name</i> <b>level</b> <i>level-id</i>	Define a CFM domain, set the domain level, and enter ethernet-cfm configuration mode for the domain. The maintenance level number range is 0 to 7.
Step 3	<b>service</b> { <i>ma-name</i>   <i>ma-number</i>   <i>vpn-id</i> } <b>port</b>	Define a customer service maintenance association name or number or VPN ID to be associated with the domain, define a port MEP, and enter ethernet-cfm-service configuration mode. <ul style="list-style-type: none"> <li>• <i>ma-name</i>—a string of no more than 100 characters that identifies the MAID.</li> <li>• <i>ma-number</i>—a value from 0 to 65535.</li> <li>• <i>vpn-id</i> <i>vpn</i>—enter a VPN ID as the <i>ma-name</i>.</li> </ul>
Step 4	<b>mep mpid</b> <i>identifier</i>	Define the static remote maintenance end point identifier in the domain and service. The range is 1 to 8191
Step 5	<b>continuity-check</b>	Enable sending and receiving of continuity check messages.
Step 6	<b>continuity-check interval</b> <i>value</i>	(Optional) Set the interval at which continuity check messages are sent. The available values are 100 ms, 1 second, 10 seconds, 1 minute and 10 minutes. The default is 10 seconds. <b>Note</b> Because faster CCM rates are more CPU-intensive, we do not recommend configuring a large number of MEPs running at 100 ms intervals.
Step 7	<b>continuity-check loss-threshold</b> <i>threshold-value</i>	(Optional) Set the number of continuity check messages to be missed before declaring that an MEP is down. The range is 2 to 255; the default is 3.
Step 8	<b>continuity-check static rmeip</b>	Enable checking of the incoming continuity check message from a remote MEP that is configured in the MEP list.
Step 9	<b>exit</b>	Return to ethernet-cfm configuration mode.
Step 10	<b>exit</b>	Return to global configuration mode.
Step 11	<b>interface</b> <i>interface-id</i>	Identify the port MEP interface and enter interface configuration mode.



	Command	Purpose
Step 12	<b>ethernet cfm mep domain</b> <i>domain-name</i> <b>mpid identifier port</b>	Configure the interface as a port MEP for the domain. <ul style="list-style-type: none"> <li>• <b>domain</b> <i>domain-name</i>—Specify the name of the created domain.</li> <li>• <b>mpid identifier</b>—Enter a maintenance end point identifier. The identifier must be unique for each VLAN (service instance). The range is 1 to 8191.</li> </ul>
Step 13	<b>end</b>	Return to privileged EXEC mode.
Step 14	<b>show ethernet cfm maintenance-points remote static</b>	Verify the configuration.
Step 15	<b>show ethernet cfm errors [configuration]</b>	Enter this command after you enable CFM crosscheck to display the results of the crosscheck operation. Enter the <b>configuration</b> keyword to display the configuration error list.
Step 16	<b>copy running-config startup-config</b>	(Optional) Save your entries in the configuration file.



**Note** Use the **no** form of each command to remove a configuration or to return to the default settings.

This is a sample configuration for a port MEP:

```
Router(config)# ethernet cfm domain abc level 3
Router(config-ecfm)# service PORTMEP port
Router(config-ecfm-srv)# mep mpid 222
Router(config-ecfm-srv)# continuity-check
Router(config-ecfm-srv)# continuity-check static rmep
Router(config-ecfm-srv)# exit
Router(config-ecfm)# exit
Router(config)# interface gigabitethernet 0/1
Router(config-if)# ethernet cfm mep domain abc mpid 111 port
Router(config-if)# end
```

## Configuring SNMP Traps

To configure traps for Ethernet CFM, complete the following steps:

	Command	Purpose
Step 1	<b>configure terminal</b>	Enter global configuration mode.
Step 2	<b>snmp-server enable traps ethernet cfm cc [mep-up] [mep-down] [config] [loop] [cross-connect]</b>	(Optional) Enable Ethernet CFM continuity check traps.
Step 3	<b>snmp-server enable traps ethernet cfm crosscheck [mep-unknown] [mep-missing] [service-up]</b>	(Optional) Enable Ethernet CFM crosscheck traps.
Step 4	<b>end</b>	Return to privileged EXEC mode.
Step 5	<b>show running-config</b>	Verify your entries.
Step 6	<b>copy running-config startup-config</b>	(Optional) Save your entries in the configuration file.

**Note**

Use the **no** form of each command to remove a configuration or to return to the default settings.

## Configuring IP SLA CFM Operation

You can manually configure an individual IP SLA ethernet ping, or jitter echo operation, or you can configure IP SLA ethernet operation with endpoint discovery. You can also configure multiple operation scheduling. For accurate one-way delay statistics, the clocks on the endpoint switches must be synchronized. You can configure the endpoint switches with Network Time Protocol (NTP) so that the switches are synchronized to the same clock source.

For more information about configuring IP SLA ethernet operations, see the [IP SLAs Configuration Guide, Cisco IOS Release 15.0S](#). For detailed information about commands for IP SLAs, see the [Cisco IOS IP SLAs Command Reference](#).

**Note**

The Cisco ASR 901 does not necessarily support all of the commands listed in the Cisco IOS IP SLA documentation.

This section includes these procedures:

- [Manually Configuring an IP SLA CFM Probe or Jitter Operation, page 10-16](#)
- [Configuring an IP SLA Operation with Endpoint Discovery, page 10-18](#)

## Manually Configuring an IP SLA CFM Probe or Jitter Operation

To manually configure an IP SLA ethernet echo (ping) or jitter operation, complete the following steps:

	Command	Purpose
Step 1	<b>configure terminal</b>	Enter global configuration mode.
Step 2	<b>ip sla <i>operation-number</i></b>	Create an IP SLA operation, and enter IP SLA configuration mode.
Step 3	<b>ethernet echo mpid <i>identifier</i> domain <i>domain-name</i>  vlan <i>vlan-id</i></b> or <b>ethernet jitter mpid <i>identifier</i> domain <i>domain-name</i>  vlan <i>vlan-id</i> [<i>interval interpacket-interval</i>]  [<i>num-frames number-of-frames-transmitted</i>]</b>	Configure the IP SLA operation as an echo (ping) or jitter operation, and enter IP SLA ethernet echo configuration mode. <ul style="list-style-type: none"> <li>• Enter <b>echo</b> for a ping operation or <b>jitter</b> for a jitter operation.</li> <li>• For <b>mpid <i>identifier</i></b>, enter a maintenance endpoint identifier. The identifier must be unique for each VLAN (service instance). The range is 1 to 8191.</li> <li>• For <b>domain <i>domain-name</i></b>, enter the CFM domain name.</li> <li>• For <b>vlan <i>vlan-id</i></b>, the VLAN range is from 1 to 4095.</li> <li>• (Optional—for jitter only) Enter the <b>interval</b> between sending of jitter packets.</li> <li>• (Optional—for jitter only) Enter the <b>num-frames</b> and the number of frames to be sent.</li> </ul>

	Command	Purpose
Step 4	<b>cos</b> <i>cos-value</i>	(Optional) Set a class of service value for the operation.
Step 5	<b>frequency</b> <i>seconds</i>	(Optional) Set the rate at which the IP SLA operation repeats. The range is from 1 to 604800 seconds; the default is 60 seconds.
Step 6	<b>history</b> <i>history-parameter</i>	(Optional) Specify parameters for gathering statistical history information for the IP SLA operation.
Step 7	<b>owner</b> <i>owner-id</i>	(Optional) Configure the SNMP owner of the IP SLA operation.
Step 8	<b>request-data-size</b> <i>bytes</i>	(Optional) Specify the protocol data size for an IP SLA request packet. The range is from 0 to the maximum size allowed by the protocol being used; the default is 66 bytes.
Step 9	<b>tag</b> <i>text</i>	(Optional) Create a user-specified identifier for an IP SLA operation.
Step 10	<b>threshold</b> <i>milliseconds</i>	(Optional) Specify the upper threshold value in milliseconds (ms0 for calculating network monitoring statistics. The range is 0 to 2147483647; the default is 5000.
Step 11	<b>timeout</b> <i>milliseconds</i>	(Optional) Specify the amount of time in ms that the IP SLA operation waits for a response from its request packet. The range is 0 to 604800000; the default value is 5000.
Step 12	<b>exit</b>	Return to global configuration mode.
Step 13	<b>ip sla schedule</b> <i>operation-number</i> [ <b>ageout</b> <i>seconds</i> ] [ <b>life</b> { <b>forever</b>   <i>seconds</i> }] [ <b>recurring</b> ] [ <b>start-time</b> { <i>hh:mm:ss</i> } [ <i>month day</i>   <i>day month</i> ]   <b>pending</b>   <b>now</b>   <b>after</b> <i>hh:mm:ss</i> ]	<p>Schedule the time parameters for the IP SLA operation.</p> <ul style="list-style-type: none"> <li>• <i>operation-number</i>—Enter the IP SLA operation number.</li> <li>• (Optional) <b>ageout</b> <i>seconds</i>—Enter the number of seconds to keep the operation in memory when it is not actively collecting information. The range is 0 to 2073600 seconds. The default is 0 seconds.</li> <li>• (Optional) <b>life</b>—Set the operation to run indefinitely (<b>forever</b>) or for a specific number of <i>seconds</i>. The range is from 0 to 2147483647. The default is 3600 seconds (1 hour)</li> <li>• (Optional) <b>recurring</b>—Set the probe to be automatically scheduled every day.</li> <li>• (Optional) <b>start-time</b>—Enter the time for the operation to begin collecting information: <ul style="list-style-type: none"> <li>– To start at a specific time, enter the hour, minute, second (in 24-hour notation), and day of the month.</li> <li>– Enter <b>pending</b> to select no information collection until a start time is selected.</li> <li>– Enter <b>now</b> to start the operation immediately.</li> <li>– Enter <b>after</b> <i>hh:mm:ss</i> to show that the operation should start after the entered time has elapsed.</li> </ul> </li> </ul>

	Command	Purpose
Step 14	<b>end</b>	Return to privileged EXEC mode.
Step 15	<b>show ip sla configuration</b> [ <i>operation-number</i> ]	Show the configured IP SLA operation.
Step 16	<b>copy running-config startup-config</b>	(Optional) Save your entries in the configuration file.

To remove an IP SLA operation, enter the no **ip sla** *operation-number* global configuration command.

### Configuring an IP SLA Operation with Endpoint Discovery

To automatically discover the CFM endpoints for a domain and VLAN ID, using IP SLAs, complete the steps given below. You can configure ping or jitter operations to the discovered endpoints.

	Command	Purpose
Step 1	<b>configure terminal</b>	Enter global configuration mode.
Step 2	<b>ip sla ethernet-monitor</b> <i>operation-number</i>	Begin configuration of an IP SLA automatic ethernet operation, and enter IP SLA ethernet monitor configuration mode.
Step 3	<b>type echo domain</b> <i>domain-name</i> <b>vlan</b> <i>vlan-id</i> [ <b>exclude-mpids</b> <i>mp-ids</i> ] or  <b>type jitter domain</b> <i>domain-name</i> <b>vlan</b> <i>vlan-id</i> [ <b>exclude-mpids</b> <i>mp-ids</i> ] [ <b>interval</b> <i>interpacket-interval</i> ] [ <b>num-frames</b> <i>number-of-frames</i> <i>transmitted</i> ]	Configure the automatic Ethernet operation to create echo (ping) or jitter operation and enter IP SLA ethernet echo configuration mode. <ul style="list-style-type: none"> <li>• Enter <b>type echo</b> for a ping operation or <b>type jitter</b> for a jitter operation.</li> <li>• For <b>mpid identifier</b>, enter a maintenance endpoint identifier. The range is 1 to 8191.</li> <li>• For <b>domain</b> <i>domain-name</i>, enter the CFM domain name.</li> <li>• For <b>vlan</b> <i>vlan-id</i>, the VLAN range is from 1 to 4095.</li> <li>• (Optional) Enter <b>exclude-mpids</b> <i>mp-ids</i> to exclude the specified maintenance endpoint identifiers.</li> <li>• (Optional—for jitter only) Enter the <b>interval</b> between sending of jitter packets.</li> <li>• (Optional—for jitter only) Enter the <b>num-frames</b> and the number of frames to be sent.</li> </ul>
Step 4	<b>cos</b> <i>cos-value</i>	(Optional) Set a class of service value for the operation.  Before configuring the <b>cos</b> parameter, you must globally enable QoS by entering the <b>mls qos</b> global configuration command.
Step 5	<b>owner</b> <i>owner-id</i>	(Optional) Configure the SNMP owner of the IP SLA operation.
Step 6	<b>request-data-size</b> <i>bytes</i>	(Optional) Specify the protocol data size for an IP SLA request packet. The range is from 0 to the maximum size allowed by the protocol being used; the default is 66 bytes.
Step 7	<b>tag</b> <i>text</i>	(Optional) Create a user-specified identifier for an IP SLA operation.

	Command	Purpose
Step 8	<b>threshold</b> <i>milliseconds</i>	(Optional) Specify the upper threshold value in milliseconds for calculating network monitoring statistics. The range is 0 to 2147483647; the default is 5000.
Step 9	<b>timeout</b> <i>milliseconds</i>	(Optional) Specify the amount of time in milliseconds that the IP SLA operation waits for a response from its request packet. The range is 0 to 604800000; the default value is 5000.
Step 10	<b>exit</b>	Return to global configuration mode.
Step 11	<b>ip sla schedule</b> <i>operation-number</i> [ <b>ageout</b> <i>seconds</i> ] [ <b>life</b> { <b>forever</b>   <i>seconds</i> }] [ <b>recurring</b> ] [ <b>start-time</b> { <i>hh:mm:ss</i>   <i>month day</i>   <i>day month</i> }   <b>pending</b>   <b>now</b>   <b>after</b> <i>hh:mm:ss</i> ]	Schedule the time parameters for the IP SLA operation. <ul style="list-style-type: none"> <li>• <i>operation-number</i>—Enter the IP SLA operation number.</li> <li>• (Optional) <b>ageout</b> <i>seconds</i>—Enter the number of seconds to keep the operation in memory when it is not actively collecting information. The range is 0 to 2073600 seconds. The default is 0 seconds.</li> <li>• (Optional) <b>life</b>—Set the operation to run indefinitely (<b>forever</b>) or for a specific number of <i>seconds</i>. The range is from 0 to 2147483647. The default is 3600 seconds (1 hour)</li> <li>• (Optional) <b>recurring</b>—Set the probe to be automatically scheduled every day.</li> <li>• (Optional) <b>start-time</b>—Enter the time for the operation to begin collecting information: <ul style="list-style-type: none"> <li>– To start at a specific time, enter the hour, minute, second (in 24-hour notation), and day of the month.</li> <li>– Enter <b>pending</b> to select no information collection until a start time is selected.</li> <li>– Enter <b>now</b> to start the operation immediately.</li> <li>– Enter <b>after</b> <i>hh:mm:ss</i> to show that the operation should start after the entered time has elapsed.</li> </ul> </li> </ul>
Step 12	<b>end</b>	Return to privileged EXEC mode.
Step 13	<b>show ip sla configuration</b> [ <i>operation-number</i> ]	Show the configured IP SLA operation.
Step 14	<b>copy running-config startup-config</b>	(Optional) Save your entries in the configuration file.

To remove an IP SLA operation, enter the **no ip sla** *operation-number* global configuration command.

## Configuring CFM over EFP with Cross Connect

The CFM over EFP Interface with cross connect feature allows you to:

- Forward continuity check messages (CCM) towards the core over cross connect pseudowires.

To know more about pseudowires, see

- Receive CFM messages from the core.
- Forward CFM messages to the access side (after Continuity Check Database [CCDB] based on maintenance point [MP] filtering rules).

This section contains the following topics:

- [Configuring CFM over EFP Interface with Cross Connect, page 10-20](#)
- [Configuring CFM over EFP Interface with Cross Connect—Port Channel-Based Cross Connect Tunnel, page 10-22](#)

## Configuring CFM over EFP Interface with Cross Connect

To configure CFM over EFP Interface with cross connect, complete the following steps.

	Command	Purpose
Step 1	<b>enable</b>  <b>Example:</b> Router# enable	Enables privileged EXEC mode. <ul style="list-style-type: none"> <li>• Enter your password if prompted.</li> </ul>
Step 2	<b>configure terminal</b>  <b>Example:</b> Router# configure terminal	Enters global configuration mode.
Step 3	<b>pseudowire-class</b> [pw-class-name]  <b>Example:</b> Router(config)# pseudowire-class vlan-xconnect	Specifies the name of a Layer 2 pseudowire class and enter pseudowire class configuration mode.
Step 4	<b>encapsulation mpls</b>  <b>Example:</b> Router(config-if)# encapsulation mpls	Specifies that Multiprotocol Label Switching (MPLS) is used as the data encapsulation method for tunneling Layer 2 traffic over the pseudowire.
Step 5	<b>exit</b>  <b>Example:</b> Router(config-if-srv)# exit	Exits the pseudowire class configuration mode.
Step 6	<b>interface gigabitethernet</b> slot/port <b>or</b> <b>interface tengigabitethernet</b> slot/port  <b>Example:</b> Router(config-if-srv)# interface Gi2/0/2	Specifies the Gigabit Ethernet or the Ten Gigabit Ethernet interface to configure.

	Command	Purpose
<b>Step 7</b>	<b>service instance id ethernet</b> [service-name]  <b>Example:</b> Router(config-if-srv)# service instance 101 ethernet	Creates a service instance (an instantiation of an EVC) on an interface and sets the device into the config-if-srv submenu.
<b>Step 8</b>	<b>encapsulation untagged   dot1q vlan-id   default</b>  <b>Example:</b> Router(config-if-srv)# encapsulation dot1q 100	Configures the encapsulation. Defines the matching criteria that maps the ingress dot1q or untagged frames on an interface for the appropriate service instance. Effective with Cisco IOS Release 15.3(2)S, default encapsulation is supported.   <b>Note</b> dot1q range and second-dot1q are not supported for EFP Interface with Cross Connect.
<b>Step 9</b>	<b>xconnect peer-ip-address vc-id {encapsulation {l2tpv3 [manual]   mpls [manual]}   pw-class pw-class-name} [pw-class pw-class-name] [sequencing {transmit   receive   both}]</b>  <b>Example:</b> Router(config-if-srv)# xconnect 10.0.3.201 123 pw-class vlan-xconnect	Binds an attachment circuit to a pseudowire, and configures an Any Transport over MPLS (AToM) static pseudowire.
<b>Step 10</b>	<b>cfm mep domain domain-name [up   down] mpid mpid-value [cos cos-value]</b>  <b>Example:</b> Router(config-if-srv)# cfm mep down mpid 100 domain Core	Configures a maintenance endpoint (MEP) for a domain.
<b>Step 11</b>	<b>exit</b>  <b>Example:</b> Router(config-if-srv)# exit	Exits the interface configuration mode.

## Examples

This example shows how to configure CFM over EVC using cross connect.

```
ASR901(config)#ethernet cfm ieee
ASR901(config)#ethernet cfm global
ASR901(config)#ethernet cfm domain L5 level 5
ASR901(config-ecfm)# service s1 evc e711
ASR901(config-ecfm-srv)# continuity-check
ASR901(config-ecfm-srv)#exit
ASR901(config-ecfm)#exit
```

### Example for untagged Encapsulation

```
ASR901(config)#int g0/1
ASR901(config-if)#service instance 711 ethernet e711
```

```

ASR901(config-if-srv)#encapsulation untagged
ASR901(config-if-srv)# xconnect 3.3.3.3 3 encapsulation mpls
ASR901(cfg-if-ether-vc-xconn)# mtu 1500
ASR901(cfg-if-ether-vc-xconn)# cfm mep domain L5 mpid 511

```

#### Example for single tag Encapsulation

```

ASR901(config)#int g0/1
ASR901(config-if)#service instance 711 ethernet e711
ASR901(config-if-srv)# encapsulation dot1q 711
ASR901(config-if-srv)# xconnect 3.3.3.3 3 encapsulation mpls
ASR901(cfg-if-ether-vc-xconn)# mtu 1500
ASR901(cfg-if-ether-vc-xconn)# cfm mep domain L5 mpid 511

```

## Configuring CFM over EFP Interface with Cross Connect—Port Channel-Based Cross Connect Tunnel

This section describes how to configure CFM over EFP Interface with Port Channel-Based cross connect Tunnel.

### Examples

This example shows how to configure CFM over EFP Interface with Port Channel-Based cross connect Tunnel:

```

ASR901(config)#ethernet cfm ieee
ASR901(config)#ethernet cfm global
ASR901(config)#ethernet cfm domain L5 level 5
ASR901(config-ecfm)# service s1 evc e711
ASR901(config-ecfm-srv)# continuity-check
ASR901(config-ecfm-srv)#exit
ASR901(config-ecfm)#exit
ASR901(config)#interface GigabitEthernet0/1
ASR901(config-if)# negotiation auto
ASR901(config-if)# no keepalive
ASR901(config-if)# channel-group 1 mode on
ASR901(config-if)#exit
ASR901(config)#interface GigabitEthernet0/7
ASR901(config-if)# negotiation auto
ASR901(config-if)# channel-group 1 mode on
ASR901(config-if)#exit
ASR901(config)#int port-channel 1
ASR901(config-if)#service instance 711 ethernet e711
ASR901(config-if-srv)# encapsulation dot1q 711
ASR901(config-if-srv)# xconnect 3.3.3.3 3 encapsulation mpls
ASR901(cfg-if-ether-vc-xconn)# mtu 1500
ASR901(cfg-if-ether-vc-xconn)# cfm mep domain L5 mpid 511

```

### Verification

Use the following commands to verify a configuration:

- Use the **show ethernet cfm maintenance-point local** commands to verify the CFM over EVC configuration. This command shows the basic configuration information for CFM.

```

Router-30-PE1#show ethernet cfm maintenance-point local
Local MEPs:

```

```

-----
MPID Domain Name                               Lvl  MacAddress      Type  CC

```



```

          Domain Id          Dir  Port          Id
          MA Name           SvcInst
          EVC name
-----
1      L6                   6    000a.f393.56d0 XCON  Y
      L6                   Down  Gi0/2 N/A
      bbb                   1
      bbb
3      L5                   5    0007.8478.4410 XCON  Y
      L5                   Up    Gi0/2 N/A
      bbb                   1
      bbb

```

Total Local MEPS: 2

Local MIPs:

\* = MIP Manually Configured

```

-----
Level Port          MacAddress      SvcInst  Type  Id
-----
7      Gi0/2 0007.8478.4410 1          XCON   N/A

```

Total Local MIPs: 1

- Use the **show ethernet cfm maintenance-point remote** to verify the MEP configuration:

```
Router-30-PE1#show ethernet cfm maintenance-point remote
```

```

-----
MPID  Domain Name          MacAddress      IfSt  PtSt
Lvl   Domain ID             Ingress
RDI   MA Name              Type Id        SvcInst
      EVC Name            Age
-----
4      L5                   000a.f393.56d0  Up    Up
5      L5                   Te2/0/0:(2.2.2.2, 1)
-      bbb                   XCON N/A        1
      bbb                   9s
2      L6                   000a.f393.56d0  Up    Up
6      L6                   Te2/0/0:(2.2.2.2, 1)
-      bbb                   XCON N/A        1
      bbb                   1s

```

Total Remote MEPS: 2

- Use the **show ethernet cfm mpdb** command to verify the catalogue of CC with MIP in intermediate routers.

```
PE2#show ethernet cfm mpdb
```

\* = Can Ping/Traceroute to MEP

```

-----
MPID  Domain Name          MacAddress      Version
Lvl   Domain ID             Ingress
Expd  MA Name              Type Id        SvcInst
      EVC Name            Age
-----
600 * L6                   0021.d8ca.d7d0  IEEE-CFM
6      L6                   Te2/1:(2.2.2.2, 1)
-      s1                   XCON N/A        1
      1                   2s
700   L7                   001f.cab7.fd01  IEEE-CFM
7      L7                   Te2/1:(2.2.2.2, 1)
-      s1                   XCON N/A        1
      1                   3s

```

```
Total Remote MEPs: 2
```

- Use **show ethernet cfm error** command to view the error report:

```
PE2#show ethernet cfm error
-----
MPID Domain Id                               Mac Address      Type  Id  Lvl
      MAName                               Reason
-----
-   L3                                     001d.45fe.ca81  BD-V  200  3
      s2                                     Receive AIS      8s
PE2#
```

## Configuring CFM with EVC Default Encapsulation

Complete the following steps to configure CFM with EVC default encapsulation:

### SUMMARY STEPS

1. **enable**
2. **configure terminal**
3. **interface** *type number*
4. **service instance** *instance-id* **ethernet** *evc-name*
5. **encapsulation default**
6. **bridge-domain** *bridge-id*
7. **cfm encapsulation** { **dot1ad** *vlan-id* | **dot1q** *vlan-id* } [**dot1q** *vlan-id* | **second-dot1q** *vlan-id*]
8. **cfm mep domain** *domain-name* **mpid** *mpid-value*

### DETAILED STEPS

	Command or Action	Purpose
Step 1	<b>enable</b>  <b>Example:</b> Router> enable	Enables privileged EXEC mode. <ul style="list-style-type: none"> <li>• Enter your password if prompted.</li> </ul>
Step 2	<b>configure terminal</b>  <b>Example:</b> Router# configure terminal	Enters global configuration mode.
Step 3	<b>interface</b> <i>type number</i>  <b>Example:</b> Router(config)# interface GigabitEthernet0/9	Specifies an interface type and number, and enters interface configuration mode.

	Command or Action	Purpose
Step 4	<p><b>service instance</b> <i>instance-id</i> <b>ethernet</b> <i>evc-name</i></p> <p><b>Example:</b> Router(config-if)# service instance 1 ethernet evc100</p>	<p>Creates a service instance on an interface and defines the matching criteria.</p> <ul style="list-style-type: none"> <li><i>instance-id</i>—Integer that uniquely identifies a service instance on an interface.</li> <li><i>evc-name</i>—String that associates an EVC to the service instance. Maximum byte size is 100.</li> </ul>
Step 5	<p><b>encapsulation default</b></p> <p><b>Example:</b> Router(config-if-srv)# encapsulation default</p>	<p>Configures the default service instance.</p>
Step 6	<p><b>bridge-domain</b> <i>bridge-id</i></p> <p><b>Example:</b> Router(config-if-srv)# bridge-domain 99</p>	<p>Binds the service instance to a bridge domain instance using an identifier.</p>
Step 7	<p><b>cfm encapsulation</b> {<b>dot1ad</b> <i>vlan-id</i>   <b>dot1q</b> <i>vlan-id</i>} [<b>dot1q</b> <i>vlan-id</i>   <b>second-dot1q</b> <i>vlan-id</i>]</p> <p><b>Example:</b> Router(config-if-srv)# cfm encapsulation dot1q 75</p>	<p>Configures connectivity fault management (CFM) Ethernet frame encapsulation.</p> <ul style="list-style-type: none"> <li><b>dot1ad</b>—Indicates the 802.1ad provider bridges encapsulation type.</li> <li><b>dot1q</b>—Supports the IEEE 802.1q standard for encapsulation of traffic and specifies the outer dot1q encapsulation tag.</li> <li><b>second-dot1q</b>—Specifies the inner dot1q encapsulation tag. Valid option only when you first select the outer <b>dot1q</b> encapsulation tag. When the dot1ad encapsulation type is selected first, <b>dot1q</b> is a valid option.</li> <li><i>vlan-id</i>—Integer from 1 to 4094 that specifies the VLAN on which to send CFM frames.</li> </ul>
Step 8	<p><b>cfm mep domain</b> <i>domain-id</i> <b>mpid</b> <i>mpid-value</i></p> <p><b>Example:</b> Router(config-if-srv)# cfm mep domain md2 mpid 111</p>	<p>Configures a maintenance endpoint (MEP) for a domain.</p> <ul style="list-style-type: none"> <li><i>domain-name</i>—String from 1 to 154 characters that identifies the domain name.</li> <li><b>mpid</b>—Indicates the maintenance point ID (MPID).</li> <li><i>mpid-value</i>—Integer from 1 to 8191 that identifies the MPID.</li> </ul>

## Verifying CFM with EVC Default Encapsulation

To verify the configuration of CFM with EVC default encapsulation, use the **show** command shown below.

```
Router# show running-config interface gigabitEthernet 0/9
Building configuration...
```

```

Current configuration : 210 bytes
!
interface GigabitEthernet0/9
no ip address
negotiation auto
service instance 1 ethernet evc100
  encapsulation default
  bridge-domain 99
  cfm mep domain md2 mpid 111
  cfm encapsulation dot1q 75
!
end

```

### Example: Configuring CFM with EVC Default Encapsulation

```

!
interface GigabitEthernet0/9
service instance 1 ethernet evc100
  encapsulation default
  bridge-domain 99
  cfm encapsulation dot1q 75
  cfm mep domain md2 mpid 111
!

```

## Configuring Y.1731 Fault Management

The ITU-T Y.1731 feature provides new CFM functionality for fault and performance management for service providers in large network. The router supports Ethernet Alarm Indication Signal (ETH-AIS) and Ethernet Remote Defect Indication (ETH-RDI) functionality for fault detection, verification, and isolation.

For more information on Y.1731 Fault Management, see [http://www.cisco.com/en/US/docs/ios/cether/configuration/guide/ce\\_cfm-ieee\\_y1731.html](http://www.cisco.com/en/US/docs/ios/cether/configuration/guide/ce_cfm-ieee_y1731.html)

To configure Y.1731 fault management, you must enable CFM and configure MIPs on the participating interfaces. AIS messages are generated only on interfaces with a configured MIP.

This section contains the following topics:

- [Default Y.1731 Configuration, page 10-26](#)
- [Configuring ETH-AIS, page 10-27](#)
- [Configuring ETH-LCK, page 10-28](#)

### Default Y.1731 Configuration

- ETH-AIS is enabled by default when CFM is enabled.
- When you configure ETH-AIS, you must configure CFM before ETH-AIS is operational.
- ETH-RDI is set automatically when continuity check messages are enabled.

## Configuring ETH-AIS

Complete the following steps to configure ETH- AIS on the router:

	Command	Purpose
Step 1	<b>configure terminal</b>	Enter global configuration mode.
Step 2	<b>ethernet cfm ais link-status global</b>	Configure AIS-specific SMEP commands by entering config-ais-link-cfm mode.
Step 3	<b>level</b> <i>level-id</i>  or <b>disable</b>	Configure the maintenance level for sending AIS frames transmitted by the SMEP. The range is 0 to 7.  or Disable generation of ETH-AIS frames.
Step 4	<b>period</b> <i>value</i>	Configure the SMEP AIS transmission period interval. Allowable values are 1 second or 60 seconds.
Step 5	<b>exit</b>	Return to global configuration mode.
Step 6	<b>ethernet cfm domain</b> <i>domain-name</i> <b>level</b> <i>level-id</i>	Define a CFM domain, set the domain level, and enter ethernet-cfm configuration mode for the domain. The maintenance level number range is 0 to 7.
Step 7	<b>service</b> { <i>short-ma-name</i>   <b>number</b> <i>MA-number</i>   <b>vlan-id</b> <i>primary-vlan-id</i>   <b>vpn-id</b> <i>vpn-id</i> } { <b>vlan</b> <i>vlan-id</i>   <b>port</b>   <b>evc</b> <i>evc-name</i> }	Configure the maintenance association and set a universally unique ID for a customer service instance (CSI) or the maintenance association number value, primary VLAN ID and VPN ID within a maintenance domain in Ethernet connectivity fault management (CFM) configuration mode.
Step 8	<b>ais level</b> <i>level-id</i>	(Optional) Configure the maintenance level for sending AIS frames transmitted by the MEP. The range is 0 to 7.
Step 9	<b>ais period</b> <i>value</i>	(Optional) Configure the MEP AIS transmission period interval. Allowable values are 1 second or 60 seconds.
Step 10	<b>ais expiry-threshold</b> <i>value</i>	(Optional) Set the expiring threshold for the MA as an integer. The range is 2 to 255. The default is 3.5.
Step 11	<b>no ais suppress-alarms</b>	(Optional) Override the suppression of redundant alarms when the MEP goes into an AIS defect condition after receiving an AIS message.
Step 12	<b>exit</b>	Return to ethernet-cfm configuration mode.
Step 13	<b>exit</b>	Return to global configuration mode.
Step 14	<b>interface</b> <i>interface-id</i>	Specify an interface ID, and enter interface configuration mode.
Step 15	[no] <b>ethernet cfm ais link-status</b>	Enable or disable sending AIS frames from the SMEP on the interface.
Step 16	<b>ethernet cfm ais link-status period</b> <i>value</i>	Configure the ETH-AIS transmission period generated by the SMEP on the interface. Allowable values are 1 second or 60 seconds.
Step 17	<b>ethernet cfm ais link-status level</b> <i>level-id</i>	Configure the maintenance level for sending AIS frames transmitted by the SMEP on the interface. The range is 0 to 7.

	Command	Purpose
Step 18	<b>end</b>	Return to privileged EXEC mode.
Step 19	<b>show ethernet cfm smep</b> [interface <i>interface-id</i> ]	Verify the configuration.
Step 20	<b>show ethernet cfm error</b>	Display received ETH-AIS frames and other errors.
Step 21	<b>copy running-config startup-config</b>	(Optional) Save your entries in the configuration file.

Use the **no** form of this commands to return to the default configuration or to remove a configuration. To disable the generation of ETH-AIS frames, enter the **disable** config-ais-link-cfm mode command.

This is an example of the output from the **show ethernet cfm smep** command when Ethernet AIS has been enabled:

```
Router# show ethernet cfm smep
SMEP Settings:
-----
Interface: GigabitEthernet1/0/3
LCK-Status: Enabled
LCK Period: 60000 (ms)
Level to transmit LCK: Default
AIS-Status: Enabled
AIS Period: 60000 (ms)
Level to transmit AIS: Default
Defect Condition: AIS
```

## Configuring ETH-LCK

Complete the following steps to configure ethernet locked signal on a switch:

	Command	Purpose
Step 1	<b>configure terminal</b>	Enter global configuration mode.
Step 2	<b>ethernet cfm lck link-status global</b>	Execute SMEP LCK commands by entering config-lck-link-cfm mode.
Step 3	<b>level</b> <i>level-id</i>  or <b>disable</b>	Configure the maintenance level for sending ETH-LCK frames transmitted by the SMEP. The range is 0 to 7.  or Disable the generation of ETH-LCK frames.
Step 4	<b>period</b> <i>value</i>	Configure the SMEP ETH-LCK frame transmission period interval. Allowable values are 1 second or 60 seconds.
Step 5	<b>exit</b>	Return to global configuration mode.
Step 6	<b>ethernet cfm domain</b> <i>domain-name</i> <b>level</b> <i>level-id</i>	Define a CFM domain, set the domain level, and enter ethernet-cfm configuration mode for the domain. The maintenance level number range is 0 to 7.

	Command	Purpose
Step 7	<b>service</b> { <i>ma-name</i>   <i>ma-number</i>   <i>vpn-id</i> <i>vpn</i> } { <b>vlan</b> <i>vlan-id</i> [ <b>direction down</b> ]   <b>port</b> }	<p>Define a customer service maintenance association name or number to be associated with the domain, or a VLAN ID or VPN-ID, and enter ethernet-cfm-service configuration mode.</p> <ul style="list-style-type: none"> <li>• <i>ma-name</i>—a string of no more than 100 characters that identifies the MAID.</li> <li>• <i>ma-number</i>—a value from 0 to 65535.</li> <li>• <i>vpn-id</i>—enter a VPN ID as the <i>ma-name</i>.</li> <li>• <b>vlan</b> <i>vlan-id</i>—VLAN range is from 1 to 4094. You cannot use the same VLAN ID for more than one domain at the same level.</li> <li>• (Optional) <b>direction down</b>—specify the service direction as down.</li> <li>• <b>port</b>—Configure port MEP, a down MEP that is untagged and not associated with a VLAN.</li> </ul>
Step 8	<b>lck level</b> <i>level-id</i>	(Optional) Configure the maintenance level for sending ETH-LCK frames sent by the MEP. The range is 0 to 7.
Step 9	<b>lck period</b> <i>value</i>	(Optional) Configure the MEP ETH-LCK frame transmission period interval. Allowable values are 1 second or 60 seconds.
Step 10	<b>lck expiry-threshold</b> <i>value</i>	(Optional) Set the expiring threshold for the MA. The range is 2 to 255. The default is 3.5.
Step 11	<b>exit</b>	Return to ethernet-cfm configuration mode.
Step 12	<b>exit</b>	Return to global configuration mode.
Step 13	<b>interface</b> <i>interface-id</i>	Specify an interface ID, and enter interface configuration mode.
Step 14	[ <b>no</b> ] <b>ethernet cfm lck link-status</b>	Enable or disable sending ETH-LCK frames from the SMEP on the interface.
Step 15	<b>ethernet cfm lck link-status period</b> <i>value</i>	Configure the ETH-LCK transmission period generated by the SMEP on the interface. Allowable values are 1 second or 60 seconds.
Step 16	<b>ethernet cfm lck link-status level</b> <i>level-id</i>	Configure the maintenance level for sending ETH-LCK frames sent by the SMEP on the interface. The range is 0 to 7.
Step 17	<b>end</b>	Return to privileged EXEC mode.

	Command	Purpose
Step 18	<b>ethernet cfm lck start interface</b> <i>interface-id</i> <b>direction</b> {up   down} [ <b>drop l2-bpdu</b> ]	(Optional) Apply the LCK condition to an interface. <ul style="list-style-type: none"> <li>• <b>interface</b> <i>interface-id</i>—Specify the interface to be put in LCK condition.</li> <li>• <b>direction inward</b>—The LCK is in the direction toward the relay; that is, within the switch.</li> <li>• <b>direction outward</b>—The LCK is in the direction of the wire.</li> <li>• (Optional) <b>drop l2-bpdu</b> specifies that all Layer 2 BPDUs except CFM frames, all data frames, and all Layer 3 control traffic are dropped for that MEP. If not entered, only data frames and Layer 3 control frames are dropped.</li> </ul>
Step 19	<b>show ethernet cfm smep</b> [ <b>interface</b> <i>interface-id</i> ]	Verify the configuration.
Step 20	<b>show ethernet cfm error</b>	Display received ETH-LCK frames.
Step 21	<b>copy running-config startup-config</b>	(Optional) Save your entries in the configuration file.

To remove the LCK condition from MEP, enter the **ethernet cfm lck stop mpid** *local-mpid* **domain** *domain-name* **vlan** *vlan-id* privileged EXEC command. To put an interface out of LCK condition, enter the **ethernet cfm lck start interface** *interface-id* **direction** {inward | outward} privileged EXEC command.

This is an example of the output from the **show ethernet cfm smep** command when ethernet LCK has been enabled:

```
Switch# show ethernet cfm smep
SMEP Settings:
-----
Interface: GigabitEthernet0/3
LCK-Status: Enabled
LCK Period: 60000 (ms)
Level to transmit LCK: Default
AIS-Status: Enabled
AIS Period: 60000 (ms)
Level to transmit AIS: Default
Defect Condition: AIS
```

## Managing and Displaying Ethernet CFM Information

Use the following commands in the privileged EXEC mode to clear Ethernet CFM information.

**Table 1** Clearing CFM Information

Command	Purpose
<b>clear ethernet cfm ais domain</b> <i>domain-name</i> <b>mpid</b> <i>id</i> { <b>vlan</b> <i>vlan-id</i>   <b>port</b> }	Clear MEPs with matching domain and VLAN ID out of AIS defect condition.
<b>clear ethernet cfm ais link-status interface</b> <i>interface-id</i>	Clear a SMEP out of AIS defect condition.
<b>clear ethernet cfm error</b>	Clear all CFM error conditions, including AIS.



Use the commands in [Table 10-2](#) in the privileged EXEC mode to display Ethernet CFM information.

**Table 10-2**      **Displaying CFM Information**

Command	Purpose
<code>show ethernet cfm domain [brief]</code>	Displays CFM domain information or brief domain information.
<code>show ethernet cfm errors [configuration   domain-id]</code>	Displays CFM continuity check error conditions logged on a device since it was last reset or the log was last cleared. When CFM crosscheck is enabled, displays the results of the CFM crosscheck operation.
<code>show ethernet cfm maintenance-points local [detail   domain   interface   level   mep   mip]</code>	Displays maintenance points configured on a device.
<code>show ethernet cfm maintenance-points remote [crosscheck   detail   domain   static]</code>	Displays information about a remote maintenance point domains or levels or details in the CFM database.
<code>show ethernet cfm mpdb</code>	Displays information about entries in the MIP continuity-check database.
<code>show ethernet cfm smep [interface interface-id]</code>	Displays Ethernet CFM SMEP information.
<code>show ethernet cfm traceroute-cache</code>	Displays the contents of the traceroute cache.
<code>show platform cfm</code>	Displays platform-independent CFM information.

This is an example of output from the `show ethernet cfm domain brief` command:

```
Router# show ethernet cfm domain brief
Domain Name                Index  Level  Services  Archive (min)
level5                     1      5      1         100
level3                     2      3      1         100
test                       3      3      3         100
name                       4      3      1         100
test1                      5      2      1         100
lck                        6      1      1         100Total Services : 1
```

This is an example of output from the `show ethernet cfm errors` command:

```
Router# show ethernet cfm errors
-----
MPID Domain Id                Mac Address      Type  Id  Lvl
      MAName                  Reason           Age
-----
6307 level3                   0021.d7ee.fe80  Vlan  7   3
      vlan7                   Receive RDI     5s
```

This is an example of output from the `show ethernet cfm maintenance-points local detail` command:

```
Router# show ethernet cfm maintenance-points local detail
Local MEPS:
-----
MPID: 7307
DomainName: level3
Level: 3
Direction: Up
Vlan: 7
Interface: Gi0/3
CC-Status: Enabled
CC Loss Threshold: 3
MAC: 0021.d7ef.0700
LCK-Status: Enabled
LCK Period: 60000 (ms)
```

```

LCK Expiry Threshold: 3.5
Level to transmit LCK: Default
Defect Condition: No Defect
presentRDI: FALSE
AIS-Status: Enabled
AIS Period: 60000(ms)
AIS Expiry Threshold: 3.5
Level to transmit AIS: Default
Suppress Alarm configuration: Enabled
Suppressing Alarms: No

```

```
MIP Settings:
```

```
-----
```

```
Local MIPs:
```

```
* = MIP Manually Configured
```

```
-----
```

Level	Port	MacAddress	SrvcInst	Type	Id
*5	Gi0/3	0021.d7ef.0700	N/A	Vlan	2,7

```
-----
```

This is an example of output from the **show ethernet cfm traceroute** command:

```

Router# show ethernet cfm traceroute
Current Cache-size: 0 Hops
Max Cache-size: 100 Hops
Hold-time: 100 Minutes

```

Use the commands in [Table 10-3](#) in the privileged EXEC mode to display IP SLA ethernet CFM information.

**Table 10-3** *Displaying IP SLA CFM Information*

Command	Purpose
<b>show ip sla configuration</b> [ <i>entry-number</i> ]	Displays configuration values including all defaults for all IP SLA operations or a specific operation.
<b>show ip sla ethernet-monitor configuration</b> [ <i>entry-number</i> ]	Displays the configuration of the IP SLA automatic ethernet operation.
<b>show ip sla statistics</b> [ <i>entry-number</i>   <b>aggregated</b>   <b>details</b> ]	Display current or aggregated operational status and statistics.

## Understanding the Ethernet OAM Protocol

The Ethernet OAM protocol for installing, monitoring, and troubleshooting Metro Ethernet networks and Ethernet WANs relies on an optional sublayer in the data link layer of the OSI model. Normal link operation does not require Ethernet OAM. You can implement Ethernet OAM on any full-duplex point-to-point or emulated point-to-point Ethernet link for a network or part of a network (specified interfaces).

OAM frames, called OAM protocol data units (OAM PDUs) use the slow protocol destination MAC address 0180.c200.0002. They are intercepted by the MAC sublayer and cannot propagate beyond a single hop within an Ethernet network. Ethernet OAM is a relatively slow protocol, with a maximum transmission rate of 10 frames per second, resulting in minor impact to normal operations. However, when you enable link monitoring, because the CPU must poll error counters frequently, the number of required CPU cycles is proportional to the number of interfaces that must be polled.

Ethernet OAM has two major components:

- The OAM client establishes and manages Ethernet OAM on a link and enables and configures the OAM sublayer. During the OAM discovery phase, the OAM client monitors OAM PDUs received from the remote peer and enables OAM functionality. After the discovery phase, it manages the rules of response to OAM PDUs and the OAM remote loopback mode.
- The OAM sublayer presents two standard IEEE 802.3 MAC service interfaces facing the superior and inferior MAC sublayers. It provides a dedicated interface for the OAM client to pass OAM control information and PDUs to and from the client. It includes these components:
  - The control block provides the interface between the OAM client and other OAM sublayer internal blocks.
  - The multiplexer manages frames from the MAC client, the control block, and the parser and passes OAM PDUs from the control block and loopback frames from the parser to the subordinate layer.
  - The parser classifies frames as OAM PDUs, MAC client frames, or loopback frames and sends them to the appropriate entity: OAM PDUs to the control block, MAC client frames to the superior sublayer, and loopback frames to the multiplexer.

### Benefits of Ethernet OAM

Ethernet OAM provides the following benefits:

- Competitive advantage for service providers
- Standardized mechanism to monitor the health of a link and perform diagnostics

## OAM Features

The following OAM features are defined by IEEE 802.3ah:

- [Discovery](#)
- [Link Monitoring](#)
- [Remote Failure Indication](#)
- [Remote Loopback](#)

### Discovery

Discovery is the first phase of Ethernet OAM and it identifies the devices in the network and their OAM capabilities. Discovery uses information OAM PDUs. During the discovery phase, the following information is advertised within periodic information OAM PDUs:

- OAM mode—Conveyed to the remote OAM entity. The mode can be either active or passive and can be used to determine device functionality.
- OAM configuration (capabilities)—Advertises the capabilities of the local OAM entity. With this information a peer can determine what functions are supported and accessible; for example, loopback capability.
- OAM PDU configuration—Includes the maximum OAM PDU size for receipt and delivery. This information along with the rate limiting of 10 frames per second can be used to limit the bandwidth allocated to OAM traffic.
- Platform identity—A combination of an organization unique identifier (OUI) and 32-bits of vendor-specific information. OUI allocation, controlled by the IEEE, is typically the first three bytes of a MAC address.

Discovery includes an optional phase in which the local station can accept or reject the configuration of the peer OAM entity. For example, a node may require that its partner support loopback capability to be accepted into the management network. These policy decisions may be implemented as vendor-specific extensions.

## Link Monitoring

Link monitoring in Ethernet OAM detects and indicates link faults under a variety of conditions. Link monitoring uses the event notification OAM PDU and sends events to the remote OAM entity when there are problems detected on the link. The error events include the following:

- **Error Symbol Period (error symbols per second)**—The number of symbol errors that occurred during a specified period exceeded a threshold. These errors are coding symbol errors.
- **Error Frame (error frames per second)**—The number of frame errors detected during a specified period exceeded a threshold.
- **Error Frame Period (error frames per n frames)**—The number of frame errors within the last n frames has exceeded a threshold.
- **Error Frame Seconds Summary (error seconds per m seconds)**—The number of error seconds (1-second intervals with at least one frame error) within the last m seconds has exceeded a threshold.

Since IEEE 802.3ah OAM does not provide a guaranteed delivery of any OAM PDU, the event notification OAM PDU may be sent multiple times to reduce the probability of a lost notification. A sequence number is used to recognize duplicate events.

## Remote Failure Indication

Faults in Ethernet connectivity that are caused by slowly deteriorating quality are difficult to detect. Ethernet OAM provides a mechanism for an OAM entity to convey these failure conditions to its peer via specific flags in the OAM PDU. The following failure conditions can be communicated:

- **Link Fault**—Loss of signal is detected by the receiver; for instance, the peer's laser is malfunctioning. A link fault is sent once per second in the information OAM PDU. Link fault applies only when the physical sublayer is capable of independently transmitting and receiving signals.
- **Dying Gasp**—This notification is sent for power failure, link down, router reload and link administratively down conditions. This type of condition is vendor specific. A notification about the condition may be sent immediately and continuously.
- **Critical Event**—An unspecified critical event occurs. This type of event is vendor specific. A critical event may be sent immediately and continuously.

## Remote Loopback

An OAM entity can put its remote peer into loopback mode using the loopback control OAM PDU. Loopback mode helps an administrator ensure the quality of links during installation or when troubleshooting. In loopback mode, every frame received is transmitted back on the same port except for OAM PDUs and pause frames. The periodic exchange of OAM PDUs must continue during the loopback state to maintain the OAM session.

The loopback command is acknowledged by responding with an information OAM PDU with the loopback state indicated in the state field. This acknowledgement allows an administrator, for example, to estimate if a network segment can satisfy a service-level agreement. Acknowledgement makes it possible to test delay, jitter, and throughput.

When an interface is set to the remote loopback mode the interface no longer participates in any other Layer 2 or Layer 3 protocols; for example Spanning Tree Protocol (STP) or Open Shortest Path First (OSPF). The reason is that when two connected ports are in a loopback session, no frames other than the OAM PDUs are sent to the CPU for software processing. The non-OAM PDU frames are either looped back at the MAC level or discarded at the MAC level.

From a user's perspective, an interface in loopback mode is in a link-up state.

### Cisco Vendor-Specific Extensions

Ethernet OAM allows vendors to extend the protocol by allowing them to create their own type-length-value (TLV) fields.

### OAM Messages

Ethernet OAM messages or OAM PDUs are standard length, untagged Ethernet frames within the normal frame length bounds of 64 to 1518 bytes. The maximum OAM PDU frame size exchanged between two peers is negotiated during the discovery phase.

OAM PDUs always have the destination address of slow protocols (0180.c200.0002) and an Ethertype of 8809. OAM PDUs do not go beyond a single hop and have a hard-set maximum transmission rate of 10 OAM PDUs per second. Some OAM PDU types may be transmitted multiple times to increase the likelihood that they will be successfully received on a deteriorating link.

Four types of OAM messages are supported:

- Information OAM PDU—A variable-length OAM PDU that is used for discovery. This OAM PDU includes local, remote, and organization-specific information.
- Event notification OAM PDU—A variable-length OAM PDU that is used for link monitoring. This type of OAM PDU may be transmitted multiple times to increase the chance of a successful receipt; for example, in the case of high-bit errors. Event notification OAM PDUs also may include a time stamp when generated.
- Loopback control OAM PDU—An OAM PDU fixed at 64 bytes in length that is used to enable or disable the remote loopback command.
- Vendor-specific OAM PDU—A variable-length OAM PDU that allows the addition of vendor-specific extensions to OAM.

For instructions on how to configure Ethernet Link OAM, see [Setting Up and Configuring Ethernet OAM, page 10-35](#).

## Setting Up and Configuring Ethernet OAM

This section includes the following topics:

- [Default Ethernet OAM Configuration, page 10-36](#)
- [Restrictions and Guidelines, page 10-36](#)
- [Enabling Ethernet OAM on an Interface, page 10-36](#)
- [Enabling Ethernet OAM Remote Loopback, page 10-38](#)
- [Configuring Ethernet OAM Link Monitoring, page 10-38](#)
- [Configuring Ethernet OAM Remote Failure Indications, page 10-41](#)
- [Configuring Ethernet OAM Templates, page 10-42](#)

- [Displaying Ethernet OAM Protocol Information, page 10-45](#)
- [Verifying Ethernet OAM Configuration, page 10-46](#)

## Default Ethernet OAM Configuration

- Ethernet OAM is disabled on all interfaces.
- When Ethernet OAM is enabled on an interface, link monitoring is automatically turned on.
- Remote loopback is disabled.
- No Ethernet OAM templates are configured.

## Restrictions and Guidelines

Follow these guidelines when configuring Ethernet OAM:

- The router does not support monitoring of egress frames sent with cyclic redundancy code (CRC) errors. The **ethernet oam link-monitor transmit crc** interface-configuration or template-configuration commands are visible but are not supported on the router. The commands are accepted, but are not applied to an interface.
- For a remote failure indication, the router does not generate link fault or Critical Event OAM PDUs. However, if these PDUs are received from a link partner, they are processed. The router supports generating and receiving Dying Gasp OAM PDUs when Ethernet OAM is disabled, the interface is shut down, the interface enters the error-disabled state, the router is reloading, or during power failure.
- Effective with Cisco IOS Release 15.3(2)S, the Cisco ASR 901 router supports sub-second OAM timers.
- The Cisco ASR 901 router supports up to two Ethernet OAM sessions with sub-second OAM timers.
- Ethernet OAM sessions with sub-second OAM timers reduce the scalability for Ethernet CFM sessions.

## Enabling Ethernet OAM on an Interface

Complete the following steps to enable Ethernet OAM on an interface:

	Command	Purpose
Step 1	<b>configure terminal</b>	Enters global configuration mode.
Step 2	<b>interface</b> <i>interface-id</i>	Defines an interface to configure as an Ethernet OAM interface, and enters interface configuration mode.
Step 3	<b>ethernet oam</b>	Enables Ethernet OAM on the interface.

	Command	Purpose
Step 4	<b>ethernet oam</b> [ <b>max-rate</b> <i>oampdus</i>   <b>min-rate</b> <i>seconds</i> [ <i>ms</i> ]   <b>mode</b> { <b>active</b>   <b>passive</b> }   <b>timeout</b> <i>seconds</i> [ <i>ms</i> ] ]	<p>Configures the OAM parameters:</p> <ul style="list-style-type: none"> <li>• <b>max-rate</b>—(Optional) Configures the maximum number of OAM PDUs sent per second.</li> <li>• <i>oampdus</i>—The range is from 1 to 10.</li> <li>• <b>min-rate</b>—(Optional) Configures the minimum transmission rate when one OAM PDU is sent per second.</li> <li>• <i>seconds</i>—The range is as follows: <ul style="list-style-type: none"> <li>– 1 to 10 seconds</li> <li>– 100 to 900 milliseconds (multiples of 100)</li> </ul> </li> <li>• <b>ms</b>—Specifies the minimum transmission rate value in milliseconds.</li> <li>• <b>mode active</b>—(Optional) Sets OAM client mode to active.</li> <li>• <b>mode passive</b>—(Optional) Sets OAM client mode to passive.</li> </ul> <p><b>Note</b> When Ethernet OAM mode is enabled on two interfaces passing traffic, at least one must be in the active mode.</p> <ul style="list-style-type: none"> <li>• <b>timeout</b>—(Optional) Sets a time for OAM client timeout.</li> <li>• <i>seconds</i>—The range is as follows: <ul style="list-style-type: none"> <li>– 2 to 30 seconds</li> <li>– 500 to 1900 milliseconds (multiples of 100)</li> </ul> </li> <li>• <b>ms</b>—Specifies the timeout value in milliseconds.</li> </ul>
Step 5	<b>end</b>	Returns to privileged EXEC mode.
Step 6	<b>show ethernet oam status</b> [ <b>interface</b> <i>interface-id</i> ]	Verifies the configuration.
Step 7	<b>copy running-config startup-config</b>	(Optional) Saves your entries in the configuration file.

Use the **no ethernet oam** interface configuration command to disable Ethernet OAM on the interface.

### Configuration Example

The following example shows how to configure an Ethernet OAM session with sub-second OAM timers on an interface:

```
Router> enable
Router# configure terminal
Router(config)# interface gigabitethernet 0/1
Router(config-if)# ethernet oam
Router(config-if)# ethernet oam min-rate 100 ms
Router(config-if)# ethernet oam timeout 500 ms
Router(config-if)# end
```

## Enabling Ethernet OAM Remote Loopback

Enable Ethernet OAM remote loopback on an interface for the local OAM client to initiate OAM remote loopback operations. Changing this setting causes the local OAM client to exchange configuration information with its remote peer. Remote loopback is disabled by default.

### Restrictions

- Internet Group Management Protocol (IGMP) packets are not looped back.
- If dynamic ARP inspection is enabled, ARP or reverse ARP packets are not looped or dropped.

Complete the following steps to enable Ethernet OAM remote loopback on an interface:

	Command	Purpose
Step 1	<b>configure terminal</b>	Enter global configuration mode.
Step 2	<b>interface</b> <i>interface-id</i>	Define an interface to configure as an EOM interface, and enter interface configuration mode.
Step 3	<b>ethernet oam remote-loopback</b> { <b>supported</b>   <b>timeout</b> <i>seconds</i> }	Enable Ethernet remote loopback on the interface or set a loopback timeout period. <ul style="list-style-type: none"> <li>• Enter <b>supported</b> to enable remote loopback.</li> <li>• Enter <b>timeout</b> <i>seconds</i> to set a remote loopback timeout period. The range is from 1 to 10 seconds.</li> </ul>
Step 4	<b>end</b>	Return to privileged EXEC mode.
Step 5	<b>ethernet oam remote-loopback</b> { <b>start</b>   <b>stop</b> } { <b>interface</b> <i>interface-id</i> }	Turn on or turn off Ethernet OAM remote loopback on an interface.
Step 6	<b>show ethernet oam status</b> [ <b>interface</b> <i>interface-id</i> ]	Verify the configuration.
Step 7	<b>copy running-config startup-config</b>	(Optional) Save your entries in the configuration file.

Use the **no ethernet oam remote-loopback** { **supported** | **timeout** } interface configuration command to disable remote loopback support or remove the timeout setting.

## Configuring Ethernet OAM Link Monitoring

You can configure high and low thresholds for link-monitoring features. If no high threshold is configured, the default is **none**—no high threshold is set. If you do not set a low threshold, it defaults to a value lower than the high threshold.

Complete the following steps to configure Ethernet OAM link monitoring on an interface:

	Command	Purpose
Step 1	<b>configure terminal</b>	Enter global configuration mode.
Step 2	<b>interface</b> <i>interface-id</i>	Define an interface, and enter interface configuration mode.



	Command	Purpose
Step 3	<b>ethernet oam link-monitor supported</b>	<p>Enable the interface to support link monitoring. This is the default.</p> <p>You need to enter this command only if it has been disabled by previously entering the <b>no ethernet oam link-monitor supported</b> command.</p>
Step 4	<b>ethernet oam link-monitor high-threshold action {error-disable-interface   failover}</b>	<p>Use the <b>ethernet oam link-monitor high-threshold</b> command to configure an error-disable function on the Ethernet OAM interface when a high threshold for an error is exceeded.</p> <p><b>Note</b> Release 15.0(1)MR does not support the <b>failover</b> keyword.</p>
Step 5	<b>ethernet oam link-monitor symbol-period</b> <b>{threshold {high {high symbols   none}   low {low-symbols}}   window symbols}</b>  <b>Note</b> Repeat this step to configure both high and low thresholds.	<p>(Optional) Configure high and low thresholds for an error-symbol period that trigger an error-symbol period link event.</p> <ul style="list-style-type: none"> <li>• Enter <b>threshold high high-symbols</b> to set a high threshold in number of symbols. The range is 1 to 65535. The default is <b>none</b>.</li> <li>• Enter <b>threshold high none</b> to disable the high threshold if it was set. This is the default.</li> <li>• Enter <b>threshold low low-symbols</b> to set a low threshold in number of symbols. The range is 0 to 65535. It must be lower than the high threshold.</li> <li>• Enter <b>window symbols</b> to set the window size (in number of symbols) of the polling period. The range is 1 to 65535 symbols.</li> </ul>
Step 6	<b>ethernet oam link-monitor frame {threshold {high {high-frames   none}   low {low-frames}}   window milliseconds}</b>  <b>Note</b> Repeat this step to configure both high and low thresholds.	<p>(Optional) Configure high and low thresholds for error frames that trigger an error-frame link event.</p> <ul style="list-style-type: none"> <li>• Enter <b>threshold high high-frames</b> to set a high threshold in number of frames. The range is 1 to 65535. The default is <b>none</b>.</li> <li>• Enter <b>threshold high none</b> to disable the high threshold if it was set. This is the default.</li> <li>• Enter <b>threshold low low-frames</b> to set a low threshold in number of frames. The range is 0 to 65535. The default is 1.</li> <li>• Enter <b>window milliseconds</b> to set the a window and period of time during which error frames are counted. The range is 10 to 600 and represents the number of milliseconds in multiples of 100. The default is 100.</li> </ul>

Command	Purpose
<p><b>Step 7</b></p> <p><b>ethernet oam link-monitor frame-period</b>  <b>{threshold {high {high-frames   none}   low {low-frames}}   window frames}</b></p> <p><b>Note</b> Repeat this step to configure both high and low thresholds.</p>	<p>(Optional) Configure high and low thresholds for the error-frame period that triggers an error-frame-period link event.</p> <ul style="list-style-type: none"> <li>• Enter <b>threshold high</b> <i>high-frames</i> to set a high threshold in number of frames. The range is 1 to 65535. The default is <b>none</b>.</li> <li>• Enter <b>threshold high none</b> to disable the high threshold if it was set. This is the default.</li> <li>• Enter <b>threshold low</b> <i>low-frames</i> to set a low threshold in number of frames. The range is 0 to 65535. The default is 1.</li> <li>• Enter <b>window frames</b> to set the a polling window size in number of frames. The range is 1 to 65535; each value is a multiple of 10000 frames. The default is 1000.</li> </ul>
<p><b>Step 8</b></p> <p><b>ethernet oam link-monitor frame-seconds</b>  <b>{threshold {high {high-frames   none}   low {low-frames}}   window milliseconds}</b></p> <p><b>Note</b> Repeat this step to configure both high and low thresholds.</p>	<p>(Optional) Configure high and low thresholds for the frame-seconds error that triggers an error-frame-seconds link event.</p> <ul style="list-style-type: none"> <li>• Enter <b>threshold high</b> <i>high-frames</i> to set a high error frame-seconds threshold in number of seconds. The range is 1 to 900. The default is none.</li> <li>• Enter <b>threshold high none</b> to disable the high threshold if it was set. This is the default.</li> <li>• Enter <b>threshold low</b> <i>low-frames</i> to set a low threshold in number of frames. The range is 1 to 900. The default is 1.</li> <li>• Enter <b>window frames</b> to set the a polling window size in number of milliseconds. The range is 100 to 9000; each value is a multiple of 100 milliseconds. The default is 1000.</li> </ul>

	Command	Purpose
Step 9	<b>ethernet oam link-monitor receive-crc</b> { <b>threshold</b> { <b>high</b> { <i>high-frames</i>   <b>none</b> }   <b>low</b> { <i>low-frames</i> } }   <b>window</b> <i>milliseconds</i> }	(Optional) Configure thresholds for monitoring ingress frames received with cyclic redundancy code (CRC) errors for a period of time. <ul style="list-style-type: none"> <li>Enter <b>threshold high</b> <i>high-frames</i> to set a high threshold for the number of frames received with CRC errors. The range is 1 to 65535 frames.</li> <li>Enter <b>threshold high none</b> to disable the high threshold.</li> <li>Enter <b>threshold low</b> <i>low-frames</i> to set a low threshold in number of frames. The range is 0 to 65535. The default is 1.</li> <li>Enter <b>window</b> <i>milliseconds</i> to set the a window and period of time during which frames with CRC errors are counted. The range is 10 to 1800 and represents the number of milliseconds in multiples of 100. The default is 100.</li> </ul>
	<b>Note</b> Repeat this step to configure both high and low thresholds.	
Step 10	<b>ethernet oam link-monitor transmit-crc</b> { <b>threshold</b> { <b>high</b> { <i>high-frames</i>   <b>none</b> }   <b>low</b> <i>low-frames</i> }   <b>window</b> <i>milliseconds</i> } }	Use the <b>ethernet oam link-monitor transmit-crc</b> command to configure an Ethernet OAM interface to monitor egress frames with CRC errors for a period of time.
Step 11	[no] <b>ethernet link-monitor on</b>	(Optional) Start or stop (when the <b>no</b> keyword is entered) link-monitoring operations on the interface. Link monitoring operations start automatically when support is enabled.
Step 12	<b>end</b>	Return to privileged EXEC mode.
Step 13	<b>show ethernet oam status</b> [ <b>interface</b> <i>interface-id</i> ]	Verify the configuration.
Step 14	<b>copy running-config startup-config</b>	(Optional) Save your entries in the configuration file.

The **ethernet oam link-monitor transmit-crc** { **threshold** { **high** { *high-frames* | **none** } | **low** { *low-frames* } } | **window** *milliseconds* } command is visible on the router and you are allowed to enter it, but it is not supported. Use the **no** form of this commands to disable the configuration. Use the **no** form of each command to disable the threshold setting.

## Configuring Ethernet OAM Remote Failure Indications

You can configure an error-disable action to occur on an interface if one of the high thresholds is exceeded, if the remote link goes down, if the remote device is rebooted, if the remote device disables Ethernet OAM on the interface, or if the power failure occurs on the remote device .

Complete the following steps to enable Ethernet OAM remote-failure indication actions on an interface:

	Command	Purpose
Step 1	<b>configure terminal</b>	Enter global configuration mode.
Step 2	<b>interface</b> <i>interface-id</i>	Define an interface, and enter interface configuration mode.

	Command	Purpose
Step 3	<b>ethernet oam remote-failure {critical-event   dying-gasp   link-fault} action error-disable-interface</b>	Configure the Ethernet OAM remote-failure action on the interface. You can configure disabling the interface for one of these conditions: <ul style="list-style-type: none"> <li>• Select <b>critical-event</b> to shut down the interface when an unspecified critical event has occurred.</li> <li>• Select <b>dying-gasp</b> to shut down the interface when Ethernet OAM is disabled or the interface enters the error-disabled state.</li> <li>• Select <b>link-fault</b> to shut down the interface when the receiver detects a loss of signal.</li> </ul>
Step 4	<b>end</b>	Return to privileged EXEC mode.
Step 5	<b>show ethernet oam status [interface interface-id]</b>	Verify the configuration.
Step 6	<b>copy running-config startup-config</b>	(Optional) Save your entries in the configuration file.

The router does not generate Link Fault or Critical Event OAM PDUs. However, if these PDUs are received from a link partner, they are processed. The router supports sending and receiving Dying Gasp OAM PDUs when Ethernet OAM is disabled, the interface is shut down, the interface enters the error-disabled state, or the router is reloading. It can respond to and generate Dying Gasp PDUs based on loss of power. Use the **no ethernet remote-failure {critical-event | dying-gasp | link-fault} action** command to disable the remote failure indication action.

## Configuring Ethernet OAM Templates

You can create a template for configuring a common set of options on multiple Ethernet OAM interfaces. The template can be configured to monitor frame errors, frame-period errors, frame-second errors, received CRS errors, and symbol-period errors and thresholds. You can also set the template to put the interface in error-disabled state if any high thresholds are exceeded. These steps are optional and can be performed in any sequence or repeated to configure different options.

Complete the following steps to configure an Ethernet OAM template and to associate it with an interface:

	Command	Purpose
Step 1	<b>configure terminal</b>	Enter global configuration mode.
Step 2	<b>template <i>template-name</i></b>	Create a template, and enter template configuration mode.

	Command	Purpose
Step 3	<b>ethernet oam link-monitor receive-crc</b> { <b>threshold</b> { <b>high</b> { <i>high-frames</i>   <b>none</b> }   <b>low</b> { <i>low-frames</i> } }   <b>window</b> <i>milliseconds</i> }	<p>(Optional) Configure thresholds for monitoring ingress frames received with cyclic redundancy code (CRC) errors for a period of time.</p> <ul style="list-style-type: none"> <li>• Enter the <b>threshold high</b> <i>high-frames</i> command to set a high threshold for the number of frames received with CRC errors. The range is 1 to 65535 frames.</li> <li>• Enter the <b>threshold high none</b> command to disable the high threshold.</li> <li>• Enter the <b>threshold low</b> <i>low-frames</i> command to set a low threshold in number of frames. The range is 0 to 65535. The default is 1.</li> <li>• Enter the <b>window</b> <i>milliseconds</i> command to set the a window and period of time during which frames with CRC errors are counted. The range is 10 to 1800 and represents the number of milliseconds in multiples of 100. The default is 100.</li> </ul>
Step 4	<b>ethernet oam link-monitor symbol-period</b> { <b>threshold</b> { <b>high</b> { <i>high symbols</i>   <b>none</b> }   <b>low</b> { <i>low-symbols</i> } }   <b>window</b> <i>symbols</i> }	<p>(Optional) Configure high and low thresholds for an error-symbol period that triggers an error-symbol period link event.</p> <ul style="list-style-type: none"> <li>• Enter the <b>threshold high</b> <i>high-symbols</i> command to set a high threshold in number of symbols. The range is 1 to 65535.</li> <li>• Enter the <b>threshold high none</b> command to disable the high threshold.</li> <li>• Enter the <b>threshold low</b> <i>low-symbols</i> command to set a low threshold in number of symbols. The range is 0 to 65535. It must be lower than the high threshold.</li> <li>• Enter the <b>window</b> <i>symbols</i> command to set the window size (in number of symbols) of the polling period. The range is 1 to 65535 symbols.</li> </ul>
Step 5	<b>ethernet oam link-monitor frame</b> { <b>threshold</b> { <b>high</b> { <i>high-frames</i>   <b>none</b> }   <b>low</b> { <i>low-frames</i> } }   <b>window</b> <i>milliseconds</i> }	<p>(Optional) Configure high and low thresholds for error frames that trigger an error-frame link event.</p> <ul style="list-style-type: none"> <li>• Enter the <b>threshold high</b> <i>high-frames</i> command to set a high threshold in number of frames. The range is 1 to 65535. You must enter a high threshold.</li> <li>• Enter the <b>threshold high none</b> command to disable the high threshold.</li> <li>• Enter the <b>threshold low</b> <i>low-frames</i> command to set a low threshold in number of frames. The range is 0 to 65535. The default is 1.</li> <li>• Enter the <b>window</b> <i>milliseconds</i> command to set the a window and period of time during which error frames are counted. The range is 10 to 600 and represents the number of milliseconds in a multiple of 100. The default is 100.</li> </ul>

	Command	Purpose
Step 6	<b>ethernet oam link-monitor frame-period</b> { <b>threshold</b> { <b>high</b> { <i>high-frames</i>   <b>none</b> }   <b>low</b> { <i>low-frames</i> }}   <b>window frames</b> }	(Optional) Configure high and low thresholds for the error-frame period that triggers an error-frame-period link event. <ul style="list-style-type: none"> <li>Enter the <b>threshold high</b> <i>high-frames</i> command to set a high threshold in number of frames. The range is 1 to 65535. You must enter a high threshold.</li> <li>Enter the <b>threshold high none</b> command to disable the high threshold.</li> <li>Enter the <b>threshold low</b> <i>low-frames</i> command to set a low threshold in number of frames. The range is 0 to 65535. The default is 1.</li> <li>Enter the <b>window frames</b> command to set the a polling window size in number of frames. The range is 1 to 65535; each value is a multiple of 10000 frames. The default is 1000.</li> </ul>
Step 7	<b>ethernet oam link-monitor frame-seconds</b> { <b>threshold</b> { <b>high</b> { <i>high-seconds</i>   <b>none</b> }   <b>low</b> { <i>low-seconds</i> }}   <b>window milliseconds</b> }	(Optional) Configure frame-seconds high and low thresholds for triggering an error-frame-seconds link event. <ul style="list-style-type: none"> <li>Enter the <b>threshold high</b> <i>high-seconds</i> command to set a high threshold in number of seconds. The range is 1 to 900. You must enter a high threshold.</li> <li>Enter the <b>threshold high none</b> command to disable the high threshold.</li> <li>Enter the <b>threshold low</b> <i>low-frames</i> command to set a low threshold in number of frames. The range is 1 to 900. The default is 1.</li> <li>Enter the <b>window frames</b> command to set the a polling window size in number of frames. The range is 100 to 9000; each value is a multiple of 100 milliseconds. The default is 1000.</li> </ul>
Step 8	<b>ethernet oam link-monitor high threshold action error-disable-interface</b>	(Optional) Configure the router to move an interface to the error disabled state when a high threshold for an error is exceeded.
Step 9	<b>exit</b>	Return to global configuration mode.
Step 10	<b>interface</b> <i>interface-id</i>	Define an Ethernet OAM interface, and enter interface configuration mode.
Step 11	<b>source-template</b> <i>template-name</i>	Associate the template to apply the configured options to the interface.
Step 12	<b>end</b>	Return to privileged EXEC mode.
Step 13	<b>show ethernet oam status</b> [ <b>interface</b> <i>interface-id</i> ]	Verify the configuration.
Step 14	<b>copy running-config startup-config</b>	(Optional) Save your entries in the configuration file.

The router does not support monitoring egress frames with CRC errors. The **ethernet oam link-monitor transmit-crc {threshold {high {high-frames | none} | low {low-frames}} | window milliseconds}** command is visible on the router and you can enter it, but it is not supported. Use the **no** form of each command to remove the option from the template. Use the **no source-template template-name** to remove the source template association.

## Configuration Example

```
Router# configure terminal

Enter configuration commands, one per line.  End with CNTL/Z.

Router(config)# interface gigabitEthernet 0/8
Router(config-if)# ethernet oam
Router(config-if)# ethernet oam link-monitor symbol-period threshold high 299
Router(config-if)# ethernet oam link-monitor frame window 399
Router(config-if)# ethernet oam link-monitor frame-period threshold high 599
Router(config-if)# ethernet oam link-monitor frame-seconds window 699
Router(config-if)# ethernet oam link-monitor receive-crc window 99
Router(config-if)# ethernet oam link-monitor transmit-crc threshold low 199
Router(config-if)# ethernet oam link-monitor high-threshold action error-disable-interface
Router(config-if)# end

Router# show running-config interface gigabitEthernet 0/8
Building configuration...

Current configuration : 478 bytes
!
interface GigabitEthernet0/8
no ip address
negotiation auto
ethernet oam link-monitor symbol-period threshold high 299
ethernet oam link-monitor frame window 399
ethernet oam link-monitor frame-period threshold high 599
ethernet oam link-monitor frame-seconds window 699
ethernet oam link-monitor receive-crc window 99
ethernet oam link-monitor transmit-crc threshold low 199
ethernet oam link-monitor high-threshold action error-disable-interface
ethernet oam
end
```

## Displaying Ethernet OAM Protocol Information

Use these commands in the privileged EXEC to display the Ethernet OAM protocol information.

**Table 10-4** Displaying Ethernet OAM Protocol Information

Command	Purpose
<b>show ethernet oam discovery</b> [ <i>interface interface-id</i> ]	Displays discovery information for all Ethernet OAM interfaces or the specified interface.
<b>show ethernet oam statistics</b> [ <i>interface interface-id</i> ]	Displays detailed information about Ethernet OAM packets.
<b>show ethernet oam status</b> [ <i>interface interface-id</i> ]	Displays Ethernet OAM configuration for all interfaces or the specified interface.
<b>show ethernet oam summary</b>	Displays active Ethernet OAM sessions on the router.

## Verifying Ethernet OAM Configuration

### Verifying an OAM Session

To verify an OAM session, use the **show ethernet oam summary** command.

In the following example, the local client interface is in session with a remote client with MAC address 442b.0348.bc60 and organizationally unique identifier (OUI) 00000C, which is the OUI for Cisco Systems. The remote client is in active mode, and has established capabilities for link monitoring and remote loopback for the OAM session.

```
Router# show ethernet oam summary
Symbols:          * - Master Loopback State, # - Slave Loopback State
                  & - Error Block State
Capability codes: L - Link Monitor, R - Remote Loopback
                  U - Unidirection, V - Variable Retrieval

  Local          Remote
Interface      MAC Address  OUI    Mode    Capability

  Gi0/8         442b.0348.bc60 00000C active  L R
```

### Verifying OAM Discovery Status

To verify OAM Discovery status on the local client and remote peer, use the **show ethernet oam discovery** command as shown in the following example:

```
Router# show ethernet oam discovery interface gigabitethernet 0/8
GigabitEthernet0/8
Local client
-----
Administrative configurations:
  Mode:                active
  Unidirection:        not supported
  Link monitor:         supported (on)
  Remote loopback:     not supported
  MIB retrieval:        not supported
  Mtu size:             1500

Operational status:
  Port status:          operational
  Loopback status:     no loopback
  PDU revision:         0

Remote client
-----
MAC address: 442b.0348.bc60
Vendor(oui): 00000C(cisco)

Administrative configurations:
  PDU revision:         0
  Mode:                active
  Unidirection:        not supported
  Link monitor:         supported
  Remote loopback:     not supported
  MIB retrieval:        not supported
  Mtu size:             1500
```

### Verifying Information OAMPDU and Fault Statistics

To verify statistics for information OAMPDUs and local and remote faults, use the **show ethernet oam statistics** command as shown in the following example:



```

Router# show ethernet oam statistics interface gigabitethernet 0/8
GigabitEthernet0/8
Counters:
-----
Information OAMPDU Tx           : 5549
Information OAMPDU Rx           : 5914
Unique Event Notification OAMPDU Tx : 0
Unique Event Notification OAMPDU Rx : 0
Duplicate Event Notification OAMPDU TX : 0
Duplicate Event Notification OAMPDU RX : 0
Loopback Control OAMPDU Tx      : 0
Loopback Control OAMPDU Rx      : 0
Variable Request OAMPDU Tx      : 0
Variable Request OAMPDU Rx      : 0
Variable Response OAMPDU Tx     : 0
Variable Response OAMPDU Rx     : 0
Cisco OAMPDU Tx                 : 1
Cisco OAMPDU Rx                 : 0
Unsupported OAMPDU Tx           : 0
Unsupported OAMPDU Rx           : 0
Frames Lost due to OAM          : 0

Local Faults:
-----
0 Link Fault records
1 Dying Gasp records
  Total dying gasps           : 1
  Time stamp                   : 23:27:13

0 Critical Event records

Remote Faults:
-----
0 Link Fault records
0 Dying Gasp records
0 Critical Event records

Local event logs:
-----
0 Errored Symbol Period records
0 Errored Frame records
0 Errored Frame Period records
0 Errored Frame Second records

Remote event logs:
-----
0 Errored Symbol Period records
0 Errored Frame records
0 Errored Frame Period records
0 Errored Frame Second records

```

### Verifying Link Monitoring Configuration and Status

To verify link monitoring configuration and status on the local client, use the **show ethernet oam status** command. The Status field in the following example shows that link monitoring status is supported and enabled (on).

```

Router# show ethernet oam status interface gigabitethernet 0/8
GigabitEthernet0/8
General
-----
Admin state:           enabled
Mode:                  active

```

```

PDU max rate:          10 packets per second
PDU min rate:          1 packet per 1000 ms
Link timeout:          5000 ms
High threshold action: error disable interface
Link fault action:     no action
Dying gasp action:     no action
Critical event action: no action

```

#### Link Monitoring

```

-----
Status: supported (on)

Symbol Period Error
Window:              100 x 1048576 symbols
Low threshold:       1 error symbol(s)
High threshold:      299 error symbol(s)

Frame Error
Window:              400 x 100 milliseconds
Low threshold:       1 error frame(s)
High threshold:      none

Frame Period Error
Window:              1000 x 10000 frames
Low threshold:       1 error frame(s)
High threshold:      599 error frame(s)

Frame Seconds Error
Window:              700 x 100 milliseconds
Low threshold:       1 error second(s)
High threshold:      none

```

#### Verifying Status of the Remote OAM Client

To verify the status of a remote OAM client, use the **show ethernet oam summary** and **show ethernet oam status** commands.

To verify the remote client mode and capabilities for the OAM session, use the **show ethernet oam summary** command and observe the values in the Mode and Capability fields. The following example shows that the local client (local interface Gi0/8) is connected to the remote client

```

Router# show ethernet oam summary
Symbols:          * - Master Loopback State, # - Slave Loopback State
                  & - Error Block State
Capability codes: L - Link Monitor, R - Remote Loopback
                  U - Unidirection, V - Variable Retrieval

Local            Remote
Interface        MAC Address  OUI    Mode    Capability
-----
Gi0/8            442b.0348.bc60 00000C active  L R

```

## Understanding E-LMI

Ethernet Local Management Interface (E-LMI) is a protocol between the customer-edge (CE) device and the provider-edge (PE) device. It runs only on the PE-to-CE UNI link and notifies the CE device of connectivity status and configuration parameters of Ethernet services available on the CE port. E-LMI interoperates with an OAM protocol, such as CFM, that runs within the provider network to collect OAM status. CFM runs at the provider maintenance level (UPE to UPE with inward-facing MEPs at the UNI).

OAM manager, which streamlines interaction between any two OAM protocols, handles the interaction between CFM and E-LMI. This interaction is unidirectional, running only from OAM manager to E-LMI on the UPE side of the router. Information is exchanged either as a result of a request from E-LMI or triggered by OAM when it received notification of a change from the OAM protocol. This type of information is relayed:

- EVC name and availability status
- Remote UNI name and status
- Remote UNI counts

You can configure Ethernet virtual connections (EVCs), service VLANs, UNI ids (for each CE-to-PE link), and UNI count and attributes. You need to configure CFM to notify the OAM manager of any change to the number of active UNIs and or the remote UNI ID for a given S-VLAN domain.

You can configure the router as a provider-edge device.

## Restrictions

E-LMI is not supported for the service instances in which the pseudowire cross-connects are configured.

## Configuring E-LMI

For E-LMI to work with CFM, you configure EVCs, EFPs, and E-LMI customer VLAN mapping. Most of the configuration occurs on the PE device on the interfaces connected to the CE device. On the CE device, you only need to enable E-LMI on the connecting interface. Note that you must configure some OAM parameters, for example, EVC definitions, on PE devices on both sides of a metro network.

This section contains the following topics:

- [Default E-LMI Configuration, page 10-49](#)
- [Enabling E-LMI, page 10-50](#)
- [Displaying E-LMI Information, page 10-51](#)

## Default E-LMI Configuration

Ethernet LMI is globally disabled by default. When enabled, the router is in provider-edge (PE) mode by default.

When you globally enable E-LMI by entering the **ethernet lmi global** global configuration command, it is automatically enabled on all interfaces. You can also enable or disable E-LMI per interface to override the global configuration. The E-LMI command that is given last is the command that has precedence.

There are no EVCs, EFP service instances, or UNIs defined.

UNI bundling service is bundling with multiplexing.

## Enabling E-LMI

You can enable E-LMI globally or on an interface and you can configure the router as a PE device. Beginning in privileged EXEC mode, follow these steps to enable for E-LMI on the router or on an interface. Note that the order of the global and interface commands determines the configuration. The command that is entered last has precedence.

	Command	Purpose
Step 1	<code>configure terminal</code>	Enter global configuration mode.
Step 2	<code>ethernet lmi global</code>	Globally enable E-LMI on all interfaces. By default, the router is a PE device.
Step 3	<code>interface interface-id</code>	Define an interface to configure as an E-LMI interface, and enter interface configuration mode.
Step 4	<code>ethernet lmi interface</code>	Configure Ethernet LMI on the interface. If E-LMI is enabled globally, it is enabled on all interfaces unless you disable it on specific interfaces. If E-LMI is disabled globally, you can use this command to enable it on specified interfaces.
Step 5	<code>ethernet lmi {n391 value   n393 value   t391 value   t392 value}</code>	<p>Configure E-LMI parameters for the UNI.</p> <p>The keywords have these meanings:</p> <ul style="list-style-type: none"> <li>• <b>n391 value</b>—Set the event counter on the customer equipment. The counter polls the status of the UNI and all Ethernet virtual connections (EVCs). The range is from 1 to 65000; the default is 360.</li> <li>• <b>n393 value</b>—Set the event counter for the metro Ethernet network. The range is from 1 to 10; the default is 4.</li> <li>• <b>t391 value</b>—Set the polling timer on the customer equipment. A polling timer sends status enquiries and when status messages are not received, records errors. The range is from 5 to 30 seconds; the default is 10 seconds.</li> <li>• <b>t392 value</b>—Set the polling verification timer for the metro Ethernet network or the timer to verify received status inquiries. The range is from 5 to 30 seconds, or enter 0 to disable the timer. The default is 15 seconds.</li> </ul> <p><b>Note</b> The <b>t392</b> keyword is not supported when the router is in CE mode.</p>
Step 6	<code>end</code>	Return to privileged EXEC mode.
Step 7	<code>show ethernet lmi evc</code>	Verify the configuration.
Step 8	<code>copy running-config startup-config</code>	(Optional) Save your entries in the configuration file.

Use the **no ethernet lmi** global configuration command to globally disable E-LMI. Use the **no** form of the **ethernet lmi** interface configuration command with keywords to disable E-LMI on the interface or to return the timers to the default settings.

Use the **show ethernet lmi** commands to display information that was sent to the CE from the status request poll. Use the **show ethernet service** commands to show current status on the device.

## Displaying E-LMI Information

Use the following commands in privileged EXEC mode to display E-LMI information.

**Table 10-5**      *Displaying E-LMI Information*

Command	Purpose
<b>show ethernet lmi evc</b> [ <b>detail</b> <i>evc-id</i> [ <b>interface</b> <i>interface-id</i> ]   <b>map interface</b> <i>type number</i> ]	Displays details sent to the CE from the status request poll about the E-LMI EVC.
<b>show ethernet lmi parameters interface</b> <i>interface-id</i>	Displays Ethernet LMI interface parameters sent to the CE from the status request poll.
<b>show ethernet lmi statistics interface</b> <i>interface-id</i>	Displays Ethernet LMI interface statistics sent to the CE from the status request poll.
<b>show ethernet lmi uni map interface</b> [ <i>interface-id</i> ]	Displays information about the E-LMI UNI VLAN map sent to the CE from the status request poll.
<b>show ethernet service instance</b> { <b>detail</b>   <b>id</b> <i>efp-identifier</i> <b>interface</b> <i>interface-id</i>   <b>interface</b> <i>interface-id</i> }	Displays information relevant to the specified Ethernet service instances (EFPs).

## Understanding Ethernet Loopback

The local aggregated Ethernet, Fast Ethernet, Tri-Rate Ethernet copper, and Gigabit Ethernet interfaces connect to a remote system. The Loopback command is used to place the interface in loopback mode. You can use per-port and per EFP Ethernet loopback to test connectivity at initial startup, to test throughput, and to test quality of service in both directions. The RFC2544 for latency testing specifies that the throughput must be measured by sending frames at increasing rate, representing the percentage of frames received as graphs, and reporting the frames dropping rate. This rate is dependent on the frame size. This throughput measurement at traffic generator requires the ethernet loopback support on the responder.

Ethernet loopback can be achieved with External or Internal loopback. External loopback is the process of looping frames coming from the port on the wire side. Internal loopback is the process of looping frames coming from the port on the relay side.

## Configuring Ethernet Loopback

This section contains the following topics:

- [Restrictions](#)
- [Enabling Ethernet Loopback](#)
- [Configuration Example](#)

## Restrictions

- Ethernet loopback is not supported on a routed port.
- A single terminal session is initiated at a time over a cross connect or bridge domain.
- The maximum total traffic that can be looped back across all sessions combined, is 1GB.
- For an internal loopback over bridge domain, the traffic for loopback must have encapsulation that matches the egress encapsulation. If there is a rewrite operation on the egress EFP, the traffic post the operation must match the EFP encapsulation.
- Dot1q tag-based filtering is not available on the Cisco ASR 901 router.
- Internal Loopback over bridge domain cannot be initiated if SPAN is already active.
- Internal Loopback over bridge domain cannot be initiated if Traffic generator is already active.
- Loopback is not supported on Fast Ethernet interface.
- External loopback is not supported on EFP with VLAN range.
- Source and destination address specified in the EXEC command are the MAC fields. These addresses are used for MAC swap. The source and destination MAC addresses cannot be identical or multicast MAC addresses.
- Source MAC address is mandatory.
- External loopback is only supported over bridge domain.
- Internal loopback is not supported over a port-channel interface
- When Ethernet Loopback is enabled, the L2CP forward and L2CP tunnel protocols are not functional on any ports.
- Internal loopback over cross connect cannot be initiated if the Traffic Generator is already active.

## Enabling Ethernet Loopback

Complete the following steps to configure Ethernet Loopback on the Cisco ASR 901 router:

### SUMMARY STEPS

1. **configure terminal**
2. **interface** *type number*
3. **service instance** *instance-number* **ethernet**
4. **encapsulation** *dot1q-number*
5. **rewrite ingress tag pop 1 symmetric**
6. [**bridge** *domain-number* | **xconnect** *peer-ip-address* *vc-id* **encapsulation** **mpls**]
7. **ethernet loopback permit** [**external** | **internal**]
8. **end**
9. **ethernet loopback start local interface** *interface-name* **service instance** *instance-number* {**external** | **internal**} **source mac-address** *source-mac-address* [**destination mac-address** *destination-mac-address*] [**timeout** {*time-in-seconds* | **none**}]
10. **ethernet loopback stop local interface** *type number* **id** *session id*

	Command or Action	Purpose
Step 1	<b>enable</b>  <b>Example:</b> Router> enable	Enables privileged EXEC mode. <ul style="list-style-type: none"> <li>Enter your password if prompted.</li> </ul>
Step 2	<b>configure terminal</b>  <b>Example:</b> Router# configure terminal	Enters global configuration mode.
Step 3	<b>interface</b> <i>type number</i>  <b>Example:</b> Router(config)# interface gigabitEthernet0/1	Specifies an interface type and number to enter the interface configuration mode.
Step 4	<b>service instance</b> <i>instance-number</i> <b>ethernet</b>  <b>Example:</b> Router(config-if)# service instance 10 ethernet	Creates a service instance on an interface and enters service instance configuration mode.
Step 5	<b>encapsulation</b> <i>dot1q-number</i>  <b>Example:</b> Router(config-if-srv)# encapsulation dot1q 10	Defines the matching criteria to be used in order to map the ingress dot1q frames on an interface to the appropriate service instance.
Step 6	<b>rewrite ingress tag pop</b> 1 <b>symmetric</b>  <b>Example:</b> Router(config-if-srv)# rewrite ingress tag pop 1 symmetric	Specifies the tag manipulation that is to be performed on the frame ingress to the service instance. Perform <a href="#">Step 7</a> if you want to configure ethernet loopback for a bridge-domain. Go to <a href="#">Step 8</a> if you want to configure ethernet loopback for cross connect.
Step 7	<b>bridge</b> <i>domain-number</i>  <b>Example:</b> Router(config-if-srv)# bridge domain 10	Binds the service instance to a bridge domain. Perform this step if you want to configure ethernet loopback for a bridge-domain.
Step 8	<b>xconnect</b> <i>peer-ip-address</i> <i>vc-id</i> <b>encapsulation</b> <b>mpls</b>  <b>Example:</b> Router(config-if-srv)# xconnect 1.1.1.1 100 encapsulation mpls	Binds an attachment circuit to a pseudowire, and to configure an Any Transport over MPLS (AToM) static pseudowire. Perform this step if you want to configure ethernet loopback for cross connect. <ul style="list-style-type: none"> <li><i>peer-ip-address</i>—IP address of the remote provider edge (PE) peer. The remote router ID can be any IP address, as long as it is reachable.</li> <li><i>vc-id</i>—The 32-bit identifier of the virtual circuit (VC) between the PE routers.</li> <li><b>encapsulation</b>—Specifies the tunneling method to encapsulate the data in the pseudowire.</li> <li><b>mpls</b>—Specifies MPLS as the tunneling method.</li> </ul>

	Command or Action	Purpose
Step 9	<b>ethernet loopback permit external</b>  <b>Example:</b> Router(config-if-srv)# ethernet loopback permit external	Configures ethernet permit external loopback on an interface. External loopback allows loopback of traffic from the wire side. This command is supported under a service instance and interface.
Step 10	<b>ethernet loopback permit internal</b>  <b>Example:</b> Router(config-if-srv)# ethernet loopback permit internal	Configures ethernet permit internal loopback on an interface. Internal loopback allows loopback of traffic from the relay side. This command is supported under a service instance and interface.
Step 11	<b>end</b>  <b>Example:</b> Router(config-if-srv)# end	Returns to privileged EXEC mode.
Step 12	<b>ethernet loopback start local interface</b> <i>type number</i> <b>service instance</b> <i>instance-number</i> { <b>external</b>   <b>internal</b> } <b>source mac-address</b> <i>source mac-address</i> [ <b>destination mac-address</b> <i>destination-mac-address</i> ] [ <b>timeout</b> <i>time-in-seconds</i>   <b>none</b> ]}  <b>Example:</b> Router# ethernet loopback start local interface gigabitEthernet 0/1 service instance 10 external source mac-address 0123.4567.89ab destination mac-address 255.255.255 timeout 9000	Starts ethernet external or internal loopback process on the service instance. Destination MAC address is an optional field. If destination mac address is not provided, the loopback interface MAC address is assigned to the source MAC address after swapping. <ul style="list-style-type: none"> <li>(Optional) Use the <b>timeout</b> <i>time-in-seconds</i> command to set a loopback timeout period. The range is from 1 to 90000 seconds (25 hours). The default value is 300 seconds.</li> <li>(Optional) Use the <b>timeout none</b> command to set the loopback to no time out.</li> </ul>
Step 13	<b>ethernet loopback stop local interface</b> <i>type number id session id</i>  <b>Example:</b> Router# ethernet loopback stop local interface gigabitEthernet 0/1 id 3	Stops ethernet loopback.

## Configuration Example

This example shows how to configure Ethernet External Loopback for a bridge-domain:

```
!
interface GigabitEthernet0/0
service instance 201 ethernet evc201
encapsulation dot1q 201
rewrite ingress tag pop 1 symmetric
bridge-domain 201
ethernet loopback permit external
ethernet loopback permit internal
!
```



```

ethernet loopback start local interface GigabitEthernet0/0 service instance 201
external source mac-address 5000.10a1.6ab8 destination mac-address 0000.0000.0202
timeout 9000
!
!
ethernet loopback stop local interface gigabitEthernet 0/0 id 1
!

```

This example shows how to configure Ethernet Internal Loopback for cross connect:

```

!
interface GigabitEthernet0/0
service instance 201 ethernet evc201
encapsulation dot1q 201
rewrite ingress tag pop 1 symmetric
xconnect 2.2.2.2 10 encapsulation mpls
ethernet loopback permit external
ethernet loopback permit internal
!
ethernet loopback start local interface GigabitEthernet0/0 service instance 201
internal source mac-address 5000.10a1.6ab8 destination mac-address 0000.0000.0202
timeout 9000
!
!
ethernet loopback stop local interface gigabitEthernet 0/0 id 1
!

```

The following is the example of the output from the **show ethernet loopback** command:

```

Router# show ethernet loopback active interface GigabitEthernet0/0 service instance 201
Loopback Session ID      : 1
Interface                 : GigabitEthernet0/0
Service Instance         : 201
Direction                 : Internal
Time out(sec)            : 300
Status                    : on
Start time                : 12:06:35.300 IST Mon Sep 23 2013
Time left                 : 00:03:28
Dot1q/Dot1ad(s)          : 201
Second-dot1q(s)          :
Source Mac Address       : 5000.10a1.6ab8
Destination Mac Address  : 0000.0000.0202
Ether Type                : Any
Class of service         : Any
Llc-oui                   : Any

Total Active Session(s) : 1
Total Internal Session(s) : 1
Total External Session(s) : 0

```

## Configuring Y.1564 to Generate Ethernet Traffic

Y.1564 is an Ethernet service activation or performance test methodology for turning up, installing, and troubleshooting Ethernet-based services. This test methodology allows for complete validation of Ethernet service-level agreements (SLAs) in a single test. Using traffic generator performance profile, you can create the traffic based on your requirements. The network performance like throughput, loss, and availability are analyzed using Layer 2 traffic with various bandwidth profiles. Availability is inversely proportional to frame loss ratio.

Figure 10-2 shows the Traffic Generator topology over bridge domain describing the traffic flow in the external and internal modes. The traffic is generated at the wire-side of network to network interface (NNI) and is transmitted to the responder through the same interface for the external mode. The traffic is generated at the user to network interface (UNI) and transmitted to the responder through NNI respectively for the internal mode. External mode is used to measure the throughput and loss at the NNI port where as internal mode is used to measure the throughput and loss at the UNI port. During traffic generation, traffic at other ports is not impacted by the generated traffic and can continue to switch network traffic.

**Figure 10-2** Traffic Generator Topology over Bridge Domain

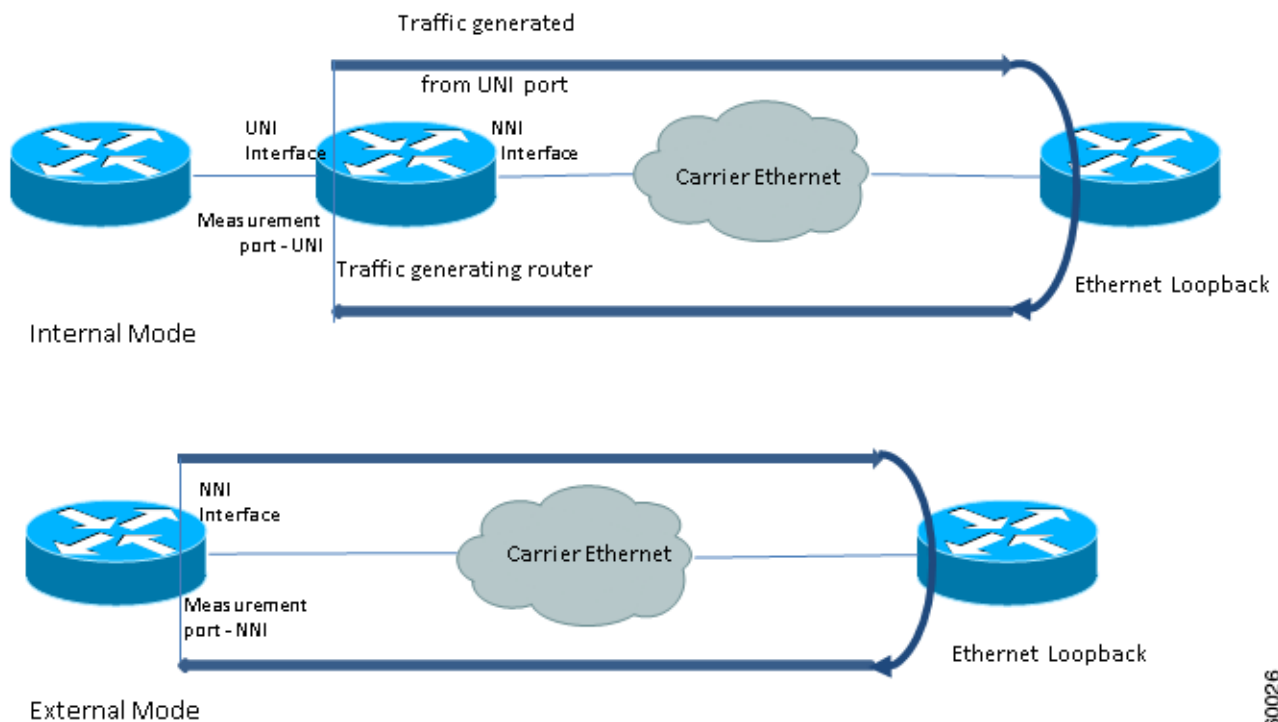

360026

Effective with Cisco IOS release 15.4.(01)S, traffic can be generated over cross connect interface.

Figure 10-3 shows the Traffic Generator topology over cross connect describing the traffic flow in the external and internal modes.

Figure 10-3 Traffic Generator Topology over cross connect

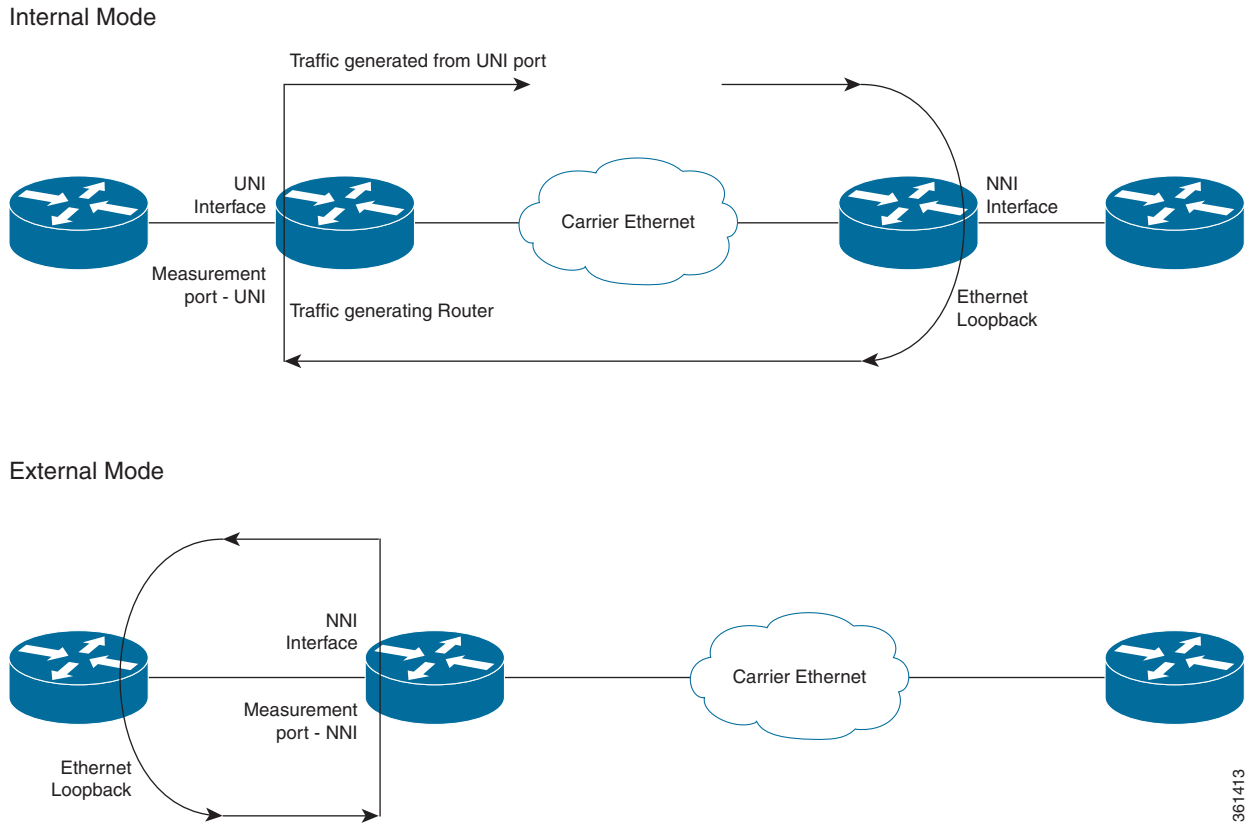

361413

To generate traffic using Y.1564, complete the following tasks:

- Configure EVC on the interface path such that the Layer 2/L2VPN path should be complete between transmitter and receiver.
- Configure Traffic Generator on the transmitter.
- Configure ethernet loopback on the receiver. For information on Ethernet loopback, see [Understanding Ethernet Loopback, page 10-51](#).
- Start the IP SLA session.

**Note**

Using traffic generator, a maximum traffic of 1GB is generated.

**Restrictions**

- A single traffic session is generated.
- Traffic generation will not be supported on VLAN interface.
- One-way traffic generation and passive measurement features are not supported.
- Payload signature verification is not supported.
- The QoS functions like classification and policing are supported on the ingress EVC.
- Internal mode traffic generation cannot be configured on port channel interfaces.
- Maximum throughput rate is 1GB.

- SPAN and Traffic generator cannot be used simultaneously since both uses the mirror mechanism.
- For Traffic generation over cross connect port-channel will not be supported for both internal and external modes.
- Ethernet loopback and Traffic generator cannot be used simultaneously.
- After reload, the Traffic generator over cross connect should be rescheduled (stop and start).
- After cross connect flaps, the Traffic generator over cross connect should be rescheduled (stop and start).

## Configuring IP SLA for Traffic Generation

Complete these steps to configure IP SLA for traffic generation.

### SUMMARY STEPS

1. **configure terminal**
2. **ip sla *sla\_id***
3. **service-performance type *ethernet dest-mac-addr destination mac-address interface type number service instance number***
4. **aggregation | default | description | duration | exit | frequency | measurement-type direction | no | profile | signature**
5. **default | exit | loss | no | throughput**
6. **exit**
7. **default | exit | inner-cos | inner-vlan | no | outer-cos | outer-vlan | packet-size | src-mac-addr**
8. **exit**
9. **direction {external | internal}**
10. **default | exit | no | rate-step**
11. **exit**

### DETAILED STEPS

	Command or Action	Purpose
Step 1	<b>configure terminal</b>  <b>Example:</b> Router# configure terminal	Enters global configuration mode.
Step 2	<b>ip sla <i>sla_id</i></b>  <b>Example:</b> Router(config)# ip sla 100	Specify the SLA ID to start the IP SLA session.

	Command or Action	Purpose
Step 3	<pre>service-performance type ethernet dest-mac-addr destination mac-address interface type number service instance number</pre> <p><b>Example:</b> Router(config-ip-sla)# service-performance type ethernet dest-mac-addr 0001.0001.0001 interface gigabitEthernet0/10 service instance 10</p>	<p>Specifies the service performance type as ethernet and the destination MAC address in H.H.H format.</p> <p>Specifies an interface type and number which traffic generator uses to send the packets. Also, specifies the service instance number that is required to create a service instance on an interface. The range is 1 to 4096.</p>
Step 4	<pre>aggregation   default   description   duration   exit   frequency   measurement-type direction   no   profile   signature</pre> <p><b>Example:</b> Router(config-ip-sla-service-performance)# profile traffic direction external</p>	<p>Specify the type of service performance. The following are the options:</p> <ul style="list-style-type: none"> <li>• <b>aggregation</b>—Represents the statistics aggregation.</li> <li>• <b>default</b>—Set a command to its defaults.</li> <li>• <b>description</b>—Description of the operation.</li> <li>• <b>duration</b>—Sets the service performance duration configuration.</li> <li>• <b>frequency</b>—Represents the scheduled frequency. The options available are iteration and time. The range is 20 to 65535 seconds.</li> <li>• <b>measurement-type direction</b>—Specifies the statistics to measure traffic. The options available are external or internal; the default option is Internal. If you use this option, go to Step 5.</li> <li>• <b>profile</b>—Specifies the service performance profile. If you use the packet or traffic option, go to Step 7 or Step 9 respectively.</li> <li>• <b>signature</b>—Specifies the payload contents.</li> </ul>
Step 5	<pre>default   exit   loss   no   throughput</pre> <p><b>Example:</b> Router(config-ip-sla-service-performance-measurement)# throughput</p>	<p>Specifies the measurement type based on which the service performance is calculated. The following are the options:</p> <ul style="list-style-type: none"> <li>• <b>default</b>—Set a command to its defaults</li> <li>• <b>loss</b>—Specifies the measurement such as frame loss.</li> <li>• <b>throughput</b>—Specifies the measurement such as average rate of successful frame delivery.</li> </ul>
Step 6	<pre>exit</pre>	<p>Exits the measurement mode.</p>

	Command or Action	Purpose
Step 7	<p><b>default</b>   <b>exit</b>   <b>inner-cos</b>   <b>inner-vlan</b>   <b>no</b>   <b>outer-cos</b>   <b>outer-vlan</b>   <b>packet-size</b>   <b>src-mac-addr</b></p> <p><b>Example:</b> Router(config-ip-sla-service-performance-packet)# src-mac-addr 4055.3989.7b56</p>	<p>Specifies the packet type. The following are the options:</p> <ul style="list-style-type: none"> <li>• <b>default</b>—Set a command to its defaults</li> <li>• <b>inner-cos</b>—Specify the class of service (CoS) value for the inner VLAN tag of the interface from which the message will be sent.</li> <li>• <b>inner-vlan</b>—Specify the VLAN ID for the inner vlan tag of the interface from which the message will be sent.</li> <li>• <b>outer-cos</b>—Specify the CoS value which will be filled in the outer VLAN tag of the packet.</li> <li>• <b>outer-vlan</b>—Specify the VLAN ID which will be filled in the outer VLAN tag of the packet.</li> <li>• <b>packet-size</b>—Specify the packet size; the default size is 64 bytes. The supported packet size are 64 bytes, 128 bytes, 256 bytes, 512 bytes, 1280 bytes, and 1518 bytes.</li> <li>• <b>src-mac-addr</b>—Specifies the source MAC address in H.H.H format.</li> </ul>
Step 8	<b>exit</b>	Exits the packet mode.
Step 9	<p><b>direction</b> {<b>external</b>   <b>internal</b>}</p> <p><b>Example:</b> Router(config-ip-sla-service-performance)# profile traffic direction external</p>	Specifies the direction of the profile traffic. The options are external and internal.
Step 10	<p><b>default</b> or <b>exit</b> or <b>no</b> or <b>rate-step</b></p> <p><b>Example:</b> Router(config-ip-sla-service-performance-traffic)# rate-step kbps 1000</p>	<p>Specifies the traffic type. The following are the options:</p> <ul style="list-style-type: none"> <li>• <b>default</b>—Set a command to its defaults</li> <li>• <b>rate-step</b>—Specifies the transmission rate in kbps. The rate-step range is from 1-1000000 (1 Kbps to 1Gbps).</li> </ul>
Step 11	<b>exit</b>	Exits the traffic mode.

## Configuration Examples

This section shows sample configuration examples for traffic generation on Cisco ASR 901 Router:

```
ip sla 10
 service-performance type ethernet dest-mac-addr 0001.0001.0001 interface
 TenGigabitEthernet0/0 service instance 30
 measurement-type direction external
 loss
 throughput
```

```
profile packet
  outer-vlan 30
  packet-size 512
  src-mac-addr d48c.b544.93dd
profile traffic direction external
  rate-step kbps 1000
  frequency time 35
```

### Example: Two-Way Measurement

The following is a sample configuration for two-way measurement to measure throughput, loss, tx, rx, txbytes, and rxbytes.

```
INTERNAL: (to test UNI scenario)
ip sla 2
service-performance type ethernet dest-mac-addr aaaa.bbbb.cccc interface
GigabitEthernet0/0 service instance 2
measurement-type direction internal
loss
throughput
profile packet
  outer-vlan 10
  packet-size 512
  src-mac-addr d48c.b544.9600
profile traffic direction internal
  rate-step kbps 1000 2000 3000
  frequency time 95
```

```
EXTERNAL: (to test NNI scenario)
ip sla 2
service-performance type ethernet dest-mac-addr aaaa.bbbb.cccc interface
gigabitEthernet0/7 service instance 2
measurement-type direction external
loss
throughput
profile packet
  outer-vlan 10
  packet-size 512
  src-mac-addr d48c.b544.9600
profile traffic direction external
  rate-step kbps 1000 2000 3000
  frequency time 95
```

### Example: Traffic Generation Mode

The following is a sample configuration for traffic generation mode to measure tx and txbytes.

```
INTERNAL: (to test UNI scenario)
ip sla 2
service-performance type ethernet dest-mac-addr aaaa.bbbb.cccc interface
GigabitEthernet0/0 service instance 2
measurement-type direction internal
profile packet
  outer-vlan 10
  packet-size 512
  src-mac-addr d48c.b544.9600
profile traffic direction internal
  rate-step kbps 1000 2000 3000
  frequency time 95
```

```

EXTERNAL: (to test NNI scenario)
ip sla 2
service-performance type ethernet dest-mac-addr aaa.bbbb.cccc interface
GigabitEthernet0/7 service instance 2
measurement-type direction external
profile packet
outer-vlan 10
packet-size 512
src-mac-addr d48c.b544.9600
profile traffic direction external
rate-step kbps 1000 2000 3000
frequency time 95

```

The following is an example of the output from the **show ip sla statistics** command.

```

show ip sla statistics 10
IPSLAs Latest Operation Statistics

IPSLA operation id: 10
Type of operation: Ethernet Service Performance
Test mode: Traffic Generator
Steps Tested (kbps): 1000
Test duration: 30 seconds

Latest measurement: 01:34:08.636 IST Wed Sep 25 2013
Latest return code: OK

Step 1 (1000 kbps):
Stats:

Tx Packets: 1425 Tx Bytes: 729600
Step Duration: 6 seconds

```

**Note**

---

Statistics are cumulative over a period of time and not specific to any particular time instance.

---





# CHAPTER 11

## ITU-T Y.1731 Performance Monitoring

This chapter provides information on the ITU-T Y.1731 Performance Monitoring for the Cisco ASR 901 Series Aggregation Services Router.

### Finding Feature Information

Your software release may not support all the features documented in this module. For the latest feature information and caveats, see the release notes for your platform and software release. To find information about the features documented in this module, and to see a list of the releases in which each feature is supported, see the “[Feature Information for ITU-T Y.1731 Performance Monitoring](#)” section on page 11-25.

Use Cisco Feature Navigator to find information about platform support and Cisco software image support. To access Cisco Feature Navigator, go to <http://www.cisco.com/go/cfn>. An account on Cisco.com is not required.

### Contents

- [Prerequisites for ITU-T Y.1731 Performance Monitoring](#), page 11-1
- [Restrictions for ITU-T Y.1731 Performance Monitoring](#), page 11-2
- [Information About ITU-T Y.1731 Performance Monitoring](#), page 11-2
- [How to Configure ITU-T Y.1731 Performance Monitoring](#), page 11-5
- [Verifying the Frame Delay and Synthetic Loss Measurement Configurations](#), page 11-15
- [How to Configure IP SLAs Y.1731 On-Demand and Concurrent Operations](#), page 11-19
- [Configuration Examples for IP SLAs Y.1731 On-Demand Operations](#), page 11-21
- [Additional References](#), page 11-23
- [Feature Information for ITU-T Y.1731 Performance Monitoring](#), page 11-25

### Prerequisites for ITU-T Y.1731 Performance Monitoring

- Configure and enable IEEE-compliant connectivity fault management (CFM) for Y.1731 performance monitoring to function.

## Restrictions for ITU-T Y.1731 Performance Monitoring

- The Cisco ASR 901 router does not support one-way delay measurement (1DM).
- The Cisco ASR 901 router does not support Loss Measurement Message (LMM).
- The Cisco ASR 901 router does not support Delay Measurement Message (DMM) on the cross connect EVC.
- The Cisco ASR 901 router does not support Synthetic Loss Measurement (SLM) on the port level cross connect.
- The Cisco ASR901 router does not support Multi-NNI CFM and SLM over the cross-connect EFP simultaneously. However, you can enable Multi-NNI CFM or SLM over the cross-connect EFP function in a node.

## Information About ITU-T Y.1731 Performance Monitoring

When service providers sell connectivity services to a subscriber, a Service Level Agreement (SLA) is reached between the buyer and seller of the service. The SLA defines the attributes offered by a provider and serves as a legal obligation on the service provider. As the level of performance required by subscribers rises, service providers need to monitor the performance parameters being offered. Various standards, such as IEEE 802.1ag and ITU-T Y.1731, define the methods and frame formats used to measure performance parameters.

ITU-T Y.1731 performance monitoring provides standards-based Ethernet performance monitoring as outlined in the ITU-T Y-1731 specification and interpreted by the Metro Ethernet Forum (MEF). It includes the measurement of Ethernet frame delay, frame delay variation, frame loss, and throughput.

To measure SLA parameters such as frame delay or frame delay variation, a small number of synthetic frames are transmitted along with the service to the end point of the maintenance region, where the Maintenance End Point (MEP) responds to the synthetic frame.

The following figure illustrates Maintenance Entities (ME) and MEP typically involved in a point-to-point metro ethernet deployment for the Y.1731 standard.

**Figure 11-1 A Point-to-Point Metro Ethernet Deployment with Typical Maintenance Entities and Maintenance Points**

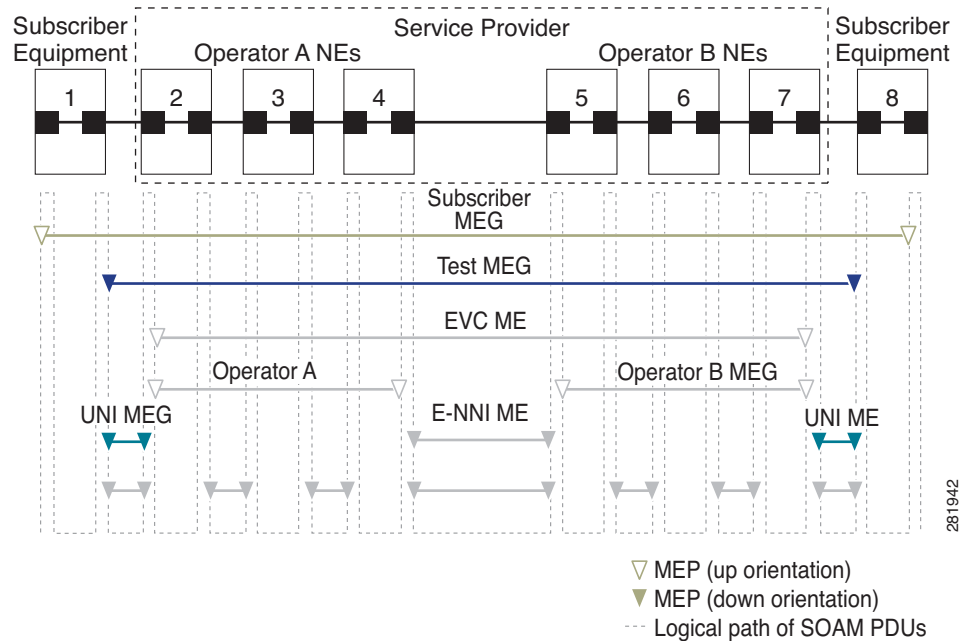

## Frame Delay and Frame-Delay Variation

Ethernet frame Delay Measurement (ETH-DM) is used for on-demand Ethernet Operations, Administration & Maintenance (OAM) to measure frame delay and frame-delay variation.

Ethernet frame delay and frame delay variation are measured by sending periodic frames with ETH-DM information to the peer MEP in the same maintenance entity. Peer MEPs perform frame-delay and frame-delay variation measurements through this periodic exchange during the diagnostic interval.

Ethernet frame delay measurement supports hardware-based timestamping in the ingress direction.

These are the two methods of delay measurement, as defined by the ITU-T Y.1731 standard, One-way ETH-DM (1DM) and Two-way ETH-DM (2DM). However, the Cisco ASR 901 router supports only Two-way ETH-DM.

### Two-way Delay Measurement

Two-way frame delay and variation can be measured using DMM and Delay Measurement Reply (DMR) frames.

In two-way delay measurements, the sender MEP transmits a frame containing ETH-DM request information and TxTimeStamp, where TxTimeStamp is the timestamp of the time at which the DMM is sent.

When the receiver MEP receives the frame, it records RxTimeStamp, where RxTimeStamp is the timestamp of the time at which the frame with ETH-DM request information is received.

The receiver MEP responds with a frame containing ETH-DM reply information and TxTimeStampb, where TxTimeStampb is the timestamp of the time at which the frame with ETH-DM reply information is sent.

When the sender MEP receives this frame, it records RxTimeStampb, where RxTimeStampb is the timestamp of the time at which the frame containing ETH-DM reply information is received.

Two-way frame delay is calculated as:

Frame delay = (RxTimeStampb-TxTimeStampf)-(TxTimeStampb-RxTimeStampf)



**Note**

Discard the frame delay and frame-delay variation measurements when known network topology changes occur or when continuity and availability faults occur.

For more information on ITU-T Y.1731 performance monitoring, see [Configuring IP SLAs Metro-Ethernet 3.0 \(ITU-T Y.1731\) Operations](#) in the *IP SLAs Configuration Guide*.

## Frame Loss Ratio

Ethernet Frame Loss Ratio (ETH-LM: FLR), also known as frame loss, measures the availability of synthetic frames in the network. Availability is defined in terms of the ratio of frames lost to frames sent, or Frame Loss Ratio (FLR).

Ethernet Synthetic Loss Measurement (ETH-SLM) is used to collect counter values applicable for ingress and egress synthetic frames where the counters maintain a count of transmitted and received synthetic frames between a pair of MEPs.

ETH-SLM transmits synthetic frames with ETH-SLM information to a peer MEP and similarly receives synthetic frames with ETH-SLM information from the peer MEP. Each MEP performs frame loss measurements, which contribute to unavailable time. A near-end frame loss refers to frame loss associated with ingress data frames. A far-end frame loss refers to frame loss associated with egress data frames. Both near-end and far-end frame loss measurements contribute to near-end severely errored seconds and far-end severely errored seconds, which together contribute to unavailable time. ETH-SLM is measured using SLM and SLR frames.

There are the two methods of frame loss measurement, defined by the ITU-T Y.1731 standard ETH-LM and ETH-SLM. However, the Cisco ASR 901 router supports only single-ended ETH-SLM.

### Single-ended ETH-SLM

Each MEP transmits frames with the ETH-SLM request information to its peer MEP and receives frames with ETH-SLR reply information from its peer MEP to carry out synthetic loss measurements.

## On-Demand and Concurrent Operations

On-demand IP SLAs SLM operations enable users without configuration access to perform real-time troubleshooting of Ethernet services. There are two operational modes for on-demand operations: direct mode that creates and runs an operation immediately and referenced mode that starts and runs a previously configured operation.

- In the direct mode, a single command can be used to create multiple pseudo operations for a range of class of service (CoS) values to be run, in the background, immediately. A single command in privileged EXEC mode can be used to specify frame size, interval, frequency, and duration for the direct on-demand operation. Direct on-demand operations start and run immediately after the command is issued.

- In the referenced mode, you can start one or more already-configured operations for different destinations, or for the same destination, with different CoS values. Issuing the privileged EXEC command creates a pseudo version of a proactive operation that starts and runs in the background, even while the proactive operation is running.
- After an on-demand operation is completed, statistical output is displayed on the console. On-demand operation statistics are not stored and are not supported by the statistic history and aggregation functions.
- After an on-demand operation is completed, and the statistics handled, the direct and referenced on-demand operation is deleted. The proactive operations are not deleted and continue to be available to be run in referenced mode, again.

A concurrent operation consists of a group of operations, all configured with the same operation ID number, that run concurrently. Concurrent operations are supported for a given EVC, CoS, and remote MEP combination, or for multiple MEPs for a given multipoint EVC, for delay or loss measurements.

The Cisco ASR 901 router also supports burst mode for concurrent operations, one-way dual-ended, single-ended delay and delay variation operations, and single-ended loss operations.

## Supported interfaces

The ASR 901 router supports ITU-T Y.1731 performance monitoring on the following interfaces:

- DMM and SLM support on the EVC bridge domain (BD)
- DMM and SLM support on the Port-Channel EVC BD
- SLM support on the EVC cross connect
- SLM support on the Port-Channel EVC cross connect
- DMM and SLM support on the EVC BD for both the up and down MEPs
- SLM support on the EVC cross connect for both the up and down MEPs



### Note

SLM and DMM can be configured for the same EVCs over CFM session. The combined number of CFM, DMM, and SLM sessions must be within the scale limits, otherwise DMM/SLM probes might get dropped resulting in a few incomplete measurements.

## Benefits of ITU-T Y.1731 Performance Monitoring

Combined with IEEE-compliant CFM, Y.1731 performance monitoring provides a comprehensive fault management and performance monitoring solution for service providers. This comprehensive solution in turn lessens service providers' operating expenses, improves their SLAs, and simplifies their operations.

## How to Configure ITU-T Y.1731 Performance Monitoring

- [Configuring Two-Way Delay Measurement, page 11-6](#)
- [Configuring Single-Ended Synthetic Loss Measurement, page 11-9](#)
- [Scheduling IP SLAs Operations, page 11-14](#)

## Configuring Two-Way Delay Measurement



### Note

To display information about remote (target) MEPs on destination devices, use the **show ethernet cfm maintenance-points remote** command.

Complete the following steps to configure two-way delay measurement.

### SUMMARY STEPS

1. **enable**
2. **configure terminal**
3. **ip sla operation-number**
4. **ethernet y1731 delay DMM domain domain-name { evc evc-id | vlan vlan-id } { mpid target-mp-id | mac-address target-address } cos cos { source { mpid source-mp-id | mac-address source-address } }**
5. **aggregate interval seconds**
6. **distribution { delay | delay-variation } { one-way | two-way } number-of-bins boundary[,...,boundary]**
7. **frame interval milliseconds**
8. **frame offset offset-value**
9. **frame size bytes**
10. **history interval intervals-stored**
11. **max-delay milliseconds**
12. **owner owner-id**
13. **end**

### DETAILED STEPS

	Command	Purpose
Step 1	<b>enable</b>  <b>Example:</b> Router> enable	Enables privileged EXEC mode. <ul style="list-style-type: none"> <li>• Enter your password if prompted.</li> </ul>
Step 2	<b>configure terminal</b>  <b>Example:</b> Router# configure terminal	Enters global configuration mode.
Step 3	<b>ip sla operation-number</b>  <b>Example:</b> Router(config)# ip sla 10	Configures an IP SLA operation and enters IP SLA configuration mode. <ul style="list-style-type: none"> <li>• <i>operation-number</i>—Identifies the IP SLAs operation you want to configure.</li> </ul>

Command	Purpose
<p><b>Step 4</b></p> <pre> <b>ethernet y1731 delay DMM domain</b> <i>domain-name</i> {<b>evc</b> <i>evc-id</i>   <b>vlan</b> <i>vlan-id</i>} {<b>mpid</b> <i>target-mp-id</i>   <b>mac-address</b> <i>target-address</i>} <b>cos</b> <i>cos</i> {<b>source</b> {<b>mpid</b> <i>source-mp-id</i>   <b>mac-address</b> <i>source-address</i>}}</pre> <p><b>Example:</b>  Router(config-ip-sla)# ethernet y1731 delay DMM domain xxx evc yyy mpid 101 cos 4 source mpid 100</p>	<p>Configures two-way delay measurement and enters IP SLA Y.1731 delay configuration mode.</p> <ul style="list-style-type: none"> <li>• <b>DMM</b>—Specifies that the frames sent are Delay Measurement Message (DMM) synthetic frames.</li> <li>• <b>domain</b> <i>domain-name</i>—Specifies the name of the Ethernet maintenance Operations, Administration &amp; Maintenance (OAM) domain.</li> <li>• <b>evc</b> <i>evc-id</i>—Specifies the EVC identification name.</li> <li>• <b>vlan</b> <i>vlan-id</i>—Specifies the VLAN identification number. The range is from 1 to 4096.</li> <li>• <b>mpid</b> <i>target-mp-id</i>—Specifies the maintenance endpoint identification numbers of the MEP at the destination. The range is from 1 to 8191.</li> <li>• <b>mac-address</b> <i>target-address</i>—Specifies the MAC address of the MEP at the destination.</li> <li>• <b>cos</b> <i>cos</i>—Specifies, for this MEP, the class of service (CoS) that will be sent in the Ethernet message. The range is from 0 to 7.</li> <li>• <b>source</b>—Specifies the source MP ID or MAC address.</li> <li>• <b>mpid</b> <i>source-mp-id</i>—Specifies the maintenance endpoint identification numbers of the MEP being configured. The range is from 1 to 8191.</li> <li>• <b>mac-address</b> <i>source-address</i>—Specifies the MAC address of the MEP being configured.</li> </ul>
<p><b>Step 5</b></p> <pre> <b>aggregate interval</b> <i>seconds</i></pre> <p><b>Example:</b>  Router(config-sla-y1731-delay)# aggregate interval 900</p>	<p>(Optional) Configures the length of time during which the performance measurements are conducted and the results stored.</p> <ul style="list-style-type: none"> <li>• <b>seconds</b>—Specifies the length of time in seconds. The range is from 1 to 65535. The default is 900.</li> </ul>

Command	Purpose
<p><b>Step 6</b> <code>distribution {delay   delay-variation} {one-way   two-way} number-of-bins boundary[, ...,boundary]</code></p> <p><b>Example:</b>  Router(config-sla-y1731-delay)# distribution delay-variation two-way 5 5000, 10000,15000,20000,-1</p>	<p>(Optional) Specifies measurement type and configures bins for statistics distributions kept.</p> <ul style="list-style-type: none"> <li>• <b>delay</b>—Specifies that the performance measurement type is delay. This is the default value, along with delay variation.</li> <li>• <b>delay-variation</b>—Specifies that the performance measurement type is delay variation. This is the default value, along with delay.</li> <li>• <b>one-way</b>—Specifies one-way measurement values. This is the default for a dual-ended operation.</li> <li>• <b>two-way</b>—Specifies two-way measurement values. This is the default for a single-ended operation.</li> <li>• <i>number-of-bins</i>—Specifies the number of bins kept during an aggregate interval. The range is from 1 to 10. The default is 10.</li> <li>• <i>boundary</i> [,...,<i>boundary</i>]—Lists upper boundaries for bins in microseconds. Minimum number of boundaries required is one. Maximum allowed value for the uppermost boundary is -1 microsecond. Multiple values must be separated by a comma (.). The default value is 5000,10000,15000,20000,25000,30000,35000,40000,45000, -1.</li> </ul>
<p><b>Step 7</b> <code>frame interval milliseconds</code></p> <p><b>Example:</b>  Router(config-sla-y1731-delay)# frame interval 100</p>	<p>(Optional) Sets the gap between successive frames.</p> <ul style="list-style-type: none"> <li>• <i>milliseconds</i>—Specifies the length of time in milliseconds (ms) between successive synthetic frames. The range is from 100 to 10000. The default is 1000.</li> </ul>
<p><b>Step 8</b> <code>frame offset offset-value</code></p> <p><b>Example:</b>  Router(config-sla-y1731-delay)# frame offset 1</p>	<p>(Optional) Sets a value for calculating delay variation values.</p> <ul style="list-style-type: none"> <li>• <i>offset-value</i>—The range is from 1 to 10. The default is 1.</li> </ul>
<p><b>Step 9</b> <code>frame size bytes</code></p> <p><b>Example:</b>  Router(config-sla-y1731-delay)# frame size 32</p>	<p>(Optional) Configures padding size for frames.</p> <ul style="list-style-type: none"> <li>• <i>bytes</i>—Specifies the padding size, in four-octet increments, for the synthetic frames. The range is from 64 to 384. The default is 64.</li> </ul>
<p><b>Step 10</b> <code>history interval intervals-stored</code></p> <p><b>Example:</b>  Router(config-sla-y1731-delay)# history interval 2</p>	<p>(Optional) Sets the number of statistics distributions kept during the lifetime of an IP SLAs Ethernet operation.</p> <ul style="list-style-type: none"> <li>• <i>intervals-stored</i>—Specifies the number of statistics distributions. The range is from 1 to 10. The default is 2.</li> </ul>



	Command	Purpose
Step 11	<b>max-delay</b> <i>milliseconds</i>  <b>Example:</b> Router(config-sla-y1731-delay)# max-delay 5000	(Optional) Sets the amount of time an MEP waits for a frame.  <ul style="list-style-type: none"> <li><i>milliseconds</i>—Specifies the maximum delay in milliseconds (ms). The range is from 1 to 65535. The default is 5000.</li> </ul>
Step 12	<b>owner</b> <i>owner-id</i>  <b>Example:</b> Router(config-sla-y1731-delay)# owner admin	(Optional) Configures the owner of an IP SLAs operation.  <ul style="list-style-type: none"> <li><i>owner-id</i>—Specifies the name of the SNMP owner. The value is from 0 to 255 ASCII characters.</li> </ul>
Step 13	<b>end</b>  <b>Example:</b> Router(config-sla-y1731-delay)# end	Exits IP SLA Y.1731 delay configuration mode and enters privileged EXEC mode.

### What to Do Next

After configuring two-way delay measurement, see the [Scheduling IP SLAs Operations, page 11-14](#) to schedule the operation.

## Configuring Single-Ended Synthetic Loss Measurement



#### Note

To display information about remote (target) MEPs on destination devices, use the **show ethernet cfm maintenance-points remote** command.

Complete the following steps to configure a single-ended SLM.

### Prerequisites

Class of Service (CoS)-level monitoring must be enabled on MEPs associated to the Ethernet frame loss operation using the **monitor loss counter** command on the devices at both ends of the operation.



#### Note

Cisco IOS Y.1731 implementation allows monitoring of frame loss for frames on an EVC regardless of the CoS value (any CoS or Aggregate CoS cases). See the "Configuration Examples for IP SLAs Metro-Ethernet 3.0 (ITU-T Y.1731) Operations" section for configuration information.

### SUMMARY STEPS

1. **enable**
2. **configure terminal**
3. **asr901-platf-multi-nni-cfm**
4. **ip sla operation-number**

5. **ethernet y1731 loss SLM domain** *domain-name* {**evc** *evc-id* | **vlan** *vlan-id*} {**mpid** *target-mp-id* | **mac-address** *target-address*} **cos** *cos* {**source** {**mpid** *source-mp-id* | **mac-address** *source-address*}}
6. **aggregate interval** *seconds*
7. **availability algorithm** {**sliding-window** | **static-window**}
8. **frame consecutive** *value*
9. **frame interval** *milliseconds*
10. **frame size** *bytes*
11. **history interval** *intervals-stored*
12. **owner** *owner-id*
13. **exit**
14. **exit**
15. **ip sla reaction-configuration** *operation-number* [**react** {**unavailableDS** | **unavailableSD** | **loss-ratioDS** | **loss-ratioSD**}] [**threshold-type** {**average** [*number-of-measurements*] | **consecutive** [*occurrences*] | **immediate**}] [**threshold-value** *upper-threshold lower-threshold*]
16. **ip sla logging traps**
17. **exit**

## DETAILED STEPS

	Command	Purpose
Step 1	<b>enable</b>  <b>Example:</b> Router> enable	Enables privileged EXEC mode. <ul style="list-style-type: none"> <li>• Enter your password if prompted.</li> </ul>
Step 2	<b>configure terminal</b>  <b>Example:</b> Router# configure terminal	Enters global configuration mode.
Step 3	<b>[no] asr901-platf-multi-nni-cfm</b>  <b>Example:</b> Router# asr901-platf-multi-nni-cfm	Enables Multi-NNI CFM configuration on the Cisco ASR 901 router. The <b>no</b> form of this command enables the SLM over cross connect EVC configuration. The default option enables multi-NNI CFM configuration.
Step 4	<b>ip sla</b> <i>operation-number</i>  <b>Example:</b> Router(config)# ip sla 11	Configures an IP SLA operation and enters IP SLA configuration mode. <ul style="list-style-type: none"> <li>• <i>operation-number</i>—Identifies the IP SLAs operation you want to configure.</li> </ul>

Command	Purpose
<p><b>Step 5</b></p> <pre>ethernet y1731 loss SLM domain domain-name {evc evc-id   vlan vlan-id} {mpid target-mp-id   mac-address target-address} cos cos {source {mpid source-mp-id   mac-address source-address}}</pre> <p><b>Example:</b> Router(config-ip-sla)# ethernet y1731 loss SLM domain xxx evc yyy mpid 101 cos 4 source mpid 100</p>	<p>Configures a single-ended synthetic loss measurement and enters IP SLA Y.1731 loss configuration mode.</p> <ul style="list-style-type: none"> <li>• <b>SLM</b>—Specifies that the frames sent are Synthetic Loss Measurement (SLM) frames.</li> <li>• <b>domain domain-name</b>—Specifies the name of the Ethernet Connectivity Fault Management (CFM) maintenance domain.</li> <li>• <b>evc evc-id</b>—Specifies the EVC identification name.</li> <li>• <b>vlan vlan-id</b>—Specifies the VLAN identification number. The range is from 1 to 4096.</li> <li>• <b>mpid target-mp-id</b>—Specifies the maintenance endpoint identification numbers of the MEP at the destination. The range is from 1 to 8191.</li> <li>• <b>mac-address target-address</b>—Specifies the MAC address of the MEP at the destination.</li> <li>• <b>cos cos</b>—Specifies, for this MEP, the class of service (CoS) that will be sent in the Ethernet message. The range is from 0 to 7.</li> <li>• <b>source</b>—Specifies the source MP ID or MAC address.</li> <li>• <b>mpid source-mp-id</b>—Specifies the maintenance endpoint identification numbers of the MEP being configured. The range is from 1 to 8191.</li> <li>• <b>mac-address source-address</b>—Specifies the MAC address of the MEP being configured.</li> </ul>
<p><b>Step 6</b></p> <pre>aggregate interval seconds</pre> <p><b>Example:</b> Router(config-sla-y1731-loss)# aggregate interval 900</p>	<p>(Optional) Configures the length of time during which the performance measurements are conducted and the results stored.</p> <ul style="list-style-type: none"> <li>• <b>seconds</b>—Specifies the length of time in seconds. The range is from 1 to 65535. The default is 900.</li> </ul>
<p><b>Step 7</b></p> <pre>availability algorithm {sliding-window   static-window}</pre> <p><b>Example:</b> Router(config-sla-y1731-loss)# availability algorithm static-window</p>	<p>(Optional) Specifies availability algorithm used.</p> <ul style="list-style-type: none"> <li>• <b>sliding-window</b>—Specifies a sliding-window control algorithm.</li> <li>• <b>static-window</b>—Specifies static-window control algorithm.</li> </ul>
<p><b>Step 8</b></p> <pre>frame consecutive value</pre> <p><b>Example:</b> Router(config-sla-y1731-loss)# frame consecutive 10</p>	<p>(Optional) Specifies number of consecutive measurements to be used to determine availability or unavailability status.</p> <ul style="list-style-type: none"> <li>• <b>value</b>—Specifies the number of consecutive measurements. The range is from 1 to 10. The default is 10.</li> </ul>

	Command	Purpose
Step 9	<p><b>frame interval</b> <i>milliseconds</i></p> <p><b>Example:</b> Router(config-sla-y1731-loss)# frame interval 100</p>	<p>(Optional) Sets the gap between successive frames.</p> <ul style="list-style-type: none"> <li><i>milliseconds</i>—Specifies the length of time in milliseconds (ms) between successive synthetic frames. The range is from 100 to 10000. The default is 1000.</li> </ul>
Step 10	<p><b>frame size</b> <i>bytes</i></p> <p><b>Example:</b> Router(config-sla-y1731-loss)# frame size 32</p>	<p>(Optional) Configures padding size for frames.</p> <ul style="list-style-type: none"> <li><i>bytes</i>—Specifies the padding size, in four-octet increments, for the synthetic frames. The range is from 64 to 384. The default is 64.</li> </ul>
Step 11	<p><b>history interval</b> <i>intervals-stored</i></p> <p><b>Example:</b> Router(config-sla-y1731-loss)# history interval 2</p>	<p>(Optional) Sets the number of statistics distributions kept during the lifetime of an IP SLAs Ethernet operation.</p> <ul style="list-style-type: none"> <li><i>intervals-stored</i>—Specifies the number of statistics distributions. The range is from 1 to 10. The default is 2.</li> </ul>
Step 12	<p><b>owner</b> <i>owner-id</i></p> <p><b>Example:</b> Router(config-sla-y1731-loss)# owner admin</p>	<p>(Optional) Configures the owner of an IP SLAs operation.</p> <ul style="list-style-type: none"> <li><i>owner-id</i>—Specified the name of the SNMP owner. The value is from 0 to 255 ASCII characters.</li> </ul>
Step 13	<p><b>exit</b></p> <p><b>Example:</b> Router(config-sla-y1731-loss)# exit</p>	<p>Exits IP SLA Y.1731 loss configuration mode and enters IP SLA configuration mode.</p>
Step 14	<p><b>exit</b></p> <p><b>Example:</b> Router(config-ip-sla)# exit</p>	<p>Exits IP SLA configuration mode and enters global configuration mode.</p>

Command	Purpose
<p><b>Step 15</b> <code>ip sla reaction-configuration operation-number</code>  <code>[react {unavailableDS   unavailableSD   loss-ratioDS</code>  <code>  loss-ratioSD}] [threshold-type {average</code>  <code>[number-of-measurements]   consecutive [occurrences]</code>  <code>  immediate}] [threshold-value upper-threshold</code>  <code>lower-threshold]</code></p> <p><b>Example:</b>  Router(config)# ip sla reaction-configuration 11  react unavailableDS</p>	<p>(Optional) Configures proactive threshold monitoring for frame loss measurements.</p> <ul style="list-style-type: none"> <li>• <i>operation-number</i>—Identifies the IP SLAs operation for which reactions are to be configured.</li> <li>• <b>react</b>—(Optional) Specifies the element to be monitored for threshold violations.</li> <li>• <b>unavailableDS</b>—Specifies that a reaction should occur if the percentage of destination-to-source Frame Loss Ratio (FLR) violates the upper threshold or lower threshold.</li> <li>• <b>unavailableSD</b>—Specifies that a reaction should occur if the percentage of source-to-destination FLR violates the upper threshold or lower threshold.</li> <li>• <b>loss-ratioDS</b>—Specifies that a reaction should occur if the one-way destination-to-source loss-ratio violates the upper threshold or lower threshold.</li> <li>• <b>loss-ratioSD</b>—Specifies that a reaction should occur if the one way source-to-destination loss-ratio violates the upper threshold or lower threshold.</li> <li>• <b>threshold-type average</b> <i>[number-of-measurements]</i>—(Optional) When the average of a specified number of measurements for the monitored element exceeds the upper threshold or when the average of a specified number of measurements for the monitored element drops below the lower threshold, perform the action defined by the <b>action-type</b> keyword. The default number of 5 averaged measurements can be changed using the <i>number-of-measurements</i> argument. The range is from 1 to 16.</li> <li>• <b>threshold-type consecutive</b> <i>[occurrences]</i>—(Optional) When a threshold violation for the monitored element is met consecutively for a specified number of times, perform the action defined by the <b>action-type</b> keyword. The default number of 5 consecutive occurrences can be changed using the <i>occurrences</i> argument. The range is from 1 to 16.</li> </ul>

Command	Purpose
	<ul style="list-style-type: none"> <li>• <b>threshold-type immediate</b>—(Optional) When a threshold violation for the monitored element is met, immediately perform the action defined by the <b>action-type</b> keyword.</li> <li>• <b>threshold-value <i>upper-threshold lower-threshold</i></b>—(Optional) Specifies the upper-threshold and lower-threshold values of the applicable monitored elements.</li> </ul>
<b>Step 16</b> <code>ip sla logging traps</code>  <b>Example:</b> <pre>Router(config)# ip sla logging traps</pre>	(Optional) Enables IP SLAs syslog messages from CISCO-RTTMON-MIB.
<b>Step 17</b> <code>exit</code>  <b>Example:</b> <pre>Router(config)# exit</pre>	Exits global configuration mode and enters privileged EXEC mode.

### What to Do Next

After configuring this MEP, see the [Scheduling IP SLAs Operations, page 11-14](#) to schedule the operation.

## Scheduling IP SLAs Operations

Complete the following steps to schedule an IP SLAs operation.

### Prerequisites

- All IP SLAs operations to be scheduled must be already configured.
- The frequency of all operations scheduled in a multi-operation group must be the same.
- List of one or more operation ID numbers to be added to a multi-operation group is limited to a maximum of 125 characters, including commas (,).

### SUMMARY STEPS

1. **enable**
2. **configure terminal**
3. Do one of the following:
  - **ip sla schedule** *operation-number* [**life** {**forever** | *seconds*}] [**start-time** {*hh : mm[:ss]* [*month day* | *day month*] | **pending** | **now** | **after** *hh : mm : ss*}] [**ageout** *seconds*] [**recurring**]
  - **ip sla group schedule** *group-operation-number operation-id-numbers schedule-period schedule-period-range* [**ageout** *seconds*] [**frequency** *group-operation-frequency*] [**life**{**forever** | *seconds*}] [**start-time**{*hh:mm[:ss]* [*month day* | *day month*] | **pending** | **now** | **after** *hh:mm:ss*}]
4. **exit**

## DETAILED STEPS

	Command or Action	Purpose
Step 1	<p><b>enable</b></p> <p><b>Example:</b> Router&gt; enable</p>	<p>Enables privileged EXEC mode.</p> <ul style="list-style-type: none"> <li>Enter your password if prompted.</li> </ul>
Step 2	<p><b>configure terminal</b></p> <p><b>Example:</b> Router# configure terminal</p>	<p>Enters global configuration mode.</p>
Step 3	<p>Do one of the following:</p> <ul style="list-style-type: none"> <li><b>ip sla schedule</b> <i>operation-number</i> [<b>life</b> {<b>forever</b>   <i>seconds</i>}] [<b>start-time</b> {<i>hh : mm[: ss]</i> [<i>month day</i>   <i>day month</i>]   <b>pending</b>   <b>now</b>   <b>after</b> <i>hh : mm : ss</i>}] [<b>ageout</b> <i>seconds</i>] [<b>recurring</b>]</li> <li><b>ip sla group schedule</b> <i>group-operation-number</i> <i>operation-id-numbers</i> <b>schedule-period</b> <i>schedule-period-range</i> [<b>ageout</b> <i>seconds</i>] [<b>frequency</b> <i>group-operation-frequency</i>] [<b>life</b>{<b>forever</b>   <i>seconds</i>}] [<b>start-time</b>{<i>hh:mm[:ss]</i> [<i>month day</i>   <i>day month</i>]   <b>pending</b>   <b>now</b>   <b>after</b> <i>hh:mm:ss</i>}]</li> </ul> <p><b>Example:</b> Router(config)# ip sla schedule 10 start-time now life forever</p> <p><b>Example:</b> Router(config)# ip sla group schedule 1 3,4,6-9</p>	<p>Configures the scheduling parameters for an individual IP SLAs operation.</p> <p>Specifies an IP SLAs operation group number and the range of operation numbers to be scheduled for a multi-operation scheduler.</p>
Step 4	<p><b>exit</b></p> <p><b>Example:</b> Router(config)# exit</p>	<p>Exits global configuration mode and enters privileged EXEC mode.</p>

## Verifying the Frame Delay and Synthetic Loss Measurement Configurations

- [Example: Verifying Sender MEP for a Two-Way Delay Measurement Operation, page 11-16](#)
- [Example: Verifying Receiver MEP for a Two-Way Delay Measurement Operation, page 11-16](#)
- [Example: Verifying Sender MEP for a Synthetic Loss Measurement Operation, page 11-17](#)
- [Example: Verifying Ethernet CFM Performance Monitoring, page 11-17](#)
- [Example: Verifying History for IP SLAs Operations, page 11-18](#)

## Example: Verifying Sender MEP for a Two-Way Delay Measurement Operation

The following sample output shows the configuration, including default values, of the sender MEP for a two-way delay measurement operation:

```
Router# show ip sla configuration 10

IP SLAs Infrastructure Engine-III
Entry number: 10
Owner:
Tag:
Operation timeout (milliseconds): 5000
Ethernet Y1731 Delay Operation
Frame Type: DMM
Domain: xxx
Vlan: yyy
Target Mpid: 101
Source Mpid: 100
CoS: 4
  Max Delay: 5000
  Request size (Padding portion): 64
  Frame Interval: 1000
  Clock: Not In Sync
Threshold (milliseconds): 5000
.
.
.
Statistics Parameters
  Aggregation Period: 900
  Frame offset: 1
  Distribution Delay Two-Way:
    Number of Bins 10
    Bin Boundaries: 5000,10000,15000,20000,25000,30000,35000,40000,45000,-1
  Distribution Delay-Variation Two-Way:
    Number of Bins 10
    Bin Boundaries: 5000,10000,15000,20000,25000,30000,35000,40000,45000,-1
History
  Number of intervals: 2
```

## Example: Verifying Receiver MEP for a Two-Way Delay Measurement Operation

The following sample output shows the configuration of the receiver MEP for a two-way delay measurement operation:



### Note

The Cisco ASR 901 router supports hardware-based timestamping. Enable the hardware-based timestamping using the **dmm responder hardware timestamp** command on the receiver MEP.

```
Router-1# show running interface gigabitethernet0/0

interface GigabitEthernet0/0
no ip address
negotiation auto
service instance 1310 ethernet ssvc1310
encapsulation dot1q 1310
rewrite ingress tag pop 1 symmetric
bridge-domain 1310
```



```
cfm mep domain sdmm mpid 1310
dmm responder hardware timestamp
```

## Example: Verifying Sender MEP for a Synthetic Loss Measurement Operation

The following sample output shows the configuration, including default values, of the sender MEP for a single-ended SLM operation with a start-time of now:

```
Router# show ip sla configuration 11

IP SLAs Infrastructure Engine-III
Entry number: 11
Owner:
Tag:
Operation timeout (milliseconds): 5000
Ethernet Y1731 Loss Operation
Frame Type: SLM
Domain: xxx
Vlan: 12
Target Mpid: 34
Source Mpid: 23
CoS: 4
  Request size (Padding portion): 0
  Frame Interval: 1000
Schedule:
  Operation frequency (seconds): 60 (not considered if randomly scheduled)
  Next Scheduled Start Time: Start Time already passed
  Group Scheduled : FALSE
  Randomly Scheduled : FALSE
  Life (seconds): 3600
  Entry Ageout (seconds): never
  Recurring (Starting Everyday): FALSE
  Status of entry (SNMP RowStatus): ActiveThreshold (milliseconds): 5000
Statistics Parameters
  Aggregation Period: 900
  Frame consecutive: 10
  Availability algorithm: static-window
History
  Number of intervals: 2
```

## Example: Verifying Ethernet CFM Performance Monitoring

To view the Ethernet CFM performance monitoring activities, use the **show ethernet cfm pm** command.

```
Router# show ethernet cfm pm session summary
Number of Configured Session : 4
Number of Active Session: 4
Number of Inactive Session: 0

Router# show ethernet cfm pm session detail 1
Session ID: 1
Sla Session ID: 2002
Level: 5
Service Type: BD-V
Service Id: 1000
Direction: Down
Source Mac: 4055.3989.736d
Destination Mac: 4055.3989.6c01
Session Version: 0
Session Operation: On-demand
```

```

Session Status: Active
MPID: 1000
Tx active: yes
Rx active: yes
RP monitor Tx active: yes
RP monitor Rx active: yes
Timeout timer: stopped
Last clearing of counters: *13:39:29.070 IST Mon Mar 18 2013
DMMs:
  Transmitted: 0
DMRs:
  Rcvd: 0
1DMs:
  Transmitted: 0
  Rcvd: 0
LMMs:
  Transmitted: 0
LMRs:
  Rcvd: 0
VSMs:
  Transmitted: 0
VSRs:
  Rcvd: 0
SLMs:
  Transmitted: 517100
SLRs:
  Rcvd: 517098

```

## Example: Verifying History for IP SLAs Operations

To view the history collected for IP SLAs operations, use the **show ip sla history** command.



### Note

The **show ip sla history full** command is not supported for the ITU-T Y.1731 operations.

```

Router# show ip sla history interval-statistics
Loss Statistics for Y1731 Operation 2001
Type of operation: Y1731 Loss Measurement
Latest operation start time: *13:48:39.055 IST Tue Mar 19 2013
Latest operation return code: OK
Distribution Statistics:

Interval 1
Start time: *13:48:39.055 IST Tue Mar 19 2013
End time: *13:48:59.055 IST Tue Mar 19 2013
Number of measurements initiated: 198
Number of measurements completed: 198
Flag: OK

Forward
Number of Observations 19
Available indicators: 19
Unavailable indicators: 0
Tx frame count: 190
Rx frame count: 190
  Min/Avg/Max - (FLR % ): 0:9/000.00%/0:9
Cumulative - (FLR % ): 000.0000%
Timestamps forward:
  Min - *13:48:58.084 IST Tue Mar 19 2013

```

```

Max - *13:48:58.084 IST Tue Mar 19 2013
Backward
Number of Observations 19
Available indicators: 19
Unavailable indicators: 0
Tx frame count: 190
Rx frame count: 190
Min/Avg/Max - (FLR % ): 0:9/000.00%/0:9
Cumulative - (FLR % ): 000.0000%
Timestamps backward:
Min - *13:48:58.084 IST Tue Mar 19 2013
Max - *13:48:58.084 IST Tue Mar 19 2013

```

## How to Configure IP SLAs Y.1731 On-Demand and Concurrent Operations

- [Configuring Direct On-Demand Operation on a Sender MEP, page 11-19](#)
- [Configuring Referenced On-Demand Operation on a Sender MEP, page 11-20](#)
- [Configuring IP SLAs Y.1731 Concurrent Operation on a Sender MEP, page 11-21](#)

### Configuring Direct On-Demand Operation on a Sender MEP

#### Prerequisites

Class of Service (CoS)-level monitoring must be enabled on MEPs associated to the Ethernet frame loss operation using the **monitor loss counter** command on the devices at both ends of the operation.



#### Note

Cisco IOS Y.1731 implementation allows monitoring of frame loss for frames on an EVC regardless of the CoS value (any CoS or Aggregate CoS cases).

#### SUMMARY STEPS

1. **enable**
2. **ip sla on-demand ethernet slm domain** *domain-name* {**evc** *evc-id* | **vlan** *vlan-id*} {**mpid** *target-mp-id* | **mac-address** *target-address*} **cos** *cos* {**source** {**mpid** *source-mp-id* | **mac-address** *source-address*}} {**continuous** [**interval** *milliseconds*] | **burst** [**interval** *milliseconds*] [**number** *number-of-frames*] [**frequency** *seconds*]} [**size** *bytes*] **aggregation** *seconds* {**duration** *seconds* | **max** *number-of-packets*}

## DETAILED STEPS

	Command or Action	Purpose
Step 1	<p><b>enable</b></p> <p><b>Example:</b> Router&gt; enable</p>	<p>Enables privileged EXEC mode.</p> <ul style="list-style-type: none"> <li>Enter your password if prompted.</li> </ul>
Step 2	<p><b>ip sla on-demand ethernet slm domain</b> <i>domain-name</i> {<b>evc</b> <i>evc-id</i>   <b>vlan</b> <i>vlan-id</i>} {<b>mpid</b> <i>target-mp-id</i>   <b>mac-address</b> <i>target-address</i>} <b>cos</b> <i>cos</i> {<b>source</b> {<b>mpid</b> <i>source-mp-id</i>   <b>mac-address</b> <i>source-address</i>}}</p> <p>{<b>continuous</b> [<b>interval</b> <i>milliseconds</i>]   <b>burst</b> [<b>interval</b> <i>milliseconds</i>] [<b>number</b> <i>number-of-frames</i>] [<b>frequency</b> <i>seconds</i>]} [<b>size</b> <i>bytes</i>] <b>aggregation</b> <i>seconds</i> {<b>duration</b> <i>seconds</i>   <b>max</b> <i>number-of-packets</i>}</p> <p><b>Example:</b> Router# ip sla on-demand ethernet SLM domain xxx vlan 12 mpid 34 cos 4 source mpid 23 continuous aggregation 10 duration 60</p>	<p>Creates and runs an on-demand operation in direct mode.</p> <p>Repeat this step for each on-demand operation to be run.</p>

## Configuring Referenced On-Demand Operation on a Sender MEP

## Prerequisites

Single-ended and concurrent Ethernet delay, or delay variation, and frame loss operations to be referenced must be configured.

## SUMMARY STEPS

- enable
- ip sla on-demand ethernet slm *operation number* {**duration** *seconds* | **max** *number-of-packets*}

## DETAILED STEPS

	Command or Action	Purpose
Step 1	<p><b>enable</b></p> <p><b>Example:</b> Router&gt; enable</p>	<p>Enables privileged EXEC mode.</p> <ul style="list-style-type: none"> <li>Enter your password if prompted.</li> </ul>
Step 2	<p><b>ip sla on-demand ethernet slm</b> <i>operation number</i> {<b>duration</b> <i>seconds</i>   <b>max</b> <i>number-of-packets</i>}</p> <p><b>Example:</b> Router# ip sla on-demand ethernet slm 11</p>	<p>Creates and runs a pseudo operation of the operation being referenced, in the background.</p> <p>Repeat this step for each on-demand operation to be run.</p>

## Configuring IP SLAs Y.1731 Concurrent Operation on a Sender MEP

To configure concurrent Ethernet delay, and delay variation, and frame loss operations, see the [“How to Configure ITU-T Y.1731 Performance Monitoring”](#) section on page 11-5.

## Configuration Examples for IP SLAs Y.1731 On-Demand Operations

- [Example: On-Demand Operation in Direct Mode, page 11-21](#)
- [Example: On-Demand Operation in Referenced Mode, page 11-22](#)

### Example: On-Demand Operation in Direct Mode

```
Router# ip sla on-demand ethernet slm domain md5 evc evc1000 mpid 1000 cos 1 source mpid
1001 continuous aggregation 30 duration 31
```

```
Loss Statistics for Y1731 Operation 3313031511
Type of operation: Y1731 Loss Measurement
Latest operation start time: *13:21:23.995 IST Tue Mar 19 2013
Latest operation return code: OK
Distribution Statistics:
```

```
Interval
Start time: *13:21:23.995 IST Tue Mar 19 2013
End time: *13:21:53.988 IST Tue Mar 19 2013
Number of measurements initiated: 30
Number of measurements completed: 30
Flag: OK
```

```
Forward
Number of Observations 3
Available indicators: 0
Unavailable indicators: 3
Tx frame count: 30
Rx frame count: 30
Min/Avg/Max - (FLR % ): 0:9/000.00%/0:9
Cumulative - (FLR % ): 000.0000%
Timestamps forward:
Min - *13:21:53.030 IST Tue Mar 19 2013
Max - *13:21:53.030 IST Tue Mar 19 2013
```

```
Backward
Number of Observations 3
Available indicators: 0
Unavailable indicators: 3
Tx frame count: 30
Rx frame count: 30
Min/Avg/Max - (FLR % ): 0:9/000.00%/0:9
Cumulative - (FLR % ): 000.0000%
Timestamps backward:
Min - *13:21:53.030 IST Tue Mar 19 2013
Max - *13:21:53.030 IST Tue Mar 19 2013
```

## Example: On-Demand Operation in Referenced Mode

```

Router# configure terminal
Router(config)# ip sla 2002
Router(config-ip-sla)# ethernet y1731 loss SLM domain md5 evc evc1000 mpid 1001 cos 3
source mpid 1000
Router(config-sla-y1731-loss)# aggregate interval 30
Router(config-sla-y1731-loss)# end
Router# ip sla on-demand ethernet slm 2002 duration 31

```

```

Loss Statistics for Y1731 Operation 3313031511
Type of operation: Y1731 Loss Measurement
Latest operation start time: *13:21:23.995 IST Tue Mar 19 2013
Latest operation return code: OK
Distribution Statistics:

```

```

Interval
Start time: *13:21:23.995 IST Tue Mar 19 2013
End time: *13:21:53.988 IST Tue Mar 19 2013
Number of measurements initiated: 30
Number of measurements completed: 30
Flag: OK

```

```

Forward
Number of Observations 3
Available indicators: 0
Unavailable indicators: 3
Tx frame count: 30
Rx frame count: 30
Min/Avg/Max - (FLR % ): 0:9/000.00%/0:9
Cumulative - (FLR % ): 000.0000%
Timestamps forward:
Min - *13:21:53.030 IST Tue Mar 19 2013
Max - *13:21:53.030 IST Tue Mar 19 2013

```

```

Backward
Number of Observations 3
Available indicators: 0
Unavailable indicators: 3
Tx frame count: 30
Rx frame count: 30
Min/Avg/Max - (FLR % ): 0:9/000.00%/0:9
Cumulative - (FLR % ): 000.0000%
Timestamps backward:
Min - *13:21:53.030 IST Tue Mar 19 2013
Max - *13:21:53.030 IST Tue Mar 19 2013

```

# Additional References

The following sections provide references to ITU-T Y.1731 Performance Monitoring.

## Related Documents

Related Topic	Document Title
Cisco IOS Commands	<i>Cisco IOS Master Commands List, All Releases</i>
Cisco IOS IP SLAs commands	<i>Cisco IOS IP SLAs Command Reference</i>
IEEE CFM	<i>Configuring IEEE Standard-Compliant Ethernet CFM in a Service Provider Network</i>
Using OAM	<i>Using Ethernet Operations, Administration, and Maintenance</i>
IEEE CFM and Y.1731 commands	<i>Cisco IOS Carrier Ethernet Command Reference</i>

## Standards

Standard	Title
IEEE 802.1ag	<i>802.1ag - Connectivity Fault Management</i>
ITU-T Y.1731	<i>ITU-T Y.1731 OAM Mechanisms for Ethernet-Based Networks</i>
MEF 17	<i>Service OAM Requirements &amp; Framework - Phase 1</i>

## MIBs

MIB	MIBs Link
CISCO-IPSLA-ETHERNET-MIB CISCO-RTTMON-MIB	To locate and download MIBs for selected platforms, Cisco IOS releases, and feature sets, use Cisco MIB Locator found at the following URL:  <a href="http://www.cisco.com/go/mibs">http://www.cisco.com/go/mibs</a>

## RFCs

RFC	Title
None	—

## Technical Assistance

Description	Link
The Cisco Technical Support website contains thousands of pages of searchable technical content, including links to products, technologies, solutions, technical tips, and tools. Registered Cisco.com users can log in from this page to access even more content.	<a href="http://www.cisco.com/cisco/web/support/index.html">http://www.cisco.com/cisco/web/support/index.html</a>



# Feature Information for ITU-T Y.1731 Performance Monitoring

Table 11-1 lists the features in this module and provides links to specific configuration information.

Use Cisco Feature Navigator to find information about platform support and software image support. Cisco Feature Navigator enables you to determine which software images support a specific software release, feature set, or platform. To access Cisco Feature Navigator, go to <http://www.cisco.com/go/cfn>. An account on Cisco.com is not required.

**Note**

Table 11-1 lists only the software release that introduced support for a given feature in a given software release train. Unless noted otherwise, subsequent releases of that software release train also support that feature.

**Table 11-1** Feature Information for ITU-T Y.1731 Performance Monitoring

Feature Name	Releases	Feature Information
Y.1731 Performance Monitoring	15.3(2)S	This feature was introduced on the Cisco ASR 901 router. The following sections provide information about this feature: <ul style="list-style-type: none"> <li>• <a href="#">Information About ITU-T Y.1731 Performance Monitoring, page 11-2</a></li> <li>• <a href="#">How to Configure ITU-T Y.1731 Performance Monitoring, page 11-5</a></li> <li>• <a href="#">Verifying the Frame Delay and Synthetic Loss Measurement Configurations, page 11-15</a></li> </ul>
Ethernet Synthetic Loss Measurement in Y.1731	15.3(2)S	This feature was introduced on the Cisco ASR 901 router. The following sections provide information about this feature: <ul style="list-style-type: none"> <li>• <a href="#">Information About ITU-T Y.1731 Performance Monitoring, page 11-2</a></li> <li>• <a href="#">Configuring Single-Ended Synthetic Loss Measurement, page 11-9</a></li> <li>• <a href="#">Verifying the Frame Delay and Synthetic Loss Measurement Configurations, page 11-15</a></li> </ul>
Y.1731 Performance Monitoring	15.3(3)S	The Cisco ASR 901 router supports ITU-T Y.1731 performance monitoring on the following interfaces: <ul style="list-style-type: none"> <li>–SLM support on the EVC cross connect</li> <li>–SLM support on the Port-Channel EVC cross connect</li> <li>–DMM and SLM support on the EVC BD for both the up and down MEPs</li> <li>–SLM support on the EVC cross connect for both the up and down MEPs</li> </ul>





# Configuring Resilient Ethernet Protocol

---

Resilient Ethernet Protocol (REP) is a Cisco proprietary protocol that provides an alternative to Spanning Tree Protocol (STP) to control network loops, to respond to link failures, and to improve convergence time. REP controls a group of ports connected in a segment, ensures that the segment does not create any bridging loops, and responds to link failures within the segment. REP provides a basis for constructing more complex networks and supports VLAN load balancing. Effective with Cisco IOS Release 15.4(1)S, the Cisco ASR 901 supports REP over port-channel.

## Contents

- [Understanding Resilient Ethernet Protocol \(REP\), page 12-1](#)
- [Configuring Resilient Ethernet Protocol \(REP\), page 12-7](#)
- [Configuration Examples for REP, page 12-24](#)

## Understanding Resilient Ethernet Protocol (REP)

This section contains the following topics:

- [Overview](#)
- [Restrictions, page 12-3](#)
- [Link Integrity](#)
- [Fast Convergence](#)
- [VLAN Load Balancing \(VLB\)](#)
- [REP Ports](#)

## Overview

An REP segment is a chain of ports connected to each other and configured with a segment ID. Each segment consists of standard (non-edge) segment ports and two user-configured edge ports. A switch can have only two ports belonging to the same segment, and each segment port can have only one external neighbor. A segment can go through a shared medium, but on any link, only two ports can belong to the same segment. REP is supported only on Layer 2 trunk interfaces.

Figure 12-1 shows an example of a segment consisting of six ports spread across four switches. Ports E1 and E2 are configured as edge ports. When all ports are operational (as in the segment on the left), a single port is blocked, shown by the diagonal line. When there is a network failure, as shown on the right of the diagram, the blocked port returns to the forwarding state to minimize network disruption.

Figure 12-1 REP Open Segments

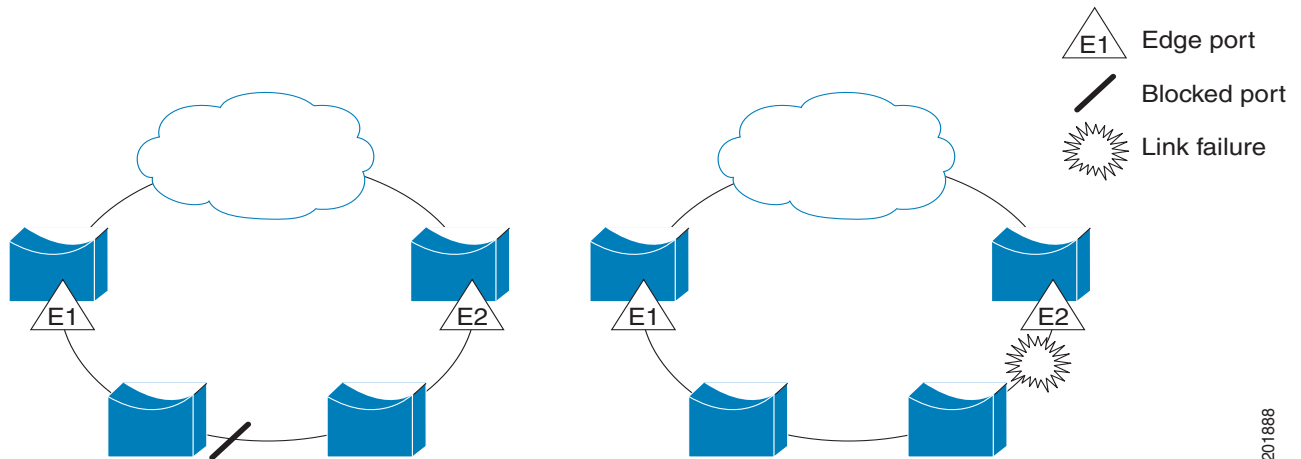

The segment shown in Figure 12-1 is an open segment; there is no connectivity between the two edge ports. The REP segment cannot cause a bridging loop, and you can safely connect the segment edges to any network. All hosts connected to switches inside the segment have two possible connections to the rest of the network through the edge ports, but only one connection is accessible at any time. If a host cannot access its usual gateway because of a failure, REP unblocks all ports to ensure that connectivity is available through the other gateway.

The segment shown in Figure 12-2, with both edge ports located on the same switch, is a ring segment. In this configuration, there is connectivity between the edge ports through the segment. With this configuration, you can create a redundant connection between any two switches in the segment.

Figure 12-2 REP Ring Segment

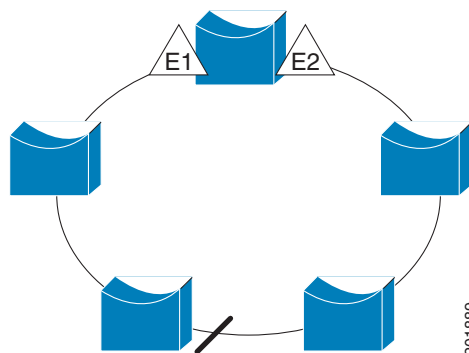

REP segments have these characteristics:

- If all ports in the segment are operational, one port (referred to as the *alternate* port) is in the blocked state for each VLAN.
- If VLAN load balancing is configured, two ports in the segment control the blocked state of VLANs.

- If one or more ports in a segment is not operational, causing a link failure, all ports forward traffic on all VLANs to ensure connectivity.
- In case of a link failure, the alternate ports are unblocked as quickly as possible. When the failed link comes back up, a logically blocked port per VLAN is selected with minimal disruption to the network.

You can construct almost any type of network based on REP segments. REP also supports VLAN load-balancing, controlled by the primary edge port but occurring at any port in the segment.

In access ring topologies, the neighboring switch might not support REP, as shown in [Figure 12-3](#). In this case, you can configure the non-REP facing ports (E1 and E2) as edge no-neighbor ports. These ports inherit all properties of edge ports, and you can configure them the same as any edge port, including configuring them to send STP or REP topology change notices to the aggregation switch. In this case the STP topology change notice (TCN) that is sent is a multiple spanning-tree (MST) STP message.

**Figure 12-3** No-neighbor Topology

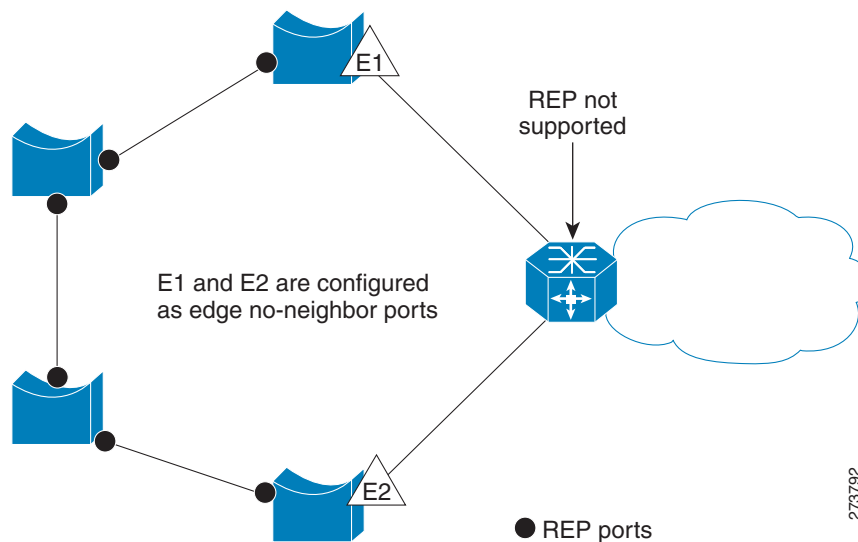

## Restrictions

- You must configure each segment port; an incorrect configuration can cause forwarding loops in the networks.
- REP can manage only a single failed port within the segment; multiple port failures within the REP segment cause loss of network connectivity.
- You should configure REP only in networks with redundancy. Configuring REP in a network without redundancy causes loss of connectivity.

## Link Integrity

REP does not use an end-to-end polling mechanism between edge ports to verify link integrity. It implements local link failure detection. The REP Link Status Layer (LSL) detects its REP-aware neighbor and establishes connectivity within the segment. All VLANs are blocked on an interface until it detects the neighbor. After the neighbor is identified, REP determines which neighbor port should become the alternate port and which ports should forward traffic.

Each port in a segment has a unique port ID. The port ID format is similar to that used by the spanning tree algorithm: a port number (unique on the bridge), associated to a MAC address (unique in the network). When a segment port is coming up, its LSL starts sending packets that include the segment ID and the port ID. The port is declared operational after it performs a three-way handshake with a neighbor in the same segment.

A segment port does not become operational if:

- No neighbor has the same segment ID.
- More than one neighbor has the same segment ID.
- The neighbor does not acknowledge the local port as a peer.

Each port creates an adjacency with its immediate neighbor. After the neighbor adjacencies are created, the ports negotiate to determine one blocked port for the segment, the alternate port. All other ports become unblocked. By default, REP packets are sent to a BPDU class MAC address. The packets are dropped by devices not running REP.

## Fast Convergence

Because REP runs on a physical link basis and not a per-VLAN basis, only one hello message is required for all VLANs, reducing the load on the protocol. We recommend that you create VLANs consistently on all switches in a given segment and configure the same allowed VLANs on the REP trunk ports. To avoid the delay introduced by relaying messages in software, REP also allows some packets to be flooded to a regular multicast address. These messages operate at the hardware flood layer (HFL) and are flooded to the whole network, not just the REP segment. Switches that do not belong to the segment treat them as data traffic. You can control flooding of these messages by configuring a dedicated administrative VLAN for the whole domain.

The estimated convergence recovery time on fiber interfaces is less than 200 ms for the local segment with 200 VLANs configured. Convergence for VLAN load balancing is 300 ms or less.

## VLAN Load Balancing (VLB)

One edge port in the REP segment acts as the primary edge port; the other as the secondary edge port. The primary edge port always participates in VLAN load balancing in the segment. REP VLAN balancing is achieved by blocking some VLANs at a configured alternate port and all other VLANs at the primary edge port. When you configure VLAN load balancing, you can specify the alternate port in one of three ways:

- Enter the port ID of the interface. To identify the port ID of a port in the segment, use the **show interface rep detail** interface configuration command for the port.

**Note**

Use **rep platform vld segment** command on every Cisco ASR 901 router participating in the REP segment.

- Enter the neighbor offset number of a port in the segment, which identifies the downstream neighbor port of an edge port. The neighbor offset number range is  $-256$  to  $+256$ ; a value of 0 is invalid. The primary edge port has an offset number of 1; positive numbers above 1 identify downstream neighbors of the primary edge port. Negative numbers identify the secondary edge port (offset number -1) and its downstream neighbors.

**Note**

You configure offset numbers on the primary edge port by identifying the downstream position from the primary (or secondary) edge port. Do not enter an offset value of 1 because that is the offset number of the primary edge port.

Figure 12-4 shows neighbor offset numbers for a segment where E1 is the primary edge port and E2 is the secondary edge port. The red numbers inside the ring are numbers offset from the primary edge port; the black numbers outside the ring show the offset numbers from the secondary edge port. Note that you can identify all ports (except the primary edge port) by either a positive offset number (downstream position from the primary edge port) or a negative offset number (downstream position from the secondary edge port). If E2 became the primary edge port, its offset number would then be 1, and E1 would be -1.

- By entering the **preferred** keyword to select the port that you previously configured as the preferred alternate port with the **rep segment segment-id preferred** interface configuration command.

**Figure 12-4 Neighbor Offset Numbers in a Segment**

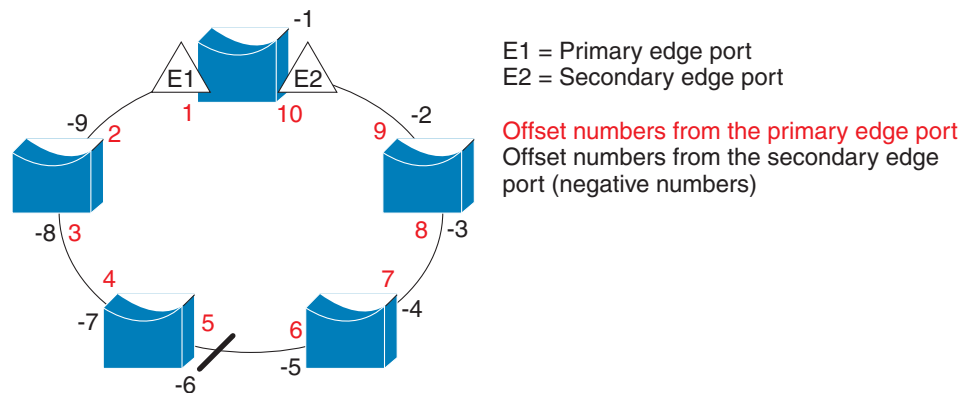

201890

When the REP segment is complete, all VLANs are blocked. When you configure VLAN load balancing, you must also configure triggers in one of two ways:

- Manually trigger VLAN load balancing at any time by entering the **rep preempt segment segment-id** privileged EXEC command on the router that has the primary edge port.
- Configure a preempt delay time by entering the **rep preempt delay seconds** interface configuration command. After a link failure and recovery, VLAN load balancing begins after the configured preemption time period elapses. Note that the delay timer restarts if another port fails before the time elapses.

**Note**

When VLAN load balancing is configured, it does not start working until triggered by either manual intervention or a link failure and recovery.

When VLAN load balancing is triggered, the primary edge port sends a message to alert all interfaces in the segment about the preemption. When the secondary port receives the message, it is reflected into the network to notify the alternate port to block the set of VLANs specified in the message and to notify the primary edge port to block the remaining VLANs.

You can also configure a particular port in the segment to block all VLANs. Only the primary edge port initiates VLAN load balancing, which is not possible if the segment is not terminated by an edge port on each end. The primary edge port determines the local VLAN load balancing configuration.

Reconfigure the primary edge port to reconfigure load balancing. When you change the load balancing configuration, the primary edge port again waits for the **rep preempt segment** command or for the configured preempt delay period after a port failure and recovery before executing the new configuration. If you change an edge port to a regular segment port, the existing VLAN load balancing status does not change. Configuring a new edge port might cause a new topology configuration.

**Spanning Tree Interaction**

REP does not interact with MSTP, but the two can coexist. A port that belongs to a segment is removed from spanning tree control, and STP BPDUs are not accepted or sent from segment ports.

To migrate from an STP ring configuration to REP segment configuration, begin by configuring a single port in the ring as part of the segment, and continue by configuring contiguous ports to minimize the number of segments. Each segment always contains a blocked port, so multiple segments means multiple blocked ports and a potential loss of connectivity. When the segment is configured in both directions to the edge ports, you then configure the edge ports.

**REP Ports**

Ports in REP segments are in the Failed, Open, or Alternate states. The various states REP ports go through are as follows:

- A port configured as a regular segment port starts as a failed port.
- After the neighbor adjacencies are determined, the port changes to alternate port state, blocking all VLANs on the interface. Blocked port negotiations occur and when the segment settles, one blocked port remains in the alternate role, and all other ports become open ports.
- When a failure occurs in a link, all ports move to the open state. When the alternate port receives the failure notification, it changes to the open state, forwarding all VLANs.

A regular segment port converted to an edge port, or an edge port converted to a regular segment port, does not always result in a topology change. If you convert an edge port into a regular segment port, VLAN load balancing is not implemented unless it has been configured. For VLAN load balancing, you must configure two edge ports in the segment.

A segment port reconfigured as a spanning tree port restarts according to the spanning tree configuration. By default, this is a designated blocking port. If PortFast is configured or if STP is disabled, the port goes into the forwarding state.

For instructions on how to configure REP, see [Configuring Resilient Ethernet Protocol \(REP\), page 12-7](#).



# Configuring Resilient Ethernet Protocol (REP)

A segment is a collection of ports connected one to the other in a chain and configured with a segment ID. To configure REP segments, you configure the REP administrative VLAN (or use the default VLAN 1) and then add the ports to the segment using interface configuration mode. You should configure a service instance with encapsulation corresponding to the REP admin VLAN and associate it to arbitrary bridge domain.

**Note**

The explicit configuration of EFP gives you the flexibility to choose the bridge domain of your choice.

You should configure two edge ports in the segment, one as the primary edge port and the other, by default, the secondary edge port. A segment has only one primary edge port. If you configure two ports in a segment as the primary edge port, for example ports on different switches, the REP selects one to serve as the segment primary edge port. You can also optionally configure where to send segment topology change notices (STCNs) and VLAN load balancing messages.

This section contains the following topics:

- [Default REP Configuration, page 12-7](#)
- [REP Configuration Guidelines, page 12-7](#)
- [Configuring the REP Administrative VLAN, page 12-9](#)
- [Configuring REP Interfaces, page 12-10](#)
- [Configuring REP as Dual Edge No-Neighbor Port, page 12-15](#)
- [Setting up Manual Preemption for VLAN Load Balancing, page 12-20](#)
- [Configuring SNMP Traps for REP, page 12-21](#)
- [Monitoring REP, page 12-22](#)

## Default REP Configuration

By default, REP is disabled on all interfaces. When enabled, the interface is a regular segment port, unless it is configured as an edge port.

When REP is enabled, the sending of segment topology change notices (STCNs) is disabled, all VLANs are blocked, and the administrative VLAN is VLAN 1.

When VLAN load balancing is enabled, the default is manual preemption with the delay timer disabled. If VLAN load balancing is not configured, the default after manual preemption is to block all VLANs at the primary edge port.

## REP Configuration Guidelines

Follow these guidelines when configuring REP:

- We recommend that you begin by configuring one port and then configure the contiguous ports to minimize the number of segments and the number of blocked ports.
- If more than two ports in a segment fail when no external neighbors are configured, one port goes into a forwarding state for the data path to help maintain connectivity during configuration. In the **show rep interface** command output, the Port Role for this port shows as *Fail Logical Open*; the

Port Role for the other failed port shows as *Fail No Ext Neighbor*. When the external neighbors for the failed ports are configured, the ports go through the alternate port state transitions and eventually go to an open state or remain as the alternate port, based on the alternate port election mechanism.

- REP ports must be Layer 2 ports.
- Be careful when configuring REP through a Telnet connection. Since REP blocks all VLANs until another REP interface sends a message to unblock the VLAN, you might lose connectivity to the router if you enable REP in a Telnet session that accesses the router through the REP interface.
- If you connect an STP network to the REP segment, be sure that the connection is at the segment edge. An STP connection that is not at the edge could cause a bridging loop because STP does not run on REP segments. All STP BPDUs are dropped at REP interfaces.
- You must configure all ports in the segment with the same set of allowed VLANs, or a misconfiguration occurs.
- REP ports follow these rules:
  - There is no limit to the number of REP ports on a switch; however, only two ports on a switch can belong to the same REP segment.
  - If only one port on a switch is configured in a segment, the port should be an edge port.
  - If two ports on a switch belong to the same segment, they must be both edge ports, both regular segment ports, or one regular port and one edge no-neighbor port. An edge port and regular segment port on a switch cannot belong to the same segment.
  - If two ports on a switch belong to the same segment and one is configured as an edge port and one as a regular segment port (a misconfiguration), the edge port is treated as a regular segment port.
- REP interfaces come up and remain in a blocked state until notified that it is safe to unblock. You need to be aware of this to avoid sudden connection losses.
- You should configure service instance with encapsulation corresponding to the REP admin VLAN and associate it to arbitrary Bridge Domain. This explicit configuration of EFP gives you the flexibility to choose the bridge domain of your choice.
- REP sends all LSL PDUs in untagged frames on the native VLAN. The BPA message sent to the Cisco multicast address is sent on the administration VLAN, which is VLAN 1 by default.
- You can configure how long a REP interface remains up without receiving a hello from a neighbor. You can use the **rep lsl-age-timer** *value* interface configuration command to set the time from 120 ms to 10000 ms. The LSL hello timer is then set to the age-timer value divided by three. In normal operation, three LSL hellos are sent before the age timer on the peer switch expires and searches for hello messages.
- You can configure how long a REP interface remains up without receiving a hello from a neighbor. You can use the **rep lsl-age-timer** *value* interface configuration command to set the time from 120 ms to 10000 ms. The LSL hello timer is then set to the age-timer value divided by three. In normal operation, three LSL hellos are sent before the age timer on the peer switch expires and searches for hello messages.
- REP ports cannot be configured as one of these port types:
  - SPAN destination port
  - Private VLAN
  - Tunnel port
  - Access port
- There is a maximum of 128 REP segments per router.

## Configuring the REP Administrative VLAN

To avoid the delay introduced by relaying messages in software for link-failure or VLAN-blocking notification during load balancing, REP floods packets at the hardware flood layer (HFL) to a regular multicast address. These messages are flooded to the whole network, not just the REP segment. You can control flooding of these messages by configuring an administrative VLAN for the whole domain.

Follow these guidelines when configuring the REP administrative VLAN:

- If you do not configure an administrative VLAN, the default is VLAN 1.
- There can be only one administrative VLAN on a router and on a segment. However, this is not enforced by the software.
- For VLB to work, **rep platform vlb** has to be configured on every Cisco ASR 901router participating in the segment.

Complete the following steps to configure the REP administrative VLAN:

### SUMMARY STEPS

1. **enable**
2. **configure terminal**
3. **rep admin vlan *vlan-id***
4. **end**
5. **show interface [*interface-id*] rep [detail]**
6. **copy running-config startup config**

### DETAILED STEPS

	Command	Purpose
Step 1	<b>enable</b>  <b>Example:</b> Router> <b>enable</b>	Enables privileged EXEC mode.  • Enter your password if prompted.
Step 2	<b>configure terminal</b>  <b>Example:</b> Router# <b>configure terminal</b>	Enters global configuration mode.
Step 3	<b>rep admin vlan <i>vlan-id</i></b>  <b>Example:</b> Router(config)# <b>rep admin vlan 1</b>	Configures a REP administrative VLAN.  • Specify the administrative VLAN. The range is 1–4094. The default is VLAN 1.
Step 4	<b>end</b>  <b>Example:</b> Router(config)# <b>end</b>	Returns to privileged EXEC mode.

	Command	Purpose
Step 5	<pre>show interface [interface-id] rep [detail]</pre> <p><b>Example:</b> Router# <code>show interface gigabitethernet0/1 rep detail</code></p>	Displays the REP configuration and status for a specified interface. <ul style="list-style-type: none"> <li>Enter the physical Layer 2 interface or port channel (logical interface) and the optional detail keyword, if desired.</li> </ul>
Step 6	<pre>copy running-config startup config</pre> <p><b>Example:</b> Router# <code>copy running-config startup config</code></p>	(Optional) Saves your entries in the router startup configuration file.

## Configuring REP Interfaces

For REP operation, you need to enable it on each segment interface and identify the segment ID. This step is required and must be done before other REP configuration. You must also configure a primary and secondary edge port on each segment. All other steps are optional.

Complete these steps to enable and configure REP on an interface:

### SUMMARY STEPS

- enable
- configure terminal
- interface *interface-id*
- service instance *<instance-id>* ethernet encap dot1q *<admin-vlan>* rewrite ingress tag pop 1 symmetric bridge-domain *<bd-id>*
- rep segment *segment-id* [edge [no-neighbor] [primary]] [preferred]
- rep lsl-retries *number-of-retries*
- rep stcn {interface *interface-id* | segment *id-list* | stp}
- rep platform vlb segment *segment-id* vlan {*vlan-list*|all}
- rep block port {id *port-id* | neighbor-offset | preferred} vlan {*vlan-list* | all}
- rep preempt delay *seconds*
- rep lsl-age-timer *value*
- end
- show interface [*interface-id*] rep [detail]
- show rep topology [segment *segment-id*] [archive] [detail]
- copy running-config startup config

## DETAILED STEPS

	Command	Purpose
Step 1	<b>enable</b>  <b>Example:</b> Router> <b>enable</b>	Enables privileged EXEC mode. <ul style="list-style-type: none"> <li>• Enter your password if prompted.</li> </ul>
Step 2	<b>configure terminal</b>  <b>Example:</b> Router# <b>configure terminal</b>	Enters global configuration mode.
Step 3	<b>interface</b> <i>interface-id</i>  <b>Example:</b> Router(config)# <b>interface</b> <b>gigabitethernet0/1</b> Router(config)# <b>interface port-channel 1</b>	Specifies the interface, and enters interface configuration mode. <ul style="list-style-type: none"> <li>• Enter the physical Layer 2 interface or port channel ID. The port-channel range is 1 to 8.</li> </ul>
Step 4	<b>service instance</b> <i>&lt;instance-id&gt;</i> <b>ethernet encap dot1q</b> <i>&lt;admin-vlan&gt;</i> <b>rewrite ingress tag pop 1 symmetric</b> <b>bridge-domain</b> <i>&lt;bd-id&gt;</i>  <b>Example:</b> Router(config-if)# <b>service instance 1</b> <b>ethernet encap dot1q 1</b> <b>rewrite ingress tag pop 1 symmetric</b> <b>bridge-domain 1</b>	Configures ethernet virtual circuit for the administrative VLAN.

Command	Purpose
<p><b>Step 5</b> <code>rep segment <i>segment-id</i> [edge [no-neighbor] [primary]] [preferred]</code></p> <p><b>Example:</b>  Router(config-if)# <code>rep segment 1 edge preferred</code></p>	<p>Enables REP on the interface, and identifies a segment number. The segment ID range is from 1 to 1024.</p> <p><b>Note</b> You must configure two edge ports, including one primary edge port for each segment.</p> <p>These are the optional keywords:</p> <ul style="list-style-type: none"> <li>• Enter the <b>edge</b> keyword to configure the port as an edge port. Entering <b>edge</b> without the <b>primary</b> keyword configures the port as the secondary edge port. Each segment has only two edge ports.</li> <li>• (Optional) Enter the <b>no-neighbor</b> keyword to configure a port with no external REP neighbors as an edge port. The port inherits all properties of edge ports, and you can configure them the same as any edge port.</li> <li>• On an edge port, enter the <b>primary</b> keyword to configure the port as the primary edge port, the port on which you can configure VLAN load balancing.</li> </ul> <p><b>Note</b> Although each segment can have only one primary edge port, if you configure edge ports on two different switches and enter the <b>primary</b> keyword on both switches, the configuration is allowed. However, REP selects only one of these ports as the segment primary edge port. You can identify the primary edge port for a segment by entering the <b>show rep topology</b> privileged EXEC command.</p> <ul style="list-style-type: none"> <li>• Enter the <b>preferred</b> keyword to indicate that the port is the preferred alternate port or the preferred port for VLAN load balancing.</li> </ul> <p><b>Note</b> Configuring a port as preferred does not guarantee that it becomes the alternate port; it merely gives it a slight edge among equal contenders. The alternate port is usually a previously failed port.</p>
<p><b>Step 6</b> <code>rep lsl-retries <i>number-of-retries</i></code></p> <p><b>Example:</b>  Router(config-if)# <code>rep lsl-retries 4</code></p>	<p>Use the <b>rep lsl-retries</b> command to configure the REP link status layer (LSL) number of retries before the REP link is disabled.</p>
<p><b>Step 7</b> <code>rep stcn {interface <i>interface-id</i>   segment <i>id-list</i>   stp}</code></p> <p><b>Example:</b>  Router(config-if)# <code>rep stcn segment 2-5</code></p>	<p>(Optional) Configures the edge port to send segment topology change notices (STCNs).</p> <ul style="list-style-type: none"> <li>• Enter <b>interface <i>interface-id</i></b> to designate a physical Layer 2 interface or port channel to receive STCNs.</li> <li>• Enter <b>segment <i>id-list</i></b> to identify one or more segments to receive STCNs. The range is from 1–1024.</li> <li>• Enter <b>stp</b> to send STCNs to STP networks.</li> </ul>

Command	Purpose
<p><b>Step 8</b> <code>rep platform vlb segment segment-id vlan {vlan-list all}</code></p> <p><b>Example:</b>  Router(config)# <code>rep platform vlb segment 1 vlan 100-200</code></p>	<p>(Optional) Configures the VLAN list which forms the VLB group. This command should be issued on all Cisco ASR 901 routers participating in VLB for a particular segment and should have a matching VLAN list. This VLAN list should also match with the <b>rep block</b> command issued on primary edge port.</p> <ul style="list-style-type: none"> <li>• Enter <b>vlan</b> <i>vlan-list</i> to block a single VLAN or a range of VLANs,</li> <li>• Enter <b>vlan all</b> to block all VLANs. This is the default configuration.</li> </ul>
<p><b>Step 9</b> <code>rep block port {id port-id   neighbor-offset   preferred} vlan {vlan-list   all}</code></p> <p><b>Example:</b>  Router(config-if)# <code>rep block port 0009001818D68700 vlan all</code></p>	<p>(Optional) Configures VLAN load balancing on the primary edge port, identifies the REP alternate port in one of three ways, and configures the VLANs to be blocked on the alternate port.</p> <ul style="list-style-type: none"> <li>• Enter the <b>id</b> <i>port-id</i> to identify the alternate port by port ID. The port ID is automatically generated for each port in the segment. You can view interface port IDs by entering the <b>show interface interface-id rep [detail]</b> privileged EXEC command.</li> <li>• Enter a <i>neighbor-offset</i> number to identify the alternate port as a downstream neighbor from an edge port. The range is from -256 to 256, with negative numbers indicating the downstream neighbor from the secondary edge port. A value of 0 is invalid. Enter <b>-1</b> to identify the secondary edge port as the alternate port.</li> </ul> <p><b>Note</b> Because you enter this command at the primary edge port (offset number 1), you would never enter an offset value of 1 to identify an alternate port.</p> <ul style="list-style-type: none"> <li>• Enter the <b>preferred</b> keyword to select the regular segment port previously identified as the preferred alternate port for VLAN load balancing.</li> <li>• Enter <b>vlan</b> <i>vlan-list</i> to block one VLAN or a range of VLANs.</li> <li>• Enter <b>vlan all</b> to block all VLANs.</li> </ul> <p><b>Note</b> Enter this command only on the REP primary edge port.</p>
<p><b>Step 10</b> <code>rep preempt delay seconds</code></p> <p><b>Example:</b>  Router(config-if)# <code>rep preempt delay 60</code></p>	<p>(Optional) Configures a preempt time delay. Use this command if you want VLAN load balancing to automatically trigger after a link failure and recovery. The time delay range is 15 to 300 seconds. The default is manual preemption with no time delay.</p> <p><b>Note</b> Use this command only on the REP primary edge port.</p>
<p><b>Step 11</b> <code>rep lsl-age-timer value</code></p> <p><b>Example:</b>  Router(config-if) <code>rep lsl-age-timer 5000</code></p>	<p>(Optional) Configure a time (in milliseconds) for which the REP interface remains up without receiving a hello from a neighbor. The range is from 120 to 10000 ms in 40-ms increments; the default is 5000 ms (5 seconds).</p>

Command	Purpose
<b>Step 12</b> <code>end</code>  <b>Example:</b> <pre>Router(config-if)# end</pre>	Returns to privileged EXEC mode.
<b>Step 13</b> <code>show interface [interface-id] rep [detail]</code>  <b>Example:</b> <pre>Router# show interface gigabitethernet0/1 rep detail</pre>	Verifies the REP interface configuration. <ul style="list-style-type: none"> <li>• Enter the physical Layer 2 interface or port channel (logical interface) and the optional detail keyword, if desired.</li> </ul>
<b>Step 14</b> <code>show rep topology [segment segment-id] [archive] [detail]</code>  <b>Example:</b> <pre>Router# show rep topology segment 1</pre>	Indicates which port in the segment is the primary edge port.
<b>Step 15</b> <code>copy running-config startup config</code>  <b>Example:</b> <pre>Router# copy running-config startup config</pre>	(Optional) Saves your entries in the router startup configuration file.



## Configuring REP as Dual Edge No-Neighbor Port

For REP operation, you need to enable it on each segment interface and identify the segment ID.

Effective with Cisco IOS release 15.4.(1)S, you can configure the non-REP switch facing ports on a single device as dual edge no-neighbor ports. These ports inherit all properties of edge ports, and overcome the limitation of not converging quickly during a failure.

**Figure 12-5** Dual Edge No-neighbor Topology

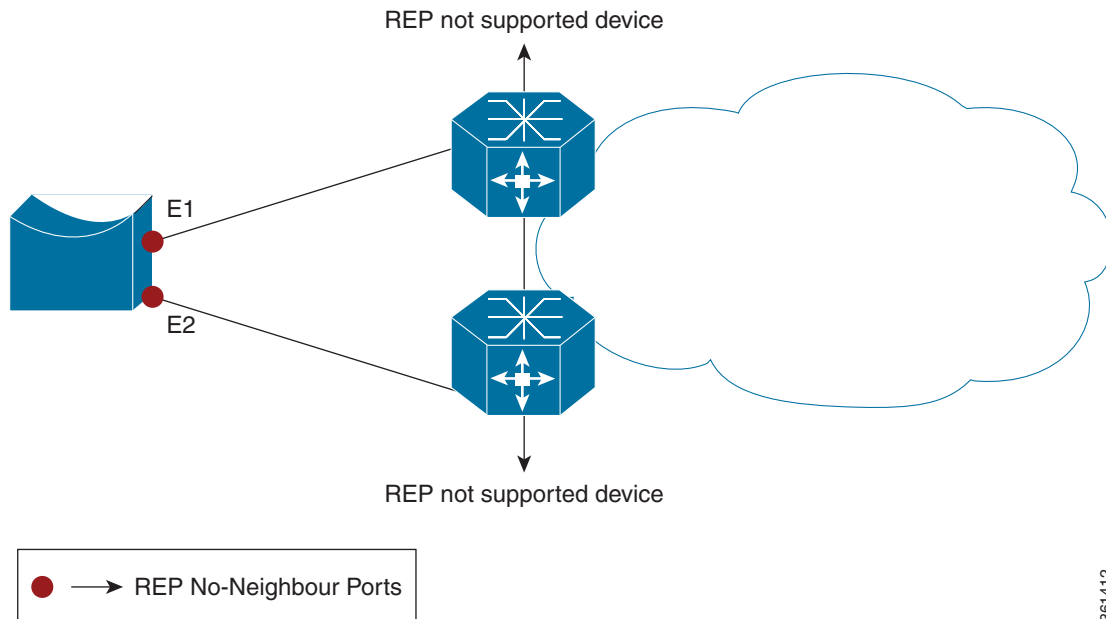

In access ring topologies, the neighboring switch might not support REP, as shown in [Figure 12-5](#). In this case, you can configure the non-REP facing ports (E1 and E2) as edge no-neighbor ports. These ports inherit all properties of edge ports, and you can configure them the same as any edge port, including configuring them to send STP or REP topology change notices to the aggregation switch. In this case the STP topology change notice (TCN) that is sent is a multiple spanning-tree (MST) STP message.

Complete these steps to enable and configure REP as dual edge no-neighbor port:

### SUMMARY STEPS

1. **enable**
2. **configure terminal**
3. **interface** *interface-id*
4. **rep segment** *segment-id* **edge no-neighbor** [**primary** | **preferred**]

## DETAILED STEPS

	Command	Purpose
Step 1	<b>enable</b>  <b>Example:</b> Router> <b>enable</b>	Enables privileged EXEC mode. <ul style="list-style-type: none"><li>• Enter your password if prompted.</li></ul>
Step 2	<b>configure terminal</b>  <b>Example:</b> Router# <b>configure terminal</b>	Enters global configuration mode.

Command	Purpose
<p><b>Step 3</b> <code>interface interface-id</code></p> <p><b>Example:</b>  Router(config)# <code>interface gigabitethernet0/1</code>  Router(config)# <code>interface port-channel 1</code></p>	<p>Specifies the interface, and enters interface configuration mode.</p> <ul style="list-style-type: none"> <li>Enter the physical Layer 2 interface or port channel ID. The port-channel range is 1 to 8.</li> </ul>
<p><b>Step 4</b> <code>rep segment segment-id edge no-neighbor [primary   preferred]</code></p> <p><b>Example:</b>  Router(config-if)# <code>rep segment 1 edge no-neighbor preferred</code></p>	<p>Enables REP on the interface, and identifies a segment number. The segment ID range is from 1 to 1024.</p> <p><b>Note</b> You must configure two edge ports, including one primary edge port for each segment.</p> <p>These are the optional keywords:</p> <ul style="list-style-type: none"> <li>Enter the <b>edge</b> keyword to configure the port as an edge port. Entering <b>edge</b> without the <b>primary</b> keyword configures the port as the secondary edge port. Each segment has only two edge ports.</li> <li>Enter the <b>no-neighbor</b> keyword to configure a port with no external REP neighbors as an edge port. The port inherits all properties of edge ports, and you can configure them the same as any edge port.</li> <li>On an edge port, enter the <b>primary</b> keyword to configure the port as the primary edge port, the port on which you can configure VLAN load balancing.</li> </ul> <p><b>Note</b> Although each segment can have only one primary edge port, if you configure edge ports on two different switches and enter the <b>primary</b> keyword on both switches, the configuration is allowed. However, REP selects only one of these ports as the segment primary edge port. You can identify the primary edge port for a segment by entering the <b>show rep topology</b> privileged EXEC command.</p> <ul style="list-style-type: none"> <li>Enter the <b>preferred</b> keyword to indicate that the port is the preferred alternate port or the preferred port for VLAN load balancing.</li> </ul> <p><b>Note</b> Configuring a port as preferred does not guarantee that it becomes the alternate port; it merely gives it a slight edge among equal contenders. The alternate port is usually a previously failed port.</p>

**Note**

For configuring REP LSL timer and VLB, see [Configuring REP Interfaces, page 12-10](#).

## Cisco ASR 901 Dual Rep Edge No-Neighbor Topology Example

The following configuration example shows a Cisco ASR 901 router running with Dual REP Edge No-Neighbor and two Cisco 7600 series routers running as non-REP devices.

**Note**

This section provides partial configurations intended to demonstrate a specific feature.

### ASR\_1

```
interface GigabitEthernet0/0
service instance 1 ethernet
  encapsulation dot1q 1
  rewrite ingress tag pop 1 symmetric
  bridge-domain 1
!
service instance 2 ethernet
  encapsulation dot1q 2
  rewrite ingress tag pop 1 symmetric
  bridge-domain 2
!
rep segment 1 edge no-neighbor primary
!
interface GigabitEthernet0/1
service instance 1 ethernet
  encapsulation dot1q 1
  rewrite ingress tag pop 1 symmetric
  bridge-domain 1
!
service instance 2 ethernet
  encapsulation dot1q 2
  rewrite ingress tag pop 1 symmetric
  bridge-domain 2
!
rep segment 1 edge no-neighbor preferred
!
interface Vlan1
ip address 172.18.40.70 255.255.255.128
no ptp enable
!
interface Vlan2
ip address 1.1.1.1 255.255.255.0
no ptp enable
!
interface Vlan3
ip address 2.2.2.2 255.255.255.0
no ptp enable
!
interface Vlan3
ip address 4.4.4.2 255.255.255.0
no ptp enable
!
ip route 3.3.3.0 255.255.255.0 1.1.1.2
ip route 5.5.5.0 255.255.255.0 1.1.1.2
```

### 7600\_1

```
interface Port-channel69
```

```
switchport
switchport trunk encapsulation dot1q
switchport trunk allowed vlan 1,2
switchport mode trunk
!
interface GigabitEthernet3/25
switchport
switchport trunk encapsulation dot1q
switchport trunk allowed vlan 1,2
switchport mode trunk
channel-group 69 mode on
!
interface GigabitEthernet3/26
switchport
switchport trunk encapsulation dot1q
switchport trunk allowed vlan 1,2
switchport mode trunk
channel-group 69 mode on
!
interface GigabitEthernet3/35
ip address 3.3.3.2 255.255.255.0
!
interface GigabitEthernet3/36
ip address 5.5.5.2 255.255.255.0
!
interface GigabitEthernet5/2
switchport
switchport trunk encapsulation dot1q
switchport trunk allowed vlan 1,2
switchport mode trunk
!
interface Vlan1
no ip address
!
interface Vlan2
ip address 1.1.1.2 255.255.255.0
!
ip route 2.2.2.0 255.255.255.0 1.1.1.1
ip route 4.4.4.0 255.255.255.0 1.1.1.1
```

## 7600\_2

```
interface Port-channel69
switchport
switchport trunk encapsulation dot1q
switchport trunk allowed vlan 1,2
switchport mode trunk
!
interface GigabitEthernet7/25
switchport
switchport trunk encapsulation dot1q
switchport trunk allowed vlan 1,2
switchport mode trunk
channel-group 69 mode on
!
interface GigabitEthernet7/26
switchport
switchport trunk encapsulation dot1q
switchport trunk allowed vlan 1,2
switchport mode trunk
channel-group 69 mode on
```

```

!
interface GigabitEthernet5/2
switchport
switchport trunk encapsulation dot1q
switchport trunk allowed vlan 1,2
switchport mode trunk
!
interface Vlan1
no ip address
!
interface Vlan2
ip address 1.1.1.3 255.255.255.0

```

## Setting up Manual Preemption for VLAN Load Balancing

If you do not enter the **rep preempt delay *seconds*** interface configuration command on the primary edge port to configure a preemption time delay, the default is to manually trigger VLAN load balancing on the segment. Be sure to complete all other segment configuration before manually preempting VLAN load balancing. When you enter the **rep preempt segment *segment-id*** command, a confirmation message appears before the command is executed because preemption can cause network disruption.



### Note

Ethernet over Multiprotocol Label Switching (EoMPLS) is supported on the Cisco ASR 901 router for Cisco IOS Release 15.2(2)SNG and later releases.

Complete these steps on the switch that has the segment primary edge port to manually trigger VLAN load balancing on a segment:

## SUMMARY STEPS

1. **enable**
2. **configure terminal**
3. **rep preempt segment *segment-id***
4. **end**
5. **show rep topology**

## DETAILED STEPS

	Command or Action	Purpose
Step 1	<b>enable</b>  <b>Example:</b> Router> enable	Enables privileged EXEC mode. <ul style="list-style-type: none"> <li>• Enter your password if prompted.</li> </ul>
Step 2	<b>configure terminal</b>  <b>Example:</b> Router# configure terminal	Enters global configuration mode.

	Command or Action	Purpose
Step 3	<code>rep preempt segment segment-id</code>  <b>Example:</b> Router# <code>rep preempt segment 1</code>	Manually triggers VLAN load balancing on the segment. <ul style="list-style-type: none"> <li>Enter the segment ID.</li> </ul> <b>Note</b> You will be asked to confirm the action before the command is executed.
Step 4	<code>end</code>  <b>Example:</b> Router(config)# <code>end</code>	Returns to privileged EXEC mode.
Step 5	<code>show rep topology</code>  <b>Example:</b> Router# <code>show rep topology</code>	Views the REP topology information.

## Configuring SNMP Traps for REP

You can configure the switch to send REP-specific traps to notify the SNMP server of link operational status changes and port role changes. Complete these steps to configure REP traps:

### SUMMARY STEPS

1. `enable`
2. `configure terminal`
3. `snmp mib rep trap-rate value`
4. `end`
5. `show running-config`
6. `copy running-config startup config`

### DETAILED STEPS

	Command or Action	Purpose
Step 1	<code>enable</code>  <b>Example:</b> Router> <code>enable</code>	Enables privileged EXEC mode. <ul style="list-style-type: none"> <li>Enter your password if prompted.</li> </ul>
Step 2	<code>configure terminal</code>  <b>Example:</b> Router# <code>configure terminal</code>	Enters global configuration mode.

	Command or Action	Purpose
Step 3	<pre>snmp mib rep trap-rate value</pre> <p><b>Example:</b> Router(config)# snmp mib rep trap-rate 500</p>	<p>Enables the router to send REP traps, and sets the number of traps sent per second.</p> <ul style="list-style-type: none"> <li>Enter the number of traps sent per second. The range is from 0 to 1000. The default is 0 (no limit imposed; a trap is sent at every occurrence).</li> </ul> <p><b>Note</b> To remove the traps, enter the <b>no snmp mib rep trap-rate</b> command.</p>
Step 4	<pre>end</pre> <p><b>Example:</b> Router(config)# end</p>	Returns to privileged EXEC mode.
Step 5	<pre>show running-config</pre> <p><b>Example:</b> Router# show running-config</p>	(Optional) Displays the running configuration, which you can use to verify the REP trap configuration.
Step 6	<pre>copy running-config startup config</pre> <p><b>Example:</b> Router# copy running-config startup config</p>	(Optional) Saves your entries in the router startup configuration file.

## Monitoring REP

Complete the following steps to monitor the REP configuration:

### SUMMARY STEPS

1. **enable**
2. **show interface** *[interface-id]* **rep** **[detail]**
3. **show rep topology** *[segment segment-id]* **[archive]** **[detail]**



## DETAILED STEPS

	Command or Action	Purpose
Step 1	<p><b>enable</b></p> <p><b>Example:</b> Router&gt; enable</p>	<p>Enables privileged EXEC mode.</p> <ul style="list-style-type: none"> <li>Enter your password if prompted.</li> </ul>
Step 2	<p><b>show interface</b> [<i>interface-id</i>] <b>rep</b> [<b>detail</b>]</p> <p><b>Example:</b> Router# show interface gigabitethernet0/1 rep detail</p>	<p>(Optional) Displays the REP configuration and status for a specified interface.</p> <ul style="list-style-type: none"> <li>Enter the physical Layer 2 interface or port channel (logical interface) and the optional detail keyword, if desired.</li> </ul>
Step 3	<p><b>show rep topology</b> [<b>segment</b> <i>segment-id</i>] [<b>archive</b>] [<b>detail</b>]</p> <p><b>Example:</b> Router# show rep topology</p>	<p>(Optional) Displays REP topology information for a segment or for all segments, including the primary and secondary edge ports in the segment.</p> <ul style="list-style-type: none"> <li>Enter the optional keywords and arguments, as desired.</li> </ul>

# Configuration Examples for REP

This section contains the following examples:

- [Configuring the REP Administrative VLAN: Example, page 12-24](#)
- [Configuring a REP Interface: Example, page 12-24](#)
- [Setting up the Preemption for VLAN Load Balancing: Example, page 12-25](#)
- [Configuring SNMP Traps for REP: Example, page 12-25](#)
- [Monitoring the REP Configuration: Example, page 12-25](#)
- [Cisco ASR 901 Topology Example, page 12-26](#)

## Configuring the REP Administrative VLAN: Example

This example shows how to configure the administrative VLAN as VLAN 100.

```
Router# configure terminal
Router(config)# rep admin vlan 100
Router(config-if)# end
```

## Configuring a REP Interface: Example

This example shows how to configure an interface as the primary edge port for segment 1, to send Spanning Tree Topology Changes Notification (STCNs) to segments 2 through 5, and to configure the alternate port as the port with port ID 0009001818D68700 to block all VLANs after a preemption delay of 60 seconds after a segment port failure and recovery.

```
Router# configure terminal
Router(config)# interface gigabitethernet0/1
Router(config-if)# rep segment 1 edge primary
Router(config-if)# rep stcn segment 2-5
Router(config-if)# rep block port 0009001818D68700 vlan all
Router(config-if)# rep preempt delay 60
Router (config-if)# rep lsl-age-timer 6000
Router(config-if)# end
```

This example shows how to configure the same configuration when the interface has no external REP neighbor:

```
Router# configure terminal
Router(conf)# interface gigabitethernet0/1
Router(config-if)# rep segment 1 edge no-neighbor primary
Router(config-if)# rep stcn segment 2-5
Router(config-if)# rep block port 0009001818D68700 vlan all
Router(config-if)# rep preempt delay 60
Router(config-if)# rep lsl-age-timer 6000
```

**Figure 6** shows how to configure the VLAN blocking configuration. The alternate port is the neighbor with neighbor offset number 4. After manual preemption, VLANs 100 to 200 are blocked at this port and all other VLANs are blocked at the primary edge port E1 (Gigabit Ethernet port 0/1).

```

Router# configure terminal
Router(config)# interface gigabitethernet0/1
Router(config-if)# rep segment 1 edge primary
Router(config-if)# rep block port 4 vlan 100-200
Router(config-if)# end
Router(config)# rep platform vlb segment 1 vlan 100-200

```

**Figure 6** Example of VLAN Blocking

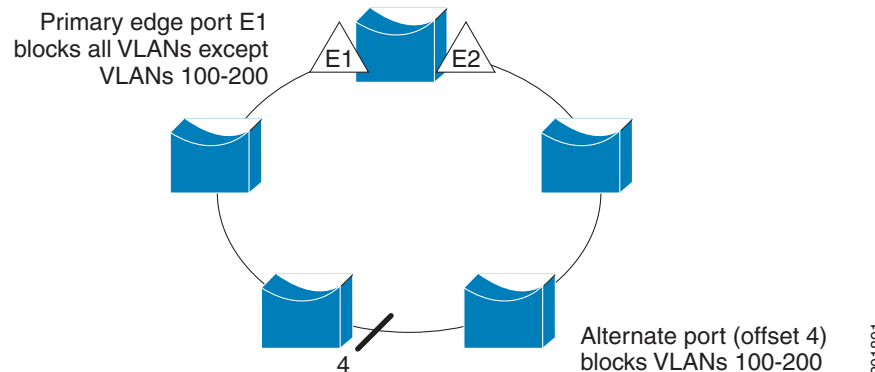

## Setting up the Preemption for VLAN Load Balancing: Example

The following is an example of setting the preemption for VLAN load balancing on a REP segment.

```

Router> enable
Router# configure terminal
Router# rep preempt segment 1
Router# end

```

## Configuring SNMP Traps for REP: Example

This example shows how to configure the router to send REP traps at a rate of 10 traps per second:

```

Router> enable
Router# configure terminal
Router(config)# snmp mib rep trap-rate 10
Router(config)# end

```

## Monitoring the REP Configuration: Example

The following is sample output of the **show interface rep detail** command. Use the **show interface rep detail** command on one of the REP interfaces to monitor and verify the REP configuration.

```

Router# show interface gigabitethernet0/1 rep detail

GigabitEthernet0/1 REP enabled
Segment-id: 2 (Edge)
PortID: 00010019E7144680
Preferred flag: No
Operational Link Status: TWO_WAY
Current Key: 0002001121A2D5800E4D
Port Role: Open
Blocked Vlan: <empty>

```

```

Admin-vlan: 100
Preempt Delay Timer: disabled
Load-balancing block port: none
Load-balancing block vlan: none
STCN Propagate to: none
LSL PDU rx: 3322, tx: 1722
HFL PDU rx: 32, tx: 5
BPA TLV rx: 16849, tx: 508
BPA (STCN, LSL) TLV rx: 0, tx: 0
BPA (STCN, HFL) TLV rx: 0, tx: 0
EPA-ELECTION TLV rx: 118, tx: 118
EPA-COMMAND TLV rx: 0, tx: 0
EPA-INFO TLV rx: 4214, tx: 4190

```

## Cisco ASR 901 Topology Example

The following configuration example shows two Cisco ASR 901 routers and two Cisco 7600 series routers using a REP ring.



### Note

---

This section provides partial configurations intended to demonstrate a specific feature.

---

### ASR\_1

```

interface GigabitEthernet0/0
service instance 1 ethernet
  encapsulation dot1q 1
  rewrite ingress tag pop 1 symmetric
  bridge-domain 1
!
service instance 2 ethernet
  encapsulation dot1q 2
  rewrite ingress tag pop 1 symmetric
  bridge-domain 2
!
rep segment 1
!
interface GigabitEthernet0/1
service instance 1 ethernet
  encapsulation dot1q 1
  rewrite ingress tag pop 1 symmetric
  bridge-domain 1
!
service instance 2 ethernet
  encapsulation dot1q 2
  rewrite ingress tag pop 1 symmetric
  bridge-domain 2
!
rep segment 1
!
interface GigabitEthernet0/3
service instance 3 ethernet
  encapsulation dot1q 3
  rewrite ingress tag pop 1 symmetric
  bridge-domain 3
!
interface GigabitEthernet0/4
service instance 4 ethernet

```

```
    encapsulation dot1q 4
    rewrite ingress tag pop 1 symmetric
    bridge-domain 4
!
interface Vlan1
ip address 172.18.40.70 255.255.255.128
no ptp enable
!
interface Vlan2
ip address 1.1.1.1 255.255.255.0
no ptp enable
!
interface Vlan3
ip address 2.2.2.2 255.255.255.0
no ptp enable
!
interface Vlan3
ip address 4.4.4.2 255.255.255.0
no ptp enable
!
ip route 3.3.3.0 255.255.255.0 1.1.1.4
ip route 5.5.5.0 255.255.255.0 1.1.1.4
```

## ASR\_2

```
interface GigabitEthernet0/0
service instance 1 ethernet
    encapsulation dot1q 1
    rewrite ingress tag pop 1 symmetric
    bridge-domain 1
!
service instance 2 ethernet
    encapsulation dot1q 2
    rewrite ingress tag pop 1 symmetric
    bridge-domain 2
!
rep segment 1
interface GigabitEthernet0/1
service instance 1 ethernet
    encapsulation dot1q 1
    rewrite ingress tag pop 1 symmetric
    bridge-domain 1
!
service instance 2 ethernet
    encapsulation dot1q 2
    rewrite ingress tag pop 1 symmetric
    bridge-domain 2
!
rep segment 1
!
interface Vlan1
ip address 172.18.44.239 255.255.255.0
no ptp enable
!
interface Vlan2
ip address 1.1.1.2 255.255.255.0
no ptp enable
```

**7600\_1**

```

interface Port-channel69
switchport
switchport trunk encapsulation dot1q
switchport trunk allowed vlan 1,2
switchport mode trunk
!
interface GigabitEthernet3/25
switchport
switchport trunk encapsulation dot1q
switchport trunk allowed vlan 1,2
switchport mode trunk
channel-group 69 mode on
!
interface GigabitEthernet3/26
switchport
switchport trunk encapsulation dot1q
switchport trunk allowed vlan 1,2
switchport mode trunk
channel-group 69 mode on
!
interface GigabitEthernet3/35
ip address 3.3.3.2 255.255.255.0
!
interface GigabitEthernet3/36
ip address 5.5.5.2 255.255.255.0
!
interface GigabitEthernet5/2
switchport
switchport trunk encapsulation dot1q
switchport trunk allowed vlan 1,2
switchport mode trunk
rep segment 1 edge
interface Vlan1
no ip address
!
interface Vlan2
ip address 1.1.1.4 255.255.255.0
!
ip route 2.2.2.0 255.255.255.0 1.1.1.1
ip route 4.4.4.0 255.255.255.0 1.1.1.1

```

**7600\_2**

```

interface Port-channel69
switchport
switchport trunk encapsulation dot1q
switchport trunk allowed vlan 1,2
switchport mode trunk
!
interface GigabitEthernet5/2
switchport
switchport trunk encapsulation dot1q
switchport trunk allowed vlan 1,2
switchport mode trunk
rep segment 1 edge
!
interface GigabitEthernet7/25

```

```
switchport
switchport trunk encapsulation dot1q
switchport trunk allowed vlan 1,2
switchport mode trunk
channel-group 69 mode on
!
interface GigabitEthernet7/26
switchport
switchport trunk encapsulation dot1q
switchport trunk allowed vlan 1,2
switchport mode trunk
channel-group 69 mode on
!
interface Vlan1
no ip address
!
interface Vlan2
ip address 1.1.1.3 255.255.255.0
```







## Configuring MST on EVC Bridge Domain

---

This section describes how to configure MST on EVC Bridge Domain.

### Contents

- [Overview of MST and STP, page 13-1](#)
- [Overview of MST on EVC Bridge Domain, page 13-2](#)
- [Restrictions and Guidelines, page 13-2](#)
- [Configuring MST on EVC Bridge Domain, page 13-4](#)

### Overview of MST and STP

Spanning Tree Protocol (STP) is a Layer 2 link-management protocol that provides path redundancy while preventing undesirable loops in the network. For a Layer 2 Ethernet network to function properly, only one active path can exist between any two stations. STP operation is transparent to end stations, which cannot detect whether they are connected to a single LAN segment or a switched LAN of multiple segments.

MST maps multiple VLANs into a spanning tree instance, with each instance having a spanning tree topology independent of other spanning tree instances. This architecture provides multiple forwarding paths for data traffic, enables load balancing, and reduces the number of spanning tree instances required to support a large number of VLANs. MST improves the fault tolerance of the network because a failure in one instance (forwarding path) does not affect other instances (forwarding paths).

For routers to participate in MST instances, you must consistently configure the routers with the same MST configuration information. A collection of interconnected routers that have the same MST configuration comprises an MST region. For two or more routers to be in the same MST region, they must have the same VLAN-to-instance mapping, the same configuration revision number, and the same MST name.

The MST configuration controls the MST region to which each router belongs. The configuration includes the name of the region, the revision number, and the MST VLAN-to-instance assignment map.

A region can have one or multiple members with the same MST configuration; each member must be capable of processing RSTP bridge protocol data units (BPDUs). There is no limit to the number of MST regions in a network, but each region can support up to 65 spanning tree instances. Instances can be identified by any number in the range from 0 to 4094. You can assign a VLAN to only one spanning tree instance at a time.

## Overview of MST on EVC Bridge Domain

The MST on EVC Bridge-Domain feature uses VLAN IDs for service-instance-to-MST-instance mapping. EVC service instances with the same VLAN ID (the outer VLAN IDs in the QinQ case) as the one in another MST instance will be mapped to that MST instance.

EVC service instances can have encapsulations with a single tag as well as double tags. In case of double tag encapsulations, the outer VLAN ID shall be used for the MST instance mapping, and the inner VLAN ID is ignored.

A single VLAN per EVC is needed for the mapping with the MST instance. The following service instances without any VLAN ID or with multiple outer VLAN IDs are not supported:

- Untagged (encapsulation untagged) is supported but there is no loop detection on the EVC
- Priority-tagged (encapsulation priority-tagged)
- Multiple outer tags (encapsulation dot1q 200 to 400 second-dot1q 300)

## Restrictions and Guidelines

The following restrictions and guidelines apply to MST on EVC bridge domain:

- Cisco IOS Release 15.1(2)SNG supports EVC port-channels.
- With default configuration, Cisco ASR 901 does not run any spanning-tree protocol. Hence all the ports participating in bridge domains are moved to forward state. To enable MSTP, issue **spanning-tree mode mstp** command in the global configuration mode.
- Main interface where the EFP is configured must be up and running with MSTP as the selected Spanning Tree Mode (PVST and Rapid-PVST are not supported).
- The SPT PortFast feature is not supported with EFPs.
- The co-existence of REP and mLACP with MST on the same port is not supported.
- Any action performed on VPORT (which represents a particular VLAN in a physical port) affects the bridge domain and other services.
- Supports 32 MSTs and one CIST (common and internal spanning tree).
- Supports one MST region.
- Scales to 4000 EFPs.
- Untagged EVCs do not participate in MST loop detection.
- Service instances without any VLAN ID in the encapsulation are not supported, because a unique VLAN ID is required to map an EVC to an MST instance.
- Supports EFPs with unambiguous outer VLAN tag (that is, no range, list on outer VLAN, neither default nor untagged).
- Removing dot1q encapsulation removes the EVC from MST.
- Changing the VLAN (outer encapsulation VLAN of EVC) mapping to a different MST instance will move the EVC port to the new MST instance.
- Changing an EVC service instance to a VLAN that has not been defined in MST 1 will result in mapping of EVC port to MST 0.
- The peer router of the EVC port must also be running MST.
- MST is supported only on EVC BD. EVCs without BD configuration will not participate in MST.

- When an MST is configured on the outer VLAN, you can configure any number of service instances with the same outer VLAN as shown in the following configuration example.

```
nPE1#sh run int gi0/5
Building configuration...

Current configuration : 373 bytes
!
interface GigabitEthernet0/5
  description connected to CE1
  no ip address
  service instance 100 ethernet
    encapsulation dot1q 100 second-dot1q 1
    bridge-domain 100
  !
  service instance 101 ethernet
    encapsulation dot1q 100 second-dot1q 2
    bridge-domain 101
  !
  service instance 102 ethernet
    encapsulation dot1q 100 second-dot1q 120-140
    bridge-domain 102
  !
end

nPE1#sh run int gi0/6
Building configuration...

Current configuration : 373 bytes
!
interface GigabitEthernet0/6
  description connected to CE1
  no ip address
  service instance 100 ethernet
    encapsulation dot1q 100 second-dot1q 1
    bridge-domain 100
  !
  service instance 101 ethernet
    encapsulation dot1q 100 second-dot1q 2
    bridge-domain 101
  !
  service instance 102 ethernet
    encapsulation dot1q 100 second-dot1q 120-140
    bridge-domain 102
  !
end

nPE1#sh span vlan 100

MST0
  Spanning tree enabled protocol mstp
  Root ID    Priority    32768
            Address    0018.742f.3b80
            Cost        0
            Port        2821 (GigabitEthernet12/5)
            Hello Time  2 sec  Max Age 20 sec  Forward Delay 15 sec

  Bridge ID  Priority    32768 (priority 32768 sys-id-ext 0)
            Address    001a.303c.3400
            Hello Time  2 sec  Max Age 20 sec  Forward Delay 15 sec

Interface                Role Sts Cost          Prio.Nbr Type
-----
-----
```

```

Gi12/5          Root FWD 20000    128.2821 P2p
Gi12/6          Altn  BLK 20000    128.2822 P2p

nPE1#

```

## Configuring MST on EVC Bridge Domain

Figure 13-1 shows an example of the untagged EVCs that do not participate in MST loop detection. When you link your networks together as shown below, a loop is caused since MST is not running on the untagged EVCs.

**Figure 13-1** Untagged EVCs not participating in MST loop detection

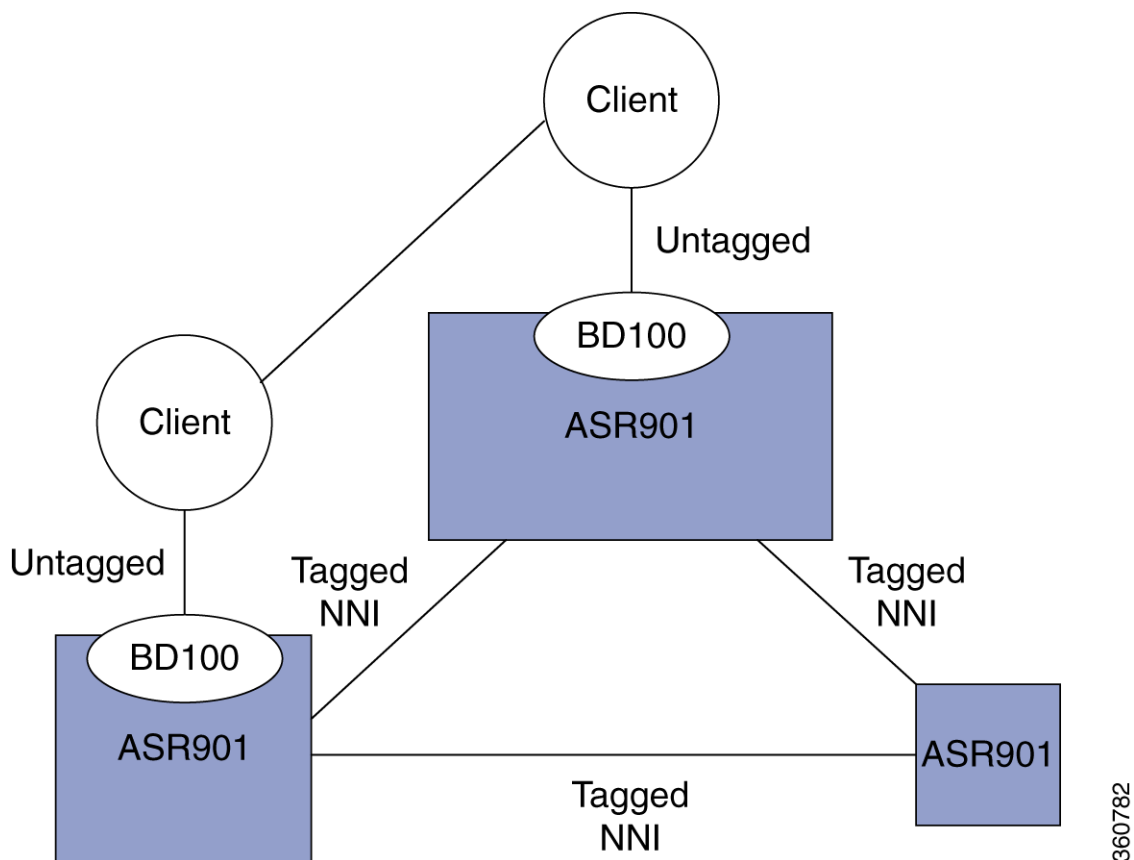
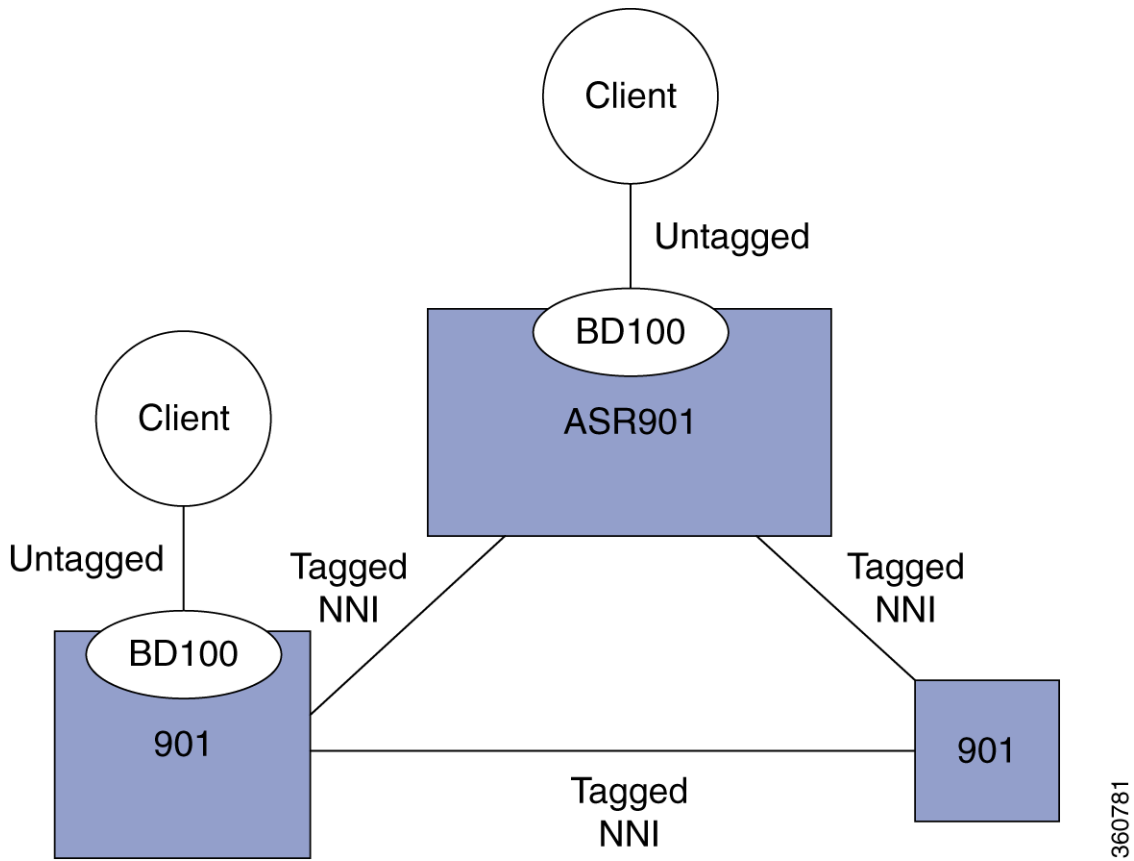

Figure 13-2 MST with untagged EVCs without loop



Complete the following steps to configure MST on EVC bridge domain.

	Command	Purpose
Step 1	<b>enable</b>  <b>Example:</b> Router# enable	Enables privileged EXEC mode. <ul style="list-style-type: none"> <li>Enter your password if prompted.</li> </ul>
Step 2	<b>configure terminal</b>  <b>Example:</b> Router# configure terminal	Enters global configuration mode.
Step 3	<b>interface gigabitethernet slot/port</b>  <b>Example:</b> Router(config)# interface gigabitethernet 0/1	Specifies the gigabit ethernet interface to configure. <ul style="list-style-type: none"> <li>slot/port—Specifies the location of the interface.</li> </ul>

	Command	Purpose
<b>Step 4</b>	<pre>[no] service instance id Ethernet [service-name]</pre> <p><b>Example:</b> Router(config-if)# service instance 101 ethernet</p>	Creates a service instance (EVC instance) on an interface and sets the device into the config-if-srv submode.
<b>Step 5</b>	<pre>encapsulation dot1q vlan-id</pre> <p><b>Example:</b> Router(config-if-srv)# encapsulation dot1q 13</p>	Defines the matching criteria to be used in order to map ingress dot1q frames on an interface to the appropriate service instance.
<b>Step 6</b>	<pre>[no] bridge-domain bridge-id</pre> <p><b>Example:</b> Router(config-if-srv)# bridge-domain 12</p>	Binds the service instance to a bridge domain instance where <i>bridge-id</i> is the identifier for the bridge domain instance.

## Configuration Example for MST on EVC Bridge Domain

In the following example, two interfaces participate in MST instance 0, the default instance to which all VLANs are mapped:

```
Router# enable
Router# configure terminal
Router(config)# interface g0/1
Router(config-if)# service instance 1 ethernet
Router(config-if-srv)# encapsulation dot1q 2
Router(config-if-srv)# bridge-domain 100
Router(config-if-srv)# interface g0/3
Router(config-if)# service instance 1 ethernet
Router(config-if-srv)# encapsulation dot1q 2
Router(config-if-srv)# bridge-domain 100
Router(config-if-srv)# end
```

## Verification

Use this command to verify the configuration:

```
Router# show spanning-tree vlan 2

MST0
  Spanning tree enabled protocol mstp
  Root ID    Priority    32768
            Address    0009.e91a.bc40
            This bridge is the root
            Hello Time  2 sec    Max Age 20 sec    Forward Delay 15 sec

  Bridge ID  Priority    32768 (priority 32768 sys-id-ext 0)
            Address    0009.e91a.bc40
            Hello Time  2 sec    Max Age 20 sec    Forward Delay 15 sec

Interface                Role Sts Cost        Prio.Nbr Type
-----
Gi4/1                    Desg FWD 20000       128.1537 P2p
Gi4/3                    Back BLK 20000       128.1540 P2p
```

In this example, interface gi4/1 and interface gi4/3 are connected back-to-back. Each has a service instance (EFP) attached to it. The EFP on both interfaces has an encapsulation VLAN ID of 2. Changing the VLAN ID from 2 to 8 in the encapsulation directive for the EFP on interface gi4/1 stops the MSTP from running in the MST instance to which the old VLAN is mapped and starts the MSTP in the MST instance to which the new VLAN is mapped:

```
Router(config-if)# interface g4/1
Router(config-if)# service instance 1 ethernet
Router(config-if-srv)# encap dot1q 8
Router(config-if-srv)# end
```

Use this command to verify the configuration:

```
Router# show spanning-tree vlan 2
```

```
MST1
Spanning tree enabled protocol mstp
Root ID      Priority      32769
             Address      0009.e91a.bc40
             This bridge is the root
             Hello Time  2 sec  Max Age 20 sec  Forward Delay 15 sec

Bridge ID    Priority      32769 (priority 32768 sys-id-ext 1)
             Address      0009.e91a.bc40
             Hello Time  2 sec  Max Age 20 sec  Forward Delay 15 sec

Interface                Role Sts Cost          Prio.Nbr Type
-----
Gi4/3                    Desg FWD 20000      128.1540 P2p
```

```
Router# show spanning-tree vlan 8
```

```
MST2
Spanning tree enabled protocol mstp
Root ID      Priority      32770
             Address      0009.e91a.bc40
             This bridge is the root
             Hello Time  2 sec  Max Age 20 sec  Forward Delay 15 sec

Bridge ID    Priority      32770 (priority 32768 sys-id-ext 2)
             Address      0009.e91a.bc40
             Hello Time  2 sec  Max Age 20 sec  Forward Delay 15 sec

Interface                Role Sts Cost          Prio.Nbr Type
-----
Gi4/1                    Desg FWD 20000      128.1537 P2p
```

In this example, interface gi4/3 (with an EFP that has an outer encapsulation VLAN ID of 2 and a bridge domain of 100) receives a new service:

```
Router# enable
Router# configure terminal
Router(config)# interface g4/3
Router((config-if)# service instance 2 ethernet
Router((config-if-srv)# encap dot1q 2 second-dot1q 100
Router((config-if-srv)# bridge-domain 200
```

Now there are two EFPs configured on interface gi4/3 and both of them have the same outer VLAN 2.

```
interface GigabitEthernet4/3
 no ip address
 service instance 1 ethernet
```

```

    encapsulation dot1q 2
    bridge-domain 100
!
service instance 2 ethernet
    encapsulation dot1q 2 second-dot1q 100
    bridge-domain 200

```

The preceding configuration does not affect the MSTP operation on the interface; there is no state change for interface gi4/3 in the MST instance it belongs to.

```
Router# show spanning-tree mst 1
```

```
##### MST1    vlans mapped: 2
Bridge address 0009.e91a.bc40 priority 32769 (32768 sysid 1)
Root          this switch for MST1

```

```

Interface      Role Sts Cost      Prio.Nbr Type
-----
Gi4/3          Desg FWD 20000    128.1540 P2p

```

This example shows MST on port channels:

```
Router# show spanning-tree mst 1
```

```
##### MST1 vlans mapped: 3
Bridge address 000a.f331.8e80 priority 32769 (32768 sysid 1)
Root address 0001.6441.68c0 priority 32769 (32768 sysid 1)
port Po5 cost 20000 rem hops 18

```

```
Interface Role Sts Cost Prio.Nbr Type
-----
```

```

Gi2/0/0 Desg FWD 20000 128.257 P2p
Po5 Root FWD 10000 128.3329 P2p
Po6 Altn BLK 10000 128.3330 P2p

```

```
Router# show spanning-tree vlan 3
```

```

MST1
Spanning tree enabled protocol mstp
Root ID Priority 32769
Address 0001.6441.68c0
Cost 20000
Port 3329 (Port-channel5)
Hello Time 2 sec Max Age 20 sec Forward Delay 15 sec

Bridge ID Priority 32769 (priority 32768 sys-id-ext 1)
Address 000a.f331.8e80
Hello Time 2 sec Max Age 20 sec Forward Delay 15 sec

```

```
Interface Role Sts Cost Prio.Nbr Type
-----
```

```

Gi2/0/0 Desg FWD 20000 128.257 P2p
Po5 Root FWD 10000 128.3329 P2p
Po6 Altn BLK 10000 128.3330 P2p

```



## Troubleshooting Tips

**Table 13-1** Troubleshooting Scenarios

Problem	Solution
Multiple Spanning Tree Protocol (MSTP) incorrectly or inconsistently formed due to misconfiguration and BPDU loss	<p>To avoid BPDU loss, re-configure these on the following nodes:</p> <ul style="list-style-type: none"> <li>• Configuration name</li> <li>• Bridge revision</li> <li>• Provider-bridge mode</li> <li>• Instance to VLAN mapping</li> </ul> <p>Determine if node A is sending BPDUs to node B. Use the <b>show spanning-tree mst interface gi1/1 service instance</b> command for each interface connecting the nodes. Only designated ports relay periodic BPDUs.</p>
MSTP correctly formed, but traffic flooding occurs	<p>Intermittent BPDU loss occurs when the spanning tree appears incorrectly in the show commands, but relays topology change notifications. These notifications cause a MAC flush, forcing traffic to flood until the MAC addresses are re-learned. Use the <b>debug spanning-tree mst packet full {received   sent}</b> command to debug topology change notifications.</p> <p>Use the <b>debug spanning-tree mst packet brief {received   sent}</b> command on both nodes to check for missing BPDUs. Monitor the timestamps. A time gap greater than or equal to six seconds causes topology change.</p>
MSTP shows incorrect port state	<p>When the spanning tree protocol (STP) attempts to change the port state, it uses L2VPN. Check the value of the sent update. If the value is Yes, then STP is awaiting an update from L2VPN.</p>
Packet forwarding does not match the MSTP state	<p>Complete the following steps to verify and troubleshoot:</p> <ol style="list-style-type: none"> <li>1. Shut down redundant links, remove MSTP configuration, and ensure that basic bridging works.</li> <li>2. Check the state of each port as calculated by MSTP, and compare it with the packet counts transmitted and received on ports and EFPs controlled by MSTP. Normal data packets should be sent/received only on ports in the forwarding (FWD) state. BPDUs should be sent/received on all ports controlled by MSTP.</li> <li>3. Ensure that BPDUs are flowing and that root bridge selection is correct and check the related scenarios.</li> <li>4. Use the <b>show l2vpn bridge-domain detail</b> command to confirm the status of the members of the bridge domain. Ensure that the relevant bridge domain members are active.</li> <li>5. Check the forwarding state as programmed in hardware.</li> </ol>





## Configuring Multiprotocol Label Switching

Several technologies such as pseudowires utilize MPLS for packet transport. For more information about how to configure MPLS, see the [MPLS Configuration Guide, Cisco IOS Release 15.1S](#).



**Note**

The Cisco ASR 901 router does not necessarily support all of the commands listed in the Release 15.1(2)S documentation.



**Note**

In Cisco ASR 901, **mpls ip** is configured on SVI only. The Cisco ASR 901 router supports only a maximum of 60 MPLS enabled SVI interfaces.



**Note**

If port channel is configured on an MPLS core, the encapsulation ID should be the same as the bridge domain.



**Note**

The maximum number of LDP labels supported in Cisco ASR 901 router is 4000.



**Note**

MPLS byte switched counters are not supported on Cisco ASR 901 router.





# Configuring EoMPLS

---

The Cisco ASR 901 router supports EoMPLS, a subset of AToM that uses a tunneling mechanism to carry Layer 2 Ethernet traffic. Ethernet Over MPLS (EoMPLS) encapsulates Ethernet frames in MPLS packets and forwards them across the MPLS network.

## Contents

- [Understanding EoMPLS, page 15-1](#)
- [Configuring EoMPLS, page 15-2](#)
- [EoMPLS Configuration Example, page 15-3](#)
- [Configuring Pseudowire Redundancy, page 15-4](#)
- [Port Based EoMPLS, page 15-5](#)

## Understanding EoMPLS

EoMPLS encapsulates ethernet frames in MPLS packets and forwards them across the MPLS network. Each frame is transported as a single packet, and the PE routers connected to the backbone add and remove labels as appropriate for packet encapsulation:

- The ingress PE router receives an Ethernet frame and encapsulates the packet by removing the preamble, the start of frame delimiter (SFD), and the frame check sequence (FCS). The rest of the packet header is not changed.
- The ingress PE router adds a point-to-point virtual connection (VC) label and a label switched path (LSP) tunnel label for normal MPLS routing through the MPLS backbone.
- The network core routers use the LSP tunnel label to move the packet through the MPLS backbone and do not distinguish Ethernet traffic from any other types of packets in the MPLS backbone.
- At the other end of the MPLS backbone, the egress PE router receives the packet and de-encapsulates the packet by removing the LSP tunnel label if one is present. The PE router also removes the VC label from the packet.
- The PE router updates the header, if necessary, and sends the packet out the appropriate interface to the destination switch.

The MPLS backbone uses the tunnel labels to transport the packet between the PE routers. The egress PE router uses the VC label to select the outgoing interface for the Ethernet packet. EoMPLS tunnels are unidirectional; for bidirectional EoMPLS, you need to configure one tunnel in each direction.

The point-to-point VC requires you to configure VC endpoints at the two PE routers. Only the PE routers at the ingress and egress points of the MPLS backbone know about the VCs dedicated to transporting Layer 2 traffic. Other routers do not have table entries for these VCs.

## Restrictions

- When configuring an EoMPLS pseudowire on Cisco ASR 901, you cannot configure an IP address on the same interface as the pseudowire.
- EoMPLS xconnect with VLAN range is not supported.
- EoMPLS xconnect port with double tagged encapsulation is not supported.
- When port channel is configured on MPLS core, the encapsulation ID should be equal to the bridge domain.
- The **encapsulation dot1ad** command is not supported.

## Configuring EoMPLS

Complete the following steps to configure EoMPLS:

	Command	Purpose
Step 1	<b>interface</b> <i>interface-id</i>  <b>Example:</b> Router(config)# int gig 0/1	Specify the interface, and enter interface configuration mode. Valid interfaces are physical ports.
Step 2	<b>service instance</b> <i>number</i> <b>ethernet</b> [ <i>name</i> ]  <b>Example:</b> Router(config-if)#service instance 101 ethernet	Configure a service instance and enter service instance configuration) mode. <ul style="list-style-type: none"> <li>• The <i>number</i> is the service instance identifier, an integer from 1 to 4000.</li> <li>• (Optional) <b>ethernet</b> <i>name</i> is the name of a previously configured EVC. You do not need to use an EVC name in a service instance.</li> </ul>
Step 3	<b>encapsulation</b> { <b>dot1q</b>   <b>untagged</b> }  <b>Example:</b> Router(config-if-srv)#encapsulation dot1q 51	Configure encapsulation type for the service instance. <ul style="list-style-type: none"> <li>• <b>dot1q</b>—Configure 802.1Q encapsulation.</li> <li>• <b>untagged</b>—Map to untagged VLANs. Only one EFP per port can have untagged encapsulation.</li> </ul> <p><b>Note</b> The <b>dot1ad</b> keyword is not supported for the <b>encapsulation</b> command in EoMPLS.</p>

	Command	Purpose
Step 4	<b>rewrite ingress tag pop 1 symmetric</b>  <b>Example:</b> <b>Router(config-if-srv)#rewrite ingress tag pop 1 symmetric</b>	Specify that encapsulation modification to occur on packets at ingress. <ul style="list-style-type: none"> <li>• <b>pop 1</b>—Pop (remove) the outermost tag.</li> <li>• <b>symmetric</b>—Configure the packet to undergo the reverse of the ingress action at egress. If a tag is popped at ingress, it is pushed (added) at egress.</li> </ul> <b>Note</b> Although the <b>symmetric</b> keyword appears to be optional, you must enter it for <b>rewrite</b> to function correctly.
Step 5	<b>xconnect ip address service-instance-number encapsulation mpls</b>  <b>Example:</b> <b>Router(config-if-srv)#xconnect 192.168.1.8 101 encapsulation mpls</b>	Configure cross-connect pseudowire by specifying the IP address of remote peer and the virtual circuit ID.

## EoMPLS Configuration Example

```

interface Loopback0
  description for_mpls_ldp
  ip address 99.99.99.99 255.255.255.255
!
interface GigabitEthernet0/10
  description Core_facing
  no negotiation auto
  service instance 150 ethernet
  encapsulation dot1q 150
  rewrite ingress tag pop 1 symmetric
  bridge-domain 150
!
interface GigabitEthernet0/11
  description Core_facing
  service instance 501 ethernet
  encapsulation dot1q 501
  rewrite ingress tag pop 1 symmetric
  xconnect 111.0.1.1 501 encapsulation mpls
!
interface FastEthernet0/0
  ip address 10.104.99.74 255.255.255.0
  full-duplex
!
interface Vlan1
!
interface Vlan150
  ip address 150.0.0.1 255.255.255.0
  mpls ip
!
router ospf 7
  network 99.99.99.99 0.0.0.0 area 0
  network 150.0.0.0 0.0.0.255 area 0
!
no ip http server
ip route 10.0.0.0 255.0.0.0 10.104.99.1
!

```

```

logging esm config
!
mpls ldp router-id Loopback0 force
!
!
end

```

## Configuring Pseudowire Redundancy

Pseudowire (PW) Redundancy enables you to configure a backup pseudowire in case the primary pseudowire fails. When the primary pseudowire fails, the PE router can switch to the backup pseudowire. Traffic can be switched back to the primary pseudowire after the path is operational again.

You can configure the network with redundant pseudowires and redundant network elements, as shown in [Figure 15-1](#).

**Figure 15-1** Configuring Redundant Pseudowires

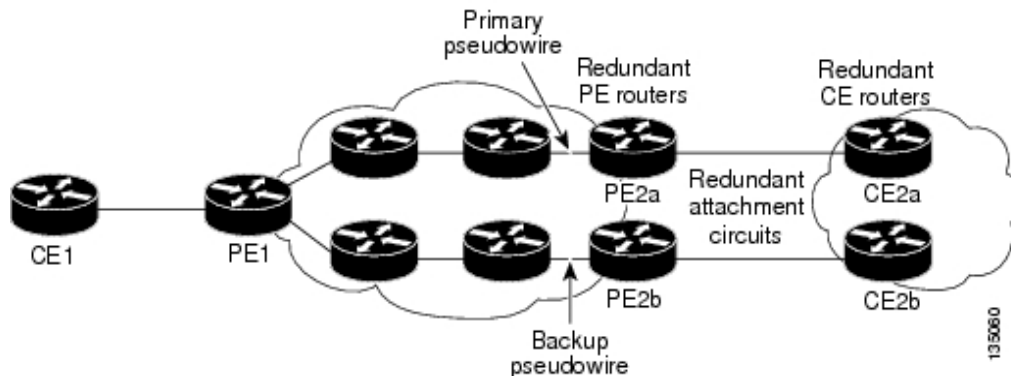

## Configuration Commands

Complete the following steps to configure pseudowire redundancy:

	Command	Purpose
Step 6	<code>configure terminal</code>	Enters global configuration mode.
Step 7	Router(config)# <b>interface</b> <b>GigabitEthernet0/2</b> Router(config-if)#	Specifies an interface to configure.
Step 8	Router(config-if)# <b>service instance</b> <b>101 ethernet</b>	Configures a service instance and enters the service instance configuration mode.
Step 9	Router(config-if-srv)# <b>encapsulation dot1q 101</b>	Configures encapsulation type for the service instance.



	Command	Purpose
Step 10	Router(config-if-srv)# <b>rewrite ingress tag pop 1 symmetric</b>	Specifies the encapsulation modification to occur on packets at ingress as follows: <ul style="list-style-type: none"> <li>• <b>pop 1</b>—Pop (remove) the outermost tag.</li> <li>• <b>symmetric</b>—Configure the packet to undergo the reverse of the ingress action at egress. If a tag is popped at ingress, it is pushed (added) at egress.</li> </ul> <p><b>Note</b> Although the <b>symmetric</b> keyword appears to be optional, you must enter it for <b>rewrite</b> to function correctly.</p>
Step 11	Router(config-if-srv)# <b>xconnect 11.205.1.1 141 encapsulation mpls</b>	Binds the VLAN attachment circuit to an Any Transport over MPLS (AToM) pseudowire for EoMPLS.
Step 12	Router(cfg-if-ether-vc-xconn)# <b>backup peer 13.205.3.3 1141</b>	Specifies a backup peer for redundancy.
Step 13	<b>end</b>	Returns to privileged EXEC mode.
Step 14	<ul style="list-style-type: none"> <li>• <b>show mpls l2t vc id</b></li> <li>• <b>show mpls l2t vc detail</b></li> <li>• <b>show mpls infrastructure lfd pseudowire internal</b></li> </ul>	Use these commands to display pseudowire information.

## Port Based EoMPLS

Port mode allows a frame coming into an interface to be packed into an MPLS packet and transported over the MPLS backbone to an egress interface. The entire ethernet frame without the preamble or frame check sequence (FCS) is transported as a single packet. To configure port mode, use the `xconnect` command in the main interface mode and specify the destination address and the VC ID. The syntax and semantics of the `xconnect` command are the same as for all other transport types. Each interface is associated with one unique pseudowire VC label.

	Command	Purpose
Step 1	<b>enable</b>  <b>Example:</b> Router> <b>enable</b>	Enables privileged EXEC mode.  Enter your password if prompted.
Step 2	<b>configure terminal</b>  <b>Example:</b> Router> <b>configure terminal</b>	Enters global configuration mode.

	Command	Purpose
Step 3	<b>interface GigabitEthernet slot/port</b>  <b>Example:</b> Router(config)# <b>interface</b> <b>GigabitEthernet 0/2</b> Router(config-if)#	Specifies an interface to configure.
Step 4	<b>xconnect peer-router-id vcid</b> <b>encapsulation mpls</b>  <b>Example:</b> Router(config)# <b>xconnect 10.0.0.1</b> <b>123 encapsulation mpls</b>	Binds the attachment circuit to a pseudowire VC. The syntax for this command is the same as for all other Layer 2 transports.



## Configuring MPLS VPNs

A Virtual Private Network (VPN) is an IP-based network that delivers private network services over a public infrastructure. VPNs allow you to create a set of sites that can communicate privately over the Internet or other public or private networks.

### Contents

- [Understanding MPLS VPNs](#)
- [Configuring MPLS VPNs](#)
- [Configuration Examples for MPLS VPN](#)

### Understanding MPLS VPNs

A conventional VPN consists of a full mesh of tunnels or permanent virtual circuits (PVCs) connecting all of the sites within the VPN. This type of VPN requires changes to each edge device in the VPN in order to add a new site. MPLS VPNs, also known as Layer 3 VPNs, are easier to manage and expand than conventional VPNs because they use layer 3 communication protocols and are based on a peer model. The peer model enables the service provider and customer to exchange Layer 3 routing information, enabling service providers to relay data between customer sites without customer involvement. The peer model also provides improved security of data transmission between VPN sites because data is isolated between improves security between VPN sites.

The Cisco ASR 901 supports the following MPLS VPN types:

- **Basic Layer 3 VPN**—Provides a VPN private tunnel connection between customer edge (CE) devices in the service provider network. The provider edge (PE) router uses Multiprotocol Border Gateway Protocol (MP-BGP) to distribute VPN routes and MPLS Label Distribution Protocol (LDP) to distribute Interior Gateway Protocol (IGP) labels to the next-hop PE router.
- **Multi-VRF CE**—Multi-VRF CE extends limited PE functionality to a CE router in an MPLS-VPN model. A CE router now has the ability to maintain separate VRF tables in order to extend the privacy and security of an MPLS-VPN down to a branch office rather than just at the PE router node.



#### Note

Cisco ASR 901 does not support VRF on TDM interfaces.

# Configuring MPLS VPNs

Layer 3 VPNs allow you to establish VPNs in a routed environment, improving the flexibility and ease of maintenance of VPNs. For instructions on how to configure layer 3 VPNs, see the *MPLS Configuration Guide, Cisco IOS Release 15.1S*.

The following restrictions apply to MPLS VPNs:

- When the port channel is on core, bridge ID must be equal to the encapsulation ID.
- Equal Cost Multipath (ECMP) is not supported for swap cases.

## Configuration Examples for MPLS VPN

This section contains the following sample configurations involving three routers:

- [PE1 Configuration, page 16-2](#)
- [Provider Configuration, page 16-5](#)
- [PE2 Configuration, page 16-6](#)

### PE1 Configuration

```
Current configuration : 3326 bytes
!
! Last configuration change at 20:37:37 UTC Thu Sep 29 2011
!
version 15.1
service timestamps debug datetime msec
service timestamps log datetime msec
!
hostname Router
!
boot-start-marker
boot-end-marker
!
!
!card type command needed for slot/vwic-slot 0/0
no logging console
!
no aaa new-model
ip source-route
ip cef
!
ip vrf customer_2
rd 1:2
route-target export 1:2
route-target import 1:2
!
!
no ip domain lookup
no ipv6 cef
!
!
multilink bundle-name authenticated
!
!
!
spanning-tree mode pvst
```

```
spanning-tree extend system-id
!
vlan internal allocation policy ascending
!
!
!
!
!
!
!
!
!
!
interface Loopback2
no ip address
!
interface Loopback100
ip address 111.0.0.1 255.255.255.255
!
interface GigabitEthernet0/0
no negotiation auto
!
interface GigabitEthernet0/1
no negotiation auto
!
interface GigabitEthernet0/2
no negotiation auto
!
interface GigabitEthernet0/3
no negotiation auto
!
interface GigabitEthernet0/4
no negotiation auto
!
interface GigabitEthernet0/5
media-type sfp
no negotiation auto
cdp enable
service instance 2 ethernet
  encapsulation dot1q 2
  rewrite ingress tag pop 1 symmetric
  bridge-domain 2
!
!
interface GigabitEthernet0/6
no negotiation auto
service instance 10 ethernet
  encapsulation dot1q 20
  bridge-domain 120
!
!
interface GigabitEthernet0/7
load-interval 30
media-type sfp
no negotiation auto
cdp enable
service instance 300 ethernet
  encapsulation dot1q 300
  rewrite ingress tag pop 1 symmetric
  bridge-domain 300
!
!
```

```

interface GigabitEthernet0/8
no negotiation auto
!
interface GigabitEthernet0/9
load-interval 30
no negotiation auto
service instance 10 ethernet
encapsulation dot1q 301
rewrite ingress tag pop 1 symmetric
bridge-domain 301
!
!
interface GigabitEthernet0/10
no negotiation auto
ethernet dot1ad nni
service instance 1 ethernet
encapsulation dot1ad 30
rewrite ingress tag pop 1 symmetric
!
!
interface GigabitEthernet0/11
no negotiation auto
!
interface ToP0/12
no negotiation auto
!
interface FastEthernet0/0
no ip address
full-duplex
!
interface Vlan1
!
interface Vlan2
ip vrf forwarding customer_2
ip address 2.2.1.1 255.255.255.0
!
interface Vlan300
ip address 1.0.0.1 255.255.255.0
mpls ip
!
interface Vlan301
ip address 11.0.0.1 255.255.255.0
mpls ip
!
router ospf 22
router-id 1.0.0.1
redistribute connected subnets
network 1.0.0.0 0.0.0.255 area 23
network 11.0.0.0 0.0.0.255 area 23
!
router bgp 1
bgp log-neighbor-changes
neighbor 111.0.1.1 remote-as 1
neighbor 111.0.1.1 update-source Loopback100
!
address-family ipv4
redistribute connected
neighbor 111.0.1.1 activate
neighbor 111.0.1.1 send-community both
exit-address-family
!
address-family vpnv4
neighbor 111.0.1.1 activate
neighbor 111.0.1.1 send-community both

```

```

exit-address-family
!
address-family ipv4 vrf cust
 redistribute static
 aggregate-address 190.0.0.0 255.0.0.0 summary-only
 redistribute connected
 neighbor 2.2.1.2 remote-as 100
 neighbor 2.2.1.2 activate
exit-address-family
!
ip forward-protocol nd
!
!
no ip http server
!
logging esm config
cdp run
!
mpls ldp router-id Loopback100 force
!
!
control-plane
!
!
line con 0
line con 1
transport preferred lat pad telnet rlogin udptn mop ssh
transport output lat pad telnet rlogin udptn mop ssh
line vty 0 4
login
!
exception data-corruption buffer truncate
exception crashinfo buffersize 128
!
end

```

### Provider Configuration

```

Router_1#show running-config interface gigabitEthernet 4/15
Building configuration...

```

```

Current configuration : 80 bytes
!
interface GigabitEthernet4/15
 ip address 9.0.0.1 255.255.255.0
 mpls ip
end

```

```

Router_1#show running-config interface gigabitEthernet 4/16
Building configuration...

```

```

Current configuration : 91 bytes
!
interface GigabitEthernet4/16
 ip address 1.0.0.2 255.255.255.0
 mpls ip
end

```

```

Router_1#

```

```

mpls ldp router-id Loopback2 force

```

```
Router_1#show running-config partition router bgp 1
Building configuration...
```

```
Current configuration : 664 bytes
!
Configuration of Partition - router bgp 1
!
!
!
router bgp 1
  bgp log-neighbor-changes
  neighbor 100.0.0.1 remote-as 1
  neighbor 100.0.0.1 update-source Loopback2
  neighbor 100.0.1.1 remote-as 1
  neighbor 100.0.1.1 update-source Loopback2
  !
  address-family ipv4
    no synchronization
    neighbor 100.0.0.1 activate
    neighbor 100.0.0.1 send-community both
    neighbor 100.0.1.1 activate
    neighbor 100.0.1.1 send-community both
    no auto-summary
  exit-address-family
  !
  address-family vpnv4
    neighbor 100.0.0.1 activate
    neighbor 100.0.0.1 send-community both
    neighbor 100.0.1.1 activate
    neighbor 100.0.1.1 send-community both
  exit-address-family
  !
  !
end
```

```
Router_1#
```

```
Router_1#show running-config partition router ospf 1
Building configuration...
```

```
Current configuration : 197 bytes
!
Configuration of Partition - router ospf 1
!
!
!
router ospf 1
  log-adjacency-changes
  redistribute connected subnets
  network 1.0.0.0 0.0.0.255 area 0
  network 9.0.0.0 0.0.0.255 area 0
  !
  !
end
```

## PE2 Configuration

### Interface details

```
Router_3#show running-config interface gigabitEthernet 6/3
Building configuration...
```



```

Current configuration : 79 bytes
!
interface GigabitEthernet6/3
 ip address 9.0.0.2 255.255.255.0
 mpls ip
end

Router_3#show running-config interface gigabitEthernet 6/6
Building configuration...

Current configuration : 107 bytes
!
interface GigabitEthernet6/6
 ip vrf forwarding customer_red
 ip address 20.20.30.100 255.255.255.0
end

Router_3#show running-config interface gigabitEthernet 6/2
Building configuration...

Current configuration : 136 bytes
!
interface GigabitEthernet6/2
 ip vrf forwarding customer_green
 ip address 20.20.30.99 255.255.255.0
 speed nonegotiate
 mpls ip
end

Router_3#

```

### OSPF and BGP details

```

Router_3#show running-config partition router bgp 1
Building configuration...

Current configuration : 1061 bytes
!
Configuration of Partition - router bgp 1
!
!
!
router bgp 1
 bgp log-neighbor-changes
 neighbor 35.35.35.35 remote-as 1
 neighbor 35.35.35.35 update-source Loopback1
 neighbor 100.0.0.1 remote-as 1
 neighbor 100.0.0.1 update-source Loopback1
!
 address-family ipv4
  no synchronization
  redistribute connected
  neighbor 35.35.35.35 activate
  neighbor 35.35.35.35 send-community both
  neighbor 100.0.0.1 activate
  neighbor 100.0.0.1 send-community both
  no auto-summary
 exit-address-family
!
 address-family vpv4
  neighbor 35.35.35.35 activate
  neighbor 35.35.35.35 send-community both

```

```

neighbor 100.0.0.1 activate
neighbor 100.0.0.1 send-community both
exit-address-family
!
address-family ipv4 vrf customer_green
redistribute static
aggregate-address 191.0.0.0 255.0.0.0 summary-only
no synchronization
redistribute connected
neighbor 20.20.30.199 remote-as 200
neighbor 20.20.30.199 activate
exit-address-family
!
address-family ipv4 vrf customer_red
redistribute static
aggregate-address 191.0.0.0 255.0.0.0 summary-only
no synchronization
redistribute connected
neighbor 20.20.30.200 remote-as 100
neighbor 20.20.30.200 activate
exit-address-family
!
!
end

```

```

Router_3#show running-config partition router ospf 1
Building configuration...

```

```

Current configuration : 220 bytes
!
Configuration of Partition - router ospf 1
!
!
!
router ospf 1
log-adjacency-changes
redistribute connected subnets
network 9.0.0.0 0.0.0.255 area 0
network 20.20.30.0 0.0.0.255 area 0
bfd all-interfaces
!
!
end

```

```

Router_3#

```

### Loop Back details

```

Router_3#show interfaces Loopback 1
Loopback1 is up, line protocol is up
Hardware is Loopback
Internet address is 100.0.1.1/24
MTU 1514 bytes, BW 8000000 Kbit/sec, DLY 5000 usec,
    reliability 255/255, txload 1/255, rxload 1/255
Encapsulation LOOPBACK, loopback not set
Keepalive set (10 sec)
Last input 20:14:17, output never, output hang never
Last clearing of "show interface" counters 22:18:00
Input queue: 0/75/0/0 (size/max/drops/flushes); Total output drops: 0
Queueing strategy: fifo
Output queue: 0/0 (size/max)
5 minute input rate 0 bits/sec, 0 packets/sec
5 minute output rate 0 bits/sec, 0 packets/sec

```

```
0 packets input, 0 bytes, 0 no buffer
Received 0 broadcasts (0 IP multicasts)
0 runts, 0 giants, 0 throttles
0 input errors, 0 CRC, 0 frame, 0 overrun, 0 ignored, 0 abort
21 packets output, 1464 bytes, 0 underruns
0 output errors, 0 collisions, 0 interface resets
0 unknown protocol drops
0 output buffer failures, 0 output buffers swapped out
```

```
Router_3#show run | i Loopback
interface Loopback1
interface Loopback60
  neighbor 35.35.35.35 update-source Loopback1
  neighbor 100.0.0.1 update-source Loopback1
mpls ldp router-id Loopback1 force
Router_3#
```





# Configuring MPLS OAM

---

This chapter describes how to configure multiprotocol label switching (MPLS) operations, administration and maintenance (OAM) in the Cisco ASR 901 router.

## Contents

- [Understanding MPLS OAM, page 17-1](#)
- [Configuring MPLS OAM, page 17-2](#)

## Understanding MPLS OAM

MPLS OAM helps service providers monitor label-switched paths (LSPs) and quickly isolate MPLS forwarding problems to assist with fault detection and troubleshooting in an MPLS network. The Cisco ASR 901 router supports the following MPLS OAM features:

- [LSP Ping](#)
- [LSP Traceroute](#)
- [LSP Ping over Pseudowire](#)

## LSP Ping

MPLS LSP ping uses MPLS echo request and reply packets, similar to Internet Control Message Protocol (ICMP) echo request and reply messages, to validate an LSP. ICMP echo request and reply messages validate IP networks; MPLS OAM echo and reply messages validate MPLS LDP networks. The LSP ping and trace functions use IPv4 UDP packets with UDP port number 3503. You can use MPLS LSP ping to validate IPv4 LDP or Forwarding Equivalence Classes (FECs) by using the **ping mpls** privileged EXEC command. The MPLS echo request packet is sent to a target router by using the label stack associated with the FEC to be validated.

The source address of the LSP echo request is the IP address of the LDP router generating the LSP request. The destination IP address is a 127.x.y.z/8 address, which prevents the IP packet from being switched to its destination if the LSP is broken. The 127.0.0.x destination address range prevents the OAM packets from exiting the egress provider-edge router, which keeps them from leaking from the service-provider network to the customer network.

In response to an MPLS echo request, an MPLS echo reply is forwarded as an IP packet by using IP, MPLS, or a combination of both. The source address of the MPLS echo-reply packet is an address obtained from the router generating the echo reply. The destination address is the source address of the router that originated the MPLS echo-request packet. The MPLS echo-reply destination port is the echo-request source port.

## LSP Traceroute

MPLS LSP traceroute also uses MPLS echo request and reply packets to validate an LSP. You can use MPLS LSP traceroute to validate LDP IPv4 by using the **trace mpls** privileged EXEC command. The traceroute time-to-live (TTL) settings force expiration of the TTL along an LSP. MPLS LSP traceroute incrementally increases the TTL value in its MPLS echo requests (TTL = 1, 2, 3, 4) to discover the downstream mapping of each successive hop. The transit router processing the MPLS echo request returns an MPLS echo reply containing information about the transit hop in response to the TTL-expired MPLS packet. The MPLS echo reply destination port is sent to the echo request source port.

## LSP Ping over Pseudowire

The LSP Ping over Pseudowire is used for detecting faults in the data plane or forwarding path for pseudowire services. The connectivity verification model for pseudowires consists of:

- Advertising the VCCV capability
- Verifying the data plane connectivity

Advertising the VCCV capability is done as part of MPLS Label Mapping message. This consists of Control Channel (CC) type which is a bitmask that indicates the type of control channel that can be used to verify connectivity. The Cisco ASR 901 router supports the following CC type:

- MPLS Router Alert Label (Type 2) : The control channel is created out of band and uses the router alert label (RA).



### Note

---

The Cisco ASR 901 router does not support Control Channel Type 1 and 3.

---

Connectivity verification type defines a bitmask that indicates the types of CV packets and protocols that can be sent on the specified control channel.

The LSP ping over pseudowire uses the same label stack as used by the pseudowire data path. Basically it contains the virtual circuit (VC) label and tunnel labels.

## Configuring MPLS OAM

This section contains the following topics:

- [Using LSP Ping for LDP IPv4 FEC, page 17-3](#)
- [Using LSP Traceroute for LDP IPv4 FEC, page 17-3](#)
- [Using LSP Ping for Pseudowire, page 17-3](#)
- [Using LSP Traceroute over Pseudowire, page 17-4](#)
- [Displaying AToM VCCV capabilities, page 17-4](#)

**Note**

On Cisco ASR 901, for a default MTU of 1500 bytes, IOS supports MPLS ping up to 1486 bytes. For MPLS ping with size more than 1486 bytes to work in Cisco ASR 901, the MTU setting on the SVI has to be adjusted to be more than 1500 bytes.

## Using LSP Ping for LDP IPv4 FEC

When you enter the **ping mpls** privileged EXEC command to begin an LSP ping operation, the keyword that follows specifies the Forwarding Equivalence Class (FEC) that is the target of the LSP ping to which you want to verify connectivity.

Command	Purpose
<b>ping mpls ipv4</b> <i>destination-address</i> <i>destination-mask</i>	To verify LSP path from Cisco ASR 901 to remote peer. The keywords have these meanings: <ul style="list-style-type: none"> <li><i>destination-address destination-mask</i>—Specify the address and network mask of the target FEC.</li> </ul>

## Using LSP Traceroute for LDP IPv4 FEC

The LSP traceroute originator sends incremental MPLS echo requests to discover the downstream mapping of each successive hop. When the originating provider edge router receives the reply from the intermediate router, it forms another MPLS echo request with the same target FEC and the time-to-live is incremented by one.

Command	Purpose
<b>traceroute mpls ipv4</b> <i>destination-address</i> <i>destination-mask</i>	To configure LSP IPv4 traceroute. <ul style="list-style-type: none"> <li><i>destination-address destination-mask</i> is the address and network mask of the target FEC.</li> </ul>

## Using LSP Ping for Pseudowire

Use the **ping mpls pseudowire** command to verify the AToM pseudowire path.

Command	Purpose
<b>ping mpls pseudowire</b> <i>ipv4-address</i> <b>vc_id</b> <i>vc-id-value</i>	To verify AToM pseudowire path from the ASR 901 router to remote peer. <ul style="list-style-type: none"> <li><i>ipv4-address</i> is the ip address of the remote peer.</li> <li><b>vc_id</b> is the virtual circuit id.</li> </ul>

## Using LSP Traceroute over Pseudowire

Use the **traceroute mpls pseudowire** command to verify the pseudowire path and the next hop details at the remote peer.

Command	Purpose
<b>traceroute mpls pseudowire</b> <i>ipv4-address</i> <b>vc_id</b> <i>vc-id-value segment</i>	To verify AToM pseudowire path from the ASR 901 router to remote peer and next hop details at remote peer. <ul style="list-style-type: none"> <li><i>ipv4-address</i> is the ip address of the remote peer.</li> <li><b>vc_id</b> is the virtual circuit id.</li> </ul>

## Displaying AToM VCCV capabilities

Use the **show mpls l2transport** command to display the AToM VCCV capabilities.

Command	Purpose
<b>show mpls l2transport binding vc_id</b> <i>vc-id-value</i>	To display AToM VCCV capabilities negotiated between the peers. <ul style="list-style-type: none"> <li><b>vc_id</b> is the virtual circuit id.</li> </ul>





## Configuring Routing Protocols

In addition to static routing, the Cisco ASR 901 supports the following routing protocols:

- OSPF—An Interior Gateway Protocol (IGP) designed for IP networks that supports IP subnetting and tagging of externally derived routing information. OSPF also allows packet authentication and uses IP multicast when sending and receiving packets. For more information on how to configure OSPF, see the *IP Routing: OSPF Configuration Guide, Cisco IOS Release 15.1S*.
- IS-IS—An Open System Interconnection (OSI) protocol that specifies how routers communicate with routers in different domains. For more information on how to configure IS-IS, see the *IP Routing: ISIS Configuration Guide, Cisco IOS Release 15.1S*.
- BGP—An interdomain routing protocol designed to provide loop-free routing between separate routing domains that contain independent routing policies (autonomous systems). For more information on how to configure BGP, see the *IP Routing: BGP Configuration Guide, Cisco IOS Release 15.1S*.

For information about Bidirectional Forwarding Detection (BFD) including sample routing configurations with BFD, see [Configuring BFD](#).



---

**Note** Cisco ASR 901 router supports IP routing on SVI interfaces.

---



---

**Note** Cisco ASR 901 router does not support IGP fast timers.

---



---

**Note** The maximum number of prefixes supported in Cisco ASR 901 router is 12000.

---



---

**Note** The maximum number of SVI's supported in Cisco ASR 901 router is 250.

---

## Changing Default Hashing Algorithm for ECMP

The hashing algorithm for ECMP is changed from Cisco IOS Release 15.3(2)S onwards. You can use the following commands to configure various types of ECMP hash configurations for improved load distribution of IP traffic.

- **asr901-ecmp-hash-config global-type**

- **asr901-ecmp-hash-config ipv4-type**
- **asr901-ecmp-hash-config ipv6-type**
- **asr901-ecmp-hash-config mpls-to-ip**

For detailed information on these commands, see the Cisco ASR 901 Series Aggregation Services Router Command Reference guide at the following location:

[http://www.cisco.com/en/US/docs/wireless/asr\\_901/Command/Reference/asr901\\_cmdref.html](http://www.cisco.com/en/US/docs/wireless/asr_901/Command/Reference/asr901_cmdref.html)



# Configuring Bidirectional Forwarding Detection

Bidirectional Forwarding Detection (BFD) provides a low-overhead, short-duration method of detecting failures in the forwarding path between two adjacent routers, including the interfaces, data links, and forwarding planes. BFD is a detection protocol that you enable at the interface and routing protocol levels.

## Contents

- [Understanding BFD, page 19-1](#)
- [Configuring BFD, page 19-1](#)
- [Configuration Examples for BFD, page 19-7](#)

## Understanding BFD

Cisco supports the BFD asynchronous mode, in which two routers exchange BFD control packets to activate and maintain BFD neighbor sessions. To create a BFD session, you must configure BFD on both systems (or BFD peers). After you enable BFD on the interface and the router level for the appropriate routing protocols, a BFD session is created, BFD timers are negotiated, and the BFD peers begin to send BFD control packets to each other at the negotiated interval.

## Configuring BFD

This section contains the following topics:

- [BFD Configuration Guidelines and Restrictions, page 19-2](#)
- [Configuring BFD for OSPF, page 19-2](#)
- [Configuring BFD for BGP, page 19-4](#)
- [Configuring BFD for IS-IS, page 19-4](#)
- [Configuring BFD for Static Routes, page 19-6](#)

For more information about BFD, refer to the *IP Routing: BFD Configuration Guide, Cisco IOS Release 15.1S*.

**Note**

Cisco ASR 901 supports BFD echo mode.

## BFD Configuration Guidelines and Restrictions

- The minimum time interval supported for BFD is 50 ms.
- The maximum number of stable sessions supported for BFD with 50 ms interval is 4.
- When you configure BFD and REP on Cisco ASR 901, REP protocol goes down.
- After enabling BFD on an interface, if you configure an IPV4 static route with BFD routing through this interface, and if the IPV4 BFD session does not get established, unconfigure BFD on the given interface, and configure it again. The BFD session comes up.
- When you move the BFD configuration saved in flash memory to the running configuration, BFD session is re-established.
- When BFD is configured on a port from which more than 70% of line rate data traffic is egressing, there is a drop in control packets including BFD packets. To avoid BFD packet drop, you have to configure QoS policies that give higher priority for both CPU generated BFD packets and BFD echo reply packets.

## Configuring BFD for OSPF

This section describes how to configure BFD on the Cisco ASR 901.

### Configuring BFD for OSPF on One of More Interfaces

Complete these steps to configure BFD for OSPF on a single interface.

	Command	Purpose
Step 1	<code>enable</code>  <b>Example:</b> Router> <code>enable</code>	Enables privileged EXEC mode. <ul style="list-style-type: none"> <li>• Enter your password if prompted.</li> </ul>
Step 2	<code>configure terminal</code>  <b>Example:</b> Router# <code>configure terminal</code>	Enters global configuration mode.
Step 3	Router(config)# <code>interface vlan1</code> Router(config-if)#	Specifies an interface to configure.
Step 4	Router(config-if)# <code>ip ospf bfd</code>	Enables BFD for OSPF on the interface.

	Command	Purpose
Step 5	<code>Router(config-if)# bfd interval 50 min_rx 50 multiplier 3</code>	Specifies the BFD session parameters.
Step 6	<code>end</code>	Exits configuration mode.
	<b>Example:</b> <code>Router(config-if)# end Router#</code>	

**Note**

You can also use the **show bfd neighbors** and **show ip ospf** commands to display troubleshooting information about BFD and OSPF.

## Configuring BFD for OSPF on All Interfaces

Complete these steps to configure BFD for OSPF on all interfaces.

	Command	Purpose
Step 1	<code>enable</code>	Enables privileged EXEC mode. <ul style="list-style-type: none"> <li>Enter your password if prompted.</li> </ul>
	<b>Example:</b> <code>Router&gt; enable</code>	
Step 2	<code>configure terminal</code>	Enters global configuration mode.
	<b>Example:</b> <code>Router# configure terminal</code>	
Step 3	<code>Router(config)# router ospf 100</code>	Creates a configuration for an OSPF process.
Step 4	<code>Router(config)# bfd all-interfaces</code>	Enables BFD globally on all interfaces associated with the OSPF routing process.
Step 5	<code>exit</code>	Exits configuration mode.
	<b>Example:</b> <code>Router(config)# exit Router#</code>	

**Note**

You can disable BFD on a single interface using the **ip ospf bfd disable** command when configuring the relevant interface.

## Configuring BFD for BGP

Complete these steps to configure BFD for BGP.

	Command	Purpose
Step 1	<b>enable</b>  <b>Example:</b> Router> enable	Enables privileged EXEC mode. <ul style="list-style-type: none"> <li>Enter your password if prompted.</li> </ul>
Step 2	<b>configure terminal</b>  <b>Example:</b> Router# configure terminal	Enters global configuration mode.
Step 3	Router(config)# <b>router bgp as-tag</b>	Specifies a BGP process and enter router configuration mode.
Step 4	Router(config)# <b>neighbor ip-address fall-over bfd</b>	Enables support for BFD failover.
Step 5	<b>exit</b>  <b>Example:</b> Router(config)# exit Router#	Exits configuration mode.
Step 6	<b>show bfd neighbors [details]</b>  <b>show ip bgp neighbor</b>	Use the following commands to verify the BFD configuration: <ul style="list-style-type: none"> <li><b>show bfd neighbors [details]</b>—Verifies that the BFD neighbor is active and displays the routing protocols that BFD has registered.</li> <li><b>show ip bgp neighbor</b>—Displays information about BGP and TCP connections to neighbors.</li> </ul>

## Configuring BFD for IS-IS

This section describes how to configure BFD for IS-IS routing.

### Configuring BFD for IS-IS on a Single Interface

Complete these steps to configure BFD for IS-IS on a single interface.

	Command	Purpose
Step 1	<b>enable</b>  <b>Example:</b> Router> enable	Enables privileged EXEC mode. <ul style="list-style-type: none"> <li>Enter your password if prompted.</li> </ul>
Step 2	<b>configure terminal</b>  <b>Example:</b> Router# configure terminal	Enters global configuration mode.

	Command	Purpose
Step 3	Router(config)# <b>interface vlan1</b> Router(config-if)#	Enters interface configuration mode.
Step 4	Router(config-if) <b>ip router isis</b> [tag]	Enables support for IPv4 routing on the interface.
Step 5	Router(config-if) <b>isis bfd</b>	Enables BFD on the interfaces.
Step 6	<b>exit</b>	Exits configuration mode.
	<b>Example:</b> Router(config)# exit Router#	

**Note**

You can use the **show bfd neighbors** and **show clns interface** commands to verify your configuration.

## Configuring BFD for IS-IS for All Interfaces

Complete these steps to configure BFD for IS-IS on all interfaces.

	Command	Purpose
Step 1	<b>enable</b>  <b>Example:</b> Router> enable	Enables privileged EXEC mode. <ul style="list-style-type: none"> <li>Enter your password if prompted.</li> </ul>
Step 2	<b>configure terminal</b>  <b>Example:</b> Router# <b>configure terminal</b>	Enters global configuration mode.
Step 3	Router(config)# <b>interface vlan1</b> Router(config-if)#	Enters interface configuration mode.
Step 4	Router(config-if) <b>ip router isis</b> [tag]	Enables support for IPv4 routing on the interface.
Step 5	Router(config-router)# <b>bfd</b> <b>all-interfaces</b>	Enables BFD globally on all interfaces associated with the IS-IS routing process.
Step 6	Router(config-router)# <b>exit</b> Router(config)#	Exits the interface.

	Command	Purpose
Step 7	<pre>Router(config)# interface vlan1 Router(config-if) ip router isis [tag]</pre>	<p>If you want to enable BFD on a per-interface basis for one or more interfaces associated with the IS-IS routing process, complete the following steps:</p> <ol style="list-style-type: none"> <li>Use the <b>interface</b> command to enter interface configuration mode.</li> <li>Use the <b>ip router isis</b> command to enable support for IPv4 routing on the interface.</li> </ol>
Step 8	<pre>exit</pre> <p><b>Example:</b>  <pre>Router(config)# exit Router#</pre></p>	Exit configuration mode.

**Note**

You can use the **show bfd neighbors** and **show cns interface** commands to verify your configuration.

## Configuring BFD for Static Routes

Complete these steps to configure BFD for static routes.

	Command	Purpose
Step 1	<pre>enable</pre> <p><b>Example:</b>  <pre>Router&gt; enable</pre></p>	<p>Enables privileged EXEC mode.</p> <ul style="list-style-type: none"> <li>Enter your password if prompted.</li> </ul>
Step 2	<pre>configure terminal</pre> <p><b>Example:</b>  <pre>Router# configure terminal</pre></p>	Enters global configuration mode.
Step 3	<pre>Router(config)# interface vlan 150</pre>	Specifies an interface and enters interface configuration mode.
Step 4	<pre>Router(config-if)# ip address 10.201.201.1 255.255.255.0</pre>	Configures an IP address for the interface.
Step 5	<pre>Router(config-if)# bfd interval 50 min_rx 50 multiplier 3</pre>	Enables BFD on the interface.
Step 6	<pre>exit</pre> <p><b>Example:</b>  <pre>Router(config-if)# exit Router#(config)</pre></p>	Exits configuration mode.
Step 7	<pre>Router(config)# ip route static bfd vlan150 150.0.0.2</pre>	Specifies neighbors for the static routes in BFD.
Step 8	<pre>Router(config)# ip route 77.77.77.0 255.255.255.0 vlan150</pre>	Specifies the exit interface for the static route in BFD.



**Note**

You can use the **show ip static route** command to verify your configuration.

## Configuration Examples for BFD

The following section contains sample configurations for each routing protocol using BFD.

**Note**

This section provides partial configurations intended to demonstrate a specific feature.

- [BFD with OSPF on All Interfaces, page 19-7](#)
- [BFD with OSPF on Individual Interfaces, page 19-7](#)
- [BFD with BGP, page 19-8](#)
- [BFD with IS-IS on All Interfaces, page 19-8](#)
- [BFD with IS-IS on Individual Interfaces, page 19-8](#)
- [BFD with Static Routes, page 19-9](#)

### BFD with OSPF on All Interfaces

```
interface GigabitEthernet0/10
  description Core_facing
  negotiation auto
  service instance 150 ethernet
  encapsulation untagged
  bridge-domain 150
!
interface Vlan150
  ip address 150.0.0.1 255.255.255.0
  bfd interval 50 min_rx 50 multiplier 3
!
router ospf 7
  network 99.99.99.99 0.0.0.0 area 0
  network 150.0.0.0 0.0.0.255 area 0
  bfd all-interfaces
```

### BFD with OSPF on Individual Interfaces

```
interface GigabitEthernet0/10
  description Core_facing
  negotiation auto
  service instance 150 ethernet
  encapsulation untagged
  bridge-domain 150
!
interface Vlan150
  ip address 150.0.0.1 255.255.255.0
  bfd interval 50 min_rx 50 multiplier 3
```

```

ip ospf bfd
!
router ospf 7
 network 99.99.99.99 0.0.0.0 area 0
 network 150.0.0.0 0.0.0.255 area 0

```

## BFD with BGP

```

interface GigabitEthernet0/10
 description Core_facing
 negotiation auto
 service instance 150 ethernet
 encapsulation untagged
 bridge-domain 150
!
interface Vlan150
 ip address 150.0.0.1 255.255.255.0
 bfd interval 50 min_rx 50 multiplier 3
!
router bgp 1
 bgp log-neighbor-changes
 neighbor 150.0.0.2 remote-as 2
 neighbor 150.0.0.2 fall-over bfd

```

## BFD with IS-IS on All Interfaces

```

interface GigabitEthernet0/10
 description Core_facing
 negotiation auto
 service instance 150 ethernet
 encapsulation untagged
 bridge-domain 150
!
interface Vlan150
 ip address 150.0.0.1 255.255.255.0
 bfd interval 50 min_rx 50 multiplier 3
!
router isis
 net 49.0001.2222.2222.2222.00
 bfd all-interfaces
!

```

## BFD with IS-IS on Individual Interfaces

```

interface GigabitEthernet0/10
 description Core_facing
 negotiation auto
 service instance 150 ethernet
 encapsulation untagged
 bridge-domain 150
!

```

```
interface Vlan150
  ip address 150.0.0.1 255.255.255.0
  bfd interval 50 min_rx 50 multiplier 3
  isis bfd
!
router isis
  net 49.0001.2222.2222.2222.00
!
```

## BFD with Static Routes

```
interface GigabitEthernet0/10
  description Core_facing
  negotiation auto
  service instance 150 ethernet
  encapsulation untagged
  bridge-domain 150
!
interface Vlan150
  ip address 150.0.0.1 255.255.255.0
  bfd interval 50 min_rx 50 multiplier 3
!
ip route static bfd Vlan150 150.0.0.2
ip route 77.77.77.0 255.255.255.0 Vlan150 150.0.0.2
```





# Configuring T1/E1 Controllers

This chapter provides information about configuring the T1/E1 controllers on Cisco ASR 901 router.

## Contents

- [Configuring the Card Type, page 20-1](#)
- [Configuring E1 Controllers, page 20-2](#)
- [Configuring T1 Controllers, page 20-4](#)
- [Troubleshooting Controllers, page 20-5](#)

## Configuring the Card Type

Perform a basic card type configuration by enabling the router, enabling an interface, and specifying the card type as described below. You might also need to enter other configuration commands, depending on the requirements for your system configuration and the protocols you plan to route on the interface.



**Note**

In the following procedure, press the **Return** key after each step unless otherwise noted. At any time, you can exit the privileged level and return to the user level by entering **disable** at the Router# prompt.

To select and configure a card type, complete the following steps:

	Command	Purpose
Step 1	<b>enable</b>  <b>Example:</b> Router> enable	Enables privileged EXEC mode. <ul style="list-style-type: none"> <li>• Enter your password if prompted.</li> </ul>
Step 2	<b>configure terminal</b>  <b>Example:</b> Router# configure terminal	Enters global configuration mode.

	Command	Purpose
Step 3	<p><b>card type</b> {e1   t1} slot subslot</p> <p><b>Example:</b> Router(config)# <b>card type e1 0 0</b></p>	<p>Sets the card type. The command has the following syntax:</p> <ul style="list-style-type: none"> <li>• <i>slot</i>—Slot number of the interface.</li> <li>• <i>subslot</i>—0.</li> </ul> <p>When the command is used for the first time, the configuration takes effect immediately. A subsequent change in the card type does not take effect unless you enter the <b>reload</b> command or reboot the router.</p> <p><b>Note</b> When you are using the <b>card type</b> command to change the configuration of an installed card, you must first enter the <b>no card type {e1   t1} slot subslot</b> command. Then enter the <b>card type {e1   t1} slot subslot</b> command for the new configuration information.</p>
Step 4	<p><b>exit</b></p> <p><b>Example:</b> Router(config)# <b>exit</b> Router#</p>	<p>Exit configuration mode.</p>

## Configuring E1 Controllers

Perform a basic E1 controller configuration by specifying the E1 controller, entering the clock source, specifying the channel-group, configuring the serial interface, configuring PPP encapsulation, and enabling keepalive packets. You might also need to enter other configuration commands, depending on the requirements for your system configuration and the protocols you plan to route on the interface.



### Note

In the following procedure, press the **Return** key after each step unless otherwise noted. At any time, you can exit the privileged level and return to the user level by entering **disable** at the Router# prompt.

To configure the E1 controllers, complete the following steps in the global configuration mode:

	Command	Purpose
Step 1	<p><b>enable</b></p> <p><b>Example:</b> Router&gt; <b>enable</b></p>	<p>Enables privileged EXEC mode.</p> <ul style="list-style-type: none"> <li>• Enter your password if prompted.</li> </ul>
Step 2	<p><b>configure terminal</b></p> <p><b>Example:</b> Router# <b>configure terminal</b></p>	<p>Enters global configuration mode.</p>
Step 3	<p><b>controller e1 slot/port</b></p> <p><b>Example:</b> Router(config)# <b>controller e1 0/0</b> Router(config-controller)#</p>	<p>Specifies the controller that you want to configure.</p>

	Command	Purpose
Step 4	<pre>framing {crc4   no-crc4}</pre> <p><b>Example:</b> Router(config-controller)# <b>framing</b> <b>crc4</b></p>	Specifies the framing type.
Step 5	<pre>linecode hdb3</pre> <p><b>Example:</b> Router(config-controller)# <b>linecode</b> <b>hdb3</b></p>	Specifies the line code format.
Step 6	<pre>Router(config-controller)# channel-group channel-no timeslots timeslot-list speed {64}</pre> <p><b>Example:</b> Router(config-controller)# <b>channel-group 0 timeslots 1-31</b> <b>speed 64</b></p>	<p>Specifies the channel-group and time slots to be mapped. After you configure a channel-group, the serial interface is automatically created. The syntax is:</p> <ul style="list-style-type: none"> <li><i>channel-no</i>—ID number to identify the channel group. The valid range is from 0–30.</li> <li><i>timeslot-list</i>—Timeslots (DS0s) to include in this channel-group. The valid time slots are from 1–31.</li> <li><b>speed {64}</b>—The speed of the DS0.</li> </ul> <p>The example configures the channel-group and time slots for the E1 controller:</p> <p><b>Note</b> When you are using the <b>channel-group channel-no timeslots timeslot-list {64}</b> command to change the configuration of an installed card, you must enter the <b>no channel-group channel-no timeslots timeslot-list speed {64}</b> command first. Then enter the <b>channel-group channel-no timeslots timeslot-list {64}</b> command for the new configuration information.</p>
Step 7	<pre>Router(config-controller)# exit Router(config)#</pre>	Exits controller configuration mode.
Step 8	<pre>interface serial slot/port:channel</pre> <p><b>Example:</b> Router(config)# <b>interface serial</b> <b>0/0:1</b> Router(config-if)#</p>	<p>Configures the serial interface. Specify the E1 slot, port number, and channel-group.</p> <p>When the prompt changes to Router(config-if), you have entered interface configuration mode.</p> <p><b>Note</b> To see a list of the configuration commands available to you, enter ? at the prompt or press the <b>Help</b> key while in the configuration mode.</p>
Step 9	<pre>encapsulation ppp</pre> <p><b>Example:</b> Router(config-if)# <b>encapsulation</b> <b>ppp</b></p>	Specifies PPP encapsulation on the interface.

	Command	Purpose
Step 10	<b>keepalive</b> [period [retries]]  <b>Example:</b> Router(config-if)# <b>keepalive</b> [period [retries]]	Enables keepalive packets on the interface and specify the number of times keepalive packets are sent without a response before the router disables the interface.
Step 11	Router(config-if)# <b>end</b> Router#	Exits interface configuration mode.

## Configuring T1 Controllers

Use the following steps to perform a basic T1 controller configuration: specifying the T1 controller, specifying the framing type, specifying the line code form, specifying the channel-group and time slots to be mapped, configuring the cable length, configuring the serial interface, configuring PPP encapsulation, and enabling keepalive packets. You might also need to enter other configuration commands, depending on the requirements for your system configuration and the protocols you plan to route on the interface.



### Note

In the following procedure, press the **Return** key after each step unless otherwise noted. At any time, you can exit the privileged level and return to the user level by entering **disable** at the `Router#` prompt.

To configure the T1 interfaces, complete the following steps in the global configuration mode:

	Command	Purpose
Step 1	<b>enable</b>	Enables privileged EXEC mode. Enter your password if prompted.
Step 2	<b>configure terminal</b>	Enters global configuration mode.
Step 3	<b>controller t1 slot/subslot</b>  <b>Example:</b> Router(config-controller)# <b>controller t1 0/0</b>	Specifies the controller that you want to configure. The command has the following syntax: <ul style="list-style-type: none"> <li><i>slot</i>—Slot number of the interface. The slot number should be 0.</li> <li><i>subslot</i>—Subslot number of the interface. The supported range for subslot is 0 to 15.</li> </ul>
Step 4	Router(config-controller)# <b>framing esf</b>	Specifies the framing type.
Step 5	Router(config-controller)# <b>linecode b8zs</b>	Specifies the line code format.
Step 6	Router(config-controller)# <b>channel-group 0 timeslots 1-24</b> <b>speed 64</b>	Specifies the channel-group and time slots to be mapped. After you configure a channel-group, the serial interface is automatically created. <ul style="list-style-type: none"> <li>The default speed of the channel-group is 64.</li> <li>The supported range for channel-group is 0 to 23.</li> </ul>



	Command	Purpose
Step 7	Router(config-controller)# <b>cablelength</b> {long [-15db   -22.5db   -7.5db   0db] short [110ft   220ft   330ft  440ft   550ft   600ft]}	Configures the cable length.
Step 8	Router(config-controller)# <b>exit</b>	Exits controller configuration mode.
Step 9	Router(config)# <b>interface serial</b> <i>slot/port:channel</i>	Configures the serial interface. Specify the T1 slot (always 0), port number, and channel-group.
Step 10	Router(config-if)# <b>encapsulation</b> <b>ppp</b>	Enters the following command to configure PPP encapsulation.
Step 11	Router(config-if)# <b>keepalive</b> [ <i>period [retries]</i> ]	Enables keepalive packets on the interface and specify the number of times that keepalive packets will be sent without a response the interface is brought down:
Step 12	<b>exit</b>	Exits configuration mode.
	<b>Example:</b> Router(config)# exit Router#	

## Troubleshooting Controllers

This line card supports local and network T1/E1 loopback modes, and remote T1 loopback modes for testing, network fault isolation, and agency compliance. You can test T1/E1 lines in local and network loopback modes. You can also test T1 lines in remote mode.



### Note

The ASR901 supports activating or deactivating payload and line loopback modes using FDL in ESF framing mode as defined in the T1.403 ANSI standard. The implementation conforms to ANSI T1.403-1999, sections 9.4.2.1 and 9.4.2.2. The ASR901 only accepts remotely initiated loopback requests and does not support initiation of FDL remote loopback requests.



### Note

Bit-error-rate testing and loopbacks are used to resolve problems and test the quality of T1/E1 links.

## Troubleshooting E1 Controllers

To troubleshoot the E1 line card, complete the following steps in the controller configuration mode:

	Command	Purpose
Step 1	<b>enable</b>  <b>Example:</b> Router# <b>enable</b>	Enables privileged EXEC mode. Enter your password if prompted.
Step 2	<b>configure terminal</b>  <b>Example:</b> Router# <b>configure terminal</b>	Enters global configuration mode.
Step 3	<b>controller e1 slot/subslot</b>  <b>Example:</b> Router(config-controller)# <b>controller e1 0/0</b>	Sets the controller type. The command has the following syntax: <ul style="list-style-type: none"> <li>• <i>slot</i>—Slot number of the interface.</li> <li>• <i>subslot</i>—0.</li> </ul>
Step 4	<b>loopback {local   network {line  payload}}</b>  <b>Example:</b> Router(config-controller)# <b>loopback network line</b>	Sends the packets from a port in local loopback to the remote end. <ul style="list-style-type: none"> <li>• <i>local</i>—Configures the line card to loop the transmitted traffic back to the line card as E1 received traffic and transmits AIS to the remote receiver.</li> <li>• <i>network line</i>—Configures the E1 line card to loop the received traffic back to the remote device after passing them through the line loopback mode of the framer. The framer does not re-clock or reframe the incoming traffic.</li> <li>• <i>network payload</i>—Configures the E1 line card to loop the received traffic back to the remote device after passing them through the payload loopback mode of the framer. The framer re-clocks and reframes the incoming traffic before sending it to the network.</li> </ul>
Step 5	<b>exit</b>  <b>Example:</b> Router(config-controller)# <b>exit</b>	Exits controller configuration mode.

## Troubleshooting T1 Controllers

To troubleshoot the T1 line card, complete the following steps in the controller configuration mode:

	Command	Purpose
Step 1	<b>enable</b>  <b>Example:</b> Router# <b>enable</b>	Enables privileged EXEC mode. Enter your password if prompted.
Step 2	<b>configure terminal</b>  <b>Example:</b> Router# <b>configure terminal</b>	Enters global configuration mode.

	Command	Purpose
Step 3	<pre>controller t1 slot/subslot</pre> <p><b>Example:</b> Router(config-controller)# controller t1 0/0 </p>	<p>Sets the controller type. The command has the following syntax:</p> <ul style="list-style-type: none"> <li>• <i>slot</i>—Slot number of the interface.</li> <li>• <i>subslot</i>—0.</li> </ul>
Step 4	<pre>loopback {diagnostic   local {line   payload}}</pre> <p><b>Example:</b> Router(config-controller)# loopback local line </p>	<p>Sends the packets from a port in local loopback to the remote end.</p> <ul style="list-style-type: none"> <li>• <i>diagnostic</i>—Configures the line card to loop data from the transmit path to the receiver path.</li> <li>• <i>local line</i>—Configures the T1 line card to loop the received traffic back to the remote device after passing them through the line loopback mode of the framer. The framer does not re-clock or reframe the incoming traffic.</li> <li>• <i>local payload</i>—Configures the T1 line card to loop the received traffic back to the remote device after passing them through the payload loopback mode of the framer. The framer re-clocks and reframes the incoming traffic before sending it to the network.</li> </ul>
Step 5	<pre>exit</pre> <p><b>Example:</b> Router(config-controller)# exit </p>	<p>Exits controller configuration mode.</p>





# Configuring Pseudowire

---

Cisco Pseudowire Emulation Edge-to-Edge (PWE3) allows you to transport traffic using traditional services such as E1/T1 over a packet-based backhaul technology such as MPLS or IP. A pseudowire (PW) consists of a connection between two provider edge (PE) devices that connects two attachment circuits (ACs), such as ATM VPIs/VCIs or E1/T1 links.

## Finding Feature Information

Your software release may not support all the features documented in this module. For the latest feature information and caveats, see the release notes for your platform and software release. To find information about the features documented in this module, and to see a list of the releases in which each feature is supported, see the “[Feature Information for Configuring Pseudowire](#)” section on page 21-37.

Use Cisco Feature Navigator to find information about platform support and Cisco software image support. To access Cisco Feature Navigator, go to <http://www.cisco.com/go/cfn>. An account on Cisco.com is not required.

## Contents

- [Understanding Pseudowires](#), page 21-2
- [Hot Standby Pseudowire Support for ATM/IMA](#), page 21-3
- [Configuring Pseudowire](#), page 21-4
- [Configuring L2VPN Pseudowire Redundancy](#), page 21-20
- [Configuring Hot Standby Pseudowire Support for ATM/IMA](#), page 21-22
- [TDM Local Switching](#), page 21-27
- [Configuration Examples of Hot Standby Pseudowire Support for ATM/IMA](#), page 21-30
- [Configuration Examples for Pseudowire](#), page 21-31

Figure 21-1 Cisco ASR 901 Router in a PWE3—Example

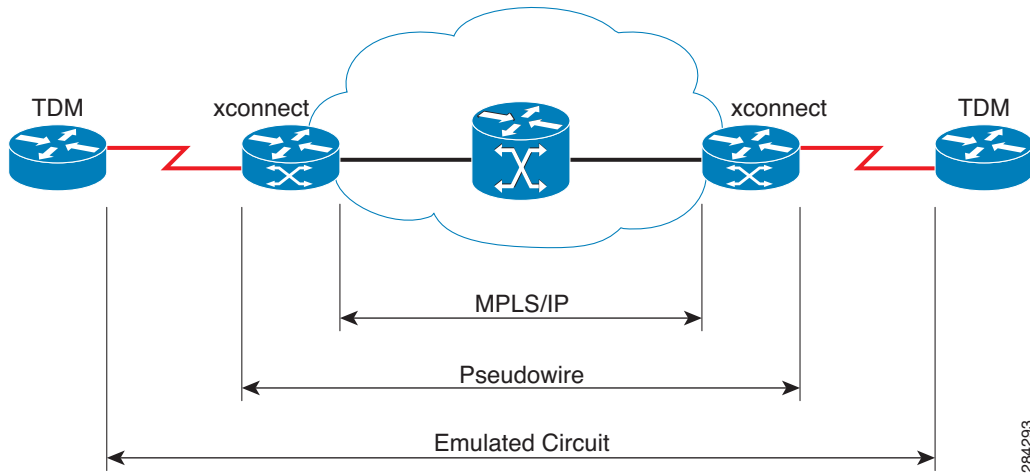

## Understanding Pseudowires

Pseudowires (PWs) manage encapsulation, timing, order, and other operations in order to make it transparent to users; the PW tunnel appears as an unshared link or circuit of the emulated service.

There are limitations that impede some applications from utilizing a PW connection.

Cisco supports the following standards-based PWE types:

- [Structure-Agnostic TDM over Packet](#), page 21-2
- [Structure-Aware TDM Circuit Emulation Service over Packet-Switched Network](#), page 21-3
- [Transportation of Service Using Ethernet over MPLS](#), page 21-3

## Structure-Agnostic TDM over Packet

SAToP encapsulates TDM bit-streams (T1, E1, T3, E3) as PWs over PSNs. It disregards any structure that may be imposed on streams, in particular the structure imposed by the standard TDM framing. The protocol used for emulation of these services does not depend on the method in which attachment circuits are delivered to the PEs. For example, a T1 attachment circuit is treated the same way for all delivery methods, including: PE on copper, multiplex in a T3 circuit, mapped into a virtual tributary of a SONET/SDH circuit, or carried over a network using unstructured Circuit Emulation Service (CES). Termination of specific carrier layers used between the PE and circuit emulation (CE) is performed by an appropriate network service provider (NSP).

For instructions on how to configure SAToP, see [Configuring Structure-Agnostic TDM over Packet](#), page 21-9.

For a sample SAToP configuration, see [Configuration Examples for Pseudowire](#), page 21-31.

## Structure-Aware TDM Circuit Emulation Service over Packet-Switched Network

CESoPSN encapsulates structured (NxDS0) TDM signals as PWs over PSNs.

Emulation of NxDS0 circuits saves PSN bandwidth and supports DS0-level grooming and distributed cross-connect applications. It also enhances resilience of CE devices due to the effects of loss of packets in the PSN.

For instructions on how to configure CESoPSN, see [Configuring Circuit Emulation Service over Packet-Switched Network, page 21-14](#).

For a sample CESoPSN configuration, see [Configuration Examples for Pseudowire, page 21-31](#).

## Transportation of Service Using Ethernet over MPLS

Ethernet over MPLS (EoMPLS) PWs provide a tunneling mechanism for Ethernet traffic through an MPLS-enabled Layer 3 core network. EoMPLS PWs encapsulate Ethernet protocol data units (PDUs) inside MPLS packets and use label switching to forward them across an MPLS network. EoMPLS PWs are an evolutionary technology that allows you to migrate packet networks from legacy networks while providing transport for legacy applications. EoMPLS PWs also simplify provisioning, since the provider edge equipment only requires Layer 2 connectivity to the connected customer edge (CE) equipment. The Cisco ASR 901 implementation of EoMPLS PWs is compliant with the RFC 4447 and 4448 standards.

For instructions on how to create an EoMPLS PW, see [Configuring Transportation of Service Using Ethernet over MPLS](#).

### Limitations

- When configuring an EoMPLS pseudowire on the Cisco ASR 901, you cannot configure an IP address on the same interface as the pseudowire.
- Layer 2 Tunneling Protocol, version 2 and 3 (L2TPv2 and L2TPv3) is not supported on the Cisco ASR 901 series routers.

## Hot Standby Pseudowire Support for ATM/IMA

The Hot Standby Pseudowire Support for Inverse Multiplexing over ATM (IMA) feature improves the availability of pseudowires by detecting failures and handling them with minimal disruption to the service. This feature allows the backup pseudowire to be in a “hot standby” state, so that it can immediately take over if the primary pseudowire fails.

A backup pseudowire is provisioned and corresponding entries are populated to hardware tables. When the primary pseudowire goes down, the backup pseudowire is used to switch the packets.

This feature supports the following transport types:

- ATM AAL5 in VC mode
- ATM in VP mode
- ATM in port mode

# Configuring Pseudowire

This section describes how to configure pseudowire on the Cisco ASR 901. The Cisco ASR 901 supports pseudowire connections using CESoPSN. The following sections describe how to configure pseudowire connections on the Cisco ASR 901.

- [Configuring Pseudowire Classes, page 21-4](#)
- [Configuring CEM Classes, page 21-6](#)
- [Configuring a Backup Peer, page 21-8](#)
- [Configuring Structure-Agnostic TDM over Packet, page 21-9](#)
- [Configuring Circuit Emulation Service over Packet-Switched Network, page 21-14](#)
- [QoS for CESoPSN over UDP and SAToP over UDP, page 21-18](#)
- [Configuring Transportation of Service Using Ethernet over MPLS, page 21-18](#)

For full descriptions of each command, see the *Cisco ASR 901 Series Aggregation Services Router IOS Command Reference*.

For pseudowire configuration examples, see [Configuration Examples for Pseudowire, page 21-31](#)

## Configuring Pseudowire Classes

A pseudowire class allows you to create a single configuration template for multiple pseudowire connections. You can apply pseudowire classes to all pseudowire types.

Complete the following steps to configure a pseudowire class:

### SUMMARY STEPS

1. **enable**
2. **configure terminal**
3. **pseudowire-class** *class-name*
4. **encapsulation mpls**
5. **interface** *cemslot/port*
6. **cem** *group-number*
7. **xconnect ip pw-class** *pseudowire-class*



## DETAILED STEPS

	Command	Purpose
Step 1	<b>enable</b>  <b>Example:</b> Router> enable	Enables privileged EXEC mode. <ul style="list-style-type: none"> <li>Enter your password if prompted.</li> </ul>
Step 2	<b>configure terminal</b>  <b>Example:</b> Router# configure terminal	Enters global configuration mode.
Step 3	<b>pseudowire-class class-name</b>  <b>Example:</b> Router(config)# pseudowire-class newclass	Creates a new pseudowire class.
Step 4	<b>encapsulation mpls</b>  <b>Example:</b> Router(config-pw-class)# encapsulation mpls	Sets an encapsulation type.
Step 5	<b>interface cemslot/port</b>  <b>Example:</b> Router(config)# interface cem0/0	Configures the pseudowire interface to use for the new pseudowire class. This example shows a CESoPSN interface.
Step 6	<b>cem group-number</b>  <b>Example:</b> Router(config-if)# cem 0	Defines a CEM channel.
Step 7	<b>xconnect ip pw-class pseudowire-class</b>  <b>Example:</b> Router(cfg-if-cem)# xconnect 1.1.1.1 40 pw-class myclass	Binds an attachment circuit to the CESoPSN interface to create a CESoPSN pseudowire. Use the <b>pw-class</b> parameter to specify the pseudowire class that the CESoPSN pseudowire interface uses.

**Note**

You cannot use the encapsulation **mpls** parameter with the **pw-class** parameter.

**Note**

The use of the **xconnect** command can vary depending on the type of pseudowire you configure.

## Configuring CEM Classes

A CEM class allows you to create a single configuration template for multiple CEM pseudowires.



### Note

- Cisco IOS release 15.3(3)S automatically enables forward-alarm ais configuration (under the config-controller configuration mode). To disable this configuration, use the **no forward-alarm ais** command.
- The forward-alarm ais configuration is applicable only for CESoP. It is not supported for SAToP.
- You must run the **no forward-alarm ais** command before using CESoP with controllers in loopback (either through loopback command under controller or by using a physical loopback jack).
- Though the **forward-alarm ais** command (and its **no** form) was not supported in previous releases, the Cisco ASR 901 router behaved as if this command was configured under the controller interface.

Complete the following steps to configure a CEM class:

### SUMMARY STEPS

1. **enable**
2. **configure terminal**
3. **class cem** *cem-class-name*
4. **payload-size** *size*
5. **de jitter-buffer** *size*
6. **idle-pattern** *size*
7. **exit**
8. **interface cem** *slot/port*
9. **no ip address**
10. **cem** *group-number*
11. **cem class** *cem-class-name*
12. **xconnect** *ip-address encapsulation mpls*

	Command	Purpose
Step 1	<b>enable</b>  <b>Example:</b> Router> enable	Enables privileged EXEC mode.  <ul style="list-style-type: none"> <li>• Enter your password if prompted.</li> </ul>
Step 2	<b>configure terminal</b>  <b>Example:</b> Router# configure terminal	Enters global configuration mode.

	Command	Purpose
Step 3	<b>class cem</b> <i>cem-class-name</i>  <b>Example:</b> Router(config)# class cem mycemclass	Creates a new CEM class
Step 4	<b>payload-size</b> <i>size</i>  <b>Example:</b> Router(config-cem-class)# payload-size 512	Specifies the payload for the CEM class.
Step 5	<b>de jitter-buffer</b> <i>size</i>  <b>Example:</b> Router(config-cem-class)# de jitter-buffer 10	Specifies the de jitter buffer for the CEM class.
Step 6	<b>idle-pattern</b> <i>size</i>  <b>Example:</b> Router(config-cem-class)# idle-pattern 0x55	Specifies the idle-pattern for the CEM class.
Step 7	<b>exit</b>  <b>Example:</b> Router(config-cem-class)# exit	Returns to the config prompt.
Step 8	<b>interface cem</b> <i>slot/port</i>  <b>Example:</b> Router(config)# interface cem 0/0	Configure the CEM interface that you want to use for the new CEM class.  <b>Note</b> The use of the <b>xconnect</b> command can vary depending on the type of pseudowire you are configuring.
Step 9	<b>no ip address</b>  <b>Example:</b> Router(config-if)# no ip address	Disables the IP address configuration for the physical layer interface.
Step 10	<b>cem</b> <i>group-number</i>  <b>Example:</b> Router(config-if)# cem 0	Enters the CEM configuration mode.

	Command	Purpose
Step 11	<b>cem class</b> <i>cem-class-name</i>  <b>Example:</b> Router(config-if-cem)# cem class mycemclass	Specifies the CEM class name.
Step 12	<b>xconnect</b> <i>ip-address encapsulation mpls</i>  <b>Example:</b> Router(config-if-cem)# xconnect 10.10.10.10 200 encapsulation mpls	Binds an attachment circuit to the CEM interface to create a pseudowire

## Configuring a Backup Peer

A backup peer provides a redundant pseudowire (PW) connection in the case that the primary PW loses connection; if the primary PW goes down, the Cisco ASR 901 diverts traffic to the backup PW.

Complete the following steps to configure a backup peer:

### SUMMARY STEPS

1. **enable**
2. **configure terminal**
3. **interface** *cemslot/port*
4. **cem** *group-number*
5. **xconnect** *peer-loopback-ip-address encapsulation mpls*
6. **backup peer** *peer-router-ip-address vcid [pw-class pw-class-name]*
7. **backup delay** *enable-delay [disable-delay | never]*

### DETAILED STEPS

	Command	Purpose
Step 1	<b>enable</b>  <b>Example:</b> Router> enable	Enables privileged EXEC mode. <ul style="list-style-type: none"> <li>• Enter your password if prompted.</li> </ul>
Step 2	<b>configure terminal</b>  <b>Example:</b> Router# configure terminal	Enters global configuration mode.
Step 3	<b>interface</b> <i>cemslot/port</i>  <b>Example:</b> Router(config)# interface cem0/0	Configures the pseudowire interface to use for the new pseudowire class.

	Command	Purpose
Step 4	<b>cem</b> <i>group-number</i>  <b>Example:</b> Router(config-if)# cem 0	Defines a CEM channel.
Step 5	<b>xconnect</b> <i>peer-loopback-ip-address</i> <b>encapsulation</b> <b>mpls</b>  <b>Example:</b> Router(config-if-cem)# xconnect 10.10.10.20 encapsulation mpls	Binds an attachment circuit to the CEM interface to create a pseudowire.
Step 6	<b>backup peer</b> <i>peer-router-ip-address</i> <i>vcid</i> [ <b>pw-class</b> <i>pw-class-name</i> ]  <b>Example:</b> Router(config-if-cem-xconn)# backup peer 10.10.10.12 10 344	Defines the address and VC of the backup peer.
Step 7	<b>backup delay</b> <i>enable-delay</i> [ <i>disable-delay</i>   <b>never</b> ]  <b>Example:</b> Router(config-if-cem-xconn)# backup delay 30 never	Specifies the delay before the router switches pseudowire traffic to the backup peer VC.  Where: <ul style="list-style-type: none"> <li><i>enable-delay</i>—Time before the backup PW takes over for the primary PW.</li> <li><i>disable-delay</i>—Time before the restored primary PW takes over for the backup PW.</li> <li><b>never</b>—Disables switching from the backup PW to the primary PW.</li> </ul>

## Configuring Structure-Agnostic TDM over Packet

Complete the following steps to configure Structure-Agnostic TDM over Packet (SAToP) on the Cisco ASR 901:

### SUMMARY STEPS

1. **enable**
2. **configure terminal**
3. **controller** {t1 | e1} *slot/port*
4. **cem-group** *group-number* **unframed**
5. **interface** CEM*slot/port*
6. **no ip address**
7. **cem** *group-number*
8. **xconnect** *ip-address* **encapsulation mpls**
9. **exit**

	Command	Purpose
Step 1	<b>enable</b>  <b>Example:</b> Router> enable	Enables privileged EXEC mode. <ul style="list-style-type: none"><li>Enter your password if prompted.</li></ul>
Step 2	<b>configure terminal</b>  <b>Example:</b> Router# configure terminal	Enters global configuration mode.
Step 3	<b>controller {t1 e1} slot/port</b>  <b>Example:</b> Router(config)# controller t1 0/4	Configures the T1 or E1 interface.
Step 4	<b>cem-group group-number unframed</b>  <b>Example:</b> Router(config-if)# cem-group 4 unframed	Assigns channels on the T1 or E1 circuit to the CEM channel. This example uses the <b>unframed</b> parameter to assign all the T1 timeslots to the CEM channel.
Step 5	<b>interface CEMslot/port</b>  <b>Example:</b> Router(config)# interface CEM0/4	Configures the pseudowire interface to use for the new pseudowire class.
Step 6	<b>no ip address</b>  <b>Example:</b> Router(config)# no ip address	Disables the IP address configuration for the physical layer interface.
Step 7	<b>cem group-number</b>  <b>Example:</b> Router(config-if)# cem 4	Defines a CEM group.
Step 8	<b>xconnect ip-address encapsulation mpls</b>  <b>Example:</b> Router(config-if-cem)# xconnect 30.30.30.2 304 encapsulation mpls	Binds an attachment circuit to the CEM interface to create a pseudowire. This example creates a pseudowire by binding the CEM circuit 304 to the remote peer 30.30.2.304.
Step 9	<b>exit</b>  <b>Example:</b> Router(cfg-if-cem-xconn)# exit	Exits configuration mode.

**Note**

When creating IP routes for a pseudowire configuration, we recommend that you build a route from the xconnect address (LDP router-id or loopback address) to the next hop IP address, such as **ip route 30.30.30.2 255.255.255.255 1.2.3.4**.

## Configuring a SAToP Pseudowire with UDP Encapsulation

Complete the following steps to configure a SAToP pseudowire with UDP encapsulation:

### SUMMARY STEPS

1. **enable**
2. **configure terminal**
3. **pseudowire-class** *pseudowire-class-name*
4. **encapsulation udp**
5. **ip local interface loopback** *interface-number*
6. **ip tos value** *value-number*
7. **ip ttl** *number*
8. **controller {e1 | t1}** *slot/port*
9. **cem-group** *group-number* **unframed**
10. **exit**
11. **interface cem** *slot/port*
12. **no ip address**
13. **cem** *group-number*
14. **xconnect** *peer-router-id* *vcid* {**pseudowire-class** *name*}
15. **udp port** *local-udp-port* **remote** *remote-udp-port*
16. **exit**

### DETAILED STEPS

	Command	Purpose
Step 1	<b>enable</b>  <b>Example:</b> Router> enable	Enables privileged EXEC mode. Enter your password if prompted.
Step 2	<b>configure terminal</b>  <b>Example:</b> Router# configure terminal	Enters global configuration mode.
Step 3	<b>pseudowire-class</b> <i>pseudowire-class-name</i>  <b>Example:</b> Router(config)# pseudowire-class udpClass	Creates a new pseudowire class.

	Command	Purpose
Step 4	<b>encapsulation udp</b>  <b>Example:</b> Router(config-pw-class)# encapsulation udp	Specifies the UDP transport protocol.
Step 5	<b>ip local interface loopback</b> <i>interface-number</i>  <b>Example:</b> Router(config-pw-class)# ip local interface Loopback 1	Configures the IP address of the provider edge (PE) router interface as the source IP address for sending tunneled packets.
Step 6	<b>ip tos value</b> <i>value-number</i>  <b>Example:</b> Router(config-pw-class)# ip tos value 100	Specifies the type of service (ToS) level for IP traffic in the pseudowire.
Step 7	<b>ip ttl</b> <i>number</i>  <b>Example:</b> Router(config-pw-class)# ip ttl 100	Specifies a value for the time-to-live (TTL) byte in the IP headers of Layer 2 tunneled packets.
Step 8	<b>controller {e1 t1}</b> <i>slot/port</i>  <b>Example:</b> Router(config)# controller [e1 t1] 0/0	Enters E1/T1 controller configuration mode.
Step 9	<b>cem-group</b> <i>group-number</i> <b>unframed</b>  <b>Example:</b> Router(config-controller)# cem-group 4 unframed	Assigns channels on the T1 or E1 circuit to the CEM channel. This example uses the unframed parameter to assign all the T1 timeslots to the CEM channel.
Step 10	<b>exit</b>  <b>Example:</b> Router(config-controller)# exit	Exits controller configuration.
Step 11	<b>interface cem</b> <i>slot/port</i>  <b>Example:</b> Router(config)# interface CEM0/4	Selects the CEM interface where the CEM circuit (group) is located (where slot/subslot is the SPA slot and subslot and port is the SPA port where the interface exists).
Step 12	<b>no ip address</b>  <b>Example:</b> Router(config)# no ip address	Disables the IP address configuration for the physical layer interface.
Step 13	<b>cem</b> <i>group-number</i>  <b>Example:</b> Router(config-if)# cem 4	Defines a CEM channel.



	Command	Purpose
Step 14	<p><b>xconnect</b> <i>peer-router-id vcid</i> {<i>pseudowire-class name</i>}</p> <p><b>Example:</b> Router(config-if-cem)# xconnect 30.30.30.2 305 pw-class udpClass</p>	<p>Binds an attachment circuit to the CEM interface to create a pseudowire. This example creates a pseudowire by binding the CEM circuit 5 to the remote peer 30.30.30.2.</p> <p><b>Note</b> When creating IP routes for a pseudowire configuration, we recommend that you build a route from the cross-connect address (LDP router-ID or loopback address) to the next hop IP address, such as <b>ip route 30.30.30.2 255.255.255.255 1.2.3.4</b>.</p>
Step 15	<p><b>udp port local</b> &lt;<i>local-udp-port</i>&gt; <b>remote</b> &lt;<i>remote-udp-port</i>&gt;</p> <p><b>Example:</b> Router(config-if-cem-xconn)# udp port local 49150 remote 55000</p>	<p>Specifies a local and remote UDP port for the connection. Valid port values for SAToP pseudowires using UDP are from 49152–57343.</p>
Step 16	<p><b>exit</b></p> <p><b>Example:</b> Router(config-if-cem-xconn)# exit</p>	<p>Exits the CEM interface.</p>
Step 17	<p><b>exit</b></p> <p><b>Example:</b> Router(config-if)# exit</p>	<p>Exits the configuration mode.</p>

## Configuring Circuit Emulation Service over Packet-Switched Network

Complete the following steps to configure Circuit Emulation Service over Packet-Switched Network (CESoPSN):

### SUMMARY STEPS

1. **enable**
2. **configure terminal**
3. **controller {e1 | t1} slot/port**
4. **cem-group group-number timeslots timeslot**
5. **exit**
6. **interface CEMslot/port**
7. **cem group-number**
8. **xconnect ip-address encapsulation mpls**
9. **exit**
10. **end**

### DETAILED STEPS

	Command	Purpose
Step 1	<b>enable</b>  <b>Example:</b> Router> enable	Enables privileged EXEC mode. <ul style="list-style-type: none"> <li>• Enter your password if prompted.</li> </ul>
Step 2	<b>configure terminal</b>  <b>Example:</b> Router# configure terminal	Enters global configuration mode.
Step 3	<b>controller {e1   t1} slot/port</b>  <b>Example:</b> Router(config)# controller [e1   t1] 0/0	Enters configuration mode for an E1 or T1 controller.
Step 4	<b>cem-group 5 timeslots timeslot</b>  <b>Example:</b> Router(config-controller)# cem-group 5 timeslots 1-24	Assigns channels on the T1 or E1 circuit to the circuit emulation (CEM) channel and specific timeslots to the CEM channel. <ul style="list-style-type: none"> <li>• <i>timeslot</i>—The timeslot value for T1 interface is between 1 to 24 and for E1 interface, its between 1 to 31.</li> </ul>
Step 5	<b>exit</b>  <b>Example:</b> Router(config-controller)# exit	Exits controller configuration.

	Command	Purpose
Step 6	<b>interface</b> CEMslot/port  <b>Example:</b> Router(config)# interface CEM0/5	Defines a CEM channel.
Step 7	<b>cem</b> group-number  <b>Example:</b> Router(config-if-cem)# cem 5	Defines a CEM channel.
Step 8	<b>xconnect</b> ip-address encapsulation mpls  <b>Example:</b> Router(config-if-cem)# xconnect 30.30.30.2 305 encapsulation mpls	Binds an attachment circuit to the CEM interface to create a pseudowire. This example creates a pseudowire by binding the CEM circuit 5 to the remote peer 30.30.30.2.  <b>Note</b> When creating IP routes for a pseudowire configuration, we recommend that you build a route from the xconnect address (LDP router-id or loopback address) to the next hop IP address, such as <b>ip route 30.30.30.2 255.255.255.255 1.2.3.4</b> .
Step 9	<b>exit</b>  <b>Example:</b> Router(config-if-cem-xconn)# exit	Exits the CEM interface.
Step 10	<b>end</b>  <b>Example:</b> Router(config-if-cem)# end	Exits configuration mode.

## Configuring a CESoPSN Pseudowire with UDP Encapsulation

Complete the following steps to configure a CESoPSN pseudowire with UDP encapsulation:

### SUMMARY STEPS

1. **enable**
2. **configure terminal**
3. **pseudowire-class** *pseudowire-class-name*
4. **encapsulation udp**
5. **ip local interface loopback** *interface-number*
6. **ip tos value** *value-number*
7. **ip ttl** *number*
8. **exit**
9. **controller {e1 | t1}** *slot/port*
10. **cem-group** *number timeslots number*
11. **exit**
12. **interface cem** *slot/port*
13. **no ip address**

14. **cem** *group-number*
15. **xconnect** *peer-router-id vcid {pseudowire-class name}*
16. **udp port** *local local\_udp\_port remote remote\_udp\_port*
17. **end**

## DETAILED STEPS

	Command	Purpose
Step 1	<b>enable</b>  <b>Example:</b> Router> enable	Enables privileged EXEC mode. <ul style="list-style-type: none"><li>Enter your password if prompted.</li></ul>
Step 2	<b>configure terminal</b>  <b>Example:</b> Router# configure terminal	Enters global configuration mode.
Step 3	<b>pseudowire-class</b> <i>pseudowire-class-name</i>  <b>Example:</b> Router(config)# pseudowire-class udpClass	Creates a new pseudowire class.
Step 4	<b>encapsulation udp</b>  <b>Example:</b> Router(config-pw-class)# encapsulation udp	Specifies the UDP transport protocol.
Step 5	<b>ip local interface loopback</b> <i>interface-number</i>  <b>Example:</b> Router(config-pw-class)# ip local interface loopback1	Configures the IP address of the provider edge (PE) router interface as the source IP address for sending tunneled packets.
Step 6	<b>ip tos value</b> <i>value-number</i>  <b>Example:</b> Router(config-pw-class)# ip tos value 100	Specifies the type of service (ToS) level for IP traffic in the pseudowire.
Step 7	<b>ip ttl</b> <i>number</i>  <b>Example:</b> Router(config-pw-class)# ip ttl 100	Specifies a value for the time-to-live (TTL) byte in the IP headers of Layer 2 tunneled packets.
Step 8	<b>exit</b>  <b>Example:</b> Router(config-pw-class)# exit	Exits pseudowire-class configuration mode.

	Command	Purpose
Step 9	<code>controller {e1 t1} slot/port</code>  <b>Example:</b> Router(config)# controller e1 0/0	Enters E1/T1 controller configuration mode.
Step 10	<code>cem-group number timeslots number</code>  <b>Example:</b> Router(config-controller)# cem-group 5 timeslots 1-24	Assigns channels on the T1 or E1 circuit to the CEM channel. This example uses the unframed parameter to assign all the T1 timeslots to the CEM channel.
Step 11	<code>exit</code>  <b>Example:</b> Router(config-controller)# exit	Exits controller configuration.
Step 12	<code>interface cem slot/port</code>  <b>Example:</b> Router(config)# interface CEM 0/5	Selects the CEM interface where the CEM circuit (group) is located (where slot/subslot is the SPA slot and subslot and port is the SPA port where the interface exists).
Step 13	<code>no ip address</code>  <b>Example:</b> Router(config)# no ip address	Disables the IP address configuration for the physical layer interface.
Step 14	<code>cem group-number</code>  <b>Example:</b> Router(config-if)# cem 5	Defines a CEM channel.
Step 15	<code>xconnect peer-router-id vcid {pseudowire-class name}</code>  <b>Example:</b> Router(config-if-cem)# xconnect 30.30.30.2 305 pw-class udpClass	Binds an attachment circuit to the CEM interface to create a pseudowire. This example creates a pseudowire by binding the CEM circuit 5 to the remote peer 30.30.30.2.  <b>Note</b> When creating IP routes for a pseudowire configuration, we recommend that you build a route from the cross-connect address (LDP router-ID or loopback address) to the next hop IP address, such as <b>ip route 30.30.30.2 255.255.255.255 1.2.3.4</b> .
Step 16	<code>udp port local local_udp_port remote remote_udp_port</code>  <b>Example:</b> Router(config-if-cem-xconn)# udp port local 49150 remote 55000	Specifies a local and remote UDP port for the connection. Valid port values for CESoPSN pseudowires using UDP are from 49152–57343.
Step 17	<code>end</code>  <b>Example:</b> Router(config-if-cem)# end	Exits the configuration mode.

## QoS for CESoPSN over UDP and SAToP over UDP

Cisco ASR 901 router supports IP DSCP and IP Precedence via service-policy and Type of Service (ToS) setting in pseudowire-class.

The ToS setting in pseudowire-class is optional. If a quality of service (QoS) policy with DSCP and IP Precedence value is applied on the cem circuit that has a ToS setting (via pseudowire-class), then the DSCP IP Precedence setting at the service policy is applied. Hence, the service-policy overrides the QoS configuration that is set through the pseudowire-class.

### Example

```
Router(config)#pseudowire-class pw-udp
Router(config-pw-class)#ip tos value tos-value

Router(config)#policy-map policy-Qos
Router(config-pmap)#class class-default
Router(config-pmap-c)#set ip precedence precedence-value
Router(config-pmap-c)#set ip dscp dscp-value
Router(config-pmap-c)#set qos-group qos-group-value

Router(config)#interface cem 0/0
Router(config-if)#cem 0
Router(config-if-cem)#service-policy input policy-Qos
Router(config-if-cem)#xconnect 180.0.0.201 29 pw-class pw-udp
Router(cfg-if-cem-xconn)#udp port local 49152 remote 49152
```

The **set qos-group** command is used to set the mpls experimental bit for the vc label, if no action on egress is copied to the outer mpls label experimental bit.



### Note

For details on configuring QoS in Cisco ASR 901, see [Configuring QoS](#).

## Configuring Transportation of Service Using Ethernet over MPLS

Ethernet over MPLS PWs allow you to transport Ethernet traffic over an existing MPLS network. For an overview of Ethernet over MPLS pseudowires, see [Transportation of Service Using Ethernet over MPLS, page 21-3](#).

Complete the following steps to configure an Ethernet over MPLS pseudowire:

### SUMMARY STEPS

1. **enable**
2. **configure terminal**
3. **interface GigabitEthernet***slot/port*
4. **service instance** *instance-number* **ethernet**
5. **encapsulation dot1q** *encapsulation-type*
6. **rewrite ingress tag pop 1 symmetric**
7. **xconnect** *ip-address* **encapsulation mpls**
8. **end**

## DETAILED STEPS

	Command	Purpose
Step 1	<b>enable</b>  <b>Example:</b> Router> enable	Enables privileged EXEC mode. <ul style="list-style-type: none"> <li>Enter your password if prompted.</li> </ul>
Step 2	<b>configure terminal</b>  <b>Example:</b> Router# configure terminal	Enters global configuration mode.
Step 3	<b>interface GigabitEthernet</b> <i>slot/port</i>  <b>Example:</b> Router(config)# interface GigabitEthernet0/2	Specifies an interface to configure.
Step 4	<b>service instance</b> <i>instance-number</i> <b>ethernet</b>  <b>Example:</b> Router(config-if)# service instance 101 ethernet	Configures a service instance and enters the service instance configuration mode.
Step 5	<b>encapsulation dot1q</b> <i>encapsulation-type</i>  <b>Example:</b> Router(config-if-srv)# encapsulation dot1q 101	Configures encapsulation type for the service instance.
Step 6	<b>rewrite ingress tag pop 1 symmetric</b>  <b>Example:</b> Router(config-if-srv)# rewrite ingress tag pop 1 symmetric	Specifies the encapsulation modification to occur on packets at ingress as follows: <ul style="list-style-type: none"> <li><b>pop 1</b>—Pop (remove) the outermost tag.</li> <li><b>symmetric</b>—Configure the packet to undergo the reverse of the ingress action at egress. If a tag is popped at ingress, it is pushed (added) at egress.</li> </ul> <p><b>Note</b> Although the <b>symmetric</b> keyword appears to be optional, you must enter it for <b>rewrite</b> to function correctly.</p>
Step 7	<b>xconnect</b> <i>ip-address</i> <b>encapsulation</b> <b>mpls</b>  <b>Example:</b> Router(config-if-srv)# xconnect 11.205.1.1 141 encapsulation mpls	Binds the VLAN attachment circuit to an Any Transport over MPLS (AToM) pseudowire for EoMPLS.
Step 8	<b>end</b>  <b>Example:</b> Router(config-if-srv)# end	Returns to privileged EXEC mode.

# Configuring L2VPN Pseudowire Redundancy

The Cisco ASR 901 router supports the L2VPN pseudowire redundancy feature that provides backup service for circuit emulation (CEM) pseudowires. This feature enables the network to detect a failure, and reroute the Layer 2 (L2) service to another endpoint that can continue to provide the service. This feature also provides the ability to recover from a failure: either the failure of the remote PE router, or of the link between the PE and the CE routers.

Configure pseudowire redundancy by configuring two pseudowires for the CEM interface: a primary pseudowire and a backup (standby) pseudowire. If the primary pseudowire goes down, the router uses the backup pseudowire in its place. When the primary pseudowire comes back up, the backup pseudowire is brought down and the router resumes using the primary.

Figure 21-2 shows an example of pseudowire redundancy.

**Figure 21-2 Pseudowire Redundancy**

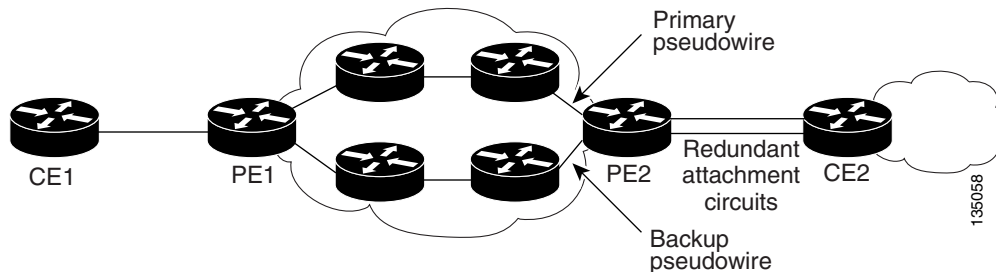

### Note

You must configure the backup pseudowire to connect to a different router than the primary pseudowire.

Complete the following steps to configure pseudowire redundancy on a CEM interface.

	Command	Purpose
Step 1	<code>enable</code>	Enables privileged EXEC mode. <ul style="list-style-type: none"> <li>Enter your password if prompted.</li> </ul>
	<b>Example:</b> <code>Router&gt; enable</code>	
Step 1	<code>configure terminal</code>	Enters global configuration mode.
	<b>Example:</b> <code>Router# configure terminal</code>	
Step 2	<code>controller {e1   t1} slot/port</code>	Selects an E1 or T1 controller.
	<b>Example:</b> <code>Router(config)# controller t1 0/1</code>	
Step 3	<code>[number] cem-group group-number {unframed   timeslots timeslot}</code>	Creates a CEM interface and assigns it a CEM group number.
	<b>Example:</b> <code>Router(config-controller)# cem-group 5 timeslots 30</code>	



	Command	Purpose
Step 4	<b>framing</b> {sf   esf}  <b>Example:</b> Router(config-controller)# framing esf	Selects the T1 framing type.
Step 5	<b>exit</b>  <b>Example:</b> Router(config-controller)# exit	Exits the controller configuration mode.
Step 6	<b>interface</b> cemslot/port  <b>Example:</b> Router(config)# interface cem0/0	Configures the pseudowire interface to use for the new pseudowire class.
Step 7	<b>cem</b> group-number  <b>Example:</b> Router(config-if)# cem 0	Configures the pseudowire interface to use for the new pseudowire class.
Step 8	<b>xconnect</b> peer-router-id vcid {encapsulation mpls   pw-class pw-class-name}  <b>Example:</b> xconnect 10.10.10.11 344 encapsulation mpls	Configures a pseudowire to transport TDM data from the CEM circuit across the MPLS network. <ul style="list-style-type: none"> <li>• <i>peer-router-id</i> is the IP address of the remote PE peer router.</li> <li>• <i>vcid</i> is a 32-bit identifier to assign to the pseudowire. The same <i>vcid</i> must be used for both ends of the pseudowire.</li> <li>• <b>encapsulation mpls</b> sets MPLS for tunneling mode.</li> <li>• <i>pw-class-name</i> specifies a pseudowire class that includes the <code>encapsulation mpls</code> command.</li> </ul> <p><b>Note</b> The <i>peer-router-id</i> and <i>vcid</i> combination must be unique on the router.</p>
Step 9	<b>backup peer</b> peer-router-ip-address vcid [pw-class pw-class-name]  <b>Example:</b> Router(config-if-xcon)# backup peer 10.10.10.11 344 [pw-class pwclass1]	Specifies a redundant peer for the pseudowire VC.  The pseudowire class name must match the name specified when you created the pseudowire class, but you can use a different <i>pw-class</i> in the <code>backup peer</code> command than the name used in the primary <code>xconnect</code> command.
Step 10	<b>backup delay</b> enable-delay {disable-delay   never}  <b>Example:</b> Router(config-if-xcon)# backup delay 30 60	<ul style="list-style-type: none"> <li>• <code>enable delay</code>—Specifies how long (in seconds) the backup pseudowire VC should wait to take over, after the primary pseudowire VC goes down. The range is 0 to 180.</li> <li>• <code>disable delay</code>—Specifies how long the primary pseudowire should wait, after it becomes active to take over for the backup pseudowire VC. The range is 0 to 180 seconds. If you specify the <code>never</code> keyword, the primary pseudowire VC never takes over for the backup.</li> </ul>

## Example: Pseudowire Redundancy

This example shows pseudowire redundancy configured for a CEM circuit (group). In the example, the `xconnect` command configures a primary pseudowire for CEM group 0. The `backup peer` command creates a redundant pseudowire for the group.

```
int cem 0/1
no ip address
cem 0
xconnect 10.10.10.1 1 encaps mpls
backup peer 10.10.10.2 200
exit
```

# Configuring Hot Standby Pseudowire Support for ATM/IMA

This section describes how to configure ATM/IMA pseudowire redundancy:

- [Configuring ATM/IMA Pseudowire Redundancy in PVC Mode](#)
- [Configuring ATM/IMA Pseudowire Redundancy in PVP Mode](#)
- [Configuring ATM/IMA Pseudowire Redundancy in Port Mode](#)
- [Verifying Hot Standby Pseudowire Support for ATM/IMA](#)



### Note

Both the primary and backup pseudowires must be provisioned for the Hot Standby Pseudowire Support feature to work.

## Configuring ATM/IMA Pseudowire Redundancy in PVC Mode

Complete the following steps to configure pseudowire redundancy in permanent virtual circuit (PVC) mode.

### SUMMARY STEPS

1. **enable**
2. **configure terminal**
3. **interface** *interface-name*
4. **pvc** *vpi/vci* **l2transport**
5. **encapsulation** { *aal0* | *aal5* }
6. **xconnect** *peer-ip-address* *vc-id* **encapsulation** **mpls**
7. **backup peer** *peer-router-ip-addr* *vcid*

## DETAILED STEPS

	Command	Purpose
Step 1	<b>enable</b>  <b>Example:</b> Router> enable	Enables privileged EXEC mode. <ul style="list-style-type: none"> <li>Enter your password if prompted.</li> </ul>
Step 2	<b>configure terminal</b>  <b>Example:</b> Router# configure terminal	Enters global configuration mode.
Step 3	<b>interface</b> <i>interface-name</i>  <b>Example:</b> Router(config)# interface ATM0/IMA1	Selects the interface. <ul style="list-style-type: none"> <li><i>interface-name</i>—Name of the interface</li> </ul>
Step 4	<b>pvc</b> <i>vpi/vci</i> <b>l2transport</b>  <b>Example:</b> Router(config-if)# pvc 90/90 l2transport	Create or assigns a name to an ATM permanent virtual circuit (PVC), to specify the encapsulation type on an ATM PVC. <ul style="list-style-type: none"> <li><i>vpi</i>—ATM network virtual path identifier (VPI) for this PVC.</li> <li><i>vci</i>—ATM network virtual channel identifier (VCI) for this PVC.</li> </ul>
Step 5	<b>encapsulation</b> { <i>aal0</i>   <i>aal5</i> }  <b>Example:</b> Router(config-if)# encapsulation aal0	Configures the ATM adaptation layer ( AAL) and encapsulation type for an ATM virtual circuit (VC), VC class , VC, bundle, or permanent virtual circuit (PVC) range.
Step 6	<b>xconnect</b> <i>peer-ip-address</i> <i>vc-id</i> <b>encapsulation</b> <i>mpls</i>  <b>Example:</b> Router(config-if-srv)# xconnect 192.168.1.12 100 encapsulation mpls	Binds an attachment circuit to a pseudowire. <ul style="list-style-type: none"> <li><i>peer-ip-address</i>—IP address of the remote provider edge (PE) peer. The remote router ID can be any IP address, as long as it is reachable.</li> <li><i>vcid</i>—32-bit identifier of the VC between the routers at each end of the layer control channel.</li> <li><b>encapsulation</b>—Specifies the tunneling method to encapsulate the data in the pseudowire.</li> </ul>
Step 7	<b>backup peer</b> <i>peer-router-ip-addr</i> <i>vcid</i>  <b>Example:</b> Router(config-if-xconn)# backup peer 170.0.0.201 200	Specifies a redundant peer for a pseudowire virtual circuit (VC). <ul style="list-style-type: none"> <li><i>peer-router-id</i>—IP address of the remote peer router.</li> <li><i>vcid</i>—32-bit identifier of the VC between the routers at each end of the layer control channel.</li> </ul>

## Configuring ATM/IMA Pseudowire Redundancy in PVP Mode

Complete the following steps to configure pseudowire redundancy in permanent virtual path (PVP) mode.

### SUMMARY STEPS

1. **enable**
2. **configure terminal**
3. **interface** *interface-name*
4. **atm pvp vpi l2transport**
5. **xconnect** *peer-ip-address vc-id encapsulation mpls*
6. **backup peer** *peer-router-ip-addr vcid*

### DETAILED STEPS

	Command	Purpose
Step 1	<b>enable</b>  <b>Example:</b> Router> enable	Enables privileged EXEC mode. <ul style="list-style-type: none"> <li>• Enter your password if prompted.</li> </ul>
Step 2	<b>configure terminal</b>  <b>Example:</b> Router# configure terminal	Enters global configuration mode.
Step 3	<b>interface</b> <i>interface-name</i>  <b>Example:</b> Router(config)# interface ATM0/IMA1	Selects the interface. <ul style="list-style-type: none"> <li>• <i>interface-name</i>—Name of the interface</li> </ul>
Step 4	<b>atm pvp vpi l2transport</b>  <b>Example:</b> Router(config-if)# atm pvp 90 l2transport	Creates a permanent virtual path (PVP) used to multiplex (or bundle) one or more virtual circuits (VCs). <ul style="list-style-type: none"> <li>• <i>vpi</i>—ATM network virtual path identifier (VPI) of the VC to multiplex on the permanent virtual path.</li> <li>• <b>l2transport</b>—Specifies that the PVP is for the Any Transport over MPLS (AToM) ATM cell relay feature or the ATM Cell Relay over L2TPv3 feature.</li> </ul>

	Command	Purpose
Step 5	<b>xconnect</b> <i>peer-ip-address</i> <i>vc-id</i> <b>encapsulation</b> <i>mpls</i>  <b>Example:</b> Router(config-if)# xconnect 192.168.1.12 100 encapsulation mpls	Binds an attachment circuit to a pseudowire, and to configure an Any Transport over MPLS (AToM) static pseudowire. <ul style="list-style-type: none"> <li><i>peer-ip-address</i>—IP address of the remote provider edge (PE) peer. The remote router ID can be any IP address, as long as it is reachable.</li> <li><i>vcid</i>—32-bit identifier of the VC between the routers at each end of the layer control channel.</li> <li><b>encapsulation</b>—Specifies the tunneling method to encapsulate the data in the pseudowire.</li> </ul>
Step 6	<b>backup peer</b> <i>peer-router-ip-addr</i> <i>vcid</i>  <b>Example:</b> Router(config-if-xconn)# backup peer 170.0.0.201 200	Specifies a redundant peer for a pseudowire virtual circuit (VC). <ul style="list-style-type: none"> <li><i>peer-router-id</i>—IP address of the remote peer router.</li> <li><i>vcid</i>—32-bit identifier of the VC between the routers at each end of the layer control channel.</li> </ul>

## Configuring ATM/IMA Pseudowire Redundancy in Port Mode

Complete the following steps to configure pseudowire redundancy in port mode.

### SUMMARY STEPS

1. **enable**
2. **configure terminal**
3. **interface** *interface-name*
4. **xconnect** *peer-ip-address* *vc-id* **encapsulation** *mpls*
5. **backup peer** *peer-router-ip-addr* *vcid*

### DETAILED STEPS

	Command	Purpose
Step 1	<b>enable</b>  <b>Example:</b> Router> enable	Enables privileged EXEC mode. <ul style="list-style-type: none"> <li>Enter your password if prompted.</li> </ul>
Step 2	<b>configure terminal</b>  <b>Example:</b> Router# configure terminal	Enters global configuration mode.
Step 3	<b>interface</b> <i>interface-name</i>  <b>Example:</b> Router(config)# interface ATM0/IMA1	Selects the interface. <ul style="list-style-type: none"> <li><i>interface-name</i>—Name of the interface</li> </ul>

	Command	Purpose
Step 4	<b>xconnect</b> <i>peer-ip-address</i> <i>vc-id</i> <b>encapsulation</b> <i>mpls</i>  <b>Example:</b> Router(config-if)# xconnect 192.168.1.12 100 encapsulation mpls	Binds an attachment circuit to a pseudowire, and to configure an Any Transport over MPLS (AToM) static pseudowire. <ul style="list-style-type: none"> <li>• <i>peer-ip-address</i>—IP address of the remote provider edge (PE) peer. The remote router ID can be any IP address, as long as it is reachable.</li> <li>• <i>vcid</i>—32-bit identifier of the VC between the routers at each end of the layer control channel.</li> <li>• <b>encapsulation</b>—Specifies the tunneling method to encapsulate the data in the pseudowire.</li> </ul>
Step 5	<b>backup peer</b> <i>peer-router-ip-addr</i> <i>vcid</i>  <b>Example:</b> Router(config-if-xconn)# backup peer 170.0.0.201 200	Specifies a redundant peer for a pseudowire virtual circuit (VC). <ul style="list-style-type: none"> <li>• <i>peer-router-ip-addr</i>—IP address of the remote peer router.</li> <li>• <i>vcid</i>—32-bit identifier of the VC between the routers at each end of the layer control channel.</li> </ul>

## Verifying Hot Standby Pseudowire Support for ATM/IMA

To verify the configuration of Hot Standby Pseudowire Support for ATM/IMA, use the **show** commands as shown in the following examples.

```
Router# show mpls l2transport vc 90
```

```
Local intf      Local circuit          Dest address      VC ID      Status
-----
AT0/IMA1       ATM VPC CELL 90       2.2.2.2         90         STANDBY
AT0/IMA1       ATM VPC CELL 90       180.0.0.201     90         UP
```

```
Router# show mpls l2transport vc detail
```

```
ASR901-PE2#sh mpls l2 vc 90 deta
Local interface: AT0/IMA1 up, line protocol up, ATM VPC CELL 90 up
Destination address: 2.2.2.2, VC ID: 90, VC status: standby
Output interface: V1500, imposed label stack {22 17}
Preferred path: not configured
Default path: active
Next hop: 150.1.1.201
Create time: 5d02h, last status change time: 2d17h
Last label FSM state change time: 5d02h
Signaling protocol: LDP, peer 2.2.2.2:0 up
Targeted Hello: 170.0.0.201(LDP Id) -> 2.2.2.2, LDP is UP
Graceful restart: not configured and not enabled
Non stop routing: not configured and not enabled
Status TLV support (local/remote) : enabled/supported
LDP route watch : enabled
Label/status state machine : established, LrdRru
Last local dataplane status rcvd: No fault
Last BFD dataplane status rcvd: Not sent
Last BFD peer monitor status rcvd: No fault
Last local AC circuit status rcvd: DOWN(standby)
Last local AC circuit status sent: No fault
Last local PW i/f circ status rcvd: No fault
Last local LDP TLV status sent: DOWN(standby)
Last remote LDP TLV status rcvd: No fault
Last remote LDP ADJ status rcvd: No fault
MPLS VC labels: local 17, remote 17
Group ID: local 0, remote 0
```

```

MTU: local n/a, remote n/a
Remote interface description:
Sequencing: receive disabled, send disabled
Control Word: On (configured: autosense)
Dataplane:
  SSM segment/switch IDs: 28683/16387 (used), PWID: 4
VC statistics:
  transit packet totals: receive 0, send 0
  transit byte totals:   receive 0, send 0
  transit packet drops: receive 0, seq error 0, send 0

Local interface: AT0/IMA1 up, line protocol up, ATM VPC CELL 90 up
Destination address: 180.0.0.201, VC ID: 90, VC status: up
Output interface: V1300, imposed label stack {21}
Preferred path: not configured
Default path: active
Next hop: 110.1.1.202
Create time: 5d02h, last status change time: 2d17h
Last label FSM state change time: 2d17h
Signaling protocol: LDP, peer 180.0.0.201:0 up
Targeted Hello: 170.0.0.201(LDP Id) -> 180.0.0.201, LDP is UP
Graceful restart: not configured and not enabled
Non stop routing: not configured and not enabled
Status TLV support (local/remote)   : enabled/supported
  LDP route watch                    : enabled
  Label/status state machine         : established, LruRru
  Last local dataplane status rcvd: No fault
  Last BFD dataplane status rcvd: Not sent
  Last BFD peer monitor status rcvd: No fault
  Last local AC circuit status rcvd: No fault
  Last local AC circuit status sent: No fault
  Last local PW i/f circ status rcvd: No fault
  Last local LDP TLV status sent: No fault
  Last remote LDP TLV status rcvd: No fault
  Last remote LDP ADJ status rcvd: No fault
MPLS VC labels: local 16, remote 21
Group ID: local 0, remote 0
MTU: local n/a, remote n/a
Remote interface description:
Sequencing: receive disabled, send disabled
Control Word: On (configured: autosense)
Dataplane:
  SSM segment/switch IDs: 4110/12290 (used), PWID: 3
VC statistics:
  transit packet totals: receive 0, send 0
  transit byte totals:   receive 0, send 0
  transit packet drops: receive 0, seq error 0, send 0

packet drops: receive 0, send 0

```

## TDM Local Switching

Time Division Multiplexing (TDM) Local Switching allows switching of layer 2 data between two CEM interfaces on the same router.



### Note

Effective with 15.2(2)SNH1 release, you can configure local switching on the T1 or E1 mode.

## Restrictions

- Auto-provisioning is not supported.
- Out-of-band signaling is not supported.
- Redundancy is not supported.
- Interworking with other interface types other than CEM is not supported.
- The same CEM circuit cannot be used for both local switching and cross-connect.
- You cannot use CEM local switching between two CEM circuits on the same CEM interface.
- Local switching is not supported in unframed mode.
- Local switching with channelized CEM interface is not supported.
- Modifications to payload size, dejitter buffer, idle pattern, and service policy CEM interface parameters are not supported.

## Configuring TDM Local Switching on a T1/E1 Mode

To configure local switching on a T1 or E1 mode, complete the following steps:

### SUMMARY STEPS

1. **enable**
2. **configure terminal**
3. **interface cemslot/port**
4. **connect name cemslot/port interface-name cemslot/port interface-name**

### DETAILED STEPS

	Command	Purpose
Step 1	<b>enable</b>  <b>Example:</b> Router> enable	Enables privileged EXEC mode. <ul style="list-style-type: none"> <li>• Enter your password if prompted.</li> </ul>
Step 2	<b>configure terminal</b>  <b>Example:</b> Router# configure terminal	Enters global configuration mode.



	Command	Purpose
Step 3	<code>interface cemslot/port</code>	Selects the CEM interface to configure the pseudowire.
	<b>Example:</b> Router(config)# interface cem0/3	
Step 4	<code>connect connection-name</code> <code>cemslot/port interface-name</code> <code>cemslot/port interface-name</code>	Configures a local switching connection between the first and the second CEM interfaces. The <b>no</b> form of this command unconfigures the connection.
	<b>Example:</b> Router(config)# connect myconn CEM0/0 0 CEM0/1 0	

## Verifying Local Switching

To verify local switching on a T1/E1 mode, use the **show connection**, **show connection all**, **show connection id** or **show connection name** command.

```
Router# show connection
ID   Name           Segment 1           Segment 2           State
=====
1    myconn         CE0/0 CESP 0       CE0/1 CESP 0       UP

Router# show connection all
ID   Name           Segment 1           Segment 2           State
=====
1    myconn         CE0/0 CESP 0       CE0/1 CESP 0       UP
2    myconn1        CE0/1 CESP 1       CE0/0 CESP 1       UP

Router# show connection name myconn
Connection: 1 - myconn
Current State: UP
Segment 1: CEM0/0 CESoPSN Basic 0 up
Segment 2: CEM0/1 CESoPSN Basic 0 up

Router# show connection id 1
Connection: 1 - myconn
Current State: UP
Segment 1: CEM0/0 CESoPSN Basic 0 up
Segment 2: CEM0/1 CESoPSN Basic 0 up
```

## Configuration Example for Local Switching

The following is a sample configuration of local switching:

```
!
controller T1 0/0
  cem-group 0 timeslots 1-24
!
controller T1 0/1
  cem-group 0 timeslots 1-24
!
!
interface CEM0/0
```

```

no ip address
cem 0
!
!
interface CEM0/1
no ip address
cem 0
!
!
connect myconn CEM0/0 0 CEM0/1 0
!

```

## Configuration Examples of Hot Standby Pseudowire Support for ATM/IMA

This section provides sample configuration examples of Hot Standby Pseudowire Support for ATM/IMA on the Cisco ASR 901 router:

- [Example: Configuring ATM/IMA Pseudowire Redundancy in PVC Mode](#)
- [Example: Configuring ATM/IMA Pseudowire Redundancy in PVP Mode](#)
- [Example: Configuring ATM/IMA Pseudowire Redundancy in Port Mode](#)

### Example: Configuring ATM/IMA Pseudowire Redundancy in PVC Mode

The following is a sample configuration of ATM/IMA pseudowire redundancy in PVC mode.

```

!
interface ATM0/IMA1
pvc 90/90 l2transport
encapsulation aal0
xconnect 192.168.1.12 100 encapsulation mpls
backup peer 170.0.0.201 200
!

```

### Example: Configuring ATM/IMA Pseudowire Redundancy in PVP Mode

The following is a sample configuration of ATM/IMA pseudowire redundancy in PVP mode.

```

!
interface ATM0/IMA1
atm pvp 90 l2transport
xconnect 192.168.1.12 100 encapsulation mpls
    backup peer 170.0.0.201 200
!

```

## Example: Configuring ATM/IMA Pseudowire Redundancy in Port Mode

The following is a sample configuration of ATM/IMA pseudowire redundancy in port mode.

```
!
interface ATM0/IMA1
xconnect 192.168.1.12 100 encapsulation mpls
      backup peer 170.0.0.201 200
!
```

## Configuration Examples for Pseudowire

This section contains the following examples:

- [Example: TDM over MPLS Configuration-Example, page 21-31](#)
- [Example: CESoPSN with UDP, page 21-34](#)
- [Example: Ethernet over MPLS, page 21-35](#)

## Example: TDM over MPLS Configuration-Example

[Figure 21-3](#) shows a TDM over MPLS configuration. The configuration uses CESoPSN for E1.

**Figure 21-3** TDM over MPLS Configuration

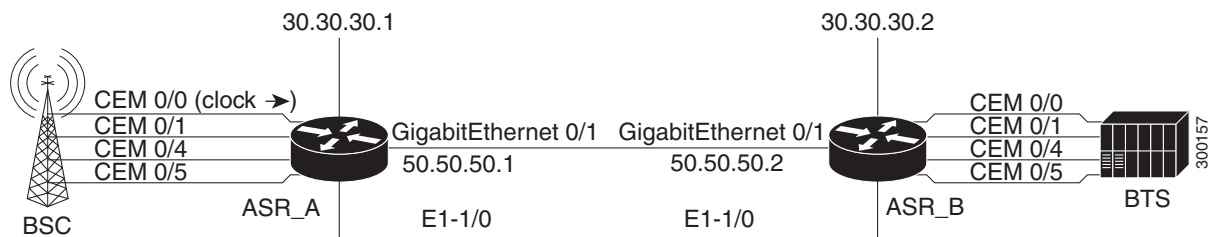

### ASR\_A

```
!
version 12.4
service timestamps debug datetime msec localtime show-timezone
service timestamps log datetime msec localtime show-timezone
no service password-encryption
!
hostname asr_A
!
boot-start-marker
boot-end-marker
!
card type e1 0 0
enable password xxx
!
no aaa new-model
clock timezone est -5
!
```

```

ip cef
!
controller E1 0/0
clock source internal
cem-group 0 timeslots 1-31
description E1 CESoPSN example
!
controller E1 0/1
clock source internal
cem-group 1 unframed
description E1 SATOP example
!
controller E1 0/4
clock source internal
cem-group 4 unframed
description E1 SATOP example
!
controller E1 0/5
clock source internal
cem-group 5 timeslots 1-24
description E1 CESoPSN example
!
interface Loopback0
ip address 30.30.30.1 255.255.255.255
!
interface GigabitEthernet0/1
no negotiation auto
service instance 2 ethernet
encapsulation untagged
bridge-domain 100
!
!
interface CEM0/0
no ip address
cem 0
xconnect 30.30.30.2 300 encapsulation mpls
!
!
interface CEM0/1
no ip address
cem 1
xconnect 30.30.30.2 301 encapsulation mpls
!
!
interface CEM0/4
no ip address
cem 4
xconnect 30.30.30.2 304 encapsulation mpls
!
!
interface CEM0/5
no ip address
cem 5
xconnect 30.30.30.2 305 encapsulation mpls
!
!
interface Vlan100
ip address 50.50.50.1 255.255.255.0
mpls ip
!
router ospf 1
network 50.50.50.0 0.0.0.255 area 0
network 30.30.30.1 0.0.0.0 area 0
!

```

```

no ip http server
no ip http secure-server
!
line con 0
password xxx
login
line aux 0
password xxx
login
no exec
line vty 0 4
password xxx
login
!
network-clock input-source 1 external 0/0/0 e1 crc4
end

```

### ASR\_B

```

!
version 12.4
service timestamps debug datetime msec localtime show-timezone
service timestamps log datetime msec localtime show-timezone
no service password-encryption
!
hostname asr_B
!
boot-start-marker
boot-end-marker
!
card type e1 0 0
enable password xxx
!
no aaa new-model
clock timezone est -5
!
ip cef
!
controller E1 0/0
clock source internal
cem-group 0 timeslots 1-31
description E1 CESoPSN example
!
controller E1 0/1
clock source internal
cem-group 1 unframed
description E1 SATOP example
!
controller E1 0/4
clock source internal
cem-group 4 unframed
description T1 SATOP example
!
controller E1 0/5
clock source internal
cem-group 5 timeslots 1-24
description T1 CESoPSN example
!
interface Loopback0
ip address 30.30.30.2 255.255.255.255
!
interface GigabitEthernet0/1
no negotiation auto
service instance 2 ethernet

```

```

encapsulation untagged
bridge-domain 100
!
!
interface CEM0/0
no ip address
cem 0
xconnect 30.30.30.1 300 encapsulation mpls
!
!
interface CEM0/1
no ip address
cem 1
xconnect 30.30.30.1 301 encapsulation mpls
!
!
interface CEM0/4
no ip address
cem 4
xconnect 30.30.30.1 304 encapsulation mpls
!
!
interface CEM0/5
no ip address
cem 5
xconnect 30.30.30.1 305 encapsulation mpls
!
!
interface Vlan100
ip address 50.50.50.2 255.255.255.0
mpls ip
!
router ospf 1
network 50.50.50.0 0.0.0.255 area 0
network 30.30.30.2 0.0.0.0 area 0
!
no ip http server
no ip http secure-server
!
line con 0
password xxx
login
line aux 0
password xxx
login
no exec
line vty 0 4
password xxx
login
!
network-clock input-source 1 controller e1 0/0
end

```

## Example: CESoPSN with UDP

The following configuration uses CESoPSN with UDP encapsulation.



### Note

---

This section provides a partial configuration intended to demonstrate a specific feature.

---

```

interface Loopback0
ip address 2.2.2.8 255.255.255.255
!
pseudowire-class udpClass
encapsulation udp
protocol none
ip local interface Loopback 0
!
controller E1 0/13
clock source internal
cem-group 0 timeslots 1-31
!
interface cem 0/13
cem 0
xconnect 2.2.2.9 200 pw-class udpClass
udp port local 50000 remote 55000

```

## Example: Ethernet over MPLS

The following configuration example shows an Ethernet pseudowire (aka EoMPLS) configuration.

```

interface Loopback0
description for_mpls_ldp
ip address 99.99.99.99 255.255.255.255
!
interface GigabitEthernet0/10
description Core_facing
no negotiation auto
service instance 150 ethernet
encapsulation dot1q 150
rewrite ingress tag pop 1 symmetric
bridge-domain 150
!
interface GigabitEthernet0/11
description Core_facing
service instance 501 ethernet
encapsulation dot1q 501
rewrite ingress tag pop 1 symmetric
xconnect 111.0.1.1 501 encapsulation mpls
!
interface FastEthernet0/0
ip address 10.104.99.74 255.255.255.0
full-duplex
!
interface Vlan1
!
interface Vlan150
ip address 150.0.0.1 255.255.255.0
mpls ip
!
router ospf 7
network 99.99.99.99 0.0.0.0 area 0
network 150.0.0.0 0.0.0.255 area 0
!
no ip http server
ip route 10.0.0.0 255.0.0.0 10.104.99.1
!
logging esm config
!
mpls ldp router-id Loopback0 force
!
!end

```

# Additional References

The following sections provide references related to inverse multiplexing over ATM.

## Related Documents

Related Topic	Document Title
Cisco IOS Commands	<i>Cisco IOS Master Commands List, All Releases</i>
ASR 901 Command Reference	<i>Cisco ASR 901 Series Aggregation Services Router Command Reference</i>
Cisco IOS Interface and Hardware Component Commands	<i>Cisco IOS Interface and Hardware Component Command Reference</i>

## Standards

Standard	Title
None	—

## MIBs

MIB	MIBs Link
IMA-MIB	To locate and download MIBs for selected platforms, Cisco IOS releases, and feature sets, use Cisco MIB Locator found at the following URL: <a href="http://www.cisco.com/go/mibs">http://www.cisco.com/go/mibs</a>

## RFCs

RFC	Title
None	—

## Technical Assistance

Description	Link
The Cisco Technical Support website contains thousands of pages of searchable technical content, including links to products, technologies, solutions, technical tips, and tools. Registered Cisco.com users can log in from this page to access even more content.	<a href="http://www.cisco.com/techsupport">http://www.cisco.com/techsupport</a>



# Feature Information for Configuring Pseudowire

Table 21-1 lists the features in this module and provides links to specific configuration information.

Use Cisco Feature Navigator to find information about platform support and software image support. Cisco Feature Navigator enables you to determine which software images support a specific software release, feature set, or platform. To access Cisco Feature Navigator, go to <http://www.cisco.com/go/cfn>. An account on Cisco.com is not required.



**Note**

Table 21-1 lists only the software release that introduced support for a given feature in a given software release train. Unless noted otherwise, subsequent releases of that software release train also support that feature.

**Table 21-1** Feature Information for Configuring Pseudowire

Feature Name	Releases	Feature Information
Configuring Pseudowire	15.2(2)SNH1	See the following links for more information about this feature: <ul style="list-style-type: none"> <li><a href="#">TDM Local Switching</a></li> </ul>
Hot Standby Pseudowire Support for ATM/IMA	15.3(2)S	See the following links for more information about this feature: <ul style="list-style-type: none"> <li><a href="#">Hot Standby Pseudowire Support for ATM/IMA</a></li> <li><a href="#">Configuring Hot Standby Pseudowire Support for ATM/IMA</a></li> </ul>





# Configuring Clocking

This chapter provides information about configuring clocking on the Cisco ASR 901 Series Aggregation Services Router.

## Contents

- [Restrictions, page 22-1](#)
- [Configuring Network Clock for Cisco ASR 901 Router, page 22-2](#)
- [Configuring PTP for the Cisco ASR 901 Router, page 22-18](#)

## Restrictions

- External interfaces like Building Integrated Timing Supply (BITS) and 1 Pulse Per Second (1PPS) have only one port. These interfaces can be used as either an input interface or output interface at a given time.
- The *line to external* option is not supported for external Synchronization Supply Unit (SSU).
- Time-of-Day (ToD) is not integrated to the router system time. ToD input or output reflects only the PTP time, not the router system time.
- Revertive and non-revertive modes work correctly only with two clock sources.
- BITS cable length option is supported via **platform timing bits line-build-out** command.
- There is no automatic recovery from out-of-resource (OOR) alarms. OOR alarms must be manually cleared using **clear platform timing oor-alarms** command.
- If copper Gigabit Ethernet port is selected as the input clock source, the link must be configured as a IEEE 802.3 link-slave, using **syntc state slave** command.
- BITS reports loss of signal (LOS) only for Alarm Indication Signal (AIS), LOS, and loss of frame (LOF) alarms.
- The **clock source line** command does not support loop timing in T1/E1 controllers. However, the clock can be recovered from T1/E1 lines and used to synchronize the system clock using the **network-clock input-source priority controller E1/T1 0/x** command.
- Adaptive clocking is not supported in Cisco ASR 901 router.

# Configuring Network Clock for Cisco ASR 901 Router

Cisco ASR 901 router supports time, phase and frequency awareness through ethernet networks; it also enables clock selection and translation between the various clock frequencies.

If Cisco ASR 901 interoperates with devices that do not support synchronization, synchronization features can be disabled or partially enabled to maintain backward compatibility.

The network clock can be configured in global configuration mode and interface configuration mode:

- [Configuring Network Clock in Global Configuration Mode, page 22-3](#)
- [Configuring Network Clock in Interface Configuration Mode, page 22-6](#)
- [Understanding SSM and ESMC, page 22-7](#)
- [Configuring ESMC in Global Configuration Mode, page 22-8](#)
- [Configuring ESMC in Interface Configuration Mode, page 22-9](#)
- [Managing Synchronization, page 22-11](#)
- [Configuring Synchronous Ethernet for Copper Ports, page 22-13](#)
- [Verifying the Synchronous Ethernet configuration, page 22-13](#)
- [Troubleshooting Tips, page 22-16](#)

## Configuring Network Clock in Global Configuration Mode

Complete the following steps to configure the network clock in global configuration mode:

### SUMMARY STEPS

1. **enable**
2. **configure terminal**
3. **network-clock synchronization automatic**
4. **network-clock eec {1 | 2}**
5. **network-clock synchronization ssm option {1 | 2 {GEN1 | GEN2}}**
6. **network-clock hold-off {0 | 50-10000} global**
7. **network-clock external slot/card/port hold-off {0 | 50-10000}**
8. **network-clock wait-to-restore 0-86400 global**
9. **network-clock input-source priority {interface interface-name slot/port | top slot/port | {external slot/card/port [t1 {sf | efs | d4} | e1 [crc4| fas| cas [crc4] | 2048k | 10m]}}**
10. **network-clock input-source priority controller [t1/e1] slot/port**
11. **network-clock revertive**
12. **network-clock output-source system priority {external slot/card/port [t1 {sf | efs | d4} | e1 [crc4| fas| cas [crc4] | 2048k | 10m]}}**

### DETAILED STEPS

	Command or Action	Purpose
Step 1	<b>enable</b>  <b>Example:</b> Router> enable	Enables privileged EXEC mode. <ul style="list-style-type: none"> <li>• Enter your password if prompted.</li> </ul>
Step 2	<b>configure terminal</b>  <b>Example:</b> Router# configure terminal	Enters global configuration mode.
Step 3	<b>network-clock synchronization automatic</b>  <b>Example:</b> Router(config)# network-clock synchronization automatic	Enables G.781-based automatic clock selection process. G.781 is the ITU-T Recommendation that specifies the synchronization layer functions.
Step 4	<b>network-clock eec {1   2}</b>  <b>Example:</b> Router(config)# network-clock eec 1	Configures the clocking system hardware with the desired parameters. These are the options: <ul style="list-style-type: none"> <li>• For option 1, the default value is EEC-Option 1 (2048).</li> <li>• For option 2, the default value is EEC-Option 2 (1544).</li> </ul>

	Command or Action	Purpose
<b>Step 5</b>	<pre>network-clock synchronization ssm option {1   2 {GEN1   GEN2}}</pre> <p><b>Example:</b> Router(config)# network-clock synchronization ssm option 2 GEN1</p>	<p>Configures the router to work in a synchronized network mode as described in G.781. The following are the options:</p> <ul style="list-style-type: none"> <li>Option 1: refers to synchronization networks designed for Europe (E1 framings are compatible with this option).</li> <li>Option 2: refers to synchronization networks designed for the US (T1 framings are compatible with this option). The default option is 1 and while choosing option 2, you need to specify the second generation message (GEN2) or first generation message (GEN1).</li> </ul> <p><b>Note</b> Network-clock configurations that are not common between options need to be configured again.</p>
<b>Step 6</b>	<pre>network-clock hold-off {0   50-10000} global</pre> <p><b>Example:</b> Router(config)# network-clock hold-off 75 global</p>	<p>Configures general hold-off timer in milliseconds. The default value is 300 milliseconds.</p> <p><b>Note</b> Displays a warning message for values below 300 ms and above 1800 ms.</p>
<b>Step 7</b>	<pre>network-clock external slot/card/port hold-off {0   50-10000}</pre> <p><b>Example:</b> Router(config)# network-clock external 3/1/1 hold-off 300</p>	<p>Overrides hold-off timer value for external interface.</p> <p><b>Note</b> Displays a warning message for values above 1800 ms, as waiting longer causes the clock to go into the holdover mode.</p>
<b>Step 8</b>	<pre>network-clock wait-to-restore 0-86400 global</pre> <p><b>Example:</b> Router(config)# network-clock external wait-to-restore 1000 global</p>	<p>Sets the value for the wait-to-restore timer globally.</p> <p>The wait to restore time is configurable in the range of 0 to 86400 seconds. The default value is 300 seconds.</p> <p> <b>Caution</b> Ensure that you set the wait-to-restore values above 50 seconds to avoid a timing flap.</p>

	Command or Action	Purpose
Step 9	<p><b>network-clock input-source</b> <i>priority</i> {<b>interface</b> <i>interface-name slot/port</i>   <b>top</b> <i>slot/port</i>   {<b>external</b> <i>slot/card/port [t1 {sf   efs   d4}</i>   <i>e1 [crc4  fas  cas [crc4]   2048k   10m</i>}}</p> <p><b>Example:</b> Router(config)# network-clock input-source 1 interface top 0/12</p> <p><b>Example for GPS interface</b></p> <p>Router(config)# network-clock input-source 1 external 0/0/0 10m</p>	<p>Configures a clock source line interface, an external timing input interface, GPS interface, or a packet-based timing recovered clock as the input clock for the system and defines its priority. Priority is a number between 1 and 250.</p> <p>This command also configures the type of signal for an external timing input interface. These signals are:</p> <ul style="list-style-type: none"> <li>• T1 with Standard Frame format or Extended Standard Frame format.</li> <li>• E1 with or without CRC4</li> <li>• 2 MHz signal</li> <li>• Default for Europe or Option I is e1 crc4 if the signal type is not specified.</li> <li>• Default for North America or Option II is t1 esf if signal type is not specified.</li> </ul> <p><b>Note</b> The <b>no</b> version of the command reverses the command configuration, implying that the priority has changed to undefined and the state machine is informed.</p>
Step 10	<p><b>network-clock input-source</b> <i>priority controller [t1/e1] slot/port</i></p> <p><b>Example:</b> Router(config)# network-clock input-source 10 controller e1 0/12</p>	<p>Adds the clock recovered from the serial interfaces as one of the nominated sources, for network-clock selection.</p>
Step 11	<p><b>network-clock revertive</b></p> <p><b>Example:</b> Router(config)# network-clock revertive</p>	<p>Specifies whether or not the clock source is revertive. Clock sources with the same priority are always non-revertive. The default value is non-revertive.</p> <p>In non-revertive switching, a switch to an alternate reference is maintained even after the original reference recovers from the failure that caused the switch. In revertive switching, the clock switches back to the original reference after that reference recovers from the failure, independent of the condition of the alternate reference.</p>
Step 12	<p><b>network-clock output-source system</b> <i>priority {external slot/card/port [t1 {sf   efs   d4}   e1 [crc4  fas  cas [crc4]   2048k   10m]}</i></p> <p><b>Example:</b> Router(config)#network-clock output-source system 55 external 0/0/0 t1 efs</p>	<p>Allows transmitting the system clock to external timing output interfaces.</p> <p>This command provides station clock output as per G.781. We recommend that you use the interface level command instead of global commands. Global command should preferably be used for interfaces that do not have an interface sub mode. For more information on configuring network clock in interface level mode, see <a href="#">Configuring Network Clock in Interface Configuration Mode</a>, page 22-6.</p>

## Configuring Network Clock in Interface Configuration Mode

Complete the following steps to configure the network clock in interface configuration mode:

### SUMMARY STEPS

1. **enable**
2. **configure terminal**
3. **interface**
4. **synchronous mode**
5. **network-clock hold-off {0 | 50-10000}**
6. **network-clock wait-to-restore 0-86400**

### DETAILED STEPS

	Command or Action	Purpose
Step 1	<b>enable</b>  <b>Example:</b> Router> enable	Enables privileged EXEC mode.  • Enter your password if prompted.
Step 2	<b>configure terminal</b>  <b>Example:</b> Router# configure terminal	Enters global configuration mode.
Step 3	<b>interface</b>  <b>Example:</b> Router(config)# <b>interface</b>	Enters interface configuration mode.
Step 4	<b>synchronous mode</b>  <b>Example:</b> Router(config-if)# synchronous mode	Configures the ethernet interface to synchronous mode.  <b>Note</b> This command is applicable to Synchronous Ethernet capable interfaces. The default value is asynchronous mode.
Step 5	<b>network-clock hold-off {0   50-10000}</b>  <b>Example:</b> Router(config-if)#network-clock hold-off 1000	Configures hold-off timer for interface. The default value is 300 milliseconds.  <b>Note</b> Displays a warning for values below 300 ms and above 1800 ms.
Step 6	<b>network-clock wait-to-restore 0-86400</b>  <b>Example:</b> Router(config-if)#network-clock wait-to-restore 1000	Configures the wait-to-restore timer on the SyncE interface.   <b>Caution</b> Ensure that you set the wait-to-restore values above 50 seconds to avoid timing flap.



## Understanding SSM and ESMC

Network Clocking uses these mechanisms to exchange the quality level of the clock between the network elements:

- [Synchronization Status Message, page 22-7](#)
- [Ethernet Synchronization Messaging Channel, page 22-7](#)

### Synchronization Status Message

Network elements use Synchronization Status Messages (SSM) to inform the neighboring elements about the Quality Level (QL) of the clock. The non-ethernet interfaces such as optical interfaces and SONET/T1/E1 SPA framer use SSM. The key benefits of the SSM functionality are:

- Prevents timing loops.
- Provides fast recovery when a part of the network fails.
- Ensures that a node derives timing from the most reliable clock source.

### Ethernet Synchronization Messaging Channel

In order to maintain a logical communication channel in synchronous network connections, ethernet relies on a channel called Ethernet Synchronization Messaging Channel (ESMC) based on IEEE 802.3 Organization Specific Slow Protocol standards. ESMC relays the SSM code that represents the quality level of the Ethernet Equipment Clock (EEC) in a physical layer.

The ESMC packets are received only for those ports configured as clock sources and transmitted on all the SyncE interfaces in the system. The received packets are processed by the clock selection algorithm and are used to select the best clock. The Tx frame is generated based on the QL value of the selected clock source and sent to all the enabled SyncE ports.

### Clock Selection Algorithm

Clock selection algorithm selects the best available synchronization source from the nominated sources. The clock selection algorithm has a non-revertive behavior among clock sources with same QL value and always selects the signal with the best QL value. For clock option 1, the default is revertive and for clock option 2, the default is non-revertive.

The clock selection process works in the QL enabled and QL disabled modes. When multiple selection processes are present in a network element, all processes work in the same mode.

#### QL-enabled mode

In the QL-enabled mode, the following parameters contribute to the selection process:

- Quality level
- Signal fail via QL-FAILED
- Priority
- External commands.

If no external commands are active, the algorithm selects the reference (for clock selection) with the highest quality level that does not experience a signal fail condition.

If multiple inputs have the same highest quality level, the input with the highest priority is selected.

For multiple inputs having the same highest priority and quality level, the existing reference is maintained (if it belongs to this group), otherwise an arbitrary reference from this group is selected.

#### QL-disabled mode

In the QL-disabled mode, the following parameters contribute to the selection process:

- Signal failure
- Priority
- External commands

If no external commands are active, the algorithm selects the reference (for clock selection) with the highest priority that does not experience a signal fail condition.

For multiple inputs having the same highest priority, the existing reference is maintained (if it belongs to this group), otherwise an arbitrary reference from this group is selected.

## ESMC behavior for Port Channels

ESMC is an Organization Specific Slow Protocol (OSSP) like LACP of port channel, sharing the same slow protocol type, indicating it is in the same sub-layer as LACP. Hence, ESMC works on the link layer on individual physical interfaces without any knowledge of the port channel. This is achieved by setting the egress VLAN as the default VLAN (VLAN 1) and the interface as a physical interface while sending out the packets from the CPU. So none of the service instance, port channel, or VLAN rules apply to the packet passing through the switch ASIC.

## ESMC behavior for STP Blocked Ports

ESMC works just above the MAC layer (below spanning tree protocol), and ignores spanning tree Port status. So, ESMC is exchanged even when the port is in the blocked state (but not disabled state). This is achieved by setting the egress VLAN as the default VLAN (VLAN 1) and the interface as a physical interface while sending out packets from the CPU. So none of the service instance, port channel, or VLAN port state, or rules apply to the packet passing through the switch ASIC.

## Configuring ESMC in Global Configuration Mode

Complete the following steps to configure ESMC in global configuration mode:

### SUMMARY STEPS

1. **enable**
2. **configure terminal**
3. **network-clock synchronization mode ql-enabled**
4. **esmc process**
5. **network-clock quality-level {tx | rx} value {interface interface-name slot/sub-slot/port | external slot/sub-slot/port | gps slot/sub-slot | controller slot/sub-slot/port}**

## DETAILED STEPS

	Command or Action	Purpose
Step 1	<b>enable</b>  <b>Example:</b> Router> enable	Enables privileged EXEC mode. <ul style="list-style-type: none"> <li>Enter your password if prompted.</li> </ul>
Step 2	<b>configure terminal</b>  <b>Example:</b> Router# configure terminal	Enters global configuration mode.
Step 3	<b>network-clock synchronization mode ql-enabled</b>  <b>Example:</b> Router(config)# network-clock synchronization mode ql-enabled	Configures the automatic selection process QL-enabled mode. <ul style="list-style-type: none"> <li>QL is disabled by default.</li> <li><b>ql-enabled</b> mode can be used only when the synchronization interface is capable to send SSM.</li> </ul>
Step 4	<b>esmc process</b>  <b>Example:</b> Router(config)# esmc process	Enables the ESMC process.  <b>Note</b> ESMC can be enabled globally or at the sync-E interface level
Step 5	<b>network-clock quality-level {tx   rx} value {interface interface-name slot/sub-slot/port   external slot/sub-slot/port   gps slot/sub-slot   controller slot/sub-slot/port}</b>  <b>Example:</b> Router(config)# network-clock quality-level rx qL-PRC external 0/0/0 e1 crc4	Forces the QL value for line or external timing output.

## Configuring ESMC in Interface Configuration Mode

Complete the following steps to configure ESMC in interface configuration mode:

## SUMMARY STEPS

- enable
- configure terminal
- interface
- esmc mode {tx | rx}
- network-clock source quality-level value {tx | rx}
- esmc mode ql-disabled

## DETAILED STEPS

	Command or Action	Purpose
Step 1	<b>enable</b>  <b>Example:</b> Router> enable	Enables privileged EXEC mode. <ul style="list-style-type: none"> <li>Enter your password if prompted.</li> </ul>
Step 2	<b>configure terminal</b>  <b>Example:</b> Router# configure terminal	Enters global configuration mode.
Step 3	<b>interface</b>  <b>Example:</b> Router(config)# interface	Enters interface configuration mode.
Step 4	<b>esmc mode {tx   rx}</b>  <b>Example:</b> Router(config-if)# esmc mode tx	Enables the ESMC process at the interface level. The no form of the command disables the ESMC process.
Step 5	<b>network-clock source quality-level value {tx   rx}</b>  <b>Example:</b> Router(config-if)# network-clock source quality-level <value> tx	Configures the QL value for ESMC on a gigabitethernet port. The value is based on global interworking options: <ul style="list-style-type: none"> <li>If Option 1 is configured, the available values are QL-PRC, QL-SSU-A, QL-SSU-B, QL-SEC, and QL-DNU.</li> <li>If Option 2 is configured with GEN 2, the available values are QL-PRS, QL-STU, QL-ST2, QL-TNC, QL-ST3, QL-SMC, QL-ST4, and QL-DUS.</li> <li>If Option 2 is configured with GEN1, the available values are QL-PRS, QL-STU, QL-ST2, QL-SMC, QL-ST4, and QL-DUS</li> </ul>
Step 6	<b>esmc mode ql-disabled</b>  <b>Example:</b> Router(config-if)# esmc mode ql-disabled	Enables the QL-disabled mode.

**Note**

By disabling Rx on an interface, any ESMC packet received on the interface shall be discarded. By disabling Tx on an interface, ESMC packets will not be sent on the interface; any pending Switching Message Delay timers (TSM) are also stopped.

## Verifying ESMC Configuration

Use the following commands to verify ESMC configuration:

- show esmc**

- **show network-clock synchronization**

```

Router#show esmc interface gigabitEthernet ?
<0-1> GigabitEthernet interface number

Router#show esmc interface gigabitEthernet 0/10
Interface: GigabitEthernet0/10
  Administrative configurations:
    Mode: Synchronous
    ESMC TX: Enable
    ESMC RX: Enable
    QL TX: -
    QL RX: -
  Operational status:
    Port status: UP
    QL Receive: QL-SEC
    QL Transmit: QL-DNU
    QL rx overridden: -
    ESMC Information rate: 1 packet/second
    ESMC Expiry: 5 second

Router# show network-clocks synchronization
Symbols:      En - Enable, Dis - Disable, Adis - Admin Disable
              NA - Not Applicable
              * - Synchronization source selected
              # - Synchronization source force selected
              & - Synchronization source manually switched

Automatic selection process : Enable
Equipment Clock : 2048 (EEC-Option1)
Clock Mode : QL-Disable
ESMC : Disabled
SSM Option : 1
T0 : GigabitEthernet0/4
Hold-off (global) : 300 ms
Wait-to-restore (global) : 300 sec
Tsm Delay : 180 ms
Revertive : No

Nominated Interfaces

Interface      SigType      Mode/QL      Prio  QL_IN  ESMC Tx  ESMC Rx
Internal       NA           NA/Dis       251   QL-SEC NA        NA
To0/12         NA           NA/En        1     QL-FAILED NA        NA
External 0/0/0  10M         NA/Dis       2     QL-FAILED NA        NA
Gi0/1          NA           Sync/En      20    QL-FAILED -         -
*Gi0/4         NA           Sync/En      21    QL-DNU  -         -

T4 Out

External Interface  SigType      Input      Prio  Squelch  AIS
External 0/0/0     E1 CRC4     Internal   1     FALSE    FALSE

```

## Managing Synchronization

You can manage the synchronization using the following management commands:

Command	Purpose
<p><b>network-clock switch force</b> {<b>interface</b> <i>interface_name slot/port</i>   <b>external</b> <i>slot/card/port</i>}</p> <p><b>Example:</b> Router(config)# network-clock switch force interface GigabitEthernet 0/1 t1</p>	Forcefully selects a synchronization source irrespective of whether the source is available and is within the range.
<p><b>network-clock switch manual</b> {<b>interface</b> <i>interface_name slot/port</i>   <b>external</b> <i>slot/card/port</i>}</p> <p><b>Example:</b> Router(config)# network-clock switch manual interface GigabitEthernet 0/1 t1</p>	Manually selects a synchronization source, provided the source is available and is within the range.
<p><b>network-clock clear switch</b> {<i>t0</i>   <b>external</b> <i>slot/card/port [10m   2m]</i>}</p> <p><b>Example:</b> Router(config)# network-clock clear switch t0</p>	Clears the forced switch and manual switch commands.

## Synchronization Example

### Example 22-1 Configuration for QL-disabled mode clock selection

```

network-clock synchronization automatic
network-clock input-source 1 interface ToP0/12
network-clock input-source 2 External 0/0/0 10m
network-clock input-source 20 interface GigabitEthernet0/1
network-clock input-source 21 interface GigabitEthernet0/4
network-clock output-source system 1 External 0/0/0 e1 crc4
!
interface GigabitEthernet0/1
 synchronous mode
 synce state slave
!
interface GigabitEthernet0/4
 negotiation auto
 synchronous mode
 synce state slave
end

```

### Example 22-2 GPS Configuration

```

10MHz signal
network-clock input-source 1 External 0/0/0 10m
2M signal
network-clock input-source 1 External 0/0/0 2048K

```

## Configuring Synchronous Ethernet for Copper Ports

You can configure synchronization on the copper ports using the following commands:

Command	Purpose
Router(config-if)# <b>sync state slave</b>	Configures synchronous ethernet copper port as slave.
Router(config-if)# <b>sync state master</b>	Configures synchronous ethernet copper port as master.

## Verifying the Synchronous Ethernet configuration

Use the **show network-clock synchronization** command to display the sample output.

```
Router# show network-clocks synchronization
Symbols:      En - Enable, Dis - Disable, Adis - Admin Disable
              NA - Not Applicable
              * - Synchronization source selected
              # - Synchronization source force selected
              & - Synchronization source manually switched

Automatic selection process : Enable
Equipment Clock : 2048 (EEC-Option1)
Clock Mode : QL-Disable
ESMC : Disabled
SSM Option : 1
T0 : GigabitEthernet0/4
Hold-off (global) : 300 ms
Wait-to-restore (global) : 300 sec
Tsm Delay : 180 ms
Revertive : No

Nominated Interfaces

Interface      SigType      Mode/QL      Prio  QL_IN  ESMC Tx  ESMC Rx
Internal      NA           NA/Dis       251   QL-SEC  NA       NA
To0/12        NA           NA/En        1     QL-FAILED NA       NA
External 0/0/0  10M         NA/Dis       2     QL-FAILED NA       NA
Gi0/1         NA           Sync/En      20    QL-FAILED -       -
*Gi0/4        NA           Sync/En      21    QL-DNU  -       -

T4 Out

External Interface  SigType      Input      Prio  Squelch  AIS
External 0/0/0     E1 CRC4     Internal   1     FALSE    FALSE
```

Use the **show network-clock synchronization detail** command to display all details of network-clock synchronization parameters at the global and interface levels.

```
Router# show network-clocks synchronization detail
Symbols:      En - Enable, Dis - Disable, Adis - Admin Disable
              NA - Not Applicable
              * - Synchronization source selected
              # - Synchronization source force selected
              & - Synchronization source manually switched

Automatic selection process : Enable
Equipment Clock : 2048 (EEC-Option1)
Clock Mode : QL-Disable
ESMC : Disabled
```

```

SSM Option : 1
T0 : External 0/0/0 10m
Hold-off (global) : 300 ms
Wait-to-restore (global) : 0 sec
Tsm Delay : 180 ms
Revertive : Yes
Force Switch: FALSE
Manual Switch: FALSE
Number of synchronization sources: 3
sm(netsync NETCLK_QL_DISABLE), running yes, state 2A
Last transition recorded: (begin)-> 2A (sf_change)-> 2A

```

## Nominated Interfaces

Interface	SigType	Mode/QL	Prio	QL_IN	ESMC Tx	ESMC Rx
Internal	NA	NA/Dis	251	QL-SEC	NA	NA
To0/12	NA	NA/En	3	QL-SEC	NA	NA
*External 0/0/0	10M	NA/Dis	1	QL-SEC	NA	NA
Gi0/11	NA	Sync/En	2	QL-DNU	-	-

## T4 Out

External Interface	SigType	Input	Prio	Squelch	AIS
External 0/0/0	E1 CRC4	Internal	1	FALSE	FALSE

## Interface:

```

-----
Local Interface: Internal
Signal Type: NA
Mode: NA(QL-disabled)
SSM Tx: DISABLED
SSM Rx: DISABLED
Priority: 251
QL Receive: QL-SEC
QL Receive Configured: -
QL Receive Overridden: -
QL Transmit: -
QL Transmit Configured: -
Hold-off: 0
Wait-to-restore: 0
Lock Out: FALSE
Signal Fail: FALSE
Alarms: FALSE
Slot Disabled: FALSE
SNMP input source index: 1
SNMP parent list index: 0

```

```

Local Interface: To0/12
Signal Type: NA
Mode: NA(QL-disabled)
SSM Tx: DISABLED
SSM Rx: ENABLED
Priority: 3
QL Receive: QL-SEC
QL Receive Configured: -
QL Receive Overridden: -
QL Transmit: -
QL Transmit Configured: -
Hold-off: 300
Wait-to-restore: 0
Lock Out: FALSE
Signal Fail: FALSE
Alarms: FALSE

```



```
Slot Disabled: FALSE
SNMP input source index: 2
SNMP parent list index: 0

Local Interface: External 0/0/0
Signal Type: 10M
Mode: NA(QL-disabled)
SSM Tx: DISABLED
SSM Rx: DISABLED
Priority: 1
QL Receive: QL-SEC
QL Receive Configured: -
QL Receive Overridden: -
QL Transmit: -
QL Transmit Configured: -
Hold-off: 300
Wait-to-restore: 0
Lock Out: FALSE
Signal Fail: FALSE
Alarms: FALSE
Active Alarms : None
Slot Disabled: FALSE
SNMP input source index: 3
SNMP parent list index: 0

Local Interface: Gi0/11
Signal Type: NA
Mode: Synchronous(QL-disabled)
ESMC Tx: ENABLED
ESMC Rx: ENABLED
Priority: 2
QL Receive: QL-DNU
QL Receive Configured: -
QL Receive Overridden: -
QL Transmit: -
QL Transmit Configured: -
Hold-off: 300
Wait-to-restore: 0
Lock Out: FALSE
Signal Fail: FALSE
Alarms: FALSE None
Slot Disabled: FALSE
SNMP input source index: 4
SNMP parent list index: 0

External 0/0/0 e1 crc4's Input:
Internal
  Local Interface: Internal
  Signal Type: NA
  Mode: NA(QL-disabled)
  SSM Tx: DISABLED
  SSM Rx: DISABLED
  Priority: 1
  QL Receive: QL-SEC
  QL Receive Configured: -
  QL Receive Overridden: -
  QL Transmit: -
  QL Transmit Configured: -
  Hold-off: 300
  Wait-to-restore: 0
  Lock Out: FALSE
  Signal Fail: FALSE
  Alarms: FALSE
  Slot Disabled: FALSE
```

```
SNMP input source index: 1
SNMP parent list index: 1
```

## Troubleshooting Tips

**Note**

Before you troubleshoot, ensure that all the network clock synchronization configurations are complete.

Table 22-1 provides the troubleshooting scenarios encountered while configuring the synchronous ethernet.

**Table 22-1 Troubleshooting Scenarios for Synchronous Ethernet Configuration**

Problem	Solution
Clock selection	<ul style="list-style-type: none"> <li>Verify that there are no alarms on the interfaces. Use the <b>show network-clock synchronization detail RP</b> command to confirm.</li> <li>Use the <b>show network-clock synchronization</b> command to confirm if the system is in revertive mode or non-revertive mode and verify the non-revertive configurations as shown in this example:</li> </ul> <pre>Router# show network-clocks synchronization Symbols:      En - Enable, Dis - Disable, Adis - Admin Disable               NA - Not Applicable               * - Synchronization source selected               # - Synchronization source force selected               &amp; - Synchronization source manually switched  Automatic selection process : Enable Equipment Clock : 2048 (EEC-Option1) Clock Mode : QL-Disable ESMC : Disabled SSM Option : 1 T0 : GigabitEthernet0/4 Hold-off (global) : 300 ms Wait-to-restore (global) : 300 sec Tsm Delay : 180 ms Revertive : Yes&lt;&lt;&lt;&lt;If it is non revertive then it will show NO here.</pre> <p><b>Note</b> The above example does not show the complete command output. For complete command output, see the example in <a href="#">Verifying the Synchronous Ethernet configuration</a>.</p> <ul style="list-style-type: none"> <li>Reproduce the current issue and collect the logs using the <b>debug network-clock errors</b>, <b>debug network-clock event</b>, and <b>debug network-clock sm</b> RP commands.</li> </ul> <p> <b>Warning</b> <u>We suggest you do not use these debug commands without TAC supervision.</u></p> <ul style="list-style-type: none"> <li>Contact Cisco technical support if the issue persists.</li> </ul>

Problem	Solution
Incorrect quality level (QL) values when you use the <b>show network-clock synchronization detail</b> command.	<ul style="list-style-type: none"> <li>Use the <b>network clock synchronization SSM</b> (<i>option 1   option 2</i>) command to confirm that there is no framing mismatch. Use the <b>show run interface</b> command to validate the framing for a specific interface. For the SSM option 1 framing should be an E1 and for SSM option 2, it should be a T1.</li> </ul>
Error message “%NETCLK-6-SRC_UPD: Synchronization source 10m 0/0/0 status (Critical Alarms(OOR)) is posted to all selection process” is displayed.	<ul style="list-style-type: none"> <li>Interfaces with alarms or OOR cannot be the part of selection process even if it has higher quality level or priority. OOR should be cleared manually. OOR can be cleared by platform command <b>clear platform timing oor-alarms</b>.</li> </ul>

## Troubleshooting ESMC Configuration

Use the following debug commands to troubleshoot the PTP configuration on the Cisco ASR 901 router:



**Warning**

**We suggest you do not use these debug commands without TAC supervision.**

Command	Purpose
<pre>debug esmc error debug esmc event debug esmc packet [interface interface-name&gt;] debug esmc packet rx [interface interface-name] debug esmc packet tx [interface interface-name]</pre>	Verify whether the ESMC packets are transmitted and received with proper quality-level values.

# Configuring PTP for the Cisco ASR 901 Router

**Note**

Before configuring PTP, you should set the system time to the current time. See [Setting System Time to Current Time](#) section for configuration details.

This section contains the following topics:

- [Restrictions](#)
- [Setting System Time to Current Time](#)
- [Configuring PTP Ordinary Clock](#)
- [Configuring PTP in Unicast Mode](#)
- [Configuring PTP in Unicast Negotiation Mode](#)
- [PTP Boundary Clock](#)
- [Verifying PTP modes](#)
- [Verifying PTP Configuration on the 1588V2 Slave](#)
- [Verifying PTP Configuration on the 1588V2 Master](#)
- [PTP Hybrid Clock](#)
- [SSM and PTP Interaction](#)
- [ClockClass Mapping](#)
- [PTP Redundancy](#)
- [Configuring ToD on 1588V2 Slave](#)
- [Troubleshooting Tips](#)

## Restrictions

- Only unicast direct and unicast negotiation modes are supported. Multicast mode is not supported.
- PTP slave supports both single and two-step modes. PTP master supports only two-step mode.
- VLAN 4093 is used for internal PTP communication; do not use VLAN 4093 in your network.
- Loopback interface is used in Cisco ASR 901 router instead of ToP interface for configuring 1588 interface/IP address.
- The **1pps output** command is not supported on master ordinary clock.
- Sync and Delay request rates should be above 32 pps. The optimum value is 64 pps.
- Clock-ports start as master even when they are configured as slave-only. The initial or reset state of the clock is master. Therefore, the master clock must have higher priority (priority1, priority2) for the slave to accept the master.

## Setting System Time to Current Time

To set the system time to the current time before configuring PTP, complete the steps given below:

### SUMMARY STEPS

1. **enable**
2. **calendar set** *hh : mm : ss day month year*
3. **clock read-calendar**
4. **show clock**

### DETAILED STEPS

Command	Purpose
Router# <b>calendar set</b> <i>hh : mm : ss day month year</i>  <b>Example:</b> Router# calendar set 09:00:00 6 Feb 2013	Sets the hardware clock. <ul style="list-style-type: none"> <li>• <i>hh : mm : ss</i>—RCurrent time in hours (using 24-hour notation), minutes, and seconds.</li> <li>• <i>day</i>—Current day (by date) in the month.</li> <li>• <i>month</i>—Current month (by name).</li> <li>• <i>year</i>—Current year (no abbreviation).</li> </ul>
Router# <b>clock read-calendar</b>  <b>Example:</b> Router# clock read-calendar	Synchronizes the system clock with the calendar time.
Router# <b>show clock</b>  <b>Example:</b> Router# show clock	Verifies the clock setting.

## Configuring PTP Ordinary Clock

The following sections describe how to configure a PTP ordinary clock.

- [Configuring Master Ordinary Clock, page 22-19](#)
- [Configuring Slave Ordinary Clock, page 22-21](#)

### Configuring Master Ordinary Clock

Complete the following steps to configure the a master ordinary clock:

#### SUMMARY STEPS

1. **enable**
2. **configure terminal**
3. **ptp clock ordinary domain** *domain*

4. **priority1** *priority-value*
5. **priority2** *priority-value*
6. **clock-port** *port-name* **master**
7. **transport ipv4 unicast interface** *interface-type interface-number*
8. **clock-destination** *clock-ip-address*
9. **sync interval** *interval*
10. **announce interval** *interval*
11. **end**

## DETAILED STEPS

	Command	Purpose
Step 1	<b>enable</b>  <b>Example:</b> Router> enable	Enables privileged EXEC mode. <ul style="list-style-type: none"> <li>Enter your password if prompted.</li> </ul>
Step 2	<b>configure terminal</b>  <b>Example:</b> Router# configure terminal	Enters global configuration mode.
Step 3	<b>ptp clock ordinary domain</b> <i>domain</i>  <b>Example:</b> Router(config)# ptp clock ordinary domain 0	Configures the PTP clock as an ordinary clock and enters clock configuration mode. <ul style="list-style-type: none"> <li><i>domain</i>—The PTP clocking domain number. The range is from 0 to 127.</li> </ul>
Step 4	<b>priority1</b> <i>priority-value</i>  <b>Example:</b> Router(config-ptp-clk)# priority1 4	(Optional) Sets the preference level for a clock. <ul style="list-style-type: none"> <li><i>priority-value</i>—The range is from 0 to 255. The default is 128.</li> </ul>
Step 5	<b>priority2</b> <i>priority-value</i>  <b>Example:</b> Router(config-ptp-clk)# priority2 8	(Optional) Sets a secondary preference level for a clock. The priority2 value is considered only when the router is unable to use priority1 and other clock attributes to select a clock. <ul style="list-style-type: none"> <li><i>priority-value</i>—The range is from 0 to 255. The default is 128.</li> </ul>
Step 6	<b>clock-port</b> <i>port-name</i> <b>master</b>  <b>Example:</b> Router(config-ptp-clk)# clock-port Master master	Sets the clock port to PTP master and enters clock port configuration mode. In master mode, the port exchanges timing packets with PTP slave devices.

	Command	Purpose
Step 7	<p><b>transport ipv4 unicast interface</b> <i>interface-type interface-number</i></p> <p><b>Example:</b> Router(config-ptp-port)# transport ipv4 unicast interface loopback 0</p>	<p>Sets port transport parameters.</p> <ul style="list-style-type: none"> <li><i>interface-type</i>—The type of the interface.</li> <li><i>interface-number</i>—The number of the interface.</li> </ul>
Step 8	<p><b>clock-destination</b> <i>clock-ip-address</i></p> <p><b>Example:</b> Router(config-ptp-port)# clock-destination 8.8.8.1</p>	<p>Specifies the IP address of a clock destination when the router is in PTP master mode.</p>
Step 9	<p><b>sync interval</b> <i>interval</i></p> <p><b>Example:</b> Router(config-ptp-port)# sync interval -5</p>	<p>(Optional) Specifies the interval used to send PTP synchronization messages. The intervals are set using log base 2 values. The Cisco ASR 901 router supports the following values:</p> <ul style="list-style-type: none"> <li>-5—1 packet every 1/32 seconds, or 32 packets per second.</li> <li>-6—1 packet every 1/64 seconds, or 64 packets per second.</li> </ul> <p>The default is -6.</p>
Step 10	<p><b>announce interval</b> <i>interval</i></p> <p><b>Example:</b> Router(config-ptp-port)# announce interval 2</p>	<p>(Optional) Specifies the interval for PTP announce messages. The intervals are set using log base 2 values, as follows:</p> <ul style="list-style-type: none"> <li>4—1 packet every 16 seconds</li> <li>3—1 packet every 8 seconds</li> <li>2—1 packet every 4 seconds</li> <li>1—1 packet every 2 seconds</li> <li>0—1 packet every second</li> </ul> <p>The default is 1.</p>
Step 11	<p><b>end</b></p> <p><b>Example:</b> Router(config-ptp-port)# end</p>	<p>Exits clock port configuration mode and enters privileged EXEC mode.</p>

## Configuring Slave Ordinary Clock

Complete the following steps to configure a slave ordinary clock:

### SUMMARY STEPS

1. **enable**
2. **configure terminal**
3. **ptp clock ordinary domain** *domain*

4. **clock-port** *port-name* **slave**
5. **transport ipv4 unicast interface** *interface-type* *interface-number*
6. **clock source** *source-address*
7. **announce timeout** *value*
8. **delay-req interval** *interval*
9. **sync interval** *interval*
10. **end**

**Note**

PTP redundancy is an implementation on different clock nodes by which the PTP slave clock node interacts with multiple master ports such as grand master, boundary clock nodes, and so on. A new servo mode is defined under PTP to support high PDV scenarios (when the PDVs exceed G.8261 standard profiles). You should use the servo mode high-jitter command to enable this mode on the PTP slave. In servo mode, convergence time would be longer than usual, as this mode is meant only for frequency synchronization.

**DETAILED STEPS**

	Command	Purpose
Step 1	<b>enable</b>  <b>Example:</b> Router> enable	Enables privileged EXEC mode. <ul style="list-style-type: none"> <li>• Enter your password if prompted.</li> </ul>
Step 2	<b>configure terminal</b>  <b>Example:</b> Router# configure terminal	Enters global configuration mode.
Step 3	<b>ptp clock ordinary domain</b> <i>domain</i>  <b>Example:</b> Router(config)# ptp clock ordinary domain 0	Configures the PTP clock as an ordinary clock and enters clock configuration mode.
Step 4	<b>clock-port</b> <i>port-name</i> <b>master</b>  <b>Example:</b> Router(config-ptp-clk)# clock-port Slave slave	Sets the clock port to PTP slave mode and enters clock port configuration mode. In slave mode, the port exchanges timing packets with a PTP master clock.
Step 5	<b>transport ipv4 unicast interface</b> <i>interface-type</i> <i>interface-number</i>  <b>Example:</b> Router(config-ptp-port)# transport ipv4 unicast interface loopback 0	Sets port transport parameters. <ul style="list-style-type: none"> <li>• <i>interface-type</i>—The type of the interface.</li> <li>• <i>interface-number</i>—The number of the interface.</li> </ul>



	Command	Purpose
<b>Step 6</b>	<p><b>clock source</b> <i>source-address</i></p> <p><b>Example:</b>  Router(config-ptp-port)# clock  source 8.8.8.1</p>	Specifies the address of a PTP master clock.
<b>Step 7</b>	<p><b>announce timeout</b> <i>value</i></p> <p><b>Example:</b>  Router(config-ptp-port)# announce  timeout 8</p>	<p>(Optional) Specifies the number of PTP announcement intervals before the session times out.</p> <ul style="list-style-type: none"> <li><i>value</i>—The range is from 1 to 10. The default is 3.</li> </ul>
<b>Step 8</b>	<p><b>delay-req interval</b> <i>interval</i></p> <p><b>Example:</b>  Router(config-ptp-port)# delay-req  interval 1</p>	<p>(Optional) Configures the minimum interval allowed between PTP delay request messages.</p> <p>The intervals are set using log base 2 values, as follows:</p> <ul style="list-style-type: none"> <li>5—1 packet every 32 seconds</li> <li>4—1 packet every 16 seconds</li> <li>3—1 packet every 8 seconds</li> <li>2—1 packet every 4 seconds</li> <li>1—1 packet every 2 seconds</li> <li>0—1 packet every second</li> <li>-1—1 packet every 1/2 second, or 2 packets per second</li> <li>-2—1 packet every 1/4 second, or 4 packets per second</li> <li>-3—1 packet every 1/8 second, or 8 packets per second</li> <li>-4—1 packet every 1/16 seconds, or 16 packets per second.</li> <li>-5—1 packet every 1/32 seconds, or 32 packets per second.</li> <li>-6—1 packet every 1/64 seconds, or 64 packets per second.</li> <li>-7—1 packet every 1/128 seconds, or 128 packets per second.</li> </ul> <p>The default is -6.</p>

	Command	Purpose
<b>Step 9</b>	<p><code>sync interval interval</code></p> <p><b>Example:</b>  Router(config-ptp-port)# sync  interval -5</p>	<p>(Optional) Specifies the interval used to send PTP synchronization messages. The intervals are set using log base 2 values. The Cisco ASR 901 router supports the following values:</p> <ul style="list-style-type: none"> <li>• -5—1 packet every 1/32 seconds, or 32 packets per second.</li> <li>• -6—1 packet every 1/64 seconds, or 64 packets per second.</li> </ul> <p>The default is -6.</p>
<b>Step 10</b>	<p><code>end</code></p> <p><b>Example:</b>  Router(config-ptp-port)# end</p>	<p>Exits clock port configuration mode and enters privileged EXEC mode.</p>

## Configuring PTP in Unicast Mode

In unicast mode, the slave port and the master port need to know each other's IP address. Unicast mode has one to one mapping between the slave and the master. One master can have just one slave and vice-versa. Unicast mode is not a good option for scalability.

The command used for configuring Cisco ASR 901 on unicast mode is **clock-port**.

Command	Purpose
Router(config-ptp-clk)# <b>clock-port</b>	Configures Cisco ASR 901 on unicast mode. The following options can be configured with this command: <ul style="list-style-type: none"> <li>• <b>Port Name</b></li> <li>• <b>Port Role</b></li> </ul>

Before configuring Cisco ASR 901 on different modes, you need to configure the loopback address. The following example shows the configuration of loopback address:



### Note

This loopback address cannot be used for any protocol other than PTP.

```
Router(config)#int loopback
Router(config-if)#ip address 8.8.8.2 255.255.255.255
Router(config-if)#no sh
```

```
Router#sh run int loopback
  Building configuration...

  Current configuration : 72 bytes
  !
  interface loopback
    ip address 8.8.8.2 255.255.255.255
  end
  !
```



### Note

Ensure that this loopback interface is reachable (using ICMP ping) from remote locations, before assigning the interface to PTP. Once the interface is assigned to PTP, it does not respond to ICMP pings.

The following example shows the configuration of Cisco ASR 901 on the unicast mode:

```
Router# configure terminal
Router(config)# ptp clock ordinary domain 0
Router(config-ptp-clk) clock-port SLAVE slave
Router(config-ptp-port)# transport ipv4 unicast interface loopback 10
Router(config-ptp-port)# clock-source 8.8.8.1
```

## Configuring PTP in Unicast Negotiation Mode

In unicast negotiation mode, master port does not know the slave port at the outset. Slave port sends negotiation TLV when active and master port figures out that there is some slave port for synchronization. Unicast negotiation mode is a good option for scalability as one master has multiple slaves.

The command used for configuring Cisco ASR 901 router on unicast negotiation mode is **clock-port**.

Command	Purpose
Router(config-ptp-clk)# <b>clock-port</b>	Configures Cisco ASR 901 router on unicast negotiation mode. The following options can be configured with this command: <ul style="list-style-type: none"> <li>• <b>Port Name</b></li> <li>• <b>Port Role</b></li> </ul>

The following example shows the configuration of Cisco ASR 901 router on the unicast negotiation mode:

```
Router# configure terminal
Router(config)# ptp clock ordinary domain 0
Router(config-ptp-clk) clock-port SLAVE slave
Router(config-ptp-port) # transport ipv4 unicast interface loopback 23 negotiation
Router(config-ptp-port) # clock-source 8.8.8.1

Router(config)# ptp clock ordinary domain 0
Router(config-ptp-clk)# clock-port MASTER Master
Router(config-ptp-port) # transport ipv4 unicast interface loopback 23 negotiation
Router(config-ptp-port) # sync interval <>
Router (config-ptp-port)# announce interval <>
```

## PTP Boundary Clock

A PTP boundary clock (BC) acts as a middle hop between a PTP master and PTP slave. It has multiple ports which can act as a master or slave port as shown in Figure 22-1. A PTP boundary clock has one slave port and one or more master ports. A slave port acts as a slave to a remote PTP master, while a master port acts as a master to a remote PTP slave. A PTP boundary clock derives clock from a master/grand master clock (by acting as a slave) and sends the derived clock to the slaves connected to it (by acting as a master).

PTP boundary clock starts its own PTP session with a number of downstream slaves. The PTP boundary clock mitigates the number of network hops and results in packet delay variations in the packet network between the grand master and slave.

Figure 22-1 PTP Boundary Clock

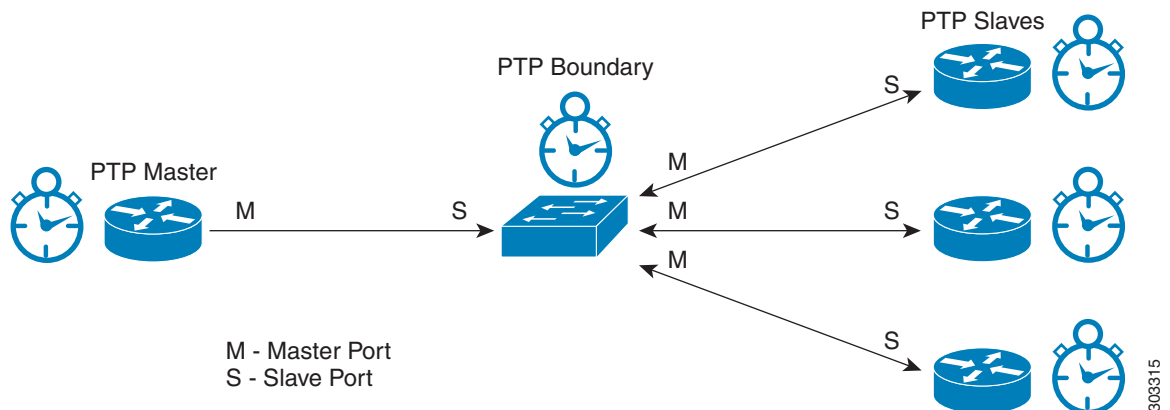

303315

The ASR 901 PTP boundary clock has the following capabilities:

- Support for up to 20 clock ports.
- Simultaneous support for static and negotiated clock ports.
- Support for up to 36 slaves and 1 master.



---

**Note** If all clock ports created in PTP boundary clock are static, Cisco ASR 901 supports only 1 master port and 19 slave ports. However, if one or more slave ports are configured in unicast negotiation mode, Cisco ASR 901 can support up to 36 slaves.

---

- Support for dynamic addition and deletion of clock ports. This capability is supported only on boundary clock master ports.
- Support for selecting boundary clock as the clock source.

## Configuring PTP Boundary Clock

Complete the following steps to configure the PTP boundary clock.

### Prerequisites

- Install the 1588BC license before configuring the PTP boundary clock. For more information on installing the license, see [“Installing the License” section on page 2-11](#).



---

**Note** If PTP boundary clock is configured before installing the 1588BC license, remove the boundary clock configuration and reconfigure the boundary clock after the license installation.

---

- Configure a different loopback address for each PTP master or slave port before configuring the PTP boundary clock. For more information on configuring loopback address, see [“Configuring PTP in Unicast Mode” section on page 22-25](#).

### Restrictions

- The loopback address configured for PTP port can be used only for PTP functionality.
- The loopback address configured for PTP port does not respond to pings.
- A clock port once configured as master cannot change to slave dynamically, and vice versa.
- PTP boundary clock can be configured for only one domain.

### SUMMARY STEPS

1. **enable**
2. **configure terminal**
3. **ptp clock boundary domain** *domain*
4. **clock-port** *port-name* **slave**
5. **transport ipv4 unicast interface** *interface-type interface-number* [**negotiation**]
6. **clock source** *source-address*
7. **clock-port** *port-name* **master**

8. **transport ipv4 unicast interface** *interface-type interface-number* [**negotiation**]
9. **exit**

## DETAILED STEPS

	Command or Action	Purpose
Step 1	<b>enable</b>  <b>Example:</b> Router> enable	Enables privileged EXEC mode. <ul style="list-style-type: none"> <li>• Enter your password if prompted.</li> </ul>
Step 2	<b>configure terminal</b>  <b>Example:</b> Router# configure terminal	Enters global configuration mode.
Step 3	<b>ptp clock boundary domain</b> <i>domain</i>  <b>Example:</b> Router(config)# ptp clock boundary domain 0	Configures the PTP boundary clock and enters clock configuration mode. <ul style="list-style-type: none"> <li>• <i>domain</i>—The PTP clocking domain number. Valid values are from 0 to 127.</li> </ul>
Step 4	<b>clock-port</b> <i>port-name</i> <b>slave</b>  <b>Example:</b> Router(config-ptp-clk)# clock-port SLAVE slave	Sets the clock port to PTP slave mode and enters the clock port configuration mode. In slave mode, the port exchanges timing packets with a PTP master clock.
Step 5	<b>transport ipv4 unicast interface</b> <i>interface-type interface-number</i> [ <b>negotiation</b> ]  <b>Example:</b> Router(config-ptp-port)# transport ipv4 unicast interface Loopback 0 negotiation	Sets port transport parameters. <ul style="list-style-type: none"> <li>• <i>interface-type</i>—The type of the interface.</li> <li>• <i>interface-number</i>—The number of the interface.</li> <li>• <b>negotiation</b>—(Optional) Enables dynamic discovery of slave devices and their preferred format for sync interval and announce interval messages.</li> </ul>
Step 6	<b>clock source</b> <i>source-address</i>  <b>Example:</b> Router(config-ptp-port)# clock source 133.133.133.133	Specifies the address of a PTP master clock.
Step 7	<b>clock-port</b> <i>port-name</i> <b>master</b>  <b>Example:</b> Router(config-ptp-port)# clock-port Master master	Sets the clock port to PTP master mode. In master mode, the port exchanges timing packets with PTP slave devices.  <b>Note</b> The master clock-port does not establish a clocking session until the slave clock-port is phase aligned.

	Command or Action	Purpose
Step 8	<p><b>transport ipv4 unicast interface</b>  <i>interface-type interface-number</i>  [<i>negotiation</i>]</p> <p><b>Example:</b>  Router(config-ptp-port)# transport  ipv4 unicast interface Loopback 1  negotiation</p>	<p>Sets port transport parameters.</p> <ul style="list-style-type: none"> <li>• <i>interface-type</i>—The type of the interface.</li> <li>• <i>interface-number</i>—The number of the interface.</li> <li>• <b>negotiation</b>—(Optional) Enables dynamic discovery of slave devices and their preferred format for sync interval and announce interval messages.</li> </ul>
Step 9	<p><b>exit</b></p> <p><b>Example:</b>  Router(config-ptp-port)# <b>exit</b></p>	<p>Exits clock port configuration mode.</p>

## Verifying PTP modes

### Ordinary Clock

Use the **show ptp clock dataset current** command to display the sample output.

```
Router#show ptp clock dataset current
CLOCK [Ordinary Clock, domain 0]
  Steps Removed: 1
  Offset From Master: 0
```

Use the **show ptp clock dataset default** command to display the sample output.

```
Router#show ptp clock dataset default
CLOCK [Ordinary Clock, domain 0]
  Two Step Flag: No
  Clock Identity: 0x0:A:8B:FF:FF:5C:A:80
  Number Of Ports: 1
  Priority1: 128
  Priority2: 128
  Domain Number: 0
  Slave Only: Yes
  Clock Quality:
  Class: 13
  Accuracy: Greater than 10s
  Offset (log variance): 52592
```

Use the **show ptp clock dataset parent domain** command to display the sample output.

```
Router# show ptp clock dataset parent domain 0
CLOCK [Ordinary Clock, domain 0]
  Parent Stats: No
  Observed Parent Offset (log variance): 65535
  Observed Parent Clock Phase Change Rate: 0
  Grandmaster Clock:
  Identity: 0x0:D0:4:FF:FF:B8:6C:0
  Priority1: 128
  Priority2: 128
  Clock Quality:
  Class: 13
  Accuracy: Within 1s
  Offset (log variance): 52592
```

Use the **show ptp clock dataset time-properties domain** command to display the sample output.

```
Router# show ptp clock dataset time-properties domain 0
CLOCK [Ordinary Clock, domain 0]
  Current UTC Offset Valid: TRUE
  Current UTC Offset: 33
  Leap 59: FALSE
  Leap 61: FALSE
  Time Traceable: TRUE
  Frequency Traceable: TRUE
  PTP Timescale: TRUE
  Time Source: Internal Oscillator
```

### Boundary Clock

Use the **show ptp clock dataset current** command to display the sample output.

```
Router# show ptp clock dataset current
CLOCK [Boundary Clock, domain 0]

  Steps Removed: 0
  Offset From Master: 0ns
```

Use the **show ptp clock dataset default** command to display the sample output.

```
Router# show ptp clock dataset default
CLOCK [Boundary Clock, domain 0]

  Two Step Flag: No
  Clock Identity: 0x0:0:0:FF:FE:0:23:45
  Number Of Ports: 1
  Priority1: 128
  Priority2: 128
  Domain Number: 0
  Slave Only: Yes
  Clock Quality:
    Class: 248
    Accuracy: Within 25us
    Offset (log variance): 22272
```

Use the **show ptp clock dataset parent domain** command to display the sample output.

```
Router# show ptp clock dataset parent domain 0
CLOCK [Boundary Clock, domain 0]

  Parent Stats: No
  Observed Parent Offset (log variance): 0
  Observed Parent Clock Phase Change Rate: 0

  Grandmaster Clock:
    Identity: 0x0:0:0:FF:FE:0:23:45
    Priority1: 128
    Priority2: 128
    Clock Quality:
      Class: 248
      Accuracy: Within 25us
      Offset (log variance): 22272
```

Use the **show ptp clock dataset time-properties domain** command to display the sample output.

```
Router# show ptp clock dataset time-properties domain 0
CLOCK [Boundary Clock, domain 0]

  Current UTC Offset Valid: FALSE
```



```

Current UTC Offset: 34
Leap 59: FALSE
Leap 61: FALSE
Time Traceable: FALSE
Frequency Traceable: FALSE
PTP Timescale: FALSE
Time Source: Internal Oscillator

```

## Verifying PTP Configuration on the 1588V2 Slave

The following examples help you verify the PTP configuration on the 1588V2 slave.



### Note

The loopback interface assigned to PTP does not respond to ICMP pings. To check route availability, either do it before assigning the interface to PTP, or remove PTP from the interface and then perform ICMP ping. For removing PTP, use **no transport ipv4 unicast interface loopback interface** command.



### Note

The bridge state indicates the extension of previously known state which can be ignored or considered to be normal. The clock state can get into holdover from bridge state when the packet delay variation is high on the received PTP packets or the PTP connection is lost. This holdover state indicates that the clock cannot be recovered from PTP packets as the quality is poor.

### Example 1

```
Router# show ptp clock runn dom 0
```

```

                                PTP Ordinary Clock [Domain 0]

State          Ports          Pkts sent    Pkts rcvd
-----
ACQUIRING     1                    5308         27185

                                PORT SUMMARY

Name           Tx Mode    Role          Transport    State    Sessions
-----
SLAVE          unicast    slave         Lo10         -        1

                                SESSION INFORMATION

SLAVE [L010] [Sessions 1]

Peer addr      Pkts in    Pkts out    In Errs     Out Errs
-----
3.3.3.3        27185      5308        0           0

```

### Example 2

```
Router# show platform ptp state
```

```

flag = 2
FLL State                : 2 (Fast Loop)
FLL Status Duration      : 7049 (sec)

Forward Flow Weight      : 0.0
Forward Flow Transient-Free : 900 (900 sec Window)
Forward Flow Transient-Free : 3600 (3600 sec Window)
Forward Flow Transactions Used: 23.0 (%)
Forward Flow Oper. Min TDEV : 4254.0 (nsec)

```

```

Forward Mafie                : 38.0
Forward Flow Min Cluster Width: 7550.0 (nsec)
Forward Flow Mode Width      : 21400.0 (nsec)

Reverse Flow Weight          : 100.0
Reverse Flow Transient-Free  : 900 (900 sec Window)
Reverse Flow Transient-Free  : 3600 (3600 sec Window)
Reverse Flow Transactions Used: 200.0 (%)
Reverse Flow Oper. Min TDEV  : 487.0 (nsec)
Reverse Mafie                : 36.0
Reverse Flow Min Cluster Width: 225.0 (nsec)
Reverse Flow Mode Width      : 450.0 (nsec)

Frequency Correction          : 257.0 (ppb)
Phase Correction              : 0.0 (ppb)

Output TDEV Estimate         : 1057.0 (nsec)
Output MDEV Estimate         : 1.0 (ppb)

Residual Phase Error         : 0.0 (nsec)
Min. Roundtrip Delay         : 45.0 (nsec)

Sync Packet Rate             : 65 (pkts/sec)
Delay Packet Rate            : 65 (pkts/sec)

Forward IPDV % Below Threshold: 0.0
Forward Maximum IPDV         : 0.0 (usec)
Forward Interpacket Jitter   : 0.0 (usec)

Reverse IPDV % Below Threshold: 0.0
Reverse Maximum IPDV         : 0.0 (usec)
Reverse Interpacket Jitter   : 0.0 (usec)

```

## Verifying PTP Configuration on the 1588V2 Master

A typical configuration on a 1588V2 master is:

```

ptp clock ordinary domain 0
tod 0/0 cisco
input 1pps 0/0
clock-port MASTER master
transport ipv4 unicast interface Lo20 negotiation

```

Use the **show ptp clock running domain** command to display the PTP clock configuration:

```

Router# show ptp clock running domain 0
          PTP Ordinary Clock [Domain 0]

          State          Ports          Pkts sent          Pkts rcvd
          -----
          FREQ_LOCKED    1              1757273            599954

          PORT SUMMARY

          Name           Tx Mode      Role           Transport      State          Sessions
          ----           -
          o              unicast     master        Lo20           Master         5

          SESSION INFORMATION
          o [Lo20] [Sessions 5]
          Peer addr      Pkts in      Pkts out      In Errs       Out Errs

```

9.9.9.14	120208	344732	0	0
9.9.9.13	120159	344608	0	0
9.9.9.11	120148	343955	0	0
9.9.9.12	119699	342863	0	0
9.9.9.10	119511	342033	0	0

Use the **show platform ptp stats** command to display the PTP statistics:

```

Statistics for PTP clock 0
#####
Number of ports : 1
Pkts Sent : 1811997
Pkts Rcvd : 619038
Pkts Discarded : 0
Statistics for PTP clock port 1
#####
Pkts Sent : 1811997
Pkts Rcvd : 619038
Pkts Discarded : 0
Signals Rejected : 0
Statistics for peer 1
#####
IP addr : 9.9.9.14
Pkts Sent : 355660
Pkts Rcvd : 124008
Statistics for peer 2
#####
IP addr : 9.9.9.13
Pkts Sent : 355550
Pkts Rcvd : 123973
Statistics for peer 3
#####
IP addr : 9.9.9.11
Pkts Sent : 354904
Pkts Rcvd : 123972
Statistics for peer 4
#####
IP addr : 9.9.9.12
Pkts Sent : 353815
Pkts Rcvd : 123525
Statistics for peer 5
#####
IP addr : 9.9.9.10
Pkts Sent : 352973
Pkts Rcvd : 123326

```

## PTP Hybrid Clock

To improve the clock quality, you can either improve the oscillator class or reduce the number of hops between the master and the slave. In PTP hybrid mode, the oscillator class is improved by using a physical layer clock (sourced from a stratum-1 clock) instead of the available internal oscillator. The PTP hybrid mode is supported for ordinary clock (in slave mode only) and boundary clock.

### Configuring a Hybrid Ordinary Clock

Complete the following steps to configure a hybrid clocking in ordinary slave clock mode:

#### Prerequisites

When configuring a hybrid clock, ensure that the frequency and phase sources are traceable to the same master clock.

#### Restrictions

- Hybrid mode is not supported when PTP ordinary clock is in the master mode.
- Hybrid clock is not supported with ToP as network-clock. It needs a valid physical clock source, for example, Sync-E/BITS/10M/TDM.

#### SUMMARY STEPS

1. **enable**
2. **configure terminal**
3. **ptp clock ordinary domain** *domain* [**hybrid**]
4. **clock-port** *port-name* **slave**
5. **transport ipv4 unicast interface** *interface-type interface-number*
6. **clock source** *source-address*
7. **announce timeout** *value*
8. **delay-req interval** *interval*
9. **sync interval** *interval*
10. **end**

## DETAILED STEPS

	Command	Purpose
Step 1	<b>enable</b>  <b>Example:</b> Router> enable	Enables privileged EXEC mode. <ul style="list-style-type: none"> <li>Enter your password if prompted.</li> </ul>
Step 2	<b>configure terminal</b>  <b>Example:</b> Router# configure terminal	Enters global configuration mode.
Step 3	<b>ptp clock ordinary domain</b> <i>domain</i> <b>hybrid</b>  <b>Example:</b> Router(config)# ptp clock ordinary domain 0	Configures the PTP clock as an ordinary clock and enters clock configuration mode. <ul style="list-style-type: none"> <li><i>domain</i>—The PTP clocking domain number. Valid values are from 0 to 127.</li> <li><b>hybrid</b>—(Optional) Enables the PTP boundary clock to work in hybrid mode. Enables the hybrid clock such that the output of the clock is transmitted to the remote slaves.</li> </ul>
Step 4	<b>clock-port</b> <i>port-name</i> <b>slave</b>  <b>Example:</b> Router(config-ptp-clk)# clock-port Slave slave	Sets the clock port to PTP slave mode and enters clock port configuration mode. In slave mode, the port exchanges timing packets with a PTP master clock.
Step 5	<b>transport ipv4 unicast interface</b> <i>interface-type interface-number</i>  <b>Example:</b> Router(config-ptp-port)# transport ipv4 unicast interface loopback 0	Sets port transport parameters. <ul style="list-style-type: none"> <li><i>interface-type</i>—The type of the interface.</li> <li><i>interface-number</i>—The number of the interface.</li> </ul>
Step 6	<b>clock source</b> <i>source-address</i>  <b>Example:</b> Router(config-ptp-port)# clock source 8.8.8.1	Specifies the address of a PTP master clock.
Step 7	<b>announce timeout</b> <i>value</i>  <b>Example:</b> Router(config-ptp-port)# announce timeout 8	(Optional) Specifies the number of PTP announcement intervals before the session times out. <ul style="list-style-type: none"> <li><i>value</i>—The range is from 1 to 10. The default is 3.</li> </ul>

	Command	Purpose
<b>Step 8</b>	<p><code>delay-req interval interval</code></p> <p><b>Example:</b>  Router(config-ptp-port)# delay-req interval 1</p>	<p>(Optional) Configures the minimum interval allowed between PTP delay request messages.</p> <p>The intervals are set using log base 2 values, as follows:</p> <ul style="list-style-type: none"> <li>• 5—1 packet every 32 seconds</li> <li>• 4—1 packet every 16 seconds</li> <li>• 3—1 packet every 8 seconds</li> <li>• 2—1 packet every 4 seconds</li> <li>• 1—1 packet every 2 seconds</li> <li>• 0—1 packet every second</li> <li>• -1—1 packet every 1/2 second, or 2 packets per second</li> <li>• -2—1 packet every 1/4 second, or 4 packets per second</li> <li>• -3—1 packet every 1/8 second, or 8 packets per second</li> <li>• -4—1 packet every 1/16 seconds, or 16 packets per second.</li> <li>• -5—1 packet every 1/32 seconds, or 32 packets per second.</li> <li>• -6—1 packet every 1/64 seconds, or 64 packets per second.</li> <li>• -7—1 packet every 1/128 seconds, or 128 packets per second.</li> </ul> <p>The default is -6.</p>
<b>Step 9</b>	<p><code>sync interval interval</code></p> <p><b>Example:</b>  Router(config-ptp-port)# sync interval -5</p>	<p>(Optional) Specifies the interval used to send PTP synchronization messages. The intervals are set using log base 2 values. The Cisco ASR 901 router supports the following values:</p> <ul style="list-style-type: none"> <li>• -5—1 packet every 1/32 seconds, or 32 packets per second.</li> <li>• -6—1 packet every 1/64 seconds, or 64 packets per second.</li> </ul> <p>The default is -6.</p>
<b>Step 10</b>	<p><code>end</code></p> <p><b>Example:</b>  Router(config-ptp-port)# end</p>	<p>Exits clock port configuration mode and enters privileged EXEC mode.</p>

## Configuring a Hybrid Boundary Clock

Complete the following steps to configure a hybrid clocking in PTP boundary clock mode.

### Prerequisites

When configuring a hybrid clock, ensure that the frequency and phase sources are traceable to the same master clock.

### Restrictions

Hybrid clock is not supported with ToP as network-clock. It needs a valid physical clock source, for example, Sync-E/BITS/10M/TDM.

### SUMMARY STEPS

1. **enable**
2. **configure terminal**
3. **ptp clock boundary domain** *domain* [**hybrid**]
4. **clock-port** *port-name* **slave**
5. **transport ipv4 unicast interface** *interface-type interface-number* [**negotiation**]
6. **clock source** *source-address*
7. **clock-port** *port-name* **master**
8. **transport ipv4 unicast interface** *interface-type interface-number* [**negotiation**]
9. **exit**

### DETAILED STEPS

	Command or Action	Purpose
Step 1	<b>enable</b>  <b>Example:</b> Router> enable	Enables privileged EXEC mode. <ul style="list-style-type: none"> <li>• Enter your password if prompted.</li> </ul>
Step 2	<b>configure terminal</b>  <b>Example:</b> Router# configure terminal	Enters global configuration mode.
Step 3	<b>ptp clock boundary domain</b> <i>domain</i> <b>hybrid</b>  <b>Example:</b> Router(config)# ptp clock boundary domain 0 hybrid	Configures the PTP boundary clock and enters clock configuration mode. <ul style="list-style-type: none"> <li>• <i>domain</i>—The PTP clocking domain number. Valid values are from 0 to 127.</li> <li>• <b>hybrid</b>—(Optional) Enables the PTP boundary clock to work in hybrid mode. Enables the hybrid clock such that the output of the clock is transmitted to the remote slaves.</li> </ul>

	Command or Action	Purpose
Step 4	<b>clock-port</b> <i>port-name</i> <b>slave</b>  <b>Example:</b> Router(config-ptp-clk)# clock-port SLAVE slave	Sets the clock port to PTP slave mode and enters the clock port configuration mode. In slave mode, the port exchanges timing packets with a PTP master clock.
Step 5	<b>transport ipv4 unicast interface</b> <i>interface-type</i> <i>interface-number</i> [ <b>negotiation</b> ]  <b>Example:</b> Router(config-ptp-port)# transport ipv4 unicast interface Loopback 0 negotiation	Sets port transport parameters. <ul style="list-style-type: none"> <li>• <i>interface-type</i>—The type of the interface.</li> <li>• <i>interface-number</i>—The number of the interface.</li> <li>• <b>negotiation</b>—(Optional) Enables dynamic discovery of slave devices and their preferred format for sync interval and announce interval messages.</li> </ul>
Step 6	<b>clock source</b> <i>source-address</i>  <b>Example:</b> Router(config-ptp-port)# clock source 133.133.133.133	Specifies the address of a PTP master clock.
Step 7	<b>clock-port</b> <i>port-name</i> <b>master</b>  <b>Example:</b> Router(config-ptp-port)# clock-port Master master	Sets the clock port to PTP master mode. In master mode, the port exchanges timing packets with PTP slave devices.  <b>Note</b> The master clock-port does not establish a clocking session until the slave clock-port is phase aligned.
Step 8	<b>transport ipv4 unicast interface</b> <i>interface-type</i> <i>interface-number</i> [ <b>negotiation</b> ]  <b>Example:</b> Router(config-ptp-port)# transport ipv4 unicast interface Loopback 1 negotiation	Sets port transport parameters. <ul style="list-style-type: none"> <li>• <i>interface-type</i>—The type of the interface.</li> <li>• <i>interface-number</i>—The number of the interface.</li> <li>• <b>negotiation</b>—(Optional) Enables dynamic discovery of slave devices and their preferred format for sync interval and announce interval messages.</li> </ul>
Step 9	<b>exit</b>  <b>Example:</b> Router(config-ptp-port)# <b>exit</b>	Exits clock port configuration mode.

**Note**

The hybrid clock (HC) relies on an external clock source for frequency recovery while phase is recovered through PTP. Once the HC reaches the normal or phase aligned state, and if the external frequency channel is active and traceable to PRC, then the HC moves into the phase aligned state even when the PTP link is down.

## Verifying Hybrid modes

Use the **show running-config | section ptp** command to display the sample output.

```
Router# show running-config | section ptp
```



```

ptp clock ordinary domain 20 hybrid
time-properties gps timeScaleTRUE currentUtcOffsetValidTRUE leap59FALSE leap61FALSE 35
clock-port SLAVE slave
transport ipv4 unicast interface Lo17
clock source 17.17.1.1

```

Use the **show ptp clock running domain** command to display the sample output.

```
Router# show ptp clock running domain
```

```

                                PTP Ordinary Clock [Domain 20] [Hybrid]
State                            Ports          Pkts sent      Pkts rcvd      Redundancy Mode
PHASE_ALIGNED 1                  27132197       81606642       Track all

                                PORT SUMMARY
Name Tx Mode      Role          Transport      State          Sessions      PTP Master
                                           Port Addr
SLAVE unicast     slave         Lo17           Slave          1             17.17.1.1

```

Use the **show platform ptp channel\_status** command to display the sample output after PTP is in normal state.

```
Router#show platform ptp channel_status
```

```

Configured channels : 2
channel[0]: type=0, source=0, frequency=0, tod_index=0, freq_prio=5
           time_enabled=y, freq_enabled=y, time_prio=1 freq_assumed_QL=0
           time_assumed_ql=0, assumed_ql_enabled=n
channel[1]: type=6, source=17, frequency=0, tod_index=0, freq_prio=2
           time_enabled=n, freq_enabled=y, time_prio=0 freq_assumed_QL=0
           time_assumed_ql=0, assumed_ql_enabled=n

```

```

Channel 0:      Frequency          Time
-----
Status OK              OK
Weight 0              100
QL      9              9
-----
QL is not read externally.  Fault status: 00000000

Channel 1:      Frequency          Time
-----
Status OK              Disabled
Weight 100           0
QL      9              9
-----
QL is not read externally.  Fault status: 00000000

```

## SSM and PTP Interaction

PTP carries clock quality in its datasets in the structure defined by the IEEE 1588 specification. The Ordinary Clock (OC) master carries the Grand Master (GM) clock quality in its default dataset which is sent to the downstream OC slaves and Boundary Clocks (BC). The OC slaves and BCs keep the GM clock quality in their parent datasets.

If the T0 clock in Cisco ASR 901 is driven by the clock recovered from the OC Slave (if ToP0/12 is selected as clock-source), then the clock quality in the PTP parent dataset represents the quality of the ToP0/12 input clock. This should be informed to the netsync process for proper clock selection. This is done by translating clockClass data field in clock quality to QL-values expected by netsync.

On the other hand, if Cisco ASR 901 serves as the OC Master, then the GM clock is the clock providing T0 clock to Cisco ASR 901 router. Hence, the T0 clock quality should be used by OC master to fill up clockClass in the clock quality field, in its default dataset. For this, the T0 output QL-value should be mapped to the clockClass value according to ITU-T Telecom Profile, and set in the default dataset of the OC Master. This QL-value is then transmitted to the PTP slaves and BC downstream.

## ClockClass Mapping

The Cisco ASR 901 router supports two methods of mapping PTP ClockClass to SSM/QL-value:

- Telecom Profile based on ITU-T G.8265.1/Y.1365.1 PTP (Telecom) Profile for Frequency Synchronization [2]
- Default method of calculating clockClass based on IEEE 1588v2 PTP specification.

## Telecom Profiles

The Telecom Profile specifies an alternative algorithm for selecting between different master clocks, based on the quality level (QL) of master clocks and on a local priority given to each master clock. Release 3.1.1 introduces support for telecom profiles using a new configuration method, which allow you to configure a clock to use the G.8265.1 recommendations for establishing PTP sessions, determining the best master clock, handling SSM, and mapping PTP classes.

## PTP Redundancy

PTP redundancy is an implementation on different clock nodes by which the PTP slave clock node achieves the following:

- Interact with multiple master ports such as grand master, boundary clock nodes, and so on.
- Open PTP sessions.
- Select the best master from the existing list of masters (referred to as the primary PTP master port or primary clock source).
- Switch to the next best master available in case the primary master fails, or the connectivity to the primary master fails.

**Note**

The Cisco ASR 901 Series Router supports unicast-based timing as specified in the 1588-2008 standard. Hybrid mode is not supported with PTP 1588 redundancy.

## Configuring Telecom Profile in Slave Ordinary Clock

Complete the following steps to configure the telecom profile in slave ordinary clock.

### Prerequisites

- When configuring the Telecom profile, ensure that the master and slave nodes have the same network option configured.
- Negotiation should be enabled for master and slave modes.
- Cisco ASR 901 router must be enabled using the **network-clock synchronization mode QL-enabled** command for both master and slave modes.

### Restrictions

- Telecom profile is not applicable for boundary clocks. It is only applicable for ordinary clocks.
- Hybrid mode with OC-MASTER is not supported.

### SUMMARY STEPS

1. **enable**
2. **configure terminal**
3. **ptp clock ordinary domain** *domain* [**hybrid**]
4. **clock-port** *port-name* **slave** [**profile g8265.1**]
5. **transport ipv4 unicast interface** *interface-type interface-number* [**negotiation**]
6. **clock source** *source-address* [*priority*]
7. **clock source** *source-address* [*priority*]
8. **clock source** *source-address* [*priority*]
9. **clock source** *source-address* [*priority*]
10. **end**

### DETAILED STEPS

	Command	Purpose
Step 1	<b>enable</b>  <b>Example:</b> Router> enable	Enables privileged EXEC mode. <ul style="list-style-type: none"> <li>• Enter your password if prompted.</li> </ul>
Step 2	<b>configure terminal</b>  <b>Example:</b> Router# configure terminal	Enters global configuration mode.

	Command	Purpose
<b>Step 3</b>	<pre>ptp clock ordinary domain domain</pre> <p><b>Example:</b> Router(config)# ptp clock ordinary domain 4</p>	<p>Configures the PTP ordinary clock and enters clock configuration mode.</p> <ul style="list-style-type: none"> <li><i>domain</i>—The PTP clocking domain number. Valid values are from 4 to 23.</li> </ul>
<b>Step 4</b>	<pre>clock-port port-name {master   slave} [profile g8265.1]</pre> <p><b>Example:</b> Router(config-ptp-clk)# clock-port Slave slave</p>	<p>Sets the clock port to PTP slave mode and enters clock port configuration mode. In slave mode, the port exchanges timing packets with a PTP master clock.</p> <p>The profile keyword configures the clock to use the G.8265.1 recommendations for establishing PTP sessions, determining the best master clock, handling SSM, and mapping PTP classes.</p> <p><b>Note</b> Using a telecom profile requires that the clock have a domain number of 4–23.</p>
<b>Step 5</b>	<pre>transport ipv4 unicast interface interface-type interface-number</pre> <p><b>Example:</b> Router(config-ptp-port)# transport ipv4 unicast interface loopback 0</p>	<p>Sets port transport parameters.</p> <ul style="list-style-type: none"> <li><i>interface-type</i>—The type of the interface.</li> <li><i>interface-number</i>—The number of the interface.</li> </ul>
<b>Step 6</b>	<pre>clock source source-address [priority]</pre> <p><b>Example:</b> Router(config-ptp-port)# clock source 8.8.8.1</p>	<p>Specifies the address of a PTP master clock. You can specify a priority value as follows:</p> <ul style="list-style-type: none"> <li>No priority value—Assigns a priority value of 0, the highest priority.</li> <li>1—Assigns a priority value of 1.</li> <li>2—Assigns a priority value of 2.</li> </ul>
<b>Step 7</b>	<pre>clock source source-address [priority]</pre> <p><b>Example:</b> Router(config-ptp-port)# clock source 8.8.8.2 1</p>	<p>Specifies the address of an additional PTP master clock; repeat this step for each additional master clock. You can configure up to four master clocks.</p>
<b>Step 8</b>	<pre>clock source source-address [priority]</pre> <p><b>Example:</b> Router(config-ptp-port)# clock source 8.8.8.3 2</p>	<p>Specifies the address of an additional PTP master clock; repeat this step for each additional master clock. You can configure up to four master clocks.</p>

	Command	Purpose
Step 9	<b>clock source</b> <i>source-address</i> <i>[priority]</i>  <b>Example:</b> Router(config-ptp-port)# clock source 8.8.8.4 3	Specifies the address of an additional PTP master clock; repeat this step for each additional master clock. You can configure up to four master clocks.
Step 10	<b>end</b>  <b>Example:</b> Router(config-ptp-port)# end	Exits clock port configuration mode and enters privileged EXEC mode.

## Configuring Telecom Profile in Master Ordinary Clock

Complete the following steps to configure the telecom profile in the master ordinary clock.

### Prerequisites

- When configuring the telecom profile, ensure that the master and slave nodes have the same network option configured.
- Negotiation should be enabled for master and slave modes.
- Cisco ASR 901 router must be enabled using the **network-clock synchronization mode QL-enabled** command for both master and slave modes.

### Restrictions

- Telecom profile is not applicable for boundary clocks. It is only applicable for ordinary clocks.
- Hybrid mode with OC-MASTER is not supported.

### SUMMARY STEPS

1. **enable**
2. **configure terminal**
3. **ptp clock ordinary domain** *domain*
4. **clock-port** *port-name* **master** [**profile g8265.1**]
5. **transport ipv4 unicast interface** *interface-type interface-number* [**negotiation**]
6. **end**

## DETAILED STEPS

	Command	Purpose
Step 1	<b>enable</b>  <b>Example:</b> Router> enable	Enables privileged EXEC mode. <ul style="list-style-type: none"> <li>Enter your password if prompted.</li> </ul>
Step 2	<b>configure terminal</b>  <b>Example:</b> Router# configure terminal	Enters global configuration mode.
Step 3	<b>ptp clock ordinary domain</b> <i>domain</i>  <b>Example:</b> Router(config)# ptp clock ordinary domain 4	Configures the PTP ordinary clock and enters clock configuration mode. <ul style="list-style-type: none"> <li><i>domain</i>—The PTP clocking domain number. Valid values are from 4 to 23.</li> </ul>
Step 4	<b>clock-port</b> <i>port-name</i> { <b>master</b>   <b>slave</b> } [ <b>profile</b> <b>g8265.1</b> ]  <b>Example:</b> Router(config-ptp-clk)# clock-port Master master profile g8265.1	Sets the clock port to PTP master and enters clock port configuration mode. In master mode, the port exchanges timing packets with a PTP slave devices.  The profile keyword configures the clock to use the G.8265.1 recommendations for establishing PTP sessions, determining the best master clock, handling SSM, and mapping PTP classes.  <b>Note</b> Using a telecom profile requires that the clock have a domain number of 4–23.
Step 5	<b>transport ipv4 unicast interface</b> <i>interface-type interface-number</i>  <b>Example:</b> Router(config-ptp-port)# transport ipv4 unicast interface loopback 0	Sets port transport parameters. <ul style="list-style-type: none"> <li><i>interface-type</i>—The type of the interface.</li> <li><i>interface-number</i>—The number of the interface.</li> </ul>
Step 6	<b>end</b>  <b>Example:</b> Router(config-ptp-port)# end	Exits clock port configuration mode and enters privileged EXEC mode.

## Verifying Telecom profile

Use the **show ptp port running detail** command to display the details of PTP masters configured for a Telecom profile slave. The PTSF and Alarm fields indicate the alarm experienced by the SLAVE clock for the MASTER clock.

```
Router#show ptp port running detail
PORT [slave] CURRENT PTP MASTER PORT
  Protocol Address: 208.1.1.3
  Clock Identity: 0xE4:D3:F1:FF:FE:FF:BC:E4
```

```
PORT [slave] PREVIOUS PTP MASTER PORT
  Protocol Address: 208.1.1.1
  Clock Identity: 0xE4:D3:F1:FF:FE:22:F2:C8
  Reason:
```

```
PORT [slave] LIST OF PTP MASTER PORTS
```

```
LOCAL PRIORITY 0
  Protocol Address: 208.1.1.1
  Clock Identity: 0xE4:D3:F1:FF:FE:22:F2:C8
  PTSF Status:
  Alarm In Stream:
  Clock Stream Id: 0
  Priority1: 128
  Priority2: 128
  Class: 102
  Accuracy: Unknown
  Offset (log variance): 0
  Steps Removed: 0
```

```
LOCAL PRIORITY 1
  Protocol Address: 208.1.1.3
  Clock Identity: 0xE4:D3:F1:FF:FE:FF:BC:E4
  PTSF Status:
  Alarm In Stream:
  Clock Stream Id: 0
  Priority1: 128
  Priority2: 128
  Class: 100
  Accuracy: Unknown
  Offset (log variance): 0
  Steps Removed: 0
```

```
LOCAL PRIORITY 2
  Protocol Address: 208.1.1.4
  Clock Identity: 0x40:55:39:FF:FE:89:44:48
  PTSF Status:
  Alarm In Stream:
  Clock Stream Id: 0
  Priority1: 128
  Priority2: 128
  Class: 102
  Accuracy: Unknown
  Offset (log variance): 0
  Steps Removed: 0
```

Use the **show ptp clock running domain** command to display the sample output.

```
Router#show ptp clock running domain 10
```

```

                                PTP Ordinary Clock [Domain 10]
State          Ports          Pkts sent      Pkts rcvd      Redundancy Mode
-----
PHASE_ALIGNED 1                22459694       67364835       Track all

                                PORT SUMMARY
Name Tx Mode   Role      Transport  State      Sessions    PTP Master
-----
SLAVE unicast  slave    Lo40       Slave      1           4.4.4.3
```

## SESSION INFORMATION

```
SLAVE [Lo40] [Sessions 1]

Peer addr          Pkts in    Pkts out   In Errs    Out Errs
4.4.4.3            60023902  20011138  0          0
```

## Setting the TimeProperties

The timeProperties dataset members (except timeTraceable and frequencyTraceable) can be individually set by using the **time-properties** command.



### Caution

The **time-properties** command does not perform any input validation; use this command with caution.

The following is an example of the time-properties command:

```
Router(config-ptp-clk)# time-properties atomic-clock timeScaleTRUE
currentUtcOffsetValidTRUE leap59TRUE leap61FALSE 34
```

```
slave#show ptp clock dataset time-properties
```

```
CLOCK [Ordinary Clock, domain 0]
  Current UTC Offset Valid: TRUE
  Current UTC Offset: 34
  Leap 59: TRUE
  Leap 61: FALSE
  Time Traceable: TRUE
  Frequency Traceable: TRUE
  PTP Timescale: TRUE
  Time Source: Atomic
```

The values of *Time Traceable* and *Frequency Traceable* are determined dynamically.

## ASR901 Negotiation Mechanism

The Cisco ASR 901 router supports a maximum of 36 slaves, when configured as a negotiated 1588V2 master. For a slave to successfully negotiate with the Cisco ASR 901 master, it should request sync and announce packet rates that are not greater than the sync and announce rate that are currently set in the master.

For example, if the sync interval on the master is -5 (32 packets/second), and if the slave tries to negotiate a value of sync interval value of -6 (64 packets/second), the negotiation fails.

## Static Unicast Mode

A clock destination can be added when the master is configured in the static unicast mode (by configuring the transport without the negotiation flag). The master does not communicate with any other slave, in this configuration.

```
Router(config-ptp-port)#clock destination 9.9.9.10
```



## Configuring ToD on 1588V2 Slave

Use the following commands configure ToD on the 1588V2 slave:

Command	Purpose
Router(config-ptp-clk)# <b>tod</b> <slot>/<subslot> <Cisco/ntp/ubx/nmea>	Configures ToD on 1588V2.
Router(config-ptp-clk)# <b>1pps-out</b> <1 PPS offset in ns> <pulse width> <pulse width unit>	Configures 1 PPS output parameters.

This example shows the ToD configuration on the 1588V2 slave:

```
Router# config terminal
Router(config)# ptp clock ordinary domain 0
Router(config-ptp-clk)# tod 0/0 cisco
Router(config-ptp-clk)# 1pps-out 0 2250 ns
Router(config-ptp-clk)# clock-port SLAVE slave
Router(config-ptp-port)# transport ipv4 unicast interface Lo10 negotiation
Router(config-ptp-port)# clock source 1.1.1.1
Router(config-ptp-port)# end
```

## Troubleshooting Tips

Use the following debug commands to troubleshoot the PTP configuration on the Cisco ASR 901 router:



**Warning**

**We suggest you do not use these debug commands without TAC supervision.**

Command	Purpose
[no] <b>debug platform ptp error</b>	Enables debugging of internal errors. The <b>no</b> form of the command disables debugging internal errors.
[no] <b>debug platform ptp event</b>	Displays event messages. The <b>no</b> form of the command disables displaying event messages.
[no] <b>debug platform ptp verbose</b>	Displays verbose output. The <b>no</b> form of the command disables displaying verbose output.
[no] <b>debug platform ptp all</b>	Debugs for error, event and verbose. The <b>no</b> form of the command disables all debugging.





## Cisco IOS IP SLA

The Cisco IOS IP Service Level Agreements (SLAs) is a core part of the Cisco IOS software portfolio, which allows Cisco customers to analyze IP service levels for IP applications and services, to increase productivity, to lower operational costs, and to reduce the frequency of network outages.

The Cisco IOS IP SLAs uses active traffic monitoring—the generation of traffic in a continuous, reliable, and predictable manner—for measuring network performance. Using Cisco IOS IP SLA, service provider customers can measure and provide SLAs, and enterprise customers can verify service levels, verify out sourced SLAs, and understand network performance.

The Cisco IOS IP SLAs can perform network assessments, verify quality of service (QoS), ease the deployment of new services, and assist administrators with network troubleshooting.

The Cisco IOS IP SLAs can be accessed using the Cisco IOS CLI or Simple Network Management Protocol (SNMP) through the Cisco Round-Trip Time Monitor (RTTMON) and syslog Management Information Bases (MIBs).

For detailed information on Cisco IOS IP SLA features, see [IP SLAs Configuration Guide, Cisco IOS Release 15.1S](#).



**Note**

Cisco IOS IP SLA for VoIP, ICMP Jitter, Gatekeeper and Data Link Switching Plus (DLSw+) features are not supported in Cisco ASR 901 router.

## Contents

- [Configuring IPSLA Path Discovery, page 23-1](#)
- [Two-Way Active Measurement Protocol, page 23-5](#)
- [Configuring TWAMP, page 23-6](#)

## Configuring IPSLA Path Discovery

The LSP path discovery (LPD) feature allows the IP SLA MPLS LSP to automatically discover all the active paths to the forwarding equivalence class (FEC), and configure LSP ping and traceroute operations across various paths between the provide edge (PE) devices.

Complete the following steps to configure IPSLA path discovery in a typical VPN setup for MPLS LPD operation:

## SUMMARY STEPS

1. **enable**
2. **configure terminal**
3. **mpls discovery vpn next-hop**
4. **mpls discovery vpn interval seconds**
5. **auto ip sla mpls-lsp-monitor operation-number**
6. **type echo ipsla-vrf-all**

	Command	Purpose
Step 1	<b>enable</b>  <b>Example:</b> Router> enable	Enables privileged EXEC mode. <ul style="list-style-type: none"><li>• Enter your password if prompted.</li></ul>
Step 2	<b>configure terminal</b>  <b>Example:</b> Router# configure terminal	Enters global configuration mode.
Step 3	<b>mpls discovery vpn next-hop</b>  <b>Example:</b> Router(config)# mpls discovery vpn next-hop	(Optional) Enables the MPLS VPN next hop neighbor discovery process. <b>Note</b> This command is automatically enabled when the auto ip sla mpls-lsp-monitor command is entered.
Step 4	<b>mpls discovery vpn interval seconds</b>  <b>Example:</b> Router(config)# mpls discovery vpn interval 120	(Optional) Specifies the time interval at which routing entries that are no longer valid are removed from the next hop neighbor discovery database of an MPLS VPN.
Step 5	<b>auto ip sla mpls-lsp-monitor operation-number</b>  <b>Example:</b> Router(config)# auto ip sla mpls-lsp-monitor 1 Router(config-auto-ip-sla-mpls)#	Begins configuration for an LSP Health Monitor operation and enters auto IP SLA MPLS configuration mode.
Step 6	<b>type echo ipsla-vrf-all</b>  <b>Example:</b> Router(config-auto-ip-sla-mpls)# type echo ipsla-vrf-all Router(config-auto-ip-sla-mpls-params)#	Enters MPLS parameters configuration submode and allows the user to configure the parameters for an IP SLAs LSP ping operation using the LSP Health Monitor.  For details on the parameters, see <a href="#">Configuration Parameters, page 23-2</a> .

**Configuration Parameters**

```
Router(config)#auto ip sla mpls-lsp-monitor 1
Router(config-auto-ip-sla-mpls)#?
Auto IP SLAs MPLS LSP Monitor entry configuration commands:
  exit  Exit IP SLAs MPLSLM configuration
```

```

type Type of entry

Router(config-auto-ip-sla-mpls)#type ?
  echo          Perform MPLS LSP Ping operation
  pathEcho     Perform MPLS LSP Trace operation

Router(config-auto-ip-sla-mpls)#type pathEcho ?
  ipsla-vrf-all  Configure IP SLAs MPLS LSP Monitor for all VPNS
  vrf            vrf Name

```

Following parameters can be configured in the **auto-ip-sla-mpls-params** mode:

```

Router(config-auto-ip-sla-mpls)#type echo ipsla-vrf-all
Router(config-auto-ip-sla-mpls-params)#?
IP SLAs MPLSLM entry parameters configuration commands:
  access-list      Apply Access-List
  default          Set a command to its defaults
  delete-scan-factor  Scan Factor for automatic deletion
  exit             Exit IP SLAs MPLSLM configuration
  exp             EXP value
  force-explicit-null  force an explicit null label to be added
  lsp-selector     LocalHost address used to select the LSP
  no              Negate a command or set its defaults
  path-discover    IP SLAs LSP path discover configuration
  reply-dscp-bits  DSCP bits in reply IP header
  reply-mode       Reply for LSP echo request
  request-data-size  Request data size
  scan-interval    Scan Interval for automatic discovery in minutes
  secondary-frequency  Frequency to be used if there is any violation condition
                    happens
  tag             User defined tag
  threshold        Operation threshold in milliseconds
  timeout          Timeout of an operation
  ttl             Time to live

```

Following parameters can be configured in the **auto-ip-sla-mpls-lpd-params** mode:

```

Router(config-auto-ip-sla-mpls-params)#path-discover
Router(config-auto-ip-sla-mpls-lpd-params)#?
IP SLAs MPLS LSP Monitor LPD configuration commands:
  default          Set a command to its defaults
  exit            Exit IP SLAs MPLS LSP Monitor path discover
                  configuration
  force-explicit-null  Force an explicit null label to be added
  hours-of-statistics-kept  Maximum number of statistics hour groups to capture
  interval         Send interval between requests in msec
  lsp-selector-base  Base 127/8 address to start the tree trace
  maximum-sessions  Number of concurrent active tree trace requests
                  which can be submit at one time
  no              Negate a command or set its defaults
  scan-period      Time period for finishing tree trace discovery in
                  minutes
  session-timeout  Timeout value for the tree trace request in seconds
  timeout          Timeout for an MPLS Echo Request in seconds

```

## Example for IPSLA Path Discovery

```

auto ip sla mpls-lsp-monitor 1
type echo ipsla-vrf-all

```

```
path-discover
auto ip sla mpls-lsp-monitor schedule 1 schedule-period 1 frequency 10 start-time now
```

This example shows the LPD parameter values configured:

```
auto ip sla mpls-lsp-monitor 2
type echo vrf vpn1
path-discover
force-explicit-null
hours-of-statistics-kept 1
scan-period 30
lsp-selector-base 127.0.0.7
session-timeout 20
timeout 100
interval 1000
auto ip sla mpls-lsp-monitor schedule 2 schedule-period 1 frequency 10 start-time now
```

Router#**show ip sla mpls-lsp-monitor summary**

```
Index                - MPLS LSP Monitor probe index
Destination          - Target IP address of the BGP next hop
Status               - LPD group status
LPD Group ID         - Unique index to identify the LPD group
Last Operation Time  - Last time an operation was attempted by
                    a particular probe in the LPD Group
```

Index	Destination	Status	LPD Group ID	Last Operation Time
1	2.2.2.2	up	100004	*20:08:01.481 UTC Tue Nov 14 2000

Router#**show ip sla mpls-lsp-monitor neighbors**

```
IP SLA MPLS LSP Monitor Database : 1
BGP Next hop 2.2.2.2 (Prefix: 2.2.2.2/32) OK Paths: 2
ProbeID: 100004 (pavan_1)
```

Router# **show ip sla mpls-lsp-monitor lpd operational-state**

```
Entry number: 100004
MPLSLM Entry Number: 1
Target FEC Type: LDP IPv4 prefix
Target Address: 2.2.2.2
Number of Statistic Hours Kept: 2
Last time LPD Stats were reset: *18:00:57.817 UTC Sat Nov 11 2000
Traps Type: 1
Latest Path Discovery Mode: initial complete
Latest Path Discovery Start Time: *20:04:26.473 UTC Tue Nov 14 2000
Latest Path Discovery Return Code: OK
Latest Path Discovery Completion Time(ms): 40
Number of Paths Discovered: 2
```

Path Information :

Path	Outgoing	Lsp	Link	Conn	Adj	NextHop	Downstream
Index	Interface	Selector	Type	Id	Addr	Addr	Label Stack
Status							
1	Vl22	127.0.0.0	90	0	22.1.1.1	22.1.1.1	29
OK							
2	Vl26	127.0.0.0	90	0	26.1.1.2	26.1.1.2	21
OK							

Router# **show ip sla mpls-lsp-monitor configuration**

```
Entry Number : 1
Modification time : *20:19:08.233 UTC Tue Nov 14 2000
Operation Type : echo
Vrf Name : ipsla-vrf-all
Tag :
EXP Value : 0
Timeout(ms) : 5000
```

```
Threshold(ms)      : 5000
Frequency(sec)     : 10
ScanInterval(min)  : 1
Delete Scan Factor : 1
Operations List    : 100006
Schedule Period(sec): 1
Request size       : 100
Start Time         : Start Time already passed
SNMP RowStatus     : Active
TTL value          : 255
Reply Mode         : ipv4
Reply Dscp Bits    :
Path Discover      : Enable
  Maximum sessions : 1
  Session Timeout(seconds) : 120
  Base LSP Selector : 127.0.0.0
  Echo Timeout(seconds) : 5
  Send Interval(msec) : 1000
  Label Shimming Mode :
  Number of Stats Hours : 2
  Scan Period(minutes) : 1
```

```
[Wrap text] [Edit this enclosure]
Unit-test_IPSLA: Added 12/02/2011 00:05:01 by pacv
[Unwrap text] [Edit this enclosure]
Unit-test_IPSLA: Added 12/02/2011 00:05:01 by pacv
```

## Two-Way Active Measurement Protocol

Two-Way Active Measurement Protocol (TWAMP) consists of two related protocols. Use the TWAMP-Control protocol to start performance measurement sessions. You can deploy TWAMP in a simplified network architecture, with the control-client and the session-sender on one device and the server and the session-reflector on another device.

The Cisco IOS software TWAMP implementation supports a basic configuration. [Figure 23-1](#) shows a sample deployment.

[Figure 23-2](#) shows the four logical entities that comprise the TWAMP architecture.

Figure 23-1 TWAMP Deployment

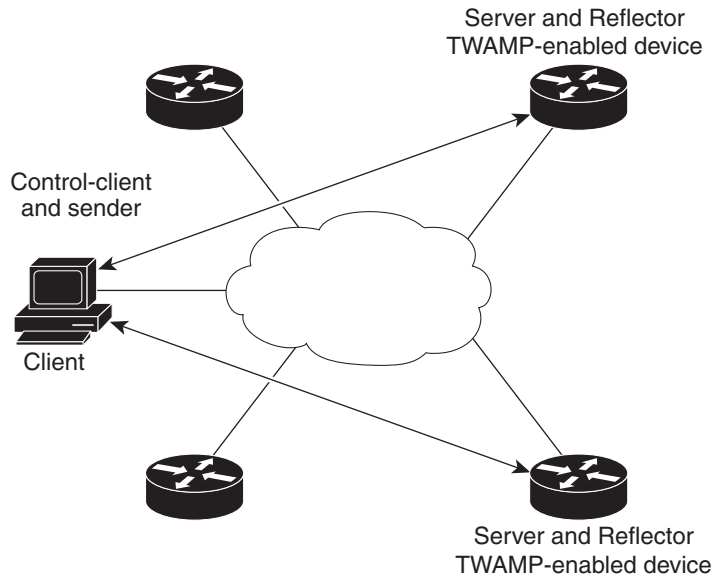

251575

Figure 23-2 TWAMP Architecture

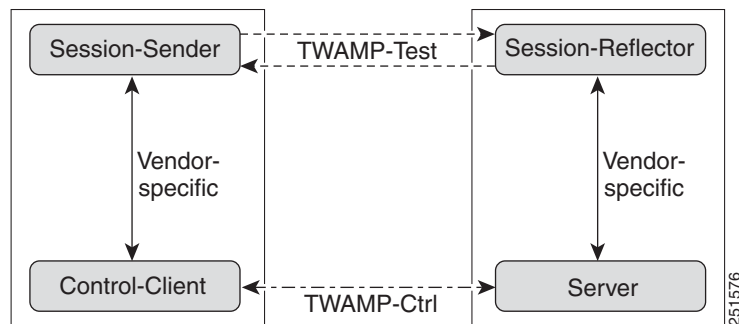

251576

Although each entity is separate, the protocol allows for logical merging of the roles on a single device.

## Configuring TWAMP

The TWAMP server and reflector functionality are configured on the same device. This section contains the following topics:

- [Configuring the TWAMP Server, page 23-7](#)
- [Configuring the TWAMP Reflector, page 23-8](#)
- [Configuration Examples for TWAMP, page 23-8](#)



## Configuring the TWAMP Server

Complete the following steps to configure the TWAMP server:

### SUMMARY STEPS

1. **enable**
2. **configure terminal**
3. **ip sla server twamp**
4. **port *port-number***
5. **timer inactivity *seconds***
6. **end**
7. **copy running-config startup-config**

	Command	Purpose
Step 1	<b>enable</b>  <b>Example:</b> Router> enable	Enables privileged EXEC mode. <ul style="list-style-type: none"> <li>• Enter your password if prompted.</li> </ul>
Step 2	<b>configure terminal</b>  <b>Example:</b> Router# configure terminal	Enters global configuration mode.
Step 3	<b>ip sla server twamp</b>  <b>Example:</b> Router(config)# ip sla server twamp	Configures the Cisco ASR 901 router as a TWAMP server, and enters TWAMP configuration mode.
Step 4	<b>port <i>port-number</i></b>  <b>Example:</b> Router(config-twamp-srvr)# port 9000	(Optional) Specifies the port number to be used by the TWAMP server to listen for connection and control requests. The same port negotiates for the port to which performance probes are sent. The configured port should not be an IANA port or any port used by other applications. The default is port 862.
Step 5	<b>timer inactivity <i>seconds</i></b>  <b>Example:</b> Router(config-twamp-srvr)# timer inactivity 300	(Optional) Sets the maximum time, in seconds. The session can be inactive before the session ends. The range is between 1 to 6000 seconds. The default is 900 seconds.
Step 6	<b>end</b>  <b>Example:</b> Router(config-twamp-srvr)# end	Return to privileged EXEC mode.

To disable the IP SLA TWAMP server, enter the **no ip sla server twamp** global configuration command.

## Configuring the TWAMP Reflector

The TWAMP server and reflector functionality are both configured on the same device.

Complete the following steps to configure the TWAMP reflector:

### SUMMARY STEPS

1. **enable**
2. **configure terminal**
3. **ip sla responder twamp**
4. **timeout *seconds***
5. **end**

	Command	Purpose
Step 1	<b>enable</b>  <b>Example:</b> Router> enable	Enables privileged EXEC mode. <ul style="list-style-type: none"> <li>• Enter your password if prompted.</li> </ul>
Step 1	<b>configure terminal</b>  <b>Example:</b> Router# configure terminal	Enters global configuration mode.
Step 2	<b>ip sla server twamp</b>  <b>Example:</b> Router(config)# ip sla server twamp	Configures the switch as a TWAMP responder, and enter TWAMP configuration mode.
Step 3	<b>timer inactivity <i>seconds</i></b>  <b>Example:</b> Router(config-twamp-srvr)# timer inactivity 300	(Optional) Sets the maximum time, in seconds. The session can be inactive before the session ends. The range is between 1 to 604800 seconds. The default is 900 seconds.
Step 4	<b>end</b>  <b>Example:</b> Router(config-twamp-srvr)# end	Return to privileged EXEC mode.

## Configuration Examples for TWAMP

This section provides the following configuration examples:

- [Example: Configuring the Router as an IP SLA TWAMP server](#)
- [Example: Configuring the Router as an IP SLA TWAMP Reflector](#)

## Example: Configuring the Router as an IP SLA TWAMP server

```
Router(config)# ip sla server twamp
Router(config-twamp-srvr)# port 9000
Router(config-twamp-srvr)# timer inactivity 300
```

## Example: Configuring the Router as an IP SLA TWAMP Reflector

```
Router(config)# ip sla responder twamp
Router(config-twamp-srvr)# timeout 300
```





## Configuring QoS

This chapter describes how to configure quality of service (QoS) by using the modular QoS CLI (MQC) on the Cisco ASR 901 router. With QoS, you can provide preferential treatment to certain types of traffic at the expense of others. When QoS is not configured, the router offers the best-effort service to each packet, regardless of the packet contents or size. It sends the packets without any assurance of reliability, delay bounds, or throughput. MQC provides a comprehensive hierarchical configuration framework for prioritizing or limiting specific streams of traffic.



**Note**

IPv6 QoS is supported only from Cisco IOS Release 15.2(2)SNG onwards.

## Finding Feature Information

Your software release may not support all the features documented in this module. For the latest feature information and caveats, see the release notes for your platform and software release. To find information about the features documented in this module, and to see a list of the releases in which each feature is supported, see the “[Feature Information for Configuring QoS](#)” section on page 24-88.

Use Cisco Feature Navigator to find information about platform support and Cisco software image support. To access Cisco Feature Navigator, go to <http://www.cisco.com/go/cfn>. An account on Cisco.com is not required.

## Contents

- [Understanding QoS](#), page 24-2
- [Configuring Quality of Service \(QoS\)](#), page 24-25
- [QoS Treatment for Performance-Monitoring Protocols](#), page 24-62
- [Additional References](#), page 24-87
- [Feature Information for Configuring QoS](#), page 24-88

# Understanding QoS

Typically, networks operate on a best-effort delivery basis, which means that all traffic has equal priority and an equal chance of being delivered in a timely manner. When congestion occurs, all traffic has an equal chance of being dropped.

When you configure the QoS feature, you can select specific network traffic, prioritize it according to its relative importance, and use traffic-management techniques to provide preferential treatment. Implementing QoS in your network makes network performance more predictable and bandwidth utilization more effective.

Figure 24-1 shows the MQC model.

**Figure 24-1 Modular QoS CLI Model**

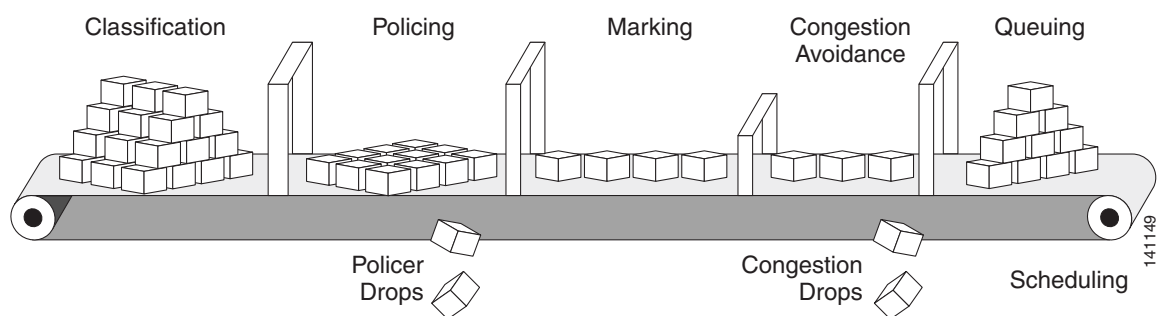

Basic QoS includes these actions.

- Packet classification organizes traffic on the basis of whether or not the traffic matches a specific criteria. When a packet is received, the router identifies all key packet fields: class of service (CoS), Differentiated Services Code Point (DSCP), or IP precedence. The router classifies the packet based on this content or based on an access-control list lookup. For more information, see the [“Classification” section on page 24-7](#).
- Packet policing determines whether a packet is in or out of profile by comparing the rate of the incoming traffic to the configured policer. You can control the traffic flow for packets that conform to or exceed the configured policer. You can configure a committed information rate (CIR) and peak information rate (PIR) and set actions to perform on packets that conform to the CIR and PIR (conform-action), packets that conform to the PIR, but not the CIR (exceed-action), and packets that exceed the PIR value (violate-action). For more information, see the [“Policing” section on page 24-14](#).
- Packet prioritization or marking evaluates the classification and policer information to determine the action to take. All packets that belong to a classification can be remarked. When you configure a policer, packets that meet or exceed the permitted bandwidth requirements (bits per second) can be conditionally passed through, dropped, or reclassified. For more information, see the [“Marking” section on page 24-18](#).
- Congestion management uses queuing and scheduling algorithms to queue and sort traffic that is leaving a port. The router supports these scheduling and traffic-limiting features: class-based weighted fair queuing (CBWFQ), class-based traffic shaping, port shaping, and class-based priority queuing. You can provide guaranteed bandwidth to a particular class of traffic while still servicing other traffic queues. For more information, see the [“Congestion Management and Scheduling” section on page 24-19](#).

### Default QoS for Traffic from External Ethernet Ports

The Cisco ASR 901 router allows complete configuration of QoS via policy-maps for the external ethernet ports. However, the default case when no policy-map is configured is described below:

By default, the qos-group (internal-priority) applied to every packet from an external port is zero.

In cases where Cisco ASR 901 router configuration causes fields to be generated that were not present on the incoming packet, (for example, if a VLAN tag or an MPLS label is added by Cisco ASR 901 that was not present on the incoming packet) the router uses the following default procedures to propagate the priority from the received frame as described below:

- a. In the absence of a policy-map, when adding an 802.1Q VLAN outer tag (service tag) when a service tag was not previously present, the priority value in outer tag is zero. The priority of the inner tag (if present) is not modified from its original value.
- b. When adding an 802.1Q VLAN inner tag (customer tag), the default priority value for the inner tag is zero.
- c. The default QoS-group, used for internal prioritization, output queuing and shaping, and for propagating QoS information to MPLS EXP, is zero.
- d. For tunneling technologies, such as EoMPLS pseudowires and L3VPN, additional defaults are in place to propagate QoS. These are described below:

### Default QoS for Traffic from Internal Ports

The Cisco ASR 901 router does not allow policy maps to be applied to internal ports, such as the Ethernet or PCI ports to the CPU, nor the Ethernet ports to the timing CPU or the Winpath.

Cisco ASR 901 router generally treats these internal ports as trusted. The Cisco ASR 901 Series Aggregation Services Router defaults to propagate the priority from the received frame as described below:

- a. By default, the QoS-group (internal-priority) applied to every packet from an internal port is equal to the priority received in the 802.1Q VLAN tag received on that packet.
- b. If a packet is received on one of these internal interfaces which does not have a VLAN tag attached, a VLAN tag is added internally, with the priority value copied from the ip-precedence field (in case of IP packets), and zero (in case on non-ip packets).
- c. The default QoS-group, (internal priority) for internal queue assignment and for propagating QoS information to MPLS EXP, is set equal to the priority of the outer VLAN tag (either the original or the default value) on the received frame.
- d. For tunneling technologies, such as EoMPLS pseudowires and L3VPN, additional defaults are in place to propagate QoS as follows:
  - For MPLS based L3 VPN and for the EoMPLS (both VPWS and VPLS), upon imposition of the first (bottom of stack) MPLS label, MPLS EXP values are equal to the value is specified in the internal qos-group setting (internal priority).
  - When adding additional MPLS label to an existing stack, the default MPLS EXP values are set to match qos-group value.

This section contains the following topics:

- [Modular QoS CLI, page 24-4](#)
- [Input and Output Policies, page 24-5](#)
- [Classification, page 24-7](#)
- [Table Maps, page 24-13](#)
- [Policing, page 24-14](#)

- [Marking, page 24-18](#)
- [Congestion Management and Scheduling, page 24-19](#)
- [Configuring Quality of Service \(QoS\), page 24-25](#)

## Modular QoS CLI

Modular QoS CLI (MQC) allows users to create traffic policies and attach these policies to interfaces. A traffic policy contains a traffic class and one or more QoS features. Use a traffic class to classify traffic, and the QoS features in the traffic policy determine how to treat the classified traffic.

Complete the following steps to configure Modular QoS CLI:

### Step 1 Define a traffic class.

Use the **class-map** [**match-all** | **match-any**] *class-map-name* global configuration command to define a traffic class and to enter class-map configuration mode. A traffic class contains three elements: a name, an instruction on how to evaluate the configured **match** commands (if more than one match command is configured in the class map), and a series of **match** commands

- Name the traffic class in the **class-map** command line to enter class-map configuration mode.
- You can optionally include keywords to evaluate these match commands by entering **class-map match-any** or **class-map match-all**. If you specify **match-any**, the traffic being evaluated must match *one* of the specified criteria. If you specify **match-all**, the traffic being evaluated must match *all* of the specified criteria. A **match-all** class map can contain only one match statement, but a **match-any** class map can contain multiple match statements.



**Note** If you do not enter **match-all** or **match-any**, the default is to match all.

- Use the **match** class-map configuration commands to specify criteria for classifying packets. If a packet matches the specified criteria, that packet is considered a member of the class and is forwarded according to the QoS specifications set in the traffic policy. Packets that fail to meet any of the matching criteria are classified as members of the default traffic class.

### Step 2 Create a traffic policy to associate the traffic class with one or more QoS features.

Use the **policy-map** *policy-map-name* global configuration command to create a traffic policy and to enter policy-map configuration mode. A traffic policy defines the QoS features to associate with the specified traffic class. A traffic policy contains three elements: a name, a traffic class (specified with the **class** policy-map configuration command), and the QoS policies configured in the class.

- Name the traffic policy in the **policy-map** command line to enter policy-map configuration mode.
- In policy-map configuration mode, enter the name of the traffic class used to classify traffic to the specified policy, and enter policy-map class configuration mode.
- In policy-map class configuration mode, you can enter the QoS features to apply to the classified traffic. These include using the **set**, **police**, or **police aggregate** commands for input policy maps or the **bandwidth**, **priority**, or **shape average** commands for output policy maps.



#### Note

A packet can match only one traffic class within a traffic policy. If a packet matches more than one traffic class in the traffic policy, the first traffic class defined in the policy is used. To configure more than one match criterion for packets, you can associate multiple traffic classes with a single traffic policy.



**Step 3** Attach the traffic policy to an interface.

Use the **service-policy** interface configuration command to attach the policy map to an interface for packets entering or leaving the interface. You must specify whether the traffic policy characteristics should be applied to incoming or outgoing packets. For example, entering the **service-policy output class1** interface configuration command attaches all the characteristics of the traffic policy named *class1* to the specified interface. All packets leaving the specified interface are evaluated according to the criteria specified in the traffic policy named *class1*.



**Note**

If you enter the **no** policy-map configuration command or the **no policy-map** *policy-map-name* global configuration command to delete a policy map that is attached to an interface, a warning message appears that lists any interfaces from which the policy map is being detached. For example:

```
Warning: Detaching Policy test1 from Interface GigabitEthernet0/1
The policy map is then detached and deleted.
```

## Input and Output Policies

Policy maps are either input policy maps or output policy maps, attached to packets as they enter or leave the router by service policies applied to interfaces. Input policy maps perform policing and marking on received traffic. Policed packets can be dropped or reduced in priority (marked down) if they exceed the maximum permitted rates. Output policy maps perform scheduling and queuing on traffic as it leaves the router.

Input policies and output policies have the same basic structure; the difference is in the characteristics that they regulate. Figure 24-2 shows the relationship of input and output policies.

You can configure a maximum of 32 policy maps.

You can apply one input policy map and one output policy map to an interface.

**Figure 24-2** Input and Output Policy Relationship

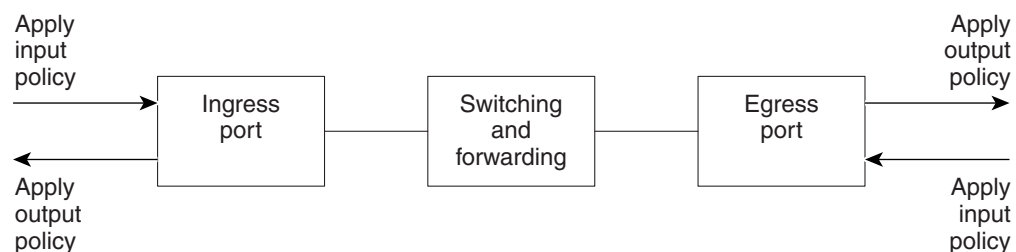

## Input Policy Maps

Input policy map classification criteria include matching a CoS, a DSCP, or an IP precedence value or VLAN ID (for per-port, per-VLAN QoS). Input policy maps can have any of these actions:

- Setting or marking a CoS, a DSCP, an IP precedence, or QoS group value
- Individual policing
- Aggregate policing

Only input policies provide matching on VLAN IDs, and only output policies provide matching on QoS groups. You can assign a QoS group number in an input policy and match it in the output policy. The class **class-default** is used in a policy map for any traffic that does not explicitly match any other class in the policy map. Input policy maps do not support queuing and scheduling keywords, such as **bandwidth**, **priority**, and **shape average**.

An input policy map can have a maximum of 64 classes plus **class-default**. You can configure a maximum of 64 classes in an input policy.

## Output Policy Maps

Output policy map classification criteria include matching a CoS, a DSCP, an IP precedence, or a QoS group value. Output policy maps support scheduling (of **bandwidth**, **priority**, and **shape average**)

Output policy maps do not support matching of access groups. You can use QoS groups as an alternative by matching the appropriate access group in the input policy map and setting a QoS group. In the output policy map, you can then match the QoS group. For more information, see the [“Classification Based on QoS Groups” section on page 24-11](#).

Output policies do not support policing (except in the case of priority with policing).

The class **class-default** is used in a policy map for any traffic that does not explicitly match any other class in the policy map.

An output policy map attached to an egress port can match only the packets that have already been matched by an input policy map attached to the ingress port for the packets. You can attach an output policy map to any or all ports on the router. The router supports configuration and attachment of a unique output policy map for each port. There are no limitations on the configurations of bandwidth, priority, or shaping.

## Access Control Lists

The Cisco IOS Release 15.2(2)SNH1 introduces support for access control list (ACL) based QoS on the Cisco ASR 901 router. This feature provides classification based on source and destination IP. The current implementation of this feature supports only named ACLs.

ACLs are an ordered set of filter rules. Each rule is a permit or a deny statement known as access control entries (ACEs). They filter network traffic by forwarding or blocking routed packets at the interface of the router. The router examines each packet to determine whether to forward or drop the packet based on the criteria specified within the access list.

The permit and deny statements are not applicable when ACLs are used as part of ACL-based QoS. ACLs are used only for traffic classification purposes as part of QoS.

## Restrictions

- Loopback feature should not be enabled when Layer 2 Control Protocol Forwarding is enabled.
- Following IOS keywords are not supported on Cisco ASR 901 router—match-any, ip-options, logging, icmp-type/code, igmp type, dynamic, reflective, evaluate.
- Ingress PACL and RACL supports TCP/UDP port range; Egress ACL does not support port range.
- Sharing access lists across interfaces is not supported.
- ACL is not supported on Management port (FastEthernet) and serial interfaces.

- Devices in the management network (network connected to Fast Ethernet port) cannot be accessed from any other port. If the default route is configured on Cisco ASR 901 to fast ethernet interface (Fa0/0), all the routed packets will be dropped. However, this configuration could keep CPU busy and affect overall convergence.

## Classification

Classification distinguishes one kind of traffic from another by examining the fields in the packet header. When a packet is received, the router examines the header and identifies all key packet fields. A packet can be classified based on the DSCP, the CoS, or the IP precedence value in the packet, or by the VLAN ID. Figure 24-3 shows the classification information carried in a Layer 2 or a Layer 3 IP packet header, using six bits from the deprecated IP type of service (ToS) field to carry the classification information.

- On ports configured as Layer 2 IEEE 802.1Q trunks, all traffic is in 802.1Q frames except for traffic in the native VLAN. Layer 2 802.1Q frame headers have a 2-byte Tag Control Information field that carries the CoS value, called the User Priority bits, in the three most-significant bits, and the VLAN ID value in the 12 least-significant bits. Other frame types cannot carry Layer 2 CoS values.

Layer 2 CoS values range from 0 to 7.

- Layer 3 IP packets can carry either an IP precedence value or a DSCP value. QoS supports the use of either value because DSCP values are backward-compatible with IP precedence values.

IP precedence values range from 0 to 7. DSCP values range from 0 to 63.

- Output remarking is based on the Layer 2 or Layer 3 marking type, marking value and packet type.

**Figure 24-3 QoS Classification Layers in Frames and Packets**

Layer 2 IEEE 802.1Q and IEEE 802.1p Frame

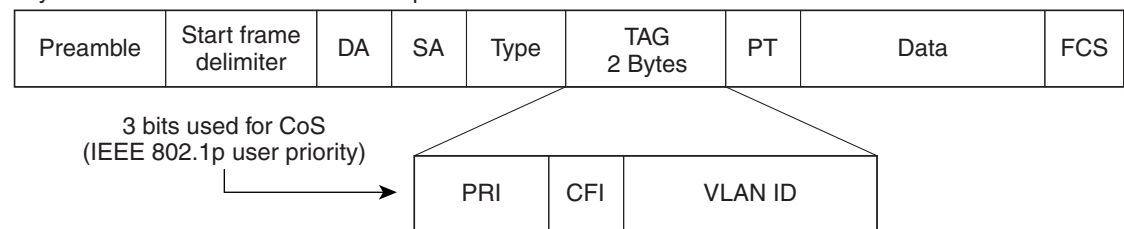

Layer 3 IPv4 Packet

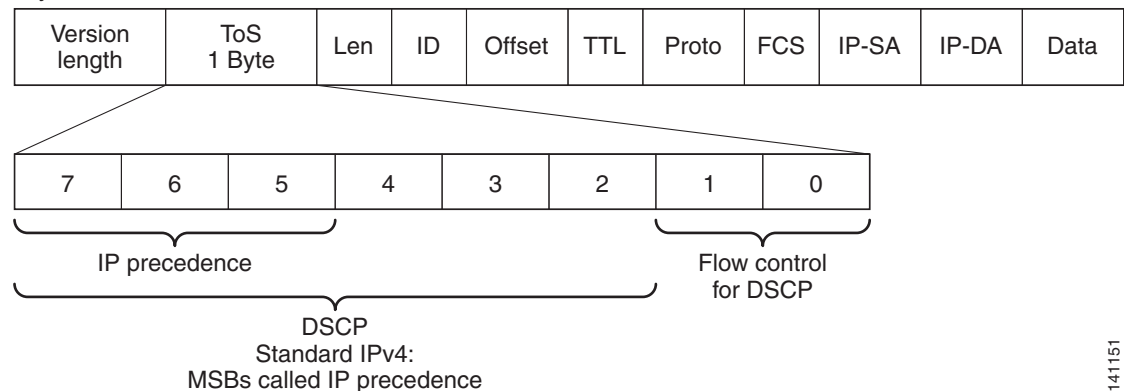

141151

These sections contain additional information about classification:

- “Class Maps” section on page 24-8
- “The match Command” section on page 24-8
- “Classification Based on Layer 2 CoS” section on page 24-9
- “Classification Based on IP Precedence” section on page 24-9
- “Classification Based on IP DSCP” section on page 24-9
- “Classification Comparisons” section on page 24-10
- “Classification Based on QoS Groups” section on page 24-11
- “Classification Based on VLAN IDs” section on page 24-12

## Class Maps

Use an MQC class map to name a specific traffic flow (or class) and to isolate it from all other traffic. A class map defines the criteria used to match against a specific traffic flow to further classify it. If you wish to classify more than one type of traffic, you can create another class map and use a different name. When you use the **class-map** command with a class-map name, the router enters the class-map configuration mode. In this mode, you define the match criterion for the traffic by using the **match class-map** configuration command. After a packet is matched against the class-map criteria, it is acted on by the associated action specified in a policy map.

You can match more than one criterion for classification. You can also create a class map that requires that all matching criteria in the class map be in the packet header by using the **class map match-all class-map name** global configuration command to enter class map configuration mode.



### Note

---

You can configure only one match entry in a **match-all** class map.

---

You can use the **class map match-any class-map name** global configuration command to define a classification with any of the listed criteria.



### Note

---

If you do not enter **match-all** or **match-any**, the default is to match all. A match-all class map cannot have more than one classification criterion (match statement). A class map with no match condition has a default of **match all**.

---

## The match Command

To configure the type of content used to classify packets, use the **match** class-map configuration command to specify the classification criteria. If a packet matches the configured criteria, it belongs to a specific class and is forwarded according to the specified policy. For example, you can use the **match** class-map command with CoS, IP DSCP, and IP precedence values. These values are referred to as *markings* on a packet.

- For an input policy map, you cannot configure an IP classification (**match ip dscp**, **match ip precedence**, **match ip acl**) and a non-IP classification (**match cos** or **match mac acl**) in the same policy map or class map.
- In an output policy map, no two class maps can have the same classification criteria, that is, the same match qualifiers and values.

This example shows how to create a class map *example* to define a class that matches any of the listed criteria. In this example, if a packet is received with the DSCP equal to 32 or a 40, the packet is identified (classified) by the class map.

```
Router(config)# class-map match-any example
Router(config-cmap)# match ip dscp 32
Router(config-cmap)# match ip dscp 40
Router(config-cmap)# exit
```

## Classification Based on Layer 2 CoS

You can use the **match** command to classify Layer 2 traffic based on the CoS value, which ranges from 0 to 7.



### Note

A **match cos** command is supported only on Layer 2 802.1Q trunk ports.

This example shows how to create a class map to match a CoS value of 5:

```
Router(config)# class-map premium
Router(config-cmap)# match cos 5
Router(config-cmap)# exit
```

## Classification Based on IP Precedence

You can classify IPv4 traffic based on the packet IP precedence values, which range from 0 to 7.

This example shows how to create a class map to match an IP precedence value of 4:

```
Router(config)# class-map sample
Router(config-cmap)# match ip precedence 4
Router(config-cmap)# exit
```

## Classification Based on IP DSCP

When you classify IPv4 traffic based on IP DSCP value, and enter the **match ip dscp** class-map configuration command, you have several classification options to choose from:

- Entering a specific DSCP value (0 to 63).
- Using the Default service, which corresponds to an IP precedence and DSCP value of 0. The default per-hop behavior (PHB) is usually best-effort service.
- Using Assured Forwarding (AF) by entering the binary representation of the DSCP value. AF sets the relative probability that a specific class of packets is forwarded when congestion occurs and the traffic does not exceed the maximum permitted rate. AF *per-hop behavior* provides delivery of IP packets in four different AF classes: AF11-13 (the highest), AF21-23, AF31-33, and AF41-43 (the lowest). Each AF class could be allocated a specific amount of buffer space and drop probabilities, specified by the binary form of the DSCP number. When congestion occurs, the drop precedence of a packet determines the relative importance of the packet within the class. An AF41 provides the best probability of a packet being forwarded from one end of the network to the other.
- Entering Class Selector (CS) service values of 1 to 7, corresponding to IP precedence bits in the ToS field of the packet.
- Using Expedited Forwarding (EF) to specify a low-latency path. This corresponds to a DSCP value of 46. EF services use priority queuing to preempt lower priority traffic classes.

This display shows the available classification options:

```
Router(config-cmap)# match ip dscp ?
<0-63> Differentiated services codepoint value
af11 Match packets with AF11 dscp (001010)
af12 Match packets with AF12 dscp (001100)
af13 Match packets with AF13 dscp (001110)
af21 Match packets with AF21 dscp (010010)
af22 Match packets with AF22 dscp (010100)
af23 Match packets with AF23 dscp (010110)
af31 Match packets with AF31 dscp (011010)
af32 Match packets with AF32 dscp (011100)
af33 Match packets with AF33 dscp (011110)
af41 Match packets with AF41 dscp (100010)
af42 Match packets with AF42 dscp (100100)
af43 Match packets with AF43 dscp (100110)
cs1 Match packets with CS1 (precedence 1) dscp (001000)
cs2 Match packets with CS2 (precedence 2) dscp (010000)
cs3 Match packets with CS3 (precedence 3) dscp (011000)
cs4 Match packets with CS4 (precedence 4) dscp (100000)
cs5 Match packets with CS5 (precedence 5) dscp (101000)
cs6 Match packets with CS6 (precedence 6) dscp (110000)
cs7 Match packets with CS7 (precedence 7) dscp (111000)
default Match packets with default dscp (000000)
ef Match packets with EF dscp (101110)
```



**Note**

For more information on DSCP prioritization, see RFC-2597 (AF per-hop behavior), RFC-2598 (EF), or RFC-2475 (DSCP).

## Classification Comparisons

Table 24-1 shows suggested IP DSCP, IP precedence, and CoS values for typical traffic types.

**Table 24-1** Typical Traffic Classifications

Traffic Type	DSCP per-hop	DSCP (decimal)	IP Precedence	CoS
Voice-bearer—traffic in a priority queue or the queue with the highest service weight and lowest drop priority.	EF	46	5	5
Voice control—signalling traffic, related to call setup, from a voice gateway or a voice application server.	AF31	26	3	3
Video conferencing—in most networks, video conferencing over IP has similar loss, delay, and delay variation requirements as voice over IP traffic.	AF41	34	4	4
Streaming video—relatively high bandwidth applications with a high tolerance for loss, delay, and delay variation. Usually considered more important than regular background applications such as e-mail and web browsing.	AF13	14	1	1
Mission critical data (gold data)—delay-sensitive applications critical to the operation of an enterprise.				
<ul style="list-style-type: none"> <li>• Level 1</li> <li>• Level 2</li> <li>• Level 3</li> </ul>	AF21 AF22 AF23	18 20 22	2 2 2	2 2 2

**Table 24-1** Typical Traffic Classifications (continued)

Traffic Type	DSCP per-hop	DSCP (decimal)	IP Precedence	CoS
Less critical data (silver data)—noncritical, but relatively important data. <ul style="list-style-type: none"> <li>Level 1</li> <li>Level 2</li> <li>Level 3</li> </ul>	AF11 AF12 AF13	10 12 14	1 1 1	1 1 1
Best-effort data (bronze data)—other traffic, including all noninteractive traffic, regardless of importance.	Default	0	0	0
Less than best-effort data—noncritical, bandwidth-intensive data traffic given the least preference. This is the first traffic type to be dropped. <ul style="list-style-type: none"> <li>Level 1</li> <li>Level 2</li> <li>Level 3</li> </ul>		2 4 6	0 0 0	0 0 0

## Classification Based on QoS Groups

A QoS group is an internal label used by the router to identify packets as a members of a specific class. The label is not part of the packet header and is restricted to the router that sets the label. QoS groups provide a way to tag a packet for subsequent QoS action without explicitly marking (changing) the packet.

A QoS group is identified at ingress and used at egress; it is assigned in an input policy to identify packets in an output policy. See [Figure 24-3](#). The QoS groups help aggregate different classes of input traffic for a specific action in an output policy.

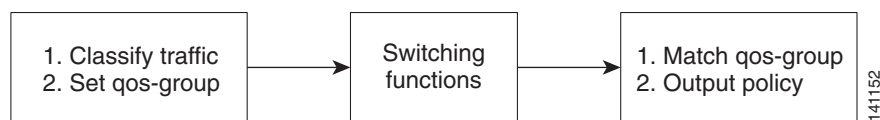
**Figure 24-4** QoS Groups

You can use QoS groups to aggregate multiple input streams across input classes and policy maps for the same QoS treatment on the egress port. Assign the same QoS group number in the input policy map to all streams that require the same egress treatment, and match to the QoS group number in the output policy map to specify the required queuing and scheduling actions.

You can also use QoS groups to identify traffic entering a particular interface if the traffic must be treated differently at the output based on the input interface.

You can use QoS groups to configure per-port, per-VLAN QoS output policies on the egress interface for bridged traffic on the VLAN. Assign a QoS group number to a VLAN on the ingress interface by configuring a per-port, per-VLAN input policy. Then use the same QoS-group number for classification at the egress. Because the VLAN of bridged traffic does not change during forwarding through the router, the QoS-group number assigned to the ingress VLAN can be used on the egress interface to identify the same VLAN.

You can independently assign QoS-group numbers at the ingress to any combination of interfaces, VLANs, traffic flows, and aggregated traffic. To assign QoS-group numbers, configure a QoS group marking in an input policy map, along with any other marking or policing actions required in the input policy map for the same service class. This allows the input marking and policing functions to be decoupled from the egress classification function if necessary because only the QoS group must be used for egress classification.

This example identifies specific packets as part of QoS group 1 for later processing in an output policy:

```
Router(config)# policy-map in-gold-policy
Router(config-pmap)# class in-class1
Router(config-pmap-c)# set qos-group 1
Router(config-cmap-c)# exit
Router(config-cmap)# exit
```

Use the **set qos-group** command only in an input policy. The assigned QoS group identification is subsequently used in an output policy with no mark or change to the packet. Use the **match qos-group** in the output policy.

**Note**

You cannot configure **match qos-group** for an input policy map.

This example creates an output policy to match the QoS group created in the input policy map *in-gold-policy*. Traffic internally tagged as *qos-group 1* is identified and processed by the output policy.

```
Router(config)# class-map out-class1
Router(config-cmap)# match qos-group 1
Router(config-cmap)# exit
```

## Classification Based on VLAN IDs

With classification based on VLAN IDs, you can apply QoS policies to frames carried on a user-specified VLAN for a given interface. Per-VLAN classification is not required on access ports because access ports carry traffic for a single VLAN.

The router supports two policy levels: a *parent* level and a *child* level. With the QoS parent-child structure, you can reference a child policy in a parent policy to provide additional control of a specific traffic type. For per-port, per-VLAN QoS, the parent-level class-default matches the VLAN; match criteria is defined by the service instance encapsulation. You cannot configure multiple service classes at the parent level to match different combinations of VLANs.

**Note**

A per-port, per-VLAN parent-level class map supports only class **class-default**; it should be configured with single rate policer. A flat policy can have multiple classes with match vlan and any action.

**Note**

You can configure only class-default in the parent level of a per-port, per-VLAN hierarchical policy map.

In this example, the class maps in the child-level policy map specify matching criteria for voice, data, and video traffic, and the child policy map sets the action for input policing each type of traffic. The parent-level policy map specifies the VLANs to which the child policy maps are applied on the specified port.

```
Router(config)# class-map match-any dscp-1 data
Router(config-cmap)# match ip dscp 1
Router(config-cmap)# exit
Router(config)# class-map match-any dscp-23 video
```



```

Router(config-cmap)# match ip dscp 23
Router(config-cmap)# exit
Router(config)# class-map match-any dscp-63 voice
Router(config-cmap)# match ip dscp-63
Router(config-cmap)# exit
Router(config)# policy-map customer-1-ingress
Router(config-pmap)# class class-default
Router(config-pmap-c)# service-policy child_policy-1

```

**Note**

You can also enter the match criteria as **match vlan 100 200 300** in the child-level policy-map.

```

Router(config)# policy-map child_policy-1
Router(config-pmap)# class dscp-63 voice
Router(config-pmap-c)# police cir 10000000 bc 50000
Router(config-pmap-c)# conform-action set-cos-transmit 5
Router(config-pmap-c)# exceed-action drop
Router(config-pmap-c)# exit
Router(config-pmap)# class dscp-1 data
Router(config-pmap-c)# set cos 0
Router(config-pmap-c)# exit
Router(config-pmap)# class dscp-23 video
Router(config-pmap-c)# set cos 4
Router(config-pmap-c)# set ip precedence 4
Router(config-pmap-c)# exit

Router(config)# interface gigabitethernet0/1
Router(config-if)# service instance 100 ethernet
Router(config-if)# encapsulation dot1q 100
Router(config-if)# service-policy input customer-1-ingress
Router(config-if)# rewrite ingress tag pop 1 symmetric
Router(config-if)# bridge-domain 100

```

## Table Maps

You can use table maps to manage a large number of traffic flows with a single command. You can specify table maps in **set** commands and use them as mark-down mapping for the policers. You can also use table maps to map an incoming QoS marking to a replacement marking without having to configure a large number of explicit matches and sets. Table maps are used only in input policy maps.

Table maps can be used to:

- Correlate specific CoS, DSCP, or IP precedence values to specific CoS, DSCP, or IP precedence values
- Mark down a CoS, DSCP, or IP precedence value
- Assign defaults for unmapped values

This example creates a table to map specific CoS values to DSCP values. The unspecified values are all mapped to a to-value of 0.

```

Router(config)# table-map cos-dscp-tablemap
Router(config-tablemap)# map from 5 to 46
Router(config-tablemap)# map from 6 to 56
Router(config-tablemap)# map from 7 to 57
Router(config-tablemap)# exit

```

The Cisco ASR 901 router supports a maximum of 32 unique table maps. You can enter up to 64 different **map from-to** entries in a table map. These table maps are supported on the router:

- Cos to Qos-group
- Qos-group to mpls experimental topmost

Table maps modify only one parameter (CoS, IP precedence, or DSCP, whichever is configured) and are only effective when configured with a **set** command in a policy map.

## Policing

After a packet is classified, you can use policing as shown in [Figure 24-5](#) to regulate the class of traffic. The policing function limits the amount of bandwidth available to a specific traffic flow or prevents a traffic type from using excessive bandwidth and system resources. A policer identifies a packet as in or out of profile by comparing the rate of the inbound traffic to the configuration profile of the policer and traffic class. Packets that exceed the permitted average rate or burst rate are *out of profile* or *nonconforming*. These packets are dropped or modified (marked for further processing), depending on the policer configuration.

Policing is used primarily on receiving interfaces. You can attach a policy map with a policer only in an input service policy. The only policing allowed in an output policy map is in priority classes. See the “[Unconditional Priority Policing](#)” section on page 24-16.

**Figure 24-5 Policing of Classified Packets**

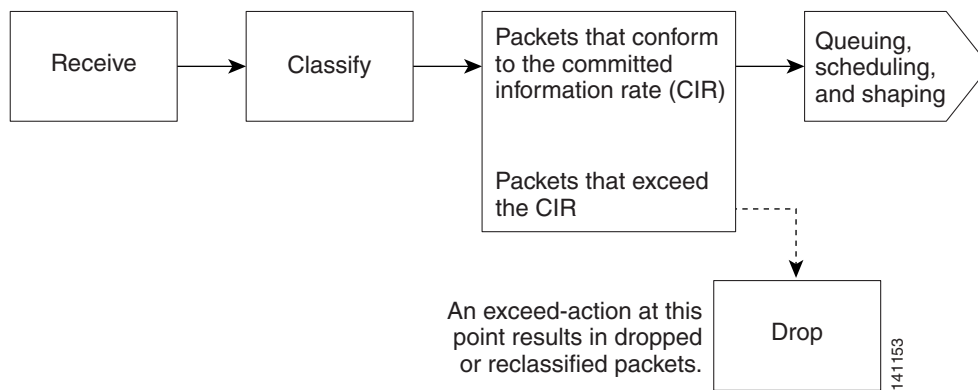

This section contains the following topics:

- [Individual Policing, page 24-15](#)
- [Unconditional Priority Policing, page 24-16](#)

## Individual Policing

Individual policing applies only to input policy maps. In policy-map configuration mode, use the **class** command followed by class-map name, and enter policy-map class configuration mode. Effective with Cisco IOS Release 15.3(3)S, the Cisco ASR 901 supports policing ingress traffic over the cross connect EVC, similar to bridge domain service policy.

Use the **police** policy-map class configuration command to define the policer, the committed rate limitations of the traffic, committed burst size limitations of the traffic, and the action to take for a class of traffic that is below the limits (**conform-action**) and above the limits (**exceed-action**). If you do not specify burst size (bc), the system calculates an appropriate burst size value. The calculated value is appropriate for most applications.

To make the policy map effective, attach it to a physical port by using the **service-policy input** interface configuration command. Policing is done only on received traffic, so you can only attach a policer to an input service policy.



### Note

The QoS-group precedes the CoS value that is matched in the class-map, when the **set qos-group** command is used along with MPLS experimental imposition.

### Restrictions

- Only byte counters are supported.
- Only drop and pass counters are supported.
- If an ingress cross connect policer is attached to a physical interface, an ingress cross connect policer cannot be attached to EVC's under the specific physical port.
- Applying or removing the policy-map on a cross connect interface requires **shutdown** or **no shutdown** on the interface.
- User class based MPLS experimental imposition is supported only for user classes based on CoS match.
- Supports policy-map on 254 ingress cross connect interfaces only.
- Dynamic modification of policy-maps (modifying a policy-map or class-map while it is attached to an interface) is not supported for the policy-maps applied on cross connect.

## Configuration Examples

The following is a sample configuration of basic policing for all traffic received with a CoS of 4. The first value following the **police** command limits the average traffic rate to 10,000,000 bits per second (bps); the second value represents the additional burst size (10 kilobytes). The policy is assigned to gigabitethernet port 1.

```
Router(config)# class-map video-class
Router(config-cmap)# match cos 4
Router(config-cmap)# exit
Router(config)# policy-map video-policy
Router(config-pmap)# class video-class
Router(config-pmap-c)# police 10000000 10000
Router(config-pmap-c-police)# exit
Router(config-pmap-c)# exit
Router(config-pmap)# exit
Router(config)# interface gigabitethernet0/1
Router(config-if)# service-policy input video-policy
Router(config-if)# exit
```

The following is a sample configuration of policing ingress traffic over cross connect EVC.

```
Router(config)# interface GigabitEthernet0/3
Router(config-if)# service instance 22 ethernet
Router(config-if-svr)# encapsulation dot1q 22
Router(config-if-svr)# rewrite ingress tag pop 1 symmetric
Router(config-if-svr)# xconnect 1.1.1.1 100 encapsulation mpls
Router(config-if-svr)# service-policy input policy1
Router(config-if-svr)# exit
```

You can use the **conform-action** and **exceed-action** policy-map class configuration commands or the **conform-action** and **exceed-action** policy-map class police configuration commands to specify the action to be taken when the packet conforms to or exceeds the specified traffic rate.

Conform actions are to send the packet without modifications, to set a new CoS, DSCP, or IP precedence value, or to set a QoS group value for classification at the egress. Exceed actions are to drop the packet, to send the packet without modification, to set a new CoS, DSCP, or IP precedence to a value, or to set a QoS group value for classification at the egress.

You can configure each marking action by using explicit values, table maps, or a combination of both. Table maps list specific traffic attributes and map (or convert) them to other attributes.

You can configure multiple conform and exceed actions simultaneously for each service class.

After you create a table map, configure a policy-map policer to use the table map.



#### Note

---

In Cisco ASR 901, the **from**-type action in the table map must be **cos**.

---

To configure multiple actions in a class, you can enter multiple conform or exceed action entries in policy-map class police configuration mode, as in this example:

```
Router(config)# policy-map map1
Router(config-pmap)# class class1
Router(config-pmap-c)# police 100000 500000
Router(config-pmap-c-police)# conform-action set-cos-transmit 4
Router(config-pmap-c-police)# conform-action set-qos-transmit 4
Router(config-pmap-c-police)# exceed-action set-cos-transmit 2
Router(config-pmap-c-police)# exceed-action set-qos-transmit 2
Router(config-pmap-c-police)# exit
Router(config-pmap-c)# exit
Router(config-pmap)# exit
```

## Unconditional Priority Policing

Priority policing applies only to output policy maps. You can use the **priority** policy-map class configuration command in an output policy map to designate a low-latency path, or class-based priority queuing, for a specific traffic class. With strict priority queuing, the packets in the priority queue are scheduled and sent until the queue is empty, at the expense of other queues. Excessive use of high-priority queuing can create congestion for lower priority traffic.

To eliminate this congestion, you can use priority with implicit policer (priority policing) to reduce the bandwidth used by the priority queue and allocate traffic rates on other queues. Priority with police is the only form of policing supported in output policy maps.



#### Note

---

You cannot configure a policer committed burst size for an unconditional priority policer. Any configured burst size is ignored.

---

This example shows how to use the **priority percent** command to configure *out-class1* as the priority queue, with traffic going to the queue limited to 20,000,000 bps so that the priority queue never uses more than that. Traffic above that rate is dropped. This allows other traffic queues to receive some port bandwidth, in this case a minimum bandwidth guarantee of 50% and 20%. The class **class-default** queue gets the remaining port bandwidth.

```
Router(config)# policy-map policy1
Router(config-pmap)# class out-class1
Router(config-pmap-c)# priority percent 20
Router(config-pmap-c)# exit
Router(config-pmap)# class out-class2
Router(config-pmap-c)# bandwidth percent 50
Router(config-pmap-c)# exit
Router(config-pmap)# class out-class3
Router(config-pmap-c)# bandwidth percent 20
Router(config-pmap-c)# exit
Router(config-pmap)# exit
Router(config)# interface gigabitethernet0/1
Router(config-if)# service-policy output policy1
Router(config-if)# exit
```

## Egress Policing

Egress policing can be classified based on QoS-groups, DSCP, and precedence value. For QoS-groups to work at egress, you should map the traffic at ingress to a specific QoS-group value.

### Restrictions

- Egress policing is supported only on the physical interface (policy-maps are applied only at port level).
- Egress policing on EVC is not supported.
- Egress policing supports up to 64 policers.
- Only byte counters are supported.
- Only drop and pass counters are supported.
- Policing and queuing are not supported together in a policy-map.
- Hierarchical egress policing is not supported.

### Configuration Example

This is an example for egress policing on a physical interface:

```
class-map match-all dscp1
match ip dscp 1
class-map match-all Q1
match qos-group 1
policy-map ingress
class dscp1
  set qos-group 1
policy-map egress
class Q1
  police cir 5000000

int gig 0/1
service-policy input ingress
int gig 0/0
service-policy output egress
end
```

## Marking

You can use packet marking in input policy maps to set or modify the attributes for traffic belonging to a specific class. After network traffic is organized into classes, you use marking to identify certain traffic types for unique handling. For example, you can change the CoS value in a class or set IP DSCP or IP precedence values for a specific type of traffic. These new values are then used to determine how the traffic should be treated. You can also use marking to assign traffic to a QoS group within the router.

Traffic marking is typically performed on a specific traffic type at the ingress port. The marking action can cause the CoS, DSCP, or precedence bits to be rewritten or left unchanged, depending on the configuration. This can increase or decrease the priority of a packet in accordance with the policy used in the QoS domain so that other QoS functions can use the marking information to judge the relative and absolute importance of the packet. The marking function can use information from the policing function or directly from the classification function.

You can specify and mark traffic by using the **set** commands in a policy map for all supported QoS markings (CoS, IP DSCP, IP precedence, and QoS groups). A **set** command unconditionally *marks* the packets that match a specific class. You then attach the policy map to an interface as an input policy map.

You can also mark traffic by using the **set** command with table maps. Table maps list specific traffic attributes and maps (or converts) them to another attribute. A table map establishes a to-from relationship for the attribute and defines the change to be made.

You can simultaneously configure actions to modify DSCP, precedence, and COS markings in the packet for the same service along with QoS group marking actions. You can use the QoS group number defined in the marking action for egress classification.



### Note

When you use a table map in an input policy map, the protocol type of the **from**-type action in the table map must be the same as the protocol type of the associated classification. If the class map represents a non-IP classification, the **from**-type action in the table map must be **cos**.



### Note

Cisco ASR 901 transparently preserves the ECN bits while marking DSCP.

After you create a table map, configure a policy map to use the table map. See the [“Congestion Management and Scheduling”](#) section on page 24-19. Figure 24-6 shows the steps for marking traffic.

**Figure 24-6** Marking of Classified Traffic

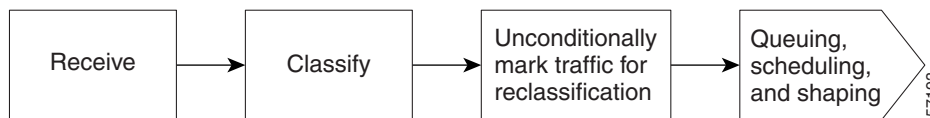

This example uses a policy map to remark a packet. The first marking (the **set** command) applies to the QoS default class map that matches all traffic not matched by class *AF31-AF33* and sets all traffic to an IP DSCP value of 1. The second marking sets the traffic in classes *AF31* to *AF33* to an IP DSCP of 3.

```

Router(config)# policy-map Example
Router(config-pmap)# class class-default
Router(config-pmap-c)# set ip dscp 1
Router(config-pmap-c)# exit
Router(config-pmap)# class AF31-AF33
Router(config-pmap-c)# set ip dscp 3
Router(config-pmap-c)# exit
Router(config-pmap)# exit
  
```

```
Router(config)# interface gigabitethernet0/1
Router(config-if)# service-policy input Example
Router(config-if)# exit
```

## Congestion Management and Scheduling

Cisco Modular QoS CLI (MQC) provides several related mechanisms to control outgoing traffic flow. They are implemented in output policy maps to control output traffic queues. The scheduling stage holds packets until the appropriate time to send them to one of the four traffic queues. Queuing assigns a packet to a particular queue based on the packet class. You can use different scheduling mechanisms to provide a guaranteed bandwidth to a particular class of traffic while also serving other traffic in a fair way. You can limit the maximum bandwidth that can be consumed by a particular class of traffic and ensure that delay-sensitive traffic in a low latency queue is sent before traffic in other queues.

The Cisco ASR 901 router supports these scheduling mechanisms:

- Traffic shaping
  - Use the **shape average** policy map class configuration command to specify that a class of traffic should have a maximum permitted average rate. You specify the maximum rate in bits per second.
- Class-based-weighted-fair-queuing (CBWFQ)
  - Use the **bandwidth** policy-map class configuration command to control the bandwidth allocated to a specific class. Minimum bandwidth can be specified as percentage.
- Priority queuing or class-based priority queuing
  - Use the **priority** policy-map class configuration command to specify the priority of a type of traffic over other types of traffic. You can specify strict priority for the high-priority traffic and allocate any excess bandwidth to other traffic queues, or specify priority with unconditional policing of high-priority traffic and allocate the known remaining bandwidth among the other traffic queues.
    - To configure strict priority, use only the **priority** policy-map class configuration command to configure the priority queue. Use the **bandwidth remaining percent** policy-map class configuration command for the other traffic classes to allocate the excess bandwidth in the desired ratios.
    - To configure priority with unconditional policing, configure the priority queue by using the **priority** policy-map class configuration command and the **police** policy-map class configuration command to unconditionally rate-limit the priority queue. In this case, you can configure the other traffic classes with **bandwidth** or **shape average**, depending on requirements.

These sections contain additional information about scheduling:

- [Traffic Shaping, page 24-19](#)
- [Class-Based Weighted Fair Queuing, page 24-21](#)
- [Priority Queuing, page 24-23](#)

### Traffic Shaping

Traffic shaping is a traffic-control mechanism similar to traffic policing. While traffic policing is used in input policy maps, traffic shaping occurs as traffic leaves an interface. The router can apply class-based shaping to classes of traffic leaving an interface and port shaping to all traffic leaving an interface. Configuring a queue for traffic shaping sets the maximum bandwidth or peak information rate (PIR) of the queue.

**Note**

---

Effective with Cisco IOS Release 15.2(2)SNI, the lower limit of the committed burst size (bc) is 1 ms.

---

## Class-Based Shaping

Class-based shaping uses the **shape average** policy-map class configuration command to limit the rate of data transmission as the number of bits per second to be used for the committed information rate for a class of traffic. The router supports separate queues for three classes of traffic. The fourth queue is always the default queue for class **class-default**, unclassified traffic.

**Note**

---

In the Cisco ASR 901 router, configuring traffic shaping automatically sets the minimum bandwidth guarantee or committed information rate (CIR) of the queue to the same value as the PIR.

---

This example shows how to configure traffic shaping for outgoing traffic on a gigabitethernet port so that *outclass1*, *outclass2*, and *outclass3* get a maximum of 50, 20, and 10 Mbps, respectively, of the available port bandwidth. The class **class-default** at a minimum gets the remaining bandwidth.

```
Router(config)# policy-map out-policy
Router(config-pmap)# class classout1
Router(config-pmap-c)# shape average 50000000
Router(config-pmap-c)# exit
Router(config-pmap)# class classout2
Router(config-pmap-c)# shape average 20000000
Router(config-pmap-c)# exit
Router(config-pmap)# class classout3
Router(config-pmap-c)# shape average 10000000
Router(config-pmap-c)# exit
Router(config-pmap)# exit
Router(config)# interface gigabitethernet 0/1
Router(config-if)# service-policy output out-policy
Router(config-if)# exit
```

## Port Shaping

To configure port shaping (a transmit port shaper), create a policy map that contains only a default class, and use the **shape average** command to specify the maximum bandwidth for a port.

This example shows how to configure a policy map that shapes a port to 90 Mbps, allocated according to the *out-policy* policy map configured in the previous example. The **service-policy** policy map class command is used to create a child policy to the parent:

```
Router(config)# policy-map out-policy-parent
Router(config-pmap)# class class-default
Router(config-pmap-c)# shape average 90000000
Router(config-pmap-c)# service-policy out-policy
Router(config-pmap-c)# exit
Router(config-pmap)# exit
Router(config)# interface gigabitethernet0/1
Router(config-if)# service-policy output out-policy-parent
Router(config-if)# exit
```

## Parent-Child Hierarchy

The router also supports *parent* policy levels and *child* policy levels for traffic shaping. The QoS parent-child structure is used for specific purposes where a child policy is referenced in a parent policy to provide additional control of a specific traffic type.



The first policy level, the parent level, is used for port shaping, and you can specify only one class of type **class-default** within the policy. This is an example of a parent-level policy map:

```
Router(config)# policy-map parent
Router(config-pmap)# class class-default
Router(config-pmap-c)# shape average 50000000
Router(config-pmap-c)# exit
```

The second policy level, the *child* level, is used to control a specific traffic stream or class, as in this example:

```
Router(config)# policy-map child
Router(config-pmap)# class class1
Router(config-pmap-c)# priority
Router(config-pmap-c)# exit
```

**Note**

The total of the minimum bandwidth guarantees (CIR) for each queue of the child policy cannot exceed the total port-shape rate.

This is an example of a parent-child configuration:

```
Router(config)# policy-map parent
Router(config-pmap)# class class-default
Router(config-pmap-c)# shape average 50000000
Router(config-pmap-c)# service-policy child
Router(config-pmap-c)# exit
Router(config-pmap)# exit
Router(config)# interface gigabitethernet0/1
Router(config-if)# service-policy output parent
Router(config-if)# exit
```

## Class-Based Weighted Fair Queuing

You can configure class-based weighted fair queuing (CBWFQ) to set the relative precedence of a queue by allocating a portion of the total bandwidth that is available for the port. Use the **bandwidth** policy-map class configuration command to set the output bandwidth for a class of traffic as a percentage of total bandwidth, or a percentage of remaining bandwidth.

**Note**

When you configure bandwidth in a policy map, you must configure all rates in the same format. The total of the minimum bandwidth guarantees (CIR) for each queue of the policy cannot exceed the total speed of the parent.

- When you use the **bandwidth** policy-map class configuration command to configure a class of traffic as a percentage of total bandwidth, it represents the minimum bandwidth guarantee (CIR) for that traffic class. This means that the traffic class gets at least the bandwidth indicated by the command, but is not limited to that bandwidth. Any excess bandwidth on the port is allocated to each class in the same ratio in which the CIR rates are configured.

**Note**

You cannot configure bandwidth as a percentage of total bandwidth when strict priority (priority without police) is configured for another class in the output policy.

- When you use the **bandwidth** policy-map class configuration command to configure a class of traffic as a percentage of total bandwidth, it represents the portion of the excess bandwidth of the port that is allocated to the class. This means that the class is allocated bandwidth only if there is excess bandwidth on the port, and if there is no minimum bandwidth guarantee for this traffic class.



---

**Note** You can configure bandwidth as percentage of remaining bandwidth only when strict priority (priority without police) is configured for another class in the output policy map.

---



**Note**

---

You cannot configure bandwidth and traffic shaping (**shape average**) or priority queuing (**priority**) for the same class in an output policy map.

---

This example shows how the classes *outclass1*, *outclass2*, and *outclass3* and *class-default* get a minimum of 40%, 20%, 10%, and 10% of the total bandwidth. Any excess bandwidth is divided among the classes in the same proportion as rated in the CIR.

```
Router(config)# policy-map out-policy
Router(config-pmap)# class outclass1
Router(config-pmap-c)# bandwidth percent 40
Router(config-pmap-c)# exit
Router(config-pmap)# class outclass2
Router(config-pmap-c)# bandwidth percent 20
Router(config-pmap-c)# exit
Router(config-pmap)# class outclass3
Router(config-pmap-c)# bandwidth percent 10
Router(config-pmap-c)# exit
Router(config-pmap)# class class-default
Router(config-pmap-c)# bandwidth percent 10
Router(config-pmap-c)# exit
Router(config-pmap)# exit
Router(config)# interface gigabitethernet 0/1
Router(config-if)# service-policy output out-policy
Router(config-if)# exit
```



**Note**

---

When you configure CIR bandwidth for a class as a percentage of the total bandwidth, any excess bandwidth remaining after servicing the CIR of all the classes in the policy map, is divided among the classes in the same proportion as the CIR rates. If the CIR rate of a class is configured as 0, that class is also not eligible for any excess bandwidth and as a result receives no bandwidth.

---

This example shows how to allocate the excess bandwidth among queues by configuring bandwidth for a traffic class as a percentage of remaining bandwidth. The class *outclass1* is given priority queue treatment. The other classes are configured to get percentages of the excess bandwidth if any, after servicing the priority queue; *outclass2* is configured to get 20 percent, *outclass3* to get 30 percent, and the class *class-default* to get the remaining 50 percent.

```
Router(config)# policy-map out-policy
Router(config-pmap)# class outclass1
Router(config-pmap-c)# priority
Router(config-pmap-c)# exit
Router(config-pmap)# class outclass2
Router(config-pmap-c)# bandwidth remaining percent 20
Router(config-pmap-c)# exit
Router(config-pmap)# class outclass3
Router(config-pmap-c)# bandwidth remaining percent 30
Router(config-pmap-c)# exit
Router(config-pmap)# exit
```

```
Router(config)# interface gigabitethernet 0/1
Router(config-if)# service-policy output out-policy
Router(config-if)# exit
```

## Priority Queuing

You can use the **priority** policy-map class configuration command to ensure that a particular class of traffic is given preferential treatment. With strict priority queuing, the priority queue is constantly serviced. All packets in the queue are scheduled and sent until the queue is empty. Priority queuing allows traffic for the associated class to be sent before packets in other queues are sent.



### Caution

Be careful when using the **priority** command. Excessive use of strict priority queuing might cause congestion in other queues.

The router supports strict priority queuing or **priority percent** policy-map command.

- *Strict priority queuing* (priority without police) assigns a traffic class to a low-latency queue to ensure that packets in this class have the lowest possible latency. When this is configured, the priority queue is continually serviced until it is empty, possibly at the expense of packets in other queues.



### Note

You cannot configure priority without policing for a traffic class when traffic shaping or CBWFQ are configured for another class in the same output policy map.

- Use the **priority percent** policy-map command, or *unconditional priority policing*, to reduce the bandwidth used by the priority queue. This is the only form of policing that is supported in output policy maps. Using this combination of commands configures a maximum rate on the priority queue, and you can use the **bandwidth** and **shape average** policy-map commands for other classes to allocate traffic rates on other queues. From Cisco IOS Release 15.3(2)S, Cisco ASR 901 Router allows configuration of multiple classes to serve based on priority.



### Note

When priority is configured in an output policy map *without* the **priority** command, you can only configure the other queues for sharing by using the **bandwidth remaining percent** policy-map command to allocate excess bandwidth.

### Restrictions

- You can associate the **priority** command with a single unique class for all attached output policies on the router. From Cisco IOS Release 15.3(2)S, Cisco ASR 901 Router allows configuration of multiple classes with “priority percent.”
- You cannot configure priority and any other scheduling action (**shape average** or **bandwidth**) in the same class.
- You cannot configure priority queuing for the **class-default** of an output policy map.

This example shows how to configure the class *out-class1* as a strict priority queue so that all packets in that class are sent before any other class of traffic. Other traffic queues are configured so that *out-class-2* gets 50 percent of the remaining bandwidth and *out-class3* gets 20 percent of the remaining bandwidth. The class **class-default** receives the remaining 30 percent with no guarantees.

```
Router(config)# policy-map policy1
Router(config-pmap)# class out-class1
Router(config-pmap-c)# priority
```

```

Router(config-pmap-c) # exit
Router(config-pmap) # class out-class2
Router(config-pmap-c) # bandwidth remaining percent 50
Router(config-pmap-c) # exit
Router(config-pmap) # class out-class3
Router(config-pmap-c) # bandwidth remaining percent 20
Router(config-pmap-c) # exit
Router(config-pmap) # exit
Router(config) # interface gigabitethernet 0/1
Router(config-if) # service-policy output policy1
Router(config-if) # exit

```

This example shows how to use the **priority with percent** commands to configure *out-class1* as the priority queue, with traffic going to the queue limited to 20000000 bps so that the priority queue will never use more than that. Traffic above that rate is dropped. The other traffic queues are configured to use 50 and 20 percent of the bandwidth that is left, as in the previous example.

```

Router(config) # policy-map policy1
Router(config-pmap) # class out-class1
Router(config-pmap-c) # priority percent 20
Router(config-pmap-c) # exit
Router(config-pmap) # class out-class2
Router(config-pmap-c) # bandwidth percent 50
Router(config-pmap-c) # exit
Router(config-pmap) # class out-class3
Router(config-pmap-c) # bandwidth percent 20
Router(config-pmap-c) # exit
Router(config-pmap) # exit

Router(config) # interface gigabitethernet 0/1
Router(config-if) # service-policy output policy1
Router(config-if) # exit

```

The following example shows how to use the **priority with percent** commands to configure multiple traffic classes:

```

Router(config) # policy-map pmap_bckbone
Router(config-pmap) # class VOICE_GRP
Router(config-pmap-c) # priority percent 50
Router(config-pmap-c) # exit
Router(config-pmap) # class CTRL_GRP
Router(config-pmap-c) # priority percent 5
Router(config-pmap-c) # exit
Router(config-pmap) # class E1_GRP
Router(config-pmap-c) # priority percent 55
Router(config-pmap-c) # exit
Router(config-pmap) # class class-default
Router(config-pmap-c) # bandwidth percent 10
Router(config-pmap-c) # exit
Router(config-pmap) # exit

```

## Ingress and Egress QoS Functions

This section lists the supported and unsupported qos functions for ingress and egress.

### Ingress QoS Functions

In Cisco ASR 901 router:

- Interfaces support ingress classification.
- Ethernet interfaces support ingress policing.

- Ethernet interfaces support ingress marking.
- Ethernet interfaces do not support Low-Latency Queuing (LLQ) (Ingress Priority) is not supported on ingress
- Ethernet interfaces do not support Queuing, Shaping and Scheduling on ingress.

### Egress QoS Functions

In Cisco ASR 901 router:

- Gigabit ethernet interfaces support egress classification.
- Gigabit ethernet interfaces do not support egress policing. All policing must be done on ingress.
- Gigabit ethernet interfaces support egress marking.
- Gigabit ethernet interfaces support egress scheduling.
- Interfaces support per interface and per qos-group shaping on egress ports.
- Interfaces support Low Latency Queuing (LLQ) and Weighted Random Early Detection (WRED) on egress.

## Configuring Quality of Service (QoS)

The following sections describe how to configure the Quality of Service (QoS) features supported by the Cisco ASR 901 router.

- [QoS Limitations](#)
- [QoS Configuration Guidelines](#)
- [Sample QoS Configuration](#)
- [Configuring Classification](#)
- [Configuring Marking](#)
- [Configuring Congestion Management](#)
- [Configuring Shaping](#)
- [Configuring Ethernet Trusted Mode](#)
- [Creating IP Extended ACLs](#)
- [Using Class Maps to Define a Traffic Class](#)
- [Creating a Named Access List](#)

## QoS Limitations

The Cisco ASR 901 offers different QoS support according to the physical interface and traffic type. The following sections describe the limitations for each QoS capability on the Cisco ASR 901.

- [General QoS Limitations](#)
- [Statistics Limitations](#)
- [Propagation Limitations](#)
- [Classification Limitations](#)
- [Marking Limitations](#)

- [Congestion Management Limitations](#)
- [Shaping Limitations](#)
- [ACL-based QoS Restrictions](#)

## General QoS Limitations

The following general QoS limitations apply to the Cisco ASR 901 router.

- You can create a maximum of 256 class maps including the class-default class map.
- You can create a maximum of 32 policy-maps.

The following limitations apply to QoS policies on HDLC, PPP, PPP interfaces:

- Input PPP interfaces support only QoS marking policies.
- You can create a maximum of eight **match** statements within a class map in a service policy applied to a PPP interface.
- You can create a maximum of eight classes within a policy-map that is applied to a PPP interface. This number includes the default-class.
- You can have only one priority class within a policy-map applied to a PPP interface.
- The **match-all** keyword of the **class-map** command is not supported.
- The following actions are not supported for Egress Policy:
  - Bandwidth value
  - Priority value
  - Set of qosgroup (VLAN Priority)—This is relevant only for Layer 2 transport over MLPPP interface.
- Requires explicit configuration of class-default with bandwidth percent.
- DSCP marking is not supported for class-default queue.
- All the above restrictions are applicable to MPLS/IP over MLPPP, in addition to the following specific restrictions.

The following limitations apply to QoS policies on MPLS/IP over MLPPP interfaces:

- Cisco ASR 901 router supports the following features for MLPPP egress—DSCP marking priority, eight bandwidth queues, link fragmentation, interleave, and queue limits.
- Input policy is not supported.
- EXP marking is not supported for class-default queue.

The following limitations apply to GigabitEthernet interfaces:

- You can apply a maximum of 2 different service policies to GigabitEthernet interfaces
- You can only use the class-default class for HQoS parent service policies applied to egress Gigabit Ethernet interfaces.

## Statistics Limitations

- Input service policies on the GigabitEthernet interface support statistics in bytes.
- PPP and MLPPP interfaces support QoS statistics in packets.
- Output service policies on the Gigabit Ethernet interface support statistics in bytes.

- 2R3C policer provides exceed and violate counters as a single counter.

## Propagation Limitations

The Cisco ASR 901 has the following limitations when propagating QoS values between interfaces:

- The following limitations apply when traffic ingresses through a GigabitEthernet interface and egresses through a GigabitEthernet interface:
  - When traffic is switched at layer 2, the QoS group is propagated through the router.
- The following limitations apply when traffic ingresses through any other interface type (host-generated, PPP) and egresses through the GigabitEthernet interface.
  - The Precedence bit value is propagated to the CoS bit (for host-generated interface only).
  - The CoS bit value is mapped 1:1 to the QoS group value.

See [Sample QoS Configuration, page 24-33](#) for a sample QoS configuration that accounts for propagation limitations on the Cisco ASR 901.

## Classification Limitations

[Table 24-2](#) summarizes the values that you can use to classify traffic based on interface type. The values are parameters that you can use with the **match** command.

**Table 24-2 QoS Classification Limitations by Interface**

Value	GigabitEthernet		PPP	
	Ingress	Egress	Ingress	Egress
access-group				
all	X	X		
any	X	X	X	X
class-map				
cos	X	X		
destination-address				
discard-class				
dscp	X	X	X	X
flow pdp				
frde				
frdleci				
ip dscp	X	X	X	X
ip precedence	X	X		
ip rtp				
mpls experimental	X			
not				
packet length				
precedence	X	X		

**Table 24-2 QoS Classification Limitations by Interface**

protocol	GigabitEthernet		PPP	
qos-group		X		
source-address				
vlan	X	X		

The following limitations also apply when configuring classification on the Cisco ASR 901.

- The following limitations apply to input Gigabit Ethernet interface QoS policies:
  - You can use the **match vlan** command with a maximum of four VLANs. The **match vlan** command is supported only for PORT, EVC, and pseudowire.
  - You can use the **match dscp** command with a maximum of four DSCP values.
  - Cisco ASR 901 router first looks for IP DSCP and then the MPLS experimental imposition for the mpls packets.
- The following limitations apply to output Gigabit Ethernet interface QoS policies:
  - Class maps with queuing action only support matching based on qos-group. This limitation does not apply to the class-default class map.
  - You cannot create two class maps that match based on the same qos-group value.
- The following limitations apply to input PPP interfaces:
  - You can create up to 8 matches in a class-map using DSCP or MPLS Exp values.

## Marking Limitations

Table 24-3 summarizes the values that you can use to mark traffic based on interface type. The values are parameters that you can use with the **set** command.

**Table 24-3 QoS Marking Limitations by Interface**

Value	GigabitEthernet		PPP	
	Ingress	Egress	Ingress	Egress
atm-clp				
cos	X			
discard-class	X			
dscp	X			
dscp-transmit	X			
ip dscp	X	X	X	
ip precedence	X	X		
mpls experimental				
mpls experimental imposition	X		X	
mpls experimental topmost qos-group		X		



**Table 24-3 QoS Marking Limitations by Interface**

	GigabitEthernet		PPP	
precedence	X			
prec-transmit	X			
qos-group	X		X	

## Congestion Management Limitations

The congestion management limitations for the Cisco ASR 901 are described in the following sections:

- [Queuing Limitations](#)
- [Rate Limiting Limitations](#)

### Queuing Limitations

The Cisco ASR 901 uses Class-based fair weighted queuing (CBFQ) for congestion management. [Table 24-4](#) summarizes the queuing commands that you can apply when using CBFQ according to interface type.

**Table 24-4 QoS Queuing Limitations by Interface**

Value	GigabitEthernet		PPP	
	Ingress	Egress	Ingress	Egress
bandwidth (kbps)				
bandwidth percent		X		X
bandwidth remaining percent		X		X
compression header ip				
drop				
fair-queue				
priority		X		X
priority (kbps)				
priority (without queue-limit)				
priority percent		X		X
queue-limit (cells)				
queue-limit (packets)				X
random-detect discard-class-based		X		

### Rate Limiting Limitations

You can use rate limiting for congestion management on the Cisco ASR 901. [Table 24-5](#) summarizes the rate limiting parameters that you can use with the **police** command according to interface type. The table uses the following terms:

- **Rate**—A speed of network traffic such as a committed information rate (CIR) or peak information rate (PIR).
- **Actions**—A defined action when traffic exceeds a rate, such as conform-action, exceed-action, or violate-action.

**Table 24-5 QoS Rate Limiting Limitations by Interface**

Policing with	GigabitEthernet		PPP	
	Ingress	Egress	Ingress	Egress
One rate				
One rate and two actions	X			
Two rates and two actions				
Two rates and three actions	X			

**Shaping Limitations**

Table 24-6 summarizes the values that you can use to mark traffic based on interface type. The values are parameters that you can use with the **shape** command.

**Table 24-6 QoS Shaping Limitations by Interface**

Value	GigabitEthernet		PPP	
	Ingress	Egress	Ingress	Egress
adaptive				
average		X		
fecn-adapt				
max-buffers				
peak				

The following limitations also apply to QoS shaping on the Cisco ASR 901:

- The following limitations apply to input Gigabit Ethernet interfaces:
  - You cannot apply shaping to the class-default class unless you are using hierarchical policy maps and applying shaping to the parent policy map.
  - If you are using hierarchical policy maps, you can only apply the class-default class to the parent policy map.

**ACL-based QoS Restrictions**

In addition to all the limitations applicable to current QoS configuration, the following restrictions are applicable for ACL-based QoS.

- IPv6 ACLs are not supported
- ACL-based QoS is limited to source and destination IP addresses. Extended ACLs with extended options like DSCP, fragments, option, precedence, time-range, ToS, and TTL are not supported.
- MAC ACLs are not supported. Only IP ACLs are supported.
- You can configure only named access lists in QoS; other ACL types are not supported.
- Only source and destination IPv4 addresses are supported in the access-list definition.

- You can add only a maximum of 128 ACL match filters (including default deny ace) as part of class or classes.

## Improving Feature Scalability

Effective with Cisco IOS Release 15.3(2)S, Ternary Content Addressable Memory (TCAM) is allocated and deallocated dynamically based on system configuration. This improves both feature scalability and efficiency of usage of TCAM. 25 percent of this memory is reserved for Layer 2 and Layer 3 control protocols and the remaining 75 percent is allocated dynamically based on the requirements. Layer 2 and Layer 3 forwarding tables are independent of TCAM.

### TCAM with QoS

The scalability of QoS will change depending on the features configured on the Cisco ASR 901 Router. The following are the examples:

- You can create a maximum of 768 TCAM rules.
- You can create a maximum of 640 TCAM rules with remote loopback in Ethernet OAM (802.3ah), Ethernet loopback, and DelayMeasurement configured.
- You can create a maximum of 512 TCAM rules with remote loopback in Ethernet OAM (802.3ah), Ethernet loopback, DelayMeasurement, and Router ACL configured.

For more information on troubleshooting scalability, see [Troubleshooting Tips, page 24-81](#).

## QoS for MPLS/IP over MLPPP

Effective with Cisco IOS Release 15.4(1)S, the extended QoS functionality is supported on the MLPPP interface. The egress policy supports classification on the MLPS EXP bits.

The following actions are supported:

- Bandwidth percent
- Priority percent
- Setting the MPLS EXP bits
- Setting the queue limit.

### QoS for CPU Generated Traffic

Effective with Cisco IOS Release 15.4(1)S, QoS is provided for CPU generated traffic. The classification is based on DSCP (for packets going over IP adjacency) or EXP (for packets going over TAG Adjacency).

QoS treatment is available for the following CPU generated traffic:

- OSPF Packets
- ICMP Packets
- BGP Packets
- LDP Packets
- ISIS Frames

The QoS configuration for CPU generated traffic is the same as of QoS for MPLS over MLPPP. However, you should use **class-map** to match on DSCP or EXP values of CPU generated traffic.

For example:

- If the OSPF packets use DSCP CS6, the policy-map should use the class-map to match DSCP CS6.
- BGP and LDP packets use either IP Adjacency or TAG Adjacency (depends on type of packets)
  - Packets going over IP Adjacency use DSCP CS6
  - Packets going over TAG Adjacency use EXP 6
- For ICMP packets (PING traffic), the default DSCP value is 0; you can specify TOS value while sending the ping traffic.
- If IS-IS packets do not have either DSCP or EXP; it is treated with the policy configuration of DSCP CS6.



**Note**

The **show policy-map interface multilink *bundle-number*** command shows the combined counters of CPU generated traffic and data traffic, if both data traffic and CPU generated traffic flow in the same class.

## QoS Configuration Guidelines

- You can configure QoS on physical ports and EFPs (only in ingress).
- QoS can likely be configured on Port-channel.
- Only table-map configuration is allowed on SVI interfaces.
- On a port configured for QoS, all traffic received through the port is classified, policed, and marked according to the input policy map attached to the port. On an EFP configured for QoS, traffic in all VLANs received through the port is classified, policed, and marked according to the policy map attached to the port. If a per-port, per-VLAN policy map is attached, traffic on the trunk port is classified, policed, and marked for the VLANs specified in the class filter.
- If you have EtherChannel ports configured on your router, you must configure QoS classification, policing, mapping, and queuing on the individual physical ports that comprise the EtherChannel. You must decide whether the QoS configuration should match on all ports in the EtherChannel.
- Control traffic (such as spanning-tree bridge protocol data units [BPDUs] and routing update packets) received by the router are subject to all ingress QoS processing.
- You might lose data when you change queue settings; therefore, try to make changes when traffic is at a minimum.
- When you try to attach a new policy to an interface and this brings the number of policer *instances* to more than 255, you receive an error message, and the configuration fails.
- When you try to attach new policy to an interface and this brings the number of policer *profiles* to more than 254, you receive an error message, and the configuration fails. A profile is a combination of commit rate, peak rate, commit burst, and peak burst. You can attach one profile to multiple instances, but if one of these characteristics differs, the policer is considered to have a new profile.
- On all Cisco ASR 901 routers, you can specify 128 *unique* VLAN classification criteria within a per-port, per-VLAN policy-map, across all ports on the router. Any policy attachment or change that causes this limit to be exceeded fails with a *VLAN label resources exceeded* error message.

- On all Cisco ASR 901 routers, you can attach per-port and per-port, per-VLAN policy-maps across all ports on the router until QoS classification resource limitations are reached. Any policy attachment or change that causes this limit to be exceeded fails with a *TCAM resources exceeded* error message.

## Sample QoS Configuration

The following configuration demonstrates how to apply QoS given the hardware limitations. The Cisco ASR 901 processes traffic between interfaces as follows:

- For layer 2 traffic passing between the GigabitEthernet 0/2 interface and the GigabitEthernet 0/0 interface, the output queue is determined by the QoS Group assigned in the in-qos policy map.
- For layer 3 traffic passing between GigabitEthernet 0/2 interface and the GigabitEthernet 0/0 interface, the output queue is determined based on the CoS value assigned in the in-qos policy map. (the CoS value is mapped 1:1 to the QoS group value.)
- For traffic passing between other interfaces, the output queue is determined based on the CS fields (top three bits) of the IP DSCP bits; these bits are copied to the CoS bits, which are mapped 1:1 to the QoS group value.

```

!
class-map match-all q0
  match qos-group 0
class-map match-all q1
  match qos-group 1
class-map match-all q2
  match qos-group 2
class-map match-all q3
  match qos-group 3
class-map match-all q4
  match qos-group 4
class-map match-all q5
  match qos-group 5
class-map match-all q6
  match qos-group 6
class-map match-all q7
  match qos-group 7
class-map match-any Voice
  match dscp ef
class-map match-any Signaling
  match dscp af41
class-map match-any HSDPA
  match dscp af11 af12
class-map match-any TCAM1
!translates to 3 TCAM rules because each match in match-any uses one entry
match dscp af21
match cos 3
match mpls experimental topmost
class-map match-all TCAM2
!translates to 1 TCAM rules because all the match-all clauses together take only 1 entry
match dscp af21
match cos 3
match mpls experimental topmost 1
!
policy-map in-qos
  class Voice
    set cos 5
    set qos-group 5
  class control_plane
    set cos 4

```

```

    set qos-group 4
class HSDPA
  set cos 1
  set qos-group 1
!
policy-map out-child
class q5
  priority percent 20
class q4
  bandwidth remaining percent 20
class q1
  bandwidth remaining percent 59
!
!
policy-map out-parent
class class-default
  shape average 100000000
  service-policy out-child
!

```

**Note**

---

This is a partial configuration intended to demonstrate the QoS feature.

---

## Configuring Classification

Classifying network traffic allows you to organize packets into traffic classes based on whether the traffic matches specific criteria. Classifying network traffic is the foundation for enabling many QoS features on your network.

This section contains the following topics:

- [Creating a Class Map for Classifying Network Traffic, page 24-34](#)
- [Creating a Policy Map for Applying a QoS Feature to Network Traffic, page 24-35](#)
- [Attaching the Policy Map to an Interface, page 24-36](#)

### Creating a Class Map for Classifying Network Traffic

Class maps allow you to define classes of network traffic in order to apply QoS features to each class. Complete the following steps to create a class map:

---

**Step 1** Enter enable mode.

```
Router> enable
```

**Step 2** Enter the password.

```
Password: password
```

When the prompt changes to `Router`, you have entered enable mode.

**Step 3** Enter global configuration mode.

```
Router# configure terminal
```

Enter configuration commands, one per line. End with CNTL/Z.

**Step 4** Use the **class-map** command to define a new class map and enter class map configuration mode.

```
Router(config)# class-map class1
```

- Step 5** Use the **match** command to specify the match criteria for the class map. You can define a variety of match criteria including CoS, DSCP, MPLS Exp, or QoS group value.

```
Router(config-cmap)# match qos-group 7
```



---

**Note** Class-default queue matches packets with qos-group 0.

---

- Step 6** Exit configuration mode.

```
Router(config-cmap)# end
Router#
```

---

## Creating a Policy Map for Applying a QoS Feature to Network Traffic

A policy map allows you to apply a QoS feature to network traffic based on the traffic classification. Complete the following steps to create and configure a policy map that uses an existing class map.

- 
- Step 1** Enter enable mode.

```
Router> enable
```

- Step 2** Enter the password.

```
Password: password
```

When the prompt changes to `Router`, you have entered enable mode.

- Step 3** Enter global configuration mode.

```
Router# configure terminal
```

Enter configuration commands, one per line. End with CNTL/Z.

- Step 4** Use the **policy-map** command to define a new policy map and enter policy map configuration mode.

```
Router(config)# policy-map policy1
Router(config-pmap)#
```

- Step 5** Use the **class** command to specify a traffic class to which the policy applies. This command enters policy-map class configuration mode, which allows you to define the treatment for the traffic class.

```
Router(config-pmap)# class class1
Router(config-pmap-c)#
```

Use the **bandwidth** command to specify the bandwidth allocated for a traffic class attached to the policy map. You can define the amount of bandwidth in kbps, a percentage of bandwidth, or an absolute amount of bandwidth. This step is optional.



---

**Note** GigabitEthernet interfaces only support bandwidth defined as a percentage or remaining percent.

---

```
Router(config-pmap-c)# bandwidth percent 50
```

- Step 6** Exit configuration mode.

```
Router(config-cmap)# end
Router#
```

**Note**

---

You can use the **show policy-map** command to verify your configuration.

---

## Attaching the Policy Map to an Interface

After you create the policy map, you must attach it to an interface. Policy maps can be attached to either the input or output direction of the interface.

Complete these steps to attach the policy map to an interface:

---

**Step 1** Enter enable mode.

```
Router> enable
```

**Step 2** Enter the password.

```
Password: password
```

When the prompt changes to *Router*, you have entered enable mode.

**Step 3** Enter global configuration mode.

```
Router# configure terminal
```

Enter configuration commands, one per line. End with CNTL/Z.

**Step 4** Specify the interface to which you want to apply the policy map.

```
Router(config)# interface gigabitEthernet0/1
```

**Step 5** Use the **service-policy** command to attach the policy map to an interface. The **input** and **output** parameters specify the direction in which router applies the policy map.

```
Router(config-if)# service-policy output policy1
```

**Step 6** Exit configuration mode.

```
Router(config-cmap)# end
Router#
```

**Note**

---

You can use the **show policy map** interface command to verify your configuration.

---

For more information about configuring classification, see the [Cisco IOS Quality of Service Solutions Configuration Guide, Release 12.2SR](#).



## Attaching Policy Map to Cross Connect EVC

After you create the policy map, you must attach it to cross connect EVC. Policy maps can be attached only to ingress.

### SUMMARY STEPS

1. **enable**
2. **configure terminal**
3. **interface** *type number*
4. **service instance** *instance-id* **ethernet**
5. **encapsulation dot1q** *vlan-id*
6. **rewrite ingress tag pop 1 symmetric**
7. **xconnect** *peer-ip-address* *vc-id* **encapsulation mpls**
8. **service policy input** *policy name*
9. **exit**

### DETAILED STEPS

	Command or Action	Purpose
Step 1	<b>enable</b>  <b>Example:</b> Router> enable	Enables privileged EXEC mode. <ul style="list-style-type: none"> <li>• Enter your password if prompted.</li> </ul>
Step 2	<b>configure terminal</b>  <b>Example:</b> Router# configure terminal	Enters global configuration mode.
Step 3	<b>interface</b> <i>type number</i>  <b>Example:</b> Router(config)# interface GigabitEthernet0/3	Specifies an interface type and number, and enters interface configuration mode.
Step 4	<b>service instance</b> <i>instance-id</i> <b>ethernet</b>  <b>Example:</b> Router(config-if)# service instance 22 ethernet	Creates a service instance on an interface and defines the matching criteria. <ul style="list-style-type: none"> <li>• <i>instance-id</i>—Unique identifier of the instance.</li> </ul>
Step 5	<b>encapsulation dot1q</b> <i>vlan-id</i>  <b>Example:</b> Router(config-if)# encapsulation dot1q 22	Defines the matching criteria to be used to map 802.1Q frames ingress on an interface to the appropriate EFP. Enter a single VLAN ID for an exact match of the outermost tag. VLAN IDs are 1 to 4094.  <b>Note</b> VLAN IDs 4093, 4094, and 4095 are reserved for internal use.

	Command or Action	Purpose
Step 6	<pre>rewrite ingress tag pop 1 symmetric</pre> <p><b>Example:</b> Router(config-if-svr)# rewrite ingress tag pop 1 symmetric</p>	<p>Specifies the encapsulation modification to occur on packets at ingress.</p> <ul style="list-style-type: none"> <li>pop 1—Pop (remove) the outermost tag.</li> <li>symmetric—Configure the packet to undergo the reverse of the ingress action at egress. If a tag is popped at ingress, it is pushed (added) at egress.</li> </ul> <p>Although the symmetric keyword appears to be optional, you must enter it for rewrite to function correctly.</p>
Step 7	<pre>xconnect peer-ip-address vc-id encapsulation mpls</pre> <p><b>Example:</b> Router(config-if-srv)# xconnect 1.1.1.1 100 encapsulation mpls</p>	<p>Binds an attachment circuit to a pseudowire, and configures an Any Transport over MPLS (AToM) static pseudowire.</p> <ul style="list-style-type: none"> <li>peer-ip-address—IP address of the remote provider edge (PE) peer. The remote router ID can be any IP address, as long as it is reachable.</li> <li>vc-id—The 32-bit identifier of the virtual circuit (VC) between the PE routers.</li> <li>encapsulation—Specifies the tunneling method to encapsulate the data in the pseudowire.</li> <li>mpls—Specifies MPLS as the tunneling method.</li> </ul>
Step 8	<pre>service policy input policy name</pre> <p><b>Example:</b> Router(config-if-srv)# service-policy input policy1</p>	<p>Attaches the policy map to an interface.</p> <ul style="list-style-type: none"> <li>input—Specifies the direction in which the router applies the policy map.</li> <li>policy name—The name of the policy map.</li> </ul>
Step 9	<pre>exit</pre>	<p>Enters global configuration mode.</p>

## Configuring Marking

Marking network traffic allows you to set or modify the attributes for packets in a defined traffic class. You can use marking with traffic classification to configure variety of QoS features for your network.

The Cisco ASR 901 marking allows you to modify the following packet attributes:

- Differentiated services code point (DSCP) value
- Class of service (CoS) value
- MPLS Exp bit value
- Qos-group value (internal)

For instructions on how to configure marking for IP Precedence, DSCP, or CoS value, see the following sections:

- [Creating a Class Map for Marking Network Traffic](#)
- [Creating a Policy Map for Applying a QoS Feature to Network Traffic](#)
- [Attaching the Policy Map to an Interface](#)

For instructions on how to configure MPLS Exp bit marking, see:

- [Configuring MPLS Exp Bit Marking using a Pseudowire.](#)

## Creating a Class Map for Marking Network Traffic

Class maps allow you to define classes of network traffic in order to apply QoS features to each class. Complete the following steps to define a traffic class to mark network traffic:

---

**Step 1** Enter enable mode.

```
Router> enable
```

**Step 2** Enter the password.

```
Password: password
```

When the prompt changes to `Router`, you have entered enable mode.

**Step 3** Enter global configuration mode.

```
Router# configure terminal
```

Enter configuration commands, one per line. End with CNTL/Z.

**Step 4** Use the **class-map** command to define a new class map and enter class map configuration mode.

```
Router(config)# class-map class1
```

**Step 5** Use the **match** command to specify the match criteria for the class map. You can define a variety of match criteria including CoS, DSCP, MPLS Exp, or QoS group value.

```
Router(config-cmap)# match qos-group 7
```

**Step 6** Exit configuration mode.

```
Router(config-cmap)# end  
Router#
```

---

## Creating a Policy Map for Applying a QoS Feature to Network Traffic

Policy maps allow you to apply the appropriate QoS feature to the network traffic based on the traffic classification. The following sections describe how to create and configure a policy map to use a class map or table map.

The following restrictions apply when applying a QoS feature to network traffic:

- A policy map containing the **set qos-group** command can only be attached as an input traffic policy.
- A policy map containing the **set cos** command can only be attached as an input traffic policy.

Complete the following steps to create a policy map.

---

**Step 1** Enter enable mode.

```
Router> enable
```

**Step 2** Enter the password.

```
Password: password
```

When the prompt changes to `Router`, you have entered enable mode.

**Step 3** Enter global configuration mode.

```
Router# configure terminal
```

Enter configuration commands, one per line. End with CNTL/Z.

- Step 4** Use the **policy-map** command to define a policy map and enter policy map configuration mode.

```
Router(config)# policy-map policy1
Router(config-pmap)#
```

- Step 5** Use the **class** command to specify the traffic class for which you want to create a policy and enter policy map class configuration mode. You can also use the **class-default** parameter to define a default class.

```
Router(config-pmap)# class class1
Router(config-pmap-c)#
```

- Step 6** Use one of the **set** commands listed in [Table 24-7](#) to define a QoS treatment type.

**Table 24-7 set Commands Summary**

set Commands	Traffic Attributes	Network Layer	Protocol
<b>set cos</b>	Layer 2 CoS value of the outgoing traffic	Layer 2	802.1q
<b>set dscp</b>	DSCP value in the ToS byte	Layer 3	IP
<b>set qos-group</b>	QoS group ID	Layer 3	IP, MPLS

- Step 7** Exit configuration mode.

```
Router(config-pmap)# end
Router#
```



**Note**

You can use the **show policy-map** or **show policy-map policy-map class class-name** commands to verify your configuration.

## Attaching the Policy Map to an Interface

- Step 1** Enter enable mode.

```
Router> enable
```

- Step 2** Enter the password.

```
Password: password
```

When the prompt changes to *Router*, you have entered enable mode.

- Step 3** Enter global configuration mode.

```
Router# configure terminal
```

Enter configuration commands, one per line. End with CNTL/Z.

- Step 4** Specify the interface to which you want to apply the policy map.

```
Router(config)# interface gigabitEthernet0/1
```

- Step 5** Use the **service-policy** command to attach the policy map to an interface. The **input** and **output** parameters specify the direction in which router applies the policy map.

```
Router(config-if)# service-policy input policy1
```

- Step 6** Exit configuration mode.

```
Router(config-cmap)# end
Router#
```



**Note** You can use the **show policy map** interface command to verify your configuration.

## Configuring MPLS Exp Bit Marking using a Pseudowire

You can also configure MPLS Exp bit marking within an EoMPLS pseudowire interface using the **set mpls experimental imposition** command. MQC based policy configuration supersedes pseudowire-class mode of configuring QoS marking. The MQC policy shall contain only class-default with set action to achieve the same. Follow these steps to configure MPLS Exp bit marking using a pseudowire interface.

Complete the following steps to apply a marking policy to a pseudowire:

- Step 1** Enter the interface configuration mode.

```
Router(config)# interface gigabitethernet 0/0
Router(config-if)#
```

- Step 2** Specify an EVC.

```
Router(config-if)# service instance 1 ethernet
Router(cfg-if-srv)#
```

- Step 3** Specify an encapsulation type for the EVC.

```
Router(cfg-if-srv)# encapsulation dot1q 200
```

- Step 4** Use the **xconnect** command with the service policy that uses the configuration defined in the pseudowire class.

```
Router(cfg-if-srv)# xconnect 10.10.10.1 121
Router(cfg-if-srv)# service-policy in <mark-policy>
```

For more information about configuring marking, see the [Cisco IOS Quality of Service Solutions Configuration Guide, Release 12.2SR](#).



**Note** The Cisco ASR 901 does not support all of the commands described in the IOS Release 12.2SR documentation.

### Configuration Example

This is a sample configuration example for applying a marking policy to a pseudowire.

```

policy-map cos-6
class cos-6
  police rate percent 5
    conform-action transmit
    exceed-action drop
set mpls experimental imposition 4
interface GigabitEthernet0/3
no ip address
load-interval 30
negotiation auto
service instance 22 ethernet
  encapsulation dot1q 22
  rewrite ingress tag pop 1 symmetric
  service-policy input cos-6
xconnect 2.2.2.2 22 encapsulation mpls

```

## Configuring Congestion Management

The following sections describe how to configure congestion management on the Cisco ASR 901.

- [Configuring Low Latency Queueing \(LLQ\)](#)
- [Configuring Multiple Priority Queueing](#)
- [Configuring Class-Based Weighted Fair Queueing \(CBFQ\)](#)
- [Weighted Random Early Detection \(WRED\)](#)

### Configuring Low Latency Queueing (LLQ)

Low latency queuing allows you to define a percentage of bandwidth to allocate to an interface or PVC as a percentage. You can define a percentage for priority or nonpriority traffic classes.

Complete the following steps to configure LLQ.

---

**Step 1** Enter enable mode.

```
Router> enable
```

**Step 2** Enter the password.

```
Password: password
```

When the prompt changes to *Router*, you have entered enable mode.

**Step 3** Enter global configuration mode.

```
Router# configure terminal
```

Enter configuration commands, one per line. End with CNTL/Z.

**Step 4** Use the **policy-map** command to define a policy map.

```
Router(config)# policy-map policy1
```

**Step 5** Use the **class** command to reference the class map that defines the traffic to which the policy map applies.

```
Router(config-pmap)# class class1
Router(config-pmap-c)#
```

**Step 6** Use the **priority** command to specify the priority percentage allocated to the traffic class assigned to the policy map. You can use the **burst** parameter to configure the network to accommodate temporary bursts of traffic.

```
Router(config-pmap-c)# priority percent 10
```

**Step 7** Use the **bandwidth** command to specify the bandwidth available to the traffic class within the policy map. You can specify the bandwidth in kbps or by a percentage of bandwidth.

```
Router(config-pmap-c)# bandwidth percent 30
```

**Step 8** Exit configuration mode.

```
Router(config-pmap-c)# end
Router#
```



**Note** You can use the **show policy-map**, **show policy-map policy-map class class-name**, or **show policy-map interface** commands to verify your configuration.

## Configuring Multiple Priority Queuing

Multiple priority queuing allows you to configure more than one class with priority percentage. The queue-number decides the ordering. The QoS group is serviced in the descending order starting with the highest queue number. This guarantees each of the queues its allocated bandwidth. This configuration has a higher latency on the lower priority queue like voice, due to servicing multiple traffic types on priority.

### Restrictions

There is no provision to configure the priority level for a traffic class.

Complete the following steps to configure multiple priority queuing.

### SUMMARY STEPS

1. **configure terminal**
2. **policy-map**
3. **class**
4. **priority percent**
5. **bandwidth**
6. **exit**

## DETAILED STEPS

	Command	Purpose
Step 1	<b>configure terminal</b>	Enters global configuration mode. Enter your password if prompted.
Step 2	<b>policy-map</b>  <b>Example</b> Router(config)# policy-map policy1 Router(config-pmap)#	Defines a new policy map and enters policy map configuration mode.
Step 3	<b>class</b>  <b>Example</b> Router(config-pmap)# class class1 Router(config-pmap-c)#	Specifies a traffic class to which the policy applies. This command enters policy-map class configuration mode, which allows you to define the treatment for the traffic class.
Step 4	<b>priority percent</b>  <b>Example</b> Router(config-pmap-c)# priority percent 10	Specifies the priority percentage allocated to the traffic class assigned to the policy map.
Step 5	<b>bandwidth</b>  <b>Example</b> Router(config-pmap-c)# bandwidth percent 50	(Optional) Specifies the bandwidth allocated for a traffic class attached to the policy map. You can define the percentage of bandwidth, or an absolute amount of bandwidth.
Step 6	<b>exit</b>	Returns to global configuration mode.

## Configuration Examples

This section shows sample configuration examples for multiple priority queuing on Cisco ASR 901 Router:

```
policy-map pmap_bckbone
 class VOICE_GRP
   priority percent 50
 class CTRL_GRP
   priority percent 5
 class E1_GRP
   priority percent 35
 class class-default
   bandwidth percent 10
```

**Note**

You can use the **show policy-map**, **show policy-map policy-map class class-name**, or **show policy-map interface** commands to verify your configuration.



## Configuring Class-Based Weighted Fair Queuing (CBFQ)

The Cisco ASR 901 supports Class-Based Weighted Fair Queuing (CBWFQ) for congestion management.

Complete the following steps to configure CBWFQ.

**Step 1** A class map contains match criteria against which a packet is checked to determine if it belongs to the class. You can use class maps to define criteria that are referenced in one or more policy maps. Complete the following steps to configure a class map.

- a. Use the **class-map** command to create a class map.

```
Router(config)# class-map class1
Router(config-cmap)#
```

- b. Use the **match** command to specify the match criteria for the class map. You can define a variety of match criteria including CoS, DSCP, MPLS Exp, or QoS group value.

```
Router(config-cmap)# match qos-group 7
```

- c. Use the **exit** command to exit class map configuration.

```
Router(config-cmap)# exit
Router(config)#
```

**Step 2** Complete the following steps to configure a policy map and attach it to an interface.



**Note**

The Cisco ASR 901 does not support the **queue-limit** commands. Only **random-detect discard-class-based** is supported on GigabitEthernet Interfaces.

- a. Use the **policy-map** command to define a policy map.

```
Router(config)# policy-map policy1
Router(config-pmap)#
```

- b. Use the **class** command to reference the class map that defines the traffic to which the policy map applies.

```
Router(config-pmap)# class class1
Router(config-pmap-c)#
```

- c. Use the **bandwidth** command to specify the bandwidth allocated for the traffic class.

```
Router(config-pmap-c)# bandwidth percent 10
```

- d. Use the **exit** command to exit the policy map class configuration.

```
Router(config-pmap-c)# exit
Router(config-pmap)#
```

- e. Use the **exit** command to exit the policy map configuration.

```
Router(config-pmap)# exit
Router(config)#
```

- f. Enter configuration for the interface to which you want to apply the policy map.

```
Router(config)# interface atm0/ima0
```

- g. Use the **service-policy** command to apply the service policy to the interface.

```
Router(config-if)# service-policy output policy1
```

## Weighted Random Early Detection (WRED)

Random Early Detection (RED) is a congestion avoidance mechanism that takes advantage of the congestion control mechanism of TCP. By randomly dropping packets prior to periods of high congestion, RED tells the packet source to decrease its transmission rate. WRED drops packets selectively based on IP discard-class. Discard-class is assigned to packets at the ingress, as they enter the network. WRED is useful on any output interface where you expect to have congestion. However, WRED is usually used in the core routers of a network, rather than at the edge. WRED uses discard-class to determine how it treats different types of traffic.

When a packet arrives, the following events occur:

1. The average queue size is calculated.
2. If the average is less than the minimum queue threshold, the arriving packet is queued.
3. If the average is between the minimum queue threshold for that type of traffic and the maximum threshold for the interface, the packet is either dropped or queued, depending on the packet drop probability for that type of traffic.
4. If the average queue size is greater than the maximum threshold, the packet is dropped.



### Note

Cisco ASR 901 supports configuration of random-detect thresholds only in number-of-packets.

Complete the following steps to configure WRED:

	Command	Purpose
Step 1	<b>configure terminal</b>	Enter global configuration mode
Step 2	<b>policy-map</b>  <b>Example</b> Router(config)# policy-map policy1 Router(config-pmap)#	Define a new policy map and enter policy map configuration mode.
Step 3	<b>class</b>  <b>Example</b> Router(config-pmap)# class class1 Router(config-pmap-c)#	Specify a traffic class to which the policy applies. This command enters policy-map class configuration mode, which allows you to define the treatment for the traffic class.
Step 4	<b>bandwidth</b>  <b>Example</b> Router(config-pmap-c)# bandwidth percent 50	Specify the bandwidth allocated for a traffic class attached to the policy map. You can define the percentage of bandwidth, or an absolute amount of bandwidth.  This step is optional.

Command	Purpose
<b>Step 5</b> <b>[no] random-detect discard-class-based</b>	Base WRED on the discard class value of a packet.  To disable this feature, use the <b>no</b> form of this command.
<b>Step 6</b> <b>[no] random-detect discard-class</b> <i>value</i> <i>min-threshold max-threshold</i> <i>mark-prob-denominator</i>  <b>Example</b> <pre>Router(config-pmap-c)# random-detect discard-class 2 100 200 10</pre>	Configure WRED parameters for a discard-class value for a class policy in a policy map. <ul style="list-style-type: none"> <li><i>value</i>—Discard class. Valid values are 0 to 2.</li> </ul> <b>Note</b> WRED counters are not supported for discard class 0. <ul style="list-style-type: none"> <li><i>min-threshold</i>—Minimum threshold in number of packets. Valid values are 1 to 4096. When the average queue length reaches the minimum threshold, WRED randomly drops some packets with the specified IP precedence.</li> <li><i>max-threshold</i>—Maximum threshold in number of packets. Valid values are 1 to 4096. When the average queue length exceeds the maximum threshold, WRED drops all packets with the specified IP precedence.</li> </ul> <b>Note</b> Max-threshold values configured above 1024 cannot be reached. <ul style="list-style-type: none"> <li><i>mark-prob-denominator</i>—Denominator for the fraction of packets dropped when the average queue depth is at the maximum threshold. For example, if the denominator is 512, 1 out of every 512 packets is dropped when the average queue is at the maximum threshold. Valid values are 1 to 65535. The default is 10; 1 out of every 10 packets is dropped at the maximum threshold.</li> </ul> To return the values to the default for the discard class, use the <b>no</b> form of this command.

## Configuring Shaping

The Cisco ASR 901 supports class-based traffic shaping. Follow these steps to configure class-based traffic shaping.

Class-based traffic shaping is configured using a hierarchical policy map structure; you enable traffic shaping on a primary level (parent) policy map and other QoS features such as queuing and policing on a secondary level (child) policy map.

This section contains the following topics:

- [Configuring Class-Based Traffic Shaping in a Primary-Level \(Parent\) Policy Map](#)
- [Configuring the Secondary-Level \(Child\) Policy Map](#)

### Configuring Class-Based Traffic Shaping in a Primary-Level (Parent) Policy Map

Follow these steps to configure a parent policy map for traffic shaping.

- Step 1** Use the **policy-map** command to specify the policy map for which you want to configure shaping and enter policy-map configuration mode.

```
Router(config)# policy-map output-policy
```

- Step 2** Use the **class** command to specify the traffic class to which the policy map applies.

```
Router(config-pmap)# class class1
Router(config-pmap-c)#
```

- Step 3** Use the **shape** command to define algorithm and rate used for traffic shaping.

```
Router(config-pmap-c)# shape average mean-rate burst-size
```

- Step 4** Use the **service-policy** command to attach the policy map to the class map.

```
Router(config-pmap-c)# service-policy policy-map
```

- Step 5** Exit configuration mode.

```
Router(config-pmap-c)# end
Router#
```

**Note**

---

You can use the **show policy-map** command to verify your configuration.

---

For more information about configuring shaping, see [Regulating Packet Flow on a Per-Class Basis---Using Class-Based Traffic Shaping](#).

**Note**

---

The Cisco ASR 901 does not support all of the commands described in the IOS Release 12.2SR documentation.

---

## Configuring the Secondary-Level (Child) Policy Map

Follow these steps to create a child policy map for traffic shaping.

- Step 1** Use the **policy-map** command to specify the policy map for which you want to configure shaping and enter policy-map configuration mode.

```
Router(config)# policy-map output-policy
```

- Step 2** Use the **class** command to specify the traffic class to which the policy map applies.

```
Router(config-pmap)# class class1
Router(config-pmap-c)#
```

- Step 3** Use the **bandwidth** command to specify the bandwidth allocated to the policy map. You can specify the bandwidth in kbps, a relative percentage of bandwidth, or an absolute amount of bandwidth.

```
Router(config-pmap-c)# bandwidth percent 50
```

- Step 4** Exit configuration mode.

```
Router(config-pmap-c)# end
Router#
```

For more information about configuring shaping, see [Regulating Packet Flow on a Per-Class Basis---Using Class-Based Traffic Shaping](#).

**Note**

The Cisco ASR 901 does not support all of the commands described in the IOS Release 12.2SR documentation.

## Configuring Ethernet Trusted Mode

The Cisco ASR 901 supports trusted and non-trusted mode for Gigabit ethernet ports. Gigabit ethernet ports are set in non-trusted mode by default. Trust mode is configured through table-maps. Use the **set qos-group cos** command to use default mapping.

## Creating IP Extended ACLs

Complete the following steps to create an IP extended ACL for IP traffic:

	Command	Purpose
Step 1	<b>configure terminal</b>	Enter global configuration mode.
Step 2	<b>access-list</b> <i>access-list-number</i> <b>permit</b> <i>protocol</i> { <i>source source-wildcard destination destination-wildcard</i> } [ <b>precedence</b> <i>precedence</i> ] [ <b>tos</b> <i>tos</i> ] [ <b>dscp</b> <i>dscp</i> ]	<p>Create an IP extended ACL. Repeat the step as many times as necessary.</p> <ul style="list-style-type: none"> <li>For <i>access-list-number</i>, enter the access list number. The range is 100 to 199 and 2000 to 2699.</li> <li>For <i>protocol</i>, enter the name or number of an IP protocol. Use the question mark (?) to see a list of available protocols. To match any Internet protocol (including ICMP, TCP, and UDP), enter <b>ip</b>.</li> <li>The <i>source</i> is the number of the network or host sending the packet.</li> <li>The <i>source-wildcard</i> applies wildcard bits to the source.</li> <li>The <i>destination</i> is the network or host number receiving the packet.</li> <li>The <i>destination-wildcard</i> applies wildcard bits to the destination.</li> </ul> <p>You can specify source, destination, and wildcards as:</p> <ul style="list-style-type: none"> <li>The 32-bit quantity in dotted-decimal format.</li> <li>The keyword <b>any</b> for 0.0.0.0 255.255.255.255 (any host).</li> <li>The keyword <b>host</b> for a single host 0.0.0.0.</li> </ul>
or	<b>ip access-list extended</b> <i>name</i>	<p>Define an extended IPv4 access list using a name, and enter access-list configuration mode. The <i>name</i> can be a number from 100 to 199.</p> <p>In access-list configuration mode, enter <b>permit</b> <i>protocol</i> {<i>source source-wildcard destination destination-wildcard</i>}.</p>
Step 3	<b>end</b>	Return to privileged EXEC mode.
Step 4	<b>show access-lists</b>	Verify your entries.
Step 5	<b>copy running-config startup-config</b>	(Optional) Save your entries in the configuration file.

To delete an access list, use the **no access-list** *access-list-number* global configuration command.

This example shows how to create an ACL that permits IP traffic from a source host at 10.1.1.1 to a destination host at 10.1.1.2:

```
Router(config)# access-list 100 permit ip host 10.1.1.1 host 10.1.1.2
```

## Using Class Maps to Define a Traffic Class

You use the **class-map** global configuration command to name and to isolate a specific traffic flow (or class) from all other traffic. A class map defines the criteria to use to match against a specific traffic flow to further classify it. Match statements can include criteria such as CoS value, DSCP value, IP precedence values, or QoS group values, or VLAN IDs. You define match criterion with one or more **match** statements entered in the class-map configuration mode.

Follow these guidelines when configuring class maps:

- A **match-all** class map cannot have more than one classification criterion (one match statement), but a **match-any** class map can contain multiple match statements.
- The **match cos** and **match vlan** commands are supported only on Layer 2 802.1Q trunk ports.
- You use a class map with the **match vlan** command in the parent policy in input hierarchical policy maps for per-port, per-VLAN QoS on trunk ports. A policy is considered a parent policy map when it has one or more of its classes associated with a child policy map. Each class within a parent policy map is called a parent class. You can configure only the **match vlan** command in parent classes. You cannot configure the **match vlan** command in classes within the child policy map.
- You cannot configure **match qos-group** for an input policy map.
- In an output policy map, no two class maps can have the same classification criteria; that is, the same match qualifiers and values.
- The maximum number of class maps supported on the Cisco ASR 901 router is 256.

Complete the following steps to create a class map and to define the match criterion to classify traffic:

	Command	Purpose
Step 1	<b>configure terminal</b>	Enter global configuration mode.
Step 2	<b>class-map</b> [ <b>match-all</b>   <b>match-any</b> ] <i>class-map-name</i>	<p>Create a class map, and enter class-map configuration mode. By default, no class maps are defined.</p> <ul style="list-style-type: none"> <li>• (Optional) Use the <b>match-all</b> keyword to perform a logical-AND of all matching statements under this class map. All match criteria in the class map must be matched.</li> <li>• (Optional) Use the <b>match-any</b> keyword to perform a logical-OR of all matching statements under this class map. One or more match criteria must be matched.</li> <li>• For <i>class-map-name</i>, specify the name of the class map.</li> </ul> <p>If no matching statements are specified, the default is <b>match-all</b>.</p> <p><b>Note</b> A <b>match-all</b> class map cannot have more than one classification criterion (match statement).</p>

	Command	Purpose
Step 3	<b>match</b> { <b>cos</b> <i>cos-list</i>   <b>ip dscp</b> <i>dscp-list</i>   <b>ip precedence</b> <i>ip-precedence-list</i>   <b>qos-group</b> <i>value</i>   <b>vlan</b> <i>vlan-list</i> }	<p>Define the match criterion to classify traffic. By default, no match criterion is defined.</p> <p>Only one match type per class map is supported.</p> <ul style="list-style-type: none"> <li>For <b>cos</b> <i>cos-list</i>, enter a list of up to four CoS values in a single line to match against incoming packets. Separate each value with a space. You can enter multiple <i>cos-list</i> lines to match more than four CoS values. The range is 0 to 7.</li> <li>For <b>ip dscp</b> <i>dscp-list</i>, enter a list of up to eight IPv4 DSCP values to match against incoming packets. Separate each value with a space. You can enter multiple <i>dscp-list</i> lines to match more than eight DSCP values. The numerical range is 0 to 63. You can also configure DSCP values in other forms. See the “<a href="#">Classification Based on IP DSCP</a>” section on page 24-9.</li> <li>For <b>ip precedence</b> <i>ip-precedence-list</i>, enter a list of up to four IPv4 precedence values to match against incoming packets. Separate each value with a space. You can enter multiple <i>ip-precedence-list</i> lines to match more than four precedence values. The range is 0 to 7.</li> <li>For <b>vlan</b> <i>vlan-list</i>, specify a VLAN ID or a range of VLANs to be used in a parent policy map for per-port, per-VLAN QoS on a trunk port. The VLAN ID range is 1 to 4094.</li> <li>For <b>qos-group</b> <i>value</i>, specify the QoS group number. The range is 0 to 7. Matching of QoS groups is supported only in output policy maps.</li> </ul>
Step 4	<b>end</b>	Return to privileged EXEC mode.
Step 5	<b>show class-map</b>	Verify your entries.
Step 6	<b>copy running-config startup-config</b>	(Optional) Save your entries in the configuration file.

This example shows how to create a class map called *class2*, which matches incoming traffic with DSCP values of 10, 11, and 12.

```
Router(config)# class-map match-any class2
Router(config-cmap)# match ip dscp 10 11 12
Router(config-cmap)# exit
```

## Creating a Named Access List

To create a standard or extended named access list, perform the following tasks:

### Restrictions

Extended ACLs with extended options like DSCP, fragments, option, precedence, time-range, ToS, and TTL are not supported. Only ACLs with source and destination IP addresses are supported.

### SUMMARY STEPS

1. **enable**
2. **configure terminal**
3. **ip access-list {standard | extended} name**
4. **permit {source [source-wildcard] | any} log**
5. **exit**
6. **class-map class-map-name**
7. **match access-group name access-group-name**

### DETAILED STEPS

	Command	Purpose
Step 1	<b>enable</b>  <b>Example:</b> Router> enable	Enables privileged EXEC mode. <ul style="list-style-type: none"> <li>• Enter your password if prompted.</li> </ul>
Step 2	<b>configure terminal</b>  <b>Example:</b> Router# configure terminal	Enters global configuration mode.
Step 3	<b>ip access-list {standard   extended} name</b>  <b>Example:</b> Router(config)# ip access-list standard acl-std  or  Router(config)# ip access-list extended acl-std	Define a standard or extended IP access list using a name. <ul style="list-style-type: none"> <li>• <b>standard</b>—Specifies a standard IP access list.</li> <li>• <b>extended</b>—Specifies an extended IP access list.</li> <li>• <b>name</b>—Name of the IP access list or object-group ACL. Names cannot contain a space or quotation mark, and must begin with an alphabetic character to prevent ambiguity with numbered access lists.</li> </ul>



	Command	Purpose
Step 4	<p><b>permit</b> <i>{source [source-wildcard]   any}</i> <b>log</b></p> <p><b>Example:</b>  Router(config-std-nacl)# permit  10.10.10.10 255.255.255.0</p>	<p>Enters access-list configuration mode, and specifies one or more allowed or denied conditions. This determines whether the packet is passed or dropped.</p> <ul style="list-style-type: none"> <li>• <i>source</i>—Number of the network or host from which the packet is sent in a 32-bit quantity in four-part, dotted-decimal format.</li> <li>• <i>source-wildcard</i>—(Optional) Wildcard bits to be applied to the source in four-part, dotted-decimal format. Place ones in the bit positions you want to ignore.</li> <li>• <b>any</b>—Specifies any source or destination host as an abbreviation for the source-addr or destination-addr value and the source-wildcard, or destination-wildcard value of 0.0.0.0 255.255.255.255.</li> <li>• <b>log</b>—Causes an informational logging message about the packet that matches the entry to be sent to the console. (The level of messages logged to the console is controlled by the logging console command.)</li> </ul>
Step 5	<p><b>exit</b></p> <p><b>Example:</b>  Router(config-std-nacl)# exit</p>	<p>Enters global configuration mode.</p>
Step 6	<p><b>class-map</b> <i>class-map-name</i></p> <p><b>Example:</b>  Router(config)# class-map  class-acl-std</p>	<p>Defines name for the class map and enters class-map config mode.</p> <ul style="list-style-type: none"> <li>• <i>class-map-name</i>—Name of the class map.</li> </ul>
Step 7	<p><b>match</b> <i>access-group name</i>  <i>access-group-name</i></p> <p><b>Example:</b>  Router(config-cmap)# match  access-group name acl-std</p>	<p>Defines a named ACL for the match criteria.</p> <ul style="list-style-type: none"> <li>• <i>access-group-name</i>—Specifies a named ACL whose contents are used as the match criteria against which packets are checked to determine if they belong to the same class. The name can be up to 40 alphanumeric characters.</li> </ul>

## What to do Next

After creating a standard access list using names, define a policy map and attach it to the interface. See [Creating a Policy Map for Applying a QoS Feature to Network Traffic, page 24-35](#) and [Attaching the Policy Map to an Interface, page 24-36](#) for more details.

## TCAM with ACL

The scalability of ACLs will change depending on the features configured on the Cisco ASR 901 Router. With on-demand allocation, ACLs can be allocated up to a maximum of 1536 TCAM rules. For more information on troubleshooting scalability, see [Troubleshooting Tips, page 24-81](#).

### Configuration Examples for ACL

The following is a sample output of the `show ip access-lists tcam1` command.

```
Router# show ip access-lists tcam1
!consumes 1 TCAM entry per rule + a default rule.
!4 TCAM entries in this case]
Extended IP access list tcam1
 10 permit ip host 1.1.1.12 any
 20 deny ip host 2.2.2.11 any
 30 permit ip host 1.1.1.13 any
Router#
Router# show run int gig 0/1
Building configuration...

Current configuration : 221 bytes
!
interface GigabitEthernet0/1
 no ip address
 ip access-group tcam1 in
 negotiation auto

Router# show platform tcam detailed

Ingress      : 6/8 slices, 1536/2048 entries used
Pre-Ingress: 3/4 slices, 768/1024 entries used
Egress       : 0/4 slices, 0/512 entries used

Slice ID: 1
Stage: Pre-Ingress
Mode: Single
Entries used: 29/256
Slice allocated to: Layer-2 Classify and Assign Group

Slice ID: 4
Stage: Pre-Ingress
Mode: Double
Entries used: 11/128
Slice allocated to: L2CP

Slice ID: 2
Stage: Ingress
Mode: Double
Entries used: 27/128
Slice allocated to: L2 Post-Switch Processing Group

Slice ID: 5
Stage: Ingress
Mode: Single
Entries used: 4/256
Slice allocated to: Port ACLs

Slice ID: 7
Stage: Ingress
Mode: Double
Entries used: 10/128
```

```

Slice allocated to: OAM, Ethernet loopback, Y.1731 DMM

Slice ID: 3
Stage: Ingress
Mode: Double
Entries used: 15/128
Slice allocated to: CESoPSN-UDP, CEF, Layer-3 Control Protocols

Slice ID: 8
Stage: Ingress
Mode: Double
Entries used: 220/256
Slice allocated to: Quality Of Service

```

## Verifying Named Access List

To verify the standard or extended access list configuration, use the **show access-lists** command as given below:

```

Router# show access-lists tes456

Extended IP access list tes456
 10 permit ip host 10.1.1.1 192.168.1.0 0.0.0.255
 20 permit ip host 10.1.1.1 192.168.2.0 0.0.0.255
 30 permit ip host 10.1.1.1 192.168.3.0 0.0.0.255
 40 permit ip host 10.1.1.1 192.168.4.0 0.0.0.255
 50 permit ip host 10.1.1.1 192.168.5.0 0.0.0.255
 60 permit ip host 10.1.1.1 192.168.6.0 0.0.0.255
 70 permit ip host 10.1.1.1 192.168.7.0 0.0.0.255
 80 permit ip host 10.1.1.1 192.168.8.0 0.0.0.255
 90 permit ip host 10.1.1.1 192.168.9.0 0.0.0.255
!
!
!

```

To verify the ACL-based QoS classification, use the **show policy-map** command as given below:

```

Router# show policy-map interface gigabitethernet 0/0

GigabitEthernet0/0

Service-policy input: test

Class-map: test (match-any)
 0 packets, 244224 bytes
 5 minute offered rate 6000 bps, drop rate 0000 bps
Match: access-group name test
QoS Set
  dscp af32
  Packets marked 0
  No marking statistics available for this class

Class-map: class-default (match-any)
 0 packets, 239168 bytes
 5 minute offered rate 6000 bps, drop rate 0000 bps
Match: any

```

## Configuration Example for Named Access List

The following is the sample configuration of a named access list on the Cisco ASR 901 Router.



### Note

In the following configuration, both the ACL and ACL-based QoS are exclusive of each other and are not related to each other.

```
Router# show running-config

Building configuration...

Current configuration : 11906 bytes
!
! Last configuration change at 22:51:12 UTC Sun May 13 2001
!
version 15.2
service timestamps debug datetime msec
service timestamps log datetime msec
!
hostname Router
!
boot-start-marker
boot-end-marker
!
!
!card type command needed for slot/vwic-slot 0/0
enable password lab
!
no aaa new-model
ip cef
!
!
!
no ipv6 cef
!
!
mpls label protocol ldp
multilink bundle-name authenticated
!
table-map sach
  map from 0 to 0
  map from 1 to 1
  map from 2 to 2
  map from 3 to 3
  map from 4 to 3
  map from 5 to 5
  map from 6 to 6
  map from 7 to 7
  default copy
!
l3-over-12 flush buffers
!
!
!
!
!
!
spanning-tree mode pvst
```

```
spanning-tree extend system-id
username lab password 0 lab
!
!
!
class-map match-any test
  match access-group name test123
class-map match-all test456
  match access-group name tes456
class-map match-any test1
  match access-group name test123
!
policy-map test
  class test456
  class class-default
!
!
!
!
!
!
interface Loopback0
  ip address 10.10.10.1 255.255.255.255
!
interface Port-channel1
  no negotiation auto
!
interface Port-channel8
  no negotiation auto
  service-policy input test
  service instance 2000 ethernet
  encapsulation dot1q 2000
  rewrite ingress tag pop 1 symmetric
  bridge-domain 2000
!
!
interface GigabitEthernet0/0
  no negotiation auto
  service-policy input test
!
interface GigabitEthernet0/1
  shutdown
  no negotiation auto
!
interface GigabitEthernet0/2
  negotiation auto
  channel-group 8 mode active
!
interface GigabitEthernet0/3
  no negotiation auto
!
interface GigabitEthernet0/4
  negotiation auto
  service instance 200 ethernet
  encapsulation untagged
  bridge-domain 200
!
!
interface GigabitEthernet0/5
  negotiation auto
!
interface GigabitEthernet0/6
  no negotiation auto
!
```

```

interface GigabitEthernet0/7
  no negotiation auto
!
interface GigabitEthernet0/8
  negotiation auto
  channel-group 8 mode active
!
interface GigabitEthernet0/9
  no negotiation auto
!
interface GigabitEthernet0/10
  no negotiation auto
!
interface GigabitEthernet0/11
  no negotiation auto
!
interface FastEthernet0/0
  ip address 10.104.99.152 255.255.255.0
  full-duplex
!
interface Vlan1
  no ip address
!
interface Vlan108
  ip address 11.11.11.1 255.255.255.0
  mpls ip
!
interface Vlan200
  ip address 10.1.1.2 255.255.255.0
  mpls ip
!
interface Vlan2000
  ip address 200.1.1.1 255.255.255.0
!
router ospf 1
  router-id 10.10.10.1
  network 10.10.10.1 0.0.0.0 area 0
  network 200.1.1.0 0.0.0.255 area 0
!
router bgp 1
  bgp router-id 10.10.10.1
  bgp log-neighbor-changes
  neighbor 10.1.1.1 remote-as 2
  neighbor 10.10.10.50 remote-as 1
  neighbor 10.10.10.50 update-source Loopback0
!
ip forward-protocol nd
!
!
no ip http server
ip route 0.0.0.0 0.0.0.0 10.104.99.1
!
ip access-list extended check
  deny ip any any
ip access-list extended tes456
  permit ip host 10.1.1.1 192.168.1.0 0.0.0.255
  permit ip host 10.1.1.1 192.168.2.0 0.0.0.255
  permit ip host 10.1.1.1 192.168.3.0 0.0.0.255
  permit ip host 10.1.1.1 192.168.4.0 0.0.0.255
  permit ip host 10.1.1.1 192.168.5.0 0.0.0.255
  permit ip host 10.1.1.1 192.168.6.0 0.0.0.255
  permit ip host 10.1.1.1 192.168.7.0 0.0.0.255
  permit ip host 10.1.1.1 192.168.8.0 0.0.0.255
  permit ip host 10.1.1.1 192.168.9.0 0.0.0.255

```

```
permit ip host 10.1.1.1 192.168.10.0 0.0.0.255
permit ip host 10.1.1.1 192.168.11.0 0.0.0.255
permit ip host 10.1.1.1 192.168.12.0 0.0.0.255
permit ip host 10.1.1.1 192.168.13.0 0.0.0.255
permit ip host 10.1.1.1 192.168.14.0 0.0.0.255
permit ip host 10.1.1.1 192.168.15.0 0.0.0.255
permit ip host 10.1.1.1 192.168.16.0 0.0.0.255
permit ip host 10.1.1.1 192.168.17.0 0.0.0.255
permit ip host 10.1.1.1 192.168.18.0 0.0.0.255
permit ip host 10.1.1.1 192.168.19.0 0.0.0.255
permit ip host 10.1.1.1 192.168.20.0 0.0.0.255
permit ip host 10.1.1.1 192.168.21.0 0.0.0.255
permit ip host 10.1.1.1 192.168.22.0 0.0.0.255
permit ip host 10.1.1.1 192.168.23.0 0.0.0.255
permit ip host 10.1.1.1 192.168.24.0 0.0.0.255
permit ip host 10.1.1.1 192.168.25.0 0.0.0.255
permit ip host 10.1.1.1 192.168.26.0 0.0.0.255
permit ip host 10.1.1.1 192.168.27.0 0.0.0.255
permit ip host 10.1.1.1 192.168.28.0 0.0.0.255
permit ip host 10.1.1.1 192.168.29.0 0.0.0.255
permit ip host 10.1.1.1 192.168.30.0 0.0.0.255
permit ip host 10.1.1.1 192.168.31.0 0.0.0.255
permit ip host 10.1.1.1 192.168.32.0 0.0.0.255
permit ip host 10.1.1.1 192.168.33.0 0.0.0.255
permit ip host 10.1.1.1 192.168.34.0 0.0.0.255
permit ip host 10.1.1.1 192.168.35.0 0.0.0.255
permit ip host 10.1.1.1 192.168.36.0 0.0.0.255
permit ip host 10.1.1.1 192.168.37.0 0.0.0.255
permit ip host 10.1.1.1 192.168.38.0 0.0.0.255
permit ip host 10.1.1.1 192.168.40.0 0.0.0.255
permit ip host 10.1.1.1 192.168.41.0 0.0.0.255
permit ip host 10.1.1.1 192.168.42.0 0.0.0.255
permit ip host 10.1.1.1 192.168.43.0 0.0.0.255
permit ip host 10.1.1.1 192.168.44.0 0.0.0.255
permit ip host 10.1.1.1 192.168.45.0 0.0.0.255
permit ip host 10.1.1.1 192.168.46.0 0.0.0.255
permit ip host 10.1.1.1 192.168.47.0 0.0.0.255
permit ip host 10.1.1.1 192.168.48.0 0.0.0.255
permit ip host 10.1.1.1 192.168.49.0 0.0.0.255
permit ip host 10.1.1.1 192.168.50.0 0.0.0.255
permit ip host 10.1.1.1 192.168.51.0 0.0.0.255
permit ip host 10.1.1.1 192.168.52.0 0.0.0.255
permit ip host 10.1.1.1 192.168.53.0 0.0.0.255
permit ip host 10.1.1.1 192.168.54.0 0.0.0.255
permit ip host 10.1.1.1 192.168.55.0 0.0.0.255
permit ip host 10.1.1.1 192.168.56.0 0.0.0.255
permit ip host 10.1.1.1 192.168.57.0 0.0.0.255
permit ip host 10.1.1.1 192.168.58.0 0.0.0.255
permit ip host 10.1.1.1 192.168.59.0 0.0.0.255
permit ip host 10.1.1.1 192.168.60.0 0.0.0.255
permit ip host 10.1.1.1 192.168.61.0 0.0.0.255
permit ip host 10.1.1.1 192.168.62.0 0.0.0.255
permit ip host 10.1.1.1 192.168.63.0 0.0.0.255
permit ip host 10.1.1.1 192.168.64.0 0.0.0.255
permit ip host 10.1.1.1 192.168.65.0 0.0.0.255
permit ip host 10.1.1.1 192.168.66.0 0.0.0.255
permit ip host 10.1.1.1 192.168.67.0 0.0.0.255
permit ip host 10.1.1.1 192.168.68.0 0.0.0.255
permit ip host 10.1.1.1 192.168.69.0 0.0.0.255
permit ip host 10.1.1.1 192.168.70.0 0.0.0.255
permit ip host 10.1.1.1 192.168.71.0 0.0.0.255
permit ip host 10.1.1.1 192.168.72.0 0.0.0.255
permit ip host 10.1.1.1 192.168.73.0 0.0.0.255
permit ip host 10.1.1.1 192.168.74.0 0.0.0.255
```

```
permit ip host 10.1.1.1 192.168.75.0 0.0.0.255
ip access-list extended test123
remark 1
permit ip host 10.1.1.1 192.168.1.0 0.0.0.255
remark 2
permit ip host 10.1.1.1 192.168.2.0 0.0.0.255
remark 3
permit ip host 10.1.1.1 192.168.3.0 0.0.0.255
remark 4
permit ip host 10.1.1.1 192.168.4.0 0.0.0.255
remark 5
permit ip host 10.1.1.1 192.168.5.0 0.0.0.255
remark 6
permit ip host 10.1.1.1 192.168.6.0 0.0.0.255
remark 7
permit ip host 10.1.1.1 192.168.7.0 0.0.0.255
remark 8
permit ip host 10.1.1.1 192.168.8.0 0.0.0.255
remark 9
permit ip host 10.1.1.1 192.168.9.0 0.0.0.255
remark 10
permit ip host 10.1.1.1 192.168.10.0 0.0.0.255
remark 11
permit ip host 10.1.1.1 192.168.11.0 0.0.0.255
remark 12
permit ip host 10.1.1.1 192.168.12.0 0.0.0.255
remark 13
permit ip host 10.1.1.1 192.168.13.0 0.0.0.255
remark 14
permit ip host 10.1.1.1 192.168.14.0 0.0.0.255
remark 15
permit ip host 10.1.1.1 192.168.15.0 0.0.0.255
remark 16
permit ip host 10.1.1.1 192.168.16.0 0.0.0.255
remark 17
permit ip host 10.1.1.1 192.168.17.0 0.0.0.255
remark 18
permit ip host 10.1.1.1 192.168.18.0 0.0.0.255
remark 19
permit ip host 10.1.1.1 192.168.19.0 0.0.0.255
remark 20
permit ip host 10.1.1.1 192.168.20.0 0.0.0.255
remark 21
permit ip host 10.1.1.1 192.168.21.0 0.0.0.255
remark 22
permit ip host 10.1.1.1 192.168.22.0 0.0.0.255
remark 23
permit ip host 10.1.1.1 192.168.23.0 0.0.0.255
remark 24
permit ip host 10.1.1.1 192.168.24.0 0.0.0.255
remark 25
permit ip host 10.1.1.1 192.168.25.0 0.0.0.255
remark 26
permit ip host 10.1.1.1 192.168.26.0 0.0.0.255
remark 27
permit ip host 10.1.1.1 192.168.27.0 0.0.0.255
remark 28
permit ip host 10.1.1.1 192.168.28.0 0.0.0.255
remark 29
permit ip host 10.1.1.1 192.168.29.0 0.0.0.255
remark 30
permit ip host 10.1.1.1 192.168.30.0 0.0.0.255
remark 31
permit ip host 10.1.1.1 192.168.31.0 0.0.0.255
```



```
remark 32
permit ip host 10.1.1.1 192.168.32.0 0.0.0.255
remark 33
permit ip host 10.1.1.1 192.168.33.0 0.0.0.255
remark 34
permit ip host 10.1.1.1 192.168.34.0 0.0.0.255
remark 35
permit ip host 10.1.1.1 192.168.35.0 0.0.0.255
remark 36
permit ip host 10.1.1.1 192.168.36.0 0.0.0.255
remark 37
permit ip host 10.1.1.1 192.168.37.0 0.0.0.255
remark 38
permit ip host 10.1.1.1 192.168.38.0 0.0.0.255
remark 39
permit ip host 10.1.1.1 192.168.39.0 0.0.0.255
remark 40
permit ip host 10.1.1.1 192.168.40.0 0.0.0.255
remark 41
permit ip host 10.1.1.1 192.168.41.0 0.0.0.255
remark 42
permit ip host 10.1.1.1 192.168.42.0 0.0.0.255
remark 43
permit ip host 10.1.1.1 192.168.43.0 0.0.0.255
remark 44
permit ip host 10.1.1.1 192.168.44.0 0.0.0.255
remark 45
permit ip host 10.1.1.1 192.168.45.0 0.0.0.255
remark 46
permit ip host 10.1.1.1 192.168.46.0 0.0.0.255
remark 47
permit ip host 10.1.1.1 192.168.47.0 0.0.0.255
remark 48
permit ip host 10.1.1.1 192.168.48.0 0.0.0.255
remark 49
permit ip host 10.1.1.1 192.168.49.0 0.0.0.255
remark 50
permit ip host 10.1.1.1 192.168.50.0 0.0.0.255
!
access-list 2600 permit ip any any
!
mpls ldp router-id Loopback0
!
!
control-plane
!
environment monitor
!
line con 0
line aux 0
  transport preferred none
  transport output lat pad telnet rlogin udptn ssh
line vty 0 4
  exec-timeout 3 3
  password lab
  login
!
exception crashinfo buffersize 128
!
!
end
```

# QoS Treatment for Performance-Monitoring Protocols

This section contains the following topics:

- [Cisco IP-SLAs, page 24-62](#)
- [QoS Treatment for IP-SLA Probes, page 24-62](#)
- [QoS Marking for CPU-Generated Traffic, page 24-62](#)
- [QoS Queuing for CPU-Generated Traffic, page 24-63](#)
- [Configuration Guidelines, page 24-80](#)

## Cisco IP-SLAs

For information about Cisco IP service level agreements (IP-SLAs), see [Understanding Cisco IOS IP SLAs, page 3-2](#).

## QoS Treatment for IP-SLA Probes

The QoS treatment for IP-SLA and TWAMP probes must exactly reflect the effects that occur to the normal data traffic crossing the device.

The generating device should not change the probe markings. It should queue these probes based on the configured queueing policies for normal traffic.

## Marking

By default, the class of service (CoS) marking of CFM traffic (including IP SLAs using CFM probes) is not changed. This feature cannot change this behavior.

By default, IP traffic marking (including IP SLA and TWAMP probes) is not changed. This feature can change this behavior.

## Queuing

The CFM traffic (including IP SLAs using CFM probes) is queued according to its CoS value and the output policy map configured on the egress port, similar to normal traffic. This feature cannot change this behavior.

IP traffic (including IP SLA and TWAMP probes) is queued according to the markings specified in the **cpu traffic qos** global configuration command and the output policy map on the egress port. If this command is not configured, all IP traffic is statically mapped to a queue on the egress port.

## QoS Marking for CPU-Generated Traffic

You can use QoS marking to set or modify the attributes of traffic from the CPU. The QoS marking action can cause the CoS, DSCP, or IP precedence bits in the packet to be rewritten or left unchanged. QoS uses packet markings to identify certain traffic types and how to treat them on the local router and the network.

You can also use marking to assign traffic to a QoS group within the router. This QoS group is an internal label that does not modify the packet, but it can be used to identify the traffic type when configuring egress queuing on the network port.

You can specify and mark traffic CPU-generated traffic by using these global configuration commands:

```
cpu traffic qos cos { cos_value | cos [table-map table-map-name] | dscp [table-map table-map-name] | precedence [table-map table-map-name] }
```

You can mark a QoS group by configuring an explicit value or by using the **table-map** keyword. Table maps list specific traffic attributes and map (or convert) them to another attribute. A table map establishes a to-from relationship for the attribute and defines the change to be made:

- Marking CoS by using the CoS, or the IP-DSCP, or the IP precedence of IP CPU-packets
- Marking CoS by using the CoS of non-IP CPU-packets.
- Marking IP DSCP by using the CoS, or the IP-DSCP, or the IP precedence of the CPU-packet
- Marking IP precedence by using the CoS, or the IP-DSCP, or the IP precedence of the CPU-packet

You can configure either IP-DSCP or IP precedence marking.

You can also simultaneously configure marking actions to modify CoS, IP-DSCP or IP precedence, and QoS group.

The **cpu traffic qos** command specifies the traffic to which it applies: all CPU traffic, only CPU IP traffic, or only CPU non-IP traffic. All other traffic retains its QoS markings. This feature does not affect CFM traffic (including Layer 2 IP SLA probes using CFM).

## QoS Queuing for CPU-Generated Traffic

You can use the QoS markings established for the CPU-generated traffic by the **cpu traffic qos** global configuration command as packet identifiers in the class-map of an output policy-map to map CPU traffic to class-queues in the output policy-map on the egress port. You can then use output policy-maps on the egress port to configure queuing and scheduling for traffic leaving the router from that port.

If you want to map *all* CPU-generated traffic to a single class in the output policy-maps without changing the CoS, IP DSCP, or IP-precedence packet markings, you can use QoS groups for marking CPU-generated traffic.

If you want to map *all* CPU-generated traffic to classes in the output policy maps based on the CoS without changing the CoS packet markings, you can use the table map:

- Configure CoS marking by using **CoS** as the **map from** value *without* a table map.
- Configure CoS marking using **CoS** as the **map from** value *with* a table map, using only the **default** and **copy** keywords.

For details about table maps, see the [“Table Maps” section on page 24-13](#).

Using the **cpu traffic qos** global configuration command with table mapping, you can configure multiple marking and queuing policies to work together or independently. You can queue native VLAN traffic based on the CoS markings configured using the **cpu traffic qos** global configuration command.

The **cpu traffic qos** command specifies the traffic to which it applies: all CPU traffic, only CPU-IP traffic, or only CPU non-IP traffic. All other traffic is statically mapped to a CPU-default queue on the egress port. All CFM traffic (including Layer 2 IP SLA probes using CFM) is mapped to classes in the output policy map, and queued based on their CoS value.

## Extending QoS for MLPPP

- [Configuring Class-map for Matching MPLS EXP Bits, page 24-64](#)
- [Configuring Class-map for Matching IP DSCP Value, page 24-65](#)
- [Configuring Class-map for Matching MPLS EXP Bits or IP DSCP Value, page 24-66](#)
- [Configuring a Policy-map, page 24-67](#)
- [Attaching the Policy-map to MLPPP Interface, page 24-70](#)
- [Re-marking IP DSCP Values of CPU Generated Traffic, page 24-72](#)
- [Re-marking MPLS EXP Values of CPU Generated Traffic, page 24-73](#)
- [Configuring a Policy-map to Match on CS5 and EXP4, page 24-74](#)
- [Attaching the Policy-map to Match on CS5 and EXP4 to MLPPP Interface, page 24-76](#)

## Configuring Class-map for Matching MPLS EXP Bits

Complete the following steps to configure class-map for matching MPLS experimental bits.

### SUMMARY STEPS

1. **enable**
2. **configure terminal**
3. **class-map match-any *class-map-name***
4. **match mpls experimental topmost *number***
5. **exit**

### DETAILED STEPS

	Command	Purpose
Step 1	<b>enable</b>  <b>Example:</b> Router> enable	Enables privileged EXEC mode. <ul style="list-style-type: none"> <li>• Enter your password if prompted.</li> </ul>
Step 2	<b>configure terminal</b>  <b>Example:</b> Router# configure terminal	Enters global configuration mode.
Step 3	<b>class-map match-any <i>class-map-name</i></b>  <b>Example:</b> Router(config)# class-map match-any mplsexp	Creates a class map to be used for matching packets to a specified class and to enter QoS class-map configuration mode: <ul style="list-style-type: none"> <li>• <i>class-map-name</i>—Name of the class for the class map. The class name is used for both the class map and to configure a policy for the class in the policy map.</li> </ul>

	Command	Purpose
Step 4	<b>match mpls experimental topmost</b> <i>number</i>  <b>Example:</b> Router(config-cmap)# match mpls experimental topmost 5	Matches the experimental (EXP) value in the topmost label header. <ul style="list-style-type: none"> <li><i>number</i>—Multiprotocol Label Switching (MPLS) EXP field in the topmost label header. Valid values are 0 to 7.</li> </ul> <b>Note</b> In this configuration packets with experimental bits of value 5 are matched. Repeat this step to configure more values. If any one of the values is matched, action pertaining to the class-map is performed.
Step 5	<b>exit</b>  <b>Example:</b> Router(config-cmap)# exit	Exits class-map configuration mode.

## Configuring Class-map for Matching IP DSCP Value

This classification is required for all the packets flowing without an MPLS header like normal IP packets flowing through an MLPPP Interface.

Complete the following steps to configure class-map for matching IP DSCP Values.

### SUMMARY STEPS

1. **enable**
2. **configure terminal**
3. **class-map match-any** *class-map-name*
4. **match ip dscp** [*dscp-value...dscp-value*]
5. **exit**

### DETAILED STEPS

	Command	Purpose
Step 1	<b>enable</b>  <b>Example:</b> Router> enable	Enables privileged EXEC mode. <ul style="list-style-type: none"> <li>Enter your password if prompted.</li> </ul>
Step 2	<b>configure terminal</b>  <b>Example:</b> Router# configure terminal	Enters global configuration mode.
Step 3	<b>class-map match-any</b> <i>class-map-name</i>  <b>Example:</b> Router(config)# class-map match-any matchdscp	Creates a class map to be used for matching packets to a specified class and to enter QoS class-map configuration mode: <ul style="list-style-type: none"> <li><i>class-map-name</i>—Name of the class for the class map. The class name is used for both the class map and to configure a policy for the class in the policy map.</li> </ul>

	Command	Purpose
Step 4	<b>match ip dscp</b> [ <i>dscp-value...dscp-value</i> ]  <b>Example:</b> Router(config-cmap)# match ip dscp af11	Identify one or more differentiated service code point (DSCP), Assured Forwarding (AF), and Class Selector (CS) values as a match criterion. <ul style="list-style-type: none"> <li><i>dscp-value</i>—The DSCP value used to identify a DSCP value.</li> </ul> <b>Note</b> In this configuration packets with IP DSCP of value af11 are matched. Repeat this step to configure more values. If any one of the values is matched, action pertaining to the class-map is performed.
Step 5	<b>exit</b>  <b>Example:</b> Router(config-cmap)# exit	Exits class-map configuration mode.

## Configuring Class-map for Matching MPLS EXP Bits or IP DSCP Value

In this configuration, all MPLS packets flowing through the MLPPP Interface EXP value are matched and all the IP Packets flowing through the MLPPP Interface IP DSCP value are matched.

Complete the following steps to configure class-map for matching MPLS EXP bits or IP DSCP Values.

### SUMMARY STEPS

1. **enable**
2. **configure terminal**
3. **class-map match-any *class-map-name***
4. **match mpls experimental topmost *number***
5. **match ip dscp [*dscp-value...dscp-value*]**
6. **exit**

### DETAILED STEPS

	Command	Purpose
Step 1	<b>enable</b>  <b>Example:</b> Router> enable	Enables privileged EXEC mode. <ul style="list-style-type: none"> <li>Enter your password if prompted.</li> </ul>
Step 2	<b>configure terminal</b>  <b>Example:</b> Router# configure terminal	Enters global configuration mode.

	Command	Purpose
Step 3	<b>class-map match-any</b> <i>class-map-name</i>  <b>Example:</b> Router(config)# class-map match-any matchdscp	Creates a class map to be used for matching packets to a specified class and to enter QoS class-map configuration mode: <ul style="list-style-type: none"> <li><i>class-map-name</i>—Name of the class for the class map. The class name is used for both the class map and to configure a policy for the class in the policy map.</li> </ul>
Step 4	<b>match mpls experimental topmost</b> <i>number</i>  <b>Example:</b> Router(config-cmap)# match mpls experimental topmost 5	Matches the experimental (EXP) value in the topmost label header. <ul style="list-style-type: none"> <li><i>number</i>—Multiprotocol Label Switching (MPLS) EXP field in the topmost label header. Valid values are 0 to 7.</li> </ul>
Step 5	<b>match ip dscp</b> <i>dscp-value</i>  <b>Example:</b> Router(config-cmap)# match ip dscp af11	Identifies the DSCP values as a match criterion. <ul style="list-style-type: none"> <li><i>dscp-value</i>—The DSCP value used to identify a DSCP.</li> </ul>
Step 6	<b>exit</b>  <b>Example:</b> Router(config-cmap)# exit	Exits class-map configuration mode.

## Configuring a Policy-map

Complete the following steps to configure a policy-map.

### SUMMARY STEPS

1. **enable**
2. **configure terminal**
3. **policy-map** *policy-map-name*
4. **class** *class-name*
5. **priority percent** *priority-percent* -
6. **class** *class-name*
7. **bandwidth percent** *bandwidth-percent*
8. **class** *class-name*
9. **set mpls experminetal topmost** *number*
10. **class** *class-name*
11. **set ip dscp** *dscp-value*
12. **class** *class-name*
13. **bandwidth percent** *bandwidth-percent*

14. **set mpls experimetal topmost** *number*
15. **set ip dscp** *value*
16. **queue-limit** *queue-limit-size* **packets**
17. **class** *class-default*
18. **bandwidth percent** *bandwidth-percent*
19. **exit**

## DETAILED STEPS

	Command	Purpose
Step 1	<b>enable</b>  <b>Example:</b> Router> enable	Enables privileged EXEC mode. <ul style="list-style-type: none"> <li>Enter your password if prompted.</li> </ul>
Step 2	<b>configure terminal</b>  <b>Example:</b> Router# configure terminal	Enters global configuration mode.
Step 3	<b>policy-map</b> <i>policy-map-name</i>  <b>Example:</b> Router(config)# policy-map mplsomlpppgos	Configures a policy map that can be attached to one or more interfaces and enters QoS policy-map configuration mode. <ul style="list-style-type: none"> <li><i>policy-map-name</i>—Name of the policy map.</li> </ul>
Step 4	<b>class</b> <i>class-name</i>  <b>Example:</b> Router(config-pmap)# class mplsexp	Specifies the name of the class whose policy you want to create. <ul style="list-style-type: none"> <li><i>class-name</i>—Name of the class to be configured or whose policy is to be modified. The class name is used for both the class map and to configure a policy for the class in the policy map.</li> </ul>
Step 5	<b>priority percent</b> <i>percentage</i>  <b>Example:</b> Router(config-pmap-c)# priority percent 10	Configures priority to a class of traffic belonging to a policy map. <ul style="list-style-type: none"> <li><i>percentage</i>—Total available bandwidth to be set aside for the priority class.</li> </ul>
Step 6	<b>class</b> <i>class-name</i>  <b>Example:</b> Router(config-pmap-c)# class matchdscp	Specifies the name of the class whose policy you want to create.
Step 7	<b>bandwidth percent</b> <i>percentage</i>  <b>Example:</b> Router(config-pmap-c)# bandwidth percent 20	Configures the bandwidth allocated for a class belonging to a policy map. <ul style="list-style-type: none"> <li><i>percentage</i>—Specifies the percentage of guaranteed bandwidth based on an absolute percent of available bandwidth to be set aside for the priority class or on a relative percent of available bandwidth.</li> </ul>



	Command	Purpose
Step 8	<b>class</b> <i>class-name</i>  <b>Example:</b> Router(config-pmap-c)# class mplsexpvalues	Specifies the name of the class whose policy you want to create.
Step 9	<b>set mpls experimental topmost</b> <i>mpls-exp-value</i>  <b>Example:</b> Router(config-pmap-c)# set mpls experimental topmost 4	Sets the MPLS EXP field value in the topmost label on an interface. <ul style="list-style-type: none"> <li><i>mpls-exp-value</i>—Specifies the value used to set MPLS experimental bits defined by the policy map.</li> </ul>
Step 10	<b>class</b> <i>class-name</i>  <b>Example:</b> Router(config-pmap-c)# class matchdscpvalues	Specifies the name of the class whose policy you want to create.
Step 11	<b>set dscp</b> <i>dscp-value</i>  <b>Example:</b> Router(config-pmap-c)# set dscp af41	Marks a packet by setting the differentiated services code point (DSCP) value in the type of service (ToS) byte. <ul style="list-style-type: none"> <li><i>dscp-value</i>—The DSCP value used to identify a DSCP.</li> </ul>
Step 12	<b>class</b> <i>class-name</i>  <b>Example:</b> Router(config-pmap-c)# class mplsexp_or_dscp	Specifies the name of the class whose policy you want to create.
Step 13	<b>bandwidth percent</b> <i>percentage</i>  <b>Example:</b> Router(config-pmap-c)# bandwidth percent 20	Configures the bandwidth allocated for a class belonging to a policy map.
Step 14	<b>set mpls experimental topmost</b> <i>mpls-exp-value</i>  <b>Example:</b> Router(config-pmap-c)# set mpls experimental topmost 1	Sets the MPLS EXP field value in the topmost label on an interface.
Step 15	<b>set dscp</b> <i>dscp-value</i>  <b>Example:</b> Router(config-pmap-c)# set dscp af11	Marks a packet by setting the differentiated services code point (DSCP) value in the type of service (ToS) byte.

	Command	Purpose
Step 16	<b>queue</b> <i>queue-limit-size</i> <b>packets</b>  <b>Example:</b> Router(config-pmap-c)# queue-limit 80 packets	Configures the queue limit (size) for a class in packets. <ul style="list-style-type: none"> <li>• <i>number</i>—The maximum size of the queue.</li> <li>• <b>packets</b>—Indicates that the unit of measure is packets.</li> </ul> <b>Note</b> To configure <b>queue-limit</b> , you should configure either priority percent or bandwidth percent.
Step 17	<b>end</b>  <b>Example:</b> Router(config-pmap-c)# exit	Exits QoS policy-map class configuration mode.

## Attaching the Policy-map to MLPPP Interface

Complete the following steps to attach the policy-map to an MLPPP interface.

### SUMMARY STEPS

1. **enable**
2. **configure terminal**
3. **interface multilink** *group-number*
4. **ip address** *address* [*subnet mask*]
5. **load-interval** *interval*
6. **mpls ip**
7. **keepalive** *period*
8. **ppp multilink**
9. **ppp multilink group** *number*
10. **ppp multilink endpoint string** *char-string*
11. **service-policy output** *policy-map-name*
12. **exit**

## DETAILED STEPS

	Command	Purpose
Step 1	<b>enable</b>  <b>Example:</b> Router> enable	Enables privileged EXEC mode. <ul style="list-style-type: none"> <li>Enter your password if prompted.</li> </ul>
Step 2	<b>configure terminal</b>  <b>Example:</b> Router# configure terminal	Enters global configuration mode.
Step 3	<b>interface multilink</b> <i>group-number</i>  <b>Example:</b> Router(config)# interface multilink5	Creates a multilink bundle and enters the interface configuration mode: <ul style="list-style-type: none"> <li><i>group-number</i>—Number of the multilink bundle.</li> </ul>
Step 4	<b>ip address</b> <i>address [subnet mask]</i>  <b>Example:</b> Router(config-if)# ip address 84.1.2.3 255.255.255.0	Assigns an IP address to the multilink interface. <ul style="list-style-type: none"> <li><i>address</i>— IP address.</li> <li><i>subnet mask</i>—Network mask of IP address.</li> </ul>
Step 5	<b>load-interval</b> <i>interval</i>  <b>Example:</b> Router(config-if)# load-interval 30	Configures the length of time for which data is used to compute load statistics. <ul style="list-style-type: none"> <li><i>interval</i>—Length of time for which data is used to compute load statistics.</li> </ul>
Step 6	<b>mpls ip</b>  <b>Example:</b> Router(config-if)# mpls ip	Enables MPLS forwarding of IPv4 packets along normally routed paths for a particular interfaces.
Step 7	<b>keepalive</b> <i>period</i>  <b>Example:</b> Router(config-if)# keepalive 1	Enables keepalive packets and specifies the number of times that the router tries to send keepalive packets without a response before bringing down the interface. <ul style="list-style-type: none"> <li><i>period</i>—Time interval, in seconds, between messages sent by the router to ensure that a network interface is alive.</li> </ul>
Step 8	<b>ppp multilink</b>  <b>Example:</b> Router(config-if)# ppp multilink	Enables Multilink PPP (MLP) on an interface.
Step 9	<b>ppp multilink group</b> <i>group-number</i>  <b>Example:</b> Router(config-if)# ppp multilink group 3	Restricts a physical link to join only one designated multilink group interface. <ul style="list-style-type: none"> <li><i>group-number</i>—Multilink group number (a nonzero number).</li> </ul>

	Command	Purpose
Step 10	<b>ppp multilink endpoint string</b> <i>char-string</i>  <b>Example:</b> Router(config-if)# ppp multilink endpoint string ML3	Configures the default endpoint discriminator the system uses when negotiating the use of MLPPP with the peer. <ul style="list-style-type: none"> <li><i>char-string</i>—Uses the supplied character string.</li> </ul>
Step 11	<b>service-policy output</b> <i>policy-map-name</i>  <b>Example:</b> Router(config-if)# service-policy output mplsomlpppqos	Attaches a policy map to an interface that will be used as the service policy for the interface. <ul style="list-style-type: none"> <li><i>policy-map-name</i>—The name of a service policy map (created using the <b>policy-map</b> command) to be attached.</li> </ul>
Step 12	<b>exit</b>  <b>Example:</b> Router(config-if)# exit	Exits interface configuration mode.

## Re-marking IP DSCP Values of CPU Generated Traffic

Complete the following steps to re-mark the IP DSCP values of the CPU generated traffic.

### SUMMARY STEPS

1. **enable**
2. **configure terminal**
3. **cpu traffic ppp set ip dscp cs5**
4. **exit**

### DETAILED STEPS

	Command	Purpose
Step 1	<b>enable</b>  <b>Example:</b> Router> enable	Enables privileged EXEC mode. <ul style="list-style-type: none"> <li>Enter your password if prompted.</li> </ul>
Step 2	<b>configure terminal</b>  <b>Example:</b> Router# configure terminal	Enters global configuration mode.

	Command	Purpose
Step 3	<code>cpu traffic ppp set ip dscp cs5</code>  <b>Example:</b> Router(config)# <code>cpu traffic ppp set ip dscp cs5</code>	Re-marks the IP DSCP value to give the desired QoS treatment to CPU generated traffic.
Step 4	<code>exit</code>  <b>Example:</b> Router(config)# <code>exit</code>	Exits configuration mode.

## Re-marking MPLS EXP Values of CPU Generated Traffic

Complete the following steps to re-mark the MPLS EXP values of the CPU generated traffic.

### SUMMARY STEPS

1. `enable`
2. `configure terminal`
3. `cpu traffic ppp set mpls experimental topmost number`
4. `exit`

### DETAILED STEPS

	Command	Purpose
Step 1	<code>enable</code>  <b>Example:</b> Router> <code>enable</code>	Enables privileged EXEC mode. <ul style="list-style-type: none"> <li>• Enter your password if prompted.</li> </ul>
Step 2	<code>configure terminal</code>  <b>Example:</b> Router# <code>configure terminal</code>	Enters global configuration mode.
Step 3	<code>cpu traffic ppp set mpls experimental topmost number</code>  <b>Example:</b> Router(config)# <code>cpu traffic ppp set mpls experimental topmost 4</code>	Re-marks Multiprotocol Label Switching (MPLS) experimental (EXP) topmost value to give the desired QoS treatment to CPU generated traffic. <ul style="list-style-type: none"> <li>• <i>number</i>—MPLS EXP field in the topmost label header. Valid values are 0 to 7.</li> </ul>
Step 4	<code>exit</code>  <b>Example:</b> Router(config)# <code>exit</code>	Exits configuration mode.

## Configuring a Policy-map to Match on CS5 and EXP4

Complete the following steps to configure a policy-map to match on CS5 and EXP4.

### SUMMARY STEPS

1. **enable**
2. **configure terminal**
3. **class-map match-any** *class-map-name*
4. **match ip dscp** *cs-value*
5. **class-map match-any** **exp4**
6. **match mpls experimental topmost** *number*
7. **policy-map** *policy-map-name*
8. **class** *class-name*
9. **bandwidth percent** *bandwidth-percent*
10. **set ip dscp** *dscp-value*
11. **class** *class-name*
12. **bandwidth percent** *bandwidth-percent*
13. **set mpls experminetal topmost** *number*
14. **class** *class-name*
15. **bandwidth percent** *bandwidth-percent*
16. **exit**

### DETAILED STEPS

	Command	Purpose
Step 1	<b>enable</b>  <b>Example:</b> Router> enable	Enables privileged EXEC mode. <ul style="list-style-type: none"> <li>• Enter your password if prompted.</li> </ul>
Step 2	<b>configure terminal</b>  <b>Example:</b> Router# configure terminal	Enters global configuration mode.
Step 3	<b>class-map match-any dscp</b> <i>cs-value</i>  <b>Example:</b> Router(config)# class-map match-any dscpcs5	Configures a class map to be used for matching packets to a specified class and enters QoS class-map configuration mode. <ul style="list-style-type: none"> <li>• <i>class-map-name</i>—The name used for class map.</li> </ul>

	Command	Purpose
Step 4	<p><b>match ip dscp</b> <i>cs-value</i></p> <p><b>Example:</b> Router(config-cmap)# match ip dscp cs5</p>	<p>Identify one or more differentiated service code point (DSCP) CS value as a match criterion.</p> <ul style="list-style-type: none"> <li><i>cs-value</i>—The Class Selector(CS) value.</li> </ul>
Step 5	<p><b>class-map match-any</b> <i>class-map-name</i></p> <p><b>Example:</b> Router(config-cmap)# class-map match-any exp4</p>	<p>Creates a class map to be used for matching packets to a specified class.</p> <ul style="list-style-type: none"> <li><i>class-map-name</i>—Name of the class for the class map.</li> </ul>
Step 6	<p><b>match mpls experimental topmost</b> <i>number</i></p> <p><b>Example:</b> Router(config-cmap)# match mpls experimental topmost 4</p>	<p>Matches the experimental (EXP) value in the topmost label header.</p> <ul style="list-style-type: none"> <li><i>number</i>—Multiprotocol Label Switching (MPLS) EXP field in the topmost label header. Valid values are 0 to 7.</li> </ul>
Step 7	<p><b>policy-map</b> <i>policy-map-name</i></p> <p><b>Example:</b> Router(config-cmap)# policy-map dscp_exp</p>	<p>Configures a policy map that can be attached to one or more interfaces and enters QoS policy-map configuration mode.</p> <ul style="list-style-type: none"> <li><i>policy-map-name</i>—Name of the policy map.</li> </ul>
Step 8	<p><b>class</b> <i>class-name</i></p> <p><b>Example:</b> Router(config-pmap)# class dscpcs5</p>	<p>Specifies the name of the class whose policy you want to create.</p> <ul style="list-style-type: none"> <li><i>class-name</i>—Name of the class to be configured or whose policy is to be modified. The class name is used for both the class map and to configure a policy for the class in the policy map.</li> </ul>
Step 9	<p><b>bandwidth percent</b> <i>percentage</i></p> <p><b>Example:</b> Router(config-pmap-c)# bandwidth percent 20</p>	<p>Configures the bandwidth allocated for a class belonging to a policy map.</p> <ul style="list-style-type: none"> <li><i>percentage</i>—Specifies the percentage of guaranteed bandwidth based on an absolute percent of available bandwidth to be set aside for the priority class or on a relative percent of available bandwidth.</li> </ul>
Step 10	<p><b>set ip dscp</b> <i>cs-value</i></p> <p><b>Example:</b> Router(config-pmap-c)# set ip dscp cs6</p>	<p>Marks a packet by setting the differentiated services code point (DSCP) value in the type of service (ToS) byte.</p>
Step 11	<p><b>class</b> <i>class-name</i></p> <p><b>Example:</b> Router(config-pmap-c)# class exp4</p>	<p>Specifies the name of the class whose policy you want to create.</p>
Step 12	<p><b>bandwidth percent</b> <i>percentage</i></p> <p><b>Example:</b> Router(config-pmap-c)# bandwidth percent 20</p>	<p>Configures the bandwidth allocated for a class belonging to a policy map.</p> <ul style="list-style-type: none"> <li><i>percentage</i>—Specifies the percentage of guaranteed bandwidth based on an absolute percent of available bandwidth to be set aside for the priority class or on a relative percent of available bandwidth.</li> </ul>

	Command	Purpose
Step 13	<pre>set mpls experimental topmost mpls-exp-value</pre> <p><b>Example:</b> Router(config-pmap-c)# set mpls experimental topmost 6</p>	<p>Sets the MPLS EXP field value in the topmost label on an interface.</p> <ul style="list-style-type: none"> <li><i>mpls-exp-value</i>—Specifies the value used to set MPLS experimental bits defined by the policy map.</li> </ul>
Step 14	<pre>class class-name</pre> <p><b>Example:</b> Router(config-pmap-c)# class class-default</p>	<p>Specifies the name of the class whose policy you want to create.</p>
Step 15	<pre>bandwidth percent percentage</pre> <p><b>Example:</b> Router(config-pmap-c)# bandwidth percent 20</p>	<p>Configures the bandwidth allocated for a class belonging to a policy map.</p>
Step 16	<pre>end</pre> <p><b>Example:</b> Router(config-pmap-c)# exit</p>	<p>Exits QoS policy-map class configuration mode.</p>

## Attaching the Policy-map to Match on CS5 and EXP4 to MLPPP Interface

See “Attaching the Policy-map to MLPPP Interface” section on page 24-78 for configuration steps.



### Note

DSCP CS6 and EXP 6 are default values. If you configure the CPU generated traffic to these values using CLI, you cannot see them in the output of the **show running-configuration** command.

## Configuration Examples for Extending QoS for MPLS over MLPPP

- [Configuring Class-map for Matching MPLS EXP Bits, page 24-76](#)
- [Configuring Class-map for Matching IP DSCP Value, page 24-77](#)
- [Configuring Class-map for Matching MPLS EXP Bits or IP DSCP Value, page 24-77](#)
- [Configuring a Policy-map, page 24-77](#)
- [Attaching the Policy-map to MLPPP Interface, page 24-78](#)

### Configuring Class-map for Matching MPLS EXP Bits

The following example shows a configuration of class-map for matching MPLS EXP bits.



```
Building configuration...

Current configuration : 101 bytes
!
class-map match-any mpls_exp5
  match mpls experimental topmost 5
!
```

## Configuring Class-map for Matching IP DSCP Value

The following example shows a configuration of class-map for matching IP DSCP value.

```
Building configuration...

Current configuration : 101 bytes
!
!
class-map match-any dscpaf11
  match ip dscp af11
!
```

## Configuring Class-map for Matching MPLS EXP Bits or IP DSCP Value

The following example shows a configuration of class-map for matching MPLS EXP Bits or IP DSCP value.

```
Building configuration...

Current configuration : 101 bytes
!
!

class-map match-any mplsexp_or_cos
  match mpls experimental topmost 4
  match ip dscp af41
!
```

## Configuring a Policy-map

The following example shows a configuration of a policy-map.

```
Building configuration...

Current configuration : 101 bytes
!
policy-map mplsomlpppqos
  class mplsexp
    priority percent 10
  class mplsexpvalues
    set mpls experimental topmost 4
  class matchdscp
    bandwidth percent 20
  class matchdscpvalues
    set dscp af41
```

```

class mplsexp_or_dscp
  bandwidth percent 20
  queue-limit 80 packets
  set mpls experimental topmost 1
  set dscp af11
!

```

## Configuring a Policy-map to Match on CS5 and EXP 4

The following example shows a configuration of a policy-map.

```

Building configuration...

Current configuration : 101 bytes
!
class-map match-any dscpcs5
  match ip dscp cs5
class-map match-any exp4
  match mpls experimental topmost 4
policy-map dscp_exp
  class dscpcs5
    bandwidth percent 20
    set ip dscp cs6
  class exp4
    bandwidth percent 20
    set mpls experimental topmost 6
  class class-default
    bandwidth percent 20
!

```

## Attaching the Policy-map to MLPPP Interface

The following example shows a configuration of attaching the policy-map to MLPPP interface.

```

Building configuration...

Current configuration : 101 bytes
!
!
interface Multilink3
  ip address 84.1.2.3 255.255.255.0
  load-interval 30
  mpls ip
  keepalive 1
  ppp multilink
  ppp multilink group 3
  ppp multilink endpoint string ML3
  service-policy output mplsomlpppqos
!

```

## Verifying MPLS over MLPPP Configuration

To verify the configuration of MPLS over MLPPP, use the following commands as shown in the examples below:

To verify the details of a class-map created for matching MPLS EXP bits, use the following command as shown in the example below:

```
Router# show run class-map mpls_exp1

Building configuration...

Current configuration : 76 bytes
!
class-map match-any mpls_exp1
  match mpls experimental topmost 1
!
end
```

To verify the details of a class-map created for matching IP DSCP values, use the following command as shown in the example below:

```
Router# show run class-map dscpaf21

Building configuration...

Current configuration : 60 bytes
!
class-map match-any dscpaf21
  match ip dscp af21
!
end
```

To verify the details of a policy-map, use the following command as shown in the example below:

```
Router# show run policy-map policy_match_dscpaf11

Building configuration...

Current configuration : 100 bytes
!
policy-map policy_match_dscpaf11
  class dscpaf11
    set ip dscp af22
    priority percent 10
!
end
```

To verify the details of a policy-map attached to MLPPP interface, use the following command as shown in the example below:

```
Router# show policy-map interface multilink3

Multilink3

Service-policy output: match_dscp_exp

Class-map: dscpcs4 (match-any)
  0 packets, 0 bytes
```

```

30 second offered rate 0000 bps, drop rate 0000 bps
Match: ip dscp cs4 (32)
Queueing
queue limit 38 packets
(queue depth/total drops/no-buffer drops) 0/0/0
(pkts output/bytes output) 0/0
bandwidth 10% (153 kbps)

Class-map: dscpcs6 (match-any)
  19 packets, 1889 bytes
  30 second offered rate 0000 bps, drop rate 0000 bps
Match: ip dscp cs6 (48)
Queueing
queue limit 38 packets
(queue depth/total drops/no-buffer drops) 0/0/0
(pkts output/bytes output) 0/0
bandwidth 10% (153 kbps)

```

## Configuration Guidelines

- This feature must be configured globally for a router; it cannot be configured per-port or per-protocol.
- Enter each **cpu traffic qos** marking action on a separate line.
- The **cpu traffic qos cos** global configuration command configures CoS marking for CPU-generated traffic by using either a specific CoS value or a table map, but not both. A new configuration overwrites the existing configuration.
- The **cpu traffic qos dscp** global configuration command configures IP-DSCP marking for CPU-generated IP traffic by using either a specific DSCP value or a table map, but not both. A new configuration overwrites the existing configuration.
- The **cpu traffic qos precedence** global configuration command configures IP-precedence marking for CPU-generated IP traffic by using either a specific precedence value or a table map, but not both. A new configuration overwrites the existing configuration.
- The **cpu traffic qos dscp** and **cpu traffic qos precedence** global configuration commands are mutually exclusive. A new configuration overwrites the existing configuration.
- When the **cpu traffic qos dscp** global configuration command is configured with table maps, you can configure only one **map from** value at a time—DSCP, precedence, or CoS. A new configuration overwrites the existing configuration. Packets marked by this command can be classified and queued by an output policy map based on the marked DSCP or precedence value.
- When the **cpu traffic qos precedence** global configuration command is configured with table maps, you can configure only one **map from** value at a time—DSCP, precedence, or CoS. A new configuration overwrites the existing configuration. Packets marked by this command can be classified and queued by an output policy map based on the marked precedence or DSCP value.
- You cannot configure a **map from** value of both DSCP and precedence. A new configuration overwrites the existing configuration.
- When the **cpu traffic qos cos** global configuration command is configured with table maps, you can configure two **map from** values at a time—CoS and either DSCP or precedence.
- If the **cpu traffic qos cos** global configuration command is configured with only a **map from** value of DSCP or precedence:

- The CoS value of IP packets is mapped by using the DSCP (or precedence) value in the packet and the configured table map. Packets can be classified and queued by an output policy map based on the marked CoS value.
- The CoS value of non-IP packets remains unchanged.
- If the **cpu traffic qos cos** global configuration command is configured with a **map from** value of CoS:
  - The CoS value of IP packets is mapped by using the CoS value in the packet and the configured table map. Packets can be classified and queued by an output policy map based on the marked CoS value.
  - The CoS value of non-IP packets is mapped by using the CoS value in the packet and the configured table map. Packets can be classified and queued by an output policy map based on the marked CoS value.
- If the **cpu traffic qos cos** global configuration command is configured with a **map from** value of DSCP or precedence and CoS:
  - The CoS value of IP packets is mapped by using the DSCP or precedence value in the packet and the configured table map. Packets can be classified and queued by an output policy map based on the marked CoS value.
  - The CoS value of non-IP packets is mapped by using the CoS value in the packet and the configured table map. Packets can be classified and queued by an output policy map based on the marked CoS value.

## Troubleshooting Tips

The on-demand TCAM resource allocation may fail due to the unavailability of resources for the requested operation. In such scenarios, use the following troubleshooting tips:

1. Run the **show platform tcam detailed** command to understand the current resource allocation.
2. Use this information to find the features that are allocated resources.
3. Unconfigure the features that are no longer required to free the resources.

Figure 24-7 shows the troubleshooting feature scalability procedure.

**Figure 24-7 Troubleshooting Feature Scalability**

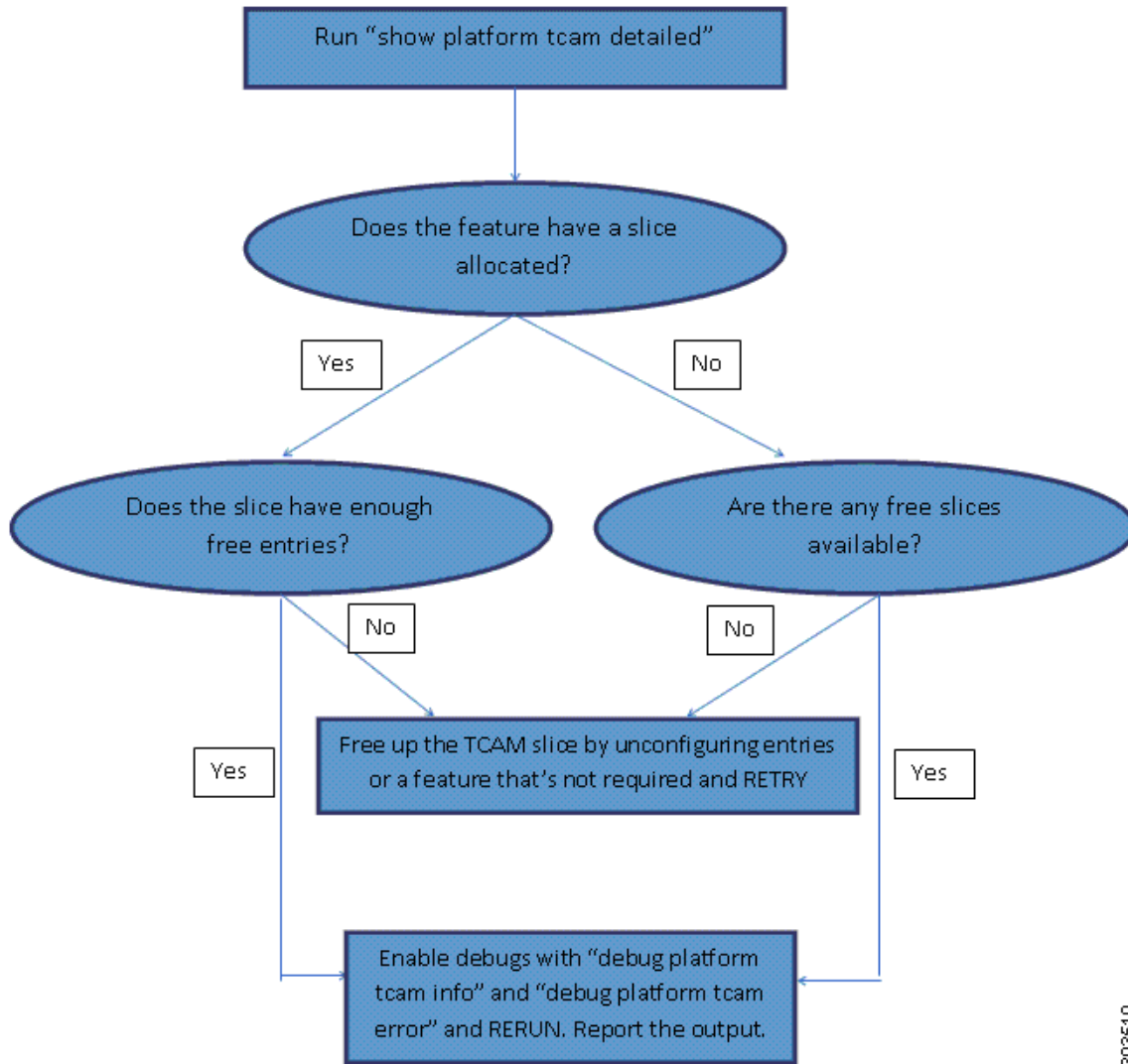

The following TCAM commands are used for troubleshooting feature scalability.

Command	Purpose
<code>show platform tcam summary</code>	Shows the current occupancy of TCAM with summary of the number of slices allocated or free.
<code>show platform tcam detailed</code>	Shows the current occupancy and includes per-slice information such as number of entries used or free, feature(s) using the slice, slice mode, and slice stage and ID. This command helps to understand current resource allocation and decide which feature(s) to unconfigure to free resources.

Command	Purpose
<code>debug platform tcam error</code>	Enables TCAM error printing. By default, the error printing is turned on and the info printing is turned off.
<code>debug platform tcam info</code>	Enables TCAM info printing.

Use the **no** form of the debug commands to disable TCAM error printing and TCAM info printing.



**Warning**

**We suggest you do not use the debug commands without TAC supervision.**

The following is a sample of the output from the `show platform tcam summary` command.

```
Router# show platform tcam summary
Ingress      : 2/8 slices, 512/2048 entries used
Pre-Ingress: 3/4 slices, 768/1024 entries used
Egress       : 0/4 slices, 0/512 entries used
```

The following is a sample of the output from the `show platform tcam detailed` command.

```
Router# show platform tcam detailed

Ingress      : 2/8 slices, 512/2048 entries used
Pre-Ingress: 3/4 slices, 768/1024 entries used
Egress       : 0/4 slices, 0/512 entries used

Slice ID: 1
Stage: Pre-Ingress
Mode: Single
Entries used: 28/256
Slice allocated to: Layer-2 Classify and Assign Group

Slice ID: 4
Stage: Pre-Ingress
Mode: Double
Entries used: 10/128
Slice allocated to: L2CP

Slice ID: 2
Stage: Ingress
Mode: Double
Entries used: 29/128
Slice allocated to: L2 Post-Switch Processing Group

Slice ID: 3
Stage: Ingress
Mode: Single
Entries used: 13/256
Slice allocated to: CESoPSN-UDP, CEF, Layer-3 Control Protocols
```

#### Example: TCAM troubleshooting related error

In this example all the eight slices available at the Ingress stage have already been allocated. Also, the slice allocated to QoS has no free entries. If we need to configure a few more QoS rules, the following options are available:

1. To unconfigure QoS rules that are no longer required and thereby freeing up the entries

## 2. To free up a slice by unconfiguring features that are no longer required.

```
Router# show platform tcam detailed
```

```
Ingress      : 8/8 slices, 2048/2048 entries used [no free slices available]
Pre-Ingress: 3/4 slices, 768/1024 entries used
Egress       : 0/4 slices, 0/512 entries used
```

```
Slice ID: 1
Stage: Pre-Ingress
Mode: Single
Entries used: 29/256
Slice allocated to: Layer-2 Classify and Assign Group
```

```
Slice ID: 4
Stage: Pre-Ingress
Mode: Double
Entries used: 11/128
Slice allocated to: L2CP
```

```
Slice ID: 2
Stage: Ingress
Mode: Double
Entries used: 27/128
Slice allocated to: L2 Post-Switch Processing Group
```

```
Slice ID: 6
Stage: Ingress
Mode: Single
Entries used: 250/256
Slice allocated to: Port ACLs
```

```
Slice ID: 5
Stage: Ingress
Mode: Single
Entries used: 500/512
Slice allocated to: Router ACLs
```

```
Slice ID: 7
Stage: Ingress
Mode: Double
Entries used: 10/128
Slice allocated to: OAM, Ethernet loopback, Y.1731 DMM
```

```
Slice ID: 3
Stage: Ingress
Mode: Double
Entries used: 15/128
Slice allocated to: CESoPSN-UDP, CEF, Layer-3 Control Protocols
```

```
Slice ID: 8
Stage: Ingress
Mode: Double
Entries used: 256/256 [no free entries available]
Slice allocated to: Quality Of Service
```

### Configuring a service-policy fails because of insufficient resources.

```
Router(config-if-srv)# service-policy input policy2
Router(config-if-srv)#
*Mar 6 18:41:14.771: %Error: Not enough hardware resources to program this policy-map

*Mar 6 18:41:14.771: %QOS-6-POLICY_INST_FAILED:
Service policy installation failed
```



```
Router(config-if-srv)#
```

In the above scenario, you can free up the TCAM rules by unconfiguring the service-policy that is no longer required or free up a slice by unconfiguring a feature that is no longer required.

```
Router(config-if-srv)# no service-policy input policy1
```

```
Router(config-if-srv)# end
```

```
Router#
```

```
Router# show platform tcam detailed
```

```
Ingress      : 8/8 slices, 2048/2048 entries used
```

```
Pre-Ingress: 3/4 slices, 768/1024 entries used
```

```
Egress       : 0/4 slices, 0/512 entries used
```

```
Slice ID: 1
```

```
Stage: Pre-Ingress
```

```
Mode: Single
```

```
Entries used: 29/256
```

```
Slice allocated to: Layer-2 Classify and Assign Group
```

```
Slice ID: 4
```

```
Stage: Pre-Ingress
```

```
Mode: Double
```

```
Entries used: 11/128
```

```
Slice allocated to: L2CP
```

```
Slice ID: 2
```

```
Stage: Ingress
```

```
Mode: Double
```

```
Entries used: 27/128
```

```
Slice allocated to: L2 Post-Switch Processing Group
```

```
Slice ID: 6
```

```
Stage: Ingress
```

```
Mode: Single
```

```
Entries used: 250/256
```

```
Slice allocated to: Port ACLs
```

```
Slice ID: 5
```

```
Stage: Ingress
```

```
Mode: Single
```

```
Entries used: 500/512
```

```
Slice allocated to: Router ACLs
```

```
Slice ID: 7
```

```
Stage: Ingress
```

```
Mode: Double
```

```
Entries used: 10/128
```

```
Slice allocated to: OAM, Ethernet loopback, Y.1731 DMM
```

```
Slice ID: 3
```

```
Stage: Ingress
```

```
Mode: Double
```

```
Entries used: 15/128
```

```
Slice allocated to: CESoPSN-UDP, CEF, Layer-3 Control Protocols
```

```
Slice ID: 8
```

```
Stage: Ingress
```

```
Mode: Double
```

```
Entries used: 195/256 [after unconfiguring policy1]
```

```
Slice allocated to: Quality Of Service
```

We now have enough free entries to configure policy2.

```
Router(config-if-srv)# service-policy input policy2
Router(config-if-srv)#

Router# show platform tcam detailed

Ingress      : 8/8 slices, 2048/2048 entries used
Pre-Ingress  : 3/4 slices, 768/1024 entries used
Egress       : 0/4 slices, 0/512 entries used

Slice ID: 1
Stage: Pre-Ingress
Mode: Single
Entries used: 29/256
Slice allocated to: Layer-2 Classify and Assign Group

Slice ID: 4
Stage: Pre-Ingress
Mode: Double
Entries used: 11/128
Slice allocated to: L2CP

Slice ID: 2
Stage: Ingress
Mode: Double
Entries used: 27/128
Slice allocated to: L2 Post-Switch Processing Group

Slice ID: 6
Stage: Ingress
Mode: Single
Entries used: 250/256
Slice allocated to: Port ACLs

Slice ID: 5
Stage: Ingress
Mode: Single
Entries used: 500/512
Slice allocated to: Router ACLs

Slice ID: 7
Stage: Ingress
Mode: Double
Entries used: 10/128
Slice allocated to: OAM, Ethernet loopback, Y.1731 DMM

Slice ID: 3
Stage: Ingress
Mode: Double
Entries used: 15/128
Slice allocated to: CESoPSN-UDP, CEF, Layer-3 Control Protocols

Slice ID: 8
Stage: Ingress
Mode: Double
Entries used: 220/256 [after configuring policy2]
Slice allocated to: Quality Of Service
```

# Additional References

The following sections provide references related to bit error rate testing.

## Related Documents

Related Topic	Document Title
Cisco IOS Commands	<a href="#">Cisco IOS Master Commands List, All Releases</a>
ASR 901 Command Reference	<a href="#">Cisco ASR 901 Series Aggregation Services Router Command Reference</a>
Cisco IOS MQC Commands	<a href="#">Cisco IOS Quality of Service Solutions Command Reference</a>

## Standards

Standard	Title
None	—

## MIBs

MIB	MIBs Link
None	To locate and download MIBs for selected platforms, Cisco IOS releases, and feature sets, use Cisco MIB Locator found at the following URL: <a href="http://www.cisco.com/go/mibs">http://www.cisco.com/go/mibs</a>

## RFCs

RFC	Title
None	—

## Technical Assistance

Description	Link
The Cisco Technical Support website contains thousands of pages of searchable technical content, including links to products, technologies, solutions, technical tips, and tools. Registered Cisco.com users can log in from this page to access even more content.	<a href="http://www.cisco.com/techsupport">http://www.cisco.com/techsupport</a>

# Feature Information for Configuring QoS

Table 24-8 lists the features in this module and provides links to specific configuration information.

Use Cisco Feature Navigator to find information about platform support and software image support. Cisco Feature Navigator enables you to determine which software images support a specific software release, feature set, or platform. To access Cisco Feature Navigator, go to <http://www.cisco.com/go/cfn>. An account on Cisco.com is not required.

**Note**

Table 24-8 lists only the software release that introduced support for a given feature in a given software release train. Unless noted otherwise, subsequent releases of that software release train also support that feature.

**Table 24-8** Feature Information for Configuring QoS

Feature Name	Releases	Feature Information
ACL-based QoS	15.2(2)SNH1	This feature was introduced.
Shaper Burst Commit Size Down to 1 ms	15.2(2)SNI	The following section provides information about this feature: <ul style="list-style-type: none"> <li><a href="#">Traffic Shaping</a></li> </ul>
Egress Policing	15.3(3)S	Support for Egress Policing was introduced on the Cisco ASR 901 routers.
Multiaction Ingress Policer on EVC	15.3(3)S	Support for Multiaction Ingress Policer on EVC was introduced on the Cisco ASR 901 routers.
QoS for MPLS over MLPPP	15.4(1)S	This feature was introduced on the Cisco ASR 901 routers. The following sections provide information about this feature: <ul style="list-style-type: none"> <li><a href="#">QoS for MPLS/IP over MLPPP, page 24-31</a></li> <li><a href="#">Extending QoS for MLPPP, page 24-64</a></li> </ul>



## Configuring MLPPP

The Multilink Point-to-Point (MLPPP) feature provides load balancing functionality over multiple WAN links, while providing multivendor interoperability, packet fragmentation and proper sequencing, and load calculation on both inbound and outbound traffic.



**Note**

To get information on the basic configuration of MLPPP, see [http://www.cisco.com/en/US/docs/ios/12\\_2/dial/configuration/guide/dafppp.html](http://www.cisco.com/en/US/docs/ios/12_2/dial/configuration/guide/dafppp.html).

## Finding Feature Information

Your software release may not support all the features documented in this module. For the latest feature information and caveats, see the release notes for your platform and software release. To find information about the features documented in this module, and to see a list of the releases in which each feature is supported, see the “[Feature Information for MLPPP](#)” section on page 25-22.

Use Cisco Feature Navigator to find information about platform support and Cisco software image support. To access Cisco Feature Navigator, go to <http://www.cisco.com/go/cfn>. An account on Cisco.com is not required.

## Contents

This section contains the following topics:

- [Prerequisites](#), page 25-2
- [Restrictions](#), page 25-2
- [MLPPP Optimization Features](#), page 25-2
- [Configuring MLPPP Backhaul](#), page 25-6
- [Additional References](#), page 25-21
- [Feature Information for MLPPP](#), page 25-22

## Prerequisites

- Cisco IOS Release 15.2(2)SNI or a later release that supports the Multiprotocol Label Switching (MPLS) over MLPPP feature must be installed previously on the Cisco ASR 901 Series Aggregation Services Router.
- Cisco Express Forwarding (CEF) or distributed Cisco Express Forwarding (dCEF) should be enabled.
- MPLS should be enabled on PE and P routers.
- Before enabling MPLS over MLPPP link, configure the following commands:
  - **mpls label protocol ldp**
  - **mpls ip** (configure this command over MLPPP link where IP address has been enabled)

## Restrictions

- TE-FRR/LFA FRR feature is not supported on the MLPPP interface.
- Virtual Routing and Forwarding (VRF) configuration is not supported on the MLPPP interface.
- You need to shut down and bring up the MLPP interface for the following conditions:
  - On the fly fragmentation enable or disable
  - On the fly changes to the fragment size
  - Link fragmentation interleave
  - Enabling multiclass
- If the CPU command is modified when IS-IS is configured, you should remove and re-apply the service-policy in MLPPP.

## MLPPP Optimization Features

The Cisco ASR 901 supports several features that improve the performance of Multilink Point-to-Point Protocol (MLPPP) connections and related applications such as IP over MLPPP. Some important features are given below:

- [Distributed Multilink Point-to-Point Protocol Offload](#)
- [Multiclass MLPPP](#)
- [MPLS over MLPPP](#)

## Distributed Multilink Point-to-Point Protocol Offload

Distributed Multilink Point-to-Point Protocol (dMLPPP) allows you to combine T1 or E1 connections into a bundle that has the combined bandwidth of all of the connections in the bundle, providing improved capacity and CPU utilization over MLPPP. The dMLPPP offload feature improves the performance for traffic in dMLPPP applications such as IP over MLPPP by shifting processing of this traffic from the main CPU to the network processor.

The Cisco ASR 901 supports one serial link per T1/E1 connection and up to 16 MLPPP bundles. You can use the fixed T1/E1 ports to create up to 16 MLPPP links.

The Cisco ASR 901 implementation of multilink (dMLPPP) uses interleaving to allow short, delay-sensitive packets to be transmitted within a predictable amount of time. Interleaving allows the Cisco ASR 901 to interrupt the transmission of delay-insensitive packets in order to transmit delay-sensitive packets. You can also adjust the responsiveness of the Cisco ASR 901 to delay-sensitive traffic by adjusting the maximum fragment size; this value determines the maximum delay that a delay-sensitive packet can encounter while the Cisco ASR 901 transmits queued fragments of delay-insensitive traffic.

## Multiclass MLPPP

The Cisco ASR 901 implementation of dMLPPP also supports Multiclass MLPPP. Multiclass MLPPP is an extension to MLPPP functionality that allows you to divide traffic passing over a multilink bundle into several independently sequenced streams or classes. Each multiclass MLPPP class has a unique sequence number, and the receiving network peer processes each stream independently. The multiclass MLPPP standard is defined in RFC 2686.

The Cisco ASR 901 supports the following multiclass MLPPP classes:

- Class 0- Data traffic that is subject to normal MLPPP fragmentation. Appropriate for non-delay-sensitive traffic.
- Class 1- Data traffic that can be interleaved but not fragmented. Appropriate for delay-sensitive traffic such as voice.

**Note**

By default, Multiclass MLPPP is enabled with two classes. Maximum number of classes supported is also two.

**Note**

The Cisco ASR 901 does not support some PPP and MLPPP options when the bundle is offloaded to the network processor; you can retain these options by disabling MLPPP and IPHC offloading for a given bundle. For more information, see [“MLPPP Offload” section on page 25-13](#).

**Note**

The output for the **show ppp multilink** command for an offloaded MLPPP bundle differs from the output for a non-offloaded bundle.

## MPLS over MLPPP

The Multiprotocol Label Switching (MPLS) support over Multilink PPP feature allows you to use labeled switch paths (LSPs) over MLPPP links. In a network with Ethernet and MLPPP connections, this feature supports MPLS over MLPPP links in the edge (PE-to-CE) or in the MPLS core (PE-to-PE and PE-to-P) or at the end of MPLS labeled path (CE-to-PE) as PE router.

**Note**

QoS is not supported for MPLS over MLPPP.

This section contains the following topics:

- [MPLS Features Supported for MLPPP](#)
- [MPLS over MLPPP on PE-to-CE Links](#)
- [MPLS over MLPPP on Core Links](#)
- [MPLS over MLPPP on CE to PE Links](#)

## MPLS Features Supported for MLPPP

The following features are supported.

- MPLS Label imposition (LER)
- MPLS Label switching (LSR)
- MPLS VPN (L3VPN): User-Network Interface (UNI) on which virtual routing and forwarding (VRF) is configured should be switch virtual interface (SVI) on Gigabit interfaces and Network-to-Network Interface(NNI) can be MLPPP link
- Routing Protocols – ISIS/OSPF/BGP on MLPPP
- Label Distribution Protocol (LDP) as MPLS label protocol
- Equal Cost Multipath (ECMP) support on MLPPP links for IP to Tag (LER cases)

## MPLS over MLPPP on PE-to-CE Links

Figure 1 shows a typical MPLS network in which the PE router is responsible for label imposition (at ingress) and disposition (at egress) of the MPLS traffic.

In this topology, MLPPP is deployed on the PE-to-CE links.

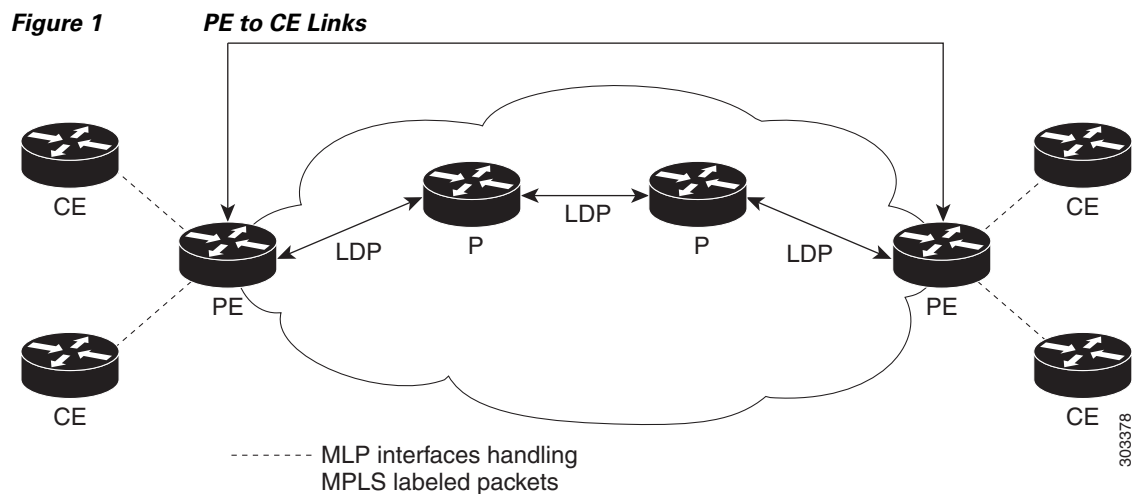



## MPLS over MLPPP on Core Links

Figure 2 shows a sample topology in which MPLS is deployed over MLPPP on PE-to-P and P-to-P links. Enabling MPLS on MLPPP for PE-to-P links is similar to enabling MPLS on MLPPP for P-to-P links.

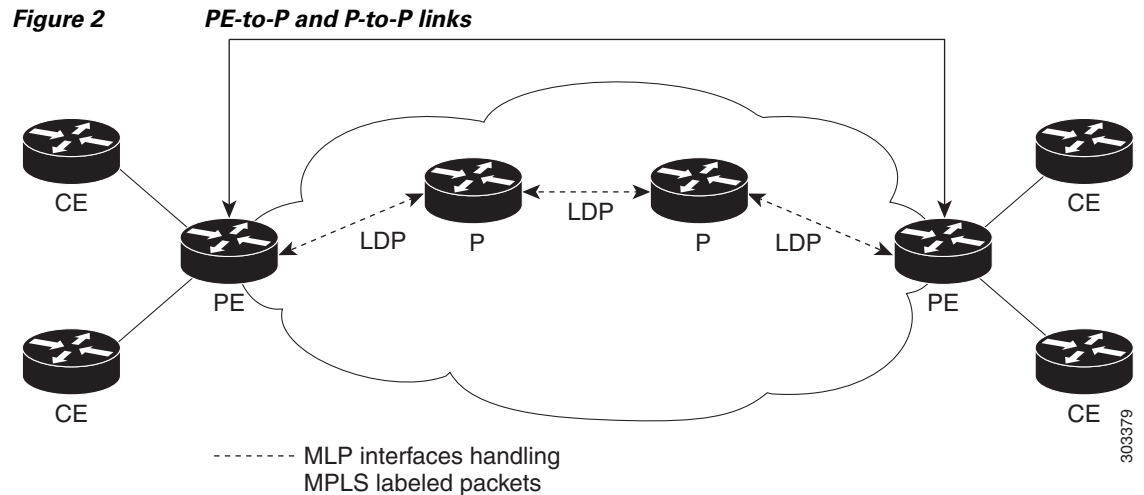

## MPLS over MLPPP on CE to PE Links

Figure 3 shows a sample topology in which MPLS is deployed over MLPPP between CE and PE links with LDP.

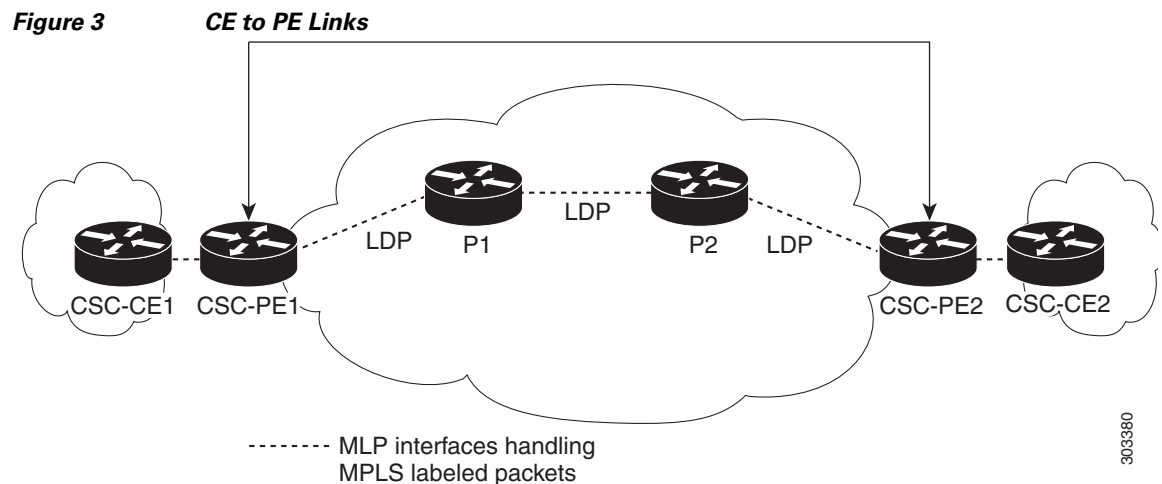

# Configuring MLPPP Backhaul

To configure an MLPPP backhaul, complete the following tasks:

- [Configuring the Card Type, E1 and T1 Controllers, page 25-6](#)
- [Configuring a Multilink Backhaul Interface, page 25-6](#)

## Configuring the Card Type, E1 and T1 Controllers

For information on configuring the card type, E1 and T1 controllers, see [Chapter 18, Configuring T1/E1 Controllers](#).

## Configuring a Multilink Backhaul Interface

A multilink interface is a virtual interface that represents a multilink PPP bundle. The multilink interface coordinates the configuration of the bundled link, and presents a single object for the aggregate links. However, the individual PPP links that are aggregated must also be configured. Therefore, to enable multilink PPP on multiple serial interfaces, you first need to set up the multilink interface, and then configure each of the serial interfaces and add them to the same multilink interface.



### Note

In the following procedure, press the **Return** key after each step unless otherwise noted. At any time, you can exit the privileged level and return to the user level by entering **disable** at the `Router#` prompt.

The Cisco ASR 901 router can support up to 16 E1/T1 connections through the multilink interface, ranging from 16 bundles of one E1/T1 each to a single bundle containing 16 E1/T1 bundles.

Complete the following tasks to configure a multilink backhaul interface.

- [Creating a Multilink Bundle, page 25-6](#)
- [Configuring MRRU, page 25-7](#)
- [Configuring PFC and ACFC, page 25-8](#)
- [Enabling Multilink and Identifying the Multilink Interface, page 25-11](#)
- [Configuring a Serial Interface as a Member Link of a MLPPP Group, page 25-12](#)

## Creating a Multilink Bundle

Complete the following steps to create a multilink bundle:

### SUMMARY STEPS

1. **enable**
2. **configure terminal**
3. **interface multilink** *group-number*
4. **ip address** *address* [*subnet mask*]
5. **exit**

## DETAILED STEPS

	Command	Purpose
Step 1	<b>enable</b>  <b>Example:</b> Router> enable	Enables privileged EXEC mode. <ul style="list-style-type: none"> <li>Enter your password if prompted.</li> </ul>
Step 2	<b>configure terminal</b>  <b>Example:</b> Router# configure terminal	Enters global configuration mode.
Step 3	Router(config)# <b>interface multilink</b> <i>group-number</i>  <b>Example:</b> Router(config)# interface multilink5	Creates a multilink bundle and enters the interface configuration mode: <ul style="list-style-type: none"> <li><i>group-number</i>—Number of the multilink bundle.</li> </ul> The example creates a multilink bundle 5. To remove a multilink bundle, use the <b>no</b> form of this command.
Step 4	Router(config-if)# <b>ip address</b> <i>address [subnet mask]</i>  <b>Example:</b> Router(config-if)# ip address 10.10.10.2 255.255.255.0	Assigns an IP address to the multilink interface. <ul style="list-style-type: none"> <li><i>address</i>— IP address.</li> <li><i>subnet mask</i>—Network mask of IP address.</li> </ul> The example configures an IP address and subnet mask.
Step 5	Router(config-if)# <b>exit</b>  <b>Example:</b> Router(config-if)# exit	Exits configuration mode.

## Configuring MRRU

You should configure the local maximum received reconstructed unit (MRRU) of the multilink bundle to a value greater than or equal to 1508 bytes (or equal to the maximum packet length expected on the bundle at any point in time). The maximum MTU supported on the Cisco ASR 901 router is 1536, and MTU drops occur when the packet length is more than 1536.

Complete the following steps to configure MRRU:

## SUMMARY STEPS

1. **enable**
2. **configure terminal**
3. **interface multilink** *group-number*
4. **ppp multilink mru local** *bytes*
5. **end**

## DETAILED STEPS

	Command	Purpose
Step 1	<b>enable</b>  <b>Example:</b> Router> enable	Enables privileged EXEC mode. <ul style="list-style-type: none"> <li>Enter your password if prompted.</li> </ul>
Step 2	<b>configure terminal</b>  <b>Example:</b> Router# configure terminal	Enters global configuration mode.
Step 3	<b>interface multilink</b> <i>multilink-bundle-number</i>  <b>Example:</b> Router(config)# interface multilink 1	Creates a multilink bundle and enters the multilink interface configuration mode to configure the multilink bundle. <ul style="list-style-type: none"> <li><i>multilink-bundle-number</i>—Number of the multilink bundle. The range is from 1 to 65535.</li> </ul>
Step 4	<b>ppp multilink mrru local bytes</b>  <b>Example:</b> Router(config-if)# ppp multilink mrru local 1536	Configures the MRRU value negotiated on a Multilink PPP bundle. <ul style="list-style-type: none"> <li><b>local</b>—Configures the local MRRU value.</li> <li><i>bytes</i>—MRRU value, in bytes. Valid value range is 128 to 16384.</li> </ul>
Step 5	<b>exit</b>  <b>Example:</b> Router(config)# exit	Exits configuration mode.

## Configuring PFC and ACFC

Protocol-Field-Compression (PFC) and Address-and-Control-Field-Compression (ACFC) are PPP compression methods defined in RFCs 1661 and 1662. PFC allows for compression of the PPP Protocol field; ACFC allows for compression of the PPP Data Link Layer Address and Control fields.

Follow these steps to configure PFC and ACFC handling during PPP negotiation to be configured. By default, PFC/ACFC handling is not enabled.

**Note**

The recommended PFC and ACFC handling in the Cisco ASR 901 router is: **acfc local request, acfc remote apply, pfc local request, and pfc remote apply.**

## Configuring PFC

Complete the following steps to configure PFC handling during PPP negotiation:

## SUMMARY STEPS

- enable**
- configure terminal**

3. **interface multilink** *group-number*
4. **ppp pfc local** {**request** | **forbid**}
5. **ppp pfc remote** {**apply** | **reject** | **ignore**}
6. **exit**

## DETAILED STEPS

	Command	Purpose
Step 1	<b>enable</b>  <b>Example:</b> Router> enable	Enables privileged EXEC mode. <ul style="list-style-type: none"> <li>Enter your password if prompted.</li> </ul>
Step 2	<b>configure terminal</b>  <b>Example:</b> Router# configure terminal	Enters global configuration mode.
Step 3	Router(config)# <b>interface multilink</b> <i>group-number</i>  <b>Example:</b> Router(config)# interface multilink5	Creates a multilink bundle and enters the interface configuration mode: <ul style="list-style-type: none"> <li><i>group-number</i>—Number of the multilink bundle.</li> </ul> <p>The example creates a multilink bundle 5.</p> <p>To remove a multilink bundle, use the <b>no</b> form of this command.</p>
Step 4	Router(config-if)# <b>ppp pfc local</b> { <b>request</b>   <b>forbid</b> }  <b>Example:</b> Router(config-if)# ppp pfc local request	Configures how the router handles PFC in its outbound configuration requests, use the <b>ppp pfc local</b> command. The syntax is as follows: <ul style="list-style-type: none"> <li><i>request</i>—The PFC option is included in outbound configuration requests.</li> <li><i>forbid</i>—The PFC option is not sent in outbound configuration requests, and requests from a remote peer to add the PFC option are not accepted.</li> </ul> <p>The example shows how to create a method for the router to manage PFC.</p>
Step 5	Router(config-if)# <b>ppp pfc remote</b> { <b>apply</b>   <b>reject</b>   <b>ignore</b> }  <b>Example:</b> Router(config-if)# ppp pfc remote apply	Specifies how the router manages the PFC option in configuration requests received from a remote peer. The syntax is as follows: <ul style="list-style-type: none"> <li><i>apply</i>—Specifies that PFC options are accepted and PFC may be performed on frames sent to the remote peer.</li> <li><i>reject</i>—Specifies that PFC options are explicitly ignored.</li> <li><i>ignore</i>—Specifies that PFC options are accepted, but PFC is not performed on frames sent to the remote peer.</li> </ul> <p>The example shows how to allow PFC options to be accepted.</p>
Step 6	Router(config-if)# <b>exit</b>  <b>Example:</b> Router(config)# exit	Exits configuration mode.

## Configuring ACFC

Complete the following steps to configure ACFC handling during PPP negotiation:

### SUMMARY STEPS

1. **enable**
2. **configure terminal**
3. **interface multilink** *group-number*
4. **ppp acfc local** {**request** | **forbid**}
5. **ppp acfc remote** {**apply** | **reject** | **ignore**}
6. **exit**

### DETAILED STEPS

	Command	Purpose
Step 1	<b>enable</b>  <b>Example:</b> Router> enable	Enables privileged EXEC mode. <ul style="list-style-type: none"> <li>• Enter your password if prompted.</li> </ul>
Step 2	<b>configure terminal</b>  <b>Example:</b> Router# configure terminal	Enters global configuration mode.
Step 3	Router(config)# <b>interface multilink</b> <i>group-number</i>  <b>Example:</b> Router(config)# interface multilink 5	Creates a multilink bundle and enter the interface configuration mode: <ul style="list-style-type: none"> <li>• <i>group-number</i>—Number of the multilink bundle.</li> </ul> The example creates a multilink bundle 5. To remove a multilink bundle, use the <b>no</b> form of this command.
Step 4	Router(config-if)# <b>ppp acfc local</b> { <b>request</b>   <b>forbid</b> }  <b>Example:</b> Router(config-if)# ppp acfc local request	Specifies how the router handles ACFC in outbound configuration requests. The syntax is as follows: <ul style="list-style-type: none"> <li>• <i>request</i>—Specifies that the ACFC option is included in outbound configuration requests.</li> <li>• <i>forbid</i>—Specifies that the ACFC option is not sent in outbound configuration requests, and requests from a remote peer to add the ACFC option are not accepted.</li> </ul>

	Command	Purpose
Step 5	<pre>Router(config-if)# ppp acfc remote {apply   reject   ignore}</pre> <p><b>Example:</b> Router(config-if)# ppp acfc remote apply</p>	<p>Specifies how the router handles the ACFC option in configuration requests received from a remote peer. The syntax is as follows:</p> <ul style="list-style-type: none"> <li>• <i>apply</i>—ACFC options are accepted and ACFC may be performed on frames sent to the remote peer.</li> <li>• <i>reject</i>—ACFC options are explicitly ignored.</li> <li>• <i>ignore</i>—ACFC options are accepted, but ACFC is not performed on frames sent to the remote peer.</li> </ul> <p>The example allows ACFC options to be accepted.</p>
Step 6	<pre>Router(config-if)# exit</pre> <p><b>Example:</b> Router(config)# exit</p>	Exit configuration mode.

## Enabling Multilink and Identifying the Multilink Interface

Complete the following steps to enable multilink and identify the multilink interface:



### Note

If you modify parameters for an MLPPP bundle while it is active, the changes do not take effect until the Cisco ASR 901 renegotiates the bundle connection.

## SUMMARY STEPS

1. **enable**
2. **configure terminal**
3. **interface multilink** *group-number*
4. **keepalive** [*period* [*retries*]]
5. **exit**

## DETAILED STEPS

	Command	Purpose
Step 1	<pre>enable</pre> <p><b>Example:</b> Router&gt; enable</p>	<p>Enables privileged EXEC mode.</p> <ul style="list-style-type: none"> <li>• Enter your password if prompted.</li> </ul>
Step 2	<pre>configure terminal</pre> <p><b>Example:</b> Router# configure terminal</p>	Enters global configuration mode.

	Command	Purpose
Step 3	<pre>Router(config-if)# <b>interface</b> <b>multilink</b> <i>group-number</i></pre> <p><b>Example:</b>  <pre>Router(config-if)# interface multilink 5</pre></p>	<p>Creates the multilink group interface corresponding to the specified group number. This command enables the following commands under the interface multilink group number:</p> <ol style="list-style-type: none"> <li><b>ppp multilink</b></li> <li><b>ppp multilink group</b> <i>group-number</i></li> </ol> <p>where <i>group-number</i> is the Multilink group number.</p> <p>The example restricts (identifies) the multilink interface that can be negotiated to multilink interface 5.</p>
Step 4	<pre>Router(config-if)# <b>keepalive</b> [<i>period</i> [<i>retries</i>]]</pre> <p><b>Example:</b>  <pre>Router(config-if)# keepalive 1 5</pre></p>	<p>Enables keepalive packets on the interface and specifies the number of times the keepalive packets are sent without a response before the router disables the interface. The syntax is as follows:</p> <ul style="list-style-type: none"> <li><i>period</i>—(Optional) Integer value in seconds greater than 0. The default is 10. Using 0 disables the keepalive option.</li> <li><i>retries</i>—(Optional) Specifies the number of times that the device will continue to send keepalive packets without response before bringing the interface down. Integer value greater than 1 and less than 255. If omitted, the value that was previously set is used; if no value was specified previously, the default of 5 is used.</li> </ul>
Step 5	<pre>Router(config-if)# <b>exit</b></pre> <p><b>Example:</b>  <pre>Router(config)# exit</pre></p>	<p>Exits configuration mode.</p>

## Configuring a Serial Interface as a Member Link of a MLPPP Group

Complete the following steps to configure a serial interface as a member link of a MLPPP group:

### SUMMARY STEPS

1. **enable**
2. **configure terminal**
3. **interface serial slot/port:** *channel-group-number*
4. **encapsulation ppp**
5. **ppp multilink**
6. **ppp multilink group** *group-number*
7. **exit**



## DETAILED STEPS

	Command	Purpose
Step 1	<b>enable</b>  <b>Example:</b> Router> enable	Enables privileged EXEC mode. <ul style="list-style-type: none"> <li>Enter your password if prompted.</li> </ul>
Step 2	<b>configure terminal</b>  <b>Example:</b> Router# configure terminal	Enters global configuration mode.
Step 3	Router(config-if)# <b>interface serial slot/port:channel-group-number</b>  <b>Example:</b> Router(config-if)# interface serial 0/5:5	Identifies and accesses the serial interface on the specified slot and port. <ul style="list-style-type: none"> <li><i>channel-group-number</i>—ID number to identify the channel group. The valid range is from 0–30 for E1 controllers and 0–23 for T1 controllers.</li> </ul>
Step 4	Router(config-if)# <b>encapsulation ppp</b>  <b>Example:</b> Router(config-if)# encapsulation ppp	Enables PPP encapsulation on the serial interface.
Step 5	Router(config-if)# <b>ppp multilink</b>  <b>Example:</b> Router(config-if)# ppp multilink	Enables multilink PPP on the serial interface.
Step 6	Router(config-if)# <b>ppp multilink group group-number</b>  <b>Example:</b> Router(config-if)# ppp multilink group 5	Configures the serial interface as a member link to the multilink interface identified by the group-number. <ul style="list-style-type: none"> <li><i>group-number</i>—Multilink group number.</li> </ul> <p>The example identifies the multilink interface to which the serial interface should be bound to as a member-link.</p>
Step 7	Router(config-if)# <b>exit</b>  <b>Example:</b> Router(config)# exit	Exits configuration mode.

## MLPPP Offload

By default, the Cisco ASR 901 router offloads processing for distributed MLPPP (dMLPPP) to the network processor for improved performance. However, the Cisco ASR 901 does not support some dMLPPP settings on offloaded bundles. The Cisco ASR 901 does not support the following options on offloaded dMLPPP bundles:

- ppp multilink idle-link**
- ppp multilink queue depth**

- **ppp multilink fragment maximum**
- **ppp multilink slippage**
- **ppp timeout multilink lost-fragment**

**Note**

---

If you have a bundle that requires the use of these options, contact Cisco support for assistance.

---

## Configuring Additional MLPPP Settings

You can perform a variety of other configurations on an MLPPP bundle, including the following:

- Modifying the maximum fragment size
- Modifying fragmentation settings
- Enabling or disabling fragmentation
- Enabling or disabling interleaving
- Configuring multiclass MLPPP

**Note**

---

For more information about configuring MLPPP, see the [Dial Configuration Guide, Cisco IOS Release 15.0S](#).

---

## Configuring MPLS over the MLPPP on a Serial Interface

Complete the following steps to configure MPLS over the MLPPP link on a serial interface:

### SUMMARY STEPS

1. **enable**
2. **configure terminal**
3. **interface serial** *slot/port:time-slot*
4. **no ip address**
5. **encapsulation** *encapsulation-type*
6. **ppp multilink**
7. **ppp multilink group** *group-number*
8. **exit**

## DETAILED STEPS

	Command	Purpose
Step 1	<b>enable</b>  <b>Example:</b> Router> enable	Enables privileged EXEC mode. <ul style="list-style-type: none"> <li>Enter your password if prompted.</li> </ul>
Step 2	<b>configure terminal</b>  <b>Example:</b> Router# configure terminal	Enters global configuration mode.
Step 3	<b>interface serial</b> <i>slot/port:time-slot</i>  <b>Example:</b> Router(config-if)# interface Serial0/0:0	Specifies a serial interface created on a channelized E1 or channelized T1 controller: <ul style="list-style-type: none"> <li><i>slot</i>—Slot number where the channelized E1 or T1 controller is located.</li> <li><i>port</i>—Port number where the channelized E1 or T1 controller is located.</li> <li><i>time-slot</i>—For ISDN, the D channel time slot, which is the :<b>23</b> channel for channelized T1 and the :<b>15</b> channel for channelized E1. PRI time slots are in the range from 0 to 23 for channelized T1 and in the range from 0 to 30 for channelized E1.</li> </ul>
Step 4	<b>no ip address</b>  <b>Example:</b> Router(config-if)# no ip address	Disabled IP address processing.
Step 5	<b>encapsulation</b> <i>encapsulation-type</i>  <b>Example:</b> Router(config-if)# encapsulation ppp	Configures the encapsulation method used by the interface. <ul style="list-style-type: none"> <li><i>encapsulation-type</i>—Encapsulation type.</li> </ul>
Step 6	<b>ppp multilink</b>  <b>Example:</b> Router(config-if)# ppp multilink	Enables Multilink PPP on an interface .
Step 7	<b>ppp multilink group</b> <i>group-number</i>  <b>Example:</b> Router(config-if)# ppp multilink group 2	Restricts a physical link to join only one designated multilink group interface. <ul style="list-style-type: none"> <li><i>group-number</i>—Multilink-group number (a non-zero number).</li> </ul>
Step 8	<b>exit</b>  <b>Example:</b> Router(config)# exit	Exits interface configuration mode.

## Configuring MPLS over MLPPP for OSPF

Complete the following steps to configure MPLS over the MLPPP link for OSPF:

### SUMMARY STEPS

1. **enable**
2. **configure terminal**
3. **interface multilink** *group-number*
4. **ip address** *address* [*subnet mask*]
5. **ip ospf** *process-id* **area** *area-id*
6. **ip ospf authentication null**
7. **mpls ip**
8. **no keepalive**
9. **ppp pfc local request**
10. **ppp pfc remote apply**
11. **ppp multilink**
12. **ppp multilink group** *group-number*
13. **ppp multilink endpoint string** *char-string*
14. **exit**
15. **router ospf** *process-id* [*vrf vrf-name*]
16. **network** *ip-address wildcard-mask* **area** *area-id*
17. **exit**

### DETAILED STEPS

	Command	Purpose
Step 1	<b>enable</b>  <b>Example:</b> Router> enable	Enables privileged EXEC mode. <ul style="list-style-type: none"><li>• Enter your password if prompted.</li></ul>
Step 2	<b>configure terminal</b>  <b>Example:</b> Router# configure terminal	Enters global configuration mode.
Step 3	<b>interface multilink</b> <i>group-number</i>  <b>Example:</b> Router(config)# interface multilink 2	Creates the multilink group interface corresponding to the specified group number, and enters the interface configuration mode. <ul style="list-style-type: none"><li>• <i>group-number</i>—Multilink group number.</li></ul>

	Command	Purpose
Step 4	<p><b>ip address</b> <i>address</i> [<i>subnet mask</i>]</p> <p><b>Example:</b> Router(config-if)# ip address 11.11.11.2 255.255.255.0</p>	<p>Assigns an IP address to the multilink interface.</p> <ul style="list-style-type: none"> <li><i>address</i>—IP address.</li> <li><i>subnet mask</i>—Network mask of IP address.</li> </ul>
Step 5	<p><b>ip ospf</b> <i>process-id</i> <b>area</b> <i>area-id</i></p> <p><b>Example:</b> Router(config-if)# ip router isis</p>	<p>Enables OSPF on an interface.</p> <ul style="list-style-type: none"> <li><i>process-id</i>—A decimal value in the range from 1 to 65535.</li> <li><i>area-id</i>—A decimal value in the range from 0 to 4294967295, or an IP address.</li> </ul>
Step 6	<p><b>ip ospf authentication null</b></p> <p><b>Example:</b> Router(config-if)# ip ospf authentication null</p>	<p>Specifies the authentication type for an interface.</p> <ul style="list-style-type: none"> <li><b>null</b>—No authentication is used. Useful for overriding password or message-digest authentication if configured for an area.</li> </ul>
Step 7	<p><b>mpls ip</b></p> <p><b>Example:</b> Router(config-if)# mpls ip</p>	<p>Enables MPLS forwarding of IPv4 packets along normally routed paths for a particular interface.</p>
Step 8	<p><b>no keepalive</b></p> <p><b>Example:</b> Router(config-if)# no keepalive</p>	<p>Disables keepalive packets.</p>
Step 9	<p><b>ppp pfc local request</b></p> <p><b>Example:</b> Router(config-if)# ppp pfc local request</p>	<p>Configures protocol field compression (PFC) in configuration requests.</p>
Step 10	<p><b>ppp pfc remote apply</b></p> <p><b>Example:</b> Router(config-if)# ppp pfc remote apply</p>	<p>Configures how the PFC option in configuration requests is received from a remote peer.</p>
Step 11	<p><b>ppp multilink</b></p> <p><b>Example:</b> Router(config-if)# ppp multilink</p>	<p>Enables Multilink PPP on an interface.</p>
Step 12	<p><b>ppp multilink group</b> <i>group-number</i></p> <p><b>Example:</b> Router(config-if)# ppp multilink group 2</p>	<p>Restricts a physical link to join only one designated multilink group interface.</p> <ul style="list-style-type: none"> <li><i>group-number</i>—Multilink-group number (a nonzero number).</li> </ul>

	Command	Purpose
Step 13	<pre>ppp multilink endpoint string char-string</pre> <p><b>Example:</b> Router(config-if)# ppp multilink endpoint string 22</p>	<p>Restricts a physical link to join only one designated multilink group interface.</p> <ul style="list-style-type: none"> <li><i>char-string</i>—Character string.</li> </ul>
Step 14	<pre>exit</pre> <p><b>Example:</b> Router(config)# exit</p>	<p>Exits interface configuration mode.</p>
Step 15	<pre>router ospf process-id [vrf vrf-name]</pre> <p><b>Example:</b> Router(config)# router ospf 1234</p>	<p>Configures an OSPF routing process and enters the router configuration mode.</p> <ul style="list-style-type: none"> <li><i>process-id</i>—Internally used identification parameter for an OSPF routing process. It is locally assigned and can be any positive integer. A unique value is assigned for each OSPF routing process.</li> </ul>
Step 16	<pre>network ip-address wildcard-mask area area-id</pre> <p><b>Example:</b> Router(config-router)# network 6.6.6.6 0.0.0.0 area 2</p>	<p>Configures the interfaces on which OSPF runs and to define the area ID for those interfaces.</p> <ul style="list-style-type: none"> <li><i>ip-address</i>—IP address.</li> <li><i>wildcard-mask</i>—IP-address-type mask that includes optional bits.</li> <li><i>area-id</i>—Area that is to be associated with the OSPF address range. It can be specified as either a decimal value or as an IP address. If you intend to associate areas with IP subnets, you can specify a subnet address as the value of the <i>area-id</i> argument.</li> </ul> <p><b>Note</b> Repeat this step to configure different interfaces on which OSPF runs, and to define the area ID for those interfaces.</p>
Step 17	<pre>exit</pre> <p><b>Example:</b> Router(config-router)# exit</p>	<p>Exits the router configuration mode.</p>

## Configuration Examples for MPLS over MLPPP

The following example shows a sample configuration of MPLS over MLPPP for OSPF.

Building configuration...

```
Current configuration : 234 bytes
!
interface Multilink2
ip address 11.11.11.2 255.255.255.0
ip ospf 1234 area 0
ip ospf authentication null
mpls ip
no keepalive
ppp pfc local request
ppp pfc remote apply
ppp multilink
ppp multilink group 2
ppp multilink endpoint string 22
```

```

router ospf 1234
network 6.6.6.6 0.0.0.0 area 2
network 11.11.11.0 0.0.0.255 area 0
network 12.12.12.0 0.0.0.255 area 2

```

The following example shows a sample configuration of MPLS over MLPPP for a Serial Interface.

```

Building configuration...

Current configuration : 101 bytes
!
interface Serial0/0:0
no ip address
encapsulation ppp
ppp multilink
ppp multilink group 2

```

## Verifying MPLS over MLPPP Configuration

To verify the configuration of MPLS over MLPPP, use the following commands as shown in the examples below:

```
Router# ping mpls ipv4 6.6.6.6/32
```

```

Sending 5, 100-byte MPLS Echos to 6.6.6.6/32,
  timeout is 2 seconds, send interval is 0 msec:

```

```

Codes: '!' - success, 'Q' - request not sent, '.' - timeout,
'L' - labeled output interface, 'B' - unlabeled output interface,
'D' - DS Map mismatch, 'F' - no FEC mapping, 'f' - FEC mismatch,
'M' - malformed request, 'm' - unsupported tlvs, 'N' - no label entry,
'P' - no rx intf label prot, 'p' - premature termination of LSP,
'R' - transit router, 'I' - unknown upstream index,
'l' - Label switched with FEC change, 'd' - see DDMAP for return code,
'X' - unknown return code, 'x' - return code 0

```

```
Type escape sequence to abort.
```

```
!!!!
```

```

Success rate is 100 percent (5/5), round-trip min/avg/max = 4/5/8 ms
Total Time Elapsed 40 ms

```

```
Router# show mpls ldp bindings 6.6.6.6 32
```

```

lib entry: 6.6.6.6/32, rev 8
  local binding:  label: 17
  remote binding: lsr: 6.6.6.6:0, label: imp-null

```

```
Router# traceroute mpls ipv4 6.6.6.6/32
```

```
Tracing MPLS Label Switched Path to 6.6.6.6/32, timeout is 2 seconds
```

```

Codes: '!' - success, 'Q' - request not sent, '.' - timeout,
'L' - labeled output interface, 'B' - unlabeled output interface,
'D' - DS Map mismatch, 'F' - no FEC mapping, 'f' - FEC mismatch,
'M' - malformed request, 'm' - unsupported tlvs, 'N' - no label entry,
'P' - no rx intf label prot, 'p' - premature termination of LSP,

```

```
'R' - transit router, 'I' - unknown upstream index,  
'l' - Label switched with FEC change, 'd' - see DDMAP for return code,  
'X' - unknown return code, 'x' - return code 0
```

Type escape sequence to abort.

```
0 11.11.11.1 MRU 1500 [Labels: implicit-null Exp: 0]  
! 1 11.11.11.2 4 ms
```



# Additional References

The following sections provide references related to MLPPP feature.

## Related Documents

Related Topic	Document Title
Cisco IOS Commands	<i>Cisco IOS Master Commands List, All Releases</i>
ASR 901 Commands	<i>Cisco ASR 901 Series Aggregation Services Router Command Reference</i>
Cisco IOS Dial Technologies Configuration Guide	<i>Configuring Media-Independent PPP and Multilink PPP</i>
MPLS over MLPPP	<i>MPLS—Multilink PPP Support</i>

## Standards

Standard	Title
None	—

## MIBs

MIB	MIBs Link
None	To locate and download MIBs for selected platforms, Cisco IOS releases, and feature sets, use Cisco MIB Locator found at the following URL: <a href="http://www.cisco.com/go/mibs">http://www.cisco.com/go/mibs</a>

## RFCs

RFC	Title
None	—

## Technical Assistance

Description	Link
The Cisco Technical Support website contains thousands of pages of searchable technical content, including links to products, technologies, solutions, technical tips, and tools. Registered Cisco.com users can log in from this page to access even more content.	<a href="http://www.cisco.com/techsupport">http://www.cisco.com/techsupport</a>

# Feature Information for MLPPP

Table 1 lists the features in this module and provides links to specific configuration information.

Use Cisco Feature Navigator to find information about platform support and software image support. Cisco Feature Navigator enables you to determine which software images support a specific software release, feature set, or platform. To access Cisco Feature Navigator, go to <http://www.cisco.com/go/cfn>. An account on Cisco.com is not required.

**Note**

Table 1 lists only the software release that introduced support for a given feature in a given software release train. Unless noted otherwise, subsequent releases of that software release train also support that feature.

**Table 1** Feature Information for MLPPP

Feature Name	Releases	Feature Information
MPLS over MLPPP	15.2(2)SNI	<p>This feature was introduced on the Cisco ASR 901 routers.</p> <p>The following sections provide information about this feature:</p> <ul style="list-style-type: none"> <li>• <a href="#">MPLS over MLPPP, page 25-3</a></li> <li>• <a href="#">Configuring MPLS over the MLPPP on a Serial Interface, page 25-14</a></li> <li>• <a href="#">Configuring MPLS over MLPPP for OSPF, page 25-16</a></li> </ul>



## Onboard Failure Logging

---

Onboard Failure Logging (OBFL) captures and stores hardware failure and environmental information into nonvolatile memory. OBFL permits improved accuracy in hardware troubleshooting and root cause isolation analysis. Stored OBFL data can be retrieved in the event of a router crash or failure.

### Contents

- [Understanding OBFL, page 26-1](#)
- [Configuring OBFL, page 26-2](#)
- [Verifying OBFL Configuration, page 26-2](#)

### Understanding OBFL

OBFL provides a mechanism to store hardware, software, and environment related critical data in a non-volatile memory, such as flash EPROM or EEPROM on routers. The logging information is used by the TAC team to troubleshoot and fix hardware issues.

OBFL collects data like temperatures and voltages. It stores the data in a dedicated area of the flash memory of the router. This data is retrieved by TAC personnel to troubleshoot routers. It can also be analyzed by back-end software to detect failure patterns, and possibly to recommend specific quality improvements.

#### Retrieval of the OBFL message

If the hardware is defective and the system cannot boot up, any data in flash is inaccessible. In that case, use any one of the following methods to recover OBFL data:

- Read the flash through JTAG: this requires provisions in hardware design and back-end hardware and software support tools.
- Repair the system; boot it; use the OBFL CLI commands.

#### Recording OBFL Messages

Data is recorded in any of the following formats:

- Continuous information that displays a snapshot of measurements.
- Samples in a continuous file, and summary information about the data being collected.

## Configuring OBFL

Use the following commands to configure and verify OBFL:

Command	Purpose
<pre>Router(conf)# <b>hw-module</b> {all/slot/module} {slotnumber/subslotnumber/modulenumber} <b>logging onboard</b></pre> <p><b>Example:</b>  <pre>Router(conf)# <b>hw-module</b> module 0 <b>logging</b> <b>onboard</b></pre></p>	<p>Enables OBFL on the specified hardware module. The <b>no</b> form of the command disables OBFL.</p>
<pre>Router&gt; <b>show logging onboard</b> {slot module} {slotnumber/subslotnumber/modulenumber} [<b>status</b>]</pre>	<p>Shows the status of OBFL logging. OBFL is enabled by default in Cisco ASR 901.</p>
<pre>Router(conf)# <b>clear logging onboard</b></pre>	<p>Clears OBFL logging.</p>

## Verifying OBFL Configuration

### Example 1

```
Router# show logging onboard status
Devices registered with infra
Slot no.: 0 Subslot no.: 0, Device obfl0:
Application name cliilog :
Path : obfl0:
CLI enable status : enabled
Platform enable status: enabled
Application name temperature :
Path : obfl0:
CLI enable status : enabled
Platform enable status: enabled
```

### Example 2

```
Router # show logging onboard temperature ?
continuous Onboard logging continuous information
detail Onboard logging detailed information
end ending time and date
raw Onboard logging raw information
start starting time and date
status Onboard logging status information
summary Onboard logging summary information
```

```
Router# show logging onboard temperature continuous
```

```
-----
TEMPERATURE CONTINUOUS INFORMATION
-----
```

```
Sensor | ID |
-----
```

```
System 1
-----
```

```

Time Stamp |Sensor Temperature 0C
MM/DD/YYYY HH:MM:SS | 1
-----
03/01/2000 00:06:02 37
03/01/2000 00:16:02 37
03/01/2000 00:05:57 36
Router# show logging onboard voltage continuous
-----
VOLTAGE CONTINUOUS INFORMATION
-----
Sensor | ID |
-----
12.00VA 0
1.50V 1
1.25V 2
12.00VB 3
2.50V 4
1.05V 5
1.20V 6
1.80V 7
-----
Time Stamp |Sensor Voltage
MM/DD/YYYY HH:MM:SS | 12.00VA 1.50V 1.25V 12.00VB 2.50V 1.05V 1.20V
1.80V
-----
02/24/2000 21:41:58 11.764 1.176 1.176 7.843 2.352 0.784 1.176
1.568
02/24/2000 21:46:00 11.764 1.176 1.176 7.843 2.352 0.784 1.176
1.568
02/25/2000 14:29:53 11.764 1.176 1.176 7.843 2.352 0.784 1.176
1.568
02/25/2000 14:33:54 11.764 1.176 1.176 7.843 2.352 0.784 1.176
1.568

Router# sh logging onboard cliilog summary
-----
CLI LOGGING SUMMARY INFORMATION
-----
COUNT COMMAND
-----
1 clear logging onboard
2 hw-module module 0 logging onboard message level 1
1 hw-module module 0 logging onboard message level 2
5 hw-module module 0 logging onboard message level 3
2 no hw-module module 0 logging onboard message level
5 show logging onboard
2 show logging onboard cliilog
2 show logging onboard cliilog continuous
1 show logging onboard cliilog summary
2 show logging onboard continuous
1 show logging onboard environment
9 show logging onboard message
9 show logging onboard message continuous
1 show logging onboard message summary
3 show logging onboard status
1 show logging onboard temperature
1 show logging onboard voltage

```

```
1 test logging onboard error 3
1 test logging onboard error1 3
1 test logging onboard try 1
```

-----



# Hot Standby Router Protocol and Virtual Router Redundancy Protocol

---

This feature module describes the HOT Standby Router Protocol(HSRP) and Virtual Router Redundancy Protocol(VRRP) features. The Hot Standby Router Protocol (HSRP) is a First Hop Redundancy Protocol (FHRP) designed to allow transparent fail-over of the first-hop IP router. HSRP provides high network availability by providing first-hop routing redundancy for IP hosts on Ethernet, Fiber Distributed Data Interface (FDDI), Bridge-Group Virtual Interface (BVI), LAN Emulation (LANE), or Token Ring networks configured with a default gateway IP address. HSRP is used in a group of routers for selecting an active router and a standby router.

The Virtual Router Redundancy Protocol (VRRP) eliminates the single point of failure inherent in the static default routed environment . VRRP is not an election protocol in itself; rather it specifies an election protocol that dynamically assigns responsibility for a virtual router.

## Finding Feature Information

Your software release may not support all the features documented in this module. For the latest feature information and caveats, see the release notes for your platform and software release. To find information about the features documented in this module, and to see a list of the releases in which each feature is supported, see the [“Feature Information for HSRP and VRRP” section on page 27-11](#).

Use Cisco Feature Navigator to find information about platform support and Cisco software image support. To access Cisco Feature Navigator, go to <http://www.cisco.com/go/cfn>. An account on Cisco.com is not required.

## Contents

- [Information About HSRP and VRRP, page 27-2](#)
- [How to Configure HSRP, page 27-3](#)
- [Configuration Examples for HSRP, page 27-5](#)
- [How to Configure VRRP, page 27-6](#)
- [Configuration Examples for VRRP, page 27-8](#)
- [Where to Go Next](#)
- [Additional References, page 27-9](#)

- [Feature Information for HSRP and VRRP, page 27-11](#)

## Information About HSRP and VRRP

- [Overview of HSRP and VRRP](#)
- [Text Authentication](#)
- [Preemption](#)

## Overview of HSRP and VRRP

HSRP provides network redundancy for IP networks, which helps maximum network uptime. By sharing an IP address and a MAC (Layer 2) address, two or more routers can act as a single virtual router. The members of the virtual router group continuously exchange status messages. This way, one router can assume the routing responsibility of another, should it go out of commission for either planned or unplanned reasons. Hosts continue to forward IP packets to a consistent IP and MAC address, and the changeover of devices doing the routing is transparent.

A VRRP router is configured to run the VRRP protocol in conjunction with one or more other routers attached to a LAN. In a VRRP configuration, one router is elected as the virtual router master, with the other routers acting as backups in case the virtual router master fails. VRRP enables you to configure multiple routers as the default gateway router, which reduces the possibility of a single point of failure in a network. You can configure VRRP in such a way that traffic to and from LAN clients can be shared by multiple routers, to balance the load on available routers.

## Text Authentication

HSRP and VRRP ignore unauthenticated protocol messages. The default authentication type is text authentication. HSRP or VRRP authentication protects against false hello packets causing a denial-of-service attack. For example, Router A has a priority of 120 and is the active router. If a host sends spoof hello packets with a priority of 130, then Router A stops being the active router. If Router A has authentication configured such that the spoof hello packets are ignored, Router A will remain the active router. Packets will be rejected in any of the following cases:

- The authentication schemes differ on the router and in the incoming packets.
- Text authentication strings differ on the router and in the incoming packets.

## Preemption

Preemption occurs when a virtual router backup with a higher priority takes over a virtual router backup that was elected to become a virtual router master and a preemptive scheme is enabled automatically. When a newly reloaded router becomes active, despite an active router already existent on the network, it may appear that preemption is not functioning but it is not true. The new active router did not receive any hello packets from the current active router, and the preemption configuration never factored into the new routers decision making.

In general, we recommend that all HSRP routers have the following configuration:

```
standby delay minimum 30 reload 60
```



The **standby delay minimum reload** interface configuration command delays HSRP groups from initializing for the specified time after the interface comes up.

This command is different from the **standby preempt delay** interface configuration command, which enables HSRP preemption delay. You can disable the preemptive scheme by using the **no vrrp preempt** command. If preemption is disabled, the virtual router backup that is elected to become virtual router master remains the master until the original virtual router master recovers and becomes master again.

## How to Configure HSRP

This section contains the following procedures:

- [Configuring HSRP](#)
- [Configuration Examples for HSRP](#)

## Configuring HSRP

Complete the following steps to configure HSRP:

### Restrictions

- HSRP is supported only on IPv4 devices and not on IPv6 devices.
- HSRP is supported only gigabyte etherchannel interfaces of the Layer 3 SVI.
- Bidirectional Forwarding Detection (BFD) protocol is not supported.

### SUMMARY STEPS

1. **enable**
2. **configure terminal**
3. **interface** *type number*
4. **standby** [*group-number*] **ip** [*ip-address mask*] [**secondary**]
5. **standby** [*group-number*] **timers** [**msec**] *hellotime* [**msec**] *holdtime*
6. **standby** [*group-number*] **preempt** [**delay** {*minimum delay* | *reload delay* | *sync delay*}]
7. **standby** [*group-number*] **priority** *priority*
8. **standby** [*group-number*] **authentication text** *string*
9. **standby** [*group-number*] **track** *object-number* [*decrement priority-decrement*]
10. **end**

## DETAILED STEPS

	Command or Action	Purpose
Step 1	<b>enable</b>  <b>Example:</b> Router> enable	Enables privileged EXEC mode. <ul style="list-style-type: none"><li>Enter your password if prompted.</li></ul>
Step 2	<b>configure terminal</b>  <b>Example:</b> Router# configure terminal	Enters global configuration mode.
Step 3	<b>interface</b> <i>type number</i>  <b>Example:</b> Router(config)# interface Ethernet0/1	Configures an interface type and enters interface configuration mode.
Step 4	<b>ip address</b> <i>ip-address mask [secondary]</i>  <b>Example:</b> Router(config-if)# ip address 10.0.0.1 255.255.255.0	Specifies an primary or secondary IP address for an interface.
Step 5	<b>standby</b> [ <i>group-number</i> ] <b>timers</b> [ <i>msec</i> ] <i>hellotime</i> [ <i>msec</i> ] <i>holdtime</i>  <b>Example:</b> Router(config-if)# standby 1 timers 14	Configures the interval at which packets are sent to refresh the MAC cache when HSRP is running.
Step 6	<b>standby</b> [ <i>group-number</i> ] <b>preempt</b> [ <i>delay {minimum delay   reload delay   sync delay}</i> ]  <b>Example:</b> Router(config-if)# standby 1 preempt delay minimum 380	Configures preemption and preemption delay.
Step 7	<b>standby</b> [ <i>group-number</i> ] <b>priority</b> <i>priority</i>  <b>Example:</b> Router(config-if)# standby 1 priority 110	Configures HSRP priority.
Step 8	<b>standby</b> [ <i>group-number</i> ] <b>authentication text</b> <i>string</i>  <b>Example:</b> Router(config-if)# standby 1 authentication text authentication1	Configures an authentication string for HSRP text authentication.

	Command or Action	Purpose
Step 9	<b>standby</b> [ <i>group-number</i> ] <b>track</b> <i>object-number</i> [ <i>decrement priority-decrement</i> ]  <b>Example:</b> Router(config-if)# standby 1 track 100 decrement 20	Configures HSRP to track an object and change the Hot Standby priority on the basis of the state of the object.
Step 10	<b>end</b>  <b>Example:</b> Router(config-if)# end	Returns to privileged EXEC mode.

## Configuration Examples for HSRP

This section provides the following configuration examples:

- [Example: Configuring HSRP Active Router](#)
- [Example: Configuring HSRP Backup Router](#)
- [Example: HSRP Text Authentication](#)

### Example: Configuring HSRP Active Router

```
Router# configure terminal
Router(config)# interface GigabitEthernet0/1
Router(config-if)# service instance 1 ethernet
Router(config-if-srv)# encapsulation dot1q 10
Router(config-if-srv)# rewrite ingress tag pop 1 symmetric
Router(config-if-srv)# bridge-domain 10
Router(config-if-srv)# end

Router# configure terminal
Router(config)# interface Vlan10
Router(config-if)# ip address 10.10.10.21 255.255.255.0
Router(config-if)# standby 1 ip 10.10.10.20
Router(config-if)# standby 1 timers 1 4
Router(config-if)# standby 1 priority 105
Router(config-if)# standby 1 preempt delay minimum 10
Router(config-if)# standby 1 authentication cisco6
Router(config-if)# standby 1 track 1 decrement 20
Router(config-if)# end
```

### Example: Configuring HSRP Backup Router

```
Router# configure terminal
Router(config)# interface GigabitEthernet0/1
Router(config-if)# service instance 1 ethernet
Router(config-if-srv)# encapsulation dot1q 10
Router(config-if-srv)# rewrite ingress tag pop 1 symmetric
Router(config-if-srv)# bridge-domain 10
Router(config-if-srv)# end
```

```

Router# configure terminal
Router(config)# interface Vlan10
Router(config-if)# ip address 10.10.10.22 255.255.255.0
Router(config-if)# standby 1 ip 10.10.10.20
Router(config-if)# standby 1 timers 1 4
Router(config-if)# standby 1 priority 90
Router(config-if)# standby 1 preempt delay minimum 10
Router(config-if)# standby 1 authentication cisco6
Router(config-if)# standby 1 track 1 decrement 20
Router(config-if)# end

```

## Example: HSRP Text Authentication

The following example shows how to configure HSRP text authentication using a text string:

```

Router# configure terminal
Router(config)# interface Ethernet0/1
Router(config-if)# standby 1 priority 110
Router(config-if)# standby 1 preempt
Router(config-if)# standby 1 authentication text company2
Router(config-if)# standby 1 ip 10.21.0.10

```

## How to Configure VRRP

This section contains the following procedures:

- [Configuring VRRP](#)
- [Configuration Examples for VRRP](#)

## Configuring VRRP

Complete the following steps to configure VRRP:

### Restrictions

- VRRP is supported only on IPv4 devices and not IPv6 devices.
- VRRP is supported only on gigabyte etherchannel interfaces of the Layer 3 SVI.
- Bidirectional Forwarding Detection (BFD) protocol is not supported.
- MD5 authentication is not supported.

### SUMMARY STEPS

1. **enable**
2. **configure terminal**
3. **interface** *type number*
4. **ip** *ip-address mask*
5. **vrrp** [*group-number*] **timers advertise** [*msec*] *interval*
6. **vrrp** [*group-number*] **preempt** [*delay minimum seconds*]

7. **vrrp** [*group-number*] **priority** *level*
8. **vrrp** [*group-number*] **authentication text** *string*
9. **vrrp** [*group-number*] **track** *object-number* [*decrement priority-decrement*]
10. **end**

## DETAILED STEPS

	Command or Action	Purpose
Step 1	<b>enable</b>  <b>Example:</b> Router> enable	Enables privileged EXEC mode. <ul style="list-style-type: none"> <li>• Enter your password if prompted.</li> </ul>
Step 2	<b>configure terminal</b>  <b>Example:</b> Router# configure terminal	Enters global configuration mode.
Step 3	<b>interface</b> <i>type number</i>  <b>Example:</b> Router(config)# interface Vlan10	Configures an interface type and enters interface configuration mode.
Step 4	<b>ip address</b> <i>ip-address mask</i>  <b>Example:</b> Router(config-if)# ip address 10.10.10.25 255.255.255.0	Specifies a primary or secondary IP address for an interface.
Step 5	<b>vrrp</b> [ <i>group-number</i> ] <b>timers advertise</b> [ <i>msec</i> ]  <b>Example:</b> Router(config-if)# vrrp 2 timers advertise 2	Configures the interval at which packets are sent to refresh the MAC cache when VRRP is running
Step 6	<b>vrrp</b> [ <i>group-number</i> ] <b>preempt</b> [ <b>delay minimum</b> <i>seconds</i> ]  <b>Example:</b> Router(config-if)# vrrp 2 preempt delay minimum 10	Configures preemption delay.
Step 7	<b>vrrp</b> [ <i>group-number</i> ] <b>priority</b> <i>priority</i>  <b>Example:</b> Router(config-if)# vrrp 2 priority 200	Configures VRRP priority.
Step 8	<b>vrrp</b> [ <i>group-number</i> ] <b>authentication text</b> <i>string</i>  <b>Example:</b> Router(config-if)# vrrp 2 authentication text cisco7	Configures an authentication string for VRRP text authentication.

	Command or Action	Purpose
Step 9	<b>vrrp</b> [group-number] <b>track</b> object-number [decrement priority-decrement]  <b>Example:</b> Router(config-if)# vrrp 2 track 1 decrement 20	Configures VRRP to track an object and change the Hot Standby priority on the basis of the state of the object.
Step 10	<b>end</b>  <b>Example:</b> Router(config-if)# end	Returns to privileged EXEC mode.

## Configuration Examples for VRRP

This section provides the following configuration examples:

- [Example: Configuring a VRRP Master Router](#)
- [Example: Configuring a VRRP Backup Router](#)
- [Example: VRRP Text Authentication](#)

### Example: Configuring a VRRP Master Router

This example shows how to configure a VRRP Master router.

```
Router# configure terminal
Router(config)# interface GigabitEthernet0/1
Router(config-if)# service instance 1 ethernet
Router(config-if-srv)# encapsulation dot1q 10
Router(config-if-srv)# rewrite ingress tag pop 1 symmetric
Router(config-if-srv)# bridge-domain 10
Router(config-if-srv)# end

Router# configure terminal
Router(config)# interface Vlan10
Router(config-if)# ip address 10.10.10.25 255.255.255.0
Router(config-if)# vrrp 2 ip 10.10.10.30
Router(config-if)# vrrp 2 timers advertise 2
Router(config-if)# vrrp 2 preempt delay minimum 10
Router(config-if)# vrrp 2 priority 110
Router(config-if)# vrrp 2 authentication text cisco7
Router(config-if)# vrrp 2 track 1 decrement 20
Router(config-if)# end
```

### Example: Configuring a VRRP Backup Router

```
Router# configure terminal
Router(config)# interface GigabitEthernet0/1
Router(config-if)# service instance 1 ethernet
Router(config-if-srv)# encapsulation dot1q 10
Router(config-if-srv)# rewrite ingress tag pop 1 symmetric
Router(config-if-srv)# bridge-domain 10
Router(config-if-srv)# end
```

```

Router# configure terminal
Router(config)# interface Vlan10
Router(config-if)# ip address 10.10.10.26 255.255.255.0
Router(config-if)# vrrp 2 ip 10.10.10.30
Router(config-if)# vrrp 2 timers advertise 2
Router(config-if)# vrrp 2 preempt delay minimum 10
Router(config-if)# vrrp 2 priority 90
Router(config-if)# vrrp 2 authentication text cisco7
Router(config-if)# vrrp 2 track 1 decrement 20
Router(config-if)# end

```

## Example: VRRP Text Authentication

The following example shows how to configure VRRP text authentication using a text string:

```

Router# configure terminal
Router(config)# interface GigabitEthernet 0/0/0
Router(config)# ip address 10.21.8.32 255.255.255.0
Router(config-if)# vrrp 10 authentication text stringxyz
Router(config-if)# vrrp 10 ip 10.21.8.10

```

## Where to Go Next

For additional information on configuring HSRP and VRRP, see the documentation listed in the “[Related Documents](#)” section on page 27-9.

## Additional References

### Related Documents

Related Topic	Document Title
Cisco IOS commands	<i>Cisco IOS Master Commands List, All Releases</i>
ASR 901 Command Reference	<i>Cisco ASR 901 Series Aggregation Services Router Command Reference</i>
Cisco IOS Interface and Hardware Component Commands	<i>Cisco IOS Interface and Hardware Component Command Reference</i>

### Standards

Standard	Title
None	—

## MIBs

MIB	MIBs Link
None	To locate and download MIBs for selected platforms, Cisco software releases, and feature sets, use Cisco MIB Locator found at the following URL: <a href="http://www.cisco.com/go/mibs">http://www.cisco.com/go/mibs</a>

## RFCs

RFC	Title
No new or modified RFCs are supported by this feature, and support for existing RFCs has not been modified by this feature.	

## Technical Assistance

Description	Link
The Cisco Support and Documentation website provides online resources to download documentation, software, and tools. Use these resources to install and configure the software and to troubleshoot and resolve technical issues with Cisco products and technologies. Access to most tools on the Cisco Support and Documentation website requires a Cisco.com user ID and password.	<a href="http://www.cisco.com/cisco/web/support/index.html">http://www.cisco.com/cisco/web/support/index.html</a>



# Feature Information for HSRP and VRRP

Table 1 lists the release history for this feature and provides links to specific configuration information.

Use Cisco Feature Navigator to find information about platform support and software image support. Cisco Feature Navigator enables you to determine which software images support a specific software release, feature set, or platform. To access Cisco Feature Navigator, go to <http://www.cisco.com/go/cfn>. An account on Cisco.com is not required.



**Note**

Table 1 lists only the software release that introduced support for a given feature in a given software release train. Unless noted otherwise, subsequent releases of that software release train also support that feature.

**Table 1** Feature Information for HSRP and VRRP

Feature Name	Releases	Feature Information
HSRP and VRRP	15.2(2)SNG	<p>The following sections provide information about this feature:</p> <ul style="list-style-type: none"> <li>• <a href="#">Overview of HSRP and VRRP</a></li> <li>• <a href="#">Text Authentication</a></li> <li>• <a href="#">Preemption</a></li> <li>• <a href="#">Configuring HSRP</a></li> <li>• <a href="#">Configuration Examples for HSRP</a></li> <li>• <a href="#">Configuring VRRP</a></li> <li>• <a href="#">Configuration Examples for VRRP</a></li> </ul>





## Configuring Link Layer Discovery Protocol

---

This feature module describes how to configure Link Layer Discovery Protocol (LLDP) on the Cisco ASR 901 Aggregation Series Router. The Cisco Discovery Protocol (CDP) is a device discovery protocol that runs over the data-link layer (Layer 2) on all Cisco-manufactured devices (routers, bridges, access servers, and switches). CDP allows network management applications to automatically discover and learn about other Cisco devices that are connected to the network.

To permit the discovery of non-Cisco devices, Cisco ASR 901 supports LLDP, a vendor-neutral device discovery protocol that is defined in the IEEE 802.1ab standard. LLDP allows network devices to advertise information about themselves to other devices on the network.

### Finding Feature Information

Your software release may not support all the features documented in this module. For the latest feature information and caveats, see the release notes for your platform and software release. To find information about the features documented in this module, and to see a list of the releases in which each feature is supported, see the [“Feature Information for LLDP” section on page 28-8](#).

Use Cisco Feature Navigator to find information about platform support and Cisco software image support. To access Cisco Feature Navigator, go to <http://www.cisco.com/go/cfn>. An account on Cisco.com is not required.

### Contents

- [Restrictions for LLDP, page 28-2](#)
- [Overview of LLDP, page 28-2](#)
- [How to Configure LLDP, page 28-2](#)
- [Configuration Example for LLDP, page 28-4](#)
- [Where to Go Next](#)
- [Additional References, page 28-7](#)
- [Feature Information for LLDP, page 28-8](#)

## Restrictions for LLDP

The following are the restrictions for LLDP:

- The memory available on a given end network device dictates the number of neighbor entries recorded. However, under most operating conditions, end devices such as printers, IP phones, workstations and so on, are typically operated in the receive mode only.
- If Entity MIB are used for LLDP broadcast, such as to create a sender ID. LLDP can be configured only when these MIBs are available.

## Overview of LLDP

It is an optional element of a protocol stack in the 802 LAN station. LLDP uses the logical link control (LLC) services to transmit and receive information to and from other LLDP agents. LLC provides a Link Service Access Point (LSAP) for access to LLDP. Each LLDP frame is transmitted as a single MAC service request. Each incoming LLDP frame is received at the MAC Service Access Point (MSAP) by the LLC entity as a MAC service indication.

The LLDP protocol operates through the LLDP agent. The tasks of the LLDP agent are to:

- Collect information from the LLDP local system MIB and transmit it periodically.
- Receive LLDP frames from neighbors and populate LLDP remote devices MIBs.

LLDP supports a set of attributes used to find the neighbor devices. These attributes are type, length, and value descriptions of devices, and are referred to as Type Length Value (TLV). LLDP supported devices use TLVs to send and receive information from their neighbors. Details such as configuration information, device capabilities, and device identity are also advertised using this protocol.

## How to Configure LLDP

This section contains the following procedures:

- [Configuring LLDP](#)
- [Verifying LLDP](#)

## Configuring LLDP

Complete the following steps to configure LLDP on the Cisco ASR 901 platform:

### SUMMARY STEPS

1. **enable**
2. **configure terminal**
3. **lldp {run | holdtime *seconds* | reinit | timer *rate* | tlv-select}**
4. **end**

## DETAILED STEPS

	Command or Action	Purpose
Step 1	<p><b>enable</b></p> <p><b>Example:</b> Router&gt; enable</p>	<p>Enables privileged EXEC mode.</p> <p>Enter your password if prompted.</p>
Step 2	<p><b>configure terminal</b></p> <p><b>Example:</b> Router# configure terminal</p>	<p>Enters global configuration mode.</p>
Step 3	<p><b>lldp run</b></p> <p><b>Example:</b> Router(config)# lldp run or</p> <p><b>lldp holdtime</b> seconds</p> <p><b>Example:</b> Router(config)# lldp holdtime 100 or</p> <p><b>lldp reinit</b></p> <p><b>Example:</b> Router(config)# lldp reinit 2 or</p> <p><b>lldp timer</b> rate</p> <p><b>Example:</b> Router(config)# lldp timer 75 or</p> <p><b>lldp tlv-select</b></p> <p><b>Example:</b> Router(config-if)# lldp tlv-select system-description</p>	<p>Enables LLDP globally on all the interfaces on the router.</p> <hr/> <p>Specifies the hold time. The value ranges from 0 to 65535 seconds. The default value is 120 seconds.</p> <hr/> <p>Specifies the delay time in seconds for LLDP to initialize on any interface.</p> <p>The value ranges from 2 to 5 seconds. The default value is 2 seconds.</p> <hr/> <p>Specifies the rate at which LLDP packets are sent. The value ranges from 5 to 65534 seconds. The default value is 30 seconds.</p> <hr/> <p>Enables a specific LLDP TLV on a supported interface. Cisco ASR 901 LLDP supports the following TLVs:</p> <ul style="list-style-type: none"> <li>• Port Description—Information about the interface that includes the name of the manufacturer, product name, and the version of the interface.</li> <li>• System Description—Textual description of the device.</li> <li>• System Name—Assigned name of the device.</li> <li>• System Capabilities—Capability of the device and its primary function.</li> <li>• Management Address—IP or MAC address of the device.</li> </ul>
Step 4	<p><b>end</b></p> <p><b>Example:</b> Router(config-if)# end</p>	<p>Returns the CLI to privileged EXEC mode.</p>

## Verifying LLDP

To verify LLDP on the Cisco ASR 901 router, use the **show** command as shown in the following example.

```
Router# show lldp ?
entry      Information for specific neighbor entry
errors     LLDP computational errors and overflows
interface  LLDP interface status and configuration
neighbors  LLDP neighbor entries
traffic    LLDP statistics
|         Output modifiers
<cr>

Router# show lldp entry *
Capability codes:
(R) Router, (B) Bridge, (T) Telephone, (C) DOCSIS Cable Device
(W) WLAN Access Point, (P) Repeater, (S) Station, (O) Other
```

## Configuration Example for LLDP

This section provides the following configuration examples:

- [Example: Enabling LLDP Globally](#)
- [Example: Configuring Hold Time](#)
- [Example: Configuring Delay Time](#)
- [Example: Configuring Intervals](#)

### Example: Enabling LLDP Globally

```
Router> enable
Router# configure terminal
Router(config)# lldp run
Router(config)# end
```

### Example: Configuring Hold Time

```
Router> enable
Router# configure terminal
Router(config)# lldp holdtime 100
Router(config)# end
```

## Example: Configuring Delay Time

```
Router> enable
Router# configure terminal
Router(config)# lldp reinit 2
Router(config)# end
```

## Example: Configuring Intervals

```
Router> enable
Router# configure terminal
Router(config)# lldp timer 75
Router(config)# end
```

This is an example to enable an LLDP TLV on a supported interface:

```
Router> enable
Router# configure terminal
Router(config)# interface ethernet 0/1
Router(config-if)# lldp tlv-select system-description
Router(config-if)# end
```

## Where to Go Next

For additional information on configuring LLDP, see the documentation listed in the [“Related Documents”](#) section on page 28-7.



# Additional References

## Related Documents

Related Topic	Document Title
Cisco IOS commands	Cisco IOS Master Commands List, All Releases
ASR 901 Command Reference	<i>Cisco ASR 901 Series Aggregation Services Router Command Reference</i>
Cisco IOS Interface and Hardware Component Commands	<i>Cisco IOS Interface and Hardware Component Command Reference</i>

## Standards

Standard	Title
None	—

## MIBs

MIB	MIBs Link
None	To locate and download MIBs for selected platforms, Cisco software releases, and feature sets, use Cisco MIB Locator found at the following URL: <a href="http://www.cisco.com/go/mibs">http://www.cisco.com/go/mibs</a>

## RFCs

RFC	Title
No new or modified RFCs are supported by this feature, and support for existing RFCs has not been modified by this feature.	

## Technical Assistance

Description	Link
The Cisco Support and Documentation website provides online resources to download documentation, software, and tools. Use these resources to install and configure the software and to troubleshoot and resolve technical issues with Cisco products and technologies. Access to most tools on the Cisco Support and Documentation website requires a Cisco.com user ID and password.	<a href="http://www.cisco.com/cisco/web/support/index.html">http://www.cisco.com/cisco/web/support/index.html</a>

## Feature Information for LLDP

LLDP is a one-way protocol that transmits information about the capabilities and current status of a device and its interfaces. LLDP devices use the protocol to solicit information only from other LLDP devices.

[Table 28-1](#) lists the release history for this feature and provides links to specific configuration information.

Use Cisco Feature Navigator to find information about platform support and software image support. Cisco Feature Navigator enables you to determine which software images support a specific software release, feature set, or platform. To access Cisco Feature Navigator, go to <http://www.cisco.com/go/cfn>. An account on Cisco.com is not required.



### Note

[Table 28-1](#) lists only the software release that introduced support for a given feature in a given software release train. Unless noted otherwise, subsequent releases of that software release train also support that feature.

**Table 28-1** Feature Information for LLDP

Feature Name	Releases	Feature Information
LLDP	12.2(2)SNG	See <a href="#">Overview of LLDP</a> for more information about this feature.



# Configuring Multihop Bidirectional Forwarding Detection

Cisco ASR 901 supports Bidirectional Forwarding Detection (BFD) on arbitrary paths, which can span multiple network hops. The multihop BFD feature provides subsecond forwarding failure detection for a destination with more than one hop and up to 255 hops. A multihop BFD session is set up between a unique source-destination address pair provided by the client. A session can be set up between two endpoints that have IP connectivity.

## Finding Feature Information

Your software release may not support all the features documented in this module. For the latest feature information and caveats, see the release notes for your platform and software release. To find information about the features documented in this module, and to see a list of the releases in which each feature is supported, see the “[Feature Information for Multihop BFD](#)” section on page 29-7.

Use Cisco Feature Navigator to find information about platform support and Cisco software image support. To access Cisco Feature Navigator, go to <http://www.cisco.com/go/cfn>. An account on Cisco.com is not required.

## Contents

- [Restrictions for Multihop BFD, page 29-2](#)
- [Information About Multihop BFD, page 29-2](#)
- [How to Configure Multihop BFD, page 29-2](#)
- [Configuration Examples for Multihop BFD, page 29-4](#)
- [Where to Go Next](#)
- [Additional References, page 29-6](#)
- [Feature Information for Multihop BFD, page 29-7](#)

## Restrictions for Multihop BFD

The following are the restrictions for multihop BFD:

- BFD does not support echo mode. You can configure sessions for minimum timer interval.
- The minimum guaranteed timer depends on the topology, scale, number of hops, and control plane processing. All the packets must reach the control plane since echo mode is not supported.
- Supports IPv4 deployments only.
- Authentication for multihop BFD is not enabled on Cisco ASR901 routers.

## Information About Multihop BFD

- [Overview of Multihop BFD, page 29-2](#)

## Overview of Multihop BFD

Cisco ASR 901 supports BFD on arbitrary paths, which can span multiple network hops. You must configure the **bfd-template** and **bfd map** commands to create a multihop template and associate it with one or more maps of destinations and associated timers. You can enable authentication and configure a key chain for multihop BFD sessions.

## How to Configure Multihop BFD

This section contains the following procedures:

- [Configuring Multihop BFD Template](#)
- [Configuring a Multihop BFD Map](#)

## Configuring Multihop BFD Template

Complete the following steps to create a multihop BFD template and configure BFD interval timers, authentication, and key chain:

### SUMMARY STEPS

1. **enable**
2. **configure terminal**
3. **bfd-template multihop** *template-name*
4. **interval min-tx** *milliseconds* **min-rx** *milliseconds* **multiplier** *multiplier-value*
5. **authentication** *authentication-type* **keychain** *keychain-name*
6. **end**

## DETAILED STEPS

	Command or Action	Purpose
Step 1	<b>enable</b>  <b>Example:</b> Router> enable	Enables privileged EXEC mode. <ul style="list-style-type: none"><li>• Enter your password if prompted.</li></ul>
Step 2	<b>configure terminal</b>  <b>Example:</b> Router# configure terminal	Enters global configuration mode.
Step 3	<b>bfd-template multi-hop</b> <i>template-name</i>  <b>Example:</b> Router(config)# bfd-template multi-hop mh-templatel	Creates a BFD multihop BFD template and enters BFD configuration mode.
Step 4	<b>interval min-tx</b> <i>milliseconds</i> <b>min-rx</b> <i>milliseconds</i> <b>multiplier</b> <i>multiplier-value</i>  <b>Example:</b> Router(bfd-config)# interval min-tx 120 min-rx 100 multiplier 3	Configures the transmit and receive intervals between BFD packets, and specifies the number of consecutive BFD control packets that must be missed before BFD declares that a peer is unavailable.
Step 5	<b>authentication</b> <i>authentication-type</i> <b>keychain</b> <i>keychain-name</i>  <b>Example:</b> Router(bfd-config)# authentication keyed-sha-1 keychain bfd-multihop	Configures authentication for the multihop template and the authentication type.
Step 6	<b>end</b>  <b>Example:</b> Router(bfd-config)# end	Returns the router to privileged EXEC mode.

## Configuring a Multihop BFD Map

After configuring the interval timers and authentication in a template, you must configure a map to associate the template with unique source-destination address pairs for multihop BFD sessions.

### SUMMARY STEPS

1. **enable**
2. **configure terminal**
3. **bfd mapipv4 vrf vrf-name destination-address/length source-address/length template-name**
4. **end**

### DETAILED STEPS

	Command or Action	Purpose
Step 1	<b>enable</b>  <b>Example:</b> Router> enable	Enables privileged EXEC mode. <ul style="list-style-type: none"> <li>• Enter your password if prompted.</li> </ul>
Step 2	<b>configure terminal</b>  <b>Example:</b> Router# configure terminal	Enters global configuration mode.
Step 3	<b>bfd mapipv4 vrf vrf-name destination-address/length source-address/length template-name</b>  <b>Example:</b> Router(config)# bfd-template multi-hop mh-templatel	Configures a BFD map and associates it with the template.
Step 4	<b>end</b>  <b>Example:</b> Router(config)# end	Returns the router to privileged EXEC mode.

## Configuration Examples for Multihop BFD

This section provides the configuration example for multihop BFD.

### Example : Configuring Multihop BFD

The following example shows how to configure BFD in a BGP network. In the following example, the simple BGP network consists of Router A and Router B. Fast Ethernet interface 0/1 on Router A is connected to the same network as Fast Ethernet interface 6/0 in Router B.

#### Configuration for Router A

```
!  
interface Fast Ethernet 0/1  
ip address 172.16.10.1 255.255.255.0  
bfd interval 50 min_rx 50 multiplier 3  
!  
interface Fast Ethernet 3/0.1  
ip address 172.17.0.1 255.255.255.0  
!  
!  
router bgp 40000  
bgp log-neighbor-changes  
neighbor 172.16.10.2 remote-as 45000  
neighbor 172.16.10.2 fall-over bfd  
!  
address-family ipv4  
neighbor 172.16.10.2 activate  
no auto-summary  
no synchronization  
network 172.18.0.0 mask 255.255.255.0  
exit-address-family  
!
```

### Configuration for Router B

```
!  
interface Fast Ethernet 6/0  
ip address 172.16.10.2 255.255.255.0  
bfd interval 50 min_rx 50 multiplier 3  
!  
interface Fast Ethernet 6/1  
ip address 172.18.0.1 255.255.255.0  
!  
router bgp 45000  
bgp log-neighbor-changes  
neighbor 172.16.10.1 remote-as 40000  
neighbor 172.16.10.1 fall-over bfd  
!  
  
address-family ipv4  
neighbor 172.16.10.1 activate  
no auto-summary  
no synchronization  
network 172.17.0.0 mask 255.255.255.0  
exit-address-family  
!
```

## Where to Go Next

For additional information on configuring Multihop BFD, see the documentation listed in the [“Related Documents”](#) section on page 29-6.

# Additional References

## Related Documents

Related Topic	Document Title
Cisco IOS commands	Cisco IOS Master Commands List, All Releases
ASR 901 Command Reference	<i>Cisco ASR 901 Series Aggregation Services Router Command Reference</i>
Cisco IOS Interface and Hardware Component Commands	<i>Cisco IOS Interface and Hardware Component Command Reference</i>

## Standards

Standard	Title
None	—

## MIBs

MIB	MIBs Link
None	To locate and download MIBs for selected platforms, Cisco software releases, and feature sets, use Cisco MIB Locator found at the following URL: <a href="http://www.cisco.com/go/mibs">http://www.cisco.com/go/mibs</a>

## RFCs

RFC	Title
No new or modified RFCs are supported by this feature, and support for existing RFCs has not been modified by this feature.	



## Technical Assistance

Description	Link
The Cisco Support and Documentation website provides online resources to download documentation, software, and tools. Use these resources to install and configure the software and to troubleshoot and resolve technical issues with Cisco products and technologies. Access to most tools on the Cisco Support and Documentation website requires a Cisco.com user ID and password.	<a href="http://www.cisco.com/cisco/web/support/index.html">http://www.cisco.com/cisco/web/support/index.html</a>

## Feature Information for Multihop BFD

Use Cisco Feature Navigator to find information about platform support and software image support. Cisco Feature Navigator enables you to determine which software images support a specific software release, feature set, or platform. To access Cisco Feature Navigator, go to <http://www.cisco.com/go/cfn>. An account on Cisco.com is not required.

[Table 29-1](#) lists the release history for this feature and provides links to specific configuration information.



### Note

[Table 29-1](#) lists only the software release that introduced support for a given feature in a given software release train. Unless noted otherwise, subsequent releases of that software release train also support that feature.

**Table 29-1** Feature Information for Multihop BFD

Feature Name	Releases	Feature Information
Multihop BFD	15.2(2)SNG	See the following links for more information about this feature: <ul style="list-style-type: none"> <li><a href="#">Restrictions for Multihop BFD</a></li> <li><a href="#">Configuring Multihop BFD Template</a></li> <li><a href="#">Configuring a Multihop BFD Map</a></li> <li><a href="#">Configuration Examples for Multihop BFD</a></li> </ul>





## Bit Error Rate Testing

---

This feature module describes how to configure a Bit Error Rate Test (BERT) and display the test results for channelized line cards in the Cisco ASR 901 Series Aggregation Services Routers.

### Finding Feature Information

Your software release may not support all the features documented in this module. For the latest feature information and caveats, see the release notes for your platform and software release. To find information about the features documented in this module, and to see a list of the releases in which each feature is supported, see the [“Feature Information for Bit Error Rate Testing” section on page 30-6](#).

Use Cisco Feature Navigator to find information about platform support and Cisco software image support. To access Cisco Feature Navigator, go to <http://www.cisco.com/go/cfn>. An account on Cisco.com is not required.

### Contents

- [Prerequisites, page 30-1](#)
- [Restrictions, page 30-2](#)
- [Feature Overview, page 30-2](#)
- [How to Configure BERT, page 30-2](#)
- [Configuration Examples, page 30-5](#)
- [Additional References, page 30-5](#)
- [Feature Information for Bit Error Rate Testing, page 30-6](#)

### Prerequisites

- To run BERT in unframed mode on a controller, you should set the “framing” configuration of the controller to “unframed”.
- When running BERT, your system expects to receive the same pattern that it is transmitting. If traffic is not being transmitted or received, create a back-to-back loopback BERT on the link or in the network, and send out a predictable stream to ensure that you receive the same data that was transmitted.

- To determine if the remote serial port returns the BERT pattern unchanged, you must manually enable network loopback at the remote serial port while you configure a BERT pattern to use in the test at specified time intervals on the local serial port.

## Restrictions

- BERT affects the functionality of any configured protocol on a controller on which it is initiated. The configured protocol functionality is resumed after the BERT process is completed or successfully aborted.
- BERT is not supported for channelized E1/T1 (per timeslot).

## Feature Overview

The BERT feature is used to test the integrity of the physical layer. Using this feature, you can test cables and diagnose signal problems in the field.

BERT generates a specific pattern on to the egress data stream of a E1/T1 controller and then analyzes the ingress data stream for the same pattern. The bits that do not match the expected pattern are counted as bit errors.

The bit error rate (BER) is determined by comparing the erroneous bits received with the total number of bits received. You can display and analyze the total number of error bits transmitted and the total number of bits received on the link. You can retrieve error statistics anytime during the BERT.

The ASR 901 router uses Pseudo-Random Binary Sequences (PRBSs) for the BERT. The following table lists the PRBSs supported on the ASR 901 routers.

**Table 30-1 BERT Pattern Supported in Cisco ASR 901 Routers**

BERT Pattern	Description
0's	Test pattern consisting of all 0's that is used to test line coding
1's	Test pattern consisting of all 1's that is used to test alternating line volt and repeaters
2 <sup>11</sup>	Pseudo-random repeating test pattern that consists of 2,048 bits
2 <sup>15</sup>	Pseudo-random repeating test pattern that consists of 32,767 bits
2 <sup>20</sup> QRSS	Pseudo-random repeating test pattern that consists of 1,048,575 bits
Alt 0's and 1's	Test pattern consisting of alternating 0's and 1's that is used to test the preamp and equalizer

## How to Configure BERT

The ASR 901 router supports BERT on all 16 E1/T1 controllers simultaneously. Additionally, you can abort an already initiated BERT.

This section describes how to configure and perform a BERT on E1/T1 controllers, and how to stop or verify the test:

- [Performing BERT on a T1/E1 Line, page 30-3](#) (Required)

- [Terminating BERT on a T1/E1 Controller, page 30-3](#) (Required)
- [Verifying BERT on a T1/E1 Controller, page 30-4](#) (Optional)

## Performing BERT on a T1/E1 Line

To enable BERT pattern on a T1 or E1 controller, perform the following steps.

### SUMMARY STEPS

1. **enable**
2. **configure terminal**
3. **controller {t1 | e1} slot/port**
4. **bert pattern pattern interval time**

### DETAILED STEPS

	Command	Purpose
Step 1	<b>enable</b>  <b>Example:</b> Router> enable	Enables privileged EXEC mode. <ul style="list-style-type: none"> <li>• Enter your password if prompted.</li> </ul>
Step 2	<b>configure terminal</b>  <b>Example:</b> Router# configure terminal	Enters global configuration mode.
Step 3	<b>controller {t1   e1} slot/port</b>  <b>Example:</b> Router(config)# controller T1 0/5	Selects a T1 or E1 controller and enters controller configuration mode.
Step 4	<b>bert pattern pattern interval time</b>  <b>Example:</b> Router(config-controller)# bert pattern 0s interval 30	Sends a BERT pattern through the T1 or E1 line for the specified time interval. <ul style="list-style-type: none"> <li>• <i>pattern</i>—Length of the repeating BERT test pattern. See <a href="#">Table 30-1</a> for allowed values.</li> <li>• <b>interval</b>—Specifies the duration of the BERT test, in minutes. The interval can be a value from 1 to 14400.</li> </ul>

## Terminating BERT on a T1/E1 Controller

### SUMMARY STEPS

1. **enable**
2. **configure terminal**
3. **controller {t1 | e1} slot/port**

#### 4. no bert pattern *pattern interval time*

### DETAILED STEPS

	Command	Purpose
Step 1	<code>enable</code>  <b>Example:</b> Router> enable	Enables privileged EXEC mode. <ul style="list-style-type: none"> <li>Enter your password if prompted.</li> </ul>
Step 2	<code>configure terminal</code>  <b>Example:</b> Router# configure terminal	Enters global configuration mode.
Step 3	<code>controller {t1   e1} slot/port</code>  <b>Example:</b> Router(config)# controller T1 0/5	Selects a T1 or E1 controller and enters controller configuration mode.
Step 4	<code>no bert pattern pattern interval time</code>  <b>Example:</b> Router(config-controller)# no bert pattern	Terminates the BER test running on the specified T1 or E1 line.

## Verifying BERT on a T1/E1 Controller

To verify that BERT is running on a T1/E1 controller, enter the **show controllers** command at any time during the test.

```
Router# show controllers e1 0/9
```

```
E1 0/9 is up.
Applique type is Channelized E1 - balanced
DSX1 BERT pattern : 2^15
DSX1 BERT sync : sync
DSX1 BERT sync count : 1
DSX1 BERT interval : 1
DSX1 BERT time remain : 49
DSX1 BERT total errs : 0
DSX1 BERT total k bits: 21068
DSX1 BERT errors (last): 0
DSX1 BERT k bits (last): 21068
Last clearing of BERT counters never
No alarms detected.
alarm-trigger is not set
Framing is crc4, Line Code is HDB3, Clock Source is Internal.
Data in current interval (68 seconds elapsed):
1 Line Code Violations, 0 Path Code Violations
0 Slip Secs, 0 Fr Loss Secs, 1 Line Err Secs, 1 Degraded Mins
0 Errored Secs, 0 Bursty Err Secs, 0 Severely Err Secs, 0 Unavail Secs
```

---

## Configuration Examples

The following is a sample configuration of the BERT feature.

```
Router#configure terminal
Enter configuration commands, one per line. End with CNTL/Z.
Router(config)#controller e1 0/9
Router(config-controller)#bert pattern 2^15 interval 1
```

## Additional References

The following sections provide references related to bit error rate testing.

## Related Documents

Related Topic	Document Title
Cisco IOS Commands	Cisco IOS Master Commands List, All Releases
ASR 901 Command Reference	<i>Cisco ASR 901 Series Aggregation Services Router Command Reference</i>
Cisco IOS Interface and Hardware Component Commands	<i>Cisco IOS Interface and Hardware Component Command Reference</i>

## Standards

Standard	Title
None	—

## MIBs

MIB	MIBs Link
None	To locate and download MIBs for selected platforms, Cisco IOS releases, and feature sets, use Cisco MIB Locator found at the following URL: <a href="http://www.cisco.com/go/mibs">http://www.cisco.com/go/mibs</a>

## RFCs

RFC	Title
None	—

## Technical Assistance

Description	Link
The Cisco Technical Support website contains thousands of pages of searchable technical content, including links to products, technologies, solutions, technical tips, and tools. Registered Cisco.com users can log in from this page to access even more content.	<a href="http://www.cisco.com/techsupport">http://www.cisco.com/techsupport</a>

# Feature Information for Bit Error Rate Testing

Table 30-2 lists the features in this module and provides links to specific configuration information.



Use Cisco Feature Navigator to find information about platform support and software image support. Cisco Feature Navigator enables you to determine which software images support a specific software release, feature set, or platform. To access Cisco Feature Navigator, go to <http://www.cisco.com/go/cfn>. An account on Cisco.com is not required.

**Note**

Table 30-2 lists only the software release that introduced support for a given feature in a given software release train. Unless noted otherwise, subsequent releases of that software release train also support that feature.

**Table 30-2** Feature Information for Bit Error Rate Testing

Feature Name	Releases	Feature Information
Bit Error Rate Testing	15.2(2)SNG	This feature was introduced.





# Microwave ACM Signaling and EEM Integration

---

This feature module describes the Microwave Adaptive Code Modulation (ACM) Signaling and Embedded Event Manager (EEM) integration, which enables the microwave radio transceivers to report link bandwidth information to an upstream Ethernet switch and take action on the signal degradation to provide optimal bandwidth.

## Finding Feature Information

Your software release may not support all the features documented in this module. For the latest feature information and caveats, see the release notes for your platform and software release. To find information about the features documented in this module, and to see a list of the releases in which each feature is supported, see the [“Feature Information for Microwave ACM Signaling and EEM Integration”](#) section on page 31-17.

Use Cisco Feature Navigator to find information about platform support and Cisco software image support. To access Cisco Feature Navigator, go to <http://www.cisco.com/go/cfn>. An account on Cisco.com is not required.

## Contents

- [Prerequisites, page 31-2](#)
- [Feature Overview, page 31-2](#)
- [How to Configure Microwave ACM Signaling and EEM Integration, page 31-4](#)
- [Configuration Examples for Microwave ACM Signaling and EEM Integration, page 31-11](#)
- [Additional References, page 31-16](#)
- [Feature Information for Microwave ACM Signaling and EEM Integration, page 31-17](#)

## Prerequisites

- The microwave transceiver in the network topology must support adaptive bandwidth modulation, and the microwave transceiver must support the Ethernet Connectivity Fault Management (CFM) extension for microwave devices as defined by Cisco.
- In a heterogeneous ring topology, all devices connected directly to the microwave transceiver must support signal degradation (SD) functions. Devices not connected directly to the microwave transceiver can be standard-compliant nodes or enhanced SD-capable nodes.
- In a homogeneous ring topology, all links must be microwave links and all devices must support microwave SD-based ring protection.
- A ring topology with multiple microwave links can experience a signal degradation condition on one or more of the microwave links. Only one signal degradation condition per ring instance is supported. This support is provided on a first-come, first-serve basis, per ring instance.
- The source MAC address must be a unique MAC address. It can be the MAC address of the Ethernet port or the Bridge.
- The destination MAC address must be set to the CCM multicast address for the associated maintenance level (a multicast address is used to avoid discovery of MAC addresses).
- The microwave transceiver in the network topology must support bandwidth vendor specific message (BW-VSM<sup>1</sup>).
- The BW-VSM may be sent untagged, or it may be transmitted with a configurable valid IEEE 802.1Q VLAN tag.
- The BW-VSM must be associated with maintenance level 0. The microwave equipment should allow the network operator to associate the message with a valid maintenance level in the range 0 to 7 per ITU-T Y.1731 / IEEE 802.1ag-2007.

## Feature Overview

Microwave links are often used in Ethernet access ring topologies and the bandwidth provided by the microwave link depends on environmental factors like fog, rain, and snow, which can drastically affect the bandwidth.

This feature relies on the Ethernet CFM to assess the environmental conditions on either end of the microwave link and automatically change the modulation to provide optimal bandwidth. The Ethernet CFM monitors the microwave link bandwidth, and when a link degradation is detected, notifies the router to take action on the degraded microwave link.

In IP/MPLS, the nodes are unaware of any changes to the bandwidth on the microwave link and the Gigabit Ethernet connection to the nodes remain constant. To ensure optimal routing and traffic transport across the access network, a mechanism has been implemented to notify the IP/MPLS access nodes of any ACM events on the microwave links. This enables microwave radio transceivers, which support ACM, to report link bandwidth information to an upstream Ethernet switch.

The vendor-specific message (VSM) in Y.1731 is used to notify Cisco routers of ACM events, and the bandwidth available on the microwave link. Acting on this information, the node can change the Hierarchical Quality of Service (H-QoS), adjust the Interior Gateway Protocol (IGP) metric of the link to the new capacity or remove the degraded link.

1. The BW-VSM is defined to report the available bandwidth information from the microwave radio to the Ethernet switch.

### H-QoS Policy Adjustment

H-QoS policy adjustment is the process of adjusting the egress H-QoS policy parameters on the IP/MPLS access node connected to the microwave link. This modifies the parent shaper rate to match the current bandwidth of the microwave link. It also adjusts the child class parameters to ensure correct priority and bandwidth-guaranteed traffic.

If the available bandwidth is less than the total bandwidth required by Expedited Forwarding (EF) and Assured Forwarding (AF) classes, the operator can choose to drop AF class traffic or remove the link from the service.

### IGP Metric Adjustment

The IP/MPLS access node can adjust the IGP metric on the microwave link to align it with the available bandwidth. This will trigger an IGP SPF recalculation, allowing the IGP to get the correct bandwidth for routing traffic.

### Link Removal

Link removal is the process of removing the microwave link from the IGP. This occurs when the bandwidth loss breaches the threshold set by the operator. It sets off the resiliency mechanisms in the network, and the degraded link is bypassed, resulting in minimal traffic loss. The degraded link is not brought administratively down. When it is up, the microwave equipment can signal to the access node about its status and usability.

## Benefits

- The IP/MPLS access network adapts intelligently to the microwave capacity change by:
  - optimizing routing
  - controlling congestion
  - enabling loss protection.
- Microwave ACM changes are signaled through a Y.1731 VSM to the IP/MPLS access node.
- The IP/MPLS access node adapts the IGP metric of the link to the new capacity.
- The IP/MPLS access node can change the H-QoS policy on the interface with the microwave system allowing EF traffic to survive.
- The IP/MPLS access node can remove a degraded link from SPF triggering a loss protection.

# How to Configure Microwave ACM Signaling and EEM Integration

This section describes how to configure Microwave ACM Signaling and EEM Integration:

- [Configuring Connectivity Fault Management, page 31-4](#) (Required)
- [Configuring EEP Applet Using CLIs, page 31-7](#) (Required)
- [Configuring Event Handler, page 31-9](#) (Required)
- [Verifying Microwave Microwave ACM Signaling and EEM Integration Configuration, page 31-10](#) (Optional)

## Configuring Connectivity Fault Management

To configure CFM between the microwave outdoor unit (ODU) and the router, complete the following steps:



### Note

For a ring topology, you should configure CFM between the microwave ODU and the router. You must configure two VLANs to the two microwave ODUs, to process the vendor specific message (VSM) and trigger the Embedded Event Manager (EEM).

### SUMMARY STEPS

1. **enable**
2. **configure terminal**
3. **ethernet cfm domain** *domain-name* **level** *level-id*
4. **service** *csi-id* **evc** *evc-name* **vlan** *vlan-id* **direction down**
5. **continuity-check**
6. **exit**
7. **ethernet evc** *evc-no*
8. **exit**
9. **interface** *type number*
10. **service instance** *id* **ethernet** *id*
11. **encapsulation dot1q** *vlan-id*
12. **rewrite ingress tag pop 1 symmetric**
13. **bridge-domain** *bridge-domain-id*
14. **exit**

## DETAILED STEPS

	Command	Purpose
Step 1	<b>enable</b>  <b>Example:</b> Router> enable	Enables privileged EXEC mode. <ul style="list-style-type: none"> <li>Enter your password if prompted.</li> </ul>
Step 2	<b>configure terminal</b>  <b>Example:</b> Router# configure terminal	Enters global configuration mode.
Step 3	<b>ethernet cfm domain</b> <i>domain-name</i> <b>level</b> <i>level-id</i>  <b>Example:</b> Router(config)# ethernet cfm domain outer level 3	Defines a CFM maintenance domain at a particular maintenance level and enter Ethernet CFM configuration mode. <ul style="list-style-type: none"> <li><i>domain-name</i>—String of a maximum of 154 characters that identifies the domain.</li> <li><i>level-id</i>—Integer from 0 to 7 that identifies the maintenance level.</li> </ul>
Step 4	<b>service</b> <i>csi-id</i> <b>evc</b> <i>evc-name</i> <b>vlan</b> <i>vlan-id</i> <b>direction</b> <b>down</b>  <b>Example:</b> Router(config-ether-cfm)# service microwavel evc V60 vlan 60 direction down	Sets a universally unique ID for a customer service instance (CSI) within a maintenance domain. <ul style="list-style-type: none"> <li><i>csi-id</i>—String of a maximum of 100 characters that identifies the CSI.</li> <li><b>evc</b>—Specifies the EVC.</li> <li><i>evc-name</i>—String that identifies the EVC.</li> <li><b>vlan</b>—Specifies the VLAN.</li> <li><i>vlan-id</i>—String that identifies the VLAN ID. Range is from 1 to 4094.</li> <li><b>direction</b>—Specifies the service direction.</li> <li><b>down</b>—Specifies the direction towards the LAN.</li> </ul>
Step 5	<b>continuity-check</b>  <b>Example:</b> Router(config-ecfm-srv)# continuity-check	Enables the transmission of continuity check messages (CCMs).
Step 6	<b>exit</b>  <b>Example:</b> Router(config-ecfm-srv)# exit	Exits Ethernet CFM service configuration mode and enters global configuration mode.
Step 7	<b>ethernet evc</b> <i>evc-id</i>  <b>Example:</b> Router(config)# ethernet evc V60	Defines an EVC and enters EVC configuration mode. <ul style="list-style-type: none"> <li><i>evc-id</i>—String from 1 to 100 characters that identifies the EVC.</li> </ul>

	Command	Purpose
Step 8	<b>exit</b>  <b>Example:</b> Router(config-evc)# exit	Exits Ethernet EVC configuration mode and enters global configuration mode.
Step 9	<b>interface</b> <i>type number</i>  <b>Example:</b> Router(config)# interface GigabitEthernet0/11	Specifies an interface type and number, and enters interface configuration mode.
Step 10	<b>service instance</b> <i>id</i> <b>ethernet</b>  <b>Example:</b> Router(config-if)# service instance 60 ethernet 60	Configures an Ethernet service instance on an interface. <ul style="list-style-type: none"> <li>• <i>id</i>—Integer that uniquely identifies a service instance on an interface.</li> </ul>
Step 11	<b>encapsulation dot1q</b> <i>vlan-id</i>  <b>Example:</b> Router(config-if)# encapsulation dot1q 60	Enables IEEE 802.1Q encapsulation of traffic on a specified interface in a VLAN. <ul style="list-style-type: none"> <li>• <i>vlan-id</i>—Virtual LAN identifier.</li> </ul>
Step 12	<b>rewrite ingress tag pop</b> <b>1</b> <b>symmetric</b>  <b>Example:</b> Router(config-if)# rewrite ingress tag pop 1 symmetric	Specifies the encapsulation adjustment to be performed on a frame ingressing a service instance. <ul style="list-style-type: none"> <li>• <b>pop</b>—Removes a tag from a packet.</li> <li>• <b>1</b>—Specifies the outermost tag for removal from a packet.</li> <li>• <b>symmetric</b>—Indicates a reciprocal adjustment to be done in the egress direction. For example, if the ingress pops a tag, the egress pushes a tag and if the ingress pushes a tag, the egress pops a tag.</li> </ul>
Step 13	<b>bridge-domain</b> <i>bridge-domain-id</i>  <b>Example:</b> Router(config-if)# bridge-domain 60	Enables RFC 1483 ATM bridging or RFC 1490 Frame Relay bridging to map a bridged VLAN to an ATM permanent virtual circuit (PVC) or Frame Relay data-link connection identifier (DLCI). <ul style="list-style-type: none"> <li>• <i>bridge-domain-id</i>—Bridge domain identifier.</li> </ul>
Step 14	<b>exit</b>  <b>Example:</b> Router(config-if)# exit	Exits interface configuration mode.



## Configuring EEP Applet Using CLIs

To configure EEP applet, complete the following steps:

### Prerequisites

- One switch virtual interface (SVI) or bridge domain is required per physical link.
- One EEM script is required per physical link.



#### Note

The EEM script configures the metric on the microwave link and adjusts the QoS policy based on the Ethernet event parameters. You can download the scripts from the following location:

### SUMMARY STEPS

1. **enable**
2. **configure terminal**
3. **event manager applet** *applet-name*
4. **event tag** *event-tag* **ethernet microwave clear-sd** {**interface** *type number*}
5. **event tag** *event-tag* **ethernet microwave sd** {**interface** *type number*} **threshold** *mbps*
6. **action** *action-id* **set** *variable-name* *variable-value*
7. **action** *action-id* **cli command** *cli-string*
8. **action** *action-id* **cli command** *cli-string*
9. **exit**

### DETAILED STEPS

	Command	Purpose
Step 1	<b>enable</b>  <b>Example:</b> Router> enable	Enables privileged EXEC mode. <ul style="list-style-type: none"> <li>• Enter your password if prompted.</li> </ul>
Step 2	<b>configure terminal</b>  <b>Example:</b> Router# configure terminal	Enters global configuration mode.
Step 3	<b>event manager applet</b> <i>applet-name</i>  <b>Example:</b> Router(config)# event manager applet ACM61	Registers an applet with the Embedded Event Manager (EEM) and enters applet configuration mode. <ul style="list-style-type: none"> <li>• <i>applet-name</i>—Name of the applet file.</li> </ul>

	Command	Purpose
Step 4	<p><b>event tag</b> <i>event-tag</i> <b>ethernet microwave clear-sd</b> {<i>interface type number</i>}</p> <p><b>Example:</b>  Router(config-applet)# event tag  event_cd ethernet microwave clear-sd  interface GigabitEthernet0/10</p>	<p>Specifies the event criteria for an EEM applet that is run by matching a Cisco IOS command-line interface (CLI).</p> <ul style="list-style-type: none"> <li>• <b>tag</b>—Specifies a tag using the <i>event-tag</i> argument that can be used with the trigger command to support multiple event statements within an applet.</li> <li>• <i>event-tag</i>—String that identifies the tag.</li> </ul>
Step 5	<p><b>event tag</b> <i>event-tag</i> <b>ethernet microwave sd</b> {<i>interface type number</i>} <b>threshold</b> <i>mbps</i></p> <p><b>Example:</b>  Router(config-applet)# event tag  event_sd ethernet microwave sd  interface GigabitEthernet0/10 threshold  1000</p>	<p>Specifies the event criteria for an EEM applet that is run by matching a Cisco IOS CLI.</p>
Step 6	<p><b>action</b> <i>action-id</i> <b>set</b> <i>variable-name</i> <i>variable-value</i></p> <p><b>Example:</b>  Router(config-applet)# action 110 set  ifname "vlan \$_svi61"</p>	<p>Sets the value of a variable when an EEM applet is triggered.</p> <ul style="list-style-type: none"> <li>• <i>action-id</i>—Unique identifier that can be any string value. Actions are sorted and run in ascending alphanumeric key sequence using the label as the sort key. If the string contains embedded blanks, enclose it in double quotation marks.</li> <li>• <i>variable-name</i>—Name assigned to the variable to be set.</li> <li>• <i>variable-value</i>—Value of the variable.</li> </ul>
Step 7	<p><b>action</b> <i>action-id</i> <b>cli command</b> <i>cli-string</i></p> <p><b>Example:</b>  Router(config-applet)# action 458 cli  command "event manager applet ACM61"</p>	<p>Specifies the action of executing a Cisco IOS CLI when an EEM applet is triggered.</p> <ul style="list-style-type: none"> <li>• <i>action-id</i>—Unique identifier that can be any string value. Actions are sorted and run in ascending alphanumeric key sequence using the label as the sort key. If the string contains embedded blanks, enclose it in double quotation marks.</li> <li>• <b>command</b>—Specifies the message to be sent to the Cisco IOS CLI.</li> <li>• <i>cli-string</i>—CLI string to be executed. If the string contains embedded blanks, enclose it in double quotation marks.</li> </ul>

	Command	Purpose
Step 8	<p><b>action</b> <i>action-id</i> <b>cli</b> <b>command</b> <i>cli-string</i></p> <p><b>Example:</b> Router(config-applet)# action 460 cli command "event tag event_sd ethernet microwave sd interface GigabitEthernet0/10 threshold \$nb"</p>	<p>Specifies the action of executing a Cisco IOS CLI command when an EEM applet is triggered.</p> <ul style="list-style-type: none"> <li>• <i>action-id</i>—Unique identifier that can be any string value. Actions are sorted and run in ascending alphanumeric key sequence using the label as the sort key. If the string contains embedded blanks, enclose it in double quotation marks.</li> <li>• <b>command</b>—Specifies the message to be sent to the Cisco IOS CLI.</li> <li>• <i>cli-string</i>—CLI string to be executed. If the string contains embedded blanks, enclose it in double quotation marks.</li> </ul>
Step 9	<p><b>exit</b></p> <p><b>Example:</b> Router(config-applet)# exit</p>	<p>Exits applet configuration mode.</p>

## Configuring Event Handler

To configure the microwave event handler, which runs hold-off timer, loss threshold, and fading wait-to-restore (WTR) timers that are configurable per interface, complete the following steps:

### SUMMARY STEPS

1. **enable**
2. **configure terminal**
3. **interface** *type number*
4. **ethernet event microwave hold-off** *seconds*
5. **ethernet event microwave loss-threshold** *number-of-messages*
6. **ethernet event microwave wtr** *seconds*

### DETAILED STEPS

	Command	Purpose
Step 1	<p><b>enable</b></p> <p><b>Example:</b> Router&gt; enable</p>	<p>Enables privileged EXEC mode.</p> <ul style="list-style-type: none"> <li>• Enter your password if prompted.</li> </ul>
Step 2	<p><b>configure terminal</b></p> <p><b>Example:</b> Router# configure terminal</p>	<p>Enters global configuration mode.</p>

	Command	Purpose
Step 3	<code>interface type number</code>  <b>Example:</b> Router(config)# interface vlan 40	Specifies an interface type and number, and enters interface configuration mode.
Step 4	<code>ethernet event microwave hold-off seconds</code>  <b>Example:</b> Router(config-if)# ethernet event microwave hold-off 30	Configures the settings of the Ethernet microwave event. <ul style="list-style-type: none"> <li><b>hold-off</b>—Specifies the microwave bandwidth degradation hold-off time, in seconds. This time is used to prevent changes in the state of the network node as a result of signal degradation (SD) occurrences.</li> <li><b>seconds</b>—Hold off time, in seconds. The valid values range from 0 to 600, with a default value of 0.</li> </ul>
Step 5	<code>ethernet event microwave loss-threshold number-of-messages</code>  <b>Example:</b> Router(config-if)# ethernet event microwave loss-threshold 100	Configures the settings of the Ethernet microwave event. <ul style="list-style-type: none"> <li><b>loss-threshold</b>—Specifies the number of bandwidth Vendor-Specific Messages (VSM) sent from the microwave transceiver to the Cisco device.</li> <li><b>number-of-messages</b>—Number of bandwidth VSMS. The valid values range from 2 to 255, with a default value of 3.</li> </ul>
Step 6	<code>ethernet event microwave wtr seconds</code>  <b>Example:</b> Router(config-if)# ethernet event microwave wtr 45	Configures the settings of the Ethernet microwave event. <ul style="list-style-type: none"> <li><b>wtr</b>—Specifies the wtr time. This time is used to prevent changes in the state of the network node as a result of recovery events after an SD occurrence.</li> <li><b>seconds</b>—WTR time, in seconds. The valid values range from 0 to 600, with a default value of 10.</li> </ul>

## Verifying Microwave Microwave ACM Signaling and EEM Integration Configuration

To verify the microwave ACM and EEM integration configuration, use the **show** commands described in the following examples.

To display microwave bandwidth status information of an interface, use the following **show** command.

```
Router# show ethernet event microwave status [interface]
```

```
Microwave Bandwidth Status for GigabitEthernet0/0/2
State : Degraded
Elapsed time in this state : 1:25:33
Nominal Bandwidth : 512Mbps
Current Bandwidth : 256Mbps
Lowest Bandwidth Since Entering Degraded : 64Mbps
Last VSM Received : Oct 27 14:06:19.983
Sender Transmit Period : 1 second
Sender Address : 01AB.CC00.1881
Hold Timer : Not Running
Restore Timer : Not Running
Periodic Timer : 2333 msec
Hold Time : 0 seconds
Restore Time : 10 seconds
Loss-Threshold: 3
```

To display microwave bandwidth statistics of an interface, use the following **show** command.

```
Router# show ethernet event microwave statistic [interface]

Microwave Bandwidth Statistics for GigabitEthernet0/0/2
Total VSM Receive Count : 145
Total VSM Drop Count : 0
Number of transitions into Degraded state : 2
```

## Configuration Examples for Microwave ACM Signaling and EEM Integration

This section provides sample configuration examples for Microwave ACM Signaling and EEM Integration feature on the Cisco ASR 901 router.

- [Example: Configuring CFM, page 31-11](#)
- [Example: Configuring EEP Applet, page 31-11](#)
- [Example: Configuring Event Handler, page 31-15](#)

### Example: Configuring CFM

The following is a sample configuration of CFM.

```
!
ethernet cfm domain outer level 3
service microwavel evc V60 vlan 60 direction down
  continuity-check
!
ethernet evc V60
!
interface GigabitEthernet0/11
!
service instance 60 ethernet V60
  encapsulation dot1q 60
  rewrite ingress tag pop 1 symmetric
  bridge-domain 60
!
```

### Example: Configuring EEP Applet

The following is a sample EEM script to configure metric on a microwave link and adjust a QoS policy according to the ethernet event parameters sent through OAM.



#### Note

You should have one SVI/BD per physical link. Also, one EEM script is required per physical link. In all, there should be two EEM scripts and two SVI/BDs:

```
! ACM script

no event manager applet ACM62
event manager applet ACM62
```

```

event tag event_cd ethernet microwave clear-sd interface GigabitEthernet0/10
event tag event_sd ethernet microwave sd interface GigabitEthernet0/10 threshold 1000
trigger
  correlate event event_cd or event event_sd

! Variable settings
action 100 set olc "100"
action 102 set dlc "1"
action 104 set n "$_ring_nodes"
action 106 set cb "$_ethernet_current_bw"
action 108 set nb "$_ethernet_nominal_bw"
action 110 set ifname "vlan $_svi61"
action 112 set cpmmap_bw 0
action 114 set pri_bw 0
action 116 set pppmap 0
action 118 set s1 "EEM-"
action 120 set zeros "000000"
action 122 set cb_bps "$cb$zeros"
action 124 set nb_bps "$nb$zeros"
action 126 set ifcfg 1
action 130 cli command "enable"
action 132 cli command "conf t"

! Restore the original QoS policy
action 160 if $cb eq $nb
action 162 cli command "interface $_ethernet_intf_name"
action 163 cli command "no service-policy output $s1$pppmap"
action 164 cli command "service-policy output $pppmap"

! QoS block
! Find an original parent policy-map name and create a new name
action 180 elseif $_eem_mode le "1"
action 181 if $pppmap eq "0"
action 182 cli command "do show run int $_ethernet_intf_name | i service-policy output"

# action 184 syslog msg "cli_result 184: $_cli_result, into: $_ethernet_intf_name"
action 186 regexp "service-policy output (.*)\n" "$_cli_result" line pmap
# action 188 syslog msg "line 196: $line"
# action 190 string replace "$line" 0 21 ""
action 192 string trimright "$pmap"
# action 194 syslog msg "QoS done. string 194: $_string_result, line: $line"
action 196 set pmap $_string_result
action 197 else
action 198 set pmap $pppmap
action 199 end
action 200 syslog msg "s1pmap 200: $s1$pmap"

! Find an original child policy-map name and create a new name

action 214 cli command "do show run policy-map $pmap | i service-policy"
# action 215 syslog msg "cli_result 215: $_cli_result"
action 216 regexp "service-policy (.*)\n" "$_cli_result" line cpmap
action 217 string trimright "$cpmap"
action 218 set cpmap "$_string_result"

# action 219 syslog msg "cpmap 219: $s1$cpmap"
action 220 cli command "do show run policy-map $cpmap"
action 221 regexp "class .*!" $_cli_result string

! Configuration of a new child policy-map
action 223 cli command "policy-map $s1$cpmap"
action 226 foreach var "$string" "\n"
action 228 regexp "class (.*)" $var match cname
action 230 if $_regexp_result eq 1

```

```

# action 233    syslog msg "233: cname: $cname"
action 234    end

! Calculate bandwidth for each of the classes
action 236    regexp "(priority|bandwidth) percent (.*)" $var line cmd ef_bw_perc
action 238    if $_regexp_result eq 1
action 256    string trimright "$ef_bw_perc"

# action 258    syslog msg "258: cb_bps: $nb_bps, ef_bw_perc:$_string_result"
action 260    divide $nb_bps 100
action 262    multiply $_result $_string_result
action 263    set bw_demand $_result
action 264    add $cpmap_bw $_result
action 266    syslog msg "266: cpmap_bw: $_result, bw_demand: $bw_demand"
action 268    set cpmap_bw $_result
action 269    syslog msg "269: cpmap_bw sub-sum: $cpmap_bw"
action 270    regexp "priority percent (.*)" $line match
action 272    if $_regexp_result eq 1
action 274    add $pri_bw $bw_demand
action 276    multiply $bw_demand 100
action 278    divide $_result $cb_bps
action 279    if $_remainder gt 0
action 280    increment _result
action 281    end
action 282    set match1 "priority percent $_result"
action 283    set match2 "priority percent $_result"
action 284    end
action 286    regexp "bandwidth percent (.*)" $line match
action 288    if $_regexp_result eq 1
action 290    set match1 "$match"
action 292    set match2 "bandwidth percent 1"
action 294    end
action 296    else
action 298    set match1 "$var"
action 300    set match2 "$var"
action 302    end
action 304    append cfg_out1 "$match1 \n"
action 306    append cfg_out2 "$match2 \n"
action 308    end

! Check if there is enough bandwidth on a uwave link
action 310    syslog msg "310: cpmap_bw sum: $cpmap_bw"
action 312    if $cpmap_bw lt $cb_bps
action 314    set cfg_out "$cfg_out1"
action 316    elseif $pri_bw lt $cb_bps
action 318    set cfg_out "$cfg_out2"
action 320    else
action 322    set metric 1000000
action 323    set ifcfg 0
action 324    end

! Configuration of a child QoS policy
action 325    if $ifcfg eq 1
action 326    foreach var "$cfg_out" "\n"
action 328    cli command "$var"
action 330    end
action 331    end

! Configuration of a parent QoS policy

action 332    cli command "policy-map $s1$pmap"
action 334    syslog msg "config 334: policy-map $s1$pmap"
action 336    cli command "class class-default"

```

```

action 338 cli command "shape average $cb_bps"
action 340 cli command "service-policy $s1$cpmap"

! Apply the QoS policy on a PHY interface

action 344 cli command "int $_ethernet_intf_name"
action 346 cli command "no service-policy output $pmap"
action 348 cli command "service-policy output $s1$pmap"
action 390 end

! End of the QoS part

! IGP metric block

action 400 if $_eem_mode ge 1
action 402 multiply $n $cb
action 404 divide $_result $nb
action 406 syslog msg "406: cb: $cb nb: $nb result: $_result"
action 408 set m $_result
action 410 syslog msg "m: $m"
action 412 increment n
action 414 subtract $n $m
action 416 multiply $_result $olc
action 418 if $ifcfg eq 0
action 420 set dlc $metric
action 422 else
action 424 set dlc $_result
action 426 end

action 428 syslog msg "428: n:$n m:$m olc:$olc dlc:$dlc result:$_result intf: $ifname"
# action 430 cli command "enable"
# action 432 cli command "conf t"
action 434 cli command "int $ifname"
action 436 cli command "do show run int $ifname"
action 438 string first "ip router isis" "$_cli_result"
action 440 if $_string_result ne "-1"
action 442 cli command "isis metric $dlc"
action 444 cli command "do show ip ospf int | i $ifname"
action 446 string first "$ifname" "$_cli_result"
action 448 elseif $_string_result ne "-1"
action 450 cli command "ip ospf cost $dlc"
action 452 end
action 454 end

! Adjust the current applet

action 456 syslog msg "The EEM script executed"
action 458 cli command "event manager applet ACM62"
action 460 cli command "event tag event_sd ethernet microwave sd interface
GigabitEthernet0/10 threshold $nb"
action 462 if $ppmap eq 0
action 464 if $_eem_mode le 1
action 466 cli command "action 116 set pmap $pmap"
action 468 end
action 470 end

! End of the script

```



## Example: Configuring Event Handler

The following is a sample configuration of Event Handler.

```
event manager applet mw_ring_sd1
  event ethernet microwave sd interface gigabitethernet 0/0/0 threshold 400
  action 1 switch ring g8032 ringA instance 1
interface gigabitethernet 0/0/0
  ethernet event microwave hold-off 30
  ethernet event microwave loss-threshold 100
  ethernet event microwave wtr 45
```

## Additional References

The following sections provide references related to Microwave ACM Signaling and EEM Integration feature.

### Related Documents

Related Topic	Document Title
Cisco IOS Commands	<i>Cisco IOS Master Commands List, All Releases</i>
Cisco ASR 901 Router Commands	<i>Cisco ASR 901 Series Aggregation Services Router Command Reference</i>
G.8032 and CFM Support for Microwave Adaptive Bandwidth	<i>Carrier Ethernet Configuration Guide</i>
Transport Integration with Microwave ACM	<i>Transport Integration with Microwave ACM</i>

### Standards

Standard	Title
None	—

### MIBs

MIB	MIBs Link
None	To locate and download MIBs for selected platforms, Cisco IOS releases, and feature sets, use Cisco MIB Locator found at the following URL: <a href="http://www.cisco.com/go/mibs">http://www.cisco.com/go/mibs</a>

### RFCs

RFC	Title
None	—

### Technical Assistance

Description	Link
The Cisco Technical Support website contains thousands of pages of searchable technical content, including links to products, technologies, solutions, technical tips, and tools. Registered Cisco.com users can log in from this page to access even more content.	<a href="http://www.cisco.com/techsupport">http://www.cisco.com/techsupport</a>

# Feature Information for Microwave ACM Signaling and EEM Integration

Table 31-1 lists the features in this module and provides links to specific configuration information.

Use Cisco Feature Navigator to find information about platform support and software image support. Cisco Feature Navigator enables you to determine which software images support a specific software release, feature set, or platform. To access Cisco Feature Navigator, go to <http://www.cisco.com/go/cfn>. An account on Cisco.com is not required.



**Note**

Table 31-1 lists only the software release that introduced support for a given feature in a given software release train. Unless noted otherwise, subsequent releases of that software release train also support that feature.

**Table 31-1** Feature Information for Remote Loop-Free Alternate - Fast Reroute

Feature Name	Releases	Feature Information
Microwave ACM Signaling and EEM Integration	15.3(2)S	<p>This feature was introduced on the Cisco ASR 901 routers. The following sections provide information about this feature:</p> <ul style="list-style-type: none"> <li>• <a href="#">Feature Overview, page 31-2</a></li> <li>• <a href="#">How to Configure Microwave ACM Signaling and EEM Integration, page 31-4</a></li> </ul>





## IPv6 Support on the Cisco ASR 901 Router

---

This document provides implementation and command reference information for IPv6 features supported on the Cisco ASR 901 router. We strongly recommend that you read this entire document before reading other documents on IPv6 for Cisco IOS software.

Detailed conceptual information about the features supported on the Cisco ASR 901 router, is documented outside of this feature in the Cisco IOS software documentation. For information about the location of this related documentation, see the [“Feature Information for IPv6 Support on the Cisco ASR 901 Router”](#) section on page 32-49.

Complete configuration information of ASR 901-specific IPv6 features is provided in this document. This information can be found in the [“How to Configure IPv6 Support on the Cisco ASR 901 Router”](#) section on page 32-8.

### Finding Feature Information

Your software release may not support all the features documented in this module. For the latest feature information and caveats, see the release notes for your platform and software release. To find information about the features documented in this module, and to see a list of the releases in which each feature is supported, see the [“Feature Information for IPv6 Support on the Cisco ASR 901 Router”](#) section on page 32-49.

Use Cisco Feature Navigator to find information about platform support and Cisco software image support. To access Cisco Feature Navigator, go to <http://www.cisco.com/go/cfn>. An account on Cisco.com is not required.

### Contents

- [Prerequisites for IPv6 Support on the Cisco ASR 901 Router, page 32-2](#)
- [Restrictions for IPv6 Support on the Cisco ASR 901 Router, page 32-2](#)
- [Information About IPv6 Support on the Cisco ASR 901 Router, page 32-2](#)
- [How to Configure IPv6 Support on the Cisco ASR 901 Router, page 32-8](#)
- [Configuration Examples for IPv6 Support on the Cisco ASR 901 Router, page 32-39](#)
- [Additional References, page 32-47](#)
- [Feature Information for IPv6 Support on the Cisco ASR 901 Router, page 32-49](#)

## Prerequisites for IPv6 Support on the Cisco ASR 901 Router

- Cisco IOS Release 15.2(2)SNG or a later IPv6-supporting release must be installed previously on the Cisco ASR 901 Series Aggregation Services Router.
- To forward IPv6 traffic using Cisco Express Forwarding (CEF) or distributed CEF, you must configure forwarding of IPv6 unicast datagrams globally on the router by using the **ipv6 unicast-routing** command, and you must configure an IPv6 address on an interface by using the **ipv6 address** command.
- You must enable CEF for IPv4 globally on the router by using the **ip cef** command before enabling Cisco Express Forwarding for IPv6 globally on the router by using the **ipv6 cef** command.

## Restrictions for IPv6 Support on the Cisco ASR 901 Router

- Switch port configuration is not supported.
- The fastethernet interface does not expect more than one IPv6 address.
- The following features are not supported:
  - Tunneling protocols such as IPv4-to-IPv6 or IPv6-to-IPv4
  - IPv6 Policy-Based Routing
  - Hot Standby Router Protocol (HSRP) and Virtual Router Redundancy Protocol (VRRP) for IPv6
  - Quality of service (QoS) based on IPv6 addresses
  - IPv6 support of IEEE 1588v2
  - IPv6 support over slower links like time-division multiplexing (TDM) interfaces, Multilink Point-to-Point Protocol (MLPPP), etc
  - IPv6 Access Control Lists (ACLs)
  - IPv6 over IP and Multiprotocol Label Switching (MPLS)
  - Bidirectional Forwarding Detection for IPv6 (BFDv6) for Intermediate System-to-Intermediate System (IS-IS)
  - IPv6 Virtual Routing and Forwarding (VRF) Lite

## Information About IPv6 Support on the Cisco ASR 901 Router

- [Benefits](#)
- [Overview of IPv6](#)
- [IPv6 Address Formats](#)
- [IPv6 Addressing and Discovery](#)
- [Routing Protocols](#)
- [Bidirectional Forwarding Detection for IPv6](#)
- [QoS for IPv6](#)

## Benefits

IPv6 Support on the Cisco ASR 901 router provides the following benefits:

- Supports state-less auto-configuration of IPv6 addresses.
- Supports the following routing protocols:
  - Static routing
  - Open Shortest Path First (OSPF) version 3
  - Border Gateway Protocol
  - Intermediate System-to-Intermediate System (IS-IS)

## Overview of IPv6

IPv6 is the latest version of the Internet Protocol that has a much larger address space and improvements such as a simplified main header and extension headers. The architecture of IPv6 has been designed to allow existing IPv4 users to transition easily to IPv6 while providing services such as end-to-end security, quality of service (QoS), and globally unique addresses.

The larger IPv6 address space allows networks to scale and provide global reachability. The simplified IPv6 packet header format handles packets more efficiently. IPv6 supports widely deployed routing protocols such as Routing Information Protocol (RIP), Integrated Intermediate System-to-Intermediate System (IS-IS), Open Shortest Path First (OSPF) for IPv6, and multiprotocol Border Gateway Protocol (BGP). Other available features include stateless autoconfiguration and enhanced support for Mobile IPv6.

IPv6 is being introduced on the Cisco ASR 901 router to support Long Term Evolution (LTE) rollouts that provides high-bandwidth data connection for mobile wireless devices. The IPv6 transport utilizes Switch Virtual Interface (SVI) and Ethernet interfaces. The Cisco ASR 901 router also supports IPv6 addressing on Loopback interfaces.

## IPv6 Address Formats

IPv6 addresses are represented as a series of 16-bit hexadecimal fields separated by colons (:) in the format: x:x:x:x:x:x:x. Following are two examples of IPv6 addresses:

```
2001:DB8:7654:3210:FEDC:BA98:7654:3210
2001:DB8:0:0:8:800:200C:417A
```

It is common for IPv6 addresses to contain successive hexadecimal fields of zeros. To make IPv6 addresses less complicated, two colons (::) may be used to compress successive hexadecimal fields of zeros at the beginning, middle, or end of an IPv6 address (the colons represent successive hexadecimal fields of zeros). [Table 32-1](#) lists compressed IPv6 address formats.

A double colon may be used as part of the *ipv6-address* argument when consecutive 16-bit values are denoted as zero. You can configure multiple IPv6 addresses per interface, but only one link-local address.



### Note

Two colons (::) can be used only once in an IPv6 address to represent the longest successive hexadecimal fields of zeros. The hexadecimal letters in IPv6 addresses are not case-sensitive.

**Table 32-1 Compressed IPv6 Address Formats**

IPv6 Address Type	Preferred Format	Compressed Format
Unicast	2001:0:0:0:DB8:800:200C:417A	2001::DB8:800:200C:417A
Loopback	0:0:0:0:0:0:1	::1
Unspecified	0:0:0:0:0:0:0	::

The loopback address listed in [Table 32-1](#) are used by a node to send an IPv6 packet to itself. The loopback address in IPv6 functions the same as the loopback address in IPv4 (127.0.0.1).

**Note**

The IPv6 loopback address cannot be assigned to a physical interface. A packet that has the IPv6 loopback address as its source or destination address must remain within the node that created the packet. IPv6 routers do not forward packets that have the IPv6 loopback address as their source or destination address.

The unspecified address listed in [Table 32-1](#) indicates the absence of an IPv6 address. For example, a newly initialized node on an IPv6 network may use the unspecified address as the source address in its packets until it receives its IPv6 address.

**Note**

The IPv6 unspecified address cannot be assigned to an interface. The unspecified IPv6 addresses must not be used as destination addresses in IPv6 packets or the IPv6 routing header.

An IPv6 address prefix, in the format *ipv6-prefix/prefix-length*, can be used to represent bit-wise contiguous blocks of the entire address space. The *ipv6-prefix* must be in the form documented in RFC 2373 where the address is specified in hexadecimal using 16-bit values between colons. The prefix length is a decimal value that indicates how many of the high-order contiguous bits of the address comprise the prefix (the network portion of the address). For example, 2001:DB8:8086:6502::/32 is a valid IPv6 prefix.

For more information on IPv6 Addressing and Basic Connectivity, see the *Implementing IPv6 Addressing and Basic Connectivity* chapter of IPv6 Configuration Guide, at the following location:

<http://www.cisco.com/en/US/docs/ios-xml/ios/ipv6/configuration/15-2mt/ipv6-addrg-bsc-con.html>

## IPv6 Addressing and Discovery

The IPv6 addressing and discover consists of static and autoconfiguration of addresses – both global and link local addresses. IPv6 differs from IPv4 in that same interface can have multiple IPv6 addresses assigned to it. The Cisco ASR 901 router supports both IPv4 and multiple IPv6 addresses on the same Loopback and SVI interface. The link-local addresses are automatically generated (if **ipv6 enable** command is configured) from the MAC-address of the interface as soon as the SVI comes up.

### Static Configuration

Static configuration is the manual process of defining an explicit path between two networking devices. The administrator of the network manually enters the IPv6 addresses, subnet masks, gateways, and corresponding MAC addresses for each interface of each router into a table. Static configuration



provides more control over the network but it requires more work to maintain the table. The table must be updated every time routes are added or changed. Moreover, the static routes must be manually reconfigured if there is a change in the network topology.

Static configuration provides security and resource efficiency. It uses less bandwidth than dynamic routing protocols and no CPU cycles are used to calculate and communicate routes. Static routes created by the static configuration can be redistributed into dynamic routing protocols. However, routes generated by dynamic routing protocols cannot be redistributed into the static routing table.

Static configuration is useful for smaller networks with only one path to an outside network and in providing security for a larger network for certain types of traffic or links to other networks that need more control. In general, most networks use dynamic routing protocols to communicate between networking devices but may have one or two static routes configured for special cases.

## Stateless Autoconfiguration

All interfaces on IPv6 nodes must have a link-local address, which is usually automatically configured from the identifier for an interface and the link-local prefix FE80::/10. A link-local address enables a node to communicate with other nodes on the link and can be used to further configure the node.

Nodes can connect to a network and automatically generate global IPv6 addresses without the need for manual configuration or help of a Dynamic Host Configuration Protocol (DHCP) server.

With IPv6, a router on the link advertises in RA messages any global prefixes, and its willingness to function as a default router for the link. RA messages are sent periodically and in response to router solicitation messages, which are sent by hosts at system startup.

A node on the link can automatically configure global IPv6 addresses by appending its interface identifier (64 bits) to the prefixes (64 bits) included in the RA messages. The resulting 128-bit IPv6 addresses configured by the node are then subjected to duplicate address detection (DAD) to ensure their uniqueness on the link. If the prefixes advertised in the RA messages are globally unique, then the IPv6 addresses configured by the node are also globally unique. Router solicitation messages, which have a value of 133 in the Type field of the ICMP packet header, are sent by hosts at system startup so that the host can immediately autoconfigure without needing to wait for the next scheduled RA message.

For more information on IPv6 Addressing and Discovery, see the *Implementing IPv6 Addressing and Basic Connectivity* chapter of IPv6 Configuration Guide, at the following location:

<http://www.cisco.com/en/US/docs/ios-xml/ios/ipv6/configuration/15-2mt/ip6-addrg-bsc-con.html>

## ICMPv6

Internet Control Message Protocol (ICMP) in IPv6 functions the same as ICMP in IPv4. ICMP generates error messages such as ICMP destination unreachable messages, and informational messages such as ICMP echo request and reply messages. Additionally, ICMP packets in IPv6 are used in the IPv6 neighbor discovery process, path MTU discovery, and the Multicast Listener Discovery (MLD) protocol for IPv6.

For more information on ICMPv6, see the *Implementing IPv6 Addressing and Basic Connectivity* chapter of IPv6 Configuration Guide, at the following location:

<http://www.cisco.com/en/US/docs/ios-xml/ios/ipv6/configuration/15-2mt/ip6-addrg-bsc-con.html>

## IPv6 Duplicate Address Detection

During the stateless autoconfiguration process, duplicate address detection (DAD) verifies the uniqueness of new unicast IPv6 addresses before the addresses are assigned to interfaces (the new addresses remain in a tentative state while duplicate address detection is performed). DAD is first performed first on the new link-local address. When the link local address is verified as unique, then DAD is performed on the remaining IPv6 unicast addresses on the interface.

When a duplicate address is identified, the state of the address is set to `DUPLICATE` and the address is not used. If the duplicate address is the link-local address of the interface, the processing of IPv6 packets is disabled on the interface and an error message is issued. If the duplicate address is a global address of the interface, the address is not used and an error message is issued. However, all configuration commands associated with the duplicate address remain as configured while the state of the address is set to `DUPLICATE`.

If the link-local address for an interface changes, duplicate address detection is performed on the new link-local address and all of the other IPv6 address associated with the interface are regenerated (duplicate address detection is performed only on the new link-local address).

## IPv6 Neighbor Discovery

The IPv6 neighbor discovery process uses ICMPv6 messages and solicited-node multicast addresses to determine the link-layer address of a neighbor on the same network (local link), verify the reachability of a neighbor, and keep track of neighboring routers.

Neighbor solicitation messages (ICMPv6 Type 135) are sent on the local link by nodes attempting to discover the link-layer addresses of other nodes on the local link. The neighbor solicitation message is sent to the solicited-node multicast address. The source address in the neighbor solicitation message is the IPv6 address of the node sending the neighbor solicitation message. The neighbor solicitation message also includes the link-layer address of the source node.

After receiving a neighbor solicitation message, the destination node replies by sending a neighbor advertisement message (ICMPv6 Type 136) on the local link. The source address in the neighbor advertisement message is the IPv6 address of the node sending the neighbor advertisement message; the destination address is the IPv6 address of the node that sent the neighbor solicitation message. The data portion of the neighbor advertisement message includes the link-layer address of the node sending the neighbor advertisement message.

After the source node receives the neighbor advertisement, the source node and destination node communicate with each other.

For more information on IPv6 Neighbor Discovery, see the *Implementing IPv6 Addressing and Basic Connectivity* chapter of IPv6 Configuration Guide, at the following location:

<http://www.cisco.com/en/US/docs/ios-xml/ios/ipv6/configuration/15-2mt/ip6-addrg-bsc-con.html>

## IPv4 and IPv6 Dual-Stack on an Interface

A dual stack means that IPv4 and IPv6 addresses coexist on the same platform and support hosts of both types. This method is a way to transition from IPv4 to IPv6 with coexistence (IPv4 and IPv6) as a first step.

The Cisco ASR 901 router supports the configuration of both IPv6 and IPv4 on an interface. You do not need to enter any specific commands to do so; simply enter the IPv4 configuration commands and IPv6 configuration commands as you normally would. Make sure you configure the default route for both IPv4 and IPv6.

## Routing Protocols

The Cisco ASR 901 router supports widely deployed routing protocols such as IS-IS, OSPFv3, and multiprotocol BGP.

### IS-IS Enhancements for IPv6

IS-IS in IPv6 functions the same as in IPv4 and offers many of the same benefits as IS-IS in IPv4. IPv6 enhancements to IS-IS allow IS-IS to advertise IPv6 prefixes in addition to IPv4 and OSI routes. Extensions to the IS-IS command-line interface (CLI) allow configuration of IPv6-specific parameters. IPv6 IS-IS extends the address families supported by IS-IS to include IPv6, in addition to OSI and IPv4.

For more information on IS-IS Enhancements for IPv6, see the following document:

<http://www.cisco.com/en/US/docs/ios-xml/ios/ipv6/configuration/15-2mt/ip6-is-is.html>

### OSPFv3 for IPv6

OSPF is a routing protocol for IP. It is a link-state protocol. A link-state protocol makes its routing decisions based on the states of the links that connect source and destination machines. The state of a link is a description of that interface, and its relationship to its neighboring networking devices. The interface information includes the IPv6 prefix of the interface, the network mask, the type of network it is connected to, the devices connected to that network, and so on. This information is propagated in various type of link-state advertisements (LSAs).

For more information on OSPFv3 for IPv6, refer the following link:

<http://www.cisco.com/en/US/docs/ios-xml/ios/ipv6/configuration/15-2mt/ip6-ospf.html>

### Multiprotocol BGP Extensions for IPv6

Multiprotocol BGP is the supported exterior gateway protocol (EGP) for IPv6. Multiprotocol BGP extensions for IPv6 support many of the same features and functionality as IPv4 BGP. IPv6 enhancements to multiprotocol BGP include support for an IPv6 address family and network layer reachability information (NLRI) and next hop (the next router in the path to the destination) attributes that use IPv6 addresses.

For more information on Multiprotocol BGP Extensions for IPv6, refer the following link:

<http://www.cisco.com/en/US/docs/ios-xml/ios/ipv6/configuration/15-2mt/ip6-mptcl-bgp.html>

### Bidirectional Forwarding Detection for IPv6

The BFDv6 is a detection protocol designed to provide fast forwarding path failure detection times for all media types, encapsulations, topologies, and routing protocols. In addition to fast forwarding path failure detection, BFD provides a consistent failure detection method for network administrators. BFDv6 provides IPv6 support by accommodating IPv6 addresses and provides the ability to create BFDv6 sessions.

For more information on Bidirectional Forwarding Detection for IPv6, refer the following link:

<http://www.cisco.com/en/US/docs/ios-xml/ios/ipv6/configuration/15-2mt/ip6-bfd.html>

## QoS for IPv6

The Cisco ASR 901 router support of QoS features for IPv6 environments include ingress packet classification, policing, marking on Ethernet interfaces. It also supports egress packet classification, marking, scheduling, per interface and per qos-group shaping, Low Latency Queuing (LLQ), and weighted random early detection (WRED) on GigabitEthernet interfaces.



### Note

Queuing, shaping, scheduling and LLQ is not supported on the ingress path for the Ethernet interfaces. Policing is not supported on the egress path for GigabitEthernet interfaces.

The QoS implementation for IPv6 environment in the Cisco ASR router is the same as that of IPv4. For more information on Configuring QoS on the Cisco ASR 901 router, refer the following link:

[http://www.cisco.com/en/US/docs/wireless/asr\\_901/Configuration/Guide/qos.html](http://www.cisco.com/en/US/docs/wireless/asr_901/Configuration/Guide/qos.html)

For additional information on Implementing QoS for IPv6, refer the following link:

<http://www.cisco.com/en/US/docs/ios-xml/ios/ipv6/configuration/15-2mt/ipv6-qos.html>

## How to Configure IPv6 Support on the Cisco ASR 901 Router

- [Configuring IPv6 Addressing and Enabling IPv6 Routing, page 32-8](#)
- [Configuring a Static IPv6 Route, page 32-10](#)
- [Enabling Stateless Auto-Configuration, page 32-11](#)
- [Implementing IPv6 on VLAN Interfaces, page 32-12](#)
- [Implementing IPv6 Addressing on Loopback Interfaces, page 32-13](#)
- [Configuring ICMPv6 Rate Limiting, page 32-14](#)
- [Configuring IPv6 Duplicate Address Detection, page 32-15](#)
- [Configuring IPv6 Neighbor Discovery, page 32-16](#)
- [Configuring IPv6 and IPv4 Dual-Stack on the Same VLAN, page 32-17](#)
- [Configuring OSPFv3 for IPv6, page 32-18](#)
- [Configuring IS-IS for IPv6, page 32-19](#)
- [Configuring Multiprotocol-BGP for IPv6, page 32-21](#)
- [Configuring BFD for IPv6, page 32-22](#)
- [Configuring BFDv6 and OSPFv3, page 32-25](#)
- [Configuring BFDv6 for BGP, page 32-26](#)
- [Implementing QoS for IPv6, page 32-27](#)

## Configuring IPv6 Addressing and Enabling IPv6 Routing

Perform this task to assign IPv6 addresses to individual router interfaces and enable IPv6 traffic forwarding globally on the router. By default, IPv6 addresses are not configured, and IPv6 routing is disabled.

## SUMMARY STEPS

1. **enable**
2. **configure terminal**
3. **interface** *type number*
4. **ipv6 address** *ipv6-address/prefix-length* { **eui-64** | **link-local** | **anycast** }
5. **ipv6 enable**
6. **exit**
7. **ipv6 unicast-routing**
8. **ipv6 cef**

## DETAILED STEPS

	Command or Action	Purpose
Step 1	<b>enable</b>  <b>Example:</b> Router> enable	Enables privileged EXEC mode. <ul style="list-style-type: none"> <li>• Enter your password if prompted.</li> </ul>
Step 2	<b>configure terminal</b>  <b>Example:</b> Router# configure terminal	Enters global configuration mode.
Step 3	<b>interface</b> <i>type number</i>  <b>Example:</b> Router(config)# interface vlan 40	Specifies an interface type and number and enters interface configuration mode.
Step 4	<b>ipv6 address</b> <i>ipv6-address/prefix-length</i> { <b>eui-64</b>   <b>link-local</b>   <b>anycast</b> }  <b>Example:</b> Router(config-if)# ipv6 address 2001:DB8:FFFF::2/64	Configures an IPv6 address based on an IPv6 general prefix and enables IPv6 processing on an interface. <ul style="list-style-type: none"> <li>• <b>eui-64</b>—Specifies the global IPv6 addresses with an interface identifier (ID) in the low-order 64 bits of the IPv6 address. Only the 64-bit network prefix for the address needs to be specified; the last 64 bits are automatically computed from the interface ID.</li> <li>• <b>link-local</b>—Specifies the link-local address on the interface that is used instead of the link-local address that is automatically configured when IPv6 is enabled on the interface.</li> <li>• <b>anycast</b>—Specifies an IPv6 anycast address.</li> </ul>
Step 5	<b>ipv6 enable</b>  <b>Example:</b> Router(config-if)# ipv6 enable	Enables IPv6 on the interface.

	Command or Action	Purpose
Step 6	<b>exit</b>  <b>Example:</b> Router(config-if)# exit	Exits interface configuration mode, and returns the router to global configuration mode.
Step 7	<b>ipv6 unicast-routing</b>  <b>Example:</b> Router(config)# ipv6 unicast-routing	Enables the forwarding of IPv6 unicast datagrams.
Step 8	<b>ipv6 cef</b>  <b>Example:</b> Router(config)# ipv6 cef	Enables Cisco Express Forwarding (CEF) globally on the router.

## Configuring a Static IPv6 Route

### SUMMARY STEPS

1. **enable**
2. **configure terminal**
3. **ipv6 route** {*ipv6-prefix / prefix-length ipv6-address* | *interface-type interface-number [ipv6-address]*} [*administrative-distance*] [*administrative-multicast-distance* | **unicast** | **multicast**] [*tag tag*]

### DETAILED STEPS

	Command or Action	Purpose
Step 1	<b>enable</b>  <b>Example:</b> Router> enable	Enables privileged EXEC mode. <ul style="list-style-type: none"> <li>• Enter your password if prompted.</li> </ul>
Step 2	<b>configure terminal</b>  <b>Example:</b> Router# configure terminal	Enters global configuration mode.

Command or Action	Purpose
<p><b>Step 3</b></p> <pre>ipv6 route {ipv6-prefix / prefix-length ipv6-address   interface-type interface-number [ipv6-address]} [administrative-distance] [administrative-multicast-distance   <b>unicast</b>   <b>multicast</b>] [tag tag]</pre> <p><b>Example:</b> Router(config)# ipv6 route 2001::/64 5::5 100</p>	<p>Configures a static default IPv6 route.</p> <ul style="list-style-type: none"> <li>• <i>ipv6-prefix</i>—The IPv6 network that is the destination of the static route. This could also be a host name when static host routes are configured.</li> <li>• <i>prefix-length</i>—The length of the IPv6 prefix.</li> <li>• <i>ipv6-address</i>—(Optional) The IPv6 address of the next hop that can be used to reach the specified network.</li> <li>• <i>interface-type</i>—Interface type.</li> <li>• <i>interface-number</i>—Interface number.</li> <li>• <i>administrative-distance</i>—(Optional) An administrative distance. The default value is 1, which gives static routes precedence over any other type of route except connected routes.</li> <li>• <i>administrative-multicast-distance</i>—(Optional) The distance used when selecting this route for multicast Reverse Path Forwarding (RPF).</li> <li>• <b>unicast</b>—(Optional) Specifies a route that must not be used in multicast RPF selection.</li> <li>• <b>multicast</b>—(Optional) Specifies a route that must not be populated in the unicast Routing Information Base (RIB).</li> <li>• <i>tag</i>—(Optional) Tag value that is used as a “match” value for controlling redistribution via route maps.</li> </ul>

## Enabling Stateless Auto-Configuration

### SUMMARY STEPS

1. **enable**
2. **configure terminal**
3. **interface** *type number*
4. **ipv6 address autoconfig**

## DETAILED STEPS

	Command or Action	Purpose
Step 1	<b>enable</b>  <b>Example:</b> Router> enable	Enables privileged EXEC mode. <ul style="list-style-type: none"> <li>Enter your password if prompted.</li> </ul>
Step 2	<b>configure terminal</b>  <b>Example:</b> Router# configure terminal	Enters global configuration mode.
Step 3	<b>interface</b> <i>type number</i>  <b>Example:</b> Router(config)# Interface fastethernet 0/0	Specifies an interface type and number, and places the router in interface configuration mode.
Step 4	<b>ipv6 address autoconfig</b>  <b>Example:</b> Router(config-if)# ipv6 address autoconfig	Enables automatic configuration of IPv6 addresses using stateless autoconfiguration on an interface and enables IPv6 processing on the interface.

## Implementing IPv6 on VLAN Interfaces

Perform the tasks given below to enable IPv6 on VLAN interfaces. By default, IPv6 is disabled on an interface.

**Note**

For information on how to create a VLAN interface, see the *Configuring Ethernet Virtual Connections* document at the following location:

[http://www.cisco.com/en/US/partner/docs/wireless/asr\\_901/Configuration/Guide/swevc.html](http://www.cisco.com/en/US/partner/docs/wireless/asr_901/Configuration/Guide/swevc.html)

## SUMMARY STEPS

- enable**
- configure terminal**
- interface** *type number*
- ipv6 enable**  
or  
**ipv6 address** {*ipv6-address/prefix-length* \ *prefix-name sub-bits/prefix-length*}



## DETAILED STEPS

	Command or Action	Purpose
Step 1	<b>enable</b>  <b>Example:</b> Router> enable	Enables privileged EXEC mode. <ul style="list-style-type: none"> <li>Enter your password if prompted.</li> </ul>
Step 2	<b>configure terminal</b>  <b>Example:</b> Router# configure terminal	Enters global configuration mode.
Step 3	<b>interface</b> <i>type number</i>  <b>Example:</b> Router(config)# Interface vlan 40	Specifies an interface type and number, and places the router in interface configuration mode. farce
Step 4	<b>ipv6 enable</b> or <b>ipv6 address</b> { <i>ipv6-address/prefix-length</i>   <i>prefix-name sub-bits/prefix-length</i> }  <b>Example:</b> Router(config-if)# ipv6 enable or Router(config-if)# ipv6 address 2000::1/64	Configures IPv6 on the VLAN interface. Though both the commands automatically configure the link local address (LLA) on the interface, the <b>ipv6 address</b> command additionally configures an ipv6 address on the interface. <ul style="list-style-type: none"> <li><i>ipv6-address</i>—The IPv6 address to be used.</li> <li><i>prefix-length</i>—The length of the IPv6 prefix. A decimal value that indicates how many of the high-order contiguous bits of the address comprise the prefix (the network portion of the address). A slash mark must precede the decimal value.</li> <li><i>prefix-name</i>—A general prefix, which specifies the leading bits of the network to be configured on the interface.</li> <li><i>sub-bits</i>—The subprefix bits and host bits of the address to be concatenated with the prefixes provided by the general prefix specified with the <i>prefix-name</i> argument.</li> </ul>

## Implementing IPv6 Addressing on Loopback Interfaces

## SUMMARY STEPS

- enable**
- configure terminal**
- interface** *type number*
- ipv6 enable**  
or  
**ipv6 address** {*ipv6-address/prefix-length* | *prefix-name sub-bits/prefix-length*}

## DETAILED STEPS

	Command or Action	Purpose
Step 1	<b>enable</b>  <b>Example:</b> Router> enable	Enables privileged EXEC mode. <ul style="list-style-type: none"> <li>Enter your password if prompted.</li> </ul>
Step 2	<b>configure terminal</b>  <b>Example:</b> Router# configure terminal	Enters global configuration mode.
Step 3	<b>interface</b> <i>type number</i>  <b>Example:</b> Router(config)# Interface loopback 0	Specifies an interface type and number, and places the router in interface configuration mode.
Step 4	<b>ipv6 enable</b> or <b>ipv6 address</b> { <i>ipv6-address/prefix-length</i>   <i>prefix-name sub-bits/prefix-length</i> }  <b>Example:</b> Router(config-if)# ipv6 enable or Router(config-if)# ipv6 address 2000::1/64	Configures IPv6 on the Loopback interface. Though both the commands automatically configure the link local address (LLA) on the interface, the <b>ipv6 address</b> command additionally configures an ipv6 address on the interface. <ul style="list-style-type: none"> <li><i>ipv6-address</i>—The IPv6 address to be used.</li> <li><i>prefix-length</i>—The length of the IPv6 prefix. A decimal value that indicates how many of the high-order contiguous bits of the address comprise the prefix (the network portion of the address). A slash mark must precede the decimal value.</li> <li><i>prefix-name</i>—A general prefix, which specifies the leading bits of the network to be configured on the interface.</li> <li><i>sub-bits</i>—The subprefix bits and host bits of the address to be concatenated with the prefixes provided by the general prefix specified with the <i>prefix-name</i> argument.</li> </ul>

## Configuring ICMPv6 Rate Limiting

## SUMMARY STEPS

- enable
- configure terminal
- ipv6 icmp error-interval *interval*

## DETAILED STEPS

	Command or Action	Purpose
Step 1	<b>enable</b>  <b>Example:</b> Router> enable	Enables privileged EXEC mode. <ul style="list-style-type: none"> <li>Enter your password if prompted.</li> </ul>
Step 2	<b>configure terminal</b>  <b>Example:</b> Router# configure terminal	Enters global configuration mode.
Step 3	<b>ipv6 icmp error-interval interval</b>  <b>Example:</b> Router(config)# ipv6 icmp error-interval 1200	Configures the interval for IPv6 ICMP error messages. <ul style="list-style-type: none"> <li><i>interval</i>—Specifies the interval between tokens, in milliseconds, being added to the bucket. The valid range is from 0 to 2147483647.</li> </ul>

## Configuring IPv6 Duplicate Address Detection

## SUMMARY STEPS

1. **enable**
2. **configure terminal**
3. **interface type number**
4. **ipv6 nd dad attempts value**

## DETAILED STEPS

	Command or Action	Purpose
Step 1	<b>enable</b>  <b>Example:</b> Router> enable	Enables privileged EXEC mode. <ul style="list-style-type: none"> <li>Enter your password if prompted.</li> </ul>
Step 2	<b>configure terminal</b>  <b>Example:</b> Router# configure terminal	Enters global configuration mode.
Step 3	<b>interface type number</b>  <b>Example:</b> Router(config)# Interface Vlan 40	Specifies an interface type and number, and places the router in interface configuration mode.

	Command or Action	Purpose
Step 4	<code>ipv6 nd dad attempts value</code>  <b>Example:</b> Router(config)ipv6 nd dad attempts 5	Configures the number of consecutive neighbor solicitation messages that are sent on an interface while duplicate address detection is performed on the unicast IPv6 addresses of the interface.

## Configuring IPv6 Neighbor Discovery

### SUMMARY STEPS

1. `enable`
2. `configure terminal`
3. `interface type number`
4. `ipv6 nd {advertisement-interval | autoconfig | cache | dad | managed-config-flag | na | ns-interval | nud | other-config-flag | prefix | ra | reachable-time | router-preference}`

### DETAILED STEPS

	Command or Action	Purpose
Step 1	<code>enable</code>  <b>Example:</b> Router> enable	Enables privileged EXEC mode. <ul style="list-style-type: none"> <li>• Enter your password if prompted.</li> </ul>
Step 2	<code>configure terminal</code>  <b>Example:</b> Router# configure terminal	Enters global configuration mode.
Step 3	<code>interface type number</code>  <b>Example:</b> Router(config)# Interface fastEthernet 0/0	Specifies an interface type and number, and places the router in interface configuration mode.

	Command or Action	Purpose
Step 4	<pre>ipv6 nd {advertisement-interval   autoconfig   cache   dad   managed-config-flag   na   ns-interval   nud   other-config-flag   prefix   ra   reachable-time   router-preference}</pre> <p><b>Example:</b> Router(config-if)# ipv6 nd autoconfig</p>	<p>Configures a Neighbor Discovery on a specified interface on the router.</p> <ul style="list-style-type: none"> <li>• <b>advertisement-interval</b>—Sends an advertisement interval option in router advertisements (RAs).</li> <li>• <b>autoconfig</b>—Automatic configuration.</li> <li>• <b>cache</b>—Cache entry.</li> <li>• <b>dad</b>—Duplicate Address Detection.</li> <li>• <b>managed-config-flag</b>—Hosts should use DHCP for address config.</li> <li>• <b>na</b>—Neighbor advertisement control. Configures ND to extract an entry from an unsolicited NA.</li> <li>• <b>ns-interval</b>— Sets the advertised NS retransmission interval.</li> <li>• <b>nud</b> —Configures the number of times neighbor unreachability detection (NUD) resends neighbor solicitations (NSs).</li> <li>• <b>other-config-flag</b>—Hosts should use DHCP for non-address config.</li> <li>• <b>prefix</b>—Configures which IPv6 prefixes are included in IPv6 ND router advertisements.</li> <li>• <b>ra</b>—Router advertisement control.</li> <li>• <b>reachable-time</b>—Sets the advertised reachability time.</li> <li>• <b>router-preference</b>—Sets the default router preference value.</li> </ul>

## Configuring IPv6 and IPv4 Dual-Stack on the Same VLAN

### Prerequisites

You should enable IPv6 routing before proceeding with this task. See [“Configuring IPv6 Addressing and Enabling IPv6 Routing”](#) section on page 8.

### SUMMARY STEPS

1. **enable**
2. **configure terminal**
3. **interface** *type number*
4. **ip address** *ip-address mask*
5. **ipv6 address** {*ipv6-address/prefix-length* | *prefix-name sub-bits/prefix-length*}
6. **ipv6 enable**

## DETAILED STEPS

	Command or Action	Purpose
Step 1	<b>enable</b>  <b>Example:</b> Router> enable	Enables privileged EXEC mode. <ul style="list-style-type: none"> <li>Enter your password if prompted.</li> </ul>
Step 2	<b>configure terminal</b>  <b>Example:</b> Router# configure terminal	Enters global configuration mode.
Step 3	<b>interface</b> <i>type number</i>  <b>Example:</b> Router(config)# interface fastEthernet 0/0	Specifies an interface type and number, and places the router in interface configuration mode.
Step 4	<b>ip address</b> <i>ip-address mask</i>  <b>Example:</b> Router(config)# ip address 192.168.99.1 255.255.255.0	Configures an IPv4 address on the interface.
Step 5	<b>ipv6 address</b> { <i>ipv6-address/prefix-length</i>   <i>prefix-name sub-bits/prefix-length</i> }  <b>Example:</b> Router(config)# ipv6 address 2000::1/64	Configures IPv6 address on the interface. <ul style="list-style-type: none"> <li><i>ipv6-address</i>—The IPv6 address to be used.</li> <li><i>prefix-length</i>—The length of the IPv6 prefix. A decimal value that indicates how many of the high-order contiguous bits of the address comprise the prefix (the network portion of the address). A slash mark must precede the decimal value.</li> <li><i>prefix-name</i>—A general prefix, which specifies the leading bits of the network to be configured on the interface.</li> <li><i>sub-bits</i>—The subprefix bits and host bits of the address to be concatenated with the prefixes provided by the general prefix specified with the <i>prefix-name</i> argument.</li> </ul>
Step 6	<b>ipv6 enable</b>  <b>Example:</b> Router(config)# ipv6 enable	Enables IPv6 address on the interface.

## Configuring OSPFv3 for IPv6

## SUMMARY STEPS

- enable
- configure terminal

3. **interface** *type number*
4. **ipv6 ospf** *process-id area area-id [instance instance-id]*

## DETAILED STEPS

	Command or Action	Purpose
Step 1	<b>enable</b>  <b>Example:</b> Router> enable	Enables privileged EXEC mode. <ul style="list-style-type: none"> <li>• Enter your password if prompted.</li> </ul>
Step 2	<b>configure terminal</b>  <b>Example:</b> Router# configure terminal	Enters global configuration mode.
Step 3	<b>interface</b> <i>type number</i>  <b>Example:</b> Router(config)# interface fastEthernet 0/0	Specifies an interface type and number, and places the router in interface configuration mode.
Step 4	<b>ipv6 ospf</b> <i>process-id area area-id [instance instance-id]</i>  <b>Example:</b> Router(config-if)# ipv6 ospf 1 area 0	Enables OSPFv3 on an interface. <ul style="list-style-type: none"> <li>• <i>process-id</i>—Internal identification. It is locally assigned and can be any positive integer. The number used here is the number assigned administratively when enabling the OSPFv3 routing process.</li> <li>• <i>area-id</i>—Area that is to be associated with the OSPFv3 interface.</li> <li>• <i>instance-id</i>—(Optional) Instance identifier.</li> </ul>

## Configuring IS-IS for IPv6

### SUMMARY STEPS

1. **enable**
2. **configure terminal**
3. **router isis** *area-tag*
4. **net** *network-entity-tag*
5. **exit**
6. **interface** *type number*
7. **ipv6 address** {*ipv6-address/prefix-length* | *prefix-name sub-bits/prefix-length*}
8. **ipv6 router isis** *area-name*

## DETAILED STEPS

	Command or Action	Purpose
Step 1	<b>enable</b>  <b>Example:</b> Router> enable	Enables privileged EXEC mode. <ul style="list-style-type: none"> <li>Enter your password if prompted.</li> </ul>
Step 2	<b>configure terminal</b>  <b>Example:</b> Router# configure terminal	Enters global configuration mode.
Step 3	<b>router isis area-tag</b>  <b>Example:</b> Router(config)# router isis area2	Enables IS-IS for the specified IS-IS routing process, and enters router configuration mode. <ul style="list-style-type: none"> <li><i>area-tag</i>—Name for a routing process.</li> </ul>
Step 4	<b>net network-entity-title</b>  <b>Example:</b> Router(config-router)# net 49.0001.0000.0000.000c.00	Configures an IS-IS network entity title (NET) for the routing process. <ul style="list-style-type: none"> <li><i>network-entity-title</i>—The network-entity-title argument defines the area addresses for the IS-IS area and the system ID of the router.</li> </ul>
Step 5	<b>exit</b>  <b>Example:</b> Router(config-router)# exit	Exits router configuration mode and enters global configuration mode.
Step 6	<b>interface type number</b>  <b>Example:</b> Router(config)# interface fastEthernet 0/0	Specifies an interface type and number, and places the router in interface configuration mode.
Step 7	<b>ipv6 address {ipv6-address/prefix-length / prefix-name sub-bits/prefix-length}</b>  <b>Example:</b> Router(config-if)# ipv6 address 2001:DB8::3/64	Specifies the IPv6 network assigned to the interface and enables IPv6 processing on the interface. <ul style="list-style-type: none"> <li><i>ipv6-address</i>—The IPv6 address to be used.</li> <li><i>prefix-length</i>—The length of the IPv6 prefix. A decimal value that indicates how many of the high-order contiguous bits of the address comprise the prefix (the network portion of the address). A slash mark must precede the decimal value.</li> <li><i>prefix-name</i>—A general prefix, which specifies the leading bits of the network to be configured on the interface.</li> <li><i>sub-bits</i>—The subprefix bits and host bits of the address to be concatenated with the prefixes provided by the general prefix specified with the <i>prefix-name</i> argument.</li> </ul>



	Command or Action	Purpose
Step 8	<pre>ipv6 router isis area-name</pre> <p><b>Example:</b> Router(config-if)# ipv6 router isis area2</p>	<p>Enables the specified IPv6 IS-IS routing process on an interface.</p> <ul style="list-style-type: none"> <li><i>area-name</i>—Meaningful name for a routing process. If a name is not specified, a null name is assumed and the process is referenced with a null name. This name must be unique among all IP or Connectionless Network Service (CLNS) router processes for a given router. Required for multiarea IS-IS configuration. Each area in a multiarea configuration should have a non-null area name to facilitate identification of the area. Optional for conventional IS-IS configuration.</li> </ul>

## Configuring Multiprotocol-BGP for IPv6

Perform this task to configure an IPv6 BGP routing process and an optional BGP router ID for a BGP-speaking router.

### SUMMARY STEPS

1. **enable**
2. **configure terminal**
3. **router bgp *as-number***
4. **no bgp default ipv4-unicast**
5. **bgp router-id *ip-address***

### DETAILED STEPS

	Command or Action	Purpose
Step 1	<pre>enable</pre> <p><b>Example:</b> Router&gt; enable</p>	<p>Enables privileged EXEC mode.</p> <ul style="list-style-type: none"> <li>Enter your password if prompted.</li> </ul>
Step 2	<pre>configure terminal</pre> <p><b>Example:</b> Router# configure terminal</p>	<p>Enters global configuration mode.</p>
Step 3	<pre>router bgp as-number</pre> <p><b>Example:</b> Router(config)# router bgp 65000</p>	<p>Configures a BGP routing process, and enters router configuration mode for the specified routing process.</p> <ul style="list-style-type: none"> <li><i>as-number</i>—Number of an autonomous system that identifies the router to other BGP routers and tags the routing information that is passed along. The range is from 1 to 65535.</li> </ul>

	Command or Action	Purpose
Step 4	<code>no bgp default ipv-unicast</code>  <b>Example:</b> Router(config-router)# no bgp default ipv4-unicast	Disables the IPv4 unicast address family for the BGP routing process specified in the previous step.
Step 5	<code>bgp router-id ip-address</code>  <b>Example:</b> Router(config-router)# bgp router-id 192.168.99.70	(Optional) Configures a fixed 32-bit router ID as the identifier of the local router running BGP.

## Configuring BFD for IPv6

Perform the tasks given below to configure Bidirectional Forwarding Detection (BFD) for IPv6:

- [Specifying a Static BFDv6 Neighbor, page 32-22](#)
- [Associating an IPv6 Static Route with a BFDv6 Neighbor, page 32-23](#)

## Specifying a Static BFDv6 Neighbor

### SUMMARY STEPS

1. `enable`
2. `configure terminal`
3. `ipv6 route static bfd [vrf vrf-name] interface-type interface-number ipv6-address [unassociated]`

### DETAILED STEPS

	Command or Action	Purpose
Step 1	<code>enable</code>  <b>Example:</b> Router> enable	Enables privileged EXEC mode. <ul style="list-style-type: none"> <li>• Enter your password if prompted.</li> </ul>
Step 2	<code>configure terminal</code>  <b>Example:</b> Router# configure terminal	Enters global configuration mode.

	Command or Action	Purpose
Step 3	<pre>ipv6 route static bfd [vrf vrf-name] interface-type interface-number ipv6-address [unassociated]</pre> <p><b>Example:</b> Router(config)# ipv6 route static bfd vlan 4000 2001::1</p>	<p>Specifies static route IPv6 BFDv6 neighbors.</p> <ul style="list-style-type: none"> <li><i>vrf-name</i>—(Optional) Name of the virtual routing and forwarding (VRF) instance by which static routes are specified.</li> <li><i>interface-type</i>—Interface type.</li> <li><i>interface-number</i>—SVI name.</li> <li><i>ipv6-address</i>—IPv6 address of the neighbor.</li> <li><b>unassociated</b>—(Optional) Moves a static BFD neighbor from associated mode to unassociated mode.</li> </ul>

## Associating an IPv6 Static Route with a BFDv6 Neighbor

IPv6 static routes are automatically associated with a static BFDv6 neighbor. A static neighbor is associated with a BFDv6 neighbor if the static next-hop explicitly matches the BFDv6 neighbor.

### SUMMARY STEPS

1. **enable**
2. **configure terminal**
3. **ipv6 route static bfd [vrf vrf-name] interface-type interface-number ipv6-address [unassociated]**
4. **ipv6 route [vrf vrf-name] ipv6-prefix/prefix-length { ipv6-address | interface-type [interface-number ipv6-address] } [nexthop-vrf [vrf-name1 | default]] [administrative-distance] [administrative-multicast-distance | unicast | multicast] [next-hop-address] [tag tag]**

### DETAILED STEPS

	Command or Action	Purpose
Step 1	<pre>enable</pre> <p><b>Example:</b> Router&gt; enable</p>	<p>Enables privileged EXEC mode.</p> <ul style="list-style-type: none"> <li>Enter your password if prompted.</li> </ul>
Step 2	<pre>configure terminal</pre> <p><b>Example:</b> Router# configure terminal</p>	<p>Enters global configuration mode.</p>

Command or Action	Purpose
<p><b>Step 3</b></p> <pre>ipv6 route static bfd [vrf vrf-name] interface-type interface-number ipv6-address [unassociated]</pre> <p><b>Example:</b> Router(config)# ipv6 route static bfd vlan 4000 2001::1</p>	<p>Specifies static route IPv6 BFDv6 neighbors.</p> <ul style="list-style-type: none"> <li>• <i>vrf-name</i>—(Optional) Name of the virtual routing and forwarding (VRF) instance by which static routes are specified.</li> <li>• <i>interface-type</i>—Interface type.</li> <li>• <i>interface-number</i>—SVI name.</li> <li>• <i>ipv6-address</i>—IPv6 address of the neighbor.</li> <li>• <b>unassociated</b>—(Optional) Moves a static BFD neighbor from associated mode to unassociated mode.</li> </ul>
<p><b>Step 4</b></p> <pre>ipv6 route [vrf vrf-name] ipv6-prefix/prefix-length {ipv6-address   interface-type [interface-number ipv6-address]} [nexthop-vrf [vrf-name1   default]] [administrative-distance] [administrative-multicast-distance   unicast   multicast] [next-hop-address] [tag tag]</pre> <p><b>Example:</b> Router(config)# ipv6 route 2001:DB8::/64 vlan 4000 2001::1</p>	<p>Establishes static IPv6 routes.</p> <ul style="list-style-type: none"> <li>• <i>vrf-name</i>—(Optional) Name of the virtual routing and forwarding (VRF) instance by which static routes are specified.</li> <li>• <i>ipv6-prefix</i>—The IPv6 network that is the destination of the static route. Can also be a host name when static host routes are configured.</li> <li>• <i>ipv6-address</i>—The IPv6 address of the next hop that can be used to reach the specified network.</li> <li>• <i>interface-type</i>—Interface type.</li> <li>• <i>interface-number</i>—SVI name.</li> <li>• <b>nexthop-vrf</b>—(Optional) Indicator that the next hop is a VRF.</li> <li>• <i>vrf-name1</i>—(Optional) Name of the next-hop VRF.</li> <li>• <b>default</b>—(Optional) Indicator that the next hop is the default.</li> <li>• <i>administrative-distance</i>—(Optional) An administrative distance. The default value is 1, which gives static routes precedence over any other type of route except connected routes.</li> <li>• <i>administrative-multicast-distance</i>—(Optional) The distance used when selecting this route for multicast Reverse Path Forwarding (RPF).</li> <li>• <b>unicast</b>—(Optional) Specifies a route that must not be used in multicast RPF selection.</li> <li>• <b>multicast</b>—(Optional) Specifies a route that must not be populated in the unicast Routing Information Base (RIB).</li> <li>• <i>next-hop-address</i>—(Optional) Address of the next hop that can be used to reach the specified network.</li> <li>• <b>tag tag</b>—(Optional) Tag value that is used as a “match” value for controlling redistribution via route maps.</li> </ul>

## Configuring BFDv6 and OSPFv3

This section describes the procedures for configuring BFD support for OSPFv3, so that OSPFv3 is a registered protocol with BFD and will receive forwarding path detection failure messages from BFD.

There are two methods for enabling BFD support for OSPFv3:

- You can enable BFD for all of the interfaces for which OSPFv3 is routing by using the **bfd all-interfaces** command in router configuration mode.
- You can enable BFD for a subset of the interfaces for which OSPFv3 is routing by using the **ipv6 ospf bfd** command in interface configuration mode.

### Prerequisites

- OSPFv3 must be running on all participating routers.
- The baseline parameters for BFD sessions on the interfaces over which you want to run BFD sessions to BFD neighbors must be configured.

### SUMMARY STEPS

1. **enable**
2. **configure terminal**
3. **ipv6 router ospf** *process-id*
4. **bfd all-interfaces**
5. **exit**

### DETAILED STEPS

	Command or Action	Purpose
Step 1	<b>enable</b>  <b>Example:</b> Router> enable	Enables privileged EXEC mode. <ul style="list-style-type: none"> <li>• Enter your password if prompted.</li> </ul>
Step 2	<b>configure terminal</b>  <b>Example:</b> Router# configure terminal	Enters global configuration mode.
Step 3	<b>ipv6 router ospf</b> <i>process-id</i>  <b>Example:</b> Router(config)# ipv6 router ospf 2	Configures an OSPFv3 routing process. <ul style="list-style-type: none"> <li>• <i>process-id</i>—Internal identification. It is locally assigned and can be a positive integer from 1 to 65535. The number used here is the number assigned administratively when enabling the OSPF for IPv6 routing process.</li> </ul>

	Command or Action	Purpose
Step 4	<b>bfd all-interfaces</b>  <b>Example:</b> Router(config-rtr)# bfd all-interfaces	Enables BFD for all interfaces participating in the routing process
Step 5	<b>end</b>  <b>Example:</b> Router(config-rtr)# end	Enter this command twice to go to privileged EXEC mode.

## Configuring BFDv6 for BGP

### SUMMARY STEPS

1. **enable**
2. **configure terminal**
3. **router bgp** *as-tag*
4. **neighbor ip-address fall-over bfd**
5. **exit**

### DETAILED STEPS

	Command or Action	Purpose
Step 1	<b>enable</b>  <b>Example:</b> Router> enable	Enables privileged EXEC mode. <ul style="list-style-type: none"> <li>• Enter your password if prompted.</li> </ul>
Step 2	<b>configure terminal</b>  <b>Example:</b> Router# configure terminal	Enters global configuration mode.
Step 3	<b>router bgp</b> <i>as-tag</i>  <b>Example:</b> Router(config)# router bgp 4500	Specifies a BGP process and enter router configuration mode. <ul style="list-style-type: none"> <li>• <i>as-tag</i>—Number of an autonomous system that identifies the router to other BGP routers and tags the routing information that is passed along. The range is from 1 to 65535.</li> </ul>
Step 4	<b>neighbor ip-address fall-over bfd</b>  <b>Example:</b> Router(config-router)# neighbor 10.0.0.1 fall-over bfd	Enables support for BFD failover. <ul style="list-style-type: none"> <li>• <i>ip-address</i>—IPv4 or IPv6 address of a BGP neighbor.</li> <li>• <b>bfd</b>—Enables BFD protocol support for failover.</li> </ul>

	Command or Action	Purpose
Step 5	<code>exit</code>	Exits global configuration mode and enters privileged EXEC mode.
	<b>Example:</b> <code>Router(config-router)# exit</code>	

## Implementing QoS for IPv6

The QoS implementation for IPv6 environment in the Cisco ASR router is the same as that of IPv4. For configuration information on Configuring QoS on the Cisco ASR 901 router, refer the following link:

[http://www.cisco.com/en/US/docs/wireless/asr\\_901/Configuration/Guide/qos.html](http://www.cisco.com/en/US/docs/wireless/asr_901/Configuration/Guide/qos.html)

For additional information on Implementing QoS for IPv6, refer the following link:

<http://www.cisco.com/en/US/docs/ios-xml/ios/ipv6/configuration/15-2mt/ipv6-qos.html>

## Verifying the Configuration of IPv6 Support on the Cisco ASR 901 Router

This section describes how to use the **show** commands to verify the configuration and operation of the IPv6 Support feature on the Cisco ASR 901 router, and it contains the following topics:

- [Verifying IPv6 Addressing Routing, page 32-27](#)
- [Verifying a Static IPv6 Route, page 32-28](#)
- [Verifying a Stateless Auto-Configuration, page 32-29](#)
- [Verifying IPv6 Implementation on VLAN Interfaces, page 32-29](#)
- [Verifying IPv6 Implementation on Loopback Interfaces, page 32-30](#)
- [Verifying ICMPv6 Configuration, page 32-30](#)
- [Verifying IPv6 Duplicate Address Detection Configuration, page 32-32](#)
- [Verifying IPv6 Neighbor Discovery Configuration, page 32-33](#)
- [Verifying IPv6 and IPv4 Dual-Stack Configuration, page 32-33](#)
- [Verifying OSPFv3 for IPv6 Configuration, page 32-34](#)
- [Verifying IS-IS for IPv6 Configuration, page 32-35](#)
- [Verifying Multiprotocol-BGP for IPv6 Configuration, page 32-35](#)
- [Verifying BFD for IPv6 Configuration, page 32-37](#)
- [Verifying BFDv6 and OSPFv3 Configuration, page 32-38](#)
- [Verifying BFDv6 for BGP Configuration, page 32-39](#)

## Verifying IPv6 Addressing Routing

To verify the IPv6 Addressing Routing information, use the **show ipv6 interface** command in privileged EXEC mode, as shown in the example.

```
Router# show ipv6 interface
```

```

Vlan40 is up, line protocol is up
  IPv6 is enabled, link-local address is FE80::4255:39FF:FE89:4831
  No Virtual link-local address(es):
  Global unicast address(es):
    2011:8:8:3::4, subnet is 2011:8:8:3::/64
  Joined group address(es):
    FF02::1
    FF02::2
    FF02::5
    FF02::6
    FF02::1:FF00:4
    FF02::1:FF89:4831
  MTU is 1500 bytes
  ICMP error messages limited to one every 100 milliseconds
  ICMP redirects are enabled
  ICMP unreachable are sent
  ND DAD is enabled, number of DAD attempts: 1
  ND reachable time is 30000 milliseconds (using 30000)
  ND advertised reachable time is 0 (unspecified)
  ND advertised retransmit interval is 0 (unspecified)
  ND router advertisements are sent every 200 seconds
  ND router advertisements live for 1800 seconds
  ND advertised default router preference is Medium
  Hosts use stateless autoconfig for addresses.
Loopback0 is up, line protocol is up
  IPv6 is enabled, link-local address is FE80::4255:39FF:FE89:4831
  No Virtual link-local address(es):
  Global unicast address(es):
    FE01:4::4, subnet is FE01:4::/64
  Joined group address(es):
    FF02::1
    FF02::2
    FF02::5
    FF02::1:FF00:4
    FF02::1:FF89:4831
  MTU is 1514 bytes
  ICMP error messages limited to one every 100 milliseconds
  ICMP redirects are enabled
  ICMP unreachable are sent
  ND DAD is not supported
  ND reachable time is 30000 milliseconds (using 30000)
  ND RAs are suppressed (periodic)
  Hosts use stateless autoconfig for addresses.

```

## Verifying a Static IPv6 Route

To verify the static IPv6 route information, use the **show ipv6 route** command in privileged EXEC mode, as shown in the example.

```

Router# show ipv6 route

IPv6 Routing Table - default - 19 entries
Codes: C - Connected, L - Local, S - Static, U - Per-user Static route
       B - BGP, R - RIP, H - NHRP, I1 - ISIS L1
       I2 - ISIS L2, IA - ISIS interarea, IS - ISIS summary, D - EIGRP
       EX - EIGRP external, ND - ND Default, NDp - ND Prefix, DCE - Destination
       NDr - Redirect
       O - OSPF Intra, OI - OSPF Inter, OE1 - OSPF ext 1, OE2 - OSPF ext 2
       ON1 - OSPF NSSA ext 1, ON2 - OSPF NSSA ext 2
C    22::/64 [0/0]
    via Vlan111, directly connected

```



```

L 22::22/128 [0/0]
   via Vlan111, receive
C 33::/64 [0/0]
   via Vlan111, directly connected
L 33::33/128 [0/0]
   via Vlan111, receive
I1 454::/96 [115/20]
   via FE80::4255:39FF:FE89:3F71, Vlan2020

```

## Verifying a Stateless Auto-Configuration

To verify the autoconfigured IPv6 address and its state, use the **show ipv6 interface** command in privileged EXEC mode, as shown in the example.

```

Router# show ipv6 interface loopback 0

Loopback0 is up, line protocol is up
IPv6 is enabled, link-local address is FE80::4255:39FF:FE89:4831
No Virtual link-local address(es):
Global unicast address(es):
  FE01:4::4, subnet is FE01:4::/64
Joined group address(es):
  FF02::1
  FF02::2
  FF02::5
  FF02::1:FF00:4
  FF02::1:FF89:4831
MTU is 1514 bytes
ICMP error messages limited to one every 100 milliseconds
ICMP redirects are enabled
ICMP unreachable are sent
ND DAD is not supported
ND reachable time is 30000 milliseconds (using 30000)
ND RAs are suppressed (periodic)
Hosts use stateless autoconfig for addresses.

```

## Verifying IPv6 Implementation on VLAN Interfaces

To verify the IPv6 implementation on VLAN interfaces, use the **show ipv6 interface** command in privileged EXEC mode, as shown in the example.

```

Router# show ipv6 interface vlan40

Vlan40 is up, line protocol is up
IPv6 is enabled, link-local address is FE80::4255:39FF:FE89:4831
No Virtual link-local address(es):
Global unicast address(es):
  2011:8:8:3::4, subnet is 2011:8:8:3::/64
Joined group address(es):
  FF02::1
  FF02::2
  FF02::5
  FF02::6
  FF02::1:FF00:4
  FF02::1:FF89:4831
MTU is 1500 bytes
ICMP error messages limited to one every 100 milliseconds
ICMP redirects are enabled
ICMP unreachable are sent

```

```

ND DAD is enabled, number of DAD attempts: 1
ND reachable time is 30000 milliseconds (using 30000)
ND advertised reachable time is 0 (unspecified)
ND advertised retransmit interval is 0 (unspecified)
ND router advertisements are sent every 200 seconds
ND router advertisements live for 1800 seconds
ND advertised default router preference is Medium
Hosts use stateless autoconfig for addresses.

```

## Verifying IPv6 Implementation on Loopback Interfaces

To verify the IPv6 implementation on loopback interfaces, use the **show ipv6 interface** command in privileged EXEC mode, as shown in the example.

```

Router# show ipv6 interface loopback0

Loopback0 is up, line protocol is up
IPv6 is enabled, link-local address is FE80::4255:39FF:FE89:4831
No Virtual link-local address(es):
Global unicast address(es):
  FE01:4::4, subnet is FE01:4::/64
Joined group address(es):
  FF02::1
  FF02::2
  FF02::5
  FF02::1:FF00:4
  FF02::1:FF89:4831
MTU is 1514 bytes
ICMP error messages limited to one every 100 milliseconds
ICMP redirects are enabled
ICMP unreachable are sent
ND DAD is not supported
ND reachable time is 30000 milliseconds (using 30000)
ND RAs are suppressed (periodic)
Hosts use stateless autoconfig for addresses.

```

## Verifying ICMPv6 Configuration

To verify the ICMPv6 configuration information, use the **show ipv6 interface** command in privileged EXEC mode, as shown in the example.

```

Router# show ipv6 interface

Vlan40 is up, line protocol is up
IPv6 is enabled, link-local address is FE80::4255:39FF:FE89:4831
No Virtual link-local address(es):
Global unicast address(es):
  2011:8:8:3::4, subnet is 2011:8:8:3::/64
Joined group address(es):
  FF02::1
  FF02::2
  FF02::5
  FF02::6
  FF02::1:FF00:4
  FF02::1:FF89:4831
MTU is 1500 bytes
ICMP error messages limited to one every 100 milliseconds
ICMP redirects are enabled
ICMP unreachable are sent

```

```

ND DAD is enabled, number of DAD attempts: 1
ND reachable time is 30000 milliseconds (using 30000)
ND advertised reachable time is 0 (unspecified)
ND advertised retransmit interval is 0 (unspecified)
ND router advertisements are sent every 200 seconds
ND router advertisements live for 1800 seconds
ND advertised default router preference is Medium
Hosts use stateless autoconfig for addresses.
Loopback0 is up, line protocol is up
IPv6 is enabled, link-local address is FE80::4255:39FF:FE89:4831
No Virtual link-local address(es):
Global unicast address(es):
  FE01:4::4, subnet is FE01:4::/64
Joined group address(es):
  FF02::1
  FF02::2
  FF02::5
  FF02::1:FF00:4
  FF02::1:FF89:4831
MTU is 1514 bytes
ICMP error messages limited to one every 100 milliseconds
ICMP redirects are enabled
ICMP unreachable are sent
ND DAD is not supported
ND reachable time is 30000 milliseconds (using 30000)
ND RAs are suppressed (periodic)
Hosts use stateless autoconfig for addresses.

```

To verify the ICMPv6 statistics, use the **show ipv6 traffic** command in privileged EXEC mode, as shown in the example.

```
Router# show ipv6 traffic
```

```

IPv6 statistics:
  Rcvd: 8 total, 0 local destination
        0 source-routed, 0 truncated
        0 format errors, 0 hop count exceeded
        0 bad header, 0 unknown option, 0 bad source
        0 unknown protocol, 0 not a router
        0 fragments, 0 total reassembled
        0 reassembly timeouts, 0 reassembly failures
  Sent: 870 generated, 0 forwarded
        0 fragmented into 0 fragments, 0 failed
        0 encapsulation failed, 0 no route, 0 too big
        0 RPF drops, 0 RPF suppressed drops
  Mcast: 8 received, 855 sent

ICMP statistics:
  Rcvd: 8 input, 0 checksum errors, 0 too short
        0 unknown info type, 0 unknown error type
  unreach: 0 routing, 0 admin, 0 neighbor, 0 address, 0 port
           0 sa policy, 0 reject route
  parameter: 0 error, 0 header, 0 option
            0 hopcount expired, 0 reassembly timeout, 0 too big
            0 echo request, 0 echo reply
            0 group query, 0 group report, 0 group reduce
            0 router solicit, 0 router advert, 0 redirects
            0 neighbor solicit, 0 neighbor advert
  Sent: 129 output, 0 rate-limited
        unreach: 0 routing, 0 admin, 0 neighbor, 0 address, 0 port
               0 sa policy, 0 reject route
        parameter: 0 error, 0 header, 0 option
                  0 hopcount expired, 0 reassembly timeout, 0 too big
                  0 echo request, 0 echo reply

```

```

0 group query, 0 group report, 0 group reduce
0 router solicit, 50 router advert, 0 redirects
8 neighbor solicit, 8 neighbor advert

UDP statistics:
  Rcvd: 0 input, 0 checksum errors, 0 length errors
        0 no port, 0 dropped
  Sent: 0 output

TCP statistics:
  Rcvd: 0 input, 0 checksum errors
  Sent: 0 output, 0 retransmitted

```

## Verifying IPv6 Duplicate Address Detection Configuration

To verify the IPv6 Duplicate Address Detection configuration information, use the **show running configuration** command or the **show ipv6 interface** command in privileged EXEC mode, as shown in the example.

```

Router# show ipv6 interface

Vlan40 is up, line protocol is up
  IPv6 is enabled, link-local address is FE80::4255:39FF:FE89:4831
  No Virtual link-local address(es):
  Global unicast address(es):
    2011:8:8:3::4, subnet is 2011:8:8:3::/64
  Joined group address(es):
    FF02::1
    FF02::2
    FF02::5
    FF02::6
    FF02::1:FF00:4
    FF02::1:FF89:4831
  MTU is 1500 bytes
  ICMP error messages limited to one every 100 milliseconds
  ICMP redirects are enabled
  ICMP unreachable are sent
  ND DAD is enabled, number of DAD attempts: 1
  ND reachable time is 30000 milliseconds (using 30000)
  ND advertised reachable time is 0 (unspecified)
  ND advertised retransmit interval is 0 (unspecified)
  ND router advertisements are sent every 200 seconds
  ND router advertisements live for 1800 seconds
  ND advertised default router preference is Medium
  Hosts use stateless autoconfig for addresses.
Loopback0 is up, line protocol is up
  IPv6 is enabled, link-local address is FE80::4255:39FF:FE89:4831
  No Virtual link-local address(es):
  Global unicast address(es):
    FE01:4::4, subnet is FE01:4::/64
  Joined group address(es):
    FF02::1
    FF02::2
    FF02::5
    FF02::1:FF00:4
    FF02::1:FF89:4831
  MTU is 1514 bytes
  ICMP error messages limited to one every 100 milliseconds
  ICMP redirects are enabled
  ICMP unreachable are sent
  ND DAD is not supported

```

```

ND reachable time is 30000 milliseconds (using 30000)
ND RAs are suppressed (periodic)
Hosts use stateless autoconfig for addresses.

```

## Verifying IPv6 Neighbor Discovery Configuration

To verify the IPv6 neighbor discovery configuration, use the **show ipv6 neighbors** command in privileged EXEC mode, as shown in the example.

```
Router# show ipv6 neighbors detail
```

IPv6 Address	TRLV	Age	Link-layer Addr	State	Interface
2001:103::2	0	0	001e.4a97.05bb	REACH	Vl103
2001:101::2	0	0	001e.4a97.05bb	REACH	Vl101
2001:300::2	0	72	001e.4a97.05bb	STALE	Vl300
2001:10::2	0	0	001e.4a97.05bb	REACH	Vl10
FE80::200:1FF:FE97:41FE	0	65	0000.0197.41fe	STALE	Vl190
FE80::21E:4AFF:FE97:5BB	0	25	001e.4a97.05bb	STALE	Vl101
FE80::21E:4AFF:FE97:5BB	0	0	001e.4a97.05bb	REACH	Vl10
FE80::21E:4AFF:FE97:5BB	0	0	001e.4a97.05bb	REACH	Vl170
FE80::21E:4AFF:FE97:5BB	0	0	001e.4a97.05bb	STALE	Vl160
2001:170::2	0	0	001e.4a97.05bb	REACH	Vl170
2001:180::2	0	0	001e.4a97.05bb	REACH	Vl180
2001:190::2	0	0	001e.4a97.05bb	REACH	Vl190

## Verifying IPv6 and IPv4 Dual-Stack Configuration

To verify the IPv6 and IPv4 dual-stack configuration, use the **show ipv6 interface** or **show ip interface** commands in privileged EXEC mode, as shown in the examples.

```
Router# show ipv6 interface loopback0
```

```

Loopback0 is up, line protocol is up
IPv6 is enabled, link-local address is FE80::4255:39FF:FE89:4831
No Virtual link-local address(es):
Global unicast address(es):
  FE01:4::4, subnet is FE01:4::/64
Joined group address(es):
  FF02::1
  FF02::2
  FF02::5
  FF02::1:FF00:4
  FF02::1:FF89:4831
MTU is 1514 bytes
ICMP error messages limited to one every 100 milliseconds
ICMP redirects are enabled
ICMP unreachable are sent
ND DAD is not supported
ND reachable time is 30000 milliseconds (using 30000)
ND RAs are suppressed (periodic)
Hosts use stateless autoconfig for addresses.

```

```
Router# show ip interface
```

```

GigabitEthernet0/0 is down, line protocol is down
  Inbound access list is not set
  Outgoing access list is not set
  Internet protocol processing disabled
GigabitEthernet0/1 is administratively down, line protocol is down

```

```

Inbound access list is not set
Outgoing access list is not set
Internet protocol processing disabled
GigabitEthernet0/2 is up, line protocol is up
Inbound access list is not set
Outgoing access list is not set
Internet protocol processing disabled
GigabitEthernet0/3 is up, line protocol is up
Inbound access list is not set
Outgoing access list is not set
Internet protocol processing disabled
GigabitEthernet0/4 is down, line protocol is down
Inbound access list is not set
Outgoing access list is not set
Internet protocol processing disabled
GigabitEthernet0/5 is down, line protocol is down
Inbound access list is not set
Outgoing access list is not set
Internet protocol processing disabled
GigabitEthernet0/6 is down, line protocol is down
Inbound access list is not set
Outgoing access list is not set
Internet protocol processing disabled
GigabitEthernet0/7 is down, line protocol is down
Inbound access list is not set
Outgoing access list is not set
Internet protocol processing disabled
GigabitEthernet0/8 is down, line protocol is down
Inbound access list is not set
Outgoing access list is not set
Internet protocol processing disabled
GigabitEthernet0/9 is down, line protocol is down
Inbound access list is not set
Outgoing access list is not set
Internet protocol processing disabled
GigabitEthernet0/10 is down, line protocol is down
Inbound access list is not set
Outgoing access list is not set
Internet protocol processing disabled
GigabitEthernet0/11 is down, line protocol is down
Inbound access list is not set
Outgoing access list is not set
Internet protocol processing disabled
FastEthernet0/0 is administratively down, line protocol is down
Internet protocol processing disabled
Vlan1 is down, line protocol is down
Internet protocol processing disabled
Vlan40 is up, line protocol is up
Internet protocol processing disabled
Loopback0 is up, line protocol is up
Internet protocol processing disabled

```

## Verifying OSPFv3 for IPv6 Configuration

To verify the OSPF for IPv6 configuration, use the **show ipv6 ospf** command in privileged EXEC mode, as shown in the example.

```
Router# show ipv6 ospf
```

```

Routing Process "ospfv3 10" with ID 4.4.4.4
Event-log enabled, Maximum number of events: 1000, Mode: cyclic

```

```

Router is not originating router-LSAs with maximum metric
Initial SPF schedule delay 5000 msec
Minimum hold time between two consecutive SPFs 10000 msec
Maximum wait time between two consecutive SPFs 10000 msec
Minimum LSA interval 5 sec
Minimum LSA arrival 1000 msec
LSA group pacing timer 240 sec
Interface flood pacing timer 33 msec
Retransmission pacing timer 66 msec
Number of external LSA 0. Checksum Sum 0x000000
Number of areas in this router is 1. 1 normal 0 stub 0 nssa
Graceful restart helper support enabled
Reference bandwidth unit is 100 mbps
RFC1583 compatibility enabled
Area 34
  Number of interfaces in this area is 2
  SPF algorithm executed 5 times
  Number of LSA 3. Checksum Sum 0x01F6C1
  Number of DCbitless LSA 0
  Number of indication LSA 0
  Number of DoNotAge LSA 0
  Flood list length 0

```

## Verifying IS-IS for IPv6 Configuration

To verify the IPv6 Addressing Routing information, use the **show isis ipv6 rib** command in privileged EXEC mode, as shown in the example.

```
Router# show isis ipv6 rib
```

```
IS-IS IPv6 process area2, local RIB
```

## Verifying Multiprotocol-BGP for IPv6 Configuration

To verify the IPv6 Addressing Routing information, use the **show bgp ipv6** command in privileged EXEC mode, as shown in the examples.

```
Router# show bgp ipv6 unicast summary
```

```

BGP router identifier 9.9.9.9, local AS number 5500
BGP table version is 25, main routing table version 25
15 network entries using 2580 bytes of memory
53 path entries using 4664 bytes of memory
3/3 BGP path/bestpath attribute entries using 384 bytes of memory
1 BGP AS-PATH entries using 24 bytes of memory
0 BGP route-map cache entries using 0 bytes of memory
0 BGP filter-list cache entries using 0 bytes of memory
BGP using 7652 total bytes of memory
BGP activity 43/2 prefixes, 134/46 paths, scan interval 60 secs

```

Neighbor	V	AS	MsgRcvd	MsgSent	TblVer	InQ	OutQ	Up/Down	State/PfxRcd
2001:10::2	4	6500	0	0	1	0	0	00:22:30	Idle
2001:101::2	4	6500	87	84	25	0	0	01:09:28	8
2001:103::2	4	6500	84	83	25	0	0	01:09:34	8
2001:170::2	4	6500	88	82	25	0	0	01:09:33	8
2001:180::2	4	6500	87	84	25	0	0	01:09:29	8
2001:190::2	4	6500	89	83	25	0	0	01:09:34	8
Neighbor	V	AS	MsgRcvd	MsgSent	TblVer	InQ	OutQ	Up/Down	State/PfxRcd
2001:300::2	4	6500	0	0	1	0	0	01:09:23	Idle

```
FE80::21E:4AFF:FE97:5BB%Vlan160
      4          6500      82      82      25      0      0 01:09:25      5
```

```
Router# show bgp ipv6 unicast neighbors 2001:101::2
```

```
BGP neighbor is 2001:101::2, remote AS 6500, external link
Fall over configured for session
BFD is configured. Using BFD to detect fast fallover
  BGP version 4, remote router ID 14.14.14.14
  BGP state = Established, up for 01:09:48
  Last read 00:00:10, last write 00:00:23, hold time is 180, keepalive interval is 60
seconds
```

```
Neighbor sessions:
```

```
  1 active, is not multiseession capable (disabled)
```

```
Neighbor capabilities:
```

```
  Route refresh: advertised and received(new)
  Four-octets ASN Capability: advertised and received
  Address family IPv6 Unicast: advertised and received
  Enhanced Refresh Capability: advertised and received
  Multiseession Capability:
  Stateful switchover support enabled: NO for session 1
```

```
Message statistics:
```

```
  InQ depth is 0
  OutQ depth is 0
```

	Sent	Rcvd
Opens:	1	1
Notifications:	0	0
Updates:	8	9
Keepalives:	75	76
Route Refresh:	0	0
Total:	84	88

```
Default minimum time between advertisement runs is 30 seconds
```

```
For address family: IPv6 Unicast
```

```
Session: 2001:101::2
BGP table version 25, neighbor version 25/0
Output queue size : 0
Index 1, Advertise bit 0
1 update-group member
Slow-peer detection is disabled
Slow-peer split-update-group dynamic is disabled
```

	Sent	Rcvd
Prefix activity:	----	----
Prefixes Current:	15	8 (Consumes 704 bytes)
Prefixes Total:	16	10
Implicit Withdraw:	0	0
Explicit Withdraw:	1	2
Used as bestpath:	n/a	3
Used as multipath:	n/a	0

	Outbound	Inbound
Local Policy Denied Prefixes:	-----	-----
AS_PATH loop:	n/a	4
Invalid Path:	2	n/a
Total:	2	4

```
Number of NLRI in the update sent: max 7, min 0
```

```
Last detected as dynamic slow peer: never
```

```
Dynamic slow peer recovered: never
```

```
Refresh Epoch: 2
```

```
Last Sent Refresh Start-of-rib: never
```

```
Last Sent Refresh End-of-rib: never
```

```
Last Received Refresh Start-of-rib: 01:09:48
```

```
Last Received Refresh End-of-rib: 01:09:48
```



```

Refresh-In took 0 seconds

Refresh activity:
Refresh Start-of-RIB      0      1
Refresh End-of-RIB       0      1

Address tracking is disabled
Connections established 1; dropped 0
Last reset never
Transport(tcp) path-mtu-discovery is enabled
Graceful-Restart is disabled
Connection state is ESTAB, I/O status: 1, unread input bytes: 0
Connection is ECN Disabled
Minimum incoming TTL 0, Outgoing TTL 1
Local host: 2001:101::1, Local port: 57438
Foreign host: 2001:101::2, Foreign port: 179
Connection tableid (VRF): 0

Enqueued packets for retransmit: 0, input: 0 mis-ordered: 0 (0 bytes)

Event Timers (current time is 0x4853F8):
Timer           Starts    Wakeups      Next
Retrans         83        0            0x0
TimeWait        0         0            0x0
AckHold         83        81           0x0
SendWnd         0         0            0x0
KeepAlive       0         0            0x0
GiveUp          0         0            0x0
PmtuAger        10940     10939        0x485427
DeadWait        0         0            0x0
Linger          0         0            0x0

iss: 338855921 snduna: 338858128 sndnxt: 338858128   sndwnd: 15636
irs: 816933509 rcvnxt: 816935775 rcvwnd: 15571   delrcvwnd: 813

SRTT: 300 ms, RTTO: 303 ms, RTV: 3 ms, KRTT: 0 ms
minRTT: 0 ms, maxRTT: 300 ms, ACK hold: 200 ms
Status Flags: none
Option Flags: higher precedence, nagle, path mtu capable

Datagrams (max data segment is 1440 bytes):
Rcvd: 163 (out of order: 0), with data: 86, total data bytes: 2265
Sent: 167 (retransmit: 0 fastretransmit: 0),with data: 167, total data bytes: 8894

```

## Verifying BFD for IPv6 Configuration

To verify the IPv6 Addressing Routing information, use the **show bfd neighbors** command in privileged EXEC mode, as shown in the example.

```
Router# show bfd neighbors
```

```

IPv4 Sessions
NeighAddr          LD/RD          RH/RS          State          Int
101.101.101.2      6/5            Up             Up             V1101
103.103.103.2      7/6            Up             Up             V1103
150.150.150.2      2/1            Up             Up             V1150

IPv6 Sessions
NeighAddr          LD/RD          RH/RS          State          Int
2001:10::2         16/14         Up             Up             V110

```

2001:101::2	12/11	Up	Up	Vl101
2001:103::2	3/2	Up	Up	Vl103
2001:170::2	8/7	Up	Up	Vl170
2001:180::2	11/10	Up	Up	Vl180
2001:190::2	4/3	Up	Up	Vl190
FE80::21E:4AFF:FE97:5BB	13/12	Up	Up	Vl160
CE1-2009#				

## Verifying BFDv6 and OSPFv3 Configuration

To verify the BFDv6 and OSPFv3 configuration, use the **show bfd neighbors** or the **show ipv6 ospf** command in privileged EXEC mode, as shown in the examples.

```
Router# show bfd neighbors
```

```
IPv4 Sessions
```

NeighAddr	LD/RD	RH/RS	State	Int
101.101.101.2	6/5	Up	Up	Vl101
103.103.103.2	7/6	Up	Up	Vl103
150.150.150.2	2/1	Up	Up	Vl150

```
IPv6 Sessions
```

NeighAddr	LD/RD	RH/RS	State	Int
2001:10::2	16/14	Up	Up	Vl10
2001:101::2	12/11	Up	Up	Vl101
2001:103::2	3/2	Up	Up	Vl103
2001:170::2	8/7	Up	Up	Vl170
2001:180::2	11/10	Up	Up	Vl180
2001:190::2	4/3	Up	Up	Vl190
FE80::21E:4AFF:FE97:5BB	13/12	Up	Up	Vl160

```
Router# show ipv6 ospf
```

```
Routing Process "ospfv3 10" with ID 4.4.4.4
Event-log enabled, Maximum number of events: 1000, Mode: cyclic
Router is not originating router-LSAs with maximum metric
Initial SPF schedule delay 5000 msec
Minimum hold time between two consecutive SPF's 10000 msec
Maximum wait time between two consecutive SPF's 10000 msec
Minimum LSA interval 5 secs
Minimum LSA arrival 1000 msec
LSA group pacing timer 240 secs
Interface flood pacing timer 33 msec
Retransmission pacing timer 66 msec
Number of external LSA 0. Checksum Sum 0x000000
Number of areas in this router is 1. 1 normal 0 stub 0 nssa
Graceful restart helper support enabled
Reference bandwidth unit is 100 mbps
RFC1583 compatibility enabled
  Area 34
    Number of interfaces in this area is 2
    SPF algorithm executed 11 times
    Number of LSA 3. Checksum Sum 0x01D6D1
    Number of DCbitless LSA 0
    Number of indication LSA 0
    Number of DoNotAge LSA 0
    Flood list length 0
```

## Verifying BFDv6 for BGP Configuration

To verify the BFDv6 for BGP configuration, use the **show bfd neighbors** command in privileged EXEC mode, as shown in the example.

```
Router# show bfd neighbors
IPv4 Sessions
NeighAddr                LD/RD          RH/RS          State          Int
101.101.101.2            6/5            Up             Up             V1101
103.103.103.2            7/6            Up             Up             V1103
150.150.150.2            2/1            Up             Up             V1150

IPv6 Sessions
NeighAddr                LD/RD          RH/RS          State          Int
2001:10::2               16/14          Up             Up             V110
2001:101::2              12/11          Up             Up             V1101
2001:103::2              3/2            Up             Up             V1103
2001:170::2              8/7            Up             Up             V1170
2001:180::2              11/10          Up             Up             V1180
2001:190::2              4/3            Up             Up             V1190
FE80::21E:4AFF:FE97:5BB  13/12          Up             Up             V1160
CE1-2009#
```

# Configuration Examples for IPv6 Support on the Cisco ASR 901 Router

This section provides sample configuration examples for IPv6 Support on the Cisco ASR 901 Router feature.

- [Example: IPv6 Addressing on VLAN Interfaces, page 32-40](#)
- [Example: IPv6 Addressing on Loopback Interfaces, page 32-40](#)
- [Example: Customizing ICMPv6, page 32-40](#)
- [Example: Configuring IPv6 Duplicate Address Detection, page 32-40](#)
- [Example: Configuring IPv6 Neighborhood Discovery, page 32-41](#)
- [Example: Enabling IPv6 Stateless Address Autoconfiguration, page 32-41](#)
- [Example: Configuring the IPv4 and IPv6 Dual-Stack, page 32-41](#)
- [Example: Configuring IPv6 Static Routing, page 32-41](#)
- [Example: Configuring BFD and Static Routing for IPv6, page 32-42](#)
- [Example: Configuring OSPFv3 for IPv6, page 32-42](#)
- [Example: Configuring BFD and OSPFv3 for IPv6, page 32-42](#)
- [Example: Configuring IS-IS for IPv6, page 32-43](#)
- [Example: Configuring Multiprotocol-BGP for IPv6, page 32-44](#)
- [Example: Configuring BFD and Multiprotocol-BGP for IPv6, page 32-45](#)

## Example: IPv6 Addressing on VLAN Interfaces

The following is a sample configuration of IPv6 addressing on VLAN interfaces.

```
!
interface Vlan2020
 ip address 4.5.6.7 255.255.255.0
 ipv6 address FE80::3 link-local
 ipv6 address 3333::3335/64
 ipv6 address 4400::/64 anycast
 ipv6 address autoconfig
 ipv6 enable
 ipv6 ospf 1 area 0
!
```

## Example: IPv6 Addressing on Loopback Interfaces

The following is a sample configuration of IPv6 addressing on Loopback interfaces.

```
!
interface Loopback100
 ip address 170.0.0.201 255.255.255.0
!
interface Loopback555
 no ip address
 ipv6 address 22::22/64
 ipv6 address 555::554/64
 ipv6 enable
 ipv6 ospf 1 area 0
!
```

## Example: Customizing ICMPv6

The following is a sample configuration of customizing ICMPv6.

```
!
 ICMP error messages limited to one every 100 milliseconds
 ICMP redirects are enabled
 ICMP unreachable are sent
!
```

## Example: Configuring IPv6 Duplicate Address Detection

The following is a sample configuration of IPv6 duplicate address detection.

```
!
 ND DAD is enabled, number of DAD attempts: 1
!Duplicate address detection information is given above.
 ND reachable time is 30000 milliseconds (using 30000)
 ND advertised reachable time is 0 (unspecified)
 ND advertised retransmit interval is 0 (unspecified)
 ND router advertisements are sent every 200 seconds
 ND router advertisements live for 1800 seconds
 ND advertised default router preference is Medium
 Hosts use stateless autoconfig for addresses.
!
```

## Example: Configuring IPv6 Neighborhood Discovery

The following is a sample configuration of IPv6 neighborhood discovery.

```
!  
interface Vlan111  
  no ip address  
  ipv6 address 22::22/64  
  ipv6 address 33::33/64  
  ipv6 address autoconfig  
  ipv6 nd autoconfig prefix  
  !Neighborhood discovery information is given above.  
  ipv6 enable
```

## Example: Enabling IPv6 Stateless Address Autoconfiguration

The following is a sample configuration of IPv6 stateless address autoconfiguration.

```
!  
interface Vlan111  
  no ip address  
  ipv6 address 22::22/64  
  ipv6 address 33::33/64  
  ipv6 address autoconfig  
  !IPv6 address autoconfiguration details are given above.  
  ipv6 nd autoconfig prefix  
  ipv6 enable  
!
```

## Example: Configuring the IPv4 and IPv6 Dual-Stack

The following is a sample configuration of IPv4 and IPv6 dual-stack.

```
!  
interface Vlan222  
  ip address 22.22.22.22 255.255.255.0  
  ipv6 address 99::99/64  
  !IPv4 and IPv6 dual-stack information is given above.  
  ipv6 enable  
!
```

## Example: Configuring IPv6 Static Routing

The following is a sample configuration of IPv6 static routing between two ASR 901 routers.

### Router-1

```
ipv6 route 555::/64 Vlan2020
```

### Router-2

```
interface Loopback555  
  no ip address  
  ipv6 address 22::22/64  
  ipv6 address 555::554/64
```

```

ipv6 enable
ipv6 ospf 1 area 0

```

## Example: Configuring BFD and Static Routing for IPv6

The following is a sample configuration of bidirectional forwarding detection and static routing for IPv6.

```

!
ipv6 route static bfd vlan 4000 2001::1
ipv6 route 2001:DB8::/64 vlan 4000 2001::1

interface vlan 4000
ipv6 add 2001::2/64
bfd interval 50 min_rx 50 multiplier 3

```

## Example: Configuring OSPFv3 for IPv6

The following is a sample configuration of OSPFv3 for IPv6.

### Router-1

```

!
interface Loopback20202
no ip address
ipv6 address 4444::4444/64
ipv6 enable
ipv6 ospf 1 area 0
!
ipv6 router ospf 1
router-id 1.1.1.1
area 0 range 4444::/48
!

```

### Router-2

```

!
interface Loopback30303
no ip address
ipv6 address 4444::4443/64
ipv6 enable
ipv6 ospf 1 area 0
!
ipv6 router ospf 1
router-id 3.3.3.3
area 0 range 4444::/48
!

```

## Example: Configuring BFD and OSPFv3 for IPv6

The following is a sample configuration of bidirectional forwarding detection support for OSPFv3 on one or more OSPFv3 Interfaces:

```

!
```

```

!
ipv6 router ospf 1
router-id 1.1.1.1

interface vlan 4000
ipv6 add 2001::2/64
ipv6 ospf 1 area 0
  ipv6 ospf bfd
bfd interval 50 min_rx 50 multiplier 3
!

```

The following is a sample configuration of bidirectional forwarding detection support for OSPFv3 on all interfaces:

```

ipv6 router ospf 1
router-id 1.1.1.1
bfd all-interfaces

interface vlan 4000
ipv6 add 2001::2/64
ipv6 ospf 1 area 0
bfd interval 50 min_rx 50 multiplier 3

```

## Example: Configuring IS-IS for IPv6

The following is a sample configuration of IS-IS for IPv6.

### Router-1

```

!
interface Loopback20202
no ip address
ipv6 address 565::565/96
ipv6 address 4444::4444/64
ipv6 enable
ipv6 router isis alpha
!
router isis alpha
net 49.1111.2222.3333.4444.00
!

```

### Router-2

```

!
interface Loopback30303
no ip address
ipv6 address 454::454/96
ipv6 address 4444::4443/64
ipv6 enable
ipv6 router isis alpha
!
router isis alpha
net 49.1111.2220.3330.4440.00
!

```

## Example: Configuring Multiprotocol-BGP for IPv6

The following is a sample configuration of multiprotocol-BGP for IPv6.

### Router-1

-----

```

ipv6 unicast-routing

!Enables forwarding of IPv6 packets.

ipv6 cef

interface Loopback10
 no ip address
 ipv6 address 2010:AB8:2::/48
 ipv6 enable
!
interface Loopback20
 no ip address
 ipv6 address 2010:AB8:3::/48
 ipv6 enable
!
interface FastEthernet0/0
 no ip address
 duplex auto
 speed auto
 ipv6 address 2010:AB8:0:2::/64 eui-64
 ipv6 enable
!

router bgp 1
 bgp router-id 1.1.1.1
 no bgp default ipv4-unicast

!Without configuring "no bgp default ipv4-unicast" only IPv4 will be advertised.

 bgp log-neighbor-changes
 neighbor 2010:AB8:0:2:C601:10FF:FE58:0 remote-as 2
!
 address-family ipv6
  neighbor 2010:AB8:0:2:C601:10FF:FE58:0 activate
  network 2010:AB8:2::/48
  network 2010:AB8:3::/48
 exit-address-family
!

```

### Router-2

-----

```

ipv6 unicast-routing
ipv6 cef

interface FastEthernet0/0
 no ip address
 duplex auto
 speed auto
 ipv6 address 2010:AB8:0:2::/64 eui-64
 ipv6 enable
!
router bgp 2
 bgp router-id 2.2.2.2

```



```
no bgp default ipv4-unicast
bgp log-neighbor-changes
neighbor 2010:AB8:0:2:C600:10FF:FE58:0 remote-as 1
!
address-family ipv6
neighbor 2010:AB8:0:2:C600:10FF:FE58:0 activate
exit-address-family
!i
```

## Example: Configuring BFD and Multiprotocol-BGP for IPv6

The following is a sample configuration of bidirectional forwarding detection and multiprotocol-BGP for IPv6.

### Router-1

```
interface Vlan10
ipv6 address 2001:10::1/64
bfd interval 250 min_rx 250 multiplier 3

router bgp 5500
bgp router-id 9.9.9.9
bgp log-neighbor-changes
no bgp default ipv4-unicast
neighbor 2001:10::2 remote-as 6500
neighbor 2001:10::2 fall-over bfd

address-family ipv6
redistribute connected
neighbor 2001:10::2 activate
exit-address-family
```

### Router-2

```
interface Vlan10
ipv6 address 2001:10::2/64
bfd interval 250 min_rx 250 multiplier 3

router bgp 6500
bgp router-id 10.10.10.10
bgp log-neighbor-changes
no bgp default ipv4-unicast
neighbor 2001:10::1 remote-as 5500
neighbor 2001:10::1 fall-over bfd

address-family ipv6
redistribute connected
neighbor 2001:10::1 activate
exit-address-family
```

## Troubleshooting Tips

Problems can occur in the IPv6 functionality due to misconfigurations. To enable IPv6 functionality, you should enable IPv6 configurations at several places.

Some of the sample troubleshooting scenarios are provided below:

Problem	Solution
IPv6 commands are not available.	IPv6 is not enabled by default. Enable IPv6 functionality using <b>ipv6 unicast-routing</b> command. Also, check to see if IPv6 is enabled on the virtual templates.
No route advertisement is sent to the MN when the IPv6 CP comes up.	The route advertisement is disabled on the virtual-templates. Configure the <b>no ipv6 nd suppress-ra</b> command to enable route advertisement messages. Also, define a valid prefix pool for IPv6.

The following **debug** and **show** commands allows you to troubleshoot the IPv6 configuration.

Debug Commands	Show Commands	Platform Hardware Commands
<b>debug ipv6</b>	<b>show ipv6</b>	<b>debug platform hardware cef adjacency</b>
<b>debug ipv6 address</b>	<b>show ipv6 interface</b>	<b>debug platform hardware cef backwalk</b>
<b>debug ipv6 icmp</b>	<b>show ipv6 interface brief</b>	<b>debug platform hardware cef deaggregate</b>
<b>debug ipv6 interface</b>	<b>show ipv6 route</b>	<b>debug platform hardware cef entry</b>
<b>debug ipv6 nd</b>	—	<b>debug platform hardware cef interface</b>
<b>debug ipv6 packet</b>	—	<b>debug platform hardware cef loadbalance</b>
<b>debug ipv6 pool</b>	—	<b>debug platform hardware cef special</b>
<b>debug ipv6 routing</b>	—	<b>debug platform hardware cef table</b>
—	—	<b>debug platform hardware ether idb</b>

## Where to Go Next

For additional information on IPv6 Support on the Cisco ASR 901 routers, see the documentation listed in the [“Related Documents”](#) section on page 32-47.

# Additional References

## Related Documents

Related Topic	Document Title
Cisco IOS commands	<i>Cisco IOS Master Commands List, All Releases</i>
Cisco IOS Debug commands	<i>Cisco IOS Debug Command Reference</i>
Cisco IOS IPv6 commands	<i>Cisco IOS IPv6 Command Reference</i>
IPv6 Configuration document	<i>IPv6 Configuration Guide</i>
Configuration Examples and TechNotes	<i>IPv6 Configuration Examples and TechNotes</i>

## Standards

Standard	Title
None	—

## MIBs

MIB	MIBs Link
<ul style="list-style-type: none"> <li>• CISCO-CONFIG-MAN-MIB</li> <li>• CISCO-FLASH-MIB</li> <li>• CISCO-IETF-BFD-MIB</li> <li>• IP-MIB</li> <li>• IP-FORWARDING-MIB</li> </ul>	<p>To locate and download MIBs for selected platforms, Cisco software releases, and feature sets, use Cisco MIB Locator found at the following URL:</p> <p><a href="http://www.cisco.com/go/mibs">http://www.cisco.com/go/mibs</a></p>

## RFCs

RFC	Title
RFC 2080	<i>RIPng for IPv6</i>
RFC 2373	<i>IP Version 6 Addressing Architecture</i>
RFC 2460	<i>Internet Protocol, Version 6 (IPv6) Specification</i>
RFC 4443	<i>Internet Control Message Protocol (ICMPv6) for the Internet Protocol Version 6 (IPv6) Specification</i>
RFC 4429	<i>Optimistic Duplicate Address Detection (DAD) for IPv6</i>
RFC 4861	<i>Neighbor Discovery for IPv6</i>
RFC 4862	<i>IPv6 Stateless Address Autoconfiguration</i>
RFC 5340	<i>OSPF for IPv6</i>

## Additional References

RFC	Title
RFC 5308	<i>Routing IPv6 with IS-IS</i>
RFC 5881	<i>Bidirectional Forwarding Detection (BFD) for IPv4 and IPv6 (Single Hop)</i>

## Technical Assistance

Description	Link
The Cisco Support and Documentation website provides online resources to download documentation, software, and tools. Use these resources to install and configure the software and to troubleshoot and resolve technical issues with Cisco products and technologies. Access to most tools on the Cisco Support and Documentation website requires a Cisco.com user ID and password.	<a href="http://www.cisco.com/cisco/web/support/index.html">http://www.cisco.com/cisco/web/support/index.html</a>

# Feature Information for IPv6 Support on the Cisco ASR 901 Router

Table 32-2 lists the release history for this feature.

Table 32-2 lists the features in this module and provides links to specific configuration information.

Use Cisco Feature Navigator to find information about platform support and software image support. Cisco Feature Navigator enables you to determine which software images support a specific software release, feature set, or platform. To access Cisco Feature Navigator, go to <http://www.cisco.com/go/cfn>. An account on Cisco.com is not required.



## Note

Table 32-2 lists only the software release that introduced support for a given feature in a given software release train. Unless noted otherwise, subsequent releases of that software release train also support that feature.

**Table 32-2** Feature Information for IPv6 Support on the Cisco ASR 901 Router

Feature Name	Releases	Feature Information
IPv6 Support on the Cisco ASR 901 Router	15.2(2)SNG	<p>This feature is introduced on the Cisco ASR 901 routers.</p> <p>The following sections provide information about this feature:</p> <ul style="list-style-type: none"> <li>• <a href="#">IPv6 Address Formats</a>, page 32-3</li> <li>• <a href="#">IPv6 Addressing and Discovery</a>, page 32-4</li> <li>• <a href="#">Routing Protocols</a>, page 32-7</li> <li>• <a href="#">Bidirectional Forwarding Detection for IPv6</a>, page 32-7</li> <li>• <a href="#">How to Configure IPv6 Support on the Cisco ASR 901 Router</a>, page 32-8</li> <li>• <a href="#">Verifying the Configuration of IPv6 Support on the Cisco ASR 901 Router</a>, page 32-27</li> <li>• <a href="#">Configuration Examples for IPv6 Support on the Cisco ASR 901 Router</a>, page 32-39</li> </ul>
ICMPv6	15.2(2)SNG	<p>The ICMP is used to generate error messages.</p> <p><b>Platform-Independent Cisco IOS Software Documentation</b></p> <p>The following section of the “<a href="#">Implementing IPv6 Addressing and Basic Connectivity</a>” chapter of the <i>IPv6 Configuration Guide</i> provide information about this feature:</p> <ul style="list-style-type: none"> <li>• <a href="#">ICMP for IPv6</a></li> </ul>

Table 32-2 Feature Information for IPv6 Support on the Cisco ASR 901 Router (continued)

Feature Name	Releases	Feature Information
IPv6 Neighbor Discovery	15.2(2)SNG	<p>The IPv6 neighbor discovery determines the link-layer address of a neighbor on the same network (local link), verify the reachability of a neighbor, and track neighboring routers.</p> <p><b>Platform-Independent Cisco IOS Software Documentation</b></p> <p>The following sections of the “<a href="#">Implementing IPv6 Addressing and Basic Connectivity</a>” chapter of the <i>IPv6 Configuration Guide</i> provide information about this feature:</p> <ul style="list-style-type: none"> <li>• <a href="#">IPv6 Neighbor Discovery</a></li> <li>• <a href="#">IPv6 Duplicate Address Detection</a></li> </ul>
IPv4 and IPv6 Dual-Stack	15.2(2)SNG	<p>The dual IPv4 and IPv6 protocol stack technique is used to transition to IPv6. It enables gradual, one-by-one upgrades to applications running on nodes.</p> <p><b>Platform-Independent Cisco IOS Software Documentation</b></p> <p>The following section of the “<a href="#">Implementing IPv6 Addressing and Basic Connectivity</a>” chapter of the <i>IPv6 Configuration Guide</i> provide information about this feature:</p> <ul style="list-style-type: none"> <li>• <a href="#">Dual IPv4 and IPv6 Protocol Stacks</a></li> </ul>
RIP for IPv6	15.2(2)SNG	<p>The IPv6 RIP Routing Information Database (RIB) contains a set of best-cost IPv6 RIP routes learned from all its neighboring networking devices. The RIB also stores any expired routes that the RIP process is advertising to its neighbors running RIP.</p> <p><b>Platform-Independent Cisco IOS Software Documentation</b></p> <p>The following section of the “<a href="#">Implementing RIP for IPv6</a>” chapter of the <i>IPv6 Configuration Guide</i> provide information about this feature:</p> <ul style="list-style-type: none"> <li>• <a href="#">RIP for IPv6</a></li> </ul>
IS-IS for IPv6	15.2(2)SNG	<p>The IPv6 RIP Routing Information Database (RIB) contains a set of best-cost IPv6 RIP routes learned from all its neighboring networking devices. The RIB also stores any expired routes that the RIP process is advertising to its neighbors running RIP.</p> <p><b>Platform-Independent Cisco IOS Software Documentation</b></p> <p>The following section of the “<a href="#">Implementing IS-IS for IPv6</a>” chapter of the <i>IPv6 Configuration Guide</i> provide information about this feature:</p> <ul style="list-style-type: none"> <li>• <a href="#">IS-IS for IPv6</a></li> </ul>

Table 32-2 Feature Information for IPv6 Support on the Cisco ASR 901 Router (continued)

Feature Name	Releases	Feature Information
OSPFv3 for IPv6	15.2(2)SNG	<p>OSPF is a link-state protocol. A link-state protocol makes its routing decisions based on the states of the links that connect source and destination machines.</p> <p><b>Platform-Independent Cisco IOS Software Documentation</b></p> <p>The following section of the “<a href="#">Implementing OSPFv3</a>” chapter of the <i>IPv6 Configuration Guide</i> provide information about this feature:</p> <ul style="list-style-type: none"> <li>• <a href="#">Information about OSPFv3</a></li> </ul>
Multiprotocol BGP Extensions for IPv6	15.2(2)SNG	<p>Multiprotocol BGP is the supported exterior gateway protocol (EGP) for IPv6.</p> <p><b>Platform-Independent Cisco IOS Software Documentation</b></p> <p>The following section of the “<a href="#">Implementing Multiprotocol BGP for IPv6</a>” chapter of the <i>IPv6 Configuration Guide</i> provide information about this feature:</p> <ul style="list-style-type: none"> <li>• <a href="#">Multiprotocol BGP Extensions for IPv6</a></li> </ul>
Bidirectional Forwarding Detection for IPv6	15.2(2)SNG	<p>BFD is a detection protocol designed to provide fast forwarding path failure detection times for all media types, encapsulations, topologies, and routing protocols.</p> <p><b>Platform-Independent Cisco IOS Software Documentation</b></p> <p>The following section of the “<a href="#">Implementing Bidirectional Forwarding Detection for IPv6</a>” chapter of the <i>IPv6 Configuration Guide</i> provide information about this feature:</p> <ul style="list-style-type: none"> <li>• <a href="#">Implementing Bidirectional Forwarding Detection for IPv6</a></li> </ul>
Implementing QoS for IPv6	15.2(2)SNG	<p>QoS features for IPv6 include packet classification, policing, marking on ingress path of Ethernet interfaces and packet classification, policing, marking, scheduling, per interface and per qos-group shaping, LLQ, and WRED on egress path of GigabitEthernet interfaces.</p> <p><b>Platform-dependent Cisco IOS Software Documentation</b></p> <p>The “<a href="#">Configuring QoS</a>” section of the <i>Cisco ASR 901 Series Aggregation Services Router Software Configuration Guide</i> provide information about this feature:</p> <ul style="list-style-type: none"> <li>• <a href="#">Configuring QoS</a></li> </ul> <p><b>Platform-Independent Cisco IOS Software Documentation</b></p> <p>The following section of the “<a href="#">Implementing QoS for IPv6</a>” chapter of the <i>IPv6 Configuration Guide</i> provide information about this feature:</p> <ul style="list-style-type: none"> <li>• <a href="#">Implementing QoS for IPv6</a></li> </ul>







## Labeled BGP Support

---

This feature module describes how to add label mapping information to the Border Gateway Protocol (BGP) message that is used to distribute the route on the Cisco ASR 901 Series Aggregation Services Routers.

### Finding Feature Information

Your software release may not support all the features documented in this module. For the latest feature information and caveats, see the release notes for your platform and software release. To find information about the features documented in this module, and to see a list of the releases in which each feature is supported, see the “[Feature Information for Labeled BGP Support](#)” section on page 33-8.

Use Cisco Feature Navigator to find information about platform support and Cisco software image support. To access Cisco Feature Navigator, go to <http://www.cisco.com/go/cfn>. An account on Cisco.com is not required.

### Contents

- [Prerequisites](#), page 33-2
- [Restrictions](#), page 33-2
- [Overview of Labeled BGP Support](#), page 33-2
- [How to Configure Labeled BGP Support](#), page 33-2
- [Configuration Example for Labeled Support](#), page 33-3
- [Additional References](#), page 33-7
- [Feature Information for Labeled BGP Support](#), page 33-8

## Prerequisites

Cisco IOS Release 15.2(2)SNG or a later release that supports Labeled BGP must be installed previously on the Cisco ASR 901 Series Aggregation Services Router.

## Restrictions

- The Cisco ASR 901 router supports only the client functionality of RFC 3107 and not its area border router (ABR) functionality.
- The Cisco ASR 901 router does not support two label-pop (Label pop is the process of removing label header).
- Four label push is not supported. Due to this limitation, Labeled BGP access (RFC 3107) with Remote LFA-FRR/TE-FRR is not supported, if it exceeds three labels.

## Overview of Labeled BGP Support

The Labeled BGP Support feature provides the option to use the BGP update message (that is used to distribute the route) to re-distribute Multiprotocol Label Switching (MPLS) label mapped to that route. The label mapping information is added (using *send-label* option of RFC 3107) to the same BGP message that is used to distribute the route. This process is useful in inter-domain routing, and the Cisco ASR 901 router supports this functionality as well as the virtual private network (VPN) and virtual routing and forwarding (VRF) over Labeled BGP functionality.

### VPN/VRF over RFC 3107

The VPN/VRF over Labeled BGP is a 3-label imposition process (VRF Label, BGP label, interior gateway protocols [IGP] label). The innermost label is VRF, followed by BGP (for RFC 3107), and IGP. This functionality allows the Cisco ASR 901 router to support a VRF over labeled BGP session with an ABR.

## How to Configure Labeled BGP Support



### Note

The TDM over Labeled BGP feature is supported effective with Cisco IOS Release 15.3(3)S. The configuration and restrictions for this feature are the same as that of Labeled BGP Support.

To configure Labeled BGP Support feature on the Cisco ASR 901 router, perform the steps given below:

### SUMMARY STEPS

1. **enable**
2. **configure terminal**
3. **router bgp** *as-number*
4. **address family ipv4**
5. **neighbor** *peer-group-name* **send-community**

6. **neighbor *peer-group-name* send-label**
7. **neighbor *peer-group-name* activate**

## DETAILED STEPS

	Command	Purpose
Step 1	<b>enable</b>  <b>Example:</b> Router> enable	Enables privileged EXEC mode. <ul style="list-style-type: none"> <li>Enter your password if prompted.</li> </ul>
Step 2	<b>configure terminal</b>  <b>Example:</b> Router# configure terminal	Enters global configuration mode.
Step 3	<b>router bgp <i>as-number</i></b>  <b>Example:</b> Router(config)# router bgp 100	Enters router configuration mode. <ul style="list-style-type: none"> <li><i>as-number</i>—Number of an autonomous system that identifies the router to other BGP routers and tags the routing information that is passed along. The valid values range from 1 to 65535.</li> </ul>
Step 4	<b>address family ipv4</b>  <b>Example:</b> Router(config-router)# address family ipv4	Configures the address family as IPv4 using standard IPv4 address prefixes.
Step 5	<b>neighbor <i>peer-group-name</i> send-community</b>  <b>Example:</b> Router(config-router)# neighbor 172.16.70.23 send-community	Specifies that the communities attribute be sent to the neighbor at this IP address. <ul style="list-style-type: none"> <li><i>peer-group-name</i>—Name of a BGP peer group.</li> </ul>
Step 6	<b>neighbor <i>peer-group-name</i> send-label</b>  <b>Example:</b> Router(config-router)# neighbor 172.16.70.23 send-label	Configures the router to associate a BGP label to the prefix using the <b>send-label</b> option.
Step 7	<b>neighbor <i>peer-group-name</i> activate</b>  <b>Example:</b> Router(config-router)# neighbor 172.16.70.23 activate	Enables the exchange of information with a neighboring BGP router.

## Configuration Example for Labeled Support

The following is a sample configuration of the Labeled BGP Support feature.

```
!
router bgp 1000
  bgp router-id 100.111.13.23
```

```

neighbor pan peer-group
neighbor pan remote-as 1000
neighbor pan update-source Loopback0
neighbor 100.111.14.3 peer-group pan
!
address-family ipv4
neighbor pan send-community
neighbor pan send-label
!The "send-label" option is used to associate a BGP label to the prefix.
neighbor 100.111.14.3 activate
exit-address-family
!
address-family vpnv4
neighbor pan send-community extended
neighbor 100.111.14.3 activate
exit-address-family
!
address-family ipv4 vrf LTE12
redistribute connected
exit-address-family
!

```

## Verifying Labeled BGP Support

To verify the Labeled BGP Support on the Cisco ASR 901 router, use the **show** commands given below:

Router# **show bgp ipv4 unicast labels**

Network	Next Hop	In label/Out label
1.0.0.0	0.0.0.0	imp-null/nolabel
10.13.22.2/31	0.0.0.0	imp-null/nolabel
10.13.23.0/31	0.0.0.0	imp-null/nolabel
10.70.1.0/30	0.0.0.0	imp-null/nolabel
100.100.10.1/32	100.111.14.4	nolabel/558
	100.111.14.3	nolabel/560
100.100.13.23/32	0.0.0.0	imp-null/nolabel
100.101.13.23/32	0.0.0.0	imp-null/nolabel
100.111.13.23/32	0.0.0.0	imp-null/nolabel
100.111.13.26/32	100.111.14.3	nolabel/534
	100.111.14.4	nolabel/68
100.111.15.1/32	100.111.14.3	nolabel/25

Router# **show ip bgp labels**

Network	Next Hop	In label/Out label
1.0.0.0	0.0.0.0	imp-null/nolabel
10.13.22.2/31	0.0.0.0	imp-null/nolabel
10.13.23.0/31	0.0.0.0	imp-null/nolabel
10.70.1.0/30	0.0.0.0	imp-null/nolabel
100.100.10.1/32	100.111.14.4	nolabel/563
	100.111.14.3	nolabel/556
100.100.13.23/32	0.0.0.0	imp-null/nolabel
100.101.13.23/32	0.0.0.0	imp-null/nolabel
100.111.13.23/32	0.0.0.0	imp-null/nolabel
100.111.13.26/32	100.111.14.4	nolabel/561
	100.111.14.3	nolabel/559
100.111.15.1/32	100.111.14.4	nolabel/59
	100.111.14.3	nolabel/57
100.111.15.2/32	100.111.14.4	nolabel/62
	100.111.14.3	nolabel/52
100.112.1.1/32	100.111.14.4	nolabel/nolabel

```

100.111.14.3      nolabel/nolabel
100.112.1.2/32   100.111.14.4   nolabel/nolabel
                  100.111.14.3   nolabel/nolabel
100.112.1.3/32   100.111.14.4   nolabel/nolabel
                  100.111.14.3   nolabel/nolabel

```

Router# **show ip bgp vpnv4 all label**

```

Network          Next Hop      In label/Out label
Route Distinguisher: 236:236
154.154.236.4/30 100.154.1.1   nolabel/14002
                  100.154.1.1   nolabel/14002
154.154.236.8/30 100.154.1.1   nolabel/14002
                  100.154.1.1   nolabel/14002
154.154.236.12/30
                  100.154.1.1   nolabel/14002
                  100.154.1.1   nolabel/14002
154.154.236.16/30
                  100.154.1.1   nolabel/14002
                  100.154.1.1   nolabel/14002
154.154.236.20/30
                  100.154.1.1   nolabel/14002
                  100.154.1.1   nolabel/14002
154.154.236.24/30
                  100.154.1.1   nolabel/14002
                  100.154.1.1   nolabel/14002

```

Router# **show ip vrf interface**

```

Interface          IP-Address      VRF              Protocol
Vl100              113.23.12.1    LTE12

```

Router# **show ip bgp vpnv4 vrf LTE12 label**

```

Network          Next Hop      In label/Out label
Route Distinguisher: 6666:6666 (LTE12)
113.22.12.0/24   100.111.13.22 nolabel/51
                  100.111.13.22 nolabel/51
113.23.12.0/24   0.0.0.0       50/nolabel(LTE12)
113.24.12.0/24   100.111.13.24 nolabel/32
                  100.111.13.24 nolabel/32
115.1.12.0/24    100.111.15.1  nolabel/16024
                  100.111.15.1  nolabel/16024
154.154.236.4/30 100.154.1.1   nolabel/14002
154.154.236.8/30 100.154.1.1   nolabel/14002
154.154.236.12/30
                  100.154.1.1   nolabel/14002
154.154.236.16/30
                  100.154.1.1   nolabel/14002
154.154.236.20/30
                  100.154.1.1   nolabel/14002
154.154.236.24/30
                  100.154.1.1   nolabel/14002

```

To verify three Label Support, use the **show ip cef vrf** command as shown in the following example.

Router# **show ip cef vrf LTE12 113.22.12.0 internal**

```

113.22.12.0/24, epoch 0, flags rib defined all labels, RIB[B], refcount 5, per-destination
sharing
sources: RIB
feature space:
IPRM: 0x00018000

```

```
LFD: 113.22.12.0/24 0 local labels
      contains path extension list
ifnums: (none)
path 13E8A064, path list 13F49DC8, share 1/1, type recursive, for IPv4, flags
must-be-labelled, recursive-via-host
      MPLS short path extensions: MOI flags = 0x0 label 51
      recursive via 100.111.13.22[IPv4:Default] label 51, fib 141253D8, 1 terminal fib,
v4:Default:100.111.13.22/32
      path 12520C8C, path list 13F49C38, share 1/1, type attached nexthop, for IPv4
      MPLS short path extensions: MOI flags = 0x0 label 17
      nexthop 100.111.14.4 Vlan10 label 17, adjacency IP adj out of Vlan10, addr
10.13.23.1 13734C80
      output chain: label 22 label 51 label 17 TAG adj out of Vlan10, addr 10.13.23.1 143EDCA0
!You can see three labels in the output chain; of which 22 is VRF label, 51 is BGP label
!and 17 is LDP label
```

# Additional References

The following sections provide references related to Labeled BGP Support feature.

## Related Documents

Related Topic	Document Title
Cisco IOS Commands	<a href="#">Cisco IOS Master Commands List, All Releases</a>
Cisco ASR 901 Command Reference	<a href="#">Cisco ASR 901 Series Aggregation Services Router Command Reference</a>
BGP Commands	<a href="#">Cisco IOS IP Routing: BGP Command Reference</a>
Configuring BGP	<a href="#">Cisco IOS IP Configuration Guide, Release 12.2</a>

## Standards

Standard	Title
None	—

## MIBs

MIB	MIBs Link
None	To locate and download MIBs for selected platforms, Cisco IOS releases, and feature sets, use Cisco MIB Locator found at the following URL: <a href="http://www.cisco.com/go/mibs">http://www.cisco.com/go/mibs</a>

## RFCs

RFC	Title
RFC-3107	<a href="#">Carrying Label Information in BGP-4</a>

## Technical Assistance

Description	Link
The Cisco Technical Support website contains thousands of pages of searchable technical content, including links to products, technologies, solutions, technical tips, and tools. Registered Cisco.com users can log in from this page to access even more content.	<a href="http://www.cisco.com/techsupport">http://www.cisco.com/techsupport</a>

# Feature Information for Labeled BGP Support

Table 33-1 lists the features in this module and provides links to specific configuration information.

Use Cisco Feature Navigator to find information about platform support and software image support. Cisco Feature Navigator enables you to determine which software images support a specific software release, feature set, or platform. To access Cisco Feature Navigator, go to <http://www.cisco.com/go/cfn>. An account on Cisco.com is not required.

**Note**

Table 33-1 lists only the software release that introduced support for a given feature in a given software release train. Unless noted otherwise, subsequent releases of that software release train also support that feature.

**Table 33-1** Feature Information for Labeled BGP Support

Feature Name	Releases	Feature Information
Labeled BGP Support	15.2(2)SNG	This feature was introduced on the Cisco ASR 901 routers. The following sections provide information about this feature: <ul style="list-style-type: none"> <li>• <a href="#">Overview of Labeled BGP Support, page 33-2</a></li> <li>• <a href="#">How to Configure Labeled BGP Support, page 33-2</a></li> </ul>
TDM over Labeled BGP	15.3(3)S	Support for TDM over Labeled BGP was introduced on the Cisco ASR 901 routers.





# MPLS Traffic Engineering - Fast Reroute Link Protection

---

This feature module describes the Fast Reroute (FRR) link protection and Bidirectional Forwarding Detection (BFD)-triggered FRR feature of Multiprotocol Label Switching (MPLS) traffic engineering (TE).

## Finding Feature Information

Your software release may not support all the features documented in this module. For the latest feature information and caveats, see the release notes for your platform and software release. To find information about the features documented in this module, and to see a list of the releases in which each feature is supported, see the [“Feature Information for MPLS Traffic Engineering - Fast Reroute Link Protection” section on page 34-27](#).

Use Cisco Feature Navigator to find information about platform support and Cisco software image support. To access Cisco Feature Navigator, go to <http://www.cisco.com/go/cfn>. An account on Cisco.com is not required.

## Contents

- [Prerequisites, page 34-2](#)
- [Restrictions, page 34-2](#)
- [Feature Overview, page 34-2](#)
- [How to Configure Traffic Engineering - Fast Reroute Link Protection, page 34-4](#)
- [Configuration Examples, page 34-24](#)
- [Additional References, page 34-25](#)
- [Feature Information for MPLS Traffic Engineering - Fast Reroute Link Protection, page 34-27](#)

## Prerequisites

- Cisco IOS Release 15.2(2)SNG or a later release that supports the MPLS TE-FRR link protection feature must be installed previously on the Cisco ASR 901 Series Aggregation Services Router.
- You should enable the **asr901-platf-frr** command at the global configuration before using TE-FRR.
- Your network must support both the following Cisco IOS features before you can enable Fast Reroute link protection:
  - IP Cisco Express Forwarding (CEF)
  - Multiprotocol Label Switching (MPLS)
- Your network must also support at least one of the following protocols:
  - Intermediate System-to-Intermediate System (IS-IS)
  - Open Shortest Path First (OSPF)

## Restrictions

- MPLS TE works only on the Switch Virtual Interface (SVI).
- MPLS TE-FRR feature is used only for link protection and not for node protection.
- MPLS deployments that allows 4-label push is not supported.
- When the TE-FRR deployments are in ring topology, hair-pinning can occur while trying to reach the destination during cutover.
- MPLS TE-FRR is not supported on layer 3 over layer 2 deployments.
- You cannot configure BFD and RSVP on the same interface.
- You should use the **no I3-over-I2 flush buffers** command before configuring MPLS TE-FRR feature.
- Path protection is not supported.
- Time-division multiplexing (TDM) psuedowire over TE-FRR is not supported.
- QoS is not supported on the MPLS TE tunnels.
- You cannot enable FRR hello messages on a router that also has Resource Reservation Protocol (RSVP) Graceful Restart enabled.
- Psuedowire redundancy over TE-FRR is not supported.
- CFM over Xconnect over TE-FRR is not supported.
- The imposition statistics will not work for EOMPLS after the FRR event or layer 3 cutover.

## Feature Overview

The MPLS TE is supported on the Cisco ASR 901 router to enable only the FRR. The traffic engineering aspects of MPLS TE is currently not supported. The MPLS TE is the process of establishing and maintaining label-switched paths (LSPs) across the backbone using Resource Reservation Protocol (RSVP). The path used by a given LSP at any point in time is based upon the LSP resource requirements and available network resources.

The MPLS TE-FRR feature is useful for time critical applications like voice calls that require minimal loss of data during link failures. This feature is used to overcome the issue of convergence speed experienced by the Interior Gateway Protocol (IGP) fast timers.

**Note**

The convergence numbers is the sum of detection time and re-programming time. The re-programming time is a function of number of prefixes and label entries. For good convergence numbers, the number of prefixes/label-entries should be kept to a minimum.

In the MPLS TE-FRR feature, backup tunnels are used to minimize the impact of link breakages. The point of failure can either be a head-end tunnel or a mid-point. In both the cases, the scope of recovery is local. The reroute decision is completely controlled locally by the router interfacing the failed link. The recovery is done by the node that listens to the failure. The node that detects the failure switches the traffic to the backup link with the least amount of delay.

Figure 34-1 illustrates the FRR link protection.

**Figure 34-1 FRR Link Protection**

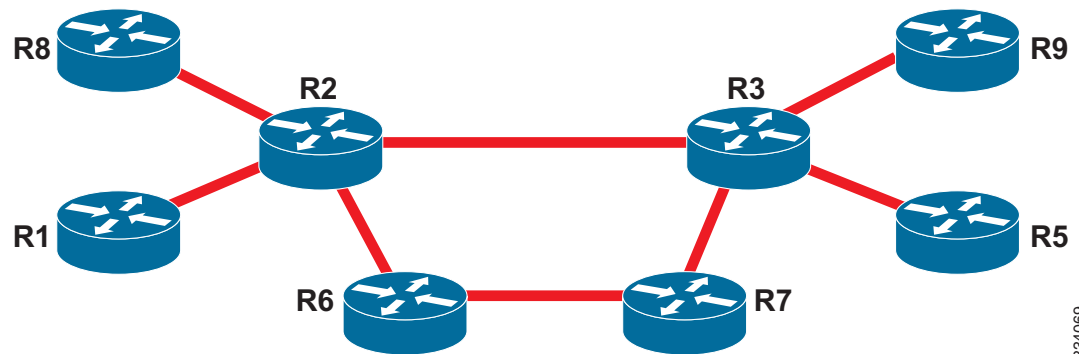

334069

<b>R2</b>	Head-end of the tunnel	<b>R2 - R6 - R7 - R3</b>	Backup link
<b>R2 - R3</b>	Protected link	<b>R3</b>	Tail-end of tunnel
<b>R2 - R3</b>	Primary link	—	—

The MPLS TE-FRR feature supports the following:

- IP, L3VPN, and EoMPLS.
- Supports BFD sessions with 50ms interval.
- Single hop tunnel and multi-hop tunnel deployments.
- Auto-tunnel feature in primary and backup nodes.
- Targeted LDP sessions on tunnels.

## BFD-triggered Fast Reroute

The MPLS Traffic Engineering: BFD-triggered Fast Reroute feature allows you to obtain link protection by using the BFD protocol.

## BFD

BFD is a detection protocol designed to provide fast forwarding link failure detection times for all media types, encapsulations, topologies, and routing protocols. In addition to fast forwarding link failure detection, BFD provides a consistent failure detection method for network administrators. Because the network administrator can use BFD to detect forwarding link failures at a uniform rate, rather than the variable rates for different routing protocol Hello mechanisms, network profiling and planning is easier, and reconvergence time is consistent and predictable.

## Fast Reroute

Fast Reroute is a mechanism for protecting MPLS TE LSPs from link failures by locally repairing the LSPs at the point of failure. This allows the data to continue to flow on them while their headend routers attempt to establish new end-to-end LSPs to replace them. FRR locally repairs the protected LSPs by rerouting them over backup tunnels that bypass failed links.

## Link Protection

Backup tunnels that bypass only a single link of the LSP's path provide link protection. They protect LSPs if a link along their path fails by rerouting the LSP's traffic to the next hop (bypassing the failed link). These are referred to as next-hop (NHOP) backup tunnels because they terminate at the LSP's next hop beyond the point of failure.

# How to Configure Traffic Engineering - Fast Reroute Link Protection

This section describes how to configure MPLS TE-FRR Link Protection feature:

- [Enabling MPLS TE-FRR on an SVI Interface, page 34-5](#) (Required)
- [Enabling MPLS TE-FRR for EoMPLS on a Global Interface, page 34-5](#) (Required)
- [Enabling MPLS TE-FRR for EoMPLS on an Interface, page 34-7](#) (Required)
- [Enabling MPLS TE-FRR for IS-IS, page 34-9](#) (Required)
- [Configuring Primary One-hop Auto-Tunnels, page 34-11](#) (Required)
- [Configuring Backup Auto-Tunnels, page 34-13](#) (Required)
- [Enabling Targeted LDP session over Primary one-hop Auto-Tunnels, page 34-14](#) (Required)
- [Enabling BFD Triggered FRR on an SVI Interface, page 34-15](#) (Required)
- [Enabling BFD Triggered FRR on a Router, page 34-16](#) (Required)
- [Verifying MPLS TE-FRR Configuration, page 34-17](#) (Optional)
- [Verifying Primary One-hop Auto-Tunnels, page 34-19](#) (Optional)
- [Verifying Backup Auto-Tunnels, page 34-19](#) (Optional)
- [Verifying BFD Triggered FRR Configuration, page 34-20](#) (Optional)

## Enabling MPLS TE-FRR on an SVI Interface

To enable MPLS TE-FRR on an SVI interface, perform the steps given below:

### SUMMARY STEPS

1. **enable**
2. **configure terminal**
3. **interface** *type number*
4. **mpls traffic-eng tunnels**

### DETAILED STEPS

	Command	Purpose
Step 1	<b>enable</b>  <b>Example:</b> Router> enable	Enables privileged EXEC mode.  <ul style="list-style-type: none"> <li>• Enter your password if prompted.</li> </ul>
Step 2	<b>configure terminal</b>  <b>Example:</b> Router# configure terminal	Enters global configuration mode.
Step 3	<b>interface</b> <i>type number</i>  <b>Example:</b> Router(config)# interface vlan 40	Specifies an interface type and number and enters interface configuration mode.
Step 4	<b>mpls traffic-eng tunnels</b>  <b>Example:</b> Router(config-if)# mpls traffic-engg tunnels	Enables MPLS TE tunnel signaling on the specified interface.

## Enabling MPLS TE-FRR for EoMPLS on a Global Interface

To enable MPLS TE-FRR for EoMPLS on a global interface, perform the steps given below:

### SUMMARY STEPS

1. **enable**
2. **configure terminal**
3. **no l3-over-l2 flush buffers**
4. **asr901-platf-frr enable**
5. **mpls ldp discovery targeted-hello accept**

6. **pseudowire-class** *pw-class-name*
7. **encapsulation** *encapsulation-type*
8. **preferred-path** {[**interface**] **tunnel** *tunnel-number* | **peer** *host-ip-address*} [**disable-fallback**]
9. **exit**
10. **mpls label protocol ldp**
11. **mpls ldp igp sync holddown** *milliseconds*

## DETAILED STEPS

	Command	Purpose
Step 1	<b>enable</b>  <b>Example:</b> Router> enable	Enables privileged EXEC mode. <ul style="list-style-type: none"> <li>• Enter your password if prompted.</li> </ul>
Step 2	<b>configure terminal</b>  <b>Example:</b> Router# configure terminal	Enters global configuration mode.
Step 3	<b>no l3-over-12 flush buffers</b>  <b>Example:</b> Router(config)# no l3-over-12 flush buffers	Disables layer 3 over layer 2 deployments.
Step 4	<b>asr901-platf-frr enable</b>  <b>Example:</b> Router(config)# asr901-platf-frr enable	Enables TE-FRR link protection.
Step 5	<b>mpls ldp discovery targeted-hello accept</b>  <b>Example:</b> Router(config)# mpls ldp discovery targeted-hello accept	Configures the neighbors from which requests for targeted hello messages may be honored. <ul style="list-style-type: none"> <li>• <b>targeted-hello</b>—Configures the intervals and hold times for neighbors that are not directly connected.</li> </ul>
Step 6	<b>pseudowire-class</b> <i>pw-class-name</i>  <b>Example:</b> Router(config)# pseudowire-class T41	Specifies the name of a layer 2 pseudowire class and enters pseudowire class configuration mode.
Step 7	<b>encapsulation</b> <i>encapsulation-type</i>  <b>Example:</b> Router(config-pw-class)# encapsulation mpls	Specifies the encapsulation method used by the interface.

	Command	Purpose
Step 8	<pre>preferred-path {[interface] tunnel tunnel-number   peer host-ip-address} [disable-fallback]</pre> <p><b>Example:</b>  Router(config-pw-class)#  preferred-path interface Tunnel41  disable-fallback</p>	<p>Specifies the MPLS TE tunnel that traffic uses.</p> <ul style="list-style-type: none"> <li>• <b>interface</b>—Specifies the preferred path using an output interface.</li> <li>• <b>tunnel</b>—Specifies an MPLS TE tunnel interface that is the core-facing output interface.</li> <li>• <i>tunnel-number</i>—Tunnel interface number.</li> <li>• <b>peer</b>—Specifies a destination IP address or DNS name configured on the peer provider edge (PE) router, which is reachable through a label switched path (LSP).</li> <li>• <i>host-ip-address</i>—Peer host name or IP address.</li> <li>• <b>peer</b>—(Optional) Disables the router from using the default path when the preferred path is unreachable.</li> </ul>
Step 9	<pre>exit</pre> <p><b>Example:</b>  Router(config-pw-class)# exit</p>	<p>Exits pseudowire class configuration mode and enters the global configuration mode.</p>
Step 10	<pre>mpls label protocol ldp</pre> <p><b>Example:</b>  Router(config)# mpls label protocol  ldp</p>	<p>Specifies the label distribution protocol for an interface. Here LDP protocol is used.</p>
Step 11	<pre>mpls ldp igp sync holddown milliseconds</pre> <p><b>Example:</b>  Router(config)# mpls ldp igp sync  holddown 1000</p>	<p>Specifies how long an Interior Gateway Protocol (IGP) should wait for Label Distribution Protocol (LDP) synchronization to be achieved.</p> <ul style="list-style-type: none"> <li>• <i>milliseconds</i>—Peer host name or IP address.</li> </ul>

## Enabling MPLS TE-FRR for EoMPLS on an Interface

To enable MPLS TE-FRR for EoMPLS on an interface, perform the steps given below:

### SUMMARY STEPS

1. **enable**
2. **configure terminal**
3. **pseudowire-class** *pw-class-name*
4. **no negotiation auto**
5. **service instance** *id* **ethernet**
6. **encapsulation dot1q** *vlan-id*
7. **rewrite ingress tag pop 1 symmetric**
8. **xconnect** *peer-ip-address* *vc-id* **pw-class** *pw-class-name*

## DETAILED STEPS

	Command	Purpose
Step 1	<b>enable</b>  <b>Example:</b> Router> enable	Enables privileged EXEC mode. <ul style="list-style-type: none"> <li>Enter your password if prompted.</li> </ul>
Step 2	<b>configure terminal</b>  <b>Example:</b> Router# configure terminal	Enters global configuration mode.
Step 3	<b>pseudowire-class</b> <i>pw-class-name</i>  <b>Example:</b> Router(config)# pseudowire-class T41	Specifies the name of a layer 2 pseudowire class and enters pseudowire class configuration mode. <ul style="list-style-type: none"> <li><i>pw-class-name</i>—Name of a layer 2 pseudowire class.</li> </ul>
Step 4	<b>no negotiation auto</b>  <b>Example:</b> Router(config-if)# no negotiation auto	Disables automatic negotiation.
Step 5	<b>service instance</b> <i>id</i> <b>ethernet</b>  <b>Example:</b> Router(config-if)# service instance 100 ethernet	Configures an Ethernet service instance on an interface. <ul style="list-style-type: none"> <li><i>id</i>—Integer that uniquely identifies a service instance on an interface. The value varies by the platform. Range: 1 to 4294967295. The identifier need not map to a VLAN and is local in scope to the interface.</li> </ul>
Step 6	<b>encapsulation dot1q</b> <i>vlan-id</i>  <b>Example:</b> Router(config-if-srv)# encapsulation dot1q 101	Enables IEEE 802.1Q encapsulation of traffic on a specified subinterface in a VLAN. <ul style="list-style-type: none"> <li><i>vlan-id</i>—Virtual LAN identifier. The allowed range is from 1 to 4094. For the IEEE 802.1Q-in-Q VLAN Tag Termination feature, the first instance of this argument defines the outer VLAN ID, and the second and subsequent instances define the inner VLAN ID.</li> </ul>



	Command	Purpose
Step 7	<pre>rewrite ingress tag pop 1 symmetric</pre> <p><b>Example:</b> Router(config-if-srv)# rewrite ingress tag pop 1 symmetric</p>	Specifies the encapsulation adjustment to be performed on a frame ingressing a service instance.
Step 8	<pre>xconnect peer-ip-address vc-id pw-class pw-class-name</pre> <p><b>Example:</b> Router(config-if-srv)# xconnect 10.0.0.4 4 pw-class T41</p>	<p>Binds an attachment circuit to a pseudowire, and to configure an Any Transport over MPLS (AToM) static pseudowire.</p> <ul style="list-style-type: none"> <li>• <i>peer-ip-address</i>—IP address of the remote provider edge (PE) peer. The remote router ID can be any IP address, as long as it is reachable.</li> <li>• <i>vc-id</i>—The 32-bit identifier of the virtual circuit (VC) between the PE routers.</li> <li>• <b>pw-class</b>—Specifies the pseudowire class for advanced configuration.</li> <li>• <i>pw-class-name</i>—Pseudowire class name.</li> </ul>

## Enabling MPLS TE-FRR for IS-IS

To enable MPLS TE-FRR for IS-IS routing process, perform the steps given below:

### SUMMARY STEPS

1. **enable**
2. **configure terminal**
3. **router isis**
4. **mpls traffic-engg router-id** *interface-name*
5. **mpls traffic-engg { level-1 | level-2 }**
6. **router isis**
7. **net** *net1*
8. **is-type level-1**
9. **fast-reroute per-prefix level-1 all**
10. **fast-reroute per-prefix level-2 all**
11. **fast-reroute remote-lfa level-1 mpls-ldp**
12. **fast-reroute remote-lfa level-2 mpls-ldp**
13. **bfd all-interfaces**
14. **mpls ldp sync**

## DETAILED STEPS

	Command	Purpose
Step 1	<b>enable</b>  <b>Example:</b> Router> enable	Enables privileged EXEC mode. <ul style="list-style-type: none"> <li>Enter your password if prompted.</li> </ul>
Step 2	<b>configure terminal</b>  <b>Example:</b> Router# configure terminal	Enters global configuration mode.
Step 3	<b>router isis</b>  <b>Example:</b> Router(config)# router isis	Activates the IS-IS routing process for IP and puts the device into router configuration mode.
Step 4	<b>mpls traffic-eng router-id interface-name</b>  <b>Example:</b> Router(config-router)# mpls traffic-eng router-id Loopback102	Specifies that the traffic engineering router identifier for the node is the IP address associated with a given interface. <ul style="list-style-type: none"> <li><i>interface-name</i>—Interface whose primary IP address is the router's identifier.</li> </ul>
Step 5	<b>mpls traffic-eng {level-1   level-2}</b>  <b>Example:</b> Router(config-router)# mpls traffic-eng level-1	Configures a router running IS-IS so that it floods MPLS TE link information into the indicated IS-IS level. <ul style="list-style-type: none"> <li><b>level-1</b>—Floods MPLS TE link information into IS-IS level 1.</li> <li><b>level-2</b>—Floods MPLS TE link information into IS-IS level 2.</li> </ul>
Step 6	<b>router isis</b>  <b>Example:</b> Router(config)# router isis	Enables the IS-IS routing protocol and enters the router configuration mode.
Step 7	<b>net net1</b>  <b>Example:</b> Router(config)# net 49.0001.0000.0000.0001.00	Configures an Intermediate System-to-Intermediate System (IS-IS) network entity table (NET) for the routing process. <ul style="list-style-type: none"> <li><i>net1</i>—NET network services access point (NSAP) name or address for the IS-IS routing process on the Multilayer Switch Feature Card (MSFC) in the primary slot.</li> </ul>
Step 8	<b>is-type level-1</b>  <b>Example:</b> Router(config-router)# is-type level-1	Configures the routing level for an instance of the Intermediate System-to-Intermediate System (IS-IS) routing process.
Step 9	<b>fast-reroute per-prefix level-1 all</b>  <b>Example:</b> Router(config-router)# fast-reroute per-prefix level-1 all	Configures an FRR path that redirects traffic to a remote LFA tunnel for level-1 packets. <ul style="list-style-type: none"> <li><b>level-1</b>—Enables per-prefix FRR of level 1 packets.</li> <li><b>all</b>—Enables FRR of all primary paths.</li> </ul>

	Command	Purpose
Step 10	<b>fast-reroute per-prefix level-2 all</b>  <b>Example:</b> Router(config-router)# fast-reroute per-prefix level-2 all	Configures an FRR path that redirects traffic to a remote LFA tunnel for level-2 packets. <ul style="list-style-type: none"> <li>• <b>level-2</b>—Enables per-prefix FRR of level 2 packets.</li> <li>• <b>all</b>—Enables FRR of all primary paths.</li> </ul>
Step 11	<b>fast-reroute remote-lfa level-1 mpls-ldp</b>  <b>Example:</b> Router(config-router)# fast-reroute remote-lfa level-1 mpls-ldp	Configures an FRR path that redirects traffic to a remote LFA tunnel. <ul style="list-style-type: none"> <li>• <b>level-1</b>—Enables LFA-FRR of level-1 packets.</li> <li>• <b>mpls-ldp</b>—Specifies that the tunnel type is MPLS or LDP.</li> </ul>
Step 12	<b>fast-reroute remote-lfa level-2 mpls-ldp</b>  <b>Example:</b> Router(config-router)# fast-reroute remote-lfa level-2 mpls-ldp	Configures an FRR path that redirects traffic to a remote LFA tunnel. <ul style="list-style-type: none"> <li>• <b>level-2</b>—Enables LFA-FRR of level-2 packets.</li> <li>• <b>mpls-ldp</b>—Specifies that the tunnel type is MPLS or LDP.</li> </ul>
Step 13	<b>bfd all-interfaces</b>  <b>Example:</b> Router(config-router)# bfd all-interfaces	Enables Bidirectional Forwarding Detection (BFD) for all interfaces participating in the routing process.
Step 14	<b>mpls ldp sync</b>  <b>Example:</b> Router(config-router)# mpls ldp sync	Enables MPLS LDP synchronization on interfaces for an IS-IS process.

## Configuring Primary One-hop Auto-Tunnels

To configure primary one-hop auto-tunnels for MPLS TE-FRR, perform the following steps.

### SUMMARY STEPS

1. **enable**
2. **configure terminal**
3. **mpls traffic-eng auto-tunnel primary onehop**
4. **mpls traffic-eng auto-tunnel primary tunnel-num [min num] [max num]**
5. **mpls traffic-eng auto-tunnel primary config unnumbered interface**
6. **mpls traffic-eng auto-tunnel primary timers removal rerouted sec**
7. **mpls traffic-eng auto-tunnel primary config mpls ip**

## DETAILED STEPS

	Command	Purpose
Step 1	<b>enable</b>  <b>Example:</b> Router> enable	Enables privileged EXEC mode. <ul style="list-style-type: none"> <li>Enter your password if prompted.</li> </ul>
Step 2	<b>configure terminal</b>  <b>Example:</b> Router# configure terminal	Enters global configuration mode.
Step 3	<b>mpls traffic-eng auto-tunnel primary onehop</b>  <b>Example:</b> Router(config)# mpls traffic-eng auto-tunnel primary onehop	Creates primary tunnels to all the next hops automatically.
Step 4	<b>mpls traffic-eng auto-tunnel primary tunnel-num [min min-num] [max max-num]</b>  <b>Example:</b> Router(config)# mpls traffic-eng auto-tunnel primary tunnel-num min 3 max 400	Configures the range of tunnel interface numbers for primary autotunnels. <ul style="list-style-type: none"> <li><i>min-num</i>—(Optional) Minimum number of the primary tunnels. The range is 0 to 65535, with a default value of 65436.</li> <li><i>max-num</i>—(Optional) Maximum number of the primary tunnels. The max number is the minimum number plus 99. The range is from 0 to 65535.</li> </ul>
Step 5	<b>mpls traffic-eng auto-tunnel primary config unnumbered interface</b>  <b>Example:</b> Router(config)# mpls traffic-eng auto-tunnel primary config unnumbered-interface Loopback102	Enables IP processing without an explicit address. <ul style="list-style-type: none"> <li><i>interface</i>—Interface on which IP processing is enabled without an explicit address.</li> </ul>
Step 6	<b>mpls traffic-eng auto-tunnel primary timers removal rerouted sec</b>  <b>Example:</b> Router(config)# mpls traffic-eng auto-tunnel primary timers removal rerouted 604800	Configures the period after a failure to remove primary autotunnels. <ul style="list-style-type: none"> <li><i>sec</i>—Number of seconds after a failure that primary autotunnels are removed. The range is from 30 to 604,800, with a default of 0.</li> </ul>
Step 7	<b>mpls traffic-eng auto-tunnel primary config mpls ip</b>  <b>Example:</b> Router(config)# mpls traffic-eng auto-tunnel primary config mpls ip	Enables Label Distribution Protocol (LDP) on primary autotunnels.

## Configuring Backup Auto-Tunnels

To configure backup auto-tunnels, perform the following steps.

### SUMMARY STEPS

1. **enable**
2. **configure terminal**
3. **mpls traffic-eng auto-tunnel backup**
4. **mpls traffic-eng auto-tunnel backup nhop-only**
5. **mpls traffic-eng auto-tunnel backup *tunnel-num* [min *num*] [max *num*]**
6. **mpls traffic-eng auto-tunnel backup timers removal unused *sec***
7. **mpls traffic-eng auto-tunnel backup config unnumbered-interface *interface***

### DETAILED STEPS

	Command	Purpose
Step 1	<b>enable</b>  <b>Example:</b> Router> enable	Enables privileged EXEC mode. <ul style="list-style-type: none"> <li>• Enter your password if prompted.</li> </ul>
Step 2	<b>configure terminal</b>  <b>Example:</b> Router# configure terminal	Enters global configuration mode.
Step 3	<b>mpls traffic-eng auto-tunnel backup</b>  <b>Example:</b> Router(config)# mpls traffic-eng auto-tunnel backup	Builds next-hop (NHOP) and next-next hop (NNHOP) backup tunnels automatically.
Step 4	<b>mpls traffic-eng auto-tunnel backup nhop-only</b>  <b>Example:</b> Router(config)# mpls traffic-eng auto-tunnel backup nhop-only	Builds next-hop (NHOP) backup tunnels automatically.
Step 5	<b>mpls traffic-eng auto-tunnel backup tunnel-num [min <i>min-num</i>] [max <i>max-num</i>]</b>  <b>Example:</b> Router(config)# mpls traffic-eng auto-tunnel backup tunnel-num min 3 max 400	Configures the range of tunnel interface numbers for backup autotunnels. <ul style="list-style-type: none"> <li>• <i>min-num</i>—(Optional) Minimum number of the backup tunnels. The range is 0 to 65535, with a default value of 65436.</li> <li>• <i>max-num</i>—(Optional) Maximum number of the backup tunnels. The max number is the minimum number plus 99. The range is from 0 to 65535.</li> </ul>

	Command	Purpose
Step 6	<pre>mpls traffic-eng auto-tunnel backup timers removal unused sec</pre> <p><b>Example:</b></p> <pre>Router(config)# mpls traffic-eng auto-tunnel primary timers removal rerouted 604800</pre>	<p>Configures how frequently a timer scans the backup autotunnels and remove tunnels that are not being used.</p> <ul style="list-style-type: none"> <li><i>sec</i>—Configures (in seconds) the timer scan interval. The range is 0 to 604,800.</li> </ul>
Step 7	<pre>mpls traffic-eng auto-tunnel backup config unnumbered-interface interface</pre> <p><b>Example:</b></p> <pre>Router(config)# mpls traffic-eng auto-tunnel backup config unnumbered-interface Loopback0</pre>	<p>Configures a specific unnumbered interface for all backup auto-tunnels.</p> <ul style="list-style-type: none"> <li><i>interface</i>—Interface for all backup auto-tunnels. Default interface is Loopback0.</li> </ul>

## Enabling Targeted LDP session over Primary one-hop Auto-Tunnels

An MPLS LDP targeted session is a label distribution session between routers that are not directly connected. When you create an MPLS TE tunnel interface, you need to establish a label distribution session between the tunnel headend and the tailend routers. You establish non-directly connected MPLS LDP sessions by enabling the transmission of targeted Hello messages.

The default behavior of an LSR is to ignore requests from other LSRs that send targeted Hello messages. You can configure an LSR to respond to requests for targeted Hello messages by using the **mpls ldp discovery targeted-hello accept** command.

The active LSR mandates the protocol that is used for a targeted session. The passive LSR uses the protocol of the received targeted Hello messages.

To enable targeted LDP sessions over primary one-hop auto-tunnels, perform the steps given below:



### Note

For targeted mpls session, the head end tunnel should have “mpls ip” configuration.

## SUMMARY STEPS

1. **enable**
2. **configure terminal**
3. **mpls ldp discovery targeted-hello accept**

## DETAILED STEPS

	Command	Purpose
Step 1	<b>enable</b>  <b>Example:</b> Router> enable	Enables privileged EXEC mode. <ul style="list-style-type: none"> <li>Enter your password if prompted.</li> </ul>
Step 2	<b>configure terminal</b>  <b>Example:</b> Router# configure terminal	Enters global configuration mode.
Step 3	<b>mpls ldp discovery targeted-hello accept</b>  <b>Example:</b> Router(config)# mpls ldp discovery targeted-hello accept	Configures the router to respond to requests for targeted Hello messages from all neighbors.

## Enabling BFD Triggered FRR on an SVI Interface

To enable BFD triggered FRR on an SVI interface, perform the steps given below:

## SUMMARY STEPS

1. **enable**
2. **configure terminal**
3. **interface *type number***
4. **ip rsvp signalling hello bfd**

## DETAILED STEPS

	Command	Purpose
Step 1	<b>enable</b>  <b>Example:</b> Router> enable	Enables privileged EXEC mode. <ul style="list-style-type: none"> <li>Enter your password if prompted.</li> </ul>
Step 2	<b>configure terminal</b>  <b>Example:</b> Router# configure terminal	Enters global configuration mode.

	Command	Purpose
Step 3	<code>interface type number</code>  <b>Example:</b> Router(config)# interface vlan 40	Specifies an interface type and number, and enters interface configuration mode.
Step 4	<code>ip rsvp signalling hello bfd</code>  <b>Example:</b> Router(config-if)# ip rsvp signalling hello bfd	Enables BFD protocol on an interface for FRR link protection.

## Enabling BFD Triggered FRR on a Router

To enable BFD triggered FRR on a router, perform the steps given below:

### SUMMARY STEPS

1. `enable`
2. `configure terminal`
3. `ip rsvp signalling hello bfd`

### DETAILED STEPS

	Command	Purpose
Step 1	<code>enable</code>  <b>Example:</b> Router> enable	Enables privileged EXEC mode. <ul style="list-style-type: none"> <li>• Enter your password if prompted.</li> </ul>
Step 2	<code>configure terminal</code>  <b>Example:</b> Router# configure terminal	Enters global configuration mode.
Step 3	<code>ip rsvp signalling hello bfd</code>  <b>Example:</b> Router(config-if)# ip rsvp signalling hello bfd	Enables BFD protocol on an interface for FRR link protection.



## Verification Examples

- [Verifying MPLS TE-FRR Configuration](#)
- [Verifying Primary One-hop Auto-Tunnels](#)
- [Verifying Backup Auto-Tunnels](#)
- [Verifying BFD Triggered FRR Configuration](#)

### Verifying MPLS TE-FRR Configuration

To verify the MPLS TE-FRR configuration, use the **show** commands given below:

- **show mpls traffic-eng tunnels brief**
- **show ip rsvp sender detail**
- **show mpls traffic-eng fast-reroute database**
- **show mpls traffic-eng tunnels backup**
- **show ip rsvp reservation detail**



#### Note

For more information on the above **show** commands, see:

[http://www.cisco.com/en/US/docs/ios-xml/ios/mp\\_te\\_path\\_protect/configuration/xs-3s/mp-te-frr-node-prot.html](http://www.cisco.com/en/US/docs/ios-xml/ios/mp_te_path_protect/configuration/xs-3s/mp-te-frr-node-prot.html)

Use the following command to verify whether the backup tunnels are up.

```
Router# show mpls traffic-eng tunnels brief
```

```
Signalling Summary:
  LSP Tunnels Process:      running
  RSVP Process:            running
  Forwarding:              enabled
  Periodic reoptimization: every 3600 seconds, next in 1706 seconds
TUNNEL NAME                DESTINATION    UP IF    DOWN IF    STATE/PROT
Router_t1                  10.112.0.12   -        PO4/0/1   up/up
Router_t2                  10.112.0.12   -        unknown   up/down
Router_t3                  10.112.0.12   -        unknown   admin-down
Router_t1000               10.110.0.10   -        unknown   up/down
Router_t2000               10.110.0.10   -        PO4/0/1   up/up
Displayed 5 (of 5) heads, 0 (of 0) midpoints, 0 (of 0) tails
```

Use the following command to verify whether the LSPs are protected by the appropriate backup tunnels.

```
Router# show ip rsvp sender detail
```

```
PATH:
Tun Dest: 10.10.0.6 Tun ID: 100 Ext Tun ID: 10.10.0.1
Tun Sender: 10.10.0.1 LSP ID: 31
Path refreshes:
  arriving: from PHOP 10.10.7.1 on Et0/0 every 30000 msecs
Session Attr:
  Setup Prio: 7, Holding Prio: 7
  Flags: (0x7) Local Prot desired, Label Recording, SE Style
  session Name: R1_t100
ERO: (incoming)
  10.10.7.2 (Strict IPv4 Prefix, 8 bytes, /32)
  10.10.0.6 (Strict IPv4 Prefix, 8 bytes, /32)
RRO:
```

```

10.10.7.1/32, Flags:0x0 (No Local Protection)
10.10.4.1/32, Flags:0x9 (Local Prot Avail/to NNHOP) !Available to NNHOP
10.10.1.1/32, Flags:0x0 (No Local Protection)
Traffic params - Rate: 10K bits/sec, Max. burst: 1K bytes
Min Policed Unit: 0 bytes, Max Pkt Size 4294967295 bytes
Fast-Reroute Backup info:
  Inbound FRR: Not active
  Outbound FRR: No backup tunnel selected
Path ID handle: 50000416.
Incoming policy: Accepted. Policy source(s): MPLS/TE
Status: Proxy-terminated

```

Use the following command to verify whether the LSPs are protected.

```
Router# show mpls traffic-eng fast-reroute database
```

```

Tunnel head end item frr information:
Protected Tunnel      In-label  intf/label      FRR intf/label      Status
Tunnell0             Tun       pos5/0:Untagged Tu0:12304           ready
Prefix item frr information:
Prefix      Tunnel In-label  Out intf/label      FRR intf/label      Status
10.0.0.11/32 Tu110    Tun hd   pos5/0:Untagged    Tu0:12304           ready
LSP midpoint frr information:
LSP identifier      In-label  Out intf/label      FRR intf/label      Status
10.0.0.12 1 [459]    16       pos0/1:17          Tu2000:19           ready

```

Use the following command to verify the backup tunnel information.

```
Router# show mpls traffic-eng tunnels backup
```

```

Router_t578
LSP Head, Tunnel578, Admin: up, Oper: up
Src 10.55.55.55, Dest 10.88.88.88, Instance 1
Fast Reroute Backup Provided:
  Protected i/fs: PO1/0, PO1/1, PO3/3
  Protected lsp: 1
  Backup BW: any pool unlimited; inuse: 100 kbps
Router_t5710
LSP Head, Tunnel5710, Admin: admin-down, Oper: down
Src 10.55.55.55, Dest 10.7.7.7, Instance 0
Fast Reroute Backup Provided:
  Protected i/fs: PO1/1
  Protected lsp: 0
  Backup BW: any pool unlimited; inuse: 0 kbps
Router_t5711
LSP Head, Tunnel5711, Admin up, Oper: up
Src 10.55.55.55,, Dest 10.7.7.7, Instance 1
Fast Reroute Backup Provided:
  Protected i/fs: PO1/0
  Protected lsp: 2
  Backup BW: any pool unlimited; inuse: 6010 kbps

```

Use the following command to verify the reservation detail.

```
Router# show ip rsvp reservation detail
```

```

Reservation:
Tun Dest: 10.1.1.1  Tun ID: 1  Ext Tun ID: 172.16.1.1
Tun Sender: 172.16.1.1  LSP ID: 104
Next Hop: 172.17.1.2 on POS1/0
Label: 18 (outgoing)
Reservation Style is Shared-Explicit, QoS Service is Controlled-Load
Average Bitrate is 0 bits/sec, Maximum Burst is 1K bytes
Min Policed Unit: 0 bytes, Max Pkt Size: 0 bytes
RRO:

```

```

172.18.1.1/32, Flags:0x1 (Local Prot Avail/to NHOP)
  Label subobject: Flags 0x1, C-Type 1, Label 18
172.19.1.1/32, Flags:0x0 (Local Prot Avail/In Use/Has BW/to NHOP)
  Label subobject: Flags 0x1, C-Type 1, Label 16
172.19.1.2/32, Flags:0x0 (No Local Protection)
  Label subobject: Flags 0x1, C-Type 1, Label 0
Resv ID handle: CD000404.
Policy: Accepted. Policy source(s): MPLS/TE

```

## Verifying Primary One-hop Auto-Tunnels

To verify the configuration of primary one-hop auto-tunnels, use the **show** commands as shown in the following examples.

```
Router# show ip rsvp fast-reroute
```

Primary Tunnel	Protect I/F	BW BPS:Type	Backup Tunnel:Label	State	Level	Type
R3-PRP_t0	PO3/1	0:G	Tu1000:24	Ready	any-unl	Nhop

```
Router# show ip interface brief
```

Interface	IP-Address	OK?	Method	Status	Protocol
POS2/0	10.0.0.14	YES	NVRAM	down	down
POS2/1	10.0.0.49	YES	NVRAM	up	up
POS2/2	10.0.0.45	YES	NVRAM	up	up
POS2/3	10.0.0.57	YES	NVRAM	administratively down	down
POS3/0	10.0.0.18	YES	NVRAM	down	down
POS3/1	10.0.0.33	YES	NVRAM	up	up
POS3/2	unassigned	YES	NVRAM	administratively down	down
POS3/3	unassigned	YES	NVRAM	administratively down	down
GigabitEthernet4/0	10.0.0.37	YES	NVRAM	up	up
GigabitEthernet4/1	unassigned	YES	NVRAM	administratively down	down
GigabitEthernet4/2	unassigned	YES	NVRAM	administratively down	down
Loopback0	10.0.3.1	YES	NVRAM	up	up
Tunnel0	10.0.3.1	YES	unset	up	up
Tunnel65436	10.0.3.1	YES	unset	up	up
Ethernet0	10.3.38.3	YES	NVRAM	up	up
Ethernet1	unassigned	YES	NVRAM	administratively down	down

## Verifying Backup Auto-Tunnels

To verify the configuration of backup auto-tunnels, use the **show** commands as shown in the following examples.

```
Router# show ip rsvp fast-reroute
```

Primary Tunnel	Protect I/F	BW BPS:Type	Backup Tunnel:Label	State	Level	Type
R3-PRP_t0	PO3/1	0:G	None	None	None	

```
Router# show ip interface brief
```

Interface	IP-Address	OK?	Method	Status	Protocol
POS2/0	10.0.0.14	YES	NVRAM	down	down

POS2/1	10.0.0.49	YES NVRAM	up	up
POS2/2	10.0.0.45	YES NVRAM	up	up
POS2/3	10.0.0.57	YES NVRAM	administratively down	down
POS3/0	10.0.0.18	YES NVRAM	down	down
POS3/1	10.0.0.33	YES NVRAM	up	up
POS3/2	unassigned	YES NVRAM	administratively down	down
POS3/3	unassigned	YES NVRAM	administratively down	down
GigabitEthernet4/0	10.0.0.37	YES NVRAM	up	up
GigabitEthernet4/1	unassigned	YES NVRAM	administratively down	down
GigabitEthernet4/2	unassigned	YES NVRAM	administratively down	down
Loopback0	10.0.3.1	YES NVRAM	up	up
Tunnel0	10.0.3.1	YES unset	up	up
Tunnel65436	10.0.3.1	YES unset	up	up
Tunnel65437	10.0.3.1	YES unset	up	up
Ethernet0	10.3.38.3	YES NVRAM	up	up
Ethernet1	unassigned	YES NVRAM	administratively down	down

```
Router# show mpls traffic-eng tunnels backup
```

```
Router_t578
LSP Head, Tunnel578, Admin: up, Oper: up
Src 10.55.55.55, Dest 10.88.88.88, Instance 1
Fast Reroute Backup Provided:
  Protected i/fs: PO1/0, PO1/1, PO3/3
  Protected lsp: 1
  Backup BW: any pool unlimited; inuse: 100 kbps
Router_t5710
LSP Head, Tunnel5710, Admin: admin-down, Oper: down
Src 10.55.55.55, Dest 10.7.7.7, Instance 0
Fast Reroute Backup Provided:
  Protected i/fs: PO1/1
  Protected lsp: 0
  Backup BW: any pool unlimited; inuse: 0 kbps
Router_t5711
LSP Head, Tunnel5711, Admin up, Oper: up
Src 10.55.55.55,, Dest 10.7.7.7, Instance 1
Fast Reroute Backup Provided:
  Protected i/fs: PO1/0
  Protected lsp: 2
  Backup BW: any pool unlimited; inuse: 6010 kbps
```

## Verifying BFD Triggered FRR Configuration

To verify the configuration of BFD triggered FRR, use the **show** commands as shown in the following examples.

- **show mpls traffic-eng tunnels brief**
- **show ip rsvp sender detail**
- **show mpls traffic-eng fast-reroute database**
- **show mpls traffic-eng tunnels backup**
- **show ip rsvp reservation detail**
- **show ip rsvp hello**
- **show ip rsvp interface detail**
- **show ip rsvp hello bfd nbr**

- **show ip rsvp hello bfd nbr detail**
- **show ip rsvp hello bfd nbr summary**

**Note**

For more information on the above **show** commands, see:

[http://www.cisco.com/en/US/docs/ios-xml/ios/mp\\_te\\_path\\_protect/configuration/xe-3s/mp-te-bfd-frr.html](http://www.cisco.com/en/US/docs/ios-xml/ios/mp_te_path_protect/configuration/xe-3s/mp-te-bfd-frr.html)

Use the following command to verify whether or not the backup tunnels are up:

```
Router# show mpls traffic-eng tunnels brief
```

```
Signalling Summary:
  LSP Tunnels Process:      running
  RSVP Process:            running
  Forwarding:              enabled
  Periodic reoptimization: every 3600 seconds, next in 1706 seconds
TUNNEL NAME                DESTINATION    UP IF    DOWN IF    STATE/PROT
Router_t1                  10.112.0.12   -        Gi4/0/1    up/up
Router_t2                  10.112.0.12   -        unknown    up/down
Router_t3                  10.112.0.12   -        unknown    admin-down
Router_t1000               10.110.0.10   -        unknown    up/down
Router_t2000               10.110.0.10   -        Gi4/0/1    up/up
Displayed 5 (of 5) heads, 0 (of 0) midpoints, 0 (of 0) tails
```

Use the following command to verify whether the LSPs are protected by the appropriate backup tunnels.

```
Router# show ip rsvp sender detail
```

```
PATH:
Tun Dest: 10.10.0.6 Tun ID: 100 Ext Tun ID: 10.10.0.1
Tun Sender: 10.10.0.1 LSP ID: 31
Path refreshes:
  arriving: from PHOP 10.10.7.1 on Et0/0 every 30000 msec
Session Attr:
  Setup Prio: 7, Holding Prio: 7
  Flags: (0x7) Local Prot desired, Label Recording, SE Style
  session Name: Rl_t100
ERO: (incoming)
  10.10.7.2 (Strict IPv4 Prefix, 8 bytes, /32)
  10.10.0.6 (Strict IPv4 Prefix, 8 bytes, /32)
RRO:
  10.10.7.1/32, Flags:0x0 (No Local Protection)
  10.10.4.1/32, Flags:0x9 (Local Prot Avail/to NNHOP) !Available to NNHOP
  10.10.1.1/32, Flags:0x0 (No Local Protection)
Traffic params - Rate: 10K bits/sec, Max. burst: 1K bytes
  Min Policed Unit: 0 bytes, Max Pkt Size 4294967295 bytes
Fast-Reroute Backup info:
  Inbound FRR: Not active
  Outbound FRR: No backup tunnel selected
Path ID handle: 50000416.
Incoming policy: Accepted. Policy source(s): MPLS/TE
Status: Proxy-terminated
```

Use the following command to verify whether the LSPs are protected:

```
Router# show mpls traffic-eng fast-reroute database
```

```
Tunnel head end item frr information:
Protected tunnel          In-label Out intf/label    FRR intf/label    Status
```

```
Tunnel500          Tun hd  AT4/0.100:Untagg Tu501:20          ready
Prefix item frr information:
Prefix            Tunnel   In-label Out intf/label   FRR intf/label   Status
10.0.0.8/32       Tu500   18       AT4/0.100:Pop ta Tu501:20          ready
10.0.8.8/32       Tu500   19       AT4/0.100:Untagg Tu501:20          ready
10.8.9.0/24       Tu500   22       AT4/0.100:Untagg Tu501:20          ready
LSP midpoint item frr information:
LSP identifier    In-label Out   intf/label   FRR intf/label   Status
```

Use the following command to verify the backup tunnel information.

```
Router# show mpls traffic-eng tunnels backup
```

```
Router_t578
LSP Head, Tunnel578, Admin: up, Oper: up
Src 10.55.55.55, Dest 10.88.88.88, Instance 1
Fast Reroute Backup Provided:
Protected i/fs: PO1/0, PO1/1, PO3/3
Protected lsp: 1
Backup BW: any pool unlimited; inuse: 100 kbps
Router_t5710
LSP Head, Tunnel5710, Admin: admin-down, Oper: down
Src 10.55.55.55, Dest 10.7.7.7, Instance 0
Fast Reroute Backup Provided:
Protected i/fs: PO1/1
Protected lsp: 0
Backup BW: any pool unlimited; inuse: 0 kbps
Router_t5711
LSP Head, Tunnel5711, Admin: up, Oper: up
Src 10.55.55.55, Dest 10.7.7.7, Instance 1
Fast Reroute Backup Provided:
Protected i/fs: PO1/0
Protected lsp: 2
Backup BW: any pool unlimited; inuse: 6010 kbps
```

Use the following command to verify detailed RSVP-related receiver information currently in the database.

```
Router# show ip rsvp reservation detail
```

```
Reservation:
Tun Dest: 10.1.1.1 Tun ID: 1 Ext Tun ID: 10.1.1.1
Tun Sender: 10.1.1.1 LSP ID: 104
Next Hop: 10.1.1.2 on Gi1/0
Label: 18 (outgoing)
Reservation Style is Shared-Explicit, QoS Service is Controlled-Load
Average Bitrate is 0 bits/sec, Maximum Burst is 1K bytes
Min Policed Unit: 0 bytes, Max Pkt Size: 0 bytes
RRO:
10.1.1.1/32, Flags:0x1 (Local Prot Avail/to NHOP)
Label subobject: Flags 0x1, C-Type 1, Label 18
10.1.1.1/32, Flags:0x0 (Local Prot Avail/In Use/Has BW/to NHOP)
Label subobject: Flags 0x1, C-Type 1, Label 16
10.1.1.2/32, Flags:0x0 (No Local Protection)
Label subobject: Flags 0x1, C-Type 1, Label 0
Resv ID handle: CD000404.
Policy: Accepted. Policy source(s): MPLS/TE
```

Use this command to display hello status and statistics for FRR, reroute (hello state timer), and graceful restart.

```
Router# show ip rsvp hello
```

```
Hello:
```

```

RSVP Hello for Fast-Reroute/Reroute: Enabled
  Statistics: Disabled
BFD for Fast-Reroute/Reroute: Enabled
RSVP Hello for Graceful Restart: Disabled

```

Use this command to display the interface configuration for Hello.

```
Router# show ip rsvp interface detail
```

```

Gi9/47:
RSVP: Enabled
Interface State: Up
Bandwidth:
  Curr allocated: 0 bits/sec
  Max. allowed (total): 0 bits/sec
  Max. allowed (per flow): 0 bits/sec
  Max. allowed for LSP tunnels using sub-pools (pool 1): 0 bits/sec
  Set aside by policy (total): 0 bits/sec
Signalling:
  DSCP value used in RSVP msgs: 0x3F
  Number of refresh intervals to enforce blockade state: 4
Authentication: disabled
  Key chain: <none>
  Type: md5
  Window size: 1
  Challenge: disabled
FRR Extension:
  Backup Path: Configured (or "Not Configured")
BFD Extension:
  State: Disabled
  Interval: Not Configured
RSVP Hello Extension:
  State: Disabled
  Refresh Interval: FRR: 200 , Reroute: 2000
  Missed Acks:      FRR: 4 , Reroute: 4
  DSCP in HELLOs:  FRR: 0x30 , Reroute: 0x30

```

Use this command to display information about all MPLS traffic engineering link and node protected neighbors that use the BFD protocol.

```
Router# show ip rsvp hello bfd nbr
```

Client	Neighbor	I/F	State	LostCnt	LSPs
FRR	10.0.0.6	Gi9/47	Up	0	1

Use this command to display detailed information about all MPLS traffic engineering link and node protected neighbors that use the BFD protocol:

```
Router# show ip rsvp hello bfd nbr detail
```

```

Hello Client Neighbors
Remote addr 10.0.0.6, Local addr 10.0.0.7
Type: Active
I/F: Gi9/47
State: Up (for 00:09:41)
Clients: FRR
LSPs protecting: 1 (frr: 1, hst upstream: 0 hst downstream: 0)
Communication with neighbor lost: 0

```

Use this command to display summarized information about all MPLS traffic engineering link and node protected neighbors that use the BFD protocol.

```
Router# show ip rsvp hello bfd nbr summary
```

Client	Neighbor	I/F	State	LostCnt	LSPs
FRR	10.0.0.6	Gi9/47	Up	0	1

## Configuration Examples

This section provides sample configuration examples for MPLS TE-FRR feature and BFD triggered TE/FRR feature on the Cisco ASR 901 Routers.

- [Example: Configuring MPLS TE-FRR, page 34-24](#)
- [Example: Configuring Primary One-hop Auto-Tunnels, page 34-24](#)
- [Example: Configuring Backup Auto-Tunnels, page 34-24](#)
- [Example: Configuring BFD Triggered FRR, page 34-24](#)

### Example: Configuring MPLS TE-FRR

For a sample configuration of MPLS TE-FRR, see:

[http://www.cisco.com/en/US/docs/ios-xml/ios/mp\\_te\\_path\\_protect/configuration/xe-3s/mp-te-frr-node-prot.html](http://www.cisco.com/en/US/docs/ios-xml/ios/mp_te_path_protect/configuration/xe-3s/mp-te-frr-node-prot.html)

### Example: Configuring Primary One-hop Auto-Tunnels

For a sample configuration of primary one-hop auto-tunnels, see:

[http://www.cisco.com/en/US/docs/ios-xml/ios/mp\\_te\\_path\\_protect/configuration/xe-3s/mp-te-autotunnel.html](http://www.cisco.com/en/US/docs/ios-xml/ios/mp_te_path_protect/configuration/xe-3s/mp-te-autotunnel.html)

### Example: Configuring Backup Auto-Tunnels

For a sample configuration of backup auto-tunnels, see:

[http://www.cisco.com/en/US/docs/ios-xml/ios/mp\\_te\\_path\\_protect/configuration/xe-3s/mp-te-autotunnel.html](http://www.cisco.com/en/US/docs/ios-xml/ios/mp_te_path_protect/configuration/xe-3s/mp-te-autotunnel.html)

### Example: Configuring BFD Triggered FRR

For a sample configuration of BFD triggered FRR, see:

[http://www.cisco.com/en/US/docs/ios-xml/ios/mp\\_te\\_path\\_protect/configuration/xe-3s/mp-te-bfd-frr.html](http://www.cisco.com/en/US/docs/ios-xml/ios/mp_te_path_protect/configuration/xe-3s/mp-te-bfd-frr.html)



## Additional References

The following sections provide references related to MPLS Traffic Engineering - Fast Reroute Link Protection feature.

### Related Documents

Related Topic	Document Title
Cisco IOS Commands	<a href="#">Cisco IOS Master Commands List, All Releases</a>
ASR 901 Commands	<a href="#">Cisco ASR 901 Series Aggregation Services Router Command Reference</a>
Cisco IOS MPLS Commands	<a href="#">Cisco IOS Multiprotocol Label Switching Command Reference</a>
MPLS TE - FRR	<a href="#">MPLS Traffic Engineering (TE)--Fast Reroute (FRR) Link</a>
MPLS TE - BFD Triggered FRR	<a href="#">MPLS Traffic Engineering BFD-triggered Fast Reroute</a>

### Standards

Standard	Title
None	—

### MIBs

MIB	MIBs Link
None	To locate and download MIBs for selected platforms, Cisco IOS releases, and feature sets, use Cisco MIB Locator found at the following URL: <a href="http://www.cisco.com/go/mibs">http://www.cisco.com/go/mibs</a>

### RFCs

RFC	Title
None	—

## Technical Assistance

Description	Link
The Cisco Technical Support website contains thousands of pages of searchable technical content, including links to products, technologies, solutions, technical tips, and tools. Registered Cisco.com users can log in from this page to access even more content.	<a href="http://www.cisco.com/techsupport">http://www.cisco.com/techsupport</a>

# Feature Information for MPLS Traffic Engineering - Fast Reroute Link Protection

Table 34-1 lists the features in this module and provides links to specific configuration information.

Use Cisco Feature Navigator to find information about platform support and software image support. Cisco Feature Navigator enables you to determine which software images support a specific software release, feature set, or platform. To access Cisco Feature Navigator, go to <http://www.cisco.com/go/cfn>. An account on Cisco.com is not required.



**Note**

Table 34-1 lists only the software release that introduced support for a given feature in a given software release train. Unless noted otherwise, subsequent releases of that software release train also support that feature.

**Table 34-1** Feature Information for MPLS Traffic Engineering - Fast Reroute Link Protection

Feature Name	Releases	Feature Information
MPLS Traffic Engineering	15.2(2)SNG	This feature was introduced on the Cisco ASR 901 routers. The following sections provide information about this feature: <ul style="list-style-type: none"> <li>• <a href="#">Enabling MPLS TE-FRR on an SVI Interface, page 34-5</a></li> </ul>
BFD-triggered Fast Reroute	15.2(2)SNG	This feature was introduced on the Cisco ASR 901 routers. The following sections provide information about this feature: <ul style="list-style-type: none"> <li>• <a href="#">BFD-triggered Fast Reroute, page 34-3</a></li> <li>• <a href="#">Enabling BFD Triggered FRR on a Router, page 34-16</a></li> <li>• <a href="#">Enabling BFD Triggered FRR on a Router, page 34-16</a></li> </ul>
TE-FRR for EoMPLS	15.3(2)S	This feature was introduced on the Cisco ASR 901 routers. The following sections provide information about this feature: <ul style="list-style-type: none"> <li>• <a href="#">Enabling MPLS TE-FRR for EoMPLS on a Global Interface, page 34-5</a></li> <li>• <a href="#">Enabling MPLS TE-FRR for EoMPLS on an Interface, page 34-7</a></li> </ul>





# Layer 2 Control Protocol Peering, Forwarding, and Tunneling

---

This feature module describes how to configure Layer 2 (L2) Control Protocol Peering, Forwarding, and Tunneling feature on the Cisco ASR 901 Series Aggregation Services Routers.

## Finding Feature Information

Your software release may not support all the features documented in this module. For the latest feature information and caveats, see the release notes for your platform and software release. To find information about the features documented in this module, and to see a list of the releases in which each feature is supported, see the [“Feature Information for Layer 2 Control Protocol Peering, Forwarding, and Tunneling” section on page 35-15](#).

Use Cisco Feature Navigator to find information about platform support and Cisco software image support. To access Cisco Feature Navigator, go to <http://www.cisco.com/go/cfn>. An account on Cisco.com is not required.

## Contents

- [Prerequisites, page 35-1](#)
- [Restrictions, page 35-2](#)
- [Layer 2 Control Protocol Forwarding, page 35-2](#)
- [How to Configure Layer 2 Control Protocol Peering, Forwarding, and Tunneling, page 35-3](#)
- [Configuration Examples, page 35-10](#)
- [Additional References, page 35-13](#)
- [Feature Information for Layer 2 Control Protocol Peering, Forwarding, and Tunneling, page 35-15](#)

## Prerequisites

A Cisco IOS software that supports Layer 2 Control Protocol Peering, Forwarding, and Tunneling must be installed previously on the Cisco ASR 901 Series Aggregation Services Router. For supported software releases, see [Release Notes for Cisco ASR 901 Series Aggregation Services Router](#).

## Restrictions

If you want to peer Operation, Administration, and Maintenance (OAM) packets when **l2proto-forward tagged** command is configured at the interface level, you should also configure the **l2protocol peer lacp** command.

## Layer 2 Control Protocol Forwarding

The ASR 901 forwards Layer 2 Control Protocol (L2CP) packets between customer-edge (CE) devices.

Figure 35-1 depicts an end-to-end layer 2 forwarding. The layer 2 traffic is sent through the S-network, and the S-network switches the traffic from end to end. The Cisco ASR 901 router forwards frames from the user network interface (UNI) to the network-to-network Interface (NNI) after appending S-tag. The third party provider edge (PE) router forwards the S-tagged frames. The PE peers the untagged Link Layer Discovery Protocol (LLDP) and Link Aggregation Control Protocol (LACP) frames. On the reverse path (from NNI to UNI), the S-tag is removed.

Figure 35-1 Layer 2 Forwarding

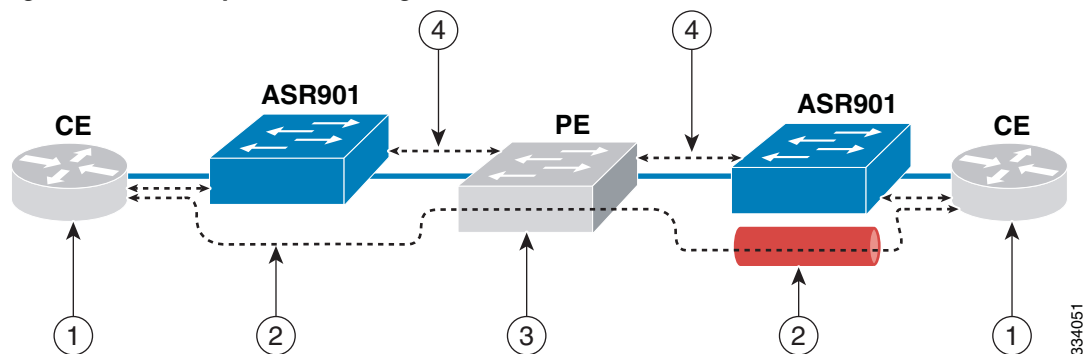

1	L2CP packets are forwarded between CE devices.	3	Third party PE forwards S-tagged frames and peers untagged frames.
2	Frames are forwarded from UNI to NNI after appending the S-tag. On the reverse path (NNI to UNI), S-tag is removed.	4	Untagged LLDP and LACP is peered.

## Layer 2 Control Protocol Tunneling

Layer 2 Control Protocol Tunneling (L2PT) is a Cisco proprietary protocol for tunneling Ethernet protocol frames across layer 2 switching domains. The following tunnel protocols are supported:

- Cisco Discovery Protocol (CDP)
- Dynamic Trunking Protocol (DTP)
- Link Aggregation Control Protocol (LACP)
- Link Layer Discovery Protocol (LLDP)

- Spanning Tree Protocol (STP)—including Multiservice Transport Platform (MSTP) and Per VLAN Spanning Tree (PVST)
- Virtual Trunking Protocol (VTP)

The ASR 901 router allows to tunnel layer 2 packets between CEs. The Cisco proprietary multicast address (01-00-0c-cd-cd-d0) is used while tunneling the packet over the NNI interfaces.

Figure 35-2 depicts Layer 2 Protocol Tunneling. The layer 2 traffic is sent through the S-network, and the S-network switches the traffic from end to end. The Cisco multicast address is added to the frames and sent from UNI to NNI. On the reverse path (NNI to UNI), protocol specific multicast address is attached to the frames and sent to the UNI.

Figure 35-2 Layer 2 Protocol Tunneling

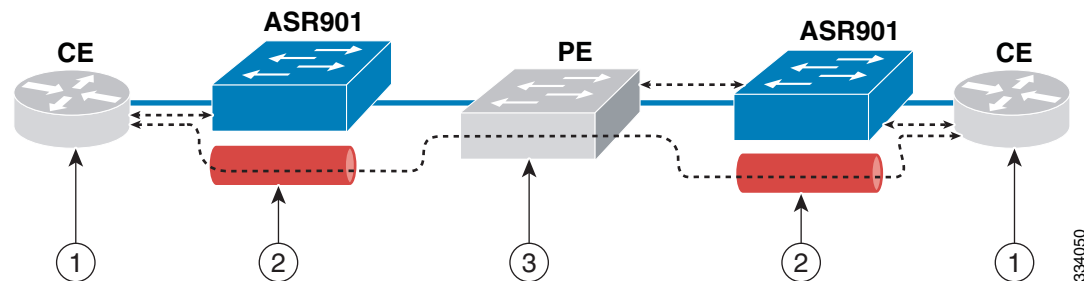

1	CE layer 2 control protocol tunnel (end-to-end).	3	Third party PE forwards S-tagged frames and peers untagged frames.
2	Cisco multicast address is added to the frames and sent from UNI to NNI. On the reverse path (NNI to UNI), a protocol specific multicast address is attached to the frames and sent to UNI.	4	—

## How to Configure Layer 2 Control Protocol Peering, Forwarding, and Tunneling

This section describes how to configure layer 2 control protocol peering, forwarding and tunneling:



### Note

The configuration defined for LACP impacts all slow protocols, and is applicable to all the options like peering, forwarding, and tunneling.

- [Configuring Layer 2 Peering, page 35-4](#) (Required)
- [Configuring Layer 2 Forwarding, page 35-5](#) (Required)
- [Configuring Layer 2 Tunneling, page 35-7](#) (Required)
- [Verifying Layer 2 Peering, page 35-9](#) (Optional)
- [Verifying Layer 2 Forwarding, page 35-9](#) (Optional)
- [Verifying Layer 2 Tunneling, page 35-9](#) (Optional)

## Configuring Layer 2 Peering

The ASR 901 router supports layer 2 peering functionality on a per Ethernet Flow Point (EFP) basis. It supports a maximum packet rate of 10 packets ps (per interface) for a protocol, and 100 packets ps for all protocols (on all interfaces).

Table 35-1 displays the supported defaults and configuration options for the Cisco ASR 901 router.

**Table 35-1 Options Supported on the ASR 901 Router**

Protocol	Packet Type	Default Action	Configuration Option
CDP	Untagged	Peer	Peer/Forward/Tunnel
DTP	Untagged	Peer	Peer/Forward/Tunnel
LACP	Untagged	Peer	Peer/Forward/Tunnel
LLDP	Untagged	Peer	Peer/Forward/Tunnel
STP	Untagged	Peer	Peer/Forward/Tunnel
VTP	Untagged	Peer	Peer/Forward/Tunnel
CDP	Tagged	Drop	Forward/Tunnel
DTP	Tagged	Drop	Forward/Tunnel
LACP	Tagged	Drop	Forward/Tunnel
LLDP	Tagged	Drop	Forward/Tunnel
STP	Tagged	Drop	Forward/Tunnel
VTP	Tagged	Drop	Forward/Tunnel

Complete the following steps to configure layer 2 peering:

### Restrictions

If an EFP is configured with layer 2 peering, then L2CP packets coming on the EFP is sent to the CPU for local protocol processing.

### SUMMARY STEPS

1. **enable**
2. **configure terminal**
3. **interface** *type number*
4. **service instance** *id ethernet*
5. **encapsulation** *encapsulation-type*
6. **l2protocol peer** [*protocol*]



## DETAILED STEPS

	Command	Purpose
Step 1	<code>enable</code>  <b>Example:</b> Router> enable	Enables privileged EXEC mode. <ul style="list-style-type: none"> <li>Enter your password if prompted.</li> </ul>
Step 2	<code>configure terminal</code>  <b>Example:</b> Router# configure terminal	Enters global configuration mode.
Step 3	<code>interface type number</code>  <b>Example:</b> Router(config)# interface gigabitethernet 0/6	Specifies an interface type and number and enters interface configuration mode.
Step 4	<code>service instance id ethernet</code>  <b>Example:</b> Router(config-if)# service instance 20 ethernet	Configures an Ethernet service instance on an interface. <ul style="list-style-type: none"> <li><i>id</i>—Integer that uniquely identifies a service instance on an interface.</li> </ul>
Step 5	<code>encapsulation encapsulation-type</code>  <b>Example:</b> Router(config-if-srv)# encapsulation untagged	Defines the matching criteria to map untagged ingress Ethernet frames on an interface to the appropriate service instance.
Step 6	<code>l2protocol peer [protocol]</code>  <b>Example:</b> Router(config-if-srv)# l2protocol peer lacp	Configures transparent Layer 2 protocol peering on the interface for a specified layer 2 protocol. <ul style="list-style-type: none"> <li><i>protocol</i>—The protocol to be used. The options are: <i>cdp</i>, <i>dtp</i>, <i>lacp</i>, <i>lldp</i>, <i>stp</i>, and <i>vtp</i>.</li> </ul> <p> <b>Note</b> The peer option is not supported for DTP protocol.</p>

## Configuring Layer 2 Forwarding

Complete the following steps to configure layer 2 forwarding:

### Restrictions

- The layer 2 forwarding functionality is supported only on an untagged EFP (Only one untagged EFP exists per interface).
- Forwarding functionality is not supported with dot1q VLAN range encapsulation.

- If an interface is configured with layer 2 protocol forwarding, then L2CP packets on the interface are flooded on to the bridge domain. The flooding follows the translations specified in interface.

## SUMMARY STEPS

1. **enable**
2. **configure terminal**
3. **interface** *type number*
4. **l2proto-forward tagged** *protocol*
5. **service instance** *id* **ethernet**
6. **encapsulation untagged**
7. **l2protocol forward** [*protocol*]
8. **bridge-domain** *bridge-id*

## DETAILED STEPS

	Command	Purpose
Step 1	<b>enable</b>  <b>Example:</b> Router> enable	Enables privileged EXEC mode. <ul style="list-style-type: none"> <li>• Enter your password if prompted.</li> </ul>
Step 2	<b>configure terminal</b>  <b>Example:</b> Router# configure terminal	Enters global configuration mode.
Step 3	<b>interface</b> <i>type number</i>  <b>Example:</b> Router(config)# interface gigabitethernet 0/1	Specifies an interface type and number and enters interface configuration mode.
Step 4	<b>l2proto-forward tagged</b> <i>protocol</i>  <b>Example:</b> Router(config-if)# l2proto-forward tagged cdp	Configures a layer 2 control protocol forwarding on an interface. <ul style="list-style-type: none"> <li>• <i>protocol</i>—Specifies the protocol to be forwarded.</li> </ul>
Step 5	<b>service instance</b> <i>id</i> <b>ethernet</b>  <b>Example:</b> Router(config-if)# service instance 20 ethernet	Configures an Ethernet service instance on an interface. <ul style="list-style-type: none"> <li>• <i>id</i>—Integer that uniquely identifies a service instance on an interface.</li> </ul>

	Command	Purpose
Step 6	<code>encapsulation untagged</code>  <b>Example:</b> Router(config-if-srv)# encapsulation untagged	Defines the matching criteria to map untagged ingress Ethernet frames on an interface to the appropriate service instance.
Step 7	<code>l2protocol forward [protocol]</code>  <b>Example:</b> Router(config-if-srv)# l2protocol forward cdp	Enables forwarding of untagged packets of specified protocol in a service instance. <ul style="list-style-type: none"> <li><i>protocol</i>—The protocol to be used. The options are: <i>cdp</i>, <i>dtp</i>, <i>lacp</i>, <i>lldp</i>, <i>stp</i>, and <i>vtp</i>.</li> </ul>
Step 8	<code>bridge-domain bridge-id</code>  <b>Example:</b> Router(config-if-srv)# bridge-domain 200	Binds a service instance to a bridge domain instance. <ul style="list-style-type: none"> <li><i>bridge-id</i>—Identifier for the bridge domain instance.</li> </ul>

## Configuring Layer 2 Tunneling

The ASR 901 router supports layer 2 control protocol tunneling functionality on a per EFP basis. This functionality is supported for tagged and untagged packets based on CDP, DTP, LACP, LLDP, STP, and VTP protocols.

If an EFP is configured for layer 2 control protocol tunneling, then:

- Any L2CP packet coming on the EFP is forwarded to the bridge domain (BD) with Cisco proprietary multicast address (01-00-0c-cd-cd-d0).
- Any packet coming on the BD with Cisco proprietary multicast address (01-00-0c-cd-cd-d0) is stamped with well known L2CP MAC address (on EFP which has layer 2 protocol tunneling configured).
- A packet with Cisco proprietary multicast address is forwarded as is if l2protocol tunnel is not configured.

Complete the following steps to configure layer 2 tunneling:

### Restrictions

- Layer 2 control protocol tunneling is not supported on x-connect EFPs, and at the interface level.
- Tunneling functionality is not supported with dot1q VLAN range encapsulation.
- Layer 2 control protocol tunneling supports a maximum packet rate of 10 packets ps (per interface) for a protocol, and 100 packets ps for all protocols (on all interfaces).

### SUMMARY STEPS

- enable**
- configure terminal**
- interface** *type number*

4. **service instance** *id* **ethernet**
5. **encapsulation** *encapsulation-type*
6. **l2protocol tunnel** [*protocol*]
7. **bridge-domain** *bridge-id*

## DETAILED STEPS

	Command	Purpose
Step 1	<b>enable</b>  <b>Example:</b> Router> enable	Enables privileged EXEC mode. <ul style="list-style-type: none"> <li>Enter your password if prompted.</li> </ul>
Step 2	<b>configure terminal</b>  <b>Example:</b> Router# configure terminal	Enters global configuration mode.
Step 3	<b>interface</b> <i>type number</i>  <b>Example:</b> Router(config)# interface gigabitethernet 0/4	Specifies an interface type and number and enters interface configuration mode.
Step 4	<b>service instance</b> <i>id</i> <b>ethernet</b>  <b>Example:</b> Router(config-if)# service instance 9 ethernet	Configure an Ethernet service instance on an interface. <ul style="list-style-type: none"> <li><i>id</i>—Integer that uniquely identifies a service instance on an interface.</li> </ul>
Step 5	<b>encapsulation</b> <i>encapsulation-type</i>  <b>Example:</b> Router(config-if-srv)# encapsulation untagged	Sets the encapsulation method used by the interface. <ul style="list-style-type: none"> <li><i>encapsulation type</i>—Type of encapsulation to be used.</li> </ul>
Step 6	<b>l2protocol tunnel</b> [ <i>protocol</i> ]  <b>Example:</b> Router(config-if-srv)# l2protocol tunnel cdp	Configures transparent Layer 2 protocol tunneling on the interface for the specified Layer 2 protocol. <ul style="list-style-type: none"> <li><i>protocol</i>—(Optional) The protocol to be used. The options are: <b>cdp</b>, <b>dtp</b>, <b>lACP</b>, <b>lldp</b>, <b>stp</b>, and <b>vtp</b>.</li> </ul>
Step 7	<b>bridge-domain</b> <i>bridge-id</i>  <b>Example:</b> Router(config-if-srv)# bridge-domain 9	Binds a service instance to a bridge domain instance. <ul style="list-style-type: none"> <li><i>bridge-id</i>—Identifier for the bridge domain instance.</li> </ul>

## Verifying Layer 2 Peering

To verify the layer 2 protocol peering functionality, use the **show ethernet service instance** command as shown below.

```
Router# show ethernet service instance id 99 interface gigabitEthernet0/4 detail

Service Instance ID: 99
Service Instance Type: static
Associated Interface: GigabitEthernet0/4
Associated EVC:
L2protocol peer cdp
CE-Vlans:
Encapsulation: untagged
Interface Dot1q Tunnel Ethertype: 0x8100
State: Up
EFP Statistics:
  Pkts In  Bytes In  Pkts Out  Bytes Out
      0      0      0          0
EFP Microblocks:
*****
Microblock type: Bridge-domain
Bridge-domain: 99
```

## Verifying Layer 2 Forwarding

To verify the layer 2 protocol forwarding functionality, use the **show ethernet service instance** command as shown below.

```
Router# show ethernet service instance id 99 interface gigabitEthernet 0/0 detail

Service Instance ID: 99
Service Instance Type: static
Associated Interface: GigabitEthernet0/0
Associated EVC:
L2protocol forward cdp lldp
CE-Vlans:
Encapsulation: untagged
Interface Dot1q Tunnel Ethertype: 0x8100
State: Up
EFP Statistics:
  Pkts In  Bytes In  Pkts Out  Bytes Out
      0      0      0          0
EFP Microblocks:
*****
Microblock type: Bridge-domain
Bridge-domain: 99
```

## Verifying Layer 2 Tunneling

To verify the layer 2 control protocol tunneling functionality, use the **show ethernet service instance** command as shown below.

```
Router# show ethernet service instance id 9 interface GigabitEthernet 0/4 detail

Service Instance ID: 9
Service Instance Type: static
```

```

Associated Interface: GigabitEthernet0/4
Associated EVC:
L2protocol tunnel
CE-Vlans:
Encapsulation: untagged
Interface Dot1q Tunnel Ethertype: 0x8100
State: Up
EFP Statistics:
Pkts In Bytes In Pkts Out Bytes Out
0 0 0 0
EFP Microblocks:
*****
Microblock type: Bridge-domain
Bridge-domain: 9

```

## Configuration Examples

This section provides sample configuration examples for Layer 2 Control Protocol Peering, Forwarding, and Tunneling feature on the Cisco ASR 901 Routers.

- [Example: Configuring Layer 2 Peering, page 35-10](#)
- [Example: Configuring Layer 2 Forwarding, page 35-10](#)
- [Example: Configuring Layer 2 Tunneling, page 35-11](#)

### Example: Configuring Layer 2 Peering

The following is a sample configuration of layer 2 peering.

```

!
interface GigabitEthernet0/0
negotiation auto
l2proto-forward tagged -- forwards all tagged frames, and drops untagged frames
cdp enable
service instance 9 ethernet
encapsulation dot1q 9
rewrite ingress tag pop 1 symmetric
bridge-domain 9
!
service instance 99 ethernet
encapsulation untagged
l2protocol peer cdp lldp -- peers lldp and cdp
bridge-domain 99
!
!

```

### Example: Configuring Layer 2 Forwarding

The following is a sample configuration of layer 2 protocol forwarding at untagged EFP.

```

Building configuration...

Current configuration : 267 bytes
!
interface Port-channel1

```

```

negotiation auto
!
service instance 9 ethernet
  encapsulation untagged
  l2protocol forward cdp
  bridge-domain 9
!
end

```

The following is a sample configuration of layer 2 protocol forwarding of tagged Bridge Protocol Data Units (BPDUs) at the port-channel interface level.

```

Current configuration : 270 bytes
!
interface Port-channel1
  no negotiation auto
  l2proto-forward tagged cdp
  service instance 9 ethernet
    encapsulation untagged
    bridge-domain 9
  !
  service instance 99 ethernet
    encapsulation dot1q 99
    rewrite ingress tag pop 1 symmetric
    bridge-domain 99
  !
end

```

## Example: Configuring Layer 2 Tunneling

The following is a sample configuration of layer 2 control protocol tunneling for untagged packets.

```

Building configuration...
Current configuration : 151 bytes
!
interface GigabitEthernet0/1
  negotiation auto
  service instance 10 ethernet
    encapsulation untagged
    l2protocol tunnel cdp
    bridge-domain 10
  !
  Service instance 100 ethernet
    encapsulation dot1q 100
    l2protocol tunnel lldp
    rewrite ingress tag pop 1 symmetric
    bridge-domain 100
  !
interface GigabitEthernet0/7
  negotiation auto
  service instance 20 ethernet
    encapsulation untagged
    l2protocol tunnel
    bridge-domain 20
  !
end

```

The following is a sample configuration of layer 2 control protocol tunneling for tagged packets.

**Note**

The configuration given below applies to only one router. Similar configuration has to be applied on two Cisco ASR 901 routers.

```
Building configuration...

Current configuration : 153 bytes
!
interface GigabitEthernet0/11
 negotiation auto
 service instance 10 ethernet
  encapsulation dot1q 100
  l2protocol tunnel
  bridge-domain 50
!
!
interface GigabitEthernet0/1
 negotiation auto
 service instance 10 ethernet
  encapsulation dot1q 100
  bridge-domain 50
!
end
```

The following is a sample configuration of layer 2 protocol tunneling for receiving untagged LLDP packets from customer nodes and tunneling them tagged over provider network.

**Router 1**

```
Building configuration...

Current configuration : 151 bytes
!
interface GigabitEthernet0/1
 negotiation auto
 service instance 10 ethernet
  encapsulation untagged
  l2protocol tunnel lldp
  bridge-domain 20
!
!
interface GigabitEthernet0/7
 negotiation auto
 service instance 10 ethernet
  encapsulation dot1q 100
  rewrite ingress tag pop 1 symmetric
  bridge-domain 20
!
end
```

**Router 2**

```
Current configuration : 170 bytes
!
interface GigabitEthernet0/7
 negotiation auto
 service instance 20 ethernet
  encapsulation dot1q 100
  rewrite ingress tag pop 1 symmetric
  bridge-domain 30
```



```
!  
!  
interface GigabitEthernet0/6  
 negotiation auto  
 service instance 20 ethernet  
  encapsulation untagged  
  l2protocol tunnel lldp  
  bridge-domain 30  
!  
end
```

## Additional References

The following sections provide references related to the Layer 2 Control Protocol Peering and Forwarding feature.

## Related Documents

Related Topic	Document Title
Cisco IOS Commands	Cisco IOS Master Commands List, All Releases
ASR 901 Commands	<a href="#">Cisco ASR 901 Series Aggregation Services Router Command Reference</a>
Cisco IOS Interface and Hardware Component Commands	<a href="#">Cisco IOS Interface and Hardware Component Command Reference</a>
Cisco IOS LAN Switching Commands	<a href="#">Cisco IOS LAN Switching Command Reference</a>

## Standards

Standard	Title
None	—

## MIBs

MIB	MIBs Link
None	To locate and download MIBs for selected platforms, Cisco IOS releases, and feature sets, use Cisco MIB Locator found at the following URL: <a href="http://www.cisco.com/go/mibs">http://www.cisco.com/go/mibs</a>

## RFCs

RFC	Title
None	—

## Technical Assistance

Description	Link
The Cisco Technical Support website contains thousands of pages of searchable technical content, including links to products, technologies, solutions, technical tips, and tools. Registered Cisco.com users can log in from this page to access even more content.	<a href="http://www.cisco.com/techsupport">http://www.cisco.com/techsupport</a>

# Feature Information for Layer 2 Control Protocol Peering, Forwarding, and Tunneling

Table 35-2 lists the features in this module and provides links to specific configuration information.

Use Cisco Feature Navigator to find information about platform support and software image support. Cisco Feature Navigator enables you to determine which software images support a specific software release, feature set, or platform. To access Cisco Feature Navigator, go to <http://www.cisco.com/go/cfn>. An account on Cisco.com is not required.



## Note

Table 35-2 lists only the software release that introduced support for a given feature in a given software release train. Unless noted otherwise, subsequent releases of that software release train also support that feature.

**Table 35-2** Feature Information for Layer 2 Control Protocol Peering, Forwarding, and Tunneling

Feature Name	Releases	Feature Information
Layer 2 Control Protocol Peering and Forwarding	15.2(2)SNG	<p>This feature was introduced on the Cisco ASR 901 routers. The following sections provide information about this feature:</p> <ul style="list-style-type: none"> <li>• <a href="#">Layer 2 Control Protocol Forwarding, page 35-2</a></li> <li>• <a href="#">Configuring Layer 2 Peering, page 35-4</a></li> <li>• <a href="#">Configuring Layer 2 Forwarding, page 35-5</a></li> </ul> <p>The following command was introduced: <b>l2proto-forward</b></p>
Layer 2 Control Protocol Tunneling	15.2(2)SNH1	<p>This feature was introduced on the Cisco ASR 901 routers. The following sections provide information about this feature:</p> <ul style="list-style-type: none"> <li>• <a href="#">Layer 2 Control Protocol Tunneling, page 35-2</a></li> <li>• <a href="#">Configuring Layer 2 Tunneling, page 35-7</a></li> </ul>





# Configuring Inverse Multiplexing over ATM

This feature module describes how to configure Inverse Multiplexing over ATM (IMA) to transport ATM traffic over a bundle of T1 or E1 cables. This feature enables the expansion of WAN bandwidth from T1 speeds, without DS3 or OC3 circuits.

## Finding Feature Information

Your software release may not support all the features documented in this module. For the latest feature information and caveats, see the release notes for your platform and software release. To find information about the features documented in this module, and to see a list of the releases in which each feature is supported, see the [“Feature Information for Inverse Multiplexing over ATM”](#) section on page 36-26.

Use Cisco Feature Navigator to find information about platform support and Cisco software image support. To access Cisco Feature Navigator, go to <http://www.cisco.com/go/cfn>. An account on Cisco.com is not required.

## Contents

- [Prerequisites, page 36-1](#)
- [Restrictions, page 36-2](#)
- [Feature Overview, page 36-2](#)
- [How to Configure IMA, page 36-2](#)
- [Configuring ATM IMA on T1/E1 Interface, page 36-3](#)
- [Configuring ATM IMA over MPLS, page 36-4](#)
- [How to Configure ATM Class of Service, page 36-11](#)
- [Configuring Marking MPLS Experimental Bits, page 36-17](#)
- [Additional References, page 36-25](#)
- [Feature Information for Inverse Multiplexing over ATM, page 36-26](#)

## Prerequisites

Before testing any IMA implementation, you should terminate the T1 circuits end-to-end.

## Restrictions

The following features are not supported:

- Native ATM interfaces
- IP Routing
- VPI or VCI rewrite
- 1:1 and N:1 (where  $N > 1$ ) VCC or VPP mode
- up and down traps
- ATM class of service (CBR, VBR-RT, VBR-nRT, UBR+, and UBR) for VPCs and port-mode
- Transmission of AIS on VCCs and VPCs to the customer-edge s, when the pseudowire goes down.
- Enabling atm cell payload scrambling for T1
- Disabling atm cell payload scrambling for E1

## Feature Overview

IMA involves inverse multiplexing and de-multiplexing of ATM cells in a cyclical fashion among physical links grouped to form a higher-bandwidth and logical link. Streams of cells are distributed in a round-robin manner across the multiple T1/E1 links and reassembled at the destination to form the original cell stream. Sequencing is provided using IMA Control Protocol (ICP) cells.

The following features are supported in this release:

- AAL0 and AAL5 encapsulation
- N:1 (where  $N \geq 1$ ) VPC and VCC cell relay mode
- Cell packing and Maximum Cell Packing Timeout (MCPT) timers
- Port mode
- AAL5 SDU frame encapsulation

## How to Configure IMA

This section describes how to configure IMA on E1/T1 interface and over MPLS:

- [Configuring ATM IMA on T1/E1 Interface, page 36-3](#)
- [Configuring ATM IMA over MPLS, page 36-4](#)
- [How to Configure ATM Class of Service, page 36-11](#)
- [Configuring Marking MPLS Experimental Bits, page 36-17](#)

# Configuring ATM IMA on T1/E1 Interface

To configure the ATM IMA on an E1 or T1 interface, complete the following steps:

## SUMMARY STEPS

1. **enable**
2. **configure terminal**
3. **card type {t1 | e1} slot port**
4. **controller {t1 | e1} slot/port**
5. **ima-group ima-group-number**
6. **exit**
7. **interface ATMslot-number/IMAima-group-number**
8. **no ip address**
9. **atm bandwidth dynamic**
10. **no atm ilmi-keepalive**

## DETAILED STEPS

	Command	Purpose
Step 1	<b>enable</b>  <b>Example:</b> Router> enable	Enables privileged EXEC mode. <ul style="list-style-type: none"> <li>• Enter your password if prompted.</li> </ul>
Step 2	<b>configure terminal</b>  <b>Example:</b> Router# configure terminal	Enters the global configuration mode.
Step 3	<b>card type {t1   e1} slot port</b>  <b>Example:</b> Router(config)# card type e1 0 0	Configures IMA on an E1 or T1 interface.
Step 4	<b>controller {t1   e1} slot/port</b>  <b>Example:</b> Router(config)# controller E1 0/4	Selects a T1 or E1 controller and enters controller configuration mode.
Step 5	<b>ima-group ima-group-number</b>  <b>Example:</b> Router(config-controller)# ima-group 0	Assigns the interface to an IMA group. This command creates the ATM0/IMAx interface by default.

	Command	Purpose
Step 6	<b>exit</b>  <b>Example:</b> Router(config-controller)# exit	Exits the controller interface.
Step 7	<b>interface ATMslot/IMAgroup-number</b>  <b>Example:</b> Router(config-if)# interface ATM0/IMA0	Specifies the slot location and port of IMA interface group. <ul style="list-style-type: none"> <li>• <i>slot</i>—Specifies the slot location of the ATM IMA port adapter.</li> <li>• <i>group-number</i>—Specifies the group number of the IMA group.</li> </ul>
Step 8	<b>no ip address</b>  <b>Example:</b> Router(config-if)# no ip address	Disables the IP address configuration for the physical layer interface.
Step 9	<b>atm bandwidth dynamic</b>  <b>Example:</b> Router(config-if)# atm bandwidth dynamic	Specifies the ATM bandwidth as dynamic.
Step 10	<b>no atm ilmi-keepalive</b>  <b>Example:</b> Router(config-if)# no atm ilmi-keepalive	Disables the Interim Local Management Interface (ILMI) keepalive parameters.

## Configuring ATM IMA over MPLS

This service allows the Cisco ASR 901 router to deliver ATM services over an existing MPLS network. The following sections describe how to configure transportation of service using ATM over MPLS:

- [Configuring the T1/E1 Controller, page 36-4](#)
- [Configuring an ATM IMA Interface, page 36-5](#)
- [Configuring ATM over MPLS Pseudowire Interface, page 36-6](#)
- [Verifying IMA Configurations, page 36-10](#)

## Configuring the T1/E1 Controller

Complete the following steps to configure an E1 or T1 controller:

### SUMMARY STEPS

1. **enable**
2. **configure terminal**
3. **card type {t1 | e1} slot port**
4. **controller {t1 | e1} slot/port**



5. **clock source internal**
6. **ima-group group-number**

## DETAILED STEPS

	Command	Purpose
Step 1	<b>enable</b>  <b>Example:</b> Router> enable	Enables privileged EXEC mode. <ul style="list-style-type: none"> <li>• Enter your password if prompted.</li> </ul>
Step 2	<b>configure terminal</b>  <b>Example:</b> Router# configure terminal	Enters the global configuration mode.
Step 3	<b>card type {t1   e1} slot port</b>  <b>Example:</b> Router(config)# card type e1 0 0	Configures the IMA on an E1 or T1 interface.
Step 4	<b>controller {t1   e1} slot/port</b>  <b>Example:</b> Router(config)# controller E1 0/4	Selects a T1 or E1 controller and enters controller configuration mode.
Step 5	<b>clock source internal</b>  <b>Example:</b> Router(config-controller)# clock source internal	Sets the clock source to internal.
Step 6	<b>ima-group group-number</b>  <b>Example:</b> Router(config-controller)# ima-group 0	Specifies the group number for the controller.

## Configuring an ATM IMA Interface

Complete the following steps to configure an ATM IMA interface:

### SUMMARY STEPS

1. **enable**
2. **configure terminal**
3. **controller {t1 | e1} slot/port**
4. **interface ATMslot/IMAgroup-number**
5. **no ip address**
6. **atm bandwidth dynamic**

## 7. no atm ilmi-keepalive

## DETAILED STEPS

	Command	Purpose
Step 1	<b>enable</b>  <b>Example:</b> Router> enable	Enables privileged EXEC mode. <ul style="list-style-type: none"> <li>Enter your password if prompted.</li> </ul>
Step 2	<b>configure terminal</b>  <b>Example:</b> Router# configure terminal	Enters the global configuration mode.
Step 3	<b>controller {t1   e1} slot/port</b>  <b>Example:</b> Router(config)# controller E1 0/4	Selects a T1 or E1 controller and enters controller configuration mode.
Step 4	<b>interface ATMslot/IMAgroup-number</b>  <b>Example:</b> Router(config-controller)# interface ATM0/IMA0	Specifies the slot location and port of IMA interface group. <ul style="list-style-type: none"> <li><i>slot</i>—Specifies the slot location of the ATM IMA port adapter.</li> <li><i>group-number</i>—Specifies the group number of the IMA group.</li> </ul>
Step 5	<b>no ip address</b>  <b>Example:</b> Router(config-if)# no ip address	Disables the IP address configuration for the physical layer interface.
Step 6	<b>atm bandwidth dynamic</b>  <b>Example:</b> Router(config-if)# atm bandwidth dynamic	Specifies the ATM bandwidth as dynamic.
Step 7	<b>no atm ilmi-keepalive</b>  <b>Example:</b> Router(config-if)# no atm ilmi-keepalive	Disables the ILMI keepalive parameters.

## Configuring ATM over MPLS Pseudowire Interface

You can configure ATM over MPLS in the following modes:

- [Configuring a Port Mode Pseudowire, page 36-7](#)
- [Configuring an N-to-1 VCC Cell Mode, page 36-7](#)
- [Configuring an N-to-1 vPC Cell Mode, page 36-8](#)
- [ATM AAL5 SDU VCC Transport, page 36-9](#)

## Configuring a Port Mode Pseudowire

A port mode pseudowire allows you to map an entire ATM interface to a single pseudowire connection. To configure, complete the following steps:

### SUMMARY STEPS

1. **enable**
2. **configure terminal**
3. **interface ATMslot/IMAgroup-number**
4. **xconnect ip-address port-number encapsulation mpls**

### DETAILED STEPS

	Command	Purpose
Step 1	<b>enable</b>  <b>Example:</b> Router> enable	Enables privileged EXEC mode. <ul style="list-style-type: none"> <li>• Enter your password if prompted.</li> </ul>
Step 2	<b>configure terminal</b>  <b>Example:</b> Router# configure terminal	Enters the global configuration mode.
Step 3	<b>interface ATMslot/IMAgroup-number</b>  <b>Example:</b> Router(config)# interface atm0/ima0	Specifies the slot location and port of IMA interface group and configures the ATM interface. <ul style="list-style-type: none"> <li>• <i>slot</i>—Specifies the slot location of the ATM IMA port adapter.</li> <li>• <i>group-number</i>—Specifies the group number of the IMA group.</li> </ul>
Step 4	<b>xconnect ip-address port-number encapsulation mpls</b>  <b>Example:</b> Router(config-if)# xconnect 10.10.10.10 20 encapsulation mpls	Binds an attachment circuit to the ATM IMA interface to create a pseudowire.

## Configuring an N-to-1 VCC Cell Mode

An N-to-1 Virtual Channel Connection (VCC) pseudowire allows you to map a ATM VCC to a pseudowire. You must use an ATM adaptation layer (AAL) encapsulation for this transport type. To configure, complete the following steps:

### SUMMARY STEPS

1. **enable**
2. **configure terminal**
3. **interface ATMslot/IMAgroup-number**
4. **pvc VPI/VCI l2transport**

5. **encapsulation** *encapsulation-type*
6. **xconnect** *ip-address port-number encapsulation mpls one-to-one*

## DETAILED STEPS

	Command	Purpose
Step 1	<b>enable</b>  <b>Example:</b> Router> enable	Enables privileged EXEC mode. <ul style="list-style-type: none"> <li>• Enter your password if prompted.</li> </ul>
Step 2	<b>configure terminal</b>  <b>Example:</b> Router# configure terminal	Enters the global configuration mode.
Step 3	<b>interface</b> <i>ATMslot/IMAgroup-number</i>  <b>Example:</b> Router(config)# interface ATM0/IMA0	Specifies the slot location and port of IMA interface group and configures the ATM interface. <ul style="list-style-type: none"> <li>• <i>slot</i>—Specifies the slot location of the ATM IMA port adapter.</li> <li>• <i>group-number</i>—Specifies the group number of the IMA group.</li> </ul>
Step 4	<b>pvc</b> <i>VPI/VCI l2transport</i>  <b>Example:</b> Router(config-if)# 100/12 l2transport	Specifies the Virtual Path Identifier (VPI) and Virtual Channel Identifier (VCI) of the Permanent Virtual Circuit (PVC) and configures them in layer 2 transport mode.
Step 5	<b>encapsulation</b> <i>encapsulation-type</i>  <b>Example:</b> Router(config-if-atm-l2trans-)# encapsulation aal0	Sets the encapsulation type to AAL0
Step 6	<b>xconnect</b> <i>ip-address port-number encapsulation mpls one-to-one</i>  <b>Example:</b> Router(config-if-atm-l2trans-)# xconnect 25.25.25.25 125 encapsulation mpls	Binds an attachment circuit to the ATM IMA interface to create a pseudowire.

## Configuring an N-to-1 vPC Cell Mode

An N-to-1 virtual port channel (vPC) pseudowire allows you to map one or more vPCs to a single pseudowire. You must use ATM Adaptation Layer (AAL) encapsulation for this transport type. To configure, complete the following steps:

### SUMMARY STEPS

1. **enable**
2. **configure terminal**
3. **interface** *ATMslot/IMAgroup-number*

4. **atm pvp VPI l2transport**
5. **xconnect ip-address port-number encapsulation mpls**

## DETAILED STEPS

	Command	Purpose
Step 1	<b>enable</b>  <b>Example:</b> Router> enable	Enables privileged EXEC mode. <ul style="list-style-type: none"> <li>• Enter your password if prompted.</li> </ul>
Step 2	<b>configure terminal</b>  <b>Example:</b> Router# configure terminal	Enters the global configuration mode.
Step 3	<b>interface ATMslot/IMAgroup-number</b>  <b>Example:</b> Router(config)# interface ATM0/IMA0	Specifies the slot location and port of IMA interface group and configures the ATM interface. <ul style="list-style-type: none"> <li>• <i>slot</i>—Specifies the slot location of the ATM IMA port adapter.</li> <li>• <i>group-number</i>—Specifies the group number of the IMA group.</li> </ul>
Step 4	<b>atm pvp VPI l2transport</b>  <b>Example:</b> Router(config-if)# atm pvp 10 l2transport	Specifies the VPI of the PVP and configures the PVP in L2transport mode.
Step 5	<b>xconnect ip-address port-number encapsulation mpls one-to-one</b>  <b>Example:</b> Router(config-if-atm-l2trans-pvp)# xconnect 30.30.30.2 305 encapsulation mpls	Binds an attachment circuit to the ATM IMA interface to create a pseudowire.

## ATM AAL5 SDU VCC Transport

An ATM AAL5 SDU VCC transport pseudowire maps a single ATM to another ATM. You must use AAL5 encapsulation for this transport type. Complete the following steps to configure an ATM AAL5 SDU VCC transport pseudowire:

### SUMMARY STEPS

1. **enable**
2. **configure terminal**
3. **interface ATMslot/IMAgroup-number**
4. **VPI/VCI l2transport**
5. **encapsulation encapsulation-type**
6. **xconnect ip-address port-number encapsulation mpls**

## DETAILED STEPS

	Command	Purpose
Step 1	<b>enable</b>  <b>Example:</b> Router> enable	Enables privileged EXEC mode. <ul style="list-style-type: none"> <li>Enter your password if prompted.</li> </ul>
Step 2	<b>configure terminal</b>  <b>Example:</b> Router# configure terminal	Enters the global configuration mode.
Step 3	<b>interface</b> <i>ATMslot/IMAgroup-number</i>  <b>Example:</b> Router(config)# interface ATM0/IMA0	Specifies the slot location and port of IMA interface group. <ul style="list-style-type: none"> <li><i>slot</i>—Specifies the slot location of the ATM IMA port adapter.</li> <li><i>group-number</i>—Specifies the group number of the IMA group.</li> </ul>
Step 4	<b>VPI/VCI l2transport</b>  <b>Example:</b> Router(config-if)# 100/12 l2transport	Specifies the VPI and VCI and configures them in layer 2 transport mode.
Step 5	<b>encapsulation</b> <i>encapsulation-type</i>  <b>Example:</b> Router(config-if-atm-l2trans-)# encapsulation aal5	Sets the encapsulation type to AAL5. AAL5 is the default l2transport encapsulation for the VCC mode.
Step 6	<b>xconnect</b> <i>ip-address port-number</i> <b>encapsulation mpls</b>  <b>Example:</b> Router(config-if-atm-l2trans-)# xconnect 25.25.25.25 125 encapsulation mpls	Binds an attachment circuit to the ATM IMA interface to create a pseudowire.

## Verifying IMA Configurations

To verify the IMA configurations, use the **show ima interface** command.

```
Router# show ima interface ATM0/IMA3

ATM0/IMA3 is up, ACTIVATION COMPLETE
Slot 0 Slot Unit 0 unit 3, CTRL VC -1, Vir -1, VC -1
IMA Configured BW 3022, Active BW 3022
IMA version 1.0, Frame length 64
Link Test: Disabled
Auto-Restart: Disabled
ImaGroupState: NearEnd = operational, FarEnd = operational
ImaGroupFailureStatus = noFailure
IMA Group Current Configuration:
ImaGroupMinNumTxLinks = 1 ImaGroupMinNumRxLinks = 1
ImaGroupDiffDelayMax = 200 ImaGroupNeTxClkMode = independent(itc)
ImaGroupFrameLength = 64 ImaTestProcStatus = disabled
```

```

ImaGroupTestLink = None ImaGroupTestPattern = 0xFF
ImaGroupConfLink = 2 ImaGroupActiveLink = 2
IMA Link Information:
ID Link Link State - Ctlr/Chan/Prot Test Status Scrambling
-----
0 T1 0/0 Up Up Up Up disabled Off
1 T1 0/1 Up Up Up Up disabled Off

```

## How to Configure ATM Class of Service

This section describes how to configure ATM class of services:

- [Configuring Constant Bit Rate, page 36-11](#)
- [Configuring Unspecified Bit Rate, page 36-12](#)
- [Configuring Unspecified Bit Rate Plus, page 36-13](#)
- [Configuring Variable Bit Rate for Real/Non-Real Time Traffic, page 36-14](#)
- [Configuration Examples, page 36-15](#)

### Configuring Constant Bit Rate

Complete the following steps to configure Constant Bit Rate (CBR) QoS class for an ATM PVC and to specify the bandwidth on the Cisco ASR 901 series router.

#### SUMMARY STEPS

1. **enable**
2. **configure terminal**
3. **interface ATMslot/IMAgroup-number**
4. **pvc VPI/VCI l2transport**
5. **cbr pcr**

#### DETAILED STEPS

	Command	Purpose
Step 1	<b>enable</b>  <b>Example:</b> Router> enable	Enables privileged EXEC mode. <ul style="list-style-type: none"> <li>• Enter your password if prompted.</li> </ul>
Step 2	<b>configure terminal</b>  <b>Example:</b> Router# configure terminal	Enters the global configuration mode.

	Command	Purpose
Step 3	<b>interface</b> <i>ATMslot/IMAgroup-number</i>  <b>Example:</b> Router(config)# interface ATM1/IMA0	Configures an ATM interface and enters the interface configuration mode.
Step 4	<b>pvc</b> <i>VPI/VCI l2transport</i>  <b>Example:</b> Router(config-if)# 100/12 l2transport	Specifies the VPI and VCI of the PVC and configures the PVC in layer 2 transport mode. <ul style="list-style-type: none"> <li>l2transport is an optional field.</li> </ul>
Step 5	<b>cbr</b> <i>rate</i>  <b>Example:</b> Router(config-if-atm-vc)# cbr 16000	Configures the constant bit rate (CBR) QoS class for an ATM permanent virtual circuit () and specifies the bandwidth. <ul style="list-style-type: none"> <li><i>rate</i>—Peak cell rate in Kbps.</li> </ul>

## Configuring Unspecified Bit Rate

Complete the following steps to configure Unspecified Bit Rate (UBR) QoS class for an ATM permanent virtual circuit () and to specify the bandwidth on the Cisco ASR 901 series router.

### SUMMARY STEPS

1. **enable**
2. **configure terminal**
3. **interface** *ATMslot/imagroup-number*
4. *VPI/VCI l2transport*
5. **ubr** *pcr*

### DETAILED STEPS

	Command	Purpose
Step 1	<b>enable</b>  <b>Example:</b> Router> enable	Enables privileged EXEC mode. <ul style="list-style-type: none"> <li>Enter your password if prompted.</li> </ul>
Step 2	<b>configure terminal</b>  <b>Example:</b> Router# configure terminal	Enters the global configuration mode.
Step 3	<b>interface</b> <i>ATMslot/IMAgroup-number</i>  <b>Example:</b> Router(config)# interface ATM1/IMA0	Configures an ATM interface and enters the interface configuration mode.



	Command	Purpose
<b>Step 4</b>	<p><b>pvc</b> <i>VPI/VCI</i> <b>l2transport</b></p> <p><b>Example:</b>  Router(config-if)# pvc 100/12  l2transport</p>	<p>Specifies the VPI and VCI of the PVC and configures the PVC in layer 2 transport mode.</p> <ul style="list-style-type: none"> <li>l2transport is an optional field.</li> </ul>
<b>Step 5</b>	<p><b>ubr</b> <i>rate</i></p> <p><b>Example:</b>  Router(config-if-atm-vc)# ubr 16000</p>	<p>Configures the UBR QoS class for an ATM permanent virtual circuit (PVC) and specifies the bandwidth. By default a value is set to UBR ATM class of service with the rate equal to the bandwidth of the IMA interface, which in turn is a product of the number of active IMA links and the bandwidth of each link.</p> <ul style="list-style-type: none"> <li><i>rate</i>—Peak cell rate in Kbps.</li> </ul>

## Configuring Unspecified Bit Rate Plus

Complete the following steps to configure Unspecified Bit Rate Plus (UBR+) QoS class for an ATM permanent virtual circuit () and to specify the bandwidth on the Cisco ASR 901 series router.

### SUMMARY STEPS

1. **enable**
2. **configure terminal**
3. **interface** *ATMslot/imagroup-number*
4. **pvc** *VPI/VCI* **l2transport**
5. **ubr+** *pcr-rate mcr-rate*

### DETAILED STEPS

	Command	Purpose
<b>Step 1</b>	<p><b>enable</b></p> <p><b>Example:</b>  Router&gt; enable</p>	<p>Enables privileged EXEC mode.</p> <ul style="list-style-type: none"> <li>Enter your password if prompted.</li> </ul>
<b>Step 2</b>	<p><b>configure terminal</b></p> <p><b>Example:</b>  Router# configure terminal</p>	<p>Enters the global configuration mode.</p>
<b>Step 3</b>	<p><b>interface</b> <i>ATMslot/IMAgroup-number</i></p> <p><b>Example:</b>  Router(config)# interface ATM1/IMA0</p>	<p>Configures an ATM interface and enters the interface configuration mode.</p>

	Command	Purpose
<b>Step 4</b>	<b>pvc</b> <i>VPI/VCI</i> <b>l2transport</b>  <b>Example:</b> Router(config-if)# pvc 100/12 l2transport	Specifies the VPI and VCI of the PVC and configures the PVC in layer 2 transport mode. <ul style="list-style-type: none"> <li>l2transport is an optional field.</li> </ul>
<b>Step 5</b>	<b>ubr+</b> <i>pcr-rate</i> <i>mcr-rate</i>  <b>Example:</b> Router(config-if-atm-vc)# ubr+ 16000 2000	Configures the UBR+ QoS class for an ATM permanent virtual circuit () and specifies the bandwidth. <ul style="list-style-type: none"> <li><i>pcr-rate</i>—Peak cell rate in Kbps.</li> <li><i>mcr-rate</i>—Peak cell rate in Mbps</li> </ul>

## Configuring Variable Bit Rate for Real/Non-Real Time Traffic

Complete the following steps to configure the real/non-real time Variable Bit Rate for VoATM voice connections for an ATM on the Cisco ASR901 series router.

### SUMMARY STEPS

1. **enable**
2. **configure terminal**
3. **interface** *ATMslot/imagroup-number*
4. *VPI/VCI* **l2transport**
5. **vbr-rt** *peak-rate average-rate burst* or **vbr-nrt** *peak-rate average-rate burst*

### DETAILED STEPS

	Command	Purpose
<b>Step 1</b>	<b>enable</b>  <b>Example:</b> Router> enable	Enables privileged EXEC mode. <ul style="list-style-type: none"> <li>Enter your password if prompted.</li> </ul>
<b>Step 2</b>	<b>configure terminal</b>  <b>Example:</b> Router# configure terminal	Enters the global configuration mode.
<b>Step 3</b>	<b>interface</b> <i>ATMslot/IMAgroup-number</i>  <b>Example:</b> Router(config)# interface ATM1/IMA0	Configures an ATM interface and enters the interface configuration mode.

	Command	Purpose
<b>Step 4</b>	<p><b>pvc</b> <i>VPI/VCI</i> <b>l2transport</b></p> <p><b>Example:</b>  Router(config-if)# pvc 100/12  l2transport</p>	<p>Specifies the VPI and VCI of the PVC and configures the PVC in layer 2 transport mode.</p> <ul style="list-style-type: none"> <li>• l2transport is an optional field.</li> </ul>
<b>Step 5</b>	<p><b>vbr-rt</b> <i>peak-rate average-rate burst</i></p> <p>or</p> <p><b>vbr-nrt</b> <i>peak-rate average-rate burst</i></p> <p><b>Example:</b>  Router(config-if-atm-vc)# vbr-rt 600  300 37  or  Router(config-if-atm-vc)# vbr-nrt 600  300 37</p>	<p>Configures the real-time VBR for VoATM voice connections for an ATM in virtual circuit configuration mode.</p> <p>Configures the non-real time VBR for VoATM voice connections for an ATM in virtual circuit configuration mode.</p> <ul style="list-style-type: none"> <li>• <i>peak-rate</i>—Peak cell rate in Kbps.</li> <li>• <i>average-rate</i>—Average cell rate in Kbps.</li> <li>• <i>burst</i>—Burst cell size in number of cells. Minimum cell size is 37.</li> </ul>

## Configuration Examples

This section provides sample configuration examples for IMA on the Cisco ASR 901 Router:

### Example: Creating an IMA Interface

The following is a sample configuration to create an IMA interface with T1 controller.

```
!
controller t1 0/0
  ima-group 0
exit
```

The following is a sample configuration to create an IMA interface with E1 controller.

```
controller e1 0/0
  ima-group 0
exit
!
```

### Example: Configuring a Port Mode Pseudowire

The following is a sample configuration of a port mode pseudowire.

```
!
interface ATM0/IMA2
  no ip address
  xconnect 10.10.10.10 20 encapsulation mpls
!
```

## Example: Configuring an N-to-1 VCC Cell Mode

The following is a sample configuration of N-to-1 VCC cell mode:

```
!
interface ATM0/IMA0
  no ip address
  atm mcpt-timers 500 600 700
  no atm enable-ilmi-trap
  100/100 l2transport
  cell-packing 10 mcpt-timer 2
  encapsulation aal0
  xconnect 25.25.25.25 125 encapsulation mpls
!
```

The following is a sample configuration for AAL5 SDU mode:

```
!
interface ATM0/IMA0
  no ip address
  no atm enable-ilmi-trap
  100/100 l2transport
  encapsulation aal5
  xconnect 25.25.25.25 125 encapsulation mpls
!
```

## Example: Configuring an N-to-1 VPC Cell Mode

The following is a sample configuration of N-to-1 Permanent Virtual Circuit (VPC) cell mode.

```
!
interface ATM0/IMA0
  no ip address
  atm pvp 12 l2transport
  xconnect 30.30.30.30 30 encapsulation mpls
!
```

## Example: Configuring CBR

The following is a sample configuration of constant bit rate.

```
!
interface atm0/ima0
  1/200 l2transport
  cbr 16000
!
```

## Example: Configuring UBR

The following is a sample configuration of constant bit rate.

```
!
interface atm0/ima0
  1/200 l2transport
  ubr 16000
!
```

### Example: Configuring UBR Plus

```
!  
interface atm0/ima0  
    1/200 l2transport  
   ubr+ 16000 2000  
!
```

### Example: Configuring VBR for Real Time Traffic

```
!  
interface atm0/ima0  
    1/200 l2transport  
    vbr-rt 10000 5000 37  
!
```

### Example: Configuring VBR for Non-Real Time Traffic

```
!  
interface atm0/ima0  
    1/200 l2transport  
    vbr-nrt 10000 5000 50  
!
```

## Configuring Marking MPLS Experimental Bits

You can configure MPLS through the following procedures:

- [Creating a Policy-map for PVP/PVC/ATM IMA Interface, page 36-17](#)
- [Applying the Policy-map, page 36-18](#)
- [Creating a Table-map, page 36-21](#)
- [Creating a Policy-map for SVI Interface, page 36-22](#)
- [Applying a Service Policy on SVI Interface, page 36-23](#)

## Creating a Policy-map for PVP/PVC/ATM IMA Interface

To configure a policy map, complete the following steps:

### SUMMARY STEPS

1. **enable**
2. **configure terminal**
3. **policy-map** *map-name*
4. **class** *class-name*
5. **set** *qos-group-name*

## DETAILED STEPS

	Command	Purpose
Step 1	<b>enable</b>  <b>Example:</b> Router> enable	Enables privileged EXEC mode. <ul style="list-style-type: none"> <li>Enter your password if prompted.</li> </ul>
Step 2	<b>configure terminal</b>  <b>Example:</b> Router# configure terminal	Enters the global configuration mode.
Step 3	<b>policy-map</b> <i>policy-map-name</i>  <b>Example:</b> Router(config)# policy-map mark_qosgroup	Specifies a name for the policy map.
Step 4	<b>class</b> <i>class-name</i>  <b>Example:</b> Router(config-if)# class class-default	Specifies a name for the class associated with the policy map.
Step 5	<b>set qos-group</b> <i>qos-group-number</i>  <b>Example:</b> Router(config-if)# set qos-group 2	Sets a group to the policy map.

## Applying the Policy-map

You can apply a policy map on the following interfaces:

- [Applying a Policy map on PVC and PVP, page 36-18](#)
- [Applying a Policy map on ATM IMA Interface, page 36-20](#)

## Applying a Policy map on PVC and PVP

To apply a policy map on PVC and PVP, complete the following steps:

## SUMMARY STEPS

1. **enable**
2. **configure terminal**
3. **interface** *ATMslot/IMAgroup-number*
4. **no ip address**
5. **no atm enable-ilmi-trap**
6. **pvc** *VPI/VCI l2transport*
7. **encapsulation** *encapsulation-type*

8. **service-policy input** *policy-map-name*
9. **xconnect** *ip-address port-number encapsulation mpls*
10. **atm pvp VPI l2transport**
11. **service-policy input** *policy-map-name*
12. **xconnect** *ip-address port-number encapsulation mpls*

## DETAILED STEPS

	Command	Purpose
Step 1	<b>enable</b>  <b>Example:</b> Router> enable	Enables privileged EXEC mode. <ul style="list-style-type: none"> <li>Enter your password if prompted.</li> </ul>
Step 2	<b>configure terminal</b>  <b>Example:</b> Router# configure terminal	Enters the global configuration mode.
Step 3	<b>interface</b> <i>ATMslot/IMAgroup-number</i>  <b>Example:</b> Router(config)# interface atm0/ima0	Specifies the slot location and port of IMA interface group and configures the ATM interface. <ul style="list-style-type: none"> <li><i>slot</i>—Specifies the slot location of the ATM IMA port adapter.</li> <li><i>group-number</i>—Specifies the group number of the IMA group.</li> </ul>
Step 4	<b>no ip address</b>  <b>Example:</b> Router(config-if)# no ip address	Disables the IP address configuration for the physical layer interface.
Step 5	<b>no atm enable-ilmi-trap</b>  <b>Example:</b> Router(config-if)# no atm enable-ilmi-trap	Disables the ILMI trap parameters.
Step 6	<b>pvc</b> <i>VPI/VCI l2transport</i>  <b>Example:</b> Router(config-if)# pvc 100/100 l2transport	Specifies the VPI and VCI of the PVC and configures the PVC in layer 2 transport mode.
Step 7	<b>encapsulation</b> <i>encapsulation-type</i>  <b>Example:</b> Router(config-if)# encapsulation aal0	Sets the PVC encapsulation type to AAL0.
Step 8	<b>service-policy input</b> <i>policy-map-name</i>  <b>Example:</b> Router(config-if)# service-policy input mark_qosgroup	Attaches a policy map to the input interface.

	Command	Purpose
Step 9	<b>xconnect</b> <i>ip-address port-number</i> <b>encapsulation mpls</b>  <b>Example:</b> Router(config-if)# xconnect 25.25.25.25 125 encapsulation mpls	Binds an attachment circuit to the ATM IMA PVC to create a pseudowire.
Step 10	<b>atm pvp</b> <i>VPI l2transport</i>  <b>Example:</b> Router(config-if)# atm pvp 200 l2transport	Specifies the VPI of the PVP and configures the PVP in layer 2 transport mode.
Step 11	<b>service-policy input</b> <i>policy-map-name</i>  <b>Example:</b> Router(config-if)# service-policy input mark_qosgroup	Attaches a policy map to the input interface.
Step 12	<b>xconnect</b> <i>ip-address port-number</i> <b>encapsulation mpls</b>  <b>Example:</b> Router(config-if)# xconnect 25.25.25.25 126 encapsulation mpls	Binds an attachment circuit to the ATM IMA PVP to create a pseudowire.

## Applying a Policy map on ATM IMA Interface

To apply a policy map on ATM IMA interface, complete the following steps:

### SUMMARY STEPS

1. **enable**
2. **configure terminal**
3. **interface** *ATMslot/IMAgroup-number*
4. **no ip address**
5. **no atm enable-ilmi-trap**
6. **service-policy input** *policy-map-name*
7. **xconnect** *ip-address port-number encapsulation mpls*



## DETAILED STEPS

	Command	Purpose
Step 1	<b>enable</b>  <b>Example:</b> Router> enable	Enables privileged EXEC mode. <ul style="list-style-type: none"> <li>Enter your password if prompted.</li> </ul>
Step 2	<b>configure terminal</b>  <b>Example:</b> Router# configure terminal	Enters the global configuration mode.
Step 3	<b>interface ATMslot/IMAgroup-number</b>  <b>Example:</b> Router(config)# interface atm0/ima0	Specifies the slot location and port of IMA interface group and configures the ATM interface. <ul style="list-style-type: none"> <li><i>slot</i>—Specifies the slot location of the ATM IMA port adapter.</li> <li><i>group-number</i>—Specifies the group number of the IMA group.</li> </ul>
Step 4	<b>no ip address</b>  <b>Example:</b> Router(config-if)# no ip address	Disables the IP address configuration for the physical layer interface.
Step 5	<b>no atm enable-ilmi-trap</b>  <b>Example:</b> Router(config-if)# no atm enable-ilmi-trap	Disables the ILMI trap parameters.
Step 6	<b>service-policy input policy-map-name</b>  <b>Example:</b> Router(config-if)# service-policy input mark_qosgroup	Attaches a policy map to the input interface.
Step 7	<b>xconnect ip-address port-number encapsulation mpls</b>  <b>Example:</b> Router(config-if)# xconnect 25.25.25.25 125 encapsulation mpls	Binds an attachment circuit to the ATM IMA interface to create a pseudowire.

## Creating a Table-map

To create a table map for mapping QoS group to MPLS experimental bit, complete the following steps:

## SUMMARY STEPS

1. **enable**
2. **configure terminal**
3. **table-map table-map-name**

4. **map from** *from-value* **to** *to-value*
5. **default copy**

## DETAILED STEPS

	Command	Purpose
Step 1	<b>enable</b>  <b>Example:</b> Router> enable	Enables privileged EXEC mode. <ul style="list-style-type: none"> <li>• Enter your password if prompted.</li> </ul>
Step 2	<b>configure terminal</b>  <b>Example:</b> Router# configure terminal	Enters the global configuration mode.
Step 3	<b>table-map</b> <i>table-name</i>  <b>Example:</b> Router(config)# table-map qos_exp_table	Creates a table map with the specified name.
Step 4	<b>map from</b> <i>from-value</i> <b>to</b> <i>to-value</i>  <b>Example:</b> Router(config-if)# map from 1 to 2	Maps the values associated with the policy map.

## Creating a Policy-map for SVI Interface

To create a policy-map, complete the following steps:

### SUMMARY STEPS

1. **enable**
2. **configure terminal**
3. **policy-map** *map-name*
4. **class** *class-name*
5. **set mpls experimental topmost qos-group table** *table-map-name*

## DETAILED STEPS

	Command	Purpose
Step 1	<b>enable</b>  <b>Example:</b> Router> enable	Enables privileged EXEC mode. <ul style="list-style-type: none"> <li>Enter your password if prompted.</li> </ul>
Step 2	<b>configure terminal</b>  <b>Example:</b> Router# configure terminal	Enters the global configuration mode.
Step 3	<b>policy-map</b> <i>map-name</i>  <b>Example:</b> Router(config)# policy-map pmap_qos_exp	Specifies the name of the existing policy map.
Step 4	<b>class class-default</b>  <b>Example:</b> Router(config)# class class-default	Specifies the name of the class associated with the policy map.
Step 5	<b>set mpls experimental topmost qos-group table</b> <i>table-map-name</i>  <b>Example:</b> Router(config-if)# set mpls experimental topmost qos-group table qos_exp_table	Copies the MPLS EXP value in the incoming MPLS traffic to the Qos group table.

## Applying a Service Policy on SVI Interface

To apply a service policy on SVI interface, complete the following steps:

## SUMMARY STEPS

- enable**
- configure terminal**
- interface** *interface-type*
- mtu** *mtu-id*
- ip address** *source-ip-address destination-ip-address*
- mpls ip**
- service-policy output** *policy-map-name*

## DETAILED STEPS

	Command	Purpose
Step 1	<b>enable</b>  <b>Example:</b> Router> enable	Enables privileged EXEC mode. <ul style="list-style-type: none"> <li>Enter your password if prompted.</li> </ul>
Step 2	<b>configure terminal</b>  <b>Example:</b> Router# configure terminal	Enters the global configuration mode.
Step 3	<b>interface</b> <i>interface-type</i>  <b>Example:</b> Router(config)# interface vlan10	Specifies the interface type and enters the interface configuration mode.
Step 4	<b>mtu</b> <i>bytes</i>  <b>Example:</b> Router(config-if)# mtu 9216	Configures the IP maximum transmission unit (MTU) size for the tunnel. <ul style="list-style-type: none"> <li><i>bytes</i>—The range is from 1500 to 9216. The default is 1500.</li> </ul>
Step 5	<b>ip address</b> <i>ip-address subnet-mask</i>  <b>Example:</b> Router(config-if)# ip address 9.0.54.9 255.255.255.0	Configures an IP address and subnet mask on the interface.
Step 6	<b>mpls ip</b>  <b>Example:</b> Router(config-if)# mpls ip	Enables MPLS forwarding of IPv4 packets along normally routed paths for the interface.
Step 7	<b>service-policy output</b> <i>policy-map-name</i>  <b>Example:</b> Router(config-if)# service-policy output pmap_qos_exp	Attaches the specified policy map to the output interface.

# Additional References

The following sections provide references related to inverse multiplexing over ATM.

## Related Documents

Related Topic	Document Title
Cisco IOS Commands	<i>Cisco IOS Master Commands List, All Releases</i>
ASR 901 Command Reference	<i>Cisco ASR 901 Series Aggregation Services Router Command Reference</i>
Cisco IOS Interface and Hardware Component Commands	<i>Cisco IOS Interface and Hardware Component Command Reference</i>

## Standards

Standard	Title
None	—

## MIBs

MIB	MIBs Link
IMA-MIB	To locate and download MIBs for selected platforms, Cisco IOS releases, and feature sets, use Cisco MIB Locator found at the following URL: <a href="http://www.cisco.com/go/mibs">http://www.cisco.com/go/mibs</a>

## RFCs

RFC	Title
None	—

## Technical Assistance

Description	Link
The Cisco Technical Support website contains thousands of pages of searchable technical content, including links to products, technologies, solutions, technical tips, and tools. Registered Cisco.com users can log in from this page to access even more content.	<a href="http://www.cisco.com/techsupport">http://www.cisco.com/techsupport</a>

## Feature Information for Inverse Multiplexing over ATM

Table 36-1 lists the features in this module and provides links to specific configuration information.

Use Cisco Feature Navigator to find information about platform support and software image support. Cisco Feature Navigator enables you to determine which software images support a specific software release, feature set, or platform. To access Cisco Feature Navigator, go to <http://www.cisco.com/go/cfn>. An account on Cisco.com is not required.

**Note**

Table 36-1 lists only the software release that introduced support for a given feature in a given software release train. Unless noted otherwise, subsequent releases of that software release train also support that feature.

**Table 36-1** Feature Information for Inverse Multiplexing over ATM

Feature Name	Releases	Feature Information
Inverse Multiplexing over ATM	15.2(2)SNH1	<p>This feature was introduced. See the following links for more information about this feature:</p> <ul style="list-style-type: none"> <li>• <a href="#">How to Configure IMA</a></li> <li>• <a href="#">Configuring ATM IMA on T1/E1 Interface</a></li> <li>• <a href="#">Configuring ATM IMA over MPLS</a></li> <li>• <a href="#">How to Configure ATM Class of Service</a></li> <li>• <a href="#">Configuring Marking MPLS Experimental Bits</a></li> </ul>



## IPv6 over MPLS: 6PE and 6VPE

---

This feature module describes how to implement IPv6 VPN Provider Edge Transport over MPLS (IPv6 on Provider Edge Routers [6PE] and IPv6 on VPN Provider Edge Routers [6VPE]) on the Cisco ASR 901 Series Aggregation Services Routers.

### Finding Feature Information

Your software release may not support all the features documented in this module. For the latest feature information and caveats, see the release notes for your platform and software release. To find information about the features documented in this module, and to see a list of the releases in which each feature is supported, see the [“Feature Information for IPv6 over MPLS: 6PE and 6VPE”](#) section on page 37-21.

Use Cisco Feature Navigator to find information about platform support and Cisco software image support. To access Cisco Feature Navigator, go to <http://www.cisco.com/go/cfn>. An account on Cisco.com is not required.

### Contents

- [Prerequisites, page 37-2](#)
- [Restrictions, page 37-2](#)
- [Feature Overview, page 37-2](#)
- [How to Configure IPv6 over MPLS: 6PE and 6VPE, page 37-6](#)
- [Configuration Examples, page 37-18](#)
- [Additional References, page 37-20](#)
- [Feature Information for IPv6 over MPLS: 6PE and 6VPE, page 37-21](#)

## Prerequisites

- Cisco IOS Release 15.2(2)SNI or a later release that supports the IPv6 over MPLS: 6PE and 6VPE feature must be installed previously on the Cisco ASR 901 Series Aggregation Services Router.
- Multiprotocol Label Switching (MPLS) in provider backbone devices.
- MPLS with Virtual Private Network (VPN) code in provider devices with VPN provider edge (PE) devices.
- Border Gateway Protocol (BGP) in all devices providing a VPN service.
- Cisco Express Forwarding switching in every MPLS-enabled device.

## Restrictions

The following restrictions are applicable for the IPv6 over MPLS: 6PE and 6VPE feature on the Cisco IOS Release 15.2(2)SNI.

- All the existing MPLS and IPv6 restrictions are applicable, as the base infrastructure of IPv6 and IPv4 MPLS remains the same.
- 6PE and 6VPE is supported only on the SVI interfaces.
- The number of global VRFs supported is the same as that of IPv4, as both the IPv4 and IPv6 VPN Routing and Forwarding (VRF) share the resources from the global VRF pool.
- The number of IPv6 VRFs supported is restricted to 113, though the maximum number of configurable VRFs are 127.
- For the single label per prefix mode allocation, the 6PE and 6VPE scale is limited by the number of labels available in the box (4000 labels).
- Supports only static routes and BGP for IPv6 in VRF context.

## Feature Overview

The IPv6 over MPLS: 6PE and 6VPE feature enables the service providers running an MPLS/IPv4 infrastructure to offer IPv6 services without any major changes in the infrastructure. This feature offers the following options to the service providers:

- Connect to other IPv6 networks accessible across the MPLS core
- Provide access to IPv6 services and resources that service provider provides
- Provide IPv6 VPN services without going for complete overhaul of existing MPLS/IPv4 core

6PE and 6VPE uses the existing MPLS/IPv4 core infrastructure for IPv6 transport. It enables IPv6 sites to communicate with each other over an MPLS/IPv4 core network using MPLS label switched paths (LSPs).

This feature relies heavily on multiprotocol Border Gateway Protocol (BGP) extensions in the IPv4 network configuration on the provider edge (PE) router to exchange IPv6 reachability information (in addition to an MPLS label) for each IPv6 address prefix. Edge routers are configured as dual-stack, running both IPv4 and IPv6, and use the IPv4 mapped IPv6 address for IPv6 prefix reachability exchange.



## Benefits of 6PE and 6VPE

6PE and 6VPE offers the following benefits to service providers:

- Minimal operational cost and risk—No impact on existing IPv4 and MPLS services.
- Only provider edge routers require upgrade—A 6PE and 6VPE router can be an existing PE router or a new one dedicated to IPv6 traffic.
- No impact on IPv6 customer edge (CE) routers—The ISP can connect to any CE router running Static, IGP or EGP.
- Production services ready—An ISP can delegate IPv6 prefixes.
- IPv6 introduction into an existing MPLS service—6PE and 6VPE routers can be added at any time.

## IPv6 on Provider Edge Routers

6PE is a technique that provides global IPv6 reachability over IPv4 MPLS. It allows one shared routing table for all other devices. 6PE allows IPv6 domains to communicate with one another over the IPv4 without an explicit tunnel setup, requiring only one IPv4 address per IPv6 domain.

While implementing 6PE, the provider edge routers are upgraded to support 6PE, while the rest of the core network is not touched (IPv6 unaware). This implementation requires no reconfiguration of core routers because forwarding is based on labels rather than on the IP header itself. This provides a cost-effective strategy for deploying IPv6. The IPv6 reachability information is exchanged by PE routers using multiprotocol Border Gateway Protocol (mp-iBGP) extensions.

6PE relies on mp-iBGP extensions in the IPv4 network configuration on the PE router to exchange IPv6 reachability information in addition to an MPLS label for each IPv6 address prefix to be advertised. PE routers are configured as dual stacks, running both IPv4 and IPv6, and use the IPv4 mapped IPv6 address for IPv6 prefix reachability exchange. The next hop advertised by the PE router for 6PE and 6VPE prefixes is still the IPv4 address that is used for IPv4 L3 VPN routes. A value of ::FFFF: is prepended to the IPv4 next hop, which is an IPv4-mapped IPv6 address.

Figure 37-1 illustrates a 6PE topology.

**Figure 37-1 6PE Topology**

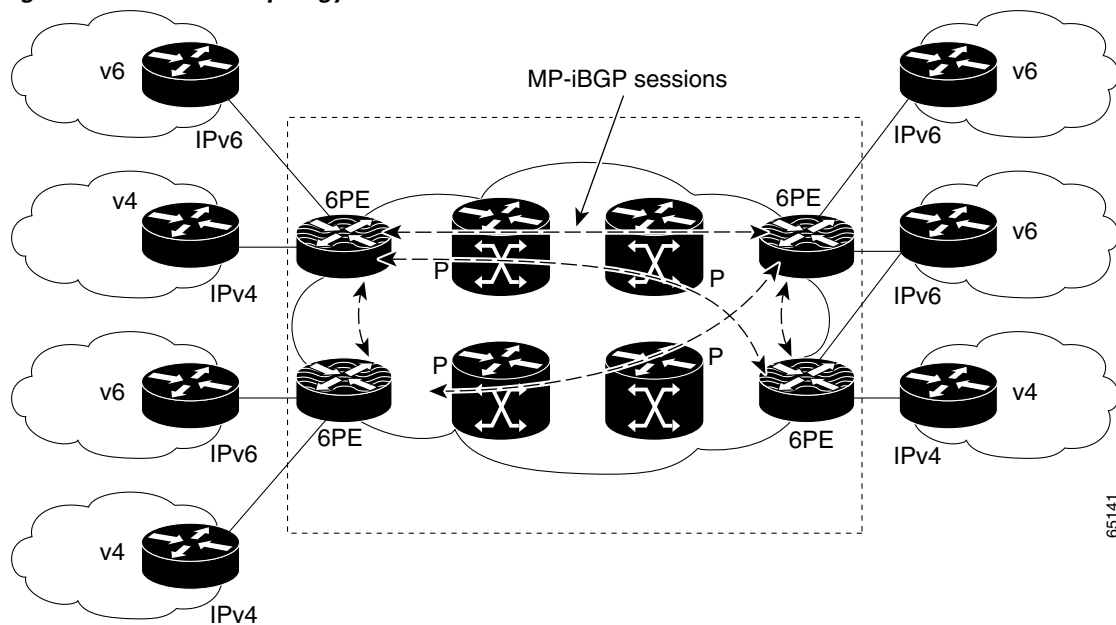

<b>V6</b>	IPv6 router on the customer premises	<b>6PE</b>	PE equipment, connected to CEs and entry points to the MPLS clouds, running a dual stack IPv6/IPv4 (IPv6 to communicate with CEs)
<b>V4</b>	IPv4 router on the customer premises	<b>P</b>	Provider routers, core of the MPLS backbone running MPLS and IPv4 stack

## IPv6 on VPN Provider Edge Routers

6VPE is a mechanism to use the IPv4 backbone to provide VPN IPv6 services. It takes advantage of operational IPv4 MPLS backbones, eliminating the need for dual-stacking within the MPLS core. This translates to savings in operational costs and addresses the security limitations of the 6PE approach. 6VPE is more like a regular IPv4 MPLS-VPN provider edge, with an addition of IPv6 support within VRF. It provides logically separate routing table entries for VPN member devices.

## Components of MPLS-based 6VPE Network

- VPN route target communities – A list of all other members of a VPN community.
- Multiprotocol BGP (MP-BGP) peering of VPN community PE routers – Propagates VRF reachability information to all members of a VPN community.
- MPLS forwarding – Transports all traffic between all VPN community members across a VPN service-provider network.

In the MPLS-VPN model a VPN is defined as a collection of sites sharing a common routing table. A customer site is connected to the service provider network by one or more interfaces, where the service provider associates each interface with a VPN routing table—known as the VRF table.

Figure 37-2 illustrates an MPLS VPN network.

**Figure 37-2 MPLS VPN Network**

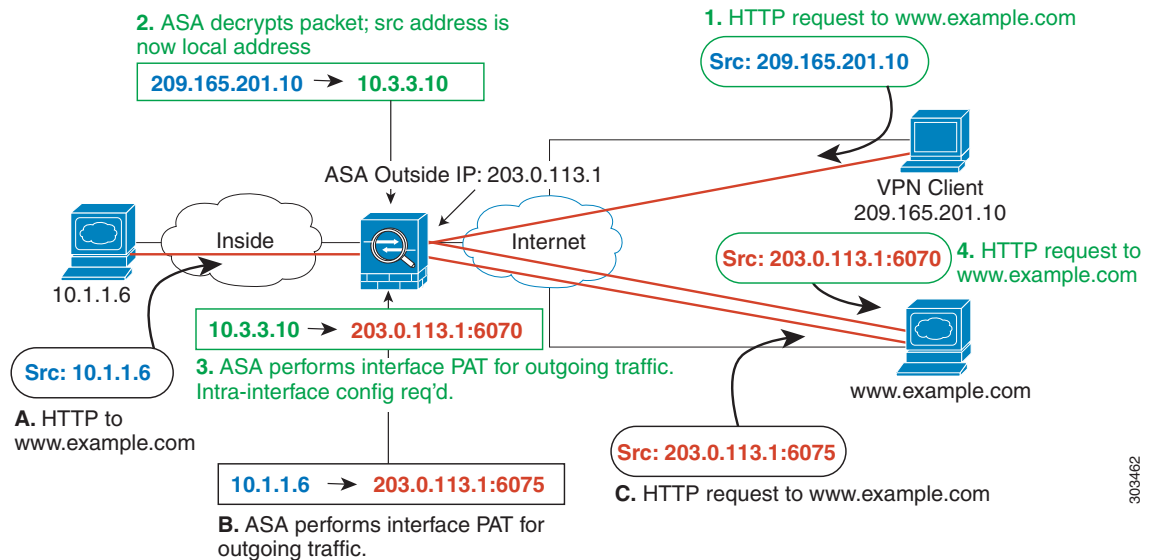

For more conceptual information on 6PE and 6VPE, see the *IPv6 VPN over MPLS* guide in the [MPLS: Layer 3 VPNs Configuration Guide](#).

## Supported Features

The following 6PE and 6VPE features are supported on the Cisco ASR 901 router effective with Cisco IOS Release 15.2(2) SNI:

- IPv6 VRF support – Enabled for supporting 6VPE
- MPLS VPN 6VPE and 6PE – Provides IPV6 reachability for IPv6 edge routers across an MPLS network backbone running an IPv4 control plane, without making changes to the software on the MPLS P routers.
- 6VPE and 6PE with QoS – Supports QoS provisioning in 6PE and 6VPE networks by using existing QoS infrastructure and configuration.
- MPLS VPN - VRF command for IPv4 and IPv6 VPN – Supports commands that allows users to enable IPv4 and IPv6 in the same VRF.



### Note

All the above features are built upon existing IPv4, IPv6, MPLS and BGP infrastructure in the IOS and Cisco ASR 901 data plane support.

# Scalability Numbers

Table 37-1 shows the scalability numbers for the 6PE and 6VPE feature.

**Table 37-1 Scalability Numbers for 6PE and 6VPE**

Interface	Numbers
Number of VRFs	113
Number of VPNv6 prefixes per VRF	About 4000 <sup>1</sup>
Number of VPNv6 prefixes	About 4000 <sup>37-1</sup>
Number of global IPv6 prefixes	About 4000 <sup>37-1</sup>

1. This number is limited by the MPLS label usage on the PE router. The maximum number of label space shared between IPv4 and IPv6 is 4000.

## How to Configure IPv6 over MPLS: 6PE and 6VPE

This section describes how to configure IPv6 over MPLS: 6PE and 6VPE feature:

- [Configuring 6PE, page 37-6](#) (Required)
- [Configuring 6VPE, page 37-9](#) (Required)
- [Verifying IPv6 over MPLS: 6PE and 6VPE Configuration, page 37-15](#) (Optional)

## Configuring 6PE

Ensure that you configure 6PE on PE routers participating in both the IPv4 cloud and IPv6 clouds. To learn routes from both clouds, you can use any routing protocol supported on IOS (BGP, OSPF, IS-IS, EIGRP, Static).

BGP running on a PE router should establish (IPv4) neighborhood with BGP running on other PEs. Subsequently, it should advertise the IPv6 prefixes learnt from the IPv6 table to the neighbors. The IPv6 prefixes advertised by BGP would automatically have IPv4-encoded-IPv6 addresses as the nexthop-address in the advertisement.

To configure 6PE, complete the following steps:

### SUMMARY STEPS

1. **enable**
2. **configure terminal**
3. **ip cef**
4. **ipv6 cef**
5. **ipv6 unicast-routing**
6. **router bgp *as-number***
7. **no synchronization**
8. **no bgp default ipv4-unicast**

9. **neighbor** { *ip-address* | *ipv6-address* | *peer-group-name* } **remote-as** *as-number*
10. **neighbor** { *ip-address* | *ipv6-address* | *peer-group-name* } **update-source** *interface-type* *interface-number*
11. **address-family ipv6**
12. **neighbor** { *ip-address* | *ipv6-address* | *peer-group-name* } **activate**
13. **neighbor** { *ip-address* | *ipv6-address* | *peer-group-name* } **send-label**
14. **exit-address-family**

## DETAILED STEPS

	Command	Purpose
Step 1	<b>enable</b>  <b>Example:</b> Router> enable	Enables privileged EXEC mode. <ul style="list-style-type: none"> <li>• Enter your password if prompted.</li> </ul>
Step 2	<b>configure terminal</b>  <b>Example:</b> Router# configure terminal	Enters global configuration mode.
Step 3	<b>ip cef</b>  <b>Example:</b> Router(config)# ip cef	Enables Cisco Express Forwarding on the router.
Step 4	<b>ipv6 cef</b>  <b>Example:</b> Router(config)# ipv6 cef	Enables Cisco Express Forwarding for IPv6.
Step 5	<b>ipv6 unicast-routing</b>  <b>Example:</b> Router(config)# ipv6 unicast-routing	Enables the forwarding of IPv6 unicast datagrams.
Step 6	<b>router bgp</b> <i>as-number</i>  <b>Example:</b> Router(config)# router bgp 100	Enters the number that identifies the autonomous system (AS) in which the router resides. <ul style="list-style-type: none"> <li>• <i>as-number</i>—Autonomous system number. Range for 2-byte numbers is 1 to 65535. Range for 4-byte numbers is 1.0 to 65535.65535.</li> </ul>
Step 7	<b>no synchronization</b>  <b>Example:</b> Router(config-router)# no synchronization	Advertises a network route without waiting for IGP.

	Command	Purpose
Step 8	<p><b>no bgp default ipv4-unicast</b></p> <p><b>Example:</b> Router(config-router)# no bgp default ipv4-unicast</p>	Disables the default IPv4 unicast address family for peering session establishment.
Step 9	<p><b>neighbor</b> {<i>ip-address</i>   <i>ipv6-address</i>   <i>peer-group-name</i>} <b>remote-as</b> <i>as-number</i></p> <p><b>Example:</b> Router(config-router)# neighbor 10.108.1.2 remote-as 65200</p>	<p>Adds an entry to the BGP or multiprotocol BGP neighbor table.</p> <ul style="list-style-type: none"> <li>• <i>ip-address</i>—IP address of a peer router with which routing information will be exchanged.</li> <li>• <i>ipv6-address</i>—IPv6 address of a peer router with which routing information will be exchanged.</li> <li>• <i>peer-group-name</i>—Name of the BGP peer group.</li> <li>• <b>remote-as</b>—Specifies a remote autonomous system.</li> <li>• <i>as-number</i>—Number of an autonomous system to which the neighbor belongs, ranging from 1 to 65535.</li> </ul>
Step 10	<p><b>neighbor</b> {<i>ip-address</i>   <i>ipv6-address</i>   <i>peer-group-name</i>} <b>update-source</b> interface-type interface-number</p> <p><b>Example:</b> Router(config-router)# neighbor 172.16.2.3 update-source Loopback0</p>	Configures BGP sessions to use any operational interface for TCP connections.
Step 11	<p><b>address-family ipv6</b></p> <p><b>Example:</b> Router(config-router)# address-family ipv6</p>	Enters address family configuration mode for configuring routing sessions, such as BGP, that use standard IPv6 address prefixes.
Step 12	<p><b>neighbor</b> {<i>ip-address</i>   <i>ipv6-address</i>   <i>peer-group-name</i>} <b>activate</b></p> <p><b>Example:</b> Router(config-router-af)# neighbor 10.0.0.44 activate</p>	Enables the exchange of information with a BGP neighbor.
Step 13	<p><b>neighbor</b> {<i>ip-address</i>   <i>ipv6-address</i>   <i>peer-group-name</i>} <b>send-label</b></p> <p><b>Example:</b> Router(config-router-af)# neighbor 10.0.0.44 send-label</p>	Sends MPLS labels with BGP routes to a neighboring BGP router.
Step 14	<p><b>exit-address-family</b></p> <p><b>Example:</b> Router(config-router-af)# exit-address-family</p>	Exits BGP address-family submode.

## Configuring 6VPE

6VPE requires setting up of IPv6 connectivity from PE to CE routers, MP-BGP peering to the neighboring PE and MPLS/IPv4 connectivity to the core network using supported routing protocols (like OSPF, IS-IS, EIGRP, Static) as done in 6PE. In addition, IPv6 VRFs have to be created on the PE routers and attached to the interfaces connecting to CE routers. IPv6-only or dual-stack(multi-protocol) VRFs support IPv6 VRF definitions.

To configure 6VPE, perform the tasks given below:

- [Setting up IPv6 Connectivity from PE to CE Routers](#)
- [Setting up MP-BGP Peering to the Neighboring PE](#)
- [Setting up MPLS/IPv4 Connectivity with LDP](#)
- [Creating IPv6 VRFs on PE Routers](#)

### Setting up IPv6 Connectivity from PE to CE Routers

To configure IPv6 connectivity from PE to CE routers, complete the following steps:

#### SUMMARY STEPS

1. **enable**
2. **configure terminal**
3. **router bgp** *as-number*
4. **address-family ipv6** [**vrf** *vrf-name*]
5. **neighbor** {*ip-address* | *ipv6-address* | *peer-group-name*} **remote-as** *as-number*
6. **neighbor** {*ip-address* | *ipv6-address* | *peer-group-name*} **activate**
7. **exit-address-family**

#### DETAILED STEPS

	Command	Purpose
Step 1	<b>enable</b>  <b>Example:</b> Router> enable	Enables privileged EXEC mode. <ul style="list-style-type: none"> <li>• Enter your password if prompted.</li> </ul>
Step 2	<b>configure terminal</b>  <b>Example:</b> Router# configure terminal	Enters global configuration mode.
Step 3	<b>router bgp</b> <i>as-number</i>  <b>Example:</b> Router(config)# router bgp 100	Enters the number that identifies the autonomous system (AS) in which the router resides. <ul style="list-style-type: none"> <li>• <i>as-number</i>—Autonomous system number. Range for 2-byte numbers is 1 to 65535. Range for 4-byte numbers is 1.0 to 65535.65535.</li> </ul>

	Command	Purpose
Step 4	<p><b>address-family ipv6</b> [<i>vrf vrf-name</i>]</p> <p><b>Example:</b>  Router(config-router)# address-family  ipv6 labeled-unicast</p>	<p>Enters address family configuration mode for configuring routing sessions, such as BGP, that use standard IPv6 address prefixes.</p> <ul style="list-style-type: none"> <li><b>vrf</b>—(Optional) Specifies all VRF instance tables or a specific VRF table for an IPv6 address.</li> <li><b>vrf-name</b>—(Optional) A specific VRF table for an IPv6 address.</li> </ul>
Step 5	<p><b>neighbor</b> {<i>ip-address</i>   <i>ipv6-address</i>   <i>peer-group-name</i>} <b>remote-as</b> <i>as-number</i></p> <p><b>Example:</b>  Router(config-router-af)# neighbor  10.108.1.2 remote-as 65200</p>	<p>Adds an entry to the BGP or multiprotocol BGP neighbor table.</p> <ul style="list-style-type: none"> <li><b>ip-address</b>—IP address of a peer router with which routing information will be exchanged.</li> <li><b>ipv6-address</b>—IPv6 address of a peer router with which routing information will be exchanged.</li> <li><b>peer-group-name</b>—Name of the BGP peer group.</li> <li><b>remote-as</b>—Specifies a remote autonomous system.</li> <li><b>as-number</b>—Number of an autonomous system to which the neighbor belongs, ranging from 1 to 65535.</li> </ul>
Step 6	<p><b>neighbor</b> {<i>ip-address</i>   <i>ipv6-address</i>   <i>peer-group-name</i>} <b>activate</b></p> <p><b>Example:</b>  Router(config-router-af)# neighbor  10.0.0.44 activate</p>	<p>Enables the exchange of information with a BGP neighbor.</p>
Step 7	<p><b>exit-address-family</b></p> <p><b>Example:</b>  Router(config-router-af)#  exit-address-family</p>	<p>Exits BGP address-family submode.</p>

## Setting up MP-BGP Peering to the Neighboring PE

To configure MP-BGP peering to the neighboring PE routers, complete the following steps:

### SUMMARY STEPS

1. **enable**
2. **configure terminal**
3. **router bgp** *as-number*
4. **address-family vpnv6**
5. **neighbor** {*ip-address* | *ipv6-address* | *peer-group-name*} **activate**
6. **neighbor** {*ip-address* | *ipv6-address* | *peer-group-name*} **send-community** *extended*
7. **exit-address-family**



## DETAILED STEPS

	Command	Purpose
Step 1	<b>enable</b>  <b>Example:</b> Router> enable	Enables privileged EXEC mode. <ul style="list-style-type: none"> <li>Enter your password if prompted.</li> </ul>
Step 2	<b>configure terminal</b>  <b>Example:</b> Router# configure terminal	Enters global configuration mode.
Step 3	<b>router bgp as-number</b>  <b>Example:</b> Router(config)# router bgp 100	Enters the number that identifies the autonomous system (AS) in which the router resides. <ul style="list-style-type: none"> <li><i>as-number</i>—Autonomous system number. Range for 2-byte numbers is 1 to 65535. Range for 4-byte numbers is 1.0 to 65535.65535.</li> </ul>
Step 4	<b>address-family vpv6</b>  <b>Example:</b> Router(config-router)# address-family vpv6	Places the router in address family configuration mode for configuring routing sessions, such as BGP, that use standard VPNv6 address prefixes.
Step 5	<b>neighbor {ip-address   ipv6-address   peer-group-name} activate</b>  <b>Example:</b> Router(config-router-af)# neighbor 10.0.0.44 activate	Enable the exchange of information with a BGP neighbor. <ul style="list-style-type: none"> <li><i>ip-address</i>—IP address of a peer router with which routing information will be exchanged.</li> <li><i>ipv6-address</i>—IPv6 address of a peer router with which routing information will be exchanged.</li> <li><i>peer-group-name</i>—Name of the BGP peer group.</li> </ul>
Step 6	<b>neighbor {ip-address   ipv6-address   peer-group-name} send-community extended</b>  <b>Example:</b> Router(config-router-af)# neighbor 10.108.1.2 send-community extended	Adds an entry to the BGP or multiprotocol BGP neighbor table. <ul style="list-style-type: none"> <li><i>ip-address</i>—IP address of a peer router with which routing information will be exchanged.</li> <li><i>ipv6-address</i>—IPv6 address of a peer router with which routing information will be exchanged.</li> <li><i>peer-group-name</i>—Name of the BGP peer group.</li> <li><b>extended</b>—Specifies that only extended communities will be sent.</li> </ul>
Step 7	<b>exit-address-family</b>  <b>Example:</b> Router(config-router-af)# exit-address-family	Exits BGP address-family submode.

## Setting up MPLS/IPv4 Connectivity with LDP

To configure MPLS and IPv4 connectivity with LDP, complete the following steps:

### SUMMARY STEPS

1. **enable**
2. **configure terminal**
3. **interface** *interface*
4. **ip address** *ip-address*
5. **mpls ip**
6. **exit**

### DETAILED STEPS

	Command	Purpose
Step 1	<b>enable</b>  <b>Example:</b> Router> enable	Enables privileged EXEC mode. <ul style="list-style-type: none"> <li>• Enter your password if prompted.</li> </ul>
Step 2	<b>configure terminal</b>  <b>Example:</b> Router# configure terminal	Enters global configuration mode.
Step 3	<b>interface</b> <i>interface-name</i>  <b>Example:</b> Router(config)# interface vlan 100	Configures an interface type and to enter interface configuration mode. <ul style="list-style-type: none"> <li>• <i>interface-name</i>—Interface name.</li> </ul>
Step 4	<b>ip address</b> <i>ip-address</i>  <b>Example:</b> Router(config-if)# ip address 1.1.1.1 255.255.255.0	Sets a primary or secondary IP address for an interface.
Step 5	<b>mpls ip</b>  <b>Example:</b> Router(config-if)# mpls ip	Enables MPLS forwarding of IP packets along normally routed paths for a particular interface.
Step 6	<b>exit</b>  <b>Example:</b> Router(config-if)# exit	Exits interface configuration mode.

## Creating IPv6 VRFs on PE Routers

To configure IPv6 VRFs on the PE routers, complete the following tasks:

- [Configuring IPv6-only VRF](#)
- [Configuring Dual-stack VRF](#)

### Configuring IPv6-only VRF

To configure IPv6-only VRF, complete the following steps:

#### SUMMARY STEPS

1. **enable**
2. **configure terminal**
3. **vrf definition** *vrf-name*
4. **address-family ipv6**
5. **exit-address-family**

#### DETAILED STEPS

	Command	Purpose
Step 1	<b>enable</b>  <b>Example:</b> Router> enable	Enables privileged EXEC mode. <ul style="list-style-type: none"> <li>• Enter your password if prompted.</li> </ul>
Step 2	<b>configure terminal</b>  <b>Example:</b> Router# configure terminal	Enters global configuration mode.
Step 3	<b>vrf definition</b> <i>vrf-name</i>  <b>Example:</b> Router(config)# vrf definition red	Configures a VRF routing table instance and enters VRF configuration mode. <ul style="list-style-type: none"> <li>• <i>vrf-name</i>—Name assigned to a VRF.</li> </ul>
Step 4	<b>address-family ipv6</b>  <b>Example:</b> Router(config-vrf)# address-family ipv6	Enters address family configuration mode for configuring routing sessions that use standard IPv6 address prefixes.
Step 5	<b>exit-address-family</b>  <b>Example:</b> Router(config-vrf-af)# exit-address-family	Exits address-family submode.

## Configuring Dual-stack VRF

To configure dual-stack VRF, complete the following steps:

### SUMMARY STEPS

1. **enable**
2. **configure terminal**
3. **vrf definition** *vrf-name*
4. **address-family ipv4**
5. **exit-address-family**
6. **address-family ipv6**
7. **exit-address-family**

### DETAILED STEPS

	Command	Purpose
Step 1	<b>enable</b>  <b>Example:</b> Router> enable	Enables privileged EXEC mode. <ul style="list-style-type: none"> <li>• Enter your password if prompted.</li> </ul>
Step 2	<b>configure terminal</b>  <b>Example:</b> Router# configure terminal	Enters global configuration mode.
Step 3	<b>vrf definition</b> <i>vrf-name</i>  <b>Example:</b> Router(config)# vrf definition red	Configures a VRF routing table instance and enters VRF configuration mode. <ul style="list-style-type: none"> <li>• <i>vrf-name</i>—Name assigned to a VRF.</li> </ul>
Step 4	<b>address-family ipv4</b>  <b>Example:</b> Router(config-vrf)# address-family ipv4	Enters address family configuration mode for configuring routing sessions that use standard IPv4 address prefixes.
Step 5	<b>exit-address-family</b>  <b>Example:</b> Router(config-vrf-af)# exit-address-family	Exits address-family submode.

	Command	Purpose
Step 6	<b>address-family ipv6</b>  <b>Example:</b> Router(config-vrf)# address-family ipv6	Enters address family configuration mode for configuring routing sessions that use standard IPv6 address prefixes.
Step 7	<b>exit-address-family</b>  <b>Example:</b> Router(config-vrf-af)# exit-address-family	Exits address-family submode.

## Verifying IPv6 over MPLS: 6PE and 6VPE Configuration

To verify the IPv6 over MPLS: 6PE and 6VPE configuration, use the **show** commands shown in the following examples.

To display BGP entries from all of the customer-specific IPv6 routing tables, use the following **show** command.

```
Router# show bgp vpnv6 unicast all
```

```

Network                Next Hop                Metric LocPrf    Weight Path
Route Distinguisher: 100:1
* 2001:100:1:1000::/56  2001:100:1:1000::72a   0           0      200 ?
*                       ::                     0           32768 ?
* i2001:100:1:2000::/56  ::FFFF:200.10.10.1
Route Distinguisher: 200:1
* 2001:100:2:1000::/56  ::                     0           32768 ?
* 2001:100:2:2000::/56  ::FFFF:200.10.10.1    0           32768 ?

```

To display the parameters and the current state of the active IPv6 routing protocol processes, use the following **show** command:

```
Router# show ipv6 protocols vrf vpe_1
```

```

IPv6 Routing Protocol is "connected"
IPv6 Routing Protocol is "bgp 100"
  IGP synchronization is disabled
  Redistribution:
    None
  Neighbor(s):
    Address                               FiltIn FiltOut Weight RoutemapIn RoutemapOut
    100::2

```

To display IPv6 router advertisement (RA) information received from on-link devices, use the following **show** command:

```
Router# show ipv6 route vrf vpe_1
```

```

pura2013#sh ipv6 route vrf vpe_1
IPv6 Routing Table - vpe_1 - 29 entries
Codes: C - Connected, L - Local, S - Static, U - Per-user Static route
       B - BGP, R - RIP, H - NHRP, I1 - ISIS L1
       I2 - ISIS L2, IA - ISIS interarea, IS - ISIS summary, D - EIGRP
       EX - EIGRP external, ND - ND Default, NDp - ND Prefix, DCE - Destination
       NDr - Redirect

```

```

        O - OSPF Intra, OI - OSPF Inter, OE1 - OSPF ext 1, OE2 - OSPF ext 2
        ON1 - OSPF NSSA ext 1, ON2 - OSPF NSSA ext 2
B 72::/64 [20/0]
    via 100::2
B 72:0:0:1::/64 [20/0]
    via 100::2
B 72:0:0:2::/64 [20/0]
    via 100::2
B 72:0:0:4::/64 [20/0]
    via 100::2
B 72:0:0:5::/64 [20/0]
    via 100::2
B 72:0:0:6::/64 [20/0]
    via 100::2
B 72:0:0:7::/64 [20/0]
    via 100::2
B 72:0:0:8::/64 [20/0]
    via 100::2
B 72:0:0:9::/64 [20/0]
    via 100::2
B 72:0:0:A::/64 [20/0]
    via 100::2
B 72:0:0:B::/64 [20/0]
    via 100::2
B 72:0:0:C::/64 [20/0]
    via 100::2
B 72:0:0:D::/64 [20/0]
    via 100::2
B 72:0:0:E::/64 [20/0]
    via 100::2
B 72:0:0:F::/64 [20/0]
    via 100::2
B 72:0:0:10::/64 [20/0]
    via 100::2
B 72:0:0:11::/64 [20/0]
    via 100::2
B 72:0:0:12::/64 [20/0]
    via 100::2

```

To display the Cisco Express Forwarding Forwarding Information Base (FIB) associated with an IPv6 Virtual Private Network (VPN) routing and forwarding (VRF) instance, use the following **show** command.

```

Router# show ipv6 cef vrf cisco1

2001:8::/64
  attached to GigabitEthernet0/0/1
2001:8::3/128
  receive
2002:8::/64
  nexthop 10.1.1.2 GigabitEthernet0/1/0 label 22 19
2010::/64
  nexthop 2001:8::1 GigabitEthernet0/0/1
2012::/64
  attached to Loopback1
2012::1/128
  receive

```

To display IPv6 routing table information associated with a VPN routing and forwarding (VRF) instance, use the following **show** command.

```
Router# show ipv6 route vrf

IPv6 Routing Table cisco1 - 6 entries
Codes: C - Connected, L - Local, S - Static, R - RIP, B - BGP
       U - Per-user Static route
       I1 - ISIS L1, I2 - ISIS L2, IA - ISIS interarea
       O - OSPF intra, OI - OSPF inter, OE1 - OSPF ext 1, OE2 - OSPF ext 2
C   2001:8::/64 [0/0]
    via ::, GigabitEthernet0/0/1
L   2001:8::3/128 [0/0]
    via ::, GigabitEthernet0/0/1
B   2002:8::/64 [200/0]
    via ::FFFF:192.168.1.4,
B   2010::/64 [20/1]
    via 2001:8::1,
C   2012::/64 [0/0]
    via ::, Loopback1
L   2012::1/128 [0/0]
    via ::, Loopback1
```

To display label forwarding information for advertised Virtual Private Network (VPN) routing and forwarding (VRF) instance routes, use the following **show** command.

```
Router# show mpls forwarding-table vrf vpe_1

Local      Outgoing  Prefix          Bytes Label  Outgoing  Next Hop
Label      Label     or Tunnel Id   Switched     interface
1760      No Label  72::/64[V]     0            V1100     100::2
1761      No Label  72:0:0:1::/64[V] 0            V1100     100::2
1762      No Label  72:0:0:2::/64[V] 0            V1100     100::2
1764      No Label  72:0:0:3::/64[V] 0            V1100     100::2
1765      No Label  72:0:0:4::/64[V] 0            V1100     100::2
1768      No Label  72:0:0:7::/64[V] 0            V1100     100::2
1769      No Label  72:0:0:8::/64[V] 0            V1100     100::2
1770      No Label  72:0:0:9::/64[V] 0            V1100     100::2
1771      No Label  72:0:0:A::/64[V] 0            V1100     100::2
1772      No Label  72:0:0:B::/64[V] 0            V1100     100::2
1773      No Label  72:0:0:C::/64[V] 0            V1100     100::2
1774      No Label  72:0:0:D::/64[V] 0            V1100     100::2
1775      No Label  72:0:0:E::/64[V] 0            V1100     100::2
1776      No Label  72:0:0:F::/64[V] 0            V1100     100::2
1777      No Label  72:0:0:10::/64[V] \
                                0            V1100     100::2
1778      No Label  72:0:0:11::/64[V] \
                                0            V1100     100::2
Local      Outgoing  Prefix          Bytes Label  Outgoing  Next Hop
Label      Label     or Tunnel Id   Switched     interface
1779      No Label  72:0:0:12::/64[V] \
                                0            V1100     100::2
1780      No Label  72:0:0:13::/64[V] \
                                0            V1100     100::2
1781      No Label  72:0:0:14::/64[V] \
                                0            V1100     100::2
1782      No Label  72:0:0:15::/64[V] \
                                0            V1100     100::2
1783      No Label  72:0:0:16::/64[V] \
                                0            V1100     100::2
1784      No Label  72:0:0:17::/64[V] \
                                0            V1100     100::2
1785      No Label  72:0:0:18::/64[V] \
                                0            V1100     100::2
```

To display output information linking the MPLS label with prefixes, use the following **show** command.

```
Router# show mpls forwarding-table
```

Local tag	Outgoing tag or VC	Prefix or Tunnel Id	Bytes switched	tag	Outgoing interface	Next Hop
16	Aggregate	IPv6	0			
17	Aggregate	IPv6	0			
18	Aggregate	IPv6	0			
19	Pop tag	192.168.99.64/30	0		GE0/0	point2point
20	Pop tag	192.168.99.70/32	0		GE0/0	point2point
21	Pop tag	192.168.99.200/32	0		GE0/0	point2point
22	Aggregate	IPv6	5424			
23	Aggregate	IPv6	3576			
24	Aggregate	IPv6	2600			

To display entries in the IPv6 BGP routing table, use the following **show** command:

```
Router# show bgp ipv6 2001:33::/64
```

```
BGP routing table entry for 2001:33::/64, version 3
Paths: (1 available, best #1, table Global-IPv6-Table)
Not advertised to any peer
Local
::FFFF:192.168.0.2 (metric 30) from 192.168.0.2 (192.168.0.2)
Origin IGP, localpref 100, valid, internal, best
```

## Configuration Examples

This section provides sample configuration examples for IPv6 over MPLS: 6PE and 6VPE feature on the Cisco ASR 901 router.

- [Example: Configuring 6PE, page 37-18](#)
- [Example: Configuring 6VPE, page 37-19](#)

### Example: Configuring 6PE

The following is a sample configuration of 6PE.

```
interface GigabitEthernet0/3/0/0
  ipv6 address 2001::1/64
!
router isis ipv6-cloud
  net 49.0000.0000.0001.00
  address-family ipv6 unicast
    single-topology
  interface GigabitEthernet0/3/0/0
    address-family ipv6 unicast
!
!
router bgp 55400
  bgp router-id 54.6.1.1
  address-family ipv4 unicast
!
  address-family ipv6 unicast
    network 55:5::/64
```



```

redistribute connected
redistribute isis ipv6-cloud
  allocate-label all
!
neighbor 34.4.3.3
  remote-as 55400
  address-family ipv4 unicast
!
  address-family ipv6 labeled-unicast

```

## Example: Configuring 6VPE

The following is a sample configuration of 6VPE.

```

vrf vpn1
  address-family ipv6 unicast
    import route-target
      200:2
    !
    export route-target
      200:2
  interface Loopback0
    ipv4 address 10.0.0.1 255.255.255.255
  interface GigabitEthernet0/0/0/1
    vrf vpn1
    ipv6 address 2001:c003:a::2/64
  router bgp 1
    bgp router-id 10.0.0.1
    bgp redistribute-internal
    bgp graceful-restart
    address-family ipv4 unicast
    !
    address-family vpnv6 unicast
    !
    neighbor 10.0.0.2 >>>> Remote peer loopback address.
      remote-as 1
      update-source Loopback0
      address-family ipv4 unicast
      !
      address-family vpnv6 unicast
        route-policy pass-all in
        route-policy pass-all out
    !
    vrf vpn1
      rd 100:2
      bgp router-id 140.140.140.140
      address-family ipv6 unicast
      redistribute connected
    !
    neighbor 2001:c003:a::1
      remote-as 6502
      address-family ipv6 unicast
      route-policy pass-all in
      route-policy pass-all out

```

## Additional References

The following sections provide references related to Remote Loop-Free Alternate Fast Reroute feature.

### Related Documents

Related Topic	Document Title
Cisco IOS Commands	<a href="#">Cisco IOS Master Commands List, All Releases</a>
Cisco ASR 901 Router Commands	<a href="#">Cisco ASR 901 Series Aggregation Services Router Command Reference</a>
IPv6 Provider Edge Router over MPLS	<a href="#">Cisco IOS IPv6 Provider Edge Router (6PE) over MPLS</a>
IPv6 VPN over MPLS	<a href="#">MPLS: Layer 3 VPNs Configuration Guide</a>

### Standards

Standard	Title
None	—

### MIBs

MIB	MIBs Link
None	To locate and download MIBs for selected platforms, Cisco IOS releases, and feature sets, use Cisco MIB Locator found at the following URL: <a href="http://www.cisco.com/go/mibs">http://www.cisco.com/go/mibs</a>

### RFCs

RFC	Title
None	—

### Technical Assistance

Description	Link
The Cisco Technical Support website contains thousands of pages of searchable technical content, including links to products, technologies, solutions, technical tips, and tools. Registered Cisco.com users can log in from this page to access even more content.	<a href="http://www.cisco.com/techsupport">http://www.cisco.com/techsupport</a>

## Feature Information for IPv6 over MPLS: 6PE and 6VPE

Table 37-2 lists the features in this module and provides links to specific configuration information.

Use Cisco Feature Navigator to find information about platform support and software image support. Cisco Feature Navigator enables you to determine which software images support a specific software release, feature set, or platform. To access Cisco Feature Navigator, go to <http://www.cisco.com/go/cfn>. An account on Cisco.com is not required.



**Note**

Table 37-2 lists only the software release that introduced support for a given feature in a given software release train. Unless noted otherwise, subsequent releases of that software release train also support that feature.

**Table 37-2** Feature Information for IPv6 over MPLS: 6PE and 6VPE

Feature Name	Releases	Feature Information
IPv6 over MPLS: 6PE and 6VPE	15.2(2)SNI	<p>This feature was introduced on the Cisco ASR 901 routers. The following sections provide information about this feature:</p> <ul style="list-style-type: none"> <li>• <a href="#">Feature Overview, page 37-2</a></li> <li>• <a href="#">IPv6 on Provider Edge Routers, page 37-3</a></li> <li>• <a href="#">IPv6 on VPN Provider Edge Routers, page 37-4</a></li> <li>• <a href="#">How to Configure IPv6 over MPLS: 6PE and 6VPE, page 37-6</a></li> </ul>





## Storm Control

---

This feature module describes the Storm Control feature that helps to monitor the incoming broadcast, multicast, and unknown unicast packets and prevent them from flooding the LAN ports.

### Finding Feature Information

Your software release may not support all the features documented in this module. For the latest feature information and caveats, see the release notes for your platform and software release. To find information about the features documented in this module, and to see a list of the releases in which each feature is supported, see the [“Feature Information for Storm Control”](#) section on page 38-9.

Use Cisco Feature Navigator to find information about platform support and Cisco software image support. To access Cisco Feature Navigator, go to <http://www.cisco.com/go/cfn>. An account on Cisco.com is not required.

### Contents

- [Prerequisites, page 38-2](#)
- [Restrictions, page 38-2](#)
- [Feature Overview, page 38-2](#)
- [Configuring Storm Control, page 38-2](#)
- [Configuring Error Disable Recovery, page 38-5](#)
- [Configuration Example for Storm Control, page 38-7](#)
- [Additional References, page 38-8](#)
- [Feature Information for Storm Control, page 38-9](#)

## Prerequisites

- Cisco IOS Release 15.3(3)S or a later release that supports the Storm Control feature must be installed previously on the Cisco ASR 901 Series Aggregation Services Router.

## Restrictions

- The **storm-control** command is not recommended on an interface that is part of a port channel.
- Storm-control counters are not supported on port channel as the counters are based on physical ports.
- Discarded counters are not displayed for port channel. You should check the port channel member-ports for discarded counters.
- The **current rate** field is not supported for **show** commands in hardware based storm control.
- Supports only drop counters. Total broadcast received in storm control is not supported.

## Feature Overview

A traffic storm occurs when huge amount of broadcast, multicast, or unknown unicast packets flood the LAN, creating excessive traffic and degrading network performance. Errors in the protocol-stack implementation or in the network configuration can also cause a storm. The mechanism to prevent and control such events is known as storm control or broadcast suppression.

The Storm Control feature prevents switchports on a LAN from being disrupted by a broadcast, multicast, or unknown unicast storm on one of the interfaces. This feature monitors incoming traffic statistics over a time period and compares the measurement with a predefined suppression level threshold. The threshold represents the percentage of the total available bandwidth of the port. If the threshold of a traffic type is reached, the system takes the appropriate storm control action until the incoming traffic falls below the threshold level.

Storm control also acts as a policer, and it drops only the storms that breaches the configured storm level.

This feature supports the following:

- Ethernet port: per port configuration for broadcast, multicast, and unknown unicast traffic.
- 10 GigabitEthernet interfaces.
- SNMP trap and SYSLOG messages: indicating storm control detection.
- Individual dropped packet counters: for broadcast, multicast, and unknown unicast flows.
- Error disable recovery feature with storm control shutdown action.

## Configuring Storm Control

To configure Storm Control feature, complete the following steps:

**Note**

---

This feature is disabled by default.

---

## SUMMARY STEPS

1. **enable**
2. **configure terminal**
3. **interface** *type number*
4. **storm-control** {action {shutdown | trap}| {broadcast | multicast | unicast} {level {level | bps  
bps-level | pps pps-level}}}
5. **end**

## DETAILED STEPS

	Command	Purpose
Step 1	<b>enable</b>  <b>Example:</b> Router> enable	Enables privileged EXEC mode. <ul style="list-style-type: none"> <li>• Enter your password if prompted.</li> </ul>
Step 2	<b>configure terminal</b>  <b>Example:</b> Router# configure terminal	Enters global configuration mode.
Step 3	<b>interface</b> <i>type number</i>  <b>Example:</b> Router(config)# interface gigabitethernet 0/1	Specifies an interface type and number, and enters interface configuration mode.

	Command	Purpose
Step 4	<pre>storm-control {action {shutdown   trap}   {broadcast   multicast   unicast} {level {level   bps bps-level   pps pps-level}}</pre> <p><b>Example:</b> Router(config-if)# storm-control broadcast level 70</p>	<p>Configures broadcast, multicast, or unknown unicast storm control.</p> <ul style="list-style-type: none"> <li>• <b>action</b>—Specifies the action to take when a storm occurs on a port.</li> <li>• <b>shutdown</b>—Disables the port during a storm.</li> <li>• <b>trap</b>—Sends an SNMP trap.</li> <li>• <b>broadcast</b>—Configures broadcast storm control.</li> <li>• <b>multicast</b>—Configures multicast storm control.</li> <li>• <b>unicast</b>—Configures unknown unicast storm control.</li> <li>• <b>level</b>—Specifies the rising threshold level for broadcast, multicast, or unicast traffic as a percentage of the bandwidth. The valid range is from 1 to 100 percent. There can also be a fractional part in the level ranging from 0 to 99, which is expressed in percentage. So a level of 49.99 on a GigabitEthernet interface means that once the number of broadcast (or configured type) packets on the interface exceeds 499.90Mbps, all the exceeding packets are dropped.</li> <li>• <i>level</i>—Threshold level.</li> <li>• <b>bps</b>—Specifies the suppression level in bits per second.</li> <li>• <i>bps-level</i>—Threshold level.</li> <li>• <b>pps</b>—Specifies the suppression level in packets per second.</li> <li>• <i>pps-level</i>—Threshold level.</li> </ul>
Step 5	<pre>end</pre> <p><b>Example:</b> Router(config-if)# end</p>	<p>Exits the interface configuration mode and enters the privileged EXEC mode.</p>

**Note**

To disable Storm Control feature, use the **no storm-control** command.

## Verifying Storm Control

To verify the Storm Control feature configuration, use the **show** command described in the following example.

```
Router# show storm-control broadcast
```

```
Interface  Type  Filter State  Level      Current
-----  -
Gi0/1     Bcast Forwarding  200 pps    0 pps
Gi0/1     Mcast Forwarding  300 pps    0 pps
```

! The "current" field is not supported for storm control.



To verify the dropped counters, use the **show** command described in the following example.

```
Router# show interface gigabitethernet 0/1 counters storm-control
```

```
Port      UcastSupp  UcastSuppDiscards  McastSupp  McastSuppDiscards  BcastSupp  BcastSuppDiscards
      %/ps
Gi0/1    100.00%    0                    20000p     1065163             100.00%    0
```

## Configuring Error Disable Recovery

The Cisco ASR 901 router supports error disable recovery for traffic storm control. When a storm is detected, the interfaces configured with the shutdown action of the **storm control** command are brought down. By default, the error recovery is disabled. You can configure automatic recovery by enabling the error disable recovery at the global configuration level and by setting a time-interval for error recovery.

To configure error disable recovery, complete the following steps:

### SUMMARY STEPS

1. **enable**
2. **configure terminal**
3. **errdisable recovery cause storm-control**
4. **errdisable recovery interval *seconds***
5. **end**

### DETAILED STEPS

	Command	Purpose
Step 1	<b>enable</b>  <b>Example:</b> Router> enable	Enables privileged EXEC mode. <ul style="list-style-type: none"> <li>• Enter your password if prompted.</li> </ul>
Step 2	<b>configure terminal</b>  <b>Example:</b> Router# configure terminal	Enters global configuration mode.
Step 3	<b>errdisable recovery cause storm-control</b>  <b>Example:</b> Router(config)# errdisable recovery cause storm-control	Configure recovery mechanism and recovery from a specific cause.

	Command	Purpose
Step 4	<b>errdisable recovery interval</b> <i>seconds</i>  <b>Example:</b> Router(config)# errdisable recovery interval 30	Configures the period to recover from a specified error-disable cause. <ul style="list-style-type: none"> <li><i>seconds</i>—Specifies the time to recover from a specified error-disable cause.</li> </ul>
Step 5	<b>end</b>  <b>Example:</b> Router(config)# end	Exits global configuration mode and enters the privileged EXEC mode.

## Monitoring Error Disable Recovery

To display the information about the error-disable recovery timer, use the **show** command described in the following example.

```
Router# show errdisable recovery
```

```

ErrDisable Reason      Timer Status
-----
udld                   Disabled
bpduguard              Disabled
security-violatio     Disabled
channel-misconfig     Disabled
vmps                   Disabled
paggp-flap            Disabled
dtp-flap               Disabled
link-flap              Disabled
lsgroup                Enabled
l2ptguard              Disabled
psecure-violation     Disabled
gbic-invalid           Disabled
dhcp-rate-limit       Disabled
mac-limit              Disabled
unicast-flood         Disabled
storm-control         Enabled
arp-inspection        Disabled
loopback               Disabled
link-monitor-fail     Disabled
oam-remote-failur     Disabled
oam-remote-failur     Disabled
oam-remote-failur     Disabled
dot1ad-incomp-ety     Disabled
dot1ad-incomp-tun     Disabled
mlacp-minlink         Disabled

```

```
Timer interval: 30 seconds
```

```
Interfaces that will be enabled at the next timeout:
```

```

Interface      Errdisable reason      Time left(sec)
-----
Gi0/3          storm-control          4

```

# Configuration Example for Storm Control

The following is a sample configuration of Storm Control feature on the Cisco ASR 901 router.

```
!  
interface GigabitEthernet0/1  
no ip address  
negotiation auto  
storm-control broadcast level pps 200  
storm-control multicast level pps 300  
storm-control action trap  
end  
!
```

## Troubleshooting Tips

Use the following **debug** command to enable the debug feature to help in troubleshooting the storm control feature.

```
Router# debug platform hardware ether SC
```

# Additional References

The following sections provide references related to Storm Control feature.

## Related Documents

Related Topic	Document Title
Cisco IOS Commands	<i>Cisco IOS Master Commands List, All Releases</i>
Cisco ASR 901 Router Commands	<i>Cisco ASR 901 Series Aggregation Services Router Command Reference</i>

## Standards

Standard	Title
None	—

## MIBs

MIB	MIBs Link
None	To locate and download MIBs for selected platforms, Cisco IOS releases, and feature sets, use Cisco MIB Locator found at the following URL: <a href="http://www.cisco.com/go/mibs">http://www.cisco.com/go/mibs</a>

## RFCs

RFC	Title
None	—

## Technical Assistance

Description	Link
The Cisco Technical Support website contains thousands of pages of searchable technical content, including links to products, technologies, solutions, technical tips, and tools. Registered Cisco.com users can log in from this page to access even more content.	<a href="http://www.cisco.com/techsupport">http://www.cisco.com/techsupport</a>

# Feature Information for Storm Control

Table 38-1 lists the features in this module and provides links to specific configuration information.

Use Cisco Feature Navigator to find information about platform support and software image support. Cisco Feature Navigator enables you to determine which software images support a specific software release, feature set, or platform. To access Cisco Feature Navigator, go to <http://www.cisco.com/go/cfn>. An account on Cisco.com is not required.



**Note**

Table 38-1 lists only the software release that introduced support for a given feature in a given software release train. Unless noted otherwise, subsequent releases of that software release train also support that feature.

**Table 38-1** Feature Information for Storm Control

Feature Name	Releases	Feature Information
Storm Control	15.3(3)S	<p>This feature was introduced on the Cisco ASR 901 routers.</p> <p>The following section provides information about this feature:</p> <ul style="list-style-type: none"> <li>• <a href="#">Configuring Storm Control, page 38-2</a></li> </ul>





## Remote Loop-Free Alternate - Fast Reroute

---

This feature module describes the Remote Loop-free Alternate (LFA) - Fast Reroute (FRR) feature that uses a backup route, computed using dynamic routing protocol during a node failure, to avoid traffic loss.

### Finding Feature Information

Your software release may not support all the features documented in this module. For the latest feature information and caveats, see the release notes for your platform and software release. To find information about the features documented in this module, and to see a list of the releases in which each feature is supported, see the “[Feature Information for Remote Loop-Free Alternate - Fast Reroute](#)” section on [page 39-40](#).

Use Cisco Feature Navigator to find information about platform support and Cisco software image support. To access Cisco Feature Navigator, go to <http://www.cisco.com/go/cfn>. An account on Cisco.com is not required.

### Contents

- [Prerequisites, page 39-2](#)
- [Restrictions, page 39-2](#)
- [Feature Overview, page 39-3](#)
- [How to Configure Remote Loop-Free Alternate - Fast Reroute, page 39-5](#)
- [Configuration Examples for Remote LFA-FRR, page 39-35](#)
- [Additional References, page 39-39](#)
- [Feature Information for Remote Loop-Free Alternate - Fast Reroute, page 39-40](#)

## Prerequisites

- Cisco IOS Release 15.2(2)SNI or a later release that supports the Remote LFA-FRR feature must be installed previously on the Cisco ASR 901 Series Aggregation Services Router.
- You should enable the following commands at the global configuration mode before configuring the Remote LFA-FRR feature.
  - **asr901-platf-frr enable**
  - **mpls label protocol ldp**
  - **mpls ldp router-id *loopback-id* force**
  - **mpls ldp discovery targeted-hello accept**
  - **no l3-over-l2 flush buffers**
- Your network must support the following Cisco IOS features before you can enable fast reroute link protection:
  - IP Cisco Express Forwarding (CEF)
  - Multiprotocol Label Switching (MPLS)
- Your network must also support at least one of the following protocols:
  - Intermediate System-to-Intermediate System (IS-IS)
  - Open Shortest Path First (OSPF)
- You should use throttle interior gateway protocol (IGP) timers for IS-IS and OSPF protocols.

## Restrictions

- 4-label push is not supported. Due to this limitation, Labeled BGP access (RFC 3107) with Remote LFA-FRR/TE-FRR is not supported, if it exceeds three labels. Four label push is observed on L2VPN and L3VPN scenarios where multihop tunnel terminates before the destination. The four labels are given below:
  - Backup-Repair Label
  - Tunnel Label
  - MPLS LDP Label
  - VC or VRF Label
- Since FRR is a software based solution on the Cisco ASR 901 router, you should keep the number of prefixes, label-entries, and pseudowires to a minimum to obtain good convergence numbers.
- Remote LFA-FRR is not supported on layer 3 over layer 2 deployments. Disable this configuration using the **no l3-over-l2 flush buffers** command before configuring Remote LFA-FRR.
- Ethernet over Multiprotocol Label Switching (EoMPLS) redundancy is not useful unless you have dual home pseudowire and a protecting backup pseudowire egress link with FRR.
- Pseudowire redundancy over RLFA is supported effective with Cisco IOS Release 15.4(1)S.
- TDM pseudowires over RLFA is supported effective with Cisco IOS Release 15.3(3)S.
- CFM over Xconnect over TE-FRR is not supported.
- The imposition statistics do not work for EoMPLS after the FRR event or layer 3 cutover.



- The Border Gateway Protocol (BGP) Prefix-Independent Convergence (PIC) edge is not supported. Specifically, the **bgp additional-paths install** command is not supported.
- If the network port is an LAG interface (etherchannel), you must use BFD over SVI to achieve FRR convergence numbers.
- If the LAG interface is used either on access side or towards the core, you should shutdown the interface before removing it.

## Feature Overview

The LFA-FRR is a mechanism that provides local protection for unicast traffic in IP, MPLS, EoMPLS, Inverse Multiplexing over ATM (IMA) over MPLS, Circuit Emulation Service over Packet Switched Network (CESoPSN) over MPLS, and Structure-Agnostic Time Division Multiplexing over Packet (SAToP) over MPLS networks. However, some topologies (such as the ring topology) require protection that is not afforded by LFA-FRR alone. The Remote LFA-FRR feature is useful in such situations.

The Remote LFA-FRR extends the basic behavior of LFA-FRR to any topology. It forwards the traffic around a failed node to a remote LFA that is more than one hop away.

In Remote LFA-FRR, a node dynamically computes its LFA node. After determining the alternate node (which is non-directly connected), the node automatically establishes a directed Label Distribution Protocol (LDP) session to the alternate node. The directed LDP session exchanges labels for the particular forward error correction (FEC).

When the link fails, the node uses label stacking to tunnel the traffic to the remote LFA node, to forward the traffic to the destination. All the label exchanges and tunneling to remote LFA node are dynamic in nature and pre-provisioning is not required.

Figure 39-1 shows the repair path that is automatically created by the Remote LFA-FRR feature to bypass looping. In this figure, the traffic is flowing between CE nodes (R1 to R7) through the PE nodes (protected link - R2 and R3). When the PE node fails, the repair path (R2 - R4 - R5 - R6 - R3) is used to route the traffic between CE nodes.

**Figure 39-1 Remote LFA-FRR Link Protection**

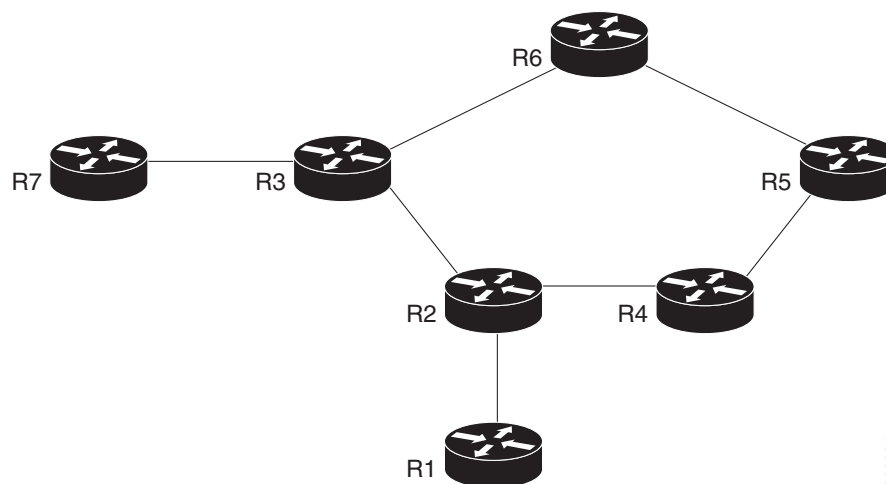

303381

<b>R1 and R7</b>	CE nodes	<b>R6 - R5 - R4</b>	P nodes
<b>R2 and R3</b>	PE nodes (protected link)	<b>R2 - R4- R5 - R6 - R3</b>	Fast Reroute Repair Path

## Benefits of Remote LFA-FRR

- Simplifies operation with minimum configuration
- Eliminates additional traffic engineering (TE) protocols.
- Computes PQ node dynamically without any manual provisioning (PQ node is a member of both the extended P-space and the Q-space. P-space is the set of routers reachable from a specific router without any path (including equal cost path splits) transiting the protected link. Q-space is the set of routers from which a specific router can be reached without any path, including equal cost path splits, transiting the protected link.)
- Prevents hair pinning that occurs in TE-FRR
- Remote LFA-FRR supports the following:
  - Basic LFA-FRR (supported for OSPF and IS-IS protocols)
  - IP, L2VPN, and L3VPN
  - BFD triggered MPLS TE-FRR. Supports BFD sessions with 50ms interval.

## Avoiding Traffic Drops

Traffic drops can occur due to congestion as a result of formation of micro loops during link recovery. To avoid traffic drops, the **tunnel-buffer port** command is introduced to set the hardware buffer values on the port. For more details on this command, see the [Cisco ASR 901 Series Aggregation Services Router Command Reference](#) guide.

## Pseudowire Redundancy over FRR

Pseudowire redundancy enables you to configure a pseudowire as a backup for the primary pseudowire. When the primary pseudowire fails, the services are switched to the backup pseudowire. Effective with Cisco IOS Release 15.4(1)S, Pseudowire Redundancy over FRR feature is supported.

You can enable FRR (TE-FRR and RLFA) in the network for both active and standby pseudowires separately. The primary and backup paths for these virtual circuits (VCs) may or may not overlap. This feature supports link failures through FRR and node failures through PW redundancy. It supports up to 500 primary and backup pseudowires.

The following figure shows the pseudowire redundancy over FRR implementation.

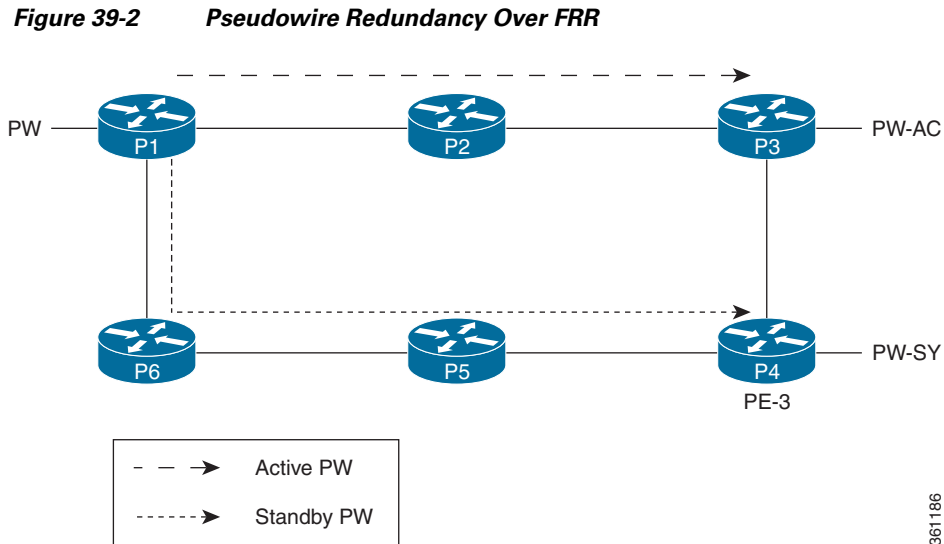

## Conditions for Switchover

- If the primary path to the peer node goes down for active VC, the FRR changes to backup and the VC remains active.
- A VC switchover does not occur unless both primary and backup paths are down for active VC.
- The standby VC does not go down until both primary and backup paths to the standby peer are down.
- A VC switchover occurs when the peer node of the active VC reboots or when the access circuit goes down.
- If the peer node of active VC reboots when the standby VC is in backup state, the VC switchover occurs immediately and the standby VC becomes active.

## How to Configure Remote Loop-Free Alternate - Fast Reroute



### Note

- Effective with Cisco IOS Release 15.3(3)S, the Remote LFA-FRR feature is supported on CESoPSN, SAToP, and ATM/IMA.
- Effective with Cisco IOS Release 15.4(1)S, the Pseudowire Redundancy over FRR feature is supported.

This section describes how to configure Remote LFA-FRR feature:

- [Configuring Remote LFA-FRR for IS-IS, page 39-6](#) (Required)
- [Configuring Remote LFA-FRR for OSPF, page 39-9](#) (Required)
- [Configuring Remote LFA-FRR for Ethernet and TDM Pseudowires, page 39-11](#) (Required)
- [Verification Examples for Remote LFA-FRR, page 39-27](#) (Optional)

## Configuring Remote LFA-FRR for IS-IS

To configure Remote LFA-FRR for the IS-IS routing process, complete the following steps:

### SUMMARY STEPS

1. **enable**
2. **configure terminal**
3. **interface** *type number*
4. **no negotiation auto**
5. **service instance** *id* **ethernet**
6. **encapsulation dot1q** *vlan-id*
7. **rewrite ingress tag pop 1 symmetric**
8. **bridge-domain** *bridge-domain-id*
9. **interface vlan** *bridge-domain-id*
10. **ip address** *ip-address*
11. **ip router isis**
12. **mpls ip**
13. **isis network point-to-point**
14. **exit**
15. **router isis**
16. **fast-reroute per-prefix** {*level-1* | *level-2*} {*all* | **route-map** *route-map-name*}
17. **fast-reroute remote-lfa** {*level-1* | *level-2*} **mpls-ldp** [**maximum-metric** *metric-value*]
18. **mpls ldp sync**
19. **mpls ldp igp sync holddown** *milliseconds*

### DETAILED STEPS

	Command	Purpose
Step 1	<b>enable</b>  <b>Example:</b> Router> enable	Enables privileged EXEC mode. <ul style="list-style-type: none"> <li>• Enter your password if prompted.</li> </ul>
Step 2	<b>configure terminal</b>  <b>Example:</b> Router# configure terminal	Enters global configuration mode.
Step 3	<b>interface</b> <i>type number</i>  <b>Example:</b> Router(config)# interface vlan 40	Specifies an interface type and number, and enters interface configuration mode.

	Command	Purpose
Step 4	<b>no negotiation auto</b>  <b>Example:</b> Router(config-if)# no negotiation auto	Disables automatic negotiation.
Step 5	<b>service instance id ethernet</b>  <b>Example:</b> Router(config-if)# service instance 7 ethernet	Configures an Ethernet service instance on an interface. <ul style="list-style-type: none"> <li><i>id</i>—Integer that uniquely identifies a service instance on an interface.</li> </ul>
Step 6	<b>encapsulation dot1q vlan-id</b>  <b>Example:</b> Router(config-if)# encapsulation dot1q 7	Enables IEEE 802.1Q encapsulation of traffic on a specified interface in a VLAN. <ul style="list-style-type: none"> <li><i>vlan-id</i>—Virtual LAN identifier.</li> </ul>
Step 7	<b>rewrite ingress tag pop 1 symmetric</b>  <b>Example:</b> Router(config-if)# rewrite ingress tag pop 1 symmetric	Specifies the encapsulation adjustment to be performed on a frame ingressing a service instance. <ul style="list-style-type: none"> <li><b>pop</b>—Removes a tag from a packet.</li> <li><b>1</b>—Specifies the outermost tag for removal from a packet.</li> <li><b>symmetric</b>—Indicates a reciprocal adjustment to be done in the egress direction. For example, if the ingress pops a tag, the egress pushes a tag and if the ingress pushes a tag, the egress pops a tag.</li> </ul>
Step 8	<b>bridge-domain bridge-domain-id</b>  <b>Example:</b> Router(config-if)# bridge-domain 7	Enables RFC 1483 ATM bridging or RFC 1490 Frame Relay bridging to map a bridged VLAN to an ATM permanent virtual circuit (PVC) or Frame Relay data-link connection identifier (DLCI). <ul style="list-style-type: none"> <li><i>bridge-domain-id</i>—Bridge domain identifier.</li> </ul>
Step 9	<b>interface vlan bridge-domain-id</b>  <b>Example:</b> Router(config-if)# interface vlan 7	Configures an Ethernet interface to create or access a dynamic Switch Virtual Interface (SVI).
Step 10	<b>ip address ip-address</b>  <b>Example:</b> Router(config-if)# ip address 7.7.7.1 255.255.255.0	Specifies an IP address for the specified interface.
Step 11	<b>ip router isis</b>  <b>Example:</b> Router(config-if)# ip router isis	Configures an IS-IS routing process for an IP on an interface.
Step 12	<b>mpls ip</b>  <b>Example:</b> Router(config-if)# mpls ip	Enables MPLS forwarding of IPv4 packets along normally routed paths for a particular interface.

	Command	Purpose
Step 13	<b>isis network point-to-point</b>  <b>Example:</b> Router(config-if)# isis network point-to-point	Configures a network of two networking devices that use the integrated IS-IS routing protocol to function as a point-to-point link.
Step 14	<b>exit</b>  <b>Example:</b> Router(config-if)# exit	Exits the interface configuration mode and enters the global configuration mode.
Step 15	<b>router isis</b>  <b>Example:</b> Router(config)# router isis	Enables the IS-IS routing protocol and enters the router configuration mode.
Step 16	<b>fast-reroute per-prefix {level-1   level-2} {all   route-map route-map-name}</b>  <b>Example:</b> Router(config-router)# fast-reroute per-prefix level-1 all	Configures an FRR path that redirects traffic to a remote LFA tunnel for either level 1 or level 2 packets. <ul style="list-style-type: none"> <li>• <b>level-1</b>—Enables per-prefix FRR of level 1 packets.</li> <li>• <b>level-2</b>—Enables per-prefix FRR of level 2 packets.</li> <li>• <b>all</b>—Enables FRR of all primary paths.</li> <li>• <b>route-map</b>—Specifies the route map for selecting primary paths for protection.</li> <li>• <i>route-map-name</i>—Route map name.</li> </ul>
Step 17	<b>fast-reroute remote-lfa {level-1   level-2} mpls-ldp [maximum-metric metric-value]</b>  <b>Example:</b> Router(config-router)# fast-reroute remote-lfa level-1 mpls-ldp	Configures an FRR path that redirects traffic to a remote LFA tunnel. <ul style="list-style-type: none"> <li>• <b>level-1</b>—Enables LFA-FRR of level 1 packets.</li> <li>• <b>level-2</b>—Enables LFA-FRR of level 2 packets.</li> <li>• <b>mpls-ldp</b>—Specifies that the tunnel type is MPLS or LDP.</li> <li>• <b>maximum-metric</b>—(Optional) Specifies the maximum metric value required to reach the release node.</li> <li>• <i>metric-value</i>—Metric value.</li> </ul>
Step 18	<b>mpls ldp sync</b>  <b>Example:</b> Router(config-router)# mpls ldp sync	Enables MPLS LDP synchronization on interfaces for an IS-IS process.
Step 19	<b>mpls ldp igp sync holddown milliseconds</b>  <b>Example:</b> Router(config)# mpls ldp igp sync holddown 1000	Specifies how long an Interior Gateway Protocol (IGP) should wait for Label Distribution Protocol (LDP) synchronization to be achieved. <ul style="list-style-type: none"> <li>• <i>milliseconds</i>—Peer host name or IP address.</li> </ul>

## Configuring Remote LFA-FRR for OSPF

To configure Remote LFA-FRR for the OSPF routing process, complete the following steps:

### SUMMARY STEPS

1. **enable**
2. **configure terminal**
3. **interface** *type number*
4. **no negotiation auto**
5. **service instance** *id* **ethernet**
6. **encapsulation dot1q** *vlan-id*
7. **rewrite ingress tag pop 1 symmetric**
8. **bridge-domain** *bridge-domain-id*
9. **interface vlan** *bridge-domain-id*
10. **ip address** *ip-address*
11. **exit**
12. **router ospf**
13. **fast-reroute per-prefix** {*level-1* | *level-2*} {*all* | **route-map** *route-map-name*}
14. **fast-reroute remote-lfa** {*level-1* | *level-2*} **mpls-ldp** [**maximum-metric** *metric-value*]
15. **mpls ldp sync**

### DETAILED STEPS

	Command	Purpose
Step 1	<b>enable</b>  <b>Example:</b> Router> enable	Enables privileged EXEC mode. <ul style="list-style-type: none"> <li>• Enter your password if prompted.</li> </ul>
Step 2	<b>configure terminal</b>  <b>Example:</b> Router# configure terminal	Enters global configuration mode.
Step 3	<b>interface</b> <i>type number</i>  <b>Example:</b> Router(config)# interface vlan 40	Specifies an interface type and number, and enters interface configuration mode.
Step 4	<b>no negotiation auto</b>  <b>Example:</b> Router(config-if)# no negotiation auto	Disables automatic negotiation.

	Command	Purpose
Step 5	<b>service instance <i>id</i> ethernet</b>  <b>Example:</b> Router(config-if)# service instance 7 ethernet	Configures an Ethernet service instance on an interface. <ul style="list-style-type: none"> <li><i>id</i>—Integer that uniquely identifies a service instance on an interface.</li> </ul>
Step 6	<b>encapsulation dot1q <i>vlan-id</i></b>  <b>Example:</b> Router(config-if)# encapsulation dot1q 7	Enables IEEE 802.1Q encapsulation of traffic on a specified interface in a VLAN. <ul style="list-style-type: none"> <li><i>vlan-id</i>—Virtual LAN identifier.</li> </ul>
Step 7	<b>rewrite ingress tag pop 1 symmetric</b>  <b>Example:</b> Router(config-if)# rewrite ingress tag pop 1 symmetric	Specifies the encapsulation adjustment to be performed on a frame ingressing a service instance. <ul style="list-style-type: none"> <li><b>pop</b>—Removes a tag from a packet.</li> <li><b>1</b>—Specifies the outermost tag for removal from a packet.</li> <li><b>symmetric</b>—Indicates a reciprocal adjustment to be done in the egress direction. For example, if the ingress pops a tag, the egress pushes a tag and if the ingress pushes a tag, the egress pops a tag.</li> </ul>
Step 8	<b>bridge-domain <i>bridge-domain-id</i></b>  <b>Example:</b> Router(config-if)# bridge-domain 7	Enables RFC 1483 ATM bridging or RFC 1490 Frame Relay bridging to map a bridged VLAN to an ATM permanent virtual circuit (PVC) or Frame Relay data-link connection identifier (DLCI). <ul style="list-style-type: none"> <li><i>bridge-domain-id</i>—Bridge domain identifier.</li> </ul>
Step 9	<b>interface vlan <i>bridge-domain-id</i></b>  <b>Example:</b> Router(config-if)# interface vlan 7	Configures an Ethernet interface to create or access a dynamic SVI.
Step 10	<b>ip address <i>ip-address</i></b>  <b>Example:</b> Router(config-if)# ip address 7.7.7.1 255.255.255.0	Specifies an IP address for the specified interface.
Step 11	<b>exit</b>  <b>Example:</b> Router(config-if)# exit	Exits the interface configuration mode and enters the global configuration mode.
Step 12	<b>router ospf</b>  <b>Example:</b> Router(config)# router ospf	Enables the OSPF routing protocol and enters the router configuration mode.



	Command	Purpose
Step 13	<pre>fast-reroute per-prefix {level-1   level-2} {all   route-map route-map-name}</pre> <p><b>Example:</b> Router(config-router)# fast-reroute per-prefix level-1 all</p>	<p>Configures an FRR path that redirects traffic to a remote LFA tunnel for either level 1 or level 2 packets.</p> <ul style="list-style-type: none"> <li>• <b>level-1</b>—Enables per-prefix FRR of level 1 packets.</li> <li>• <b>level-2</b>—Enables per-prefix FRR of level 2 packets.</li> <li>• <b>all</b>—Enables FRR of all primary paths.</li> <li>• <b>route-map</b>—Specifies the route map for selecting primary paths for protection.</li> <li>• <i>route-map-name</i>—Route map name.</li> </ul>
Step 14	<pre>fast-reroute remote-lfa {level-1   level-2} mpls-ldp [maximum-metric metric-value]</pre> <p><b>Example:</b> Router(config-router)# fast-reroute remote-lfa level-1 mpls-ldp</p>	<p>Configures an FRR path that redirects traffic to a remote LFA tunnel.</p> <ul style="list-style-type: none"> <li>• <b>level-1</b>—Enables LFA-FRR of level 1 packets.</li> <li>• <b>level-2</b>—Enables LFA-FRR of level 2 packets.</li> <li>• <b>mpls-ldp</b>—Specifies that the tunnel type is MPLS or LDP.</li> <li>• <b>maximum-metric</b>—(Optional) Specifies the maximum metric value required to reach the release node.</li> <li>• <i>metric-value</i>—Metric value.</li> </ul>
Step 15	<pre>mpls ldp sync</pre> <p><b>Example:</b> Router(config-router)# mpls ldp sync</p>	<p>Enables MPLS LDP synchronization on interfaces for an OSPF process.</p>

## Configuring Remote LFA-FRR for Ethernet and TDM Pseudowires



### Note

The Remote LFA-FRR feature is supported on the TDM pseudowires from Cisco IOS Release 15.3(3)S onwards. The configuration and restrictions for EoMPLS are also applicable to the TDM pseudowires.



### Note

During packet loss, SAToP requires one second for convergence and two seconds for recovery.

- [Configuring Remote LFA-FRR on a Global Interface](#)
- [Configuring Remote LFA-FRR on a GigabitEthernet Interface](#)
- [Configuring Remote LFA-FRR on an SVI Interface](#)
- [Configuring Remote LFA-FRR on IS-IS](#)
- [Configuring LFA-FRR for EoMPLS](#)
- [Configuring LFA-FRR for ATM/IMA](#)
- [Configuring LFA-FRR for CESoPSN](#)
- [Configuring LFA-FRR for SAToP](#)

## Configuring Remote LFA-FRR on a Global Interface

To configure Remote LFA-FRR on a global interface, complete the following steps:

### SUMMARY STEPS

1. **enable**
2. **configure terminal**
3. **mpls label protocol ldp**
4. **no l3-over-l2 flush buffers**
5. **asr901-platf-frr enable**
6. **mpls ldp discovery targeted-hello accept**

### DETAILED STEPS

	Command	Purpose
Step 1	<b>enable</b>  <b>Example:</b> Router> enable	Enables privileged EXEC mode. <ul style="list-style-type: none"> <li>• Enter your password if prompted.</li> </ul>
Step 2	<b>configure terminal</b>  <b>Example:</b> Router# configure terminal	Enters global configuration mode.
Step 3	<b>mpls label protocol ldp</b>  <b>Example:</b> Router(config)# mpls label protocol ldp	Specifies that this LDP is the default distribution protocol.
Step 4	<b>no l3-over-l2 flush buffers</b>  <b>Example:</b> Router(config)# no l3-over-l2 flush buffers	Disables Layer 3 over Layer 2 deployments.
Step 5	<b>asr901-platf-frr enable</b>  <b>Example:</b> Router(config)# asr901-platf-frr enable	Enables TE-FRR link protection.
Step 6	<b>mpls ldp discovery targeted-hello accept</b>  <b>Example:</b> Router(config)# mpls ldp discovery targeted-hello accept	Configures the neighbors from which requests for targeted hello messages may be honored. <ul style="list-style-type: none"> <li>• <b>targeted-hello</b>—Configures the intervals and hold times for neighbors that are not directly connected.</li> <li>• <b>accept</b>—Configures the router to respond to requests for targeted hello messages from all neighbors.</li> </ul>

## Configuring Remote LFA-FRR on a GigabitEthernet Interface

To configure Remote LFA-FRR on a GigabitEthernet interface, complete the following steps:

### SUMMARY STEPS

1. **enable**
2. **configure terminal**
3. **interface** *type number*
4. **no negotiation auto**
5. **service instance** *id* **ethernet**
6. **encapsulation dot1q** *vlan-id*
7. **rewrite ingress tag pop 1 symmetric**
8. **bridge-domain** *bridge-domain-id*

### DETAILED STEPS

	Command	Purpose
Step 1	<b>enable</b>  <b>Example:</b> Router> enable	Enables privileged EXEC mode. <ul style="list-style-type: none"> <li>• Enter your password if prompted.</li> </ul>
Step 2	<b>configure terminal</b>  <b>Example:</b> Router# configure terminal	Enters global configuration mode.
Step 3	<b>interface</b> <i>type number</i>  <b>Example:</b> Router(config)# interface vlan 40	Specifies an interface type and number, and enters interface configuration mode.
Step 4	<b>no negotiation auto</b>  <b>Example:</b> Router(config-if)# no negotiation auto	Disables automatic negotiation.
Step 5	<b>service instance</b> <i>id</i> <b>ethernet</b>  <b>Example:</b> Router(config-if)# service instance 7 ethernet	Configures an Ethernet service instance on an interface. <ul style="list-style-type: none"> <li>• <i>id</i>—Integer that uniquely identifies a service instance on an interface.</li> </ul>
Step 6	<b>encapsulation dot1q</b> <i>vlan-id</i>  <b>Example:</b> Router(config-if-srv)# encapsulation dot1q 7	Enables IEEE 802.1Q encapsulation of traffic on a specified interface in a VLAN. <ul style="list-style-type: none"> <li>• <i>vlan-id</i>—Virtual LAN identifier.</li> </ul>

	Command	Purpose
Step 7	<pre>rewrite ingress tag pop 1 symmetric</pre> <p><b>Example:</b> Router(config-if-srv)# rewrite ingress tag pop 1 symmetric</p>	<p>Specifies the encapsulation adjustment to be performed on a frame ingressing a service instance.</p> <ul style="list-style-type: none"> <li>• <b>pop</b>—Removes a tag from a packet.</li> <li>• <b>1</b>—Specifies the outermost tag for removal from a packet.</li> <li>• <b>symmetric</b>—Indicates a reciprocal adjustment to be done in the egress direction. For example, if the ingress pops a tag, the egress pushes a tag and if the ingress pushes a tag, the egress pops a tag.</li> </ul>
Step 8	<pre>bridge-domain bridge-domain-id</pre> <p><b>Example:</b> Router(config-if-srv)# bridge-domain 7</p>	<p>Enables RFC 1483 ATM bridging or RFC 1490 Frame Relay bridging to map a bridged VLAN to an ATM permanent virtual circuit (PVC) or Frame Relay data-link connection identifier (DLCI).</p> <ul style="list-style-type: none"> <li>• <i>bridge-domain-id</i>—Bridge domain identifier.</li> </ul>

## Configuring Remote LFA-FRR on an SVI Interface

To configure Remote LFA-FRR on an SVI interface, complete the following steps:

### SUMMARY STEPS

1. **enable**
2. **configure terminal**
3. **interface** *type number*
4. **ip address** *ip-address*
5. **ip router isis**
6. **mpls ip**
7. **isis network point-to-point**

### DETAILED STEPS

	Command	Purpose
Step 1	<pre>enable</pre> <p><b>Example:</b> Router&gt; enable</p>	<p>Enables privileged EXEC mode.</p> <ul style="list-style-type: none"> <li>• Enter your password if prompted.</li> </ul>
Step 2	<pre>configure terminal</pre> <p><b>Example:</b> Router# configure terminal</p>	<p>Enters global configuration mode.</p>
Step 3	<pre>interface type number</pre> <p><b>Example:</b> Router(config)# interface vlan 40</p>	<p>Specifies an interface type and number, and enters interface configuration mode.</p>

	Command	Purpose
Step 4	<b>ip address</b> <i>ip-address</i>  <b>Example:</b> Router(config-if)# ip address 7.7.7.1 255.255.255.0	Specifies an IP address for the specified interface.
Step 5	<b>ip router isis</b>  <b>Example:</b> Router(config-if)# ip router isis	Configures an IS-IS routing process for an IP on an interface.
Step 6	<b>mpls ip</b>  <b>Example:</b> Router(config-if)# mpls ip	Enables MPLS forwarding of IPv4 packets along normally routed paths for a particular interface.
Step 7	<b>isis network point-to-point</b>  <b>Example:</b> Router(config-if)# isis network point-to-point	Configures a network of two networking devices that use the integrated IS-IS routing protocol to function as a point-to-point link.

## Configuring Remote LFA-FRR on IS-IS

To configure Remote LFA-FRR for the IS-IS routing process, complete the following steps:

### SUMMARY STEPS

1. **enable**
2. **configure terminal**
3. **router isis**
4. **net** *net*
5. **is-type level-1**
6. **advertise-passive-only**
7. **ispf level-1**
8. **fast-flood**
9. **max-lsp-lifetime** *seconds*
10. **lsp-refresh-interval** *seconds*
11. **spf-interval** [*level-1* | *level-2*] **spf-max-wait** [*spf-initial-wait* *spf-second-wait*]
12. **prc-interval** *prc-max-wait* [*prc-initial-wait* *prc-second-wait*]
13. **lsp-gen-interval** [*level-1* | *level-2*] *lsp-max-wait* [*lsp-initial-wait* *lsp-second-wait*]
14. **no hello padding**
15. **log-adjacency-changes**
16. **fast-reroute per-prefix level-1 all**
17. **fast-reroute remote-lfa level-1 mpls-ldp**

18. `passive-interface interface-type interface-number`
19. `mpls ldp sync`

## DETAILED STEPS

	Command	Purpose
Step 1	<code>enable</code>  <b>Example:</b> Router> enable	Enables privileged EXEC mode. <ul style="list-style-type: none"> <li>Enter your password if prompted.</li> </ul>
Step 2	<code>configure terminal</code>  <b>Example:</b> Router# configure terminal	Enters global configuration mode.
Step 3	<code>router isis</code>  <b>Example:</b> Router(config)# router isis	Enables the IS-IS routing protocol and enters the router configuration mode.
Step 4	<code>net net</code>  <b>Example:</b> Router(config-router)# net 49.0001.0002.0001.0001.00	Configures an IS-IS network entity table (NET) for the routing process.
Step 5	<code>is-type level-1</code>  <b>Example:</b> Router(config-router)# is-type level-1	Configures the routing level for an instance of the IS-IS routing process. <ul style="list-style-type: none"> <li><b>level-1</b>—Router performs only Level 1 (intra-area) routing. This router learns only about destinations inside its area.</li> </ul>
Step 6	<code>advertise-passive-only</code>  <b>Example:</b> Router(config-router)# advertise-passive-only	Configures IS-IS to advertise only prefixes that belong to passive interfaces.
Step 7	<code>ispf level-1</code>  <b>Example:</b> Router(config-router)# ispf level-1	Enables incremental shortest path first (SPF). <ul style="list-style-type: none"> <li><b>level-1</b>—Enables incremental SPF for Level 1 packets only. The level-1 keyword applies only after enabling IS-IS.</li> </ul> <p><b>Note</b> When IS-IS incremental SPF is configured on a ring topology, high convergence numbers are observed for random global prefixes. See <a href="#">CSCue11410</a> for details.</p>
Step 8	<code>fast-flood</code>  <b>Example:</b> Router(config-router)# fast-flood	Fills IS-IS link-state packets (LSPs).

	Command	Purpose
Step 9	<b>max-lsp-lifetime</b> <i>seconds</i>  <b>Example:</b> Router(config-router)# max-lsp-lifetime 65535	Configures the maximum link-state packets (LSPs) lifetime. <ul style="list-style-type: none"> <li>• <i>seconds</i>—Maximum LSP lifetime in seconds. The range is from 1 to 65535.</li> </ul>
Step 10	<b>lsp-refresh-interval</b> <i>seconds</i>  <b>Example:</b> Router(config-router)# lsp-refresh-interval 900	Sets the link-state packet (LSP) refresh interval. <ul style="list-style-type: none"> <li>• <i>seconds</i>—Interval (in seconds) at which LSPs are refreshed. The range is 1 to 65535 seconds. The default value is 900 seconds (15 minutes).</li> </ul>
Step 11	<b>spf-interval</b> [ <i>level-1</i>   <i>level-2</i> ] <i>spf-max-wait</i> [ <i>spf-initial-wait</i> <i>spf-second-wait</i> ]  <b>Example:</b> Router(config-router)# spf-interval 5 50 200	Customizes IS-IS throttling of shortest path first (SPF) calculations. <ul style="list-style-type: none"> <li>• <b>level-1</b>—(Optional) Apply intervals to Level-1 areas only.</li> <li>• <b>level-2</b>—(Optional) Apply intervals to Level-2 areas only.</li> <li>• <i>spf-max-wait</i>—Indicates the maximum interval (in seconds) between two consecutive SPF calculations. The range is 1 to 120 seconds. The default is 10 seconds.</li> <li>• <i>spf-initial-wait</i>—(Optional) Indicates the initial SPF calculation delay (in milliseconds) after a topology change. The range is 1 to 120000 milliseconds. The default is 5500 milliseconds (5.5 seconds).</li> <li>• <i>spf-second-wait</i>—(Optional) Indicates the hold time between the first and second SPF calculation (in milliseconds). The range is 1 to 120000 milliseconds. The default is 5500 milliseconds (5.5 seconds).</li> </ul>
Step 12	<b>prc-interval</b> <i>prc-max-wait</i> <i>[prc-initial-wait prc-second-wait]</i>  <b>Example:</b> Router(config-router)# prc-interval 5 50 200	Customizes IS-IS throttling of partial route calculations (PRC). <ul style="list-style-type: none"> <li>• <i>prc-max-wait</i>—Indicates the maximum interval (in seconds) between two consecutive PRC calculations. Value range is 1 to 120 seconds. The default is 5 seconds.</li> <li>• <i>prc-initial-wait</i>—(Optional) Indicates the initial PRC calculation delay (in milliseconds) after a topology change. The range is 1 to 120,000 milliseconds. The default is 2000 milliseconds.</li> <li>• <i>prc-second-wait</i>—(Optional) Indicates the hold time between the first and second PRC calculation (in milliseconds). The range is 1 to 120,000 milliseconds. The default is 5000 milliseconds (5 seconds).</li> </ul>

	Command	Purpose
Step 13	<p><b>lsp-gen-interval</b> [<b>level-1</b>   <b>level-2</b>]  <i>lsp-max-wait</i> [<i>lsp-initial-wait</i>  <i>lsp-second-wait</i>]</p> <p><b>Example:</b>  Router(config-router)#  lsp-gen-interval 5 50 200</p>	<p>Customizes IS-IS throttling of LSP generation.</p> <ul style="list-style-type: none"> <li>• <b>level-1</b>—(Optional) Apply intervals to Level-1 areas only.</li> <li>• <b>level-2</b>—(Optional) Apply intervals to Level-2 areas only.</li> <li>• <i>lsp-max-wait</i>—Indicates the maximum interval (in seconds) between two consecutive occurrences of an LSP being generated. The range is 1 to 120 seconds. The default is 5 seconds.</li> <li>• <i>lsp-initial-wait</i>—(Optional) Indicates the initial LSP generation delay (in milliseconds). The range is 1 to 120,000 milliseconds. The default is 50 milliseconds.</li> <li>• <i>lsp-second-wait</i>—(Optional) Indicates the hold time between the first and second LSP generation (in milliseconds). The range is 1 to 120,000 milliseconds. The default is 5000 milliseconds (5 seconds).</li> </ul>
Step 14	<p><b>no hello padding</b></p> <p><b>Example:</b>  Router(config-router)# no hello padding</p>	<p>Reenables IS-IS hello padding at the router level.</p>
Step 15	<p><b>log-adjacency-changes</b></p> <p><b>Example:</b>  Router(config-router)#  log-adjacency-changes</p>	<p>Configures the router to send a syslog message when an OSPF neighbor goes up or down.</p>
Step 16	<p><b>fast-reroute per-prefix</b> {<b>level-1</b>   <b>level-2</b>} {<b>all</b>   <b>route-map</b> <i>route-map-name</i>}</p> <p><b>Example:</b>  Router(config-router)# fast-reroute per-prefix level-1 all</p>	<p>Configures an FRR path that redirects traffic to a remote LFA tunnel for either level 1 or level 2 packets.</p> <ul style="list-style-type: none"> <li>• <b>level-1</b>—Enables per-prefix FRR of level 1 packets.</li> <li>• <b>level-2</b>—Enables per-prefix FRR of level 2 packets.</li> <li>• <b>all</b>—Enables FRR of all primary paths.</li> <li>• <b>route-map</b>—Specifies the route map for selecting primary paths for protection.</li> <li>• <i>route-map-name</i>—Route map name.</li> </ul>
Step 17	<p><b>fast-reroute remote-lfa</b> {<b>level-1</b>   <b>level-2</b>} <b>mpls-ldp</b> [<b>maximum-metric</b> <i>metric-value</i>]</p> <p><b>Example:</b>  Router(config-router)# fast-reroute remote-lfa level-1 mpls-ldp</p>	<p>Configures an FRR path that redirects traffic to a remote LFA tunnel.</p> <ul style="list-style-type: none"> <li>• <b>level-1</b>—Enables LFA-FRR of level 1 packets.</li> <li>• <b>level-2</b>—Enables LFA-FRR of level 2 packets.</li> <li>• <b>mpls-ldp</b>—Specifies that the tunnel type is MPLS or LDP.</li> <li>• <b>maximum-metric</b>—(Optional) Specifies the maximum metric value required to reach the release node.</li> <li>• <i>metric-value</i>—Metric value.</li> </ul>



	Command	Purpose
Step 18	<b>passive-interface</b> <i>interface-type</i> <i>interface-number</i>  <b>Example:</b> Router(config-router)# passive-interface Loopback0	Disables sending routing updates on an interface. <ul style="list-style-type: none"> <li><i>interface-type</i>—Interface type.</li> <li><i>interface-number</i>—Interface number.</li> </ul>
Step 19	<b>mpls ldp sync</b>  <b>Example:</b> Router(config-router)# mpls ldp sync	Enables MPLS LDP synchronization on interfaces for an IS-IS process.

## Configuring LFA-FRR for EoMPLS

To configure LFA-FRR for EoMPLS, complete the following steps:



### Note

Effective with Cisco IOS release 15.4(1)S, the EoMPLS Pseudowire Redundancy over FRR feature is supported.

## SUMMARY STEPS

1. **enable**
2. **configure terminal**
3. **interface** *type number*
4. **no ip address**
5. **negotiation auto**
6. **service instance** *id ethernet*
7. **encapsulation dot1q** *vlan-id*
8. **rewrite ingress tag pop 1 symmetric**
9. **xconnect** *peer-ip-address vc-id encapsulation mpls*
10. **backup peer** *peer-ip-address vc-id*

## DETAILED STEPS

	Command	Purpose
Step 1	<b>enable</b>  <b>Example:</b> Router> enable	Enables privileged EXEC mode. <ul style="list-style-type: none"> <li>Enter your password if prompted.</li> </ul>
Step 2	<b>configure terminal</b>  <b>Example:</b> Router# configure terminal	Enters global configuration mode.
Step 3	<b>interface</b> <i>type number</i>  <b>Example:</b> Router(config)# interface gigabitethernet 0/1	Specifies an interface type and number and enters interface configuration mode.
Step 4	<b>no ip address</b>  <b>Example:</b> Router(config-if)# no ip address	Removes an IP address or disables IP processing.
Step 5	<b>negotiation auto</b>  <b>Example:</b> Router(config-if)# negotiation auto	Enables automatic negotiation.
Step 6	<b>service instance</b> <i>id</i> <b>ethernet</b>  <b>Example:</b> Router(config-if)# service instance 100 ethernet	Configures an Ethernet service instance on an interface. <ul style="list-style-type: none"> <li><i>id</i>—Integer that uniquely identifies a service instance on an interface. The value varies by the platform. Range: 1 to 4294967295. The identifier need not map to a VLAN and is local in scope to the interface.</li> </ul>
Step 7	<b>encapsulation dot1q</b> <i>vlan-id</i>  <b>Example:</b> Router(config-if-srv)# encapsulation dot1q 101	Enables IEEE 802.1Q encapsulation of traffic on a specified subinterface in a VLAN. <ul style="list-style-type: none"> <li><i>vlan-id</i>—Virtual LAN identifier. The allowed range is from 1 to 4094. For the IEEE 802.1Q-in-Q VLAN Tag Termination feature, the first instance of this argument defines the outer VLAN ID, and the second and subsequent instances define the inner VLAN ID.</li> </ul>
Step 8	<b>rewrite ingress tag pop 1 symmetric</b>  <b>Example:</b> Router(config-if-srv)# rewrite ingress tag pop 1 symmetric	Specifies the encapsulation adjustment to be performed on a frame ingressing a service instance.

	Command	Purpose
Step 9	<b>xconnect</b> <i>peer-ip-address</i> <i>vc-id</i> <b>encapsulation</b> <b>mpls</b>  <b>Example:</b> Router(config-if-srv)# xconnect 10.0.0.4 4 encapsulation mpls	Binds an attachment circuit to a pseudowire, and to configure an Any Transport over MPLS (AToM) static pseudowire. <ul style="list-style-type: none"> <li>• <i>peer-ip-address</i>—IP address of the remote provider edge (PE) peer. The remote router ID can be any IP address, as long as it is reachable.</li> <li>• <i>vc-id</i>—The 32-bit identifier of the virtual circuit (VC) between the PE routers.</li> <li>• <b>encapsulation</b>—Specifies the tunneling method to encapsulate the data in the pseudowire.</li> <li>• <b>mpls</b>—Specifies Multiprotocol Label Switching (MPLS) as the tunneling method.</li> </ul>
Step 10	<b>backup peer</b> <i>peer-ip-address</i> <i>vc-id</i>  <b>Example:</b> Router(config-if-ether-vc-xconn)# backup peer 10.0.0.5 4	Specifies a redundant peer for a pseudowire VC. <ul style="list-style-type: none"> <li>• <i>peer-ip-address</i>—IP address of the remote peer.</li> </ul>

## Configuring LFA-FRR for ATM/IMA

To configure LFA-FRR for ATM/IMA, complete the following steps:



### Note

Effective with Cisco IOS release 15.4(1)S, the TDM Pseudowire Redundancy over FRR feature is supported.

## SUMMARY STEPS

1. **enable**
2. **configure terminal**
3. **controller** {*e1* | *t1*} *slot/port*
4. **ima-group** *ima-group-number*
5. **exit**
6. **interface** **ATM** *slot/IMA* *group-number*
7. **no ip address**
8. **no atm enable-ilmi-trap**
9. **pvc** *VPI/VCI* **l2transport**
10. **xconnect** *ip-address* **encapsulation** **mpls**
11. **backup peer** *peer-ip-address* *vc-id*

## DETAILED STEPS

	Command	Purpose
Step 1	<b>enable</b>  <b>Example:</b> Router> enable	Enables privileged EXEC mode. <ul style="list-style-type: none"> <li>Enter your password if prompted.</li> </ul>
Step 2	<b>configure terminal</b>  <b>Example:</b> Router# configure terminal	Enters global configuration mode.
Step 3	<b>controller {t1   e1} slot/port</b>  <b>Example:</b> Router(config)# controller e1 0/0	Selects a T1 or E1 controller and enters controller configuration mode.
Step 4	<b>ima-group ima-group-number</b>  <b>Example:</b> Router(config-controller)# ima-group 2	Assigns the interface to an IMA group. <ul style="list-style-type: none"> <li><i>ima-group-number</i>—IMA group number.</li> </ul>
Step 5	<b>exit</b>  <b>Example:</b> Router(config-controller)# exit	Exits controller configuration mode and enters global configuration mode.
Step 6	<b>interface ATM slot/IMA group-number</b>  <b>Example:</b> Router(config)# interface ATM0/IMA2	Configures inverse multiplexing over ATM (IMA) group. <ul style="list-style-type: none"> <li><i>slot</i>—Specifies the slot location of the ATM IMA port adapter.</li> <li><i>group-number</i>—Specifies the group number of the IMA group.</li> </ul>
Step 7	<b>no ip address</b>  <b>Example:</b> Router(config-if)# no ip address	Disables IP address configuration for the physical layer interface.
Step 8	<b>no atm ilmi-keepalive</b>  <b>Example:</b> Router(config-if)# no atm ilmi-keepalive	Disables the Interim Local Management Interface (ILMI) keepalive parameters.
Step 9	<b>pvc vpi/vci l2transport</b>  <b>Example:</b> Router(config-if)# pvc 90/90 l2transport	Create or assigns a name to an ATM permanent virtual circuit (PVC), to specify the encapsulation type on an ATM PVC. <ul style="list-style-type: none"> <li><i>vpi</i>—ATM network virtual path identifier (VPI) for this PVC.</li> <li><i>vci</i>—ATM network virtual channel identifier (VCI) for this PVC.</li> </ul>

	Command	Purpose
Step 10	<b>xconnect</b> <i>ip-address encapsulation mpls</i>  <b>Example:</b> Router(config-if-cem)# xconnect 2.2.2.2 111 encapsulation mpls	Binds an attachment circuit to a pseudowire, to configure an Any Transport over MPLS (AToM) static pseudowire. <ul style="list-style-type: none"> <li>• <i>ip-address</i>—IP address of the remote provider edge (PE) peer. The remote router ID can be any IP address, as long as it is reachable.</li> <li>• <b>encapsulation</b>—Specifies the tunneling method to encapsulate the data in the pseudowire.</li> <li>• <b>mpls</b>—Specifies Multiprotocol Label Switching (MPLS) as the tunneling method.</li> </ul>
Step 11	<b>backup peer</b> <i>peer-ip-address</i>  <b>Example:</b> Router(config-if-xconn)# backup peer 2.2.2.3 111	Specifies a redundant peer for a pseudowire VC. <ul style="list-style-type: none"> <li>• <i>peer-ip-address</i>—IP address of the remote peer.</li> </ul>

## Configuring LFA-FRR for CESoPSN

To configure LFA-FRR for CESoPSN, complete the following steps:



### Note

Effective with Cisco IOS release 15.4(1)S, the TDM Pseudowire Redundancy over FRR feature is supported.

## SUMMARY STEPS

1. **enable**
2. **configure terminal**
3. **controller** {**e1** | **t1**} *slot/port*
4. **clock source internal**
5. **cem-group** *group-number timeslots timeslot-range*
6. **description** *descriptive-name*
7. **exit**
8. **interface CEM** *slot/port*
9. **no ip address**
10. **cem** *group-number*
11. **xconnect** *ip-address encapsulation mpls*
12. **backup peer** *peer-ip-address*

## DETAILED STEPS

	Command	Purpose
Step 1	<b>enable</b>  <b>Example:</b> Router> enable	Enables privileged EXEC mode. <ul style="list-style-type: none"> <li>Enter your password if prompted.</li> </ul>
Step 2	<b>configure terminal</b>  <b>Example:</b> Router# configure terminal	Enters global configuration mode.
Step 3	<b>controller {t1   e1} slot/port</b>  <b>Example:</b> Router(config)# controller e1 0/0	Selects a T1 or E1 controller and enters controller configuration mode.
Step 4	<b>clock source internal</b>  <b>Example:</b> Router(config-controller)# clock source internal	Sets clocking for individual links.
Step 5	<b>cem-group group-number timeslots timeslot-range</b>  <b>Example:</b> Router(config-controller)# cem-group 0 timeslots 1-31	Assigns channels on the T1 or E1 circuit to the circuit emulation (CEM) channel and specific timeslots to the CEM channel. <ul style="list-style-type: none"> <li><i>group-number</i>—Channel number to be used for this group of time slots.</li> <li><b>timeslot</b>—Specifies that a list of time slots is to be used as specified by the <i>timeslot-range</i> argument.</li> <li><i>timeslot-range</i>—List of the time slots to be included in the CEM channel. The list may include commas and hyphens with no spaces between the numbers.</li> </ul>
Step 6	<b>description descriptive-name</b>  <b>Example:</b> Router(config-controller)# description E1 CESoPSN example	Specifies a descriptive name for the controller.
Step 7	<b>exit</b>  <b>Example:</b> Router(config)# exit	Exits global configuration mode.
Step 8	<b>interface CEM slot/port</b>  <b>Example:</b> Router(config)# interface CEM 0/0	Defines a CEM channel.

	Command	Purpose
Step 9	<b>no ip address</b>  <b>Example:</b> Router(config-cem)# no ip address	Removes an IP address or disables IP processing.
Step 10	<b>cem group-number</b>  <b>Example:</b> Router(config-cem)# cem 0	Defines a CEM channel.
Step 11	<b>xconnect ip-address encapsulation mpls</b>  <b>Example:</b> Router(config-cem)# xconnect 2.2.2.2 111 encapsulation mpls	Binds an attachment circuit to a pseudowire, to configure an Any Transport over MPLS (AToM) static pseudowire. <ul style="list-style-type: none"> <li>• <i>ip-address</i>—IP address of the remote provider edge (PE) peer. The remote router ID can be any IP address, as long as it is reachable.</li> <li>• <b>encapsulation</b>—Specifies the tunneling method to encapsulate the data in the pseudowire.</li> <li>• <b>mpls</b>—Specifies Multiprotocol Label Switching (MPLS) as the tunneling method.</li> </ul>
Step 12	<b>backup peer peer-ip-address</b>  <b>Example:</b> Router(config-if-xconn)# backup peer 2.2.2.3 111	Specifies a redundant peer for a pseudowire VC. <ul style="list-style-type: none"> <li>• <i>peer-ip-address</i>—IP address of the remote peer.</li> </ul>

## Configuring LFA-FRR for SAToP

To configure LFA-FRR for SAToP, complete the following steps:



### Note

Effective with Cisco IOS release 15.4(1)S, the TDM Pseudowire Redundancy over FRR feature is supported.

## SUMMARY STEPS

1. **enable**
2. **configure terminal**
3. **controller {e1 | t1} slot/port**
4. **framing unframed**
5. **clock source internal**
6. **cem-group group-number unframed**
7. **description descriptive-name**
8. **exit**
9. **interface CEM slot/port**

10. **no ip address**
11. **cem group-number**
12. **xconnect ip-address encapsulation mpls**
13. **backup peer peer-ip-address**

## DETAILED STEPS

	Command	Purpose
Step 1	<b>enable</b>  <b>Example:</b> Router> enable	Enables privileged EXEC mode. <ul style="list-style-type: none"> <li>• Enter your password if prompted.</li> </ul>
Step 2	<b>configure terminal</b>  <b>Example:</b> Router# configure terminal	Enters global configuration mode.
Step 3	<b>controller {t1   e1} slot/port</b>  <b>Example:</b> Router(config)# controller e1 0/0	Selects a T1 or E1 controller and enters controller configuration mode.
Step 4	<b>framing unframed</b>  <b>Example:</b> Router(config-controller)# framing unframed	Specifies the framing format of a circuit emulation (CEM) T1 or E1 port.
Step 5	<b>clock source internal</b>  <b>Example:</b> Router(config-controller)# clock source internal	Sets clocking for individual T1 or E1 links.
Step 6	<b>cem-group group-number unframed</b>  <b>Example:</b> Router(config-controller)# cem-group 0 unframed	Assigns channels on the T1 or E1 circuit to the CEM channel. <ul style="list-style-type: none"> <li>• <i>group-number</i>—Channel number to be used for this group of time slots.</li> <li>• <b>unframed</b>—Specifies that a single CEM channel is being created including all time slots and the framing structure of the line.</li> </ul>
Step 7	<b>description descriptive-name</b>  <b>Example:</b> Router(config-controller)# description E1 SAToP example	Specifies a descriptive name for the controller
Step 8	<b>exit</b>  <b>Example:</b> Router(config-controller)# exit	Exits controller configuration mode.



	Command	Purpose
Step 9	<code>interface CEM slot/port</code>  <b>Example:</b> Router(config)# interface CEM 0/0	Defines a CEM channel.
Step 10	<code>no ip address</code>  <b>Example:</b> Router(config-if)# no ip address	Removes an IP address or disables IP processing.
Step 11	<code>cem group-number</code>  <b>Example:</b> Router(config-if)# cem 0	Defines a CEM channel.
Step 12	<code>xconnect ip-address encapsulation mpls</code>  <b>Example:</b> Router(config-if-cem)# xconnect 2.2.2.2 111 encapsulation mpls	Binds an attachment circuit to a pseudowire, to configure an Any Transport over MPLS (AToM) static pseudowire. <ul style="list-style-type: none"> <li>• <i>ip-address</i>—IP address of the remote provider edge (PE) peer. The remote router ID can be any IP address, as long as it is reachable.</li> <li>• <b>encapsulation</b>—Specifies the tunneling method to encapsulate the data in the pseudowire.</li> <li>• <b>mpls</b>—Specifies Multiprotocol Label Switching (MPLS) as the tunneling method.</li> </ul>
Step 13	<code>backup peer peer-ip-address</code>  <b>Example:</b> Router(config-if-cem-xconn)# backup peer 2.2.2.3 111	Specifies a redundant peer for a pseudowire VC. <ul style="list-style-type: none"> <li>• <i>peer-ip-address</i>—IP address of the remote peer.</li> </ul>

## Verification Examples for Remote LFA-FRR

- [Verifying Remote LFA-FRR Configuration, page 39-28](#)
- [Verifying Remote LFA-FRR Configuration for EoMPLS on a GigabitEthernet Interface, page 39-30](#)
- [Verifying Remote LFA-FRR Configuration for EoMPLS on an EVC Interface, page 39-32](#)
- [Verifying Remote LFA-FRR Configuration on IS-IS, page 39-33](#)
- [Verifying Remote LFA-FRR Configuration on ATM/IMA, page 39-33](#)
- [Verifying Remote LFA-FRR Configuration on CESoPSN, page 39-34](#)
- [Verifying Remote LFA-FRR Configuration on SAToP, page 39-35](#)

## Verifying Remote LFA-FRR Configuration

To verify the remote LFA-FRR configuration, use the **show** commands described in the following examples.

To display information for an OSPF per-prefix LFA-FRR configuration, use the following **show** command.

```
Router# show ip ospf fast-reroute remote-lfa tunnels

      OSPF Router with ID (1.1.1.1) (Process ID 1)

                Area with ID (0)

                Base Topology (MTID 0)

Interface MPLS-Remote-Lfa5
  Tunnel type: MPLS-LDP
  Tailend router ID: 5.5.5.5
  Termination IP address: 5.5.5.5
  Outgoing interface: Vlan4004
  First hop gateway: 71.14.1.4
  Tunnel metric: 2
  Protects:
    71.17.1.7 Vlan4003, total metric 4

Interface MPLS-Remote-Lfa6
  Tunnel type: MPLS-LDP
  Tailend router ID: 6.6.6.6
  Termination IP address: 6.6.6.6
  Outgoing interface: Vlan4003
  First hop gateway: 71.17.1.7
  Tunnel metric: 2
  Protects:
    71.14.1.4 Vlan4004, total metric 4
```

To display entries in the Cisco Express Forwarding (CEF) Forwarding Information Base (FIB), use the following **show** command.

```
Router# show ip cef 171.1.1.0 internal

171.1.1.0/24, epoch 0, RIB[I], refcount 5, per-destination sharing
sources: RIB, LTE
feature space:
  IPRM: 0x00028000
  LFD: 171.1.1.0/24 1 local label
  local label info: global/542
    contains path extension list
    disposition chain 0x12E83850
    label switch chain 0x12E83850
ifnums:
  Vlan4004(30): 71.14.1.4
  MPLS-Remote-Lfa6(37)
  path 12C70E98, path list 12D52154, share 1/1, type attached nexthop, for IPv4, flags
has-repair
  MPLS short path extensions: MOI flags = 0x20 label 31
  nexthop 71.14.1.4 Vlan4004 label [31|537], adjacency IP adj out of Vlan4004, addr
71.14.1.4 12CD6A40
  repair: attached-nexthop 6.6.6.6 MPLS-Remote-Lfa6 (12C70FE8)
  path 12C70FE8, path list 12D52154, share 1/1, type attached nexthop, for IPv4, flags
repair, repair-only
```

```

nexthop 6.6.6.6 MPLS-Remote-Lfa6, repair, adjacency IP midchain out of MPLS-Remote-Lfa6
12CD7880
output chain: label [31|537]
FRR Primary (0x11139020)
<primary: TAG adj out of Vlan4004, addr 71.14.1.4 12D8A780>
<repair: TAG midchain out of MPLS-Remote-Lfa6 12CD6580 label 338 TAG adj out of
Vlan4003, addr 71.17.1.7 12CD7160>

```

To display local Routing Information Base (RIB) or locally redistributed routes use the following **show** command.

```

Router# show ip ospf rib 171.1.1.0

          OSPF Router with ID (1.1.1.1) (Process ID 1)

          Base Topology (MTID 0)

OSPF local RIB
Codes: * - Best, > - Installed in global RIB
LSA: type/LSID/originator

*> 171.1.1.0/24, Intra, cost 2, area 0
    SPF Instance 130, age 00:03:52
    Flags: RIB, iSPF
    via 71.14.1.4, Vlan4004
    Flags: RIB, iSPF
    LSA: 1/2.0.0.2/2.0.0.2
    repair path via 6.6.6.6, MPLS-Remote-Lfa6, cost 4
    Flags: RIB, Repair, Intfdj, BcastDj, CostWon
    LSA: 1/2.0.0.2/2.0.0.2

```

To display information for an IS-IS per-prefix LFA-FRR configuration, use the following **show** command.

```

Router# show isis fast-reroute remote-lfa tunnels

Tag Null - Fast-Reroute Remote-LFA Tunnels:

MPLS-Remote-Lfa1: use V14003, nexthop 71.17.1.7, end point 6.6.6.6
MPLS-Remote-Lfa2: use V14004, nexthop 71.14.1.4, end point 5.5.5.5

```

To display entries in the CEF Forwarding Information Base (FIB) use the following **show** command.

```

Router# show ip cef 171.1.1.0 internal

171.1.1.0/24, epoch 0, RIB[I], refcount 5, per-destination sharing
sources: RIB, LTE
feature space:
  IPRM: 0x00028000
  LFD: 171.1.1.0/24 1 local label
  local label info: global/18
    contains path extension list
    disposition chain 0x12B537C8
ifnums:
  Vlan4004(30): 71.14.1.4
  MPLS-Remote-Lfa1(32)
  path 12C55CB4, path list 12C856E8, share 1/1, type attached nexthop, for IPv4, flags
has-repair
  MPLS short path extensions: MOI flags = 0x20 label none
  nexthop 71.14.1.4 Vlan4004 label [none|23], adjacency IP adj out of Vlan4004, addr
71.14.1.4 1139FAA0

```

```

repair: attached-nexthop 6.6.6.6 MPLS-Remote-Lfa1 (12C55D24)
path 12C55D24, path list 12C856E8, share 1/1, type attached nexthop, for IPv4, flags
repair, repair-only
nexthop 6.6.6.6 MPLS-Remote-Lfa1, repair, adjacency IP midchain out of MPLS-Remote-Lfa1
12D512C0
output chain: label [none|23]
FRR Primary (0xA74F800)
<primary: IP adj out of Vlan4004, addr 71.14.1.4 1139FAA0>
<repair: TAG midchain out of MPLS-Remote-Lfa1 11180740 label 366 TAG adj out of
Vlan4003, addr 71.17.1.7 12D51520>

```

To display information about IS-IS FRR configurations, use the following **show** command.

```
Router# show isis fast-reroute summary
```

```

Tag null:
IPv4 Fast-Reroute Protection Summary:

Prefix Counts:          Total      Protected   Coverage
High priority:          0         0           0%
Normal priority:        10        8           80%
Total:                   10        8           80%

```

To display paths for a specific route or for all routes under a major network that are stored in the IP local Routing Information Base (RIB), use the following **show** command.

```
Router# show isis rib 171.1.1.0
```

```

IPv4 local RIB for IS-IS process

IPV4 unicast topology base (TID 0, TOPOID 0x0) =====
Repair path attributes:
  DS - Downstream, LC - Linecard-Disjoint, NP - Node-Protecting
  PP - Primary-Path, SR - SRLG-Disjoint

Routes under majornet 171.1.0.0/16:

171.1.1.0/24
  [115/L1/10] via 71.14.1.4(Vlan4004), from 71.14.1.4, tag 0, LSP[2/18]
  (installed)
  repair path: 6.6.6.6(MPLS-Remote-Lfa1) metric:20 (DS,SR) LSP[2]

```

## Verifying Remote LFA-FRR Configuration for EoMPLS on a GigabitEthernet Interface

To verify the remote LFA-FRR configuration for EoMPLS on a GigabitEthernet interface, use the **show** commands described in the following examples.

```
Router# show mpls l2transport vc 1 detail
```

```

Local interface: Gi0/0 up, line protocol up, Ethernet up
Destination address: 3.3.3.3, VC ID: 1, VC status: up
Output interface: Vl4000, imposed label stack {18 16}
Preferred path: not configured
Default path: active
Next hop: 71.12.1.2
Create time: 00:00:06, last status change time: 00:00:06
Last label FSM state change time: 00:00:06
Signaling protocol: LDP, peer 3.3.3.3:0 up
Targeted Hello: 1.1.1.1(LDP Id) -> 3.3.3.3, LDP is UP
Graceful restart: not configured and not enabled
Non stop routing: not configured and not enabled

```

```

Status TLV support (local/remote) : enabled/supported
LDP route watch                   : enabled
Label/status state machine        : established, LruRru
Last local dataplane status rcvd: No fault
Last BFD dataplane status rcvd: Not sent
Last BFD peer monitor status rcvd: No fault
Last local AC circuit status rcvd: No fault
Last local AC circuit status sent: No fault
Last local PW i/f circ status rcvd: No fault
Last local LDP TLV status sent: No fault
Last remote LDP TLV status rcvd: No fault
Last remote LDP ADJ status rcvd: No fault
MPLS VC labels: local 323, remote 16
Group ID: local 0, remote 0
MTU: local 1500, remote 1500
Remote interface description:
Sequencing: receive disabled, send disabled
Control Word: On (configured: autosense)
Dataplane:
SSM segment/switch IDs: 4801/4799 (used), PWID: 1
VC statistics:
transit packet totals: receive 0, send 1009697
transit byte totals: receive 0, send 96933706
transit packet drops: receive 0, seq error 0, send 0

Local interface: Gi0/0 up, line protocol up, Ethernet up
Destination address: 4.4.4.4, VC ID: 1, VC status: standby
Output interface: V14000, imposed label stack {21 16}
Preferred path: not configured
Default path: active
Next hop: 71.12.1.2
Create time: 00:00:06, last status change time: 00:16:44
Last label FSM state change time: 00:00:06
Signaling protocol: LDP, peer 4.4.4.4:0 up
Targeted Hello: 1.1.1.1(LDP Id) -> 4.4.4.4, LDP is UP
Graceful restart: not configured and not enabled
Non stop routing: not configured and not enabled
Status TLV support (local/remote) : enabled/supported
LDP route watch                   : enabled
Label/status state machine        : established, LrdRru
Last local dataplane status rcvd: No fault
Last BFD dataplane status rcvd: Not sent
Last BFD peer monitor status rcvd: No fault
Last local AC circuit status rcvd: DOWN(standby)
Last local AC circuit status sent: No fault
Last local PW i/f circ status rcvd: No fault
Last local LDP TLV status sent: DOWN(standby)
Last remote LDP TLV status rcvd: No fault
Last remote LDP ADJ status rcvd: No fault
MPLS VC labels: local 324, remote 16
Group ID: local 0, remote 0
MTU: local 1500, remote 1500
Remote interface description:
Sequencing: receive disabled, send disabled
Control Word: On (configured: autosense)
Dataplane:
SSM segment/switch IDs: 8898/8896 (used), PWID: 2
VC statistics:
transit packet totals: receive 0, send 0
transit byte totals: receive 0, send 0
transit packet drops: receive 0, seq error 0, send 0

```

## Verifying Remote LFA-FRR Configuration for EoMPLS on an EVC Interface

To verify the remote LFA-FRR configuration for EoMPLS on an EVC interface, use the **show** commands described in the following examples.

```
Router# show mpls l2transport vc 3001 detail

Local interface: Gi0/0 up, line protocol up, Eth VLAN 200 up
  Interworking type is Ethernet
  Destination address: 3.3.3.3, VC ID: 1, VC status: up
  Output interface: Vl4000, imposed label stack {18 16}
  Preferred path: not configured
  Default path: active
  Next hop: 71.12.1.2
  Create time: 00:13:47, last status change time: 00:04:20
  Last label FSM state change time: 00:11:54
  Signaling protocol: LDP, peer 3.3.3.3:0 up
  Targeted Hello: 1.1.1.1(LDP Id) -> 3.3.3.3, LDP is UP
  Graceful restart: not configured and not enabled
  Non stop routing: not configured and not enabled
  Status TLV support (local/remote) : enabled/supported
  LDP route watch : enabled
  Label/status state machine : established, LruRru
  Last local dataplane status rcvd: No fault
  Last BFD dataplane status rcvd: Not sent
  Last BFD peer monitor status rcvd: No fault
  Last local AC circuit status rcvd: No fault
  Last local AC circuit status sent: No fault
  Last local PW i/f circ status rcvd: No fault
  Last local LDP TLV status sent: No fault
  Last remote LDP TLV status rcvd: No fault
  Last remote LDP ADJ status rcvd: No fault
  MPLS VC labels: local 16, remote 16
  Group ID: local 0, remote 0
  MTU: local 1500, remote 1500
  Remote interface description:
  MAC Withdraw: sent:1, received:0
  Sequencing: receive disabled, send disabled
  Control Word: On (configured: autosense)
  Dataplane:
  SSM segment/switch IDs: 1434251/4096 (used), PWID: 1
  VC statistics:
  transit packet totals: receive 0, send 260970
  transit byte totals: receive 0, send 24009240
  transit packet drops: receive 0, seq error 0, send 0

Local interface: Gi0/0 up, line protocol up, Eth VLAN 200 up
  Interworking type is Ethernet
  Destination address: 4.4.4.4, VC ID: 1, VC status: standby
  Output interface: Vl4000, imposed label stack {21 16}
  Preferred path: not configured
  Default path: active
  Next hop: 71.12.1.2
  Create time: 00:13:47, last status change time: 00:14:41
  Last label FSM state change time: 00:12:47
  Signaling protocol: LDP, peer 4.4.4.4:0 up
  Targeted Hello: 1.1.1.1(LDP Id) -> 4.4.4.4, LDP is UP
  Graceful restart: not configured and not enabled
  Non stop routing: not configured and not enabled
  Status TLV support (local/remote) : enabled/supported
  LDP route watch : enabled
  Label/status state machine : established, LrdRru
  Last local dataplane status rcvd: No fault
```

```

Last BFD dataplane      status rcvd: Not sent
Last BFD peer monitor  status rcvd: No fault
Last local AC circuit  status rcvd: DOWN(standby)
Last local AC circuit  status sent: No fault
Last local PW i/f circ status rcvd: No fault
Last local LDP TLV     status sent: DOWN(standby)
Last remote LDP TLV    status rcvd: No fault
Last remote LDP ADJ    status rcvd: No fault
MPLS VC labels: local 17, remote 16
Group ID: local 0, remote 0
MTU: local 1500, remote 1500
Remote interface description:
MAC Withdraw: sent:1, received:0
Sequencing: receive disabled, send disabled
Control Word: On (configured: autosense)
Dataplane:
  SSM segment/switch IDs: 885253/8193 (used), PWID: 2
VC statistics:
transit packet totals: receive 0, send 0
transit byte totals:  receive 0, send 0
transit packet drops:  receive 0, seq error 0, send 0

```

## Verifying Remote LFA-FRR Configuration on IS-IS

To verify the remote LFA-FRR configuration on IS-IS, use the **show** commands described in the following examples.

```
Router# show isis fast-reroute remote-lfa tunnels
```

```
Tag agg - Fast-Reroute Remote-LFA Tunnels:
```

```
No Remote-LFA tunnel
```

```
Tag Null - Fast-Reroute Remote-LFA Tunnels:
```

```
No Remote-LFA tunnel
```

```
Tag agg - Fast-Reroute Remote-LFA Tunnels:
```

```
MPLS-Remote-Lfa5: use V127, nexthop 27.27.27.2, end point 192.168.1.2
MPLS-Remote-Lfa6: use V150, nexthop 50.50.50.2, end point 192.168.1.2
```

## Verifying Remote LFA-FRR Configuration on ATM/IMA

To verify the remote LFA-FRR configuration on ATM/IMA, use the **show** commands described in the following example.

```
Router# show mpls 12 vc 90 detail
```

```

Local interface: AT0/IMA2 up, line protocol up, ATM AAL5 90/90 Basic 1 up
  Destination address: 2.2.2.2, VC ID: 111, VC status: up
  Output interface: Vlan300, imposed label stack {29 32}
  Preferred path: not configured
  Default path: active
  Next hop: point2point
  Create time: 17:54:25, last status change time: 17:54:25
  Last label FSM state change time: 17:54:25
  Signaling protocol: LDP, peer 2.2.2.2:0 up
  Targeted Hello: 170.0.0.201(LDP Id) -> 2.2.2.2, LDP is UP

```

```

Graceful restart: not configured and not enabled
Non stop routing: not configured and not enabled
Status TLV support (local/remote)   : enabled/supported
  LDP route watch                    : enabled
  Label/status state machine         : established, LruRru
  Last local dataplane status rcvd: No fault
  Last BFD dataplane status rcvd: Not sent
  Last BFD peer monitor status rcvd: No fault
  Last local AC circuit status rcvd: No fault
  Last local AC circuit status sent: No fault
  Last local PW i/f circ status rcvd: No fault
  Last local LDP TLV status sent: No fault
  Last remote LDP TLV status rcvd: No fault
  Last remote LDP ADJ status rcvd: No fault
MPLS VC labels: local 20, remote 32
Group ID: local 0, remote 0
MTU: local 0, remote 0
Remote interface description:
Sequencing: receive disabled, send disabled
Control Word: On (configured: autosense)

```

## Verifying Remote LFA-FRR Configuration on CESoPSN

To verify the remote LFA-FRR configuration on CESoPSN, use the **show** commands described in the following example.

```
Router# show mpls 12 vc 111 detail
```

```

Local interface: CE0/0 up, line protocol up, CESoPSN Basic 1 up
Destination address: 2.2.2.2, VC ID: 111, VC status: up
  Output interface: Vlan300, imposed label stack {29 32}
  Preferred path: not configured
  Default path: active
  Next hop: point2point
Create time: 17:54:25, last status change time: 17:54:25
  Last label FSM state change time: 17:54:25
Signaling protocol: LDP, peer 2.2.2.2:0 up
Targeted Hello: 170.0.0.201(LDP Id) -> 2.2.2.2, LDP is UP
Graceful restart: not configured and not enabled
Non stop routing: not configured and not enabled
Status TLV support (local/remote)   : enabled/supported
  LDP route watch                    : enabled
  Label/status state machine         : established, LruRru
  Last local dataplane status rcvd: No fault
  Last BFD dataplane status rcvd: Not sent
  Last BFD peer monitor status rcvd: No fault
  Last local AC circuit status rcvd: No fault
  Last local AC circuit status sent: No fault
  Last local PW i/f circ status rcvd: No fault
  Last local LDP TLV status sent: No fault
  Last remote LDP TLV status rcvd: No fault
  Last remote LDP ADJ status rcvd: No fault
MPLS VC labels: local 20, remote 32
Group ID: local 0, remote 0
MTU: local 0, remote 0
Remote interface description:
Sequencing: receive disabled, send disabled
Control Word: On (configured: autosense)
Dataplane:
  SSM segment/switch IDs: 4124/8219 (used), PWID: 4
VC statistics:

```



```
transit packet totals: receive 64465447, send 64465519
transit byte totals:   receive 15987430856, send 15987448712
transit packet drops:  receive 0, seq error 0, send 0
```

## Verifying Remote LFA-FRR Configuration on SAToP

To verify the remote LFA-FRR configuration on SAToP, use the **show** commands described in the following example.

```
Router# show mpls 12 vc 111 detail

Local interface: CE0/0 up, line protocol up, SATOP Basic 1 up
  Destination address: 2.2.2.2, VC ID: 111, VC status: up
  Output interface: Vlan300, imposed label stack {29 32}
  Preferred path: not configured
  Default path: active
  Next hop: point2point
  Create time: 17:54:25, last status change time: 17:54:25
  Last label FSM state change time: 17:54:25
  Signaling protocol: LDP, peer 2.2.2.2:0 up
  Targeted Hello: 170.0.0.201(LDP Id) -> 2.2.2.2, LDP is UP
  Graceful restart: not configured and not enabled
  Non stop routing: not configured and not enabled
  Status TLV support (local/remote)   : enabled/supported
    LDP route watch                    : enabled
    Label/status state machine         : established, LruRru
  Last local dataplane status rcvd: No fault
  Last BFD dataplane status rcvd: Not sent
  Last BFD peer monitor status rcvd: No fault
  Last local AC circuit status rcvd: No fault
  Last local AC circuit status sent: No fault
  Last local PW i/f circ status rcvd: No fault
  Last local LDP TLV status sent: No fault
  Last remote LDP TLV status rcvd: No fault
  Last remote LDP ADJ status rcvd: No fault
  MPLS VC labels: local 20, remote 32
  Group ID: local 0, remote 0
  MTU: local 0, remote 0
  Remote interface description:
  Sequencing: receive disabled, send disabled
  Control Word: On (configured: autosense)
```

## Configuration Examples for Remote LFA-FRR

This section provides sample configuration examples for Remote LFA-FRR feature on the Cisco ASR 901 router.

- [Example: Configuring Remote LFA-FRR for IS-IS, page 39-36](#)
- [Example: Configuring Remote LFA-FRR for OSPF, page 39-36](#)
- [Example: Configuring Remote LFA-FRR Globally, page 39-36](#)
- [Example: Configuring Remote LFA-FRR on a GigabitEthernet Interface, page 39-37](#)
- [Example: Configuring Remote LFA-FRR on an SVI Interface, page 39-37](#)
- [Example: Configuring EoMPLS Pseudowire Redundancy over FRR, page 39-37](#)

- [Example: Configuring LFA-FRR on ATM/IMA, page 39-37](#)
- [Example: Configuring LFA-FRR on CESoPSN, page 39-38](#)
- [Example: Configuring LFA-FRR on SAToP, page 39-38](#)

## Example: Configuring Remote LFA-FRR for IS-IS

The following is a sample configuration of Remote LFA-FRR for IS-IS on all nodes.

```

!
mpls label protocol ldp
mpls ldp router-id lo0 force
mpls ldp discovery targeted-hello accept
no l3-over-12 flush buffers
asr901-platf-frr enable

router isis
metric-style wide
fast-flood
max-lsp-lifetime 65535
lsp-refresh-interval 65000
spf-interval 5 50 200
prc-interval 5 50 200
lsp-gen-interval 5 50 200
no hello padding
log-adjacency-changes all
fast-reroute per-prefix level-1 all
fast-reroute remote-lfa level-1 mpls-ldp
mpls ldp sync
!

```

## Example: Configuring Remote LFA-FRR for OSPF

The following is a sample configuration of Remote LFA-FRR for OSPF on all nodes.

```

!
mpls label protocol ldp
mpls ldp router-id lo0 force
mpls ldp discovery targeted-hello accept
no l3-over-12 flush buffers
asr901-platf-frr enable

router ospf 1
router-id 5.5.5.5
fast-reroute per-prefix enable area 0 prefix-priority low
fast-reroute per-prefix remote-lfa tunnel mpls-ldp
timers throttle spf 50 200 5000
timers throttle lsa 50 200 5000
timers lsa arrival 100
mpls ldp sync
!

```

## Example: Configuring Remote LFA-FRR Globally

The following is a sample configuration of Remote LFA-FRR at a global level.

```

!
mpls label protocol ldp

```

```
mpls ldp discovery targeted-hello accept
no l3-over-l2 flush buffers
asr901-platf-frr enable
!
```

## Example: Configuring Remote LFA-FRR on a GigabitEthernet Interface

The following is a sample configuration of Remote LFA-FRR on a GigabitEthernet Interface.

```
!
interface GigabitEthernet0/7
no ip address
negotiation auto
service instance 7 ethernet
encapsulation dot1q 7
rewrite ingress tag pop 1 symmetric
bridge-domain 7
!
```

## Example: Configuring Remote LFA-FRR on an SVI Interface

The following is a sample configuration of Remote LFA-FRR on an SVI Interface.

```
!
interface Vlan7
ip address 7.7.7.2 255.255.25
ip router isis
mpls ip
isis network point-to-point
!
```

## Example: Configuring EoMPLS Pseudowire Redundancy over FRR

The following is a sample configuration of EoMPLS pseudowire redundancy over FRR.

```
!
interface GigabitEthernet0/0
no ip address
load-interval 30
negotiation auto
service instance 1 ethernet
encapsulation dot1q 200
rewrite ingress tag pop 1 symmetric
xconnect 3.3.3.3 1 encapsulation mpls
backup peer 4.4.4.4 1
mtu 1500
!
```

## Example: Configuring LFA-FRR on ATM/IMA

The following is a sample configuration of LFA-FRR on ATM/IMA, which also includes pseudowire redundancy.

```
!
controller E1 0/0
```

```

ima-group 2

!
interface ATM0/IMA1
no ip address
no atm enable-ilmi-trap
xconnect 2.2.2.2 90 encapsulation mpls
backup peer 180.0.0.201 90
!

```

## Example: Configuring LFA-FRR on CESoPSN

The following is a sample configuration of LFA-FRR on CESoPSN, which also includes pseudowire redundancy.

```

!
controller E1 0/0
clock source internal
cem-group 0 timeslots 1-31
description E1 CESoPSN example
!
!
interface CEM0/2
no ip address
cem 1
xconnect 2.2.2.2 111 encapsulation mpls pw-class test
backup peer 180.0.0.201 111
!

```

## Example: Configuring LFA-FRR on SAToP

The following is a sample configuration of LFA-FRR on SAToP, which also includes pseudowire redundancy.

```

!
controller E1 0/0
clock source internal
cem-group 1 unframed
description E1 SATOP example
!
interface CEM0/0
no ip address
cem 0
xconnect 2.2.2.2 111 encapsulation mpls
backup peer 180.0.0.201 111
!
!

```

# Additional References

The following sections provide references related to Remote Loop-Free Alternate - Fast Reroute feature.

## Related Documents

Related Topic	Document Title
Cisco IOS Commands	<a href="#">Cisco IOS Master Commands List, All Releases</a>
Cisco ASR 901 Router Commands	<a href="#">Cisco ASR 901 Series Aggregation Services Router Command Reference</a>
IS-IS Remote LFA FRR	<a href="#">IS-IS Remote Loop-Free Alternate Fast Reroute</a>
OSPFv2 LFA FRR	<a href="#">OSPFv2 Loop-Free Alternate Fast Reroute</a>

## Standards

Standard	Title
None	—

## MIBs

MIB	MIBs Link
None	To locate and download MIBs for selected platforms, Cisco IOS releases, and feature sets, use Cisco MIB Locator found at the following URL: <a href="http://www.cisco.com/go/mibs">http://www.cisco.com/go/mibs</a>

## RFCs

RFC	Title
None	—

## Technical Assistance

Description	Link
The Cisco Technical Support website contains thousands of pages of searchable technical content, including links to products, technologies, solutions, technical tips, and tools. Registered Cisco.com users can log in from this page to access even more content.	<a href="http://www.cisco.com/techsupport">http://www.cisco.com/techsupport</a>

# Feature Information for Remote Loop-Free Alternate - Fast Reroute

Table 39-1 lists the features in this module and provides links to specific configuration information.

Use Cisco Feature Navigator to find information about platform support and software image support. Cisco Feature Navigator enables you to determine which software images support a specific software release, feature set, or platform. To access Cisco Feature Navigator, go to <http://www.cisco.com/go/cfn>. An account on Cisco.com is not required.



## Note

Table 39-1 lists only the software release that introduced support for a given feature in a given software release train. Unless noted otherwise, subsequent releases of that software release train also support that feature.

**Table 39-1** Feature Information for Remote Loop-Free Alternate - Fast Reroute

Feature Name	Releases	Feature Information
Remote Loop-Free Alternate - Fast Reroute	15.2(2)SNI	This feature was introduced on the Cisco ASR 901 routers. The following sections provide information about this feature: <ul style="list-style-type: none"> <li>• <a href="#">Feature Overview, page 39-3</a></li> <li>• <a href="#">How to Configure Remote Loop-Free Alternate - Fast Reroute, page 39-5</a></li> </ul>
Remote Loop-Free Alternate - Fast Reroute for EoMPLS	15.3(2)S	This feature was introduced on the Cisco ASR 901 routers. The following section provides information about this feature: <ul style="list-style-type: none"> <li>• <a href="#">Configuring Remote LFA-FRR for Ethernet and TDM Pseudowires, page 39-11</a></li> </ul>
Remote Loop-Free Alternate - Fast Reroute for TDM Pseudowires.	15.3(3)S	Support for TDM Pseudowires was added.
EoMPLS Pseudowire Redundancy over FRR	15.4(1)S	Support was added for EoMPLS pseudowire redundancy over FRR.
TDM Pseudowire Redundancy over FRR	15.4(1)S	Support was added for TDM pseudowire redundancy over FRR.



# Digital Optical Monitoring

This feature module provides information on the digital optical monitoring (DOM) feature for the Cisco ASR 901 Series Aggregation Services Router.

## Finding Feature Information

Your software release may not support all the features documented in this module. For the latest feature information and caveats, see the release notes for your platform and software release. To find information about the features documented in this module, and to see a list of the releases in which each feature is supported, see the [“Feature Information for Digital Optical Monitoring”](#) section on page 40-13.

Use Cisco Feature Navigator to find information about platform support and Cisco software image support. To access Cisco Feature Navigator, go to <http://www.cisco.com/go/cfn>. An account on Cisco.com is not required.

## Contents

- [Feature Overview, page 40-1](#)
- [How to Enable Transceiver Monitoring, page 40-2](#)
- [Examples, page 40-3](#)
- [Additional References, page 40-12](#)
- [Feature Information for Digital Optical Monitoring, page 40-13](#)

## Feature Overview

The ASR 901 router supports DOM as per the standard SFF-8724 Multi-Source Agreement (MSA). This feature allows monitoring real-time parameters of the router, such as optical input and output power, temperature, laser bias current, and transceiver supply voltage. These parameters are monitored against the threshold values. The real-time DOM parameters can be monitored using command line interface or SNMP interface. Effective with Cisco IOS Release 15.3(3)S, Cisco ASR 901 supports DOM for both 1G and 10G SFPs.

DOM allows the user to view the threshold violation messages. To display the threshold violation messages, you must enable transceiver monitoring. For information on enabling transceiver monitoring, see [“How to Enable Transceiver Monitoring”](#) section on page 40-2.

The command line output for the real-time parameters is shown using the **show interfaces transceiver** command. To enable threshold notification in the transceiver via SNMP, use the **snmp-server enable traps transceiver** command. You can use the **show controllers gig 0/x** command to check whether SFP's are DOM capable. This command displays the SFP details.

## How to Enable Transceiver Monitoring

Complete the following steps to enable transceiver monitoring:

### Restrictions

- You need the transceiver module compatibility information for configuring transceiver monitoring. The compatibility matrix that lists the support for DOM in the Cisco transceiver modules is available at the following URL:  
[http://www.cisco.com/en/US/docs/interfaces\\_modules/transceiver\\_modules/compatibility/matrix/OL\\_8031.html](http://www.cisco.com/en/US/docs/interfaces_modules/transceiver_modules/compatibility/matrix/OL_8031.html)
- In case of combo ports with SFP and RJ45 provision, when SFP is inserted in slot or port and media type is not configured to SFP, DOM is functional if global transceiver monitoring is enabled.

### SUMMARY STEPS

- enable**
- configure terminal**
- transceiver type all**
- monitoring**
- monitoring interval *seconds***

### DETAILED STEPS

	Command	Purpose
Step 1	<b>enable</b>  <b>Example:</b> Router> enable	Enables privileged EXEC mode.  • Enter your password if prompted.
Step 2	<b>configure terminal</b>  <b>Example:</b> Router# configure terminal	Enters global configuration mode.
Step 3	<b>transceiver type all</b>  <b>Example:</b> Router(config)# transceiver type all	Enters transceiver type configuration mode.



	Command	Purpose
Step 4	<b>monitoring</b>  <b>Example:</b> Router(config-xcvr-type)# monitoring	Enables monitoring of all optical transceivers.
Step 5	<b>monitoring interval seconds</b>  <b>Example:</b> Router(config-xcvr-type)# monitoring interval 500	(Optional) Specifies the time interval for monitoring optical transceivers. Valid range is 300 to 3600 seconds, and the default value is 600 seconds.

## Examples

The real-time parameters of the router, such as optical output power, optical input power, temperature, laser bias current, and transceiver supply voltage can be monitored using the **show interfaces transceiver** command.

This section provides sample output for monitoring the real-time parameters on the ASR 901 router:

- [Example: Displaying Transceiver Information, page 40-3](#)
- [Example: Displaying Detailed Transceiver Information, page 40-4](#)
- [Example: Displaying List of Supported Transceivers, page 40-5](#)
- [Example: Displaying Threshold Tables, page 40-6](#)
- [Example: Displaying Threshold Violations, page 40-9](#)
- [Example: Displaying Threshold Violations on a Specific Interface, page 40-9](#)
- [Example: When Transceiver Monitoring is Disabled, page 40-9](#)
- [Example: Displaying SPF Details, page 40-10](#)

### Example: Displaying Transceiver Information

This example shows how to display transceiver information:

```
Router# show interfaces transceiver
If device is externally calibrated, only calibrated values are printed.
++ : high alarm, + : high warning, - : low warning, -- : low alarm.
NA or N/A: not applicable, Tx: transmit, Rx: receive.
mA: milliamperes, dBm: decibels (milliwatts).
```

Port	Temperature (Celsius)	Voltage (Volts)	Current (mA)	Optical Tx Power (dBm)	Optical Rx Power (dBm)
Gi0/10	36.9	3.25	537.7	-4.5	-9.7
Gi0/11	35.8	3.22	393.6	-5.5	-5.0

## Example: Displaying Detailed Transceiver Information

This example shows how to display detailed transceiver information:

```
Router# show interfaces transceiver detail
```

mA: milliamperes, dBm: decibels (milliwatts), NA or N/A: not applicable.

++ : high alarm, + : high warning, - : low warning, -- : low alarm.

A2D readouts (if they differ), are reported in parentheses.

The threshold values are calibrated.

Port	Temperature (Celsius)	High Alarm Threshold (Celsius)	High Warn Threshold (Celsius)	Low Warn Threshold (Celsius)	Low Alarm Threshold (Celsius)
Gi0/10	33.9	85.0	75.0	0.0	-5.0
Gi0/11	32.8	85.0	75.0	0.0	-5.0

Port	Voltage (Volts)	High Alarm Threshold (Volts)	High Warn Threshold (Volts)	Low Warn Threshold (Volts)	Low Alarm Threshold (Volts)
Gi0/10	3.25	3.70	3.59	3.09	3.00
Gi0/11	3.23	3.70	3.59	3.09	3.00

Port	Current (milliamperes)	High Alarm Threshold (mA)	High Warn Threshold (mA)	Low Warn Threshold (mA)	Low Alarm Threshold (mA)
Gi0/10	533.3	N/A	N/A	N/A	N/A
Gi0/11	391.1	N/A	N/A	N/A	N/A

Port	Optical Transmit Power (dBm)	High Alarm Threshold (dBm)	High Warn Threshold (dBm)	Low Warn Threshold (dBm)	Low Alarm Threshold (dBm)
Gi0/10	-4.5	-3.5	-4.0	-9.5	-10.0
Gi0/11	-5.5	-3.5	-4.0	-9.5	-10.0

Port	Optical Receive Power (dBm)	High Alarm Threshold (dBm)	High Warn Threshold (dBm)	Low Warn Threshold (dBm)	Low Alarm Threshold (dBm)
Gi0/10	-5.2	0.0	0.0	-17.0	-17.1
Gi0/11	-7.5	0.0	0.0	-17.0	-17.1

## Example: Displaying List of Supported Transceivers

This example shows how to display the list of supported DOM transceivers:

```
Router# show interfaces transceiver supported-list
Transceiver Type          Cisco p/n min version
                          supporting DOM
-----
DWDM GBIC                 ALL
DWDM SFP                  ALL
RX only WDM GBIC         ALL
DWDM XENPAK               ALL
DWDM X2                   ALL
DWDM XFP                  ALL
CWDM GBIC                 NONE
CWDM X2                   ALL
CWDM XFP                  ALL
XENPAK ZR                 ALL
X2 ZR                     ALL
XFP ZR                    ALL
Rx_only_WDM_XENPAK      ALL
XENPAK_ER                 10-1888-04
X2_ER                     ALL
XFP_ER                    ALL
XENPAK_LR                 10-1838-04
X2_LR                     ALL
XFP_LR                    ALL
XENPAK_LW                 ALL
X2_LW                     ALL
XFP_LW                    NONE
XENPAK SR                 NONE
X2 SR                     ALL
XFP SR                    ALL
XENPAK LX4                NONE
X2 LX4                    NONE
XFP LX4                   NONE
XENPAK CX4                NONE
X2 CX4                    NONE
SX GBIC                   NONE
LX GBIC                   NONE
ZX GBIC                   NONE
CWDM_SFP                  ALL
Rx_only_WDM_SFP          NONE
SX_SFP                    ALL
LX_SFP                    ALL
ZX_SFP                    ALL
EX_SFP                    ALL
SX SFP                    NONE
LX SFP                    NONE
ZX SFP                    NONE
GigE BX U SFP            NONE
GigE BX D SFP            ALL
X2 LRM                    ALL
```

## Example: Displaying Threshold Tables

This example shows how to display the threshold tables for all transceivers on the ASR 901 router:

```
Router# show interfaces transceiver threshold table
          Optical Tx      Optical Rx      Temp      Laser Bias      Voltage
                   current
-----
DWDM GBIC
Min1          -0.50        -28.50         0          N/A             4.50

Min2          -0.30        -28.29         5          N/A             4.75
Max2          3.29         -6.69         60         N/A             5.25
Max1          3.50         6.00         70         N/A             5.50

DWDM SFP
Min1          -0.50        -28.50         0          N/A             3.00

Min2          -0.30        -28.29         5          N/A             3.09
Max2          4.30         -9.50         60         N/A             3.59
Max1          4.50         9.30         70         N/A             3.70

RX only WDM GBIC
Min1          N/A          -28.50         0          N/A             4.50

Min2          N/A          -28.29         5          N/A             4.75
Max2          N/A          -6.69         60         N/A             5.25
Max1          N/A          6.00         70         N/A             5.50

DWDM XENPAK
Min1          -1.50        -24.50         0          N/A             N/A

Min2          -1.29        -24.29         5          N/A             N/A
Max2          3.29         -6.69         60         N/A             N/A
Max1          3.50         4.00         70         N/A             N/A

DWDM X2
Min1          -1.50        -24.50         0          N/A             N/A

Min2          -1.29        -24.29         5          N/A             N/A
Max2          3.29         -6.69         60         N/A             N/A
Max1          3.50         4.00         70         N/A             N/A

DWDM XFP
Min1          -1.50        -24.50         0          N/A             N/A

Min2          -1.29        -24.29         5          N/A             N/A
Max2          3.29         -6.69         60         N/A             N/A
Max1          3.50         4.00         70         N/A             N/A

CWDM X2
Min1          N/A          N/A           0          N/A             N/A

Min2          N/A          N/A           0          N/A             N/A
Max2          N/A          N/A           0          N/A             N/A
Max1          N/A          N/A           0          N/A             N/A

CWDM XFP
Min1          N/A          N/A           0          N/A             N/A

Min2          N/A          N/A           0          N/A             N/A
Max2          N/A          N/A           0          N/A             N/A
Max1          N/A          N/A           0          N/A             N/A

XENPAK ZR
Min1          -0.50        -24.50         0          N/A             N/A

Min2          -0.80        -24.29         5          N/A             N/A
Max2          4.30         -6.69         60         N/A             N/A
Max1          4.50         4.00         70         N/A             N/A
```

X2_ZR						
Min1	-0.50	-24.50	0	N/A	N/A	
Min2	-0.80	-24.29	5	N/A	N/A	
Max2	4.30	-6.69	60	N/A	N/A	
Max1	4.50	4.00	70	N/A	N/A	
XFP_ZR						
Min1	-0.50	-24.50	0	N/A	N/A	
Min2	-0.80	-24.29	5	N/A	N/A	
Max2	4.30	-6.69	60	N/A	N/A	
Max1	4.50	4.00	70	N/A	N/A	
Rx_only_WDM_XENPAK						
Min1	N/A	-24.50	0	N/A	N/A	
Min2	N/A	-24.29	5	N/A	N/A	
Max2	N/A	-6.69	60	N/A	N/A	
Max1	N/A	4.00	70	N/A	N/A	
XENPAK_ER						
Min1	-5.00	-16.50	0	N/A	N/A	
Min2	-4.69	-15.80	5	N/A	N/A	
Max2	4.00	-0.50	60	N/A	N/A	
Max1	4.50	0.00	70	N/A	N/A	
X2_ER						
Min1	-5.00	-16.50	0	N/A	N/A	
Min2	-4.69	-15.80	5	N/A	N/A	
Max2	4.00	-0.50	60	N/A	N/A	
Max1	4.50	0.00	70	N/A	N/A	
XFP_ER						
Min1	-5.00	-16.50	0	N/A	N/A	
Min2	-4.69	-15.80	5	N/A	N/A	
Max2	4.00	-0.50	60	N/A	N/A	
Max1	4.50	0.00	70	N/A	N/A	
XENPAK_LR						
Min1	-8.50	-15.00	0	N/A	N/A	
Min2	-8.19	-14.39	5	N/A	N/A	
Max2	0.50	0.50	60	N/A	N/A	
Max1	1.00	1.00	70	N/A	N/A	
X2_LR						
Min1	-8.50	-15.00	0	N/A	N/A	
Min2	-8.19	-14.39	5	N/A	N/A	
Max2	0.50	0.50	60	N/A	N/A	
Max1	1.00	1.00	70	N/A	N/A	
XFP_LR						
Min1	-8.50	-15.00	0	N/A	N/A	
Min2	-8.19	-14.39	5	N/A	N/A	
Max2	0.50	0.50	60	N/A	N/A	
Max1	1.00	1.00	70	N/A	N/A	
XENPAK_LW						
Min1	-8.50	-15.00	0	N/A	N/A	
Min2	-8.19	-14.39	5	N/A	N/A	
Max2	0.50	0.50	60	N/A	N/A	
Max1	1.00	1.00	70	N/A	N/A	
X2_LW						
Min1	-8.50	-15.00	0	N/A	N/A	
Min2	-8.19	-14.39	5	N/A	N/A	

## Examples

Max2	0.50	0.50	60	N/A	N/A
Max1	1.00	1.00	70	N/A	N/A
X2 SR					
Min1	-11.30	-13.89	-4	N/A	N/A
Min2	-7.30	-9.89	0	N/A	N/A
Max2	-1.00	-1.00	70	N/A	N/A
Max1	3.00	3.00	74	N/A	N/A
XFP SR					
Min1	-10.30	-12.89	0	N/A	N/A
Min2	-7.30	-9.89	5	N/A	N/A
Max2	-1.00	-1.00	60	N/A	N/A
Max1	2.00	2.00	70	N/A	N/A
CWDM_SFP					
Min1	-4.00	-32.00	-4	84.00	3.00
Min2	0.00	-28.00	0	70.00	3.09
Max2	5.00	-7.00	85	4.00	3.50
Max1	8.00	-3.00	90	2.00	3.59
SX_SFP					
Min1	-10.00	-17.50	-5	N/A	3.00
Min2	-9.50	-17.00	0	N/A	3.09
Max2	-4.00	0.00	75	N/A	3.59
Max1	-3.50	0.00	85	N/A	3.70
LX_SFP					
Min1	-10.00	-19.50	-5	N/A	3.00
Min2	-9.50	-19.00	0	N/A	3.09
Max2	-3.00	-3.00	75	N/A	3.59
Max1	-2.50	0.00	85	N/A	3.70
ZX_SFP					
Min1	-5.00	-24.00	-5	N/A	3.00
Min2	0.00	-23.00	0	N/A	3.09
Max2	5.00	-3.00	75	N/A	3.59
Max1	5.50	5.00	85	N/A	3.70
EX_SFP					
Min1	-5.00	-25.00	-45	N/A	3.00
Min2	-1.00	-22.50	-15	N/A	3.09
Max2	3.00	1.00	95	N/A	3.59
Max1	6.00	4.00	97	N/A	3.70
GigE BX D SFP					
Min1	N/A	N/A	0	N/A	N/A
Min2	N/A	N/A	0	N/A	N/A
Max2	N/A	N/A	0	N/A	N/A
Max1	N/A	N/A	0	N/A	N/A
X2 LRM					
Min1	-10.50	-12.39	-4	N/A	N/A
Min2	-6.50	-8.39	0	N/A	N/A
Max2	0.50	0.50	70	N/A	N/A
Max1	3.00	3.00	74	N/A	N/A

## Example: Displaying Threshold Violations

This example shows how to display the threshold violations for all transceivers on a Cisco ASR 901 router:

```
Router# show interfaces transceiver threshold violations
```

```
Rx: Receive, Tx: Transmit.
```

```
DDDD: days, HH: hours, MM: minutes, SS: seconds
```

Port	Time in slot (DDDD:HH:MM:SS)	Time since Last Known Threshold Violation (DDDD:HH:MM:SS)	Type(s) of Last Known Threshold Violation(s)
Gi0/10	0000:02:50:19	Not applicable	Not applicable
Gi0/11	0000:02:51:15		Rx power low alarm -31.0 dBm < -17.1 dBm

## Example: Displaying Threshold Violations on a Specific Interface

This example shows how to display violations for the transceiver on a specific interface:

```
Router# show interfaces GigabitEthernet 0/9 transceiver
```

```
ITU Channel not available (Wavelength not available),
```

```
Transceiver is externally calibrated.
```

```
If device is externally calibrated, only calibrated values are printed.
```

```
++ : high alarm, + : high warning, - : low warning, -- : low alarm.
```

```
NA or N/A: not applicable, Tx: transmit, Rx: receive.
```

```
mA: milliamperes, dBm: decibels (milliwatts).
```

Port	Temperature (Celsius)	Voltage (Volts)	Current (mA)	Optical Tx Power (dBm)	Optical Rx Power (dBm)
Gi0/9	32.5	3.20	385.1	-5.5	-5.0

## Example: When Transceiver Monitoring is Disabled

This example shows how to disable transceiver monitoring for all transceivers:

```
Router(config-xcvr-type)# no monitoring
```

This example shows the sample output when transceiver monitoring is disabled:

```
Router# show interfaces transceiver detail
```

```
Transceiver monitoring is disabled for all interfaces.
```

```
mA: milliamperes, dBm: decibels (milliwatts), NA or N/A: not applicable.
```

```
++ : high alarm, + : high warning, - : low warning, -- : low alarm.
```

```
A2D readouts (if they differ), are reported in parentheses.
```

```
The threshold values are calibrated.
```

Port	Temperature (Celsius)	High Alarm Threshold (Celsius)	High Warn Threshold (Celsius)	Low Warn Threshold (Celsius)	Low Alarm Threshold (Celsius)
Gi0/10	34.1	85.0	75.0	0.0	-5.0
Gi0/11	32.8	85.0	75.0	0.0	-5.0

Port	Voltage (Volts)	High Alarm Threshold (Volts)	High Warn Threshold (Volts)	Low Warn Threshold (Volts)	Low Alarm Threshold (Volts)
Gi0/10	3.20	3.20	3.20	3.20	3.20
Gi0/11	3.20	3.20	3.20	3.20	3.20

## Examples

Gi0/10	3.25	3.70	3.59	3.09	3.00
Gi0/11	3.23	3.70	3.59	3.09	3.00
Port	Current (milliamperes)	High Alarm Threshold (mA)	High Warn Threshold (mA)	Low Warn Threshold (mA)	Low Alarm Threshold (mA)
Gi0/10	533.9	N/A	N/A	N/A	N/A
Gi0/11	391.1	N/A	N/A	N/A	N/A
Port	Optical Transmit Power (dBm)	High Alarm Threshold (dBm)	High Warn Threshold (dBm)	Low Warn Threshold (dBm)	Low Alarm Threshold (dBm)
Gi0/10	-4.5	-3.5	-4.0	-9.5	-10.0
Gi0/11	-5.5	-3.5	-4.0	-9.5	-10.0
Port	Optical Receive Power (dBm)	High Alarm Threshold (dBm)	High Warn Threshold (dBm)	Low Warn Threshold (dBm)	Low Alarm Threshold (dBm)
Gi0/10	-5.2	0.0	0.0	-17.0	-17.1
Gi0/11	-7.5	0.0	0.0	-17.0	-17.1

## Example: Displaying SPF Details

The following is the sample output from the **show controller gig0/x** command.

```
Router# show controllers gig0/4
Switch Unit: 0   port: 10
PHY info:
    0x00: 0x1140   0x01: 0x79ED   0x02: 0x0362   0x03: 0x5DB1
    0x04: 0x0581   0x05: 0xC001   0x06: 0x006F   0x07: 0x2001
    0x08: 0x4FF5   0x09: 0x0600   0x0A: 0x7800   0x0B: 0x0000
    0x0C: 0x0000   0x0D: 0x0000   0x0E: 0x0000   0x0F: 0x3000
    0x10: 0x0001   0x11: 0x0F00   0x12: 0x0003   0x13: 0xFFFF
    0x14: 0x0707   0x15: 0x0000   0x16: 0x0000   0x17: 0x0F04
    0x18: 0x7067   0x19: 0xFF1C   0x1A: 0x257F   0x1B: 0xFFFF
    0x1C: 0x7EA8   0x1D: 0x064C   0x1E: 0x0000   0x1F: 0x0000
== SFP EEPROM content ==

Reg 0x00:  03  04  07  00  00  00  02  00
Reg 0x08:  00  00  00  01  0D  00  0A  64
Reg 0x10:  37  37  00  00  43  49  53  43
Reg 0x18:  4F  2D  53  55  4D  49  54  4F
Reg 0x20:  4D  4F  20  20  00  00  00  5F
Reg 0x28:  53  43  50  36  47  34  34  2D
Reg 0x30:  43  31  2D  42  4D  48  20  20
Reg 0x38:  41  20  20  20  05  1E  00  28
Reg 0x40:  00  1A  00  00  53  50  43  31
Reg 0x48:  35  32  34  30  43  50  36  20
Reg 0x50:  20  20  20  20  31  31  30  36
Reg 0x58:  31  32  43  38  68  F0  01  64
Reg 0x60:  00  00  0B  CC  81  5C  0A  9E
Reg 0x68:  3B  41  84  F5  19  46  DD  C3
Reg 0x70:  BC  EB  9E  00  00  00  00  00
Reg 0x78:  00  00  00  00  A3  0A  62  04
Reg 0x80:  00

    identifier          0x03 (SFP)
    connector           0x07 (LC)
    sfp_transceiver_code 0x02 (1000BaseLX)
    encoding            0x01 (8B10B)
```



```
br_nominal      (100MHz) 13
length_9km     (100m)  10
length_9m      (100m)  100
length_50m     (100m)  55
length_62_5m  (100m)  55
length_cu      (10m)   0
vendor_name    CISCO-SUMITOMO
vendor_oui     0x00 00 5F
vendor_pn      SCP6G44-C1-BMH
vendor_rev     A
cc_base        0x28
options[0]     0x00000000
options[1]     0x0000001A
br_max (%)     0
br_min (%)     0
vendor_sn      SPC15240CP6
date_code      110612C8 (yymmddvv, v=vendor specific)
cc_ext         0x64
DOM support    yes
```

## Additional References

The following sections provide references to digital optical monitoring feature.

### Related Documents

Related Topic	Document Title
Cisco IOS Commands	<i>Cisco IOS Master Commands List, All Releases</i>
ASR 901 Command Reference	<i>Cisco ASR 901 Series Aggregation Services Router Command Reference</i>
Compatibility Matrix	<i>Cisco Digital Optical Monitoring Compatibility Matrix</i>

### Standards

Standard	Title
SFF-8472	<i>Specification for Diagnostic Monitoring Interface for Optical Transceivers</i>

### MIBs

MIB	MIBs Link
CISCO-ENTITY-MIB CISCO-ENTITY-SENSOR-MIB	To locate and download MIBs for selected platforms, Cisco IOS releases, and feature sets, use Cisco MIB Locator found at the following URL: <a href="http://www.cisco.com/go/mibs">http://www.cisco.com/go/mibs</a>

### RFCs

RFC	Title
None	—

### Technical Assistance

Description	Link
The Cisco Technical Support website contains thousands of pages of searchable technical content, including links to products, technologies, solutions, technical tips, and tools. Registered Cisco.com users can log in from this page to access even more content.	<a href="http://www.cisco.com/cisco/web/support/index.html">http://www.cisco.com/cisco/web/support/index.html</a>

# Feature Information for Digital Optical Monitoring

Table 40-1 lists the features in this module and provides links to specific configuration information.

Use Cisco Feature Navigator to find information about platform support and software image support. Cisco Feature Navigator enables you to determine which software images support a specific software release, feature set, or platform. To access Cisco Feature Navigator, go to <http://www.cisco.com/go/cfn>. An account on Cisco.com is not required.



**Note**

Table 40-1 lists only the software release that introduced support for a given feature in a given software release train. Unless noted otherwise, subsequent releases of that software release train also support that feature.

**Table 40-1** Feature Information for Digital Optical Monitoring

Feature Name	Releases	Feature Information
Support for Digital Optical Monitoring on Cisco ASR 901 Router	15.2(2)SNI	<p>This feature was introduced on the Cisco ASR 901 router.</p> <p>The following sections provide information about this feature:</p> <ul style="list-style-type: none"> <li>• <a href="#">Feature Overview, page 40-1</a></li> <li>• <a href="#">Examples, page 40-3</a></li> </ul>





## IPv4 Multicast

---

This feature module describes how to configure IP multicast in an IPv4 network. IP multicast is an efficient way to use network resources, especially for bandwidth-intensive services such as audio and video.

### Finding Feature Information

Your software release may not support all the features documented in this module. For the latest feature information and caveats, see the release notes for your platform and software release. To find information about the features documented in this module, and to see a list of the releases in which each feature is supported, see the [“Feature Information for IPv4 Multicast”](#) section on page 41-16.

Use Cisco Feature Navigator to find information about platform support and Cisco software image support. To access Cisco Feature Navigator, go to <http://www.cisco.com/go/cfn>. An account on Cisco.com is not required.

### Contents

- [Prerequisites, page 41-2](#)
- [Restrictions, page 41-2](#)
- [Feature Overview, page 41-2](#)
- [Configuring IPv4 Multicast, page 41-6](#)
- [Verifying PIM SSM, page 41-9](#)
- [Configuration Examples for IPv4 Multicast, page 41-11](#)
- [Additional References, page 41-14](#)
- [Feature Information for IPv4 Multicast, page 41-16](#)

## Prerequisites

- Cisco IOS Release 15.4(1)S or a later release that supports the IPv4 Multicast feature must be installed previously on the Cisco ASR 901 Series Aggregation Services Router.

## Restrictions

- Source Specific Multicast (SSM) mapping takes a group G join from a host and identifies this group with an application associated with one or more sources. The SSM mapping can support only one such application per group G.
- When both SSM mapping and Internet Group Management Protocol Version 3 (IGMPv3) are enabled and the hosts already support IGMPv3 (but source specific information is not present), they start sending IGMPv3 group reports. These IGMPv3 group reports are not supported with SSM mapping and the router does not correctly associate sources with these reports.
- PIM Dense Mode is not supported.
- Only PIM version 2 is supported.
- IGMP snooping and Multicast Listener Discovery (MLD) snooping is not supported.
- Time-To-Live (TTL) threshold is not supported.
- Mroute ageing is not supported.
- Bi-Directional PIM (BIDIR-PIM) is not supported.
- Mroute based counter or rate statistics is not supported. The hardware supports only physical interface based multicast counter and rate statistics.
- Multicast VPN (MVPN) is not supported.
- You must enable the **asr901-multicast source** command on the SVI interface that is connected to the traffic source for PIM sparse mode.
- IPv4 multicast is not supported in VRF lite.

## Feature Overview

IP multicast is a bandwidth-conserving technology that reduces traffic by delivering a single stream of information simultaneously to potentially thousands of businesses and homes. Applications that take advantage of multicast include video conferencing, corporate communications, distance learning, and distribution of software, stock quotes, and news.

IP multicast routing enables a host (source) to send packets to a group of hosts (receivers) anywhere within the IP network by using a special form of IP address called the IP multicast group address. The sending host inserts the multicast group address into the IP destination address field of the packets and IP multicast routers and multilayer switches forward the incoming IP multicast packets out of all interfaces that lead to the members of the multicast group. Any host, regardless of whether it is a member of a group, can send to a group. However, only the members of a group receive the message.

Effective with Cisco IOS Release 15.4(1), IPv4 multicast is supported on the Cisco ASR 901 series routers. The router supports up to 500 multicast IP address entries. Multicast support is provided for source and multicast groups using IGMP (IGMPv1 or IGMPv2 or IGMPv3) report messages.

For more information on IP Multicast Technology, see *tIP Multicast Technology Overview* document at: [http://www.cisco.com/en/US/docs/ios-xml/ios/ipmulti\\_pim/configuration/xs-3s/imc\\_tech\\_oview.html](http://www.cisco.com/en/US/docs/ios-xml/ios/ipmulti_pim/configuration/xs-3s/imc_tech_oview.html)

## Supported Protocols

- Basic multicast routing
- IGMP
- PIMv4 SSM
- PIMv4 SSM Mapping
- PIM MIB
- PIM Sparse mode
- Static Rendezvous Point (RP)
- Auto RP
- Bootstrap router (BSR)

## PIM SSM for IPv4

PIM SSM is the routing protocol that supports the implementation of SSM and is derived from the PIM sparse mode (PIM-SM). IGMP is the Internet Engineering Task Force (IETF) standards track protocol used for hosts to signal multicast group membership to routers. IGMPv3 supports source filtering, which is required for SSM. In order for SSM to run with IGMPv3, SSM must be supported in the device (the host where the application is running) and in the application itself.

## Source Specific Multicast

SSM is a datagram delivery model that best supports one-to-many applications, also known as broadcast applications. SSM is a core networking technology for the Cisco implementation of IP multicast solutions targeted for audio and video broadcast application environments and is described in [RFC 3569](#). The following two components together support SSM:

- PIM SSM
- IGMPv3

## Protocol Independent Multicast

The PIM protocol maintains the current IP multicast service mode of receiver-initiated membership. PIM is not dependent on a specific unicast routing protocol; it is IP routing protocol independent, and can leverage whichever unicast routing protocols are used to populate the unicast routing table, including Open Shortest Path First (OSPF), Border Gateway Protocol (BGP), Intermediate System-to-Intermediate System (IS-IS), and static routes. PIM uses unicast routing information to perform the multicast forwarding function.

Although PIM is called a multicast routing protocol, it actually uses the unicast routing table to perform the RPF check function instead of building up a completely independent multicast routing table. Unlike other routing protocols, PIM does not send and receive routing updates between routers.

For more information on SSM and PIM, see the *IP Multicast Technology Overview* document at: [http://www.cisco.com/en/US/docs/ios-xml/ios/ipmulti\\_pim/configuration/xs-3s/imc\\_tech\\_oview.html](http://www.cisco.com/en/US/docs/ios-xml/ios/ipmulti_pim/configuration/xs-3s/imc_tech_oview.html)

## PIM SSM Address Range

SSM can coexist with the Internet Standard Multicast (ISM) service by applying the SSM delivery model to a configured subset of the IP multicast group address range. The Cisco IOS software allows SSM configuration for an arbitrary subset of the IP multicast address range 224.0.0.0 through 239.255.255.255. When an SSM range is defined, existing IP multicast receiver applications do not receive any traffic when they try to use addresses in the SSM range (unless the application is modified to use explicit (S, G) channel subscription).

For groups within the SSM range, (S, G) channel subscriptions are accepted through IGMPv3 INCLUDE mode membership reports.

## IGMP

IGMP is used to dynamically register individual hosts in a multicast group on a particular LAN. Enabling PIM on an interface also enables IGMP. IGMP provides a means to automatically control and limit the flow of multicast traffic throughout the network with the use of special multicast queriers and hosts.

For more information on IGMP, see the *IP Multicast: IGMP Configuration Guide* at: [http://www.cisco.com/en/US/docs/ios-xml/ios/ipmulti\\_igmp/configuration/xr-3s/imc\\_customizing\\_igmp.html](http://www.cisco.com/en/US/docs/ios-xml/ios/ipmulti_igmp/configuration/xr-3s/imc_customizing_igmp.html)

### IGMPv1

IGMP version 1 is a simple protocol consisting of two messages. It provides the basic query-response mechanism that allows the multicast device to determine which multicast groups are active and other processes that enable hosts to join a multicast group. [RFC 1112](#) defines the IGMPv1 host extensions for IP multicasting.

### IGMPv2

IGMP version 2 extends the functionality of IGMP, allowing such capabilities as the IGMP leave process, group-specific queries, and an explicit maximum response time field. IGMPv2 also adds the capability for devices to elect the IGMP querier without dependence on the multicast protocol to perform this task. [RFC 2236](#) defines IGMPv2.

### IGMPv3

IGMP version 3 provides for source filtering, which enables a multicast receiver host to signal to a device which groups it wants to receive multicast traffic from, and from which sources this traffic is expected. In addition, IGMPv3 supports the link local address 224.0.0.22, which is the destination IP address for IGMPv3 membership reports; all IGMPv3-capable multicast devices must listen to this address. [RFC 3376](#) defines IGMPv3.



## PIM SSM Mapping

PIM SSM mapping supports SSM transition in cases where neither the URD nor IGMP v3lite is available, or when supporting SSM on the end system is not feasible. SSM mapping enables you to leverage SSM for video delivery to legacy set-top boxes (STBs) that do not support IGMPv3 or for applications that do not take advantage of the IGMPv3 host stack. URD and IGMPv3lite are applications used on receivers which do not have SSM support.

SSM mapping introduces a means for the last hop router to discover sources sending to groups. When SSM mapping is configured, if a router receives an IGMPv1 or IGMPv2 membership report for a particular group G, the router translates this report into one or more (S, G) channel memberships for the well-known sources associated with this group.

SSM mapping only needs to be configured on the last hop router connected to receivers. No support is needed on any other routers in the network. When the router receives an IGMPv1 or IGMPv2 membership report for a group G, the router uses SSM mapping to determine one or more source IP addresses for the group G. SSM mapping then translates the membership report as an IGMPv3 report INCLUDE (G, [S1, G], [S2, G]...[Sn, G]) and continues as if it had received an IGMPv3 report.

### Static SSM Mapping

SSM static mapping enables you to configure the last hop router to use a static map to determine the sources sending to groups. Static SSM mapping requires that you configure access lists (ACLs) to define group ranges. The groups permitted by those ACLs then can be mapped to sources using the **ip igmp static ssm-map** command.

For more information on SSM Mapping, see the *IP Multicast: IGMP Configuration Guide* at: [http://www.cisco.com/en/US/docs/ios-xml/ios/ipmulti\\_igmp/configuration/xe-3s/imc\\_ssm\\_map.html](http://www.cisco.com/en/US/docs/ios-xml/ios/ipmulti_igmp/configuration/xe-3s/imc_ssm_map.html)

## Reverse Path Forwarding

Reverse-path forwarding is used for forwarding multicast datagrams. It functions as follows:

- If a router receives a datagram on an interface it uses to send unicast packets to the source, it means the packet has arrived on the RPF interface.
- If the packet arrives on the RPF interface, a router forwards the packet out the interfaces present in the outgoing interface list of a multicast routing table entry.
- If the packet does not arrive on the RPF interface, the packet is silently discarded to prevent loops.

PIM SSM uses source trees to forward datagrams; the RPF check is performed as follows:

- If a PIM router has source-tree state (that is, an [S, G] entry is present in the multicast routing table), the router performs the RPF check against the IPv4 address of the source of the multicast packet.
- Sparse-mode PIM uses the RPF lookup function to determine where it needs to send joins and prunes. (S, G) joins (which are source-tree states) are sent toward the source.

For more information on Reverse Path Forwarding, see the *Configuring Unicast Reverse Path Forwarding* document at:

[http://www.cisco.com/en/US/docs/ios/12\\_2/security/configuration/guide/scfrpf.html](http://www.cisco.com/en/US/docs/ios/12_2/security/configuration/guide/scfrpf.html)

# Configuring IPv4 Multicast

- [Enabling IPv4 Multicast Routing, page 41-6](#)
- [Configuring PIM SSM, page 41-7](#)
- [Configuring PIM SSM Mapping, page 41-8](#)
- [Verifying IPv4 Multicast Routing, page 41-9](#)
- [Verifying PIM SSM, page 41-9](#)
- [Verifying PIM SSM Mapping, page 41-10](#)

## Enabling IPv4 Multicast Routing

To configure IPv4 multicast on the Cisco ASR 901 series routers, complete the following steps:

### SUMMARY STEPS

1. **enable**
2. **configure terminal**
3. **ip multicast-routing**
4. **asr901-platf-multicast enable**
5. **ip pim rp-address**
6. **interface** *type number*
7. **ip pim sparse-mode**
8. **asr901-multicast source**

### DETAILED STEPS

	Command	Purpose
Step 1	<b>enable</b>  <b>Example:</b> Router> enable	Enables privileged EXEC mode. <ul style="list-style-type: none"> <li>• Enter your password if prompted.</li> </ul>
Step 2	<b>configure terminal</b>  <b>Example:</b> Router# configure terminal	Enters global configuration mode.
Step 3	<b>ip multicast-routing</b>  <b>Example:</b> Router(config)# ip multicast-routing	Enables multicast routing.

	Command	Purpose
Step 4	<b>asr901-platf-multicast enable</b>  <b>Example:</b> Router(config)# asr901-platf-multicast enable	Enables multicast on the Cisco ASR 901 series routers.
Step 5	<b>ip pim rp-address rp-address</b>  <b>Example:</b> Router(config)# ip pim rp-address 192.168.0.1	Configures the address of a PIM RP for multicast groups.
Step 6	<b>interface type number</b>  <b>Example:</b> Router(config)# interface vlan 5	Configures the interface type and enters interface configuration mode.
Step 7	<b>ip pim sparse-mode</b>  <b>Example:</b> Router(config-if)# ip pim sparse-mode	Enables PIM sparse mode.
Step 8	<b>asr901-multicast source</b>  <b>Example:</b> Router(config-if)# asr901-multicast source	Configures the router to send multicast packets to the CPU enabling it to transmit register packets to the RP.  <b>Note</b> This command should be enabled on the SVI which is facing the source and is applicable only for PIM SM.

## Configuring PIM SSM

To configure PIM SSM, complete the following steps:

### SUMMARY STEPS

1. **enable**
2. **configure terminal**
3. **ip pim ssm default**
4. **interface type number**
5. **ip pim sparse-mode**
6. **ip igmp version 3**

## DETAILED STEPS

	Command	Purpose
Step 1	<b>enable</b>  <b>Example:</b> Router> enable	Enables privileged EXEC mode. <ul style="list-style-type: none"><li>Enter your password if prompted.</li></ul>
Step 2	<b>configure terminal</b>  <b>Example:</b> Router# configure terminal	Enters global configuration mode.
Step 3	<b>ip pim ssm [default   range access-list]</b>  <b>Example:</b> Router(config-if)# ip pim ssm default	Configures SSM service. The <b>default</b> keyword defines the SSM range access list. The <b>range</b> keyword specifies the standard IP access list number or name that defines the SSM range.
Step 4	<b>interface type number</b>  <b>Example:</b> Router(config)# interface GigabitEthernet 0/1	Specifies an interface type and number, and places the device in interface configuration mode.
Step 5	<b>ip pim sparse-mode</b>  <b>Example:</b> Router(config-if)# ip pim sparse-mode	Enables PIM on an interface.
Step 6	<b>ip igmp version 3</b>  <b>Example:</b> Router(config-if)# ip igmp version 3	Enables IGMPv3 on an interface.

## Configuring PIM SSM Mapping

To configure PIM SSM mapping, complete the following steps:

## SUMMARY STEPS

- enable**
- configure terminal**
- no ip igmp ssm-map query dns**
- ip igmp ssm-map enable**
- ip igmp ssm-map static access-list source-address**

## DETAILED STEPS

	Command	Purpose
Step 1	<b>enable</b>  <b>Example:</b> Router> enable	Enables privileged EXEC mode. <ul style="list-style-type: none"> <li>Enter your password if prompted.</li> </ul>
Step 2	<b>configure terminal</b>  <b>Example:</b> Router# configure terminal	Enters global configuration mode.
Step 3	<b>no ip igmp ssm-map query dns</b>  <b>Example:</b> Router(config)# no ip igmp ssm-map query dns	Disables DNS-based SSM mapping.
Step 4	<b>ip igmp ssm-map enable</b>  <b>Example:</b> Router(config)# ip igmp ssm-map enable	Enables SSM mapping for groups in the configured SSM range.
Step 5	<b>ip igmp ssm-map static access-list source-address</b>  <b>Example:</b> Router(config)# ip igmp ssm-map static 11 172.16.8.11	Configures static SSM mapping.

## Verifying IPv4 Multicast Routing

Use the **show** commands listed below to verify the IPv4 multicast routing.

```
Router# show asr901 multicast-support
```

```
Platform support for IPv4(v6) Multicast: ENABLED
```

## Verifying PIM SSM

Use the **show** commands listed below to verify the PIM SSM configuration.

To display the multicast groups with receivers that are directly connected to the router and that were learned through IGMP, use the **show ip igmp groups** command described in the following example.

```
Router# show ip igmp groups
```

```
IGMP Connected Group Membership
Group Address      Interface          Uptime    Expires    Last Reporter    Group
Accounted
232.1.1.1          Vlan70            04:10:01  stopped   70.1.1.10
```

```

224.0.1.40      Vlan16          04:17:35  00:02:58  16.1.1.3
224.0.1.40      Vlan23          05:08:03  00:02:54  23.1.1.1

```

To display the contents of the IP multicast routing table, use the **show** command described in the following example.

```

Router# show ip mroute

IP Multicast Routing Table
Flags: D - Dense, S - Sparse, B - Bidir Group, s - SSM Group, C - Connected,
       L - Local, P - Pruned, R - RP-bit set, F - Register flag,
       T - SPT-bit set, J - Join SPT, M - MSDP created entry, E - Extranet,
       X - Proxy Join Timer Running, A - Candidate for MSDP Advertisement,
       U - URD, I - Received Source Specific Host Report,
       Z - Multicast Tunnel, z - MDT-data group sender,
       Y - Joined MDT-data group, y - Sending to MDT-data group,
       G - Received BGP C-Mroute, g - Sent BGP C-Mroute,
       N - Received BGP Shared-Tree Prune, n - BGP C-Mroute suppressed,
       Q - Received BGP S-A Route, q - Sent BGP S-A Route,
       V - RD & Vector, v - Vector, p - PIM Joins on route,
       x - VxLAN group

Outgoing interface flags: H - Hardware switched, A - Assert winner, p - PIM Join
Timers: Uptime/Expires
Interface state: Interface, Next-Hop or VCD, State/Mode

(9.1.1.1, 232.1.1.1), 00:00:03/00:02:57, flags: sTI
  Incoming interface: Vlan16, RPF nbr 16.1.1.1
  Outgoing interface list:
    Vlan70, Forward/Sparse, 00:00:04/00:02:56

(5.1.1.1, 232.1.1.1), 00:00:04/00:02:56, flags: sTI
  Incoming interface: Vlan16, RPF nbr 16.1.1.1
  Outgoing interface list:
    Vlan70, Forward/Sparse, 00:00:04/00:02:56

(*, 224.0.1.40), 00:00:12/00:02:47, RP 6.6.6.6, flags: SJCL
  Incoming interface: Vlan16, RPF nbr 16.1.1.1
  Outgoing interface list:
    Vlan23, Forward/Sparse, 00:00:12/00:02:47

```

## Verifying PIM SSM Mapping

Use the **show** commands listed below to verify the PIM SSM Mapping configuration.

To display information about SSM mapping, use the **show** command described in the following example.

```

Router# show ip igmp ssm-mapping

SSM Mapping   : Enabled
DNS Lookup    : Disabled
Cast domain   : ssm-map.cisco.com
Name servers  : 255.255.255.255

```

To display the sources that SSM mapping uses for a particular group, use the **show** command described in the following example.

```

Router# show ip igmp ssm-mapping 232.1.1.1

Group address: 232.1.1.1

```

```
Database      : Static
Source list   : 5.1.1.1
                9.1.1.1
```

To display the multicast groups with receivers that are directly connected to the router and that were learned through IGMP, use the **show** command described in the following examples.

- **show ip igmp groups group-address**

```
Router# show ip igmp groups 232.1.1.1
```

```
IGMP Connected Group Membership
Group Address   Interface          Uptime    Expires    Last Reporter  Group
Accounted
232.1.1.1      Vlan70            04:14:26  stopped    70.1.1.10
```

- **show ip igmp groups interface-type interface-number**

```
Router# show ip igmp groups vlan70
```

```
IGMP Connected Group Membership
Group Address   Interface          Uptime    Expires    Last Reporter  Group
Accounted
232.1.1.1      Vlan70            04:15:33  stopped    70.1.1.10
```

- **show ip igmp groups interface-type detail**

```
Router# show ip igmp groups vlan70 detail
```

```
Flags: L - Local, U - User, SG - Static Group, VG - Virtual Group,
       SS - Static Source, VS - Virtual Source,
       Ac - Group accounted towards access control limit
```

```
Interface:      Vlan70
Group:          232.1.1.1
Flags:         SSM
Uptime:        04:15:37
Group mode:    INCLUDE
Last reporter: 70.1.1.10
CSR Grp Exp:   00:02:04
Group source list: (C - Cisco Src Report, U - URD, R - Remote, S - Static,
                   V - Virtual, M - SSM Mapping, L - Local,
                   Ac - Channel accounted towards access control limit)
Source Address  Uptime    v3 Exp   CSR Exp  Fwd  Flags
5.1.1.1        04:15:37  stopped  00:02:04 Yes  CM
9.1.1.1        04:15:37  stopped  00:02:04 Yes  CM
```

## Configuration Examples for IPv4 Multicast

- [Example: IPv4 Multicast Routing, page 41-12](#)
- [Example: Configuring PIM SSM, page 41-12](#)
- [Example: Configuring PIM SSM Mapping, page 41-12](#)
- [Example: Configuring Rendezvous Point, page 41-13](#)

## Example: IPv4 Multicast Routing

The following is a sample configuration of IPv4 Multicast routing feature on the Cisco ASR 901 router.

```
!
Building configuration...

Current configuration : 120 bytes
!

ip multicast-routing
asr901-platf-multicast enable
!
interface Vlan5
  asr901-multicast source
  ip address 22.1.1.2 255.255.255.0
  ip pim sparse-mode
!
end
```

## Example: Configuring PIM SSM

The following is a sample configuration of PIM SSM on the Cisco ASR 901 router.

```
!
Building configuration...

Current configuration : 116 bytes
!
ip multicast-routing
asr901-platf-multicast enable
!
ip pim ssm default
interface Vlan70
  ip address 70.1.1.2 255.255.255.0
  ip pim sparse-mode
  ip igmp version 3
  ip ospf 1 area 0
end
```

## Example: Configuring PIM SSM Mapping

The following is a sample configuration of PIM SSM Mapping on the Cisco ASR 901 router.

```
!
no ip domain lookup
ip domain multicast ssm.map.cisco.com
ip name-server 10.48.81.21
!
ip multicast-routing
ip igmp ssm-map enable
ip igmp ssm-map static 10 172.16.8.10
ip igmp ssm-map static 11 172.16.8.11
!
.
.
.
```



```
!
interface vlan10
  description Sample IGMP Interface Configuration for SSM-Mapping Example
  ip address 10.20.1.2 255.0.0.0
  ip pim sparse-mode
  ip igmp static-group 232.1.2.1 source ssm-map
  ip igmp version 3
!
.
.
.
!
ip pim ssm default
!
access-list 10 permit 232.1.2.10
access-list 11 permit 232.1.2.0 0.0.0.255
!
```

## Example: Configuring Rendezvous Point

For a sample configuration of RP, see the Configuring a Rendezvous Point guide at:  
[http://www.cisco.com/en/US/docs/ios/solutions\\_docs/ip\\_multicast/White\\_papers/rps.html](http://www.cisco.com/en/US/docs/ios/solutions_docs/ip_multicast/White_papers/rps.html)

## Troubleshooting Tips

To display IGMP packets received and sent, use the following **debug** command.

```
Router# debug ip igmp
```



### Caution

---

We suggest you do not use these debug commands without TAC supervision.

---

# Additional References

The following sections provide references related to IPv4 Multicast feature.

## Related Documents

Related Topic	Document Title
Cisco IOS Commands	<i>Cisco IOS Master Commands List, All Releases</i>
Cisco ASR 901 Router Commands	<i>Cisco ASR 901 Series Aggregation Services Router Command Reference</i>
IP Multicast Technology Overview	<i>IP Multicast: PIM Configuration Guide</i>
Customizing IGMP	<i>IP Multicast: IGMP Configuration Guide</i>
Configuring Unicast Reverse Path Forwarding	<i>Cisco IOS Security Configuration Guide</i>

## Standards

Standard	Title
None	—

## MIBs

MIB	MIBs Link
PIM-MIB	To locate and download MIBs for selected platforms, Cisco IOS releases, and feature sets, use Cisco MIB Locator found at the following URL: <a href="http://www.cisco.com/go/mibs">http://www.cisco.com/go/mibs</a>

## RFCs

RFC	Title
RFC 1112	<i>Host Extensions for IP Multicasting</i>
RFC 2236	<i>Internet Group Management Protocol, Version 2</i>
RFC 3376	<i>Internet Group Management Protocol, Version 3</i>
RFC 3569	<i>Source-Specific Multicast</i>

## Technical Assistance

Description	Link
The Cisco Technical Support website contains thousands of pages of searchable technical content, including links to products, technologies, solutions, technical tips, and tools. Registered Cisco.com users can log in from this page to access even more content.	<a href="http://www.cisco.com/techsupport">http://www.cisco.com/techsupport</a>

## Feature Information for IPv4 Multicast

Table 41-1 lists the features in this module and provides links to specific configuration information.

Use Cisco Feature Navigator to find information about platform support and software image support. Cisco Feature Navigator enables you to determine which software images support a specific software release, feature set, or platform. To access Cisco Feature Navigator, go to <http://www.cisco.com/go/cfn>. An account on Cisco.com is not required.

**Note**

Table 41-1 lists only the software release that introduced support for a given feature in a given software release train. Unless noted otherwise, subsequent releases of that software release train also support that feature.

**Table 41-1** Feature Information for IPv4 Multicast

Feature Name	Releases	Feature Information
Source Specific Multicast	15.4(1)S	<p>This feature was introduced on the Cisco ASR 901 routers.</p> <p>The following section provides information about this feature:</p> <ul style="list-style-type: none"> <li>• <a href="#">Source Specific Multicast, page 41-3</a></li> </ul> <p><b>Platform-Independent Cisco IOS Software Documentation</b></p> <ul style="list-style-type: none"> <li>• See the “<a href="#">Configuring Source Specific Multicast</a>” chapter of the <i>IP Multicast: IGMP Configuration Guide</i>.</li> </ul>
Source Specific Multicast Mapping	15.4(1)S	<p>This feature was introduced on the Cisco ASR 901 routers.</p> <p>The following section provides information about this feature:</p> <ul style="list-style-type: none"> <li>• <a href="#">PIM SSM Mapping, page 41-5</a></li> </ul> <p><b>Platform-Independent Cisco IOS Software Documentation</b></p> <p>See the “<a href="#">SSM Mapping</a>” chapter of the <i>IP Multicast: IGMP Configuration Guide</i>.</p>
IGMP Version 1	15.4(1)S	<p>This feature was introduced on the Cisco ASR 901 routers.</p> <p>The following section provides information about this feature:</p> <ul style="list-style-type: none"> <li>• <a href="#">IGMPv1, page 41-4</a></li> </ul> <p><b>Platform-Independent Cisco IOS Software Documentation</b></p> <p>See the “<a href="#">Customizing IGMP</a>” chapter of the <i>IP Multicast: IGMP Configuration Guide</i>.</p>

**Table 41-1** Feature Information for IPv4 Multicast

Feature Name	Releases	Feature Information
IGMP Version 2	15.4(1)S	<p>This feature was introduced on the Cisco ASR 901 routers. The following section provides information about this feature:</p> <ul style="list-style-type: none"> <li>• <a href="#">IGMPv2, page 41-4</a></li> </ul> <p><b>Platform-Independent Cisco IOS Software Documentation</b> See the “<a href="#">Customizing IGMP</a>” chapter of the <i>IP Multicast: IGMP Configuration Guide</i>.</p>
IGMP Version 3	15.4(1)S	<p>This feature was introduced on the Cisco ASR 901 routers. The following section provides information about this feature:</p> <ul style="list-style-type: none"> <li>• <a href="#">IGMPv3, page 41-4</a></li> </ul> <p><b>Platform-Independent Cisco IOS Software Documentation</b> See the “<a href="#">Customizing IGMP</a>” chapter of the <i>IP Multicast: IGMP Configuration Guide</i>.</p>





## IPv6 Multicast

---

This feature module describes how to configure basic IP multicast in an IPv6 network.

### Finding Feature Information

Your software release may not support all the features documented in this module. For the latest feature information and caveats, see the release notes for your platform and software release. To find information about the features documented in this module, and to see a list of the releases in which each feature is supported, see the “[Feature Information for IPv6 Multicast](#)” section on page 42-24.

Use Cisco Feature Navigator to find information about platform support and Cisco software image support. To access Cisco Feature Navigator, go to <http://www.cisco.com/go/cfn>. An account on Cisco.com is not required.

### Contents

- [Prerequisites, page 42-2](#)
- [Restrictions, page 42-2](#)
- [Feature Overview, page 42-2](#)
- [Configuring IPv6 Multicast, page 42-6](#)
- [Verifying IPv6 Multicast, page 42-13](#)
- [Configuration Examples for IPv6 Multicast, page 42-21](#)
- [Additional References, page 42-23](#)
- [Feature Information for IPv6 Multicast, page 42-24](#)

## Prerequisites

- Cisco IOS Release 15.4(1)S or a later release that supports the IPv6 Multicast feature must be installed previously on the Cisco ASR 901 Series Aggregation Services Router.
- You must first enable IPv6 unicast routing on all interfaces of the device on which you want to enable IPv6 multicast routing.

## Restrictions

- PIM dense-mode is not supported.
- Bidirectional PIM is not supported.
- IGMP and Multicast Listener Discovery (MLD) snooping is not supported.
- You must disable the Source Specific Multicast (SSM) map query dns when static mapping is configured.
- You must configure the **asr901-platf-multicast enable** command to enable multicast on the Cisco ASR 901 router.
- You must enable the **asr901-multicast source** command on the SVI interface that is connected to the traffic source.
- Mroute based counter or rate statistics is not supported. The hardware supports only physical interface based multicast counter and rate statistics.
- Multicast VPN (MVPN) is not supported.
- IPv6 multicast is not supported in VRF lite.

## Feature Overview

An IPv6 multicast group is an arbitrary group of receivers that want to receive a particular data stream. This group has no physical or geographical boundaries—receivers can be located anywhere on the Internet or in any private network. Receivers that are interested in receiving data flowing to a particular group must join the group by signaling their local device. This signaling is achieved with the MLD protocol.

Devices use the MLD protocol to learn whether members of a group are present on their directly attached subnets. Hosts join multicast groups by sending MLD report messages. The network then delivers data to a potentially unlimited number of receivers, using only one copy of the multicast data on each subnet. IPv6 hosts that wish to receive the traffic are known as group members.

Packets delivered to group members are identified by a single multicast group address. Multicast packets are delivered to a group using best-effort reliability, just like IPv6 unicast packets.

The multicast environment consists of senders and receivers. Any host, regardless of whether it is a member of a group, can send to a group. However, only the members of a group receive the message.

A multicast address is chosen for the receivers in a multicast group. Senders use that address as the destination address of a datagram to reach all members of the group.

Membership in a multicast group is dynamic; hosts can join and leave at any time. There is no restriction on the location or number of members in a multicast group. A host can be a member of more than one multicast group at a time.



How active a multicast group is, its duration, and its membership can vary from group to group and from time to time. A group that has members may have no activity.

## IPv6 Multicast Groups

An IPv6 address must be configured on an interface for the interface to forward IPv6 traffic. Configuring a site-local or global IPv6 address on an interface automatically configures a link-local address and activates IPv6 for that interface. Additionally, the configured interface automatically joins the following required multicast groups for that link:

- Solicited-node multicast group FF02:0:0:0:1:FF00::/104 for each unicast and anycast address assigned to the interface
- All-nodes link-local multicast group FF02::1
- All-routers link-local multicast group FF02::2

## IPv6 Multicast Routing Implementation

The Cisco IOS software supports the following protocols to implement IPv6 multicast routing:

- MLD for IPv6: MLD is used by IPv6 routers to discover multicast listeners (nodes that want to receive multicast packets destined for specific multicast addresses) on directly attached links. There are two versions of MLD:
  - MLD version 1 is based on version 2 of the IGMP for IPv4
  - MLD version 2 is based on version 3 of the IGMP for IPv4.
- IPv6 multicast for Cisco IOS software uses both MLD version 2 and MLD version 1. MLD version 2 is fully backward-compatible with MLD version 1 (described in [RFC 2710](#)). Hosts that support only MLD version 1 interoperates with a router running MLD version 2. Mixed LANs with both MLD version 1 and MLD version 2 hosts are likewise supported.
- PIM is used between routers so that they can track which multicast packets to forward to each other and to their directly connected LANs.
- PIM in PIM SSM has the additional ability to report interest in receiving packets from specific source addresses (or from all but the specific source addresses) to an IP multicast address.

## Multicast Listener Discovery Protocol for IPv6

To start implementing multicasting in a network, users must first define who receives the multicast. The MLD protocol is used by IPv6 devices to discover the presence of multicast listeners (for example, nodes that want to receive multicast packets) on their directly attached links, and to discover specifically which multicast addresses are of interest to those neighboring nodes. It is used for discovering local group and source-specific group membership. The MLD protocol provides a means to automatically control and limit the flow of multicast traffic throughout your network with the use of special multicast queriers and hosts.

The differences between multicast queriers and hosts are as follows:

- A querier is a network device that sends query messages to discover which network devices are members of a given multicast group.
- A host is a receiver that send report messages to inform the querier of a host membership.

A set of queriers and hosts that receive multicast data streams from the same source is called a multicast group. Queriers and hosts use MLD reports to join and leave multicast groups and to begin receiving group traffic.

MLD uses the Internet Control Message Protocol (ICMP) to carry its messages. All MLD messages are link-local with a hop limit of 1, and they all have the alert option set. The alert option implies an implementation of the hop-by-hop option header.

MLD has three types of messages:

- **Query**—General, group-specific, and multicast-address-specific. In a query message, the multicast address field is set to 0 when MLD sends a general query. The general query learns which multicast addresses have listeners on an attached link. Group-specific and multicast-address-specific queries are the same. A group address is a multicast address.
- **Report**—In a report message, the multicast address field is that of the specific IPv6 multicast address to which the sender is listening.
- **Done**—In a done message, the multicast address field is that of the specific IPv6 multicast address to which the source of the MLD message is no longer listening.

An MLD report must be sent with a valid IPv6 link-local source address, or the unspecified address (::). If the sending interface has not yet acquired a valid link-local address. Sending reports with the unspecified address is allowed to support the use of IPv6 multicast in the Neighbor Discovery Protocol.

For stateless autoconfiguration, a node is required to join several IPv6 multicast groups in order to perform duplicate address detection (DAD). Prior to DAD, the only address the reporting node has for the sending interface is a tentative one, which cannot be used for communication. Therefore, the unspecified address must be used.

MLD states that result from MLD version 2 or MLD version 1 membership reports can be limited globally or by interface. The MLD group limits feature provides protection against denial of service (DoS) attacks caused by MLD packets. Membership reports in excess of the configured limits are not entered in the MLD cache, and traffic for those excess membership reports are not forwarded.

MLD provides support for source filtering. Source filtering allows a node to report interest in listening to packets only from specific source addresses (as required to support SSM), or from all addresses except specific source addresses sent to a particular multicast address.

When a host using MLD version 1 sends a leave message, the device needs to send query messages to reconfirm that this host was the last MLD version 1 host joined to the group before it can stop forwarding traffic. This function takes about 2 seconds. This “leave latency” is also present in IGMP version 2 for IPv4 multicast.

## Protocol Independent Multicast

Protocol Independent Multicast (PIM) is used between devices so that they can track which multicast packets to forward to each other and to their directly connected LANs. PIM works independently of the unicast routing protocol to perform send or receive multicast route updates like other protocols.

Regardless of which unicast routing protocols are being used in the LAN to populate the unicast routing table, Cisco IOS PIM uses the existing unicast table content to perform the Reverse Path Forwarding (RPF) check instead of building and maintaining its own separate routing table.

For more information on PIM, see the *IP Multicast Technology Overview* document at:

[http://www.cisco.com/en/US/docs/ios-xml/ios/ipmulti\\_pim/configuration/xs-3s/imc\\_tech\\_oview.html](http://www.cisco.com/en/US/docs/ios-xml/ios/ipmulti_pim/configuration/xs-3s/imc_tech_oview.html)

## PIM Source Specific Multicast

PIM SSM is the routing protocol that supports the implementation of SSM and is derived from PIM SM. However, unlike PIM SM where data from all multicast sources are sent when there is a PIM join, the SSM feature forwards datagram traffic to receivers from only those multicast sources that the receivers have explicitly joined, thus optimizing bandwidth utilization and denying unwanted Internet broadcast traffic. Further, instead of the use of RP and shared trees, SSM uses information found on source addresses for a multicast group. This information is provided by receivers through the source addresses relayed to the last-hop devices by MLD membership reports, resulting in shortest-path trees directly to the sources.

In SSM, delivery of datagrams is based on the (S, G) channels. Traffic for one (S, G) channel consists of datagrams with an IPv6 unicast source address S and the multicast group address G as the IPv6 destination address. Systems receive this traffic by becoming members of the (S, G) channel. Signaling is not required, but receivers must subscribe or unsubscribe to (S, G) channels to receive or not receive traffic from specific sources.

MLD version 2 is required for SSM to operate. MLD allows the host to provide source information. Before SSM runs with MLD, SSM must be supported in the Cisco IPv6 device, the host where the application is running, and the application itself.

For more information on PIM Source-Specific Multicast, see the *IP Multicast: PIM Configuration Guide* at:

[http://www.cisco.com/en/US/docs/ios-xml/ios/ipmulti\\_pim/configuration/xe-3s/ip6-mcast-pim-ssm.html](http://www.cisco.com/en/US/docs/ios-xml/ios/ipmulti_pim/configuration/xe-3s/ip6-mcast-pim-ssm.html)

## Source Specific Multicast Mapping for IPv6

SSM mapping for IPv6 supports both static and dynamic Domain Name System (DNS) mapping for MLD version 1 receivers. This feature allows deployment of IPv6 SSM with hosts that are incapable of providing MLD version 2 support in their TCP/IP host stack and their IP multicast receiving application.

SSM mapping allows the device to look up the source of a multicast MLD version 1 report either in the running configuration of the device or from a DNS server. The device can then initiate an (S, G) join toward the source.

For more information on IPv6 Source Specific Multicast Mapping, see the *IP Multicast: PIM Configuration Guide* at:

[http://www.cisco.com/en/US/docs/ios-xml/ios/ipmulti\\_pim/configuration/xe-3s/ip6-mcast-ssm-map.html](http://www.cisco.com/en/US/docs/ios-xml/ios/ipmulti_pim/configuration/xe-3s/ip6-mcast-ssm-map.html)

## PIM-Sparse Mode

PIM-SM uses a pull model to deliver multicast traffic. Only network segments with active receivers that have explicitly requested the data receive the traffic.

PIM-SM distributes information about active sources by forwarding data packets on the shared tree. Because PIM-SM uses shared trees (at least, initially), it requires the use of a rendezvous point (RP). The RP must be administratively configured in the network.

For more information on PIM Sparse Mode, see the *IP Multicast: PIM Configuration Guide* at:

[http://www.cisco.com/en/US/docs/ios-xml/ios/ipmulti\\_pim/configuration/xe-3s/ip6-mcast-pim-sm.html](http://www.cisco.com/en/US/docs/ios-xml/ios/ipmulti_pim/configuration/xe-3s/ip6-mcast-pim-sm.html)

## Rendezvous Point

A rendezvous point (RP) is required only in networks running Protocol Independent Multicast sparse mode (PIM-SM). The protocol is described in RFC 2362.

For more information on RP, see the Configuring a Rendezvous Point guide at:  
[http://www.cisco.com/en/US/docs/ios/solutions\\_docs/ip\\_multicast/White\\_papers/rps.html](http://www.cisco.com/en/US/docs/ios/solutions_docs/ip_multicast/White_papers/rps.html)

The recommended methods for configuring an RP in a PIM-SM network are given below:

- Static RP
- Bootstrap router
- Anycast RP

## Configuring IPv6 Multicast

- [Enabling IPv6 Multicast Routing, page 42-6](#)
- [Disabling IPv6 Multicast Forwarding, page 42-7](#)
- [Disabling MLD Device-Side Processing, page 42-8](#)
- [Configuring MLD Protocol on an Interface, page 42-9](#)
- [Configuring a Rendezvous Point, page 42-10](#)
- [Configuring PIM SSM Options, page 42-11](#)
- [Disabling PIM SSM Multicast on an Interface, page 42-12](#)
- [Configuring IPv6 SSM Mapping, page 42-12](#)
- [Verifying IPv6 Multicast, page 42-13](#)

## Enabling IPv6 Multicast Routing

To enable IPv6 Multicast Routing feature, complete the following steps:

### SUMMARY STEPS

1. **enable**
2. **configure terminal**
3. **ipv6 multicast-routing [vrf *vrf-name*]**
4. **asr901-platf-multicast enable**

## DETAILED STEPS

	Command	Purpose
Step 1	<b>enable</b>  <b>Example:</b> Router> enable	Enables privileged EXEC mode. <ul style="list-style-type: none"> <li>Enter your password if prompted.</li> </ul>
Step 2	<b>configure terminal</b>  <b>Example:</b> Router# configure terminal	Enters global configuration mode.
Step 3	<b>ipv6 multicast-routing [vrf vrf-name]</b>  <b>Example:</b> Router(config)# ipv6 multicast-routing	Enables multicast routing on all IPv6-enabled interfaces and enables multicast forwarding for PIM and MLD on all enabled interfaces of the device.
Step 4	<b>asr901-platf-multicast enable</b>  <b>Example:</b> Router(config)# asr901-platf-multicast enable	Enables platform multicast routing.

## Disabling IPv6 Multicast Forwarding

This procedure disables IPv6 multicast forwarding on the router. The IPv6 multicast forwarding is turned on by default when IPv6 multicast routing is enabled.

To disable IPv6 multicast forwarding, complete the following steps:

## SUMMARY STEPS

1. **enable**
2. **configure terminal**
3. **no ipv6 mfib**

## DETAILED STEPS

	Command	Purpose
Step 1	<b>enable</b>  <b>Example:</b> Router> enable	Enables privileged EXEC mode. <ul style="list-style-type: none"> <li>Enter your password if prompted.</li> </ul>

	Command	Purpose
Step 2	<b>configure terminal</b>  <b>Example:</b> Router# configure terminal	Enters global configuration mode.
Step 3	<b>no ipv6 mfib</b>  <b>Example:</b> Router(config)# no ipv6 mfib	Disables IPv6 multicast forwarding on the router.

## Disabling MLD Device-Side Processing

MLD is enabled on every interface when IPv6 multicast routing is configured. This procedure disables MLD router side processing on that interface. The router stops sending MLD queries and stops keeping track of MLD members on the LAN. If the **ipv6 mld join-group** command is configured on this interface, the interface continues with the MLD host functionality and report group membership when MLD query is received.

To turn off MLD device-side processing on a specified interface, complete the following steps:

### SUMMARY STEPS

1. **enable**
2. **configure terminal**
3. **interface type number**
4. **no ipv6 mld router**

### DETAILED STEPS

	Command	Purpose
Step 1	<b>enable</b>  <b>Example:</b> Router> enable	Enables privileged EXEC mode. <ul style="list-style-type: none"> <li>• Enter your password if prompted.</li> </ul>
Step 2	<b>configure terminal</b>  <b>Example:</b> Router# configure terminal	Enters global configuration mode.

	Command	Purpose
Step 3	<b>interface</b> <i>type number</i>  <b>Example:</b> Router(config)# interface GigabitEthernet 0/1	Specifies an interface type and number, and places the device in interface configuration mode.
Step 4	<b>no ipv6 mld router</b>  <b>Example:</b> Router(config)# no ipv6 mld router	Disables MLD device-side processing on a specified interface.

## Configuring MLD Protocol on an Interface

To configure Multicast Listener Discovery Protocol on an interface, complete the following steps:

### SUMMARY STEPS

1. **enable**
2. **configure terminal**
3. **interface** *type number*
4. **ipv6 mld query-interval** *seconds*
5. **ipv6 mld query-max-response-time** *seconds*
6. **ipv6 mld query-timeout** *seconds*
7. **ipv6 mld join-group** [*group-address*] [[**include** | **exclude**] {**source-address** | *source-list* [*acl*]}]
8. **ipv6 mld static-group** [*group-address*] [[**include** | **exclude**] {**source-address** | *source-list* [*acl*]}]

### DETAILED STEPS

	Command	Purpose
Step 1	<b>enable</b>  <b>Example:</b> Router> enable	Enables privileged EXEC mode. <ul style="list-style-type: none"> <li>• Enter your password if prompted.</li> </ul>
Step 2	<b>configure terminal</b>  <b>Example:</b> Router# configure terminal	Enters global configuration mode.
Step 3	<b>interface</b> <i>type number</i>  <b>Example:</b> Router(config)# interface gigabitethernet 0/1	Specifies an interface type and number, and enters interface configuration mode.

	Command	Purpose
Step 4	<pre>ipv6 mld query-interval seconds</pre> <p><b>Example:</b> Router(config-if)# ipv6 mld query-interval 60</p>	Configures the frequency of MLD Host-Query packets transmitted. A designated router for a LAN is the only router that transmits queries. The default value is 60 seconds.
Step 5	<pre>ipv6 mld query-max-response-time seconds</pre> <p><b>Example:</b> Router(config-if)# ipv6 mld query-max-response-time 20</p>	Specifies the maximum query response time advertised in the MLD queries. Default value is 10 seconds. Configuring a value less than 10 seconds enables the router to prune groups faster.
Step 6	<pre>ipv6 mld query-timeout seconds</pre> <p><b>Example:</b> Router(config-if)# ipv6 mld query-timeout 130</p>	Specifies the timeout for the router to take over as the querier for the interface, after the previous querier has stopped querying. The default value is 2 * query-interval. If the router hears no queries for the <i>timeout</i> period, it becomes the querier.
Step 7	<pre>ipv6 mld join-group [group-address] [[include   exclude] {source-address   source-list [acl]]</pre> <p><b>Example:</b> Router(config-if)# ipv6 mld join-group FF04::12 exclude 2001:DB8::10::11</p>	Configures MLD reporting for given <i>group</i> with MLDv1 or given <i>source</i> and <i>group</i> with MLDv2. The packets that are addressed to this group address are passed up to the client process in the router as well forwarded out the interface.
Step 8	<pre>ipv6 mld static-group [group-address] [[include   exclude] {source-address   source-list [acl]]</pre> <p><b>Example:</b> Router(config-if)# ipv6 mld static-group ff04::10 include 100::1</p>	Configures forwarding of traffic for the multicast group onto this interface and behave as if an MLD joiner was present on the interface. The packets to the group get fastswitched or hardware switched (whatever is available on the platform).  <b>Note</b> This command is not a sufficient condition for traffic to be forwarded onto the interface. Other conditions such as absence of a route, not being the DR or losing an assert can cause the router to not forward traffic even if the command is configured.

## Configuring a Rendezvous Point

To configure a rendezvous point (RP) in a Protocol Independent Multicast sparse mode (PIM-SM) network, see the Configuring a Rendezvous Point guide at:

[http://www.cisco.com/en/US/docs/ios/solutions\\_docs/ip\\_multicast/White\\_papers/rps.html](http://www.cisco.com/en/US/docs/ios/solutions_docs/ip_multicast/White_papers/rps.html)

This guide provides scenario descriptions and basic configuration examples for the following options:

- Static RP
- Bootstrap router
- Anycast RP



## Configuring PIM SSM Options

To configure PIM Source-Specific Multicast options, complete the following steps.

### SUMMARY STEPS

1. **enable**
2. **configure terminal**
3. **ipv6 pim**
4. **interface** *type number*
5. **ipv6 pim hello-interval** *interval-in-seconds*
6. **ipv6 pim join-prune-interval** *interval-in-seconds*

### DETAILED STEPS

	Command	Purpose
Step 1	<b>enable</b>  <b>Example:</b> Router> enable	Enables privileged EXEC mode. <ul style="list-style-type: none"> <li>• Enter your password if prompted.</li> </ul>
Step 2	<b>configure terminal</b>  <b>Example:</b> Router# configure terminal	Enters global configuration mode.
Step 3	<b>ipv6 pim</b>  <b>Example:</b> Router(config)# ipv6 pim	Configures PIM, if it is disabled. PIM runs on every interface after configuring IPv6 multicast routing.
Step 4	<b>interface</b> <i>type number</i>  <b>Example:</b> Router(config)# interface gigabitethernet 0/1	Specifies an interface type and number, and enters interface configuration mode.
Step 5	<b>ipv6 pim hello-interval</b> <i>interval-in-seconds</i>  <b>Example:</b> Router(config-if)# ipv6 pim hello-interval 45	Configures periodic hello interval for this interface. Default is 30 seconds. Periodic hellos are sent out at intervals randomized by a small amount instead of on exact periodic interval.
Step 6	<b>ipv6 pim join-prune-interval</b> <i>interval-in-seconds</i>  <b>Example:</b> Router(config-if)# ipv6 pim join-prune-interval 75	Configures periodic Join-Prune announcement interval for this interface. Default is 60 seconds.

## Disabling PIM SSM Multicast on an Interface

To disable PIM SSM multicast on a specified interface, complete the following steps.

### SUMMARY STEPS

1. **enable**
2. **configure terminal**
3. **interface** *type number*
4. **no ipv6 pim**

### DETAILED STEPS

	Command	Purpose
Step 1	<b>enable</b>  <b>Example:</b> Router> enable	Enables privileged EXEC mode. <ul style="list-style-type: none"> <li>• Enter your password if prompted.</li> </ul>
Step 2	<b>configure terminal</b>  <b>Example:</b> Router# configure terminal	Enters global configuration mode.
Step 3	<b>interface</b> <i>type number</i>  <b>Example:</b> Router(config)# interface gigabitethernet 0/1	Specifies an interface type and number, and enters interface configuration mode.
Step 4	<b>no ipv6 pim</b>  <b>Example:</b> Router(config-if)# ipv6 multicast-routing	Disables PIM on the specified interface.

## Configuring IPv6 SSM Mapping

When the SSM mapping feature is enabled, DNS-based SSM mapping is automatically enabled, which means that the device looks up the source of a multicast MLD version 1 report from a DNS server.

You can configure either DNS-based or static SSM mapping, depending on your device configuration. If you choose to use static SSM mapping, you can configure multiple static SSM mappings. If multiple static SSM mappings are configured, the source addresses of all matching access lists are used.

To configure IPv6 SSM mapping, complete the following steps.

### SUMMARY STEPS

1. **enable**

2. **configure terminal**
3. **ipv6 mld [vrf vrf-name] ssm-map enable**
4. **ipv6 mld [vrf vrf-name] ssm-map static access-list source-address**
5. **no ipv6 mld [vrf vrf-name] ssm-map query dns**

## DETAILED STEPS

	Command	Purpose
Step 1	<b>enable</b>  <b>Example:</b> Router> enable	Enables privileged EXEC mode.  • Enter your password if prompted.
Step 2	<b>configure terminal</b>  <b>Example:</b> Router# configure terminal	Enters global configuration mode.
Step 3	<b>ipv6 mld [vrf vrf-name] ssm-map enable</b>  <b>Example:</b> Router(config-if)# ipv6 mld ssm-map enable	Enables the SSM mapping feature for groups in the configured SSM range.  <b>Note</b> You should first create ACL to define the group that needs to be mapped.
Step 4	<b>ipv6 mld [vrf vrf-name] ssm-map static access-list source-address</b>  <b>Example:</b> Router(config-if)# ipv6 mld ssm-map static SSM_MAP_ACL_2 2001:DB8:1::1	Configures static SSM mappings.
Step 5	<b>no ipv6 mld [vrf vrf-name] ssm-map query dns</b>  <b>Example:</b> Router(config-if)# ipv6 mld ssm-map query dns	Disables DNS-based SSM mapping.  <b>Note</b> You must disable SSM-map query dns when static mapping is configured.

## Verifying IPv6 Multicast

Use the **show** commands listed below to verify the IPv6 Multicast configuration.

To display the group membership information on various interfaces on a router, use the **show** command described in the following example.

```
Router# show ipv6 mld groups

MLD Connected Group Membership
Group Address Interface Uptime Expires
FF0E::E0:1:1:1 FastEthernet4/10 04:25:51 00:03:38
```

To display the MLD interface specific parameters, use the **show** command described in the following example.

```
Router# show ipv6 mld interface gigabitethernet 0/1
```

```
FastEthernet4/10 is up, line protocol is up
Internet address is FE80::204:6DFF:FE87:6400/10
MLD is enabled on interface
Current MLD version is 2
MLD query interval is 125 seconds
MLD querier timeout is 60 seconds
MLD max query response time is 10 seconds
Last member query response interval is 1 seconds
Inbound MLD access group is:
MLD activity: 6 joins, 0 leaves
MLD querying router is FE80::1:1:3
```

To display the MLD traffic counters, use the **show** command described in the following example.

```
Router# show ipv6 mld traffic
```

```
MLD Traffic Counters
Elapsed time since counters cleared: 04:27:23
Received Sent
Valid MLD Packets 1634 1469
Queries 269 654
Reports 548 815
Leaves 0 0
Mtrace packets 0 0
Errors:
Malformed Packets 0
Bad Checksums 0
Martian source 0
Packets Received on MLD-disabled Interface 0
```

To display interface specific information for PIM, use the **show** command described in the following example.

```
Router# show ipv6 pim interface
```

Interface	PIM	Nbr Count	Hello Intvl	DR Prior
Null0	off	0	30	1
Address: FE80::1				
DR : not elected				
FastEthernet0/0	off	0	30	1
Address: ::				
DR : not elected				
GigabitEthernet0/8	off	0	30	1
Address: ::				
DR : not elected				
GigabitEthernet0/9	off	0	30	1
Address: ::				
DR : not elected				
Gi0/10	off	0	30	1
Address: ::				
DR : not elected				
Gi0/11	off	0	30	1
Address: ::				
DR : not elected				
GigabitEthernet0/0	off	0	30	1
Address: ::				

```

DR      : not elected
GigabitEthernet0/1 off  0   30   1
Address: ::
DR      : not elected
GigabitEthernet0/2 off  0   30   1
Address: ::
DR      : not elected
GigabitEthernet0/3 off  0   30   1
Address: ::
DR      : not elected
GigabitEthernet0/4 off  0   30   1
Address: ::
DR      : not elected
GigabitEthernet0/5 off  0   30   1
Address: ::
DR      : not elected
GigabitEthernet0/6 off  0   30   1
Address: ::
DR      : not elected
GigabitEthernet0/7 off  0   30   1
Address: ::
DR      : not elected
Vlan1   off  0   30   1
Address: ::
DR      : not elected
Loopback0 on  0   30   1
Address: FE80::4255:39FF:FE89:69CC
DR      : this system
Port-channel2 off  0   30   1
Vlan10  on  1   30   1
Address: FE80::4255:39FF:FE89:69C8
DR      : FE80::4255:39FF:FE89:7404
Vlan20  off  0   30   1
Address: ::
DR      : not elected
Vlan30  off  0   30   1
Address: ::
DR      : not elected
Vlan100 on  0   30   1
Address: FE80::4255:39FF:FE89:69C8
DR      : this system
Tunnel0 off  0   30   1
Address: FE80::4255:39FF:FE89:69CC
DR      : not elected
Tunnel1 off  0   30   1
Address: FE80::4255:39FF:FE89:69CC
DR      : not elected

```

To display the number of (\*, G) and (S, G) membership reports present in the MLD cache, use the **show** command described in the following example.

```
Router# show ipv6 mld groups summary
```

```

MLD Route Summary
No. of (*,G) routes = 6
No. of (S,G) routes = 0

```

To display the number of PIM neighbors on each interface, as well as, the total number of PIM neighbors, use the **show** command described in the following example.

```
Router# show ipv6 pim neighbor count
```

```

Interface          Nbr count
Vlan300            0
Vlan100            0
Vlan10             1
Loopback0         0

Total Nbrs        1

```

To display the number of PIM neighbors discovered, use the **show** command described in the following example.

```
Router# show ipv6 pim neighbor
```

```

Neighbor Address Interface Uptime Expires DR pri Bidir
FE80::1:1:3 FastEthernet4/10 04:27:15 00:01:23 1 B

```

To display the information in the PIM topology table in a format similar to the **show ip mroute** command, use the **show** command described in the following example.

```
Router# show ipv6 mroute
```

```

Multicast Routing Table
Flags: D - Dense, S - Sparse, B - Bidir Group, s - SSM Group,
C - Connected, L - Local, I - Received Source Specific Host Report,
P - Pruned, R - RP-bit set, F - Register flag, T - SPT-bit set,
J - Join SPT
Timers: Uptime/Expires
Interface state: Interface, State
(*, FF0E::E0:1:1:1), 04:26:01/00:02:36, RP 51::1:1:2, flags: SCJ
Incoming interface: Tunnel1
RPF nbr: 51::1:1:2
Outgoing interface list:
FastEthernet4/10, Forward, 04:26:01/00:02:36
(47::1:1:3, FF0E::E0:1:1:1), 04:25:32/00:01:47, flags: SFJT
Incoming interface: Vlan47
RPF nbr: 47::1:1:3, Registering
Outgoing interface list:
FastEthernet4/10, Forward, 04:25:27/00:03:02
Tunnel0, Forward, 04:25:28/never

```

To display PIM topology table for given group or all groups, use the **show** command described in the following example.

```
Router# show ipv6 pim topology
```

```

IP PIM Multicast Topology Table
Entry state: (*S,G)[RPT/SPT] Protocol Uptime Info
Entry flags: KAT - Keep Alive Timer, AA - Assume Alive, PA - Probe Alive,
RA - Really Alive, LH - Last Hop, DSS - Don't Signal Sources,
RR - Register Received, SR - Sending Registers,
E - MSDP External, DCC - Don't Check Connected
Interface state: Name, Uptime, Fwd, Info
Interface flags: LI - Local Interest, LD - Local Dissinterest,
II - Internal Interest, ID - Internal Dissinterest,
LH - Last Hop, AS - Assert, AB - Admin Boundary
(*,FF0E::E0:1:1:1)
SM UP: 04:27:50 JP: Join(never) Flags: LH
RP: 51::1:1:2*
RPF: Tunnel1,51::1:1:2*
FastEthernet4/10 04:27:50 fwd Join(00:02:48) LI LH
(47::1:1:3,FF0E::E0:1:1:1)

```

```
SM SPT UP: 04:27:20 JP: Join(never) Flags: KAT(00:01:04) AA PA RA SR
RPF: Vlan47,47::1:1:3*
FastEthernet4/10 04:27:16 fwd Join(00:03:14)
Tunnel0 04:27:17 fwd
```

To display the count of the ranges, (\*, G), (S, G) and (S, G) RPT routes in the pim topology tables, use the **show** command described in the following example.

```
Router# show ipv6 pim topology route-count
```

```
PIM TT Summary
No. of group ranges = 47
No. of (*,G) routes = 7
No. of (S,G) routes = 1
No. of (S,G)RPT routes = 0
```

To display the IP multicast group mapping table, use the **show** command described in the following example. It shows group to mode mapping and RP information in case of sparse-mode groups.

```
Router# show ipv6 pim group-map FF0E::E0:1:1:1
```

```
FF00::/8*
RP : 51::1:1:2
Protocol: SM
Client : config
Groups : 1
Info : RPF: Tu1,51::1:1:2 (us)
```

To display the IPv6 multicast range-lists on a per client (config/autorp/BSR) and per mode (SSM/SM/DM/ Bidir) basis, use the **show** command described in the following example.

```
Router# show ipv6 pim range-list
```

```
Static SSM Exp: never Learnt from : ::
  FF33::/32 Up: 1d16h
  FF34::/32 Up: 1d16h
  FF35::/32 Up: 1d16h
  FF36::/32 Up: 1d16h
  FF37::/32 Up: 1d16h
  FF38::/32 Up: 1d16h
  FF39::/32 Up: 1d16h
  FF3A::/32 Up: 1d16h
  FF3B::/32 Up: 1d16h
  FF3C::/32 Up: 1d16h
  FF3D::/32 Up: 1d16h
  FF3E::/32 Up: 1d16h
  FF3F::/32 Up: 1d16h
BSR SM RP: 3::3 Exp: 00:02:03 Learnt from : 2::2
  FF00::/8 Up: 13:14:05
BSR SM RP: 4::4 Exp: 00:02:03 Learnt from : 2::2
  FF00::/8 Up: 13:13:03
```

To display information about the PIM register encapsulation and decapsulation tunnels, use the **show** command described in the following example.

```
Router# show ipv6 pim tunnel
```

```
Tunnel0*
Type : PIM Encap
RP : Embedded RP Tunnel
Source: 1::1
```

```
Tunnel1*
  Type : PIM Encap
  RP   : 4::4
  Source: 300::1
```

To display information about the PIM traffic counters, use the **show** command described in the following example.

```
Router# show ipv6 pim traffic

PIM Traffic Counters
Elapsed time since counters cleared: 04:31:40
Received Sent
Valid PIM Packets 1259 1637
Hello 717 2185
Join-Prune 542 0
Register 0 0
Register Stop 0 0
Assert 0 0
Bidir DF Election 0 0
Errors:
Malformed Packets 0
Bad Checksums 0
Send Errors 0
Packet Sent on Loopback Errors 548
Packets Received on PIM-disabled Interface 0
Packets Received with Unknown PIM Version 0
```

To display the average Join/Prune aggregation for the last (1000/10000/50000) packets for each interface, use the **show** command described in the following example.

```
Router# show ipv6 pim join-prune statistic

PIM Average Join/Prune Aggregation for last (1K/10K/50K) packets
Interface           MTU      Transmitted           Received
-----
Null0                1500     0 / 0 / 0            0 / 0 / 0
GigabitEthernet0/9  1280     0 / 0 / 0            0 / 0 / 0
Gi0/10               1280     0 / 0 / 0            0 / 0 / 0
Gi0/11               1280     0 / 0 / 0            0 / 0 / 0
GigabitEthernet0/0  1280     0 / 0 / 0            0 / 0 / 0
GigabitEthernet0/1  1280     0 / 0 / 0            0 / 0 / 0
GigabitEthernet0/2  1280     0 / 0 / 0            0 / 0 / 0
GigabitEthernet0/3  1280     0 / 0 / 0            0 / 0 / 0
GigabitEthernet0/4  1280     0 / 0 / 0            0 / 0 / 0
GigabitEthernet0/5  1280     0 / 0 / 0            0 / 0 / 0
GigabitEthernet0/6  1280     0 / 0 / 0            0 / 0 / 0
GigabitEthernet0/7  1280     0 / 0 / 0            0 / 0 / 0
Vlan1                1280     0 / 0 / 0            0 / 0 / 0
Loopback0            1514     0 / 0 / 0            0 / 0 / 0
Port-channel2        1280     0 / 0 / 0            0 / 0 / 0
Vlan10               1476     18 / 18 / 0          18 / 0 / 0
Vlan20               1500     0 / 0 / 0            0 / 0 / 0
Vlan30               1476     27 / 0 / 0           19 / 22 / 0
Vlan100              1500     0 / 0 / 0            0 / 0 / 0
Vlan300              1500     0 / 0 / 0            0 / 0 / 0
Tunnel0              1452     0 / 0 / 0            0 / 0 / 0
Tunnel1              1452     0 / 0 / 0            0 / 0 / 0
```



To display the MRIB table, use the **show** command described in the following example. All entries are created by various clients of MRIB, such as, MLD, PIM and MFIB. The flags on each entry or interface, serve as communication mechanism between various clients of MRIB.

```
Router# show ipv6 mrrib route FF0E::E0:1:1:1

IP Multicast Routing Information Base
Entry flags: L - Domain-Local Source, E - External Source to the Domain,
C - Directly-Connected Check, S - Signal, IA - Inherit Accept, D - Drop
Interface flags: F - Forward, A - Accept, IC - Internal Copy,
NS - Negate Signal, DP - Don't Preserve, SP - Signal Present,
II - Internal Interest, ID - Internal Disinterest, LI - Local
Interest,
LD - Local Disinterest
(*,FF0E::E0:1:1:1) RPF nbr: 51::1:1:2 Flags: C
FastEthernet4/10 Flags: F NS LI
Tunnell1 Flags: A NS
(47::1:1:3,FF0E::E0:1:1:1) RPF nbr: 47::1:1:3 Flags:
Vlan47 Flags: A
Tunnel0 Flags: F NS
FastEthernet4/10 Flags: F NS
```

To display the count of the number of routes in the Multicast RIB, use the **show** command described in the following example.

```
Router# show ipv6 mrrib route summary

MRIB Route-DB Summary
No. of (*,G) routes = 53
No. of (S,G) routes = 1
No. of Route x Interfaces (RxI) = 24
```

To display information about the various MRIB clients, use the **show** command described in the following example.

```
Router# show ipv6 mrrib client

IP MRIB client-connections
igmp:110 (connection id 0)
pim:162 (connection id 1)
mfib ipv6:3 (connection id 2)
```

To display information about the IPv6 Multicast Forwarding Information Base, in terms of forwarding entries and interfaces, use the **show** command described in the following example.

```
Router# show ipv6 mfrib FF0E::E0:1:1:1

IP Multicast Forwarding Information Base
Entry Flags: C - Directly Connected, S - Signal, IA - Inherit A flag,
AR - Activity Required, D - Drop
Forwarding Counts: Pkt Count/Pkts per second/Avg Pkt Size/Kbits per second
Other counts: Total/RPF failed/Other drops
Interface Flags: A - Accept, F - Forward, NS - Negate Signalling
IC - Internal Copy, NP - Not platform switched
SP - Signal Present
Interface Counts: FS Pkt Count/PS Pkt Count
(*,FF0E::E0:1:1:1) Flags: C
Forwarding: 0/0/0/0, Other: 0/0/0
Tunnell1 Flags: A NS
FastEthernet4/10 Flags: F NS
Pkts: 0/0
(47::1:1:3,FF0E::E0:1:1:1) Flags:
```

```
Forwarding: 9592618/0/182/0, Other: 0/0/0
Vlan47 Flags: A
Tunnel0 Flags: F NS
Pkts: 0/0
FastEthernet4/10 Flags: F NS
Pkts: 0/9592618
```

To display the general MFIB configuration status and operational status, use the **show** command described in the following example.

```
Router# show ipv6 mfib status

IPv6 Multicast Forwarding (MFIB) status:
  Configuration Status: enabled
  Operational Status: running
  Initialization State: Running
  Total signalling packets queued: 0
  Process Status: may enable - 3 - pid 323
  Tables 1/1/0 (active/mrib/io)
```

To display summary information about the number of IPv6 MFIB entries and interfaces, use the **show** command described in the following example.

```
Router# show ipv6 mfib summary

Default
 356 prefixes (356/0/0 fwd/non-fwd/deleted)
 634 ioitems (634/0/0 fwd/non-fwd/deleted)
Forwarding prefixes: [200 (S,G), 110 (*,G), 46 (*,G/m)]
Table id 0x0, instance 0x10B78770
Database: epoch 0
```

To display the IPv6 multicast-enabled interfaces and their forwarding status, use the **show** command described in the following example.

```
Router# show ipv6 mfib interface

IPv6 Multicast Forwarding (MFIB) status:
Configuration Status: enabled
Operational Status: running
MFIB interface status CEF-based output
[configured,available]
Loopback0 up [yes ,? ]
Vlan46 up [yes ,? ]
Vlan47 up [yes ,? ]
Tunnel0 down [yes ,no ]
Tunnel1 down [yes ,no ]
```

To display how IPv6 multicast routing does Reverse Path Forwarding, use the **show** command described in the following example.

```
Router# show ipv6 rpf FE80::4255:39FF:FE89:7404

RPF information for 3::3
  RPF interface: Vlan10
  RPF neighbor: FE80::4255:39FF:FE89:7404
  RPF route/mask: 3::3/128
  RPF type: Unicast
  RPF recursion count: 0
  Metric preference: 110
  Metric: 2
```

# Configuration Examples for IPv6 Multicast

- [Example: Enabling IPv6 Multicast Routing, page 42-21](#)
- [Example: Configuring IPv6 SSM Mapping, page 42-21](#)
- [Example: Configuring Rendezvous Point, page 42-21](#)

## Example: Enabling IPv6 Multicast Routing

The following is a sample configuration of IPv6 Multicast feature on the Cisco ASR 901 router.

```
!  
Current configuration : 64 bytes  
!  
interface Vlan100  
  no ip address  
  ipv6 address 100::1/64  
end  
!
```

## Example: Configuring IPv6 SSM Mapping

The following is a sample configuration of IPv6 SSM mapping on the Cisco ASR 901 router.

```
!  
Building configuration...  
  
Current configuration : 111 bytes  
!  
interface Vlan110  
  asr901-multicast source  
  no ip address  
  ipv6 address 110::1/64  
  ipv6 ospf 100 area 0  
end  
!
```

## Example: Configuring Rendezvous Point

For a sample configuration of RP, see the [Configuring a Rendezvous Point](http://www.cisco.com/en/US/docs/ios/solutions_docs/ip_multicast/White_papers/rps.html) guide at:  
[http://www.cisco.com/en/US/docs/ios/solutions\\_docs/ip\\_multicast/White\\_papers/rps.html](http://www.cisco.com/en/US/docs/ios/solutions_docs/ip_multicast/White_papers/rps.html)

## Troubleshooting Tips

Use the following **debug** commands to enable the debug feature to help in troubleshooting the IPv6 Multicast feature on the Cisco ASR 901 router:

**Caution**

We suggest you do not use these debug commands without TAC supervision.

Command Name	Description
<b>[no] debug ipv6 mld</b>	Enables debugging MLD protocol activity.
<b>[no] debug ipv6 pim</b>	Enables debugging PIM protocol activity.
<b>[no] debug ipv6 pim neighbor</b>	Enables debugging for PIM Hello message processing.
<b>[no] debug ipv6 mrrib route</b>	Enables debugging MRIB routing entry related activity.
<b>[no] debug ipv6 mrrib client</b>	Enables debugging MRIB client management activity.
<b>[no] debug ipv6 mrrib io</b>	Enables debugging MRIB I/O events.
<b>[no] debug ipv6 mrrib table</b>	Enables debugging MRIB table management activity.
<b>[no] debug ipv6 mrrib proxy</b>	Enables debugging of MRIB proxy activity between route processor and linecards.
<b>[no] debug ipv6 mfib</b>	Enables debugging IPv6 MFIB activity.

# Additional References

The following sections provide references related to IPv6 Multicast feature.

## Related Documents

Related Topic	Document Title
Cisco IOS Commands	<a href="#">Cisco IOS Master Commands List, All Releases</a>
Cisco ASR 901 Router Commands	<a href="#">Cisco ASR 901 Series Aggregation Services Router Command Reference</a>

## Standards

Standard	Title
None	—

## MIBs

MIB	MIBs Link
None	To locate and download MIBs for selected platforms, Cisco IOS releases, and feature sets, use Cisco MIB Locator found at the following URL: <a href="http://www.cisco.com/go/mibs">http://www.cisco.com/go/mibs</a>

## RFCs

RFC	Title
RFC 2710	<a href="#">Multicast Listener Discovery (MLD) for IPv6</a>

## Technical Assistance

Description	Link
The Cisco Technical Support website contains thousands of pages of searchable technical content, including links to products, technologies, solutions, technical tips, and tools. Registered Cisco.com users can log in from this page to access even more content.	<a href="http://www.cisco.com/techsupport">http://www.cisco.com/techsupport</a>

## Feature Information for IPv6 Multicast

Table 42-1 lists the features in this module and provides links to specific configuration information.

Use Cisco Feature Navigator to find information about platform support and software image support. Cisco Feature Navigator enables you to determine which software images support a specific software release, feature set, or platform. To access Cisco Feature Navigator, go to <http://www.cisco.com/go/cfn>. An account on Cisco.com is not required.

**Note**

Table 42-1 lists only the software release that introduced support for a given feature in a given software release train. Unless noted otherwise, subsequent releases of that software release train also support that feature.

**Table 42-1** Feature Information for IPv6 Multicast

Feature Name	Releases	Feature Information
IPv6 Multicast	15.4(1)S	<p>This feature was introduced on the Cisco ASR 901 routers.</p> <p>The following section provides information about this feature:</p> <ul style="list-style-type: none"> <li>• <a href="#">Feature Overview, page 42-2</a></li> <li>• <a href="#">IPv6 Multicast Routing Implementation, page 42-3</a></li> <li>• <a href="#">Configuring IPv6 Multicast, page 42-6</a></li> </ul> <p><b>Platform-Independent Cisco IOS Software Documentation</b></p> <p>See the “<a href="#">Configuring Basic IP Multicast in IPv6 Networks</a>” chapter of the <i>IP Multicast: PIM Configuration Guide</i>.</p>

Table 42-1 Feature Information for IPv6 Multicast

Feature Name	Releases	Feature Information
IPv6 Multicast: Multicast Listener Discovery Protocol, Versions 1 and 2	15.4(1)S	<p>This feature was introduced on the Cisco ASR 901 routers. The following section provides information about this feature:</p> <ul style="list-style-type: none"> <li>• <a href="#">Multicast Listener Discovery Protocol for IPv6, page 42-3</a></li> <li>• <a href="#">Configuring MLD Protocol on an Interface, page 42-9</a></li> </ul> <p><b>Platform-Independent Cisco IOS Software Documentation</b> See the “<a href="#">IPv6 Multicast Listener Discovery Protocol</a>” chapter of the <i>IP Multicast: LSM Configuration Guide</i>.</p>
IPv6 Multicast: PIM Source-Specific Multicast	15.4(1)S	<p>This feature was introduced on the Cisco ASR 901 routers. The following section provides information about this feature:</p> <ul style="list-style-type: none"> <li>• <a href="#">PIM Source Specific Multicast, page 42-5</a></li> <li>• <a href="#">Configuring PIM SSM Options, page 42-11</a></li> <li>• <a href="#">Configuring IPv6 SSM Mapping, page 42-12</a></li> </ul> <p><b>Platform-Independent Cisco IOS Software Documentation</b> See the “<a href="#">IPv6 Multicast: PIM Source-Specific Multicast</a>” chapter of the <i>IP Multicast: PIM Configuration Guide</i>.</p>







# Configuring Switched Port Analyzer

---

This feature module describes how to configure a switched port analyzer (SPAN) on the Cisco ASR 901 Router.

## Finding Feature Information

Your software release may not support all the features documented in this module. For the latest feature information and caveats, see the release notes for your platform and software release. To find information about the features documented in this module, and to see a list of the releases in which each feature is supported, see the [“Feature Information for Switched Port Analyzer”](#) section on page 43-9.

Use Cisco Feature Navigator to find information about platform support and Cisco software image support. To access Cisco Feature Navigator, go to <http://www.cisco.com/go/cfn>. An account on Cisco.com is not required.

## Contents

- [SPAN Limitations and Configuration Guidelines, page 43-1](#)
- [Understanding SPAN, page 43-2](#)
- [Configuring SPAN, page 43-4](#)
- [Additional References, page 43-8](#)
- [Feature Information for Switched Port Analyzer, page 43-9](#)

## SPAN Limitations and Configuration Guidelines

The following limitations and configuration guidelines apply when configuring SPAN on the Cisco ASR 901 Router:

- Only one SPAN session is supported.
- Only one local SPAN destination interface is supported.
- You cannot configure a local SPAN destination interface to receive ingress traffic.
- Use a network analyzer to monitor interfaces.
- Outgoing CDP and BPDU packets are not replicated.

- Ethernet loopback and Traffic generator are not supported when SPAN is enabled. For egress SPAN, the traffic is mirrored before egress xlate translation.
- Egress SPAN is only supported for port and not supported for VLAN, EFP, or Port-Channel interfaces.
- When you specify source interfaces and do not specify a traffic type [Transmit (Tx), Receive (Rx), or Both], both type is used by default.
- Use the **no monitor session** *session\_number* command with no other parameters to clear the SPAN session number.

## Understanding SPAN

The following sections describe SPAN:

- [Overview, page 43-2](#)
- [SPAN Session, page 43-3](#)
- [Source Interface, page 43-3](#)
- [Destination Interface, page 43-4](#)
- [Traffic Types, page 43-4](#)
- [SPAN Traffic, page 43-4](#)

## Overview

Effective with Cisco IOS Release 15.4(1)S, the Cisco ASR 901 supports Local SPAN. Local SPAN supports a SPAN session entirely within one switch. You can analyze network traffic passing through ports or VLANs by using SPAN to send a copy of the traffic to another port on the switch that has been connected to a network analyzer or other monitoring or security devices. SPAN copies (or mirrors) traffic received or sent (or both) on source ports to a destination port for analysis. SPAN does not affect the switching of network traffic on the source ports, VLANs, or EFPs. You must dedicate the destination port for SPAN use. Except for traffic that is required for the SPAN session, destination ports do not receive or forward traffic.

Only traffic that enters or leaves source ports or traffic that enters or leaves source VLANs or EFPs can be monitored by using SPAN; traffic routed to a source VLAN cannot be monitored. For example, if incoming traffic is being monitored, traffic that gets routed from another VLAN to the source VLAN cannot be monitored; however, traffic that is received on the source VLAN and routed to another VLAN can be monitored. You can use the SPAN destination port to inject traffic from a network security device.

In [Figure 43-1](#), all traffic on Ethernet port 5 (the source port) is mirrored on Ethernet port 10. A network analyzer on Ethernet port 10 receives all the network traffic from Ethernet port 5 without being physically attached to Ethernet port 5.

Figure 43-1 Example of Local SPAN Configuration

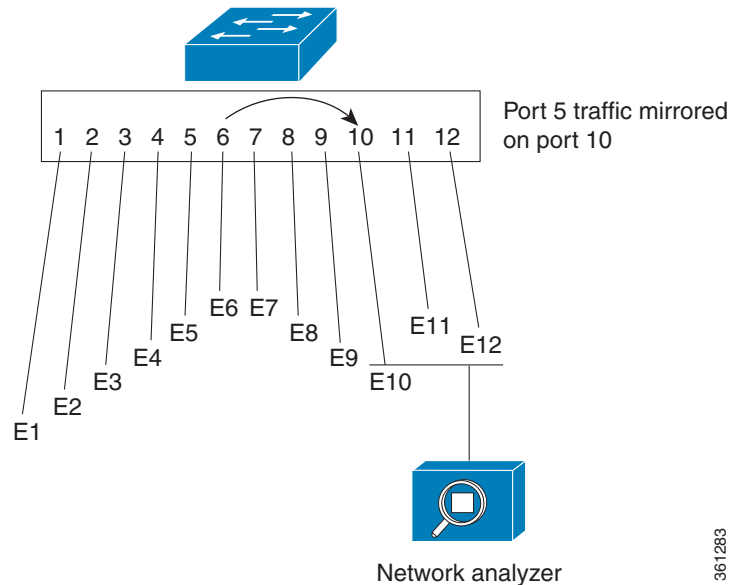

SPAN does not affect the switching of network traffic that is received on source ports; a copy of the packets that are received by the source ports is still sent to the destination port.

## SPAN Session

A local SPAN session is an association of a destination interface with a set of source interfaces. You configure SPAN sessions using parameters that specify the type of network traffic to monitor. SPAN sessions allow you to monitor traffic on one or more interfaces and to send either ingress traffic, egress traffic, or both to one destination interface. You can configure a SPAN session with separate sets of SPAN source interfaces or VLANs; overlapping sets are not supported.

SPAN sessions do not interfere with the normal operation of the switch. The **show monitor session all** command displays the operational status of a SPAN session.

A SPAN session remains inactive after system power-up until the destination interface is operational.

## Source Interface

A source interface (also called a monitored interface) is an interface monitored for network traffic analysis.

A source interface has these characteristics:

- A single VLAN, EFP, or port-channel source per session is supported for ingress.
- A single physical source port is supported for ingress and egress.
- A maximum of five physical ports can be used in a single session for ingress SPAN (Rx).
- When an interface is configured as a destination interface, it cannot be configured as a source interface.

## Destination Interface

A destination interface (also called a monitoring interface) is a switched interface to which SPAN sends packets for analysis. You can have only one SPAN destination interface.

A destination interface has these restrictions:

- It needs to be a single physical port.
- It cannot be used as an ingress interface.
- When an interface is configured as a destination interface, it cannot be configured as a source interface.

## Traffic Types

Ingress SPAN (Rx) copies network traffic received by the source interfaces for analysis at the destination interface. Egress SPAN (Tx) copies network traffic transmitted from the source interfaces. Specifying the configuration option both copies network traffic received and transmitted by the source interfaces to the destination interface.

## SPAN Traffic

Network traffic, including multicast, can be monitored using local SPAN. Multicast packet monitoring is enabled by default. In some local SPAN configurations, multiple copies of the same source packet are sent to the local SPAN destination interface. For example, a bidirectional (both ingress and egress) local SPAN session is configured for sources a1 and a2 to a destination interface d1. If a packet enters the switch through a1 and gets switched to a2, both incoming and outgoing packets are sent to destination interface d1; both packets would be the same (unless a Layer-3 rewrite had occurred, in which case the packets would be different).

## Configuring SPAN

The following sections describe how to configure SPAN:

- [Creating a SPAN Session, page 43-4](#)
- [Removing Sources or Destination from a SPAN Session, page 43-5](#)

## Creating a SPAN Session

To create a SPAN session:

### SUMMARY STEPS

1. **enable**
2. **configure terminal**
3. **monitor session** {*session\_number*} **type local**

4. **source** {**interface interface\_type slot/port**} | {**vlan vlan\_ID**} | {**service instance id interface\_type slot/port**} [, | - | **rx** | **tx** | **both**]
5. **destination** {**interface interface\_type slot/port**}
6. **no shutdown**

## DETAILED STEPS

	Command	Purpose
Step 1	<b>enable</b>  <b>Example:</b> Router> enable	Enables privileged EXEC mode. <ul style="list-style-type: none"> <li>• Enter your password if prompted.</li> </ul>
Step 2	<b>configure terminal</b>  <b>Example:</b> Router# configure terminal	Enters global configuration mode.
Step 3	<b>monitor session</b> { <i>session_number</i> } <b>type local</b>  <b>Example:</b> Router(config)# monitor session 1 type local	Specifies the SPAN session number.
Step 4	<b>source</b> { <b>interface interface_type slot/port</b> }   { <b>vlan vlan_ID</b> }   { <b>service instance id interface_type slot/port</b> } [,   -   <b>rx</b>   <b>tx</b>   <b>both</b> ]  <b>Example:</b> Router(config-mon-local)# source interface gigabitethernet 0/8	Specifies the source interfaces, VLANs, or service instances, and the traffic direction to be monitored.
Step 5	{ <b>destination</b> { <b>interface interface_type slot/port</b> }}  <b>Example:</b> Router(config-mon-local)# destination interface gigabitethernet 0/11	Specifies the destination interface.
Step 6	<b>no shutdown</b>  <b>Example:</b> Router(config-mon-local)# no shutdown	Enables the SPAN session using the <b>no shutdown</b> command.

## Removing Sources or Destination from a SPAN Session

To remove sources or destination from a SPAN session, use the following commands beginning in executive mode:

## SUMMARY STEPS

1. **enable**
2. **configure terminal**
3. **no monitor session** *session\_number*

## DETAILED STEPS

	Command	Purpose
Step 1	<b>enable</b>  <b>Example:</b> Router> enable	Enables privileged EXEC mode.  <ul style="list-style-type: none"> <li>• Enter your password if prompted.</li> </ul>
Step 2	<b>configure terminal</b>  <b>Example:</b> Router# configure terminal	Enters global configuration mode.
Step 3	<b>no monitor session</b> <i>session_number</i>  <b>Example:</b> Router(config)# no monitor session 1	Clears existing SPAN configuration for a session.

## Configuration Examples for SPAN

This section shows a sample configuration for local SPAN session on Cisco ASR 901 Router:

```
monitor session 1 type local
source interface gigabitEthernet 0/8 tx
destination interface gigabitEthernet 0/11
no shut
exit
```

## Verifying Local SPAN

The following is sample output from the **show monitor session all** command.

```
Session 1
-----
Type                : Local Session
Status              : Admin Enabled
Source Ports        :
  TX Only           : Gi0/8
Destination Ports   : Gi0/11
Encapsulation       : Native
  Ingress           : Disabled
```

The following is sample output from the **show monitor session all detail** command.

```
Session 1
-----
Type                : Local Session
Status              : Admin Enabled
Description          : -
Source Ports        :
    RX Only         : None
    TX Only         : Gi0/8
    Both            : None
Source VLANs        :
    RX Only         : None
    TX Only         : None
    Both            : None
Source EFPs         :
    RX Only         : None
    TX Only         : None
    Both            : None
Source RSPAN VLAN   : None
Destination Ports   : Gi0/11
    Encapsulation   : Native
                    : Ingress: Disabled
Filter VLANs        : None
Dest RSPAN VLAN     : None
Source IP Address    : None
Source IP VRF        : None
Source ERSPAN ID     : None
Destination IP Address : None
Destination IP VRF   : None
MTU                  : None
Destination ERSPAN ID : None
Origin IP Address    : None
IP QOS PREC          : 0
IP TTL               : 255
```

## Additional References

The following sections provide references to digital optical monitoring feature.

### Related Documents

Related Topic	Document Title
Cisco IOS Commands	<i>Cisco IOS Master Commands List, All Releases</i>
ASR 901 Command Reference	<i>Cisco ASR 901 Series Aggregation Services Router Command Reference</i>

### Standards

Standard	Title
None	—

### MIBs

MIB	MIBs Link
None	—

### RFCs

RFC	Title
None	—

### Technical Assistance

Description	Link
The Cisco Technical Support website contains thousands of pages of searchable technical content, including links to products, technologies, solutions, technical tips, and tools. Registered Cisco.com users can log in from this page to access even more content.	<a href="http://www.cisco.com/cisco/web/support/index.html">http://www.cisco.com/cisco/web/support/index.html</a>



# Feature Information for Switched Port Analyzer

Table 43-1 lists the features in this module and provides links to specific configuration information.

Use Cisco Feature Navigator to find information about platform support and software image support. Cisco Feature Navigator enables you to determine which software images support a specific software release, feature set, or platform. To access Cisco Feature Navigator, go to <http://www.cisco.com/go/cfn>. An account on Cisco.com is not required.



**Note**

Table 43-1 lists only the software release that introduced support for a given feature in a given software release train. Unless noted otherwise, subsequent releases of that software release train also support that feature.

**Table 43-1** Feature Information for Switched Port Analyzer

Feature Name	Releases	Feature Information
Switched Port Analyzer	15.4(1)S	<p>This feature was introduced on the Cisco ASR 901 router.</p> <p>The following sections provide information about this feature:</p> <ul style="list-style-type: none"> <li>• <a href="#">Additional References, page 43-8</a></li> <li>• <a href="#">Configuration Examples for SPAN, page 43-6</a></li> </ul>





---

## Numerics

802.3ad  
See LACP

---

## A

abbreviating commands [5-4](#)  
ACLs  
    any keyword [24-49](#)  
    host keyword [24-49](#)  
Address Resolution Protocol  
    See ARP  
administrative VLAN  
    REP, configuring [12-9](#)  
administrative VLAN, REP [12-9](#)  
ARP  
    defined [1-3](#)  
assured forwarding, DSCP [24-9](#)  
autonegotiation  
    duplex mode [1-2](#)  
autosensing, port speed [1-2](#)

---

## B

bandwidth command  
    for CBWFQ [24-19](#)  
    QoS, described [24-21](#)  
    with police command [24-23](#)  
bandwidth remaining percent command [24-23](#)  
base station controller  
    See BSC  
before starting router [3-1](#)

best-effort packet delivery [24-2](#)  
BGP  
    support for [1-5](#)  
Border Gateway Protocol  
    See BGP  
bridge domain  
    configuring [8-5](#)  
    creating [8-4](#)  
    rewrite command [8-6](#)  
    split horizon [8-6](#)  
    symmetric rewrite [8-7](#)  
bridge-domain command [9-11, 10-21, 13-6](#)  
BSC  
    in RAN [1-2](#)

---

## C

CBWFQ  
    and bandwidth command [24-21](#)  
    QoS scheduling [24-19](#)  
CDP  
    support for [1-3](#)  
CFM  
    clearing [10-30](#)  
    configuration guidelines [10-3](#)  
    configuring crosscheck [10-12](#)  
    configuring port MEP [10-14](#)  
    configuring static remote MEP [10-13](#)  
    configuring the network [10-3](#)  
    default configuration [10-3](#)  
    defined [10-2](#)  
    EtherChannel support [10-3](#)  
    IP SLAs support for [10-2](#)

- IP SLAs with endpoint discovers [10-18](#)
- manually configuring IP SLAs ping or jitter [10-16](#)
- measuring network performance [10-2](#)
- monitoring [10-31, 10-32](#)
- port MEP, configuring [10-14](#)
- static RMEP, configuring [10-13](#)
- Y.1731
  - described [10-26](#)
- channel-group group
  - command [9-6](#)
- child policies, QoS [24-12, 24-20](#)
- circuit emulation service over packet-switched network [21-3](#)
- Cisco Configuration Engine [1-3](#)
- Cisco Discovery Protocol
  - See CDP
- Cisco IOS
  - saving configuration changes [5-10](#)
- Cisco IOS File System
  - See IFS
- CiscoWorks 2000 [1-3](#)
- class-based priority queuing, QoS [24-16](#)
- class-based shaping
  - for QoS [24-20](#)
- Class-Based-Weighted-Fair-Queuing
  - See CBWFQ
- classification
  - in packet headers [24-7](#)
  - per-port per VLAN [24-12](#)
  - QoS comparisons [24-10](#)
  - QoS group [24-11](#)
- class map
  - match-all option [24-8](#)
  - match-any option [24-8](#)
- class-map command [24-4](#)
- class maps, QoS
  - configuring [24-50](#)
  - described [24-8](#)
- class of service
  - See CoS
- class selectors, DSCP [24-9](#)
- clearing
  - Ethernet CFM [10-30](#)
- CLI
  - abbreviating commands [5-4](#)
  - command modes [5-1](#)
  - described [1-3](#)
  - editing features
    - enabling and disabling [5-6](#)
    - keystroke editing [5-7](#)
    - wrapped lines [5-8](#)
  - error messages [5-4](#)
  - filtering command output [5-9](#)
  - getting help [5-3](#)
  - history
    - changing the buffer size [5-5](#)
    - described [5-5](#)
    - disabling [5-6](#)
    - recalling commands [5-6](#)
  - no and default forms of commands [5-4](#)
- command-line interface
  - See CLI
- command modes [5-1](#)
  - global configuration [5-2](#)
  - interface configuration [5-2](#)
  - privileged EXEC [5-2](#)
  - user EXEC [5-2](#)
- commands
  - abbreviating [5-4](#)
  - copy running-config [5-10](#)
  - no and default [5-4](#)
  - setup [3-1](#)
  - show version [3-5](#)
- configuration
  - before starting router [3-1](#)
  - completing [3-4](#)
  - first-time [3-1](#)
  - saving [3-4, 5-10](#)

## configuration guidelines

- CFM [10-3](#)
- Ethernet OAM [10-36](#)
- EVCs [8-7](#)
- QoS, general [24-32](#)
- QoS class maps [24-50](#)
- REP [12-7](#)

## configuring

## controllers

- E1 interface [20-2](#)

global parameters [3-2](#)hostname [3-5](#)IP address [7-1](#)password [3-5](#)Configuring PFC and ACFC [25-8](#)congestion management, QoS [24-2, 24-19](#)

## Connectivity Fault Management

See CFM

console port, connecting to [5-9](#)

## controllers

- E1 configuration [20-2](#)

## convergence

- REP [12-4](#)

## CoS

- classification [24-9](#)
- values [24-7](#)

crosscheck, CFM [10-12](#)**D**default commands [5-4](#)

## default configuration

- CFM [10-3](#)
- E-LMI and OAM [10-49](#)
- Ethernet OAM [10-36](#)
- EVCs [8-7](#)
- REP [12-7](#)
- Y.1731 [10-26](#)

default service, DSCP [24-9](#)

## Differentiated Services Code Point

See DSCP

## DSCP

- assured forwarding [24-9](#)
- classification [24-9](#)
- class selectors [24-9](#)
- default service [24-9](#)
- expedited forwarding [24-9](#)
- values [24-7](#)

duplex mode, setting [7-2](#)**E**E1 controllers [20-2](#)

## editing features

- enabling and disabling [5-6](#)
- keystrokes used [5-7](#)
- wrapped lines [5-8](#)

## E-LMI

- configuring a PE device [10-50](#)
- default configuration [10-49](#)
- defined [10-48](#)
- enabling [10-50](#)
- information [10-49](#)
- monitoring [10-51](#)

encapsulation frame-relay ietf command [9-11](#)encapsulation on service instances [8-4](#)encapsulation types supported [8-5](#)equal-cost routing [1-5](#)error messages during command entry [5-4](#)

## EtherChannel

## channel-group group

command [9-6](#)configuration guidelines [9-4](#)

## configuring

Layer 2 [9-5](#)

## lacp system-priority

command example [9-6](#)Layer 2, configuring [9-5](#)

load balancing

- configuring [9-8](#)
- understanding [9-4](#)

modes [9-2](#)

port-channel interfaces [9-4](#)

port-channel load-balance

- command [9-6, 9-8](#)
- command example [9-8](#)

STP [9-4](#)

support for [1-2](#)

understanding [9-1](#)

Ethernet flow point

- See EFP

Ethernet infrastructure [10-1](#)

Ethernet Link Management Interface

- See E-LMI

Ethernet OAM

- configuration guidelines [10-36](#)
- default configuration [10-36](#)
- enabling [10-36](#)
- link monitoring [10-38](#)
- protocol
  - defined [10-32](#)
  - monitoring [10-45](#)
- remote failure indications [10-41](#)
- remote loopback [10-38](#)
- templates [10-42](#)

Ethernet OAM protocol [10-1](#)

Ethernet operation, administration, and maintenance

- See Ethernet OAM

Ethernet Virtual Connection

- See EVC

EVC

- broadcast domain [8-1](#)
- configuration guidelines [8-7](#)
- creating [8-3](#)
- default configuration [8-7](#)
- supported features [8-2](#)

expedited forwarding, DSCP [24-9](#)

---

## F

figure

- Cisco ASR 901 router in a PWE3 [21-2](#)
- TDM over MPLS configuration [21-31](#)

filtering

- show and more command output [5-9](#)

filtering show and more command output [5-9](#)

first-time configuration [3-1](#)

frame distribution

- See EtherChannel load balancing

---

## G

GE interface

- IP address [7-1](#)
- mode [7-2](#)
- speed [7-2](#)

global parameters

- configuring [3-2](#)

---

## H

help, for the command line [5-3](#)

history

- changing the buffer size [5-5](#)
- described [5-5](#)
- disabling [5-6](#)
- recalling commands [5-6](#)

hostname

- configuring [3-5](#)
- verifying [3-6](#)

HP OpenView [1-3](#)

---

## I

ICMP

- support for [1-5](#)

ICMP Router Discovery Protocol  
 See IRDP

IEEE 802.1ag [10-2](#)

IEEE 802.3ad  
 See LACP

IEEE 802.3ah Ethernet OAM discovery [10-1](#)

IFS [1-3](#)

input policy maps  
 classification criteria [24-5](#)

interface  
 configuring E1 [20-2](#)

interface configuration, REP [12-10](#)

interfaces  
 management [1-3](#)

Intermediate System-to-Intermediate System  
 See IS-IS

Internet Control Message Protocol  
 See ICMP

inter-VLAN routing [1-5](#)

IOS software  
 verifying version [3-5](#)

IP address  
 configuring [7-1](#)  
 GE interface [7-1](#)

IP packets, classification [24-7](#)

IP precedence  
 classification [24-9](#)  
 values [24-7](#)

IP protocols  
 routing [1-5](#)

IP Service Level Agreements  
 See IP SLAs

IP SLAs  
 CFM endpoint discovery [10-18](#)  
 manually configuring CFM ping or jitter [10-16](#)

IPv6 address formats [32-3](#)

IRDP  
 support for [1-5](#)

IS-IS

support for [1-5](#)

ITU-T Y.1731  
 See Y.1731

---

## L

LACP  
 system ID [9-3](#)

LACP over EVC Port Channel  
 configuration commands, configuration steps [13-5](#)

LACP over EVC port channel  
 configuration commands, configuration steps [10-22](#)

Layer 2 packets, classification [24-7](#)

Layer 3 features [1-5](#)

link integrity, verifying with REP [12-4](#)

link monitoring, Ethernet OAM [10-38](#)

LSP ping  
 configuring [17-3](#)  
 described [17-1](#)  
 over pseudowire  
 configuring [17-3](#)  
 described [17-2](#)

LSP traceroute  
 configuring [17-3](#)  
 described [17-2](#)

---

## M

MAC addresses  
 static  
 allowing [8-19](#)

manageability features [1-3](#)

management access  
 in-band  
 CLI session [1-3](#)  
 SNMP [1-3](#)  
 out-of-band console port connection [1-3](#)

management options

CLI [5-1](#)  
   overview [1-3](#)  
 manual preemption, REP, configuring [12-20](#)  
 marking  
   described [24-2, 24-14](#)  
 match command, QoS  
   for classification [24-4, 24-8](#)  
   guidelines [24-50](#)  
 matching classifications, QoS [24-8](#)  
 mobile switching center  
   *See* MSC  
 modular QoS command-line interface  
   *See* MQC  
 monitoring  
   E-LMI [10-51](#)  
   Ethernet CFM [10-31, 10-32](#)  
   Ethernet OAM [10-45](#)  
   Ethernet OAM protocol [10-45](#)  
   features [1-5](#)  
 MPLS  
   LSP ping [17-1](#)  
   LSP traceroute [17-2](#)  
 MPLS OAM  
   described [17-1](#)  
 MQC  
   process [24-4](#)  
   steps to configure [24-4](#)  
 MSC  
   in a RAN [1-2](#)  
 MSTP  
   and REP [12-6](#)  
 multiple VPN routing/forwarding in customer edge devices  
   *See* multi-VRF CE  
 multiprotocol label switching  
   *See* MPLS  
 multi-VRF CE  
   support for [1-5](#)

---

## N

neighbor offset numbers, REP [12-5](#)  
 Network Time Protocol  
   *See* NTP  
 no commands [5-4](#)  
 NTP  
   support for [1-3](#)

---

## O

OAM  
   client [10-33](#)  
   features [10-33](#)  
   sublayer [10-33](#)  
 OAM manager  
   purpose of [10-49](#)  
 OAM PDUs [10-36](#)  
 OAM protocol data units [10-32](#)  
 Open Shortest Path First  
   *See* OSPF  
 options, management [1-3](#)  
 OSPF  
   support for [1-5](#)  
 output policies [24-6](#)  
 output policy maps  
   classification criteria [24-6](#)

---

## P

packet classification  
   defined [24-7](#)  
   to organize traffic [24-2](#)  
 packet marking  
   defined [24-18](#)  
 packet policing, for QoS [24-2](#)  
 parent policies, QoS [24-12, 24-20](#)  
 password [3-4](#)  
   configuring [3-5](#)



- verifying [3-6](#)
  - passwords
    - for security [1-4](#)
  - performance features [1-2](#)
  - per-port per VLAN policing [24-12](#)
  - ping, LSP [17-1](#)
  - ping mpls ipv4 command [17-3](#)
  - ping mpls pseudowire command [17-3](#)
  - policers
    - described [24-2](#)
  - policing
    - described [24-2](#)
    - individual in input policy maps [24-15](#)
    - priority in output policy maps [24-16](#)
    - QoS [24-14](#)
  - policy-map command [24-4](#)
  - policy maps
    - attaching [24-5](#)
    - described [24-15](#)
    - input
      - described [24-5](#)
    - output
      - described [24-5](#)
  - port-channel
    - see EtherChannel
  - port-channel load-balance
    - command [9-6, 9-8](#)
    - command example [9-6, 9-8](#)
  - ports
    - REP [12-6](#)
  - port shaping
    - described [24-20](#)
  - preempt delay time, REP [12-5](#)
  - preferential treatment of traffic
    - See QoS
  - primary edge port, REP [12-4](#)
  - priority command [24-16](#)
    - for QoS scheduling [24-19](#)
    - for strict priority queuing [24-23](#)
  - priority policing, described [24-16](#)
  - priority queues
    - described [24-23](#)
    - for QoS scheduling [24-19](#)
  - priority with police
    - commands [24-17](#)
  - priority with unconditional policing, QoS [24-19](#)
  - PWE3
    - example of Cisco ASR 901 router in a PWE3 (figure) [21-2](#)
- 
- ## Q
- QoS
    - and MQC [24-1](#)
    - basic model [24-2](#)
    - CBWFQ [24-21](#)
    - class-based shaping, described [24-20](#)
    - classification
      - based on CoS value [24-9](#)
      - based on DSCP [24-9](#)
      - based on IP precedence [24-9](#)
      - based on QoS group [24-11](#)
      - based on VLAN IDs [24-12](#)
    - class maps, described [24-8](#)
    - comparisons [24-10](#)
    - criteria [24-7](#)
    - in frames and packets [24-7](#)
    - policy maps, described [24-15](#)
  - class maps, configuration guidelines [24-50](#)
  - class maps, configuring [24-50](#)
  - configuration guidelines
    - class maps [24-50](#)
    - general [24-32](#)
  - configuring
    - class maps [24-50](#)
  - congestion management [24-2, 24-19](#)
  - CPU-generated traffic
    - output remarking [24-7](#)

- input policy maps
  - described [24-5](#)
- IP packet classification [24-7](#)
- Layer 2 packet classification [24-7](#)
- Layer 3 packet classification [24-7](#)
- marking, described [24-2](#)
- match command [24-8](#)
- output policy maps
  - described [24-6](#)
- overview [24-2](#)
- packet classification [24-2](#)
- packet marking [24-18](#)
- packet policing [24-2](#)
- parent-child hierarchy [24-12, 24-20](#)
- per-port, per-VLAN hierarchical policy maps
  - described [24-12](#)
- policers
  - described [24-14](#)
- policing
  - described [24-2, 24-14](#)
  - individual [24-15](#)
  - priority [24-16](#)
- port shaping, described [24-20](#)
- priority policing, described [24-16](#)
- scheduling [24-19](#)
  - CBWFQ [24-19](#)
  - priority queuing [24-19](#)
  - traffic shaping [24-19](#)
- strict priority queuing [24-23](#)
- supported table maps [24-13](#)
- support for [1-4](#)
- table maps [24-13](#)
- traffic shaping, described [24-19](#)
- QoS groups
  - classification [24-11, 24-12](#)
  - described [24-6, 24-11](#)
- quality of service
  - See QoS

---

## R

- RADIUS
  - support for [1-4](#)
- RAN, using the Cisco ASR 901 router [1-2](#)
- Remote Authentication Dial-In User Service
  - See RADIUS
- remote failure indications, Ethernet OAM [10-41](#)
- remote loopback, Ethernet OAM [10-38](#)
- REP
  - administrative VLAN [12-9](#)
  - administrative VLAN, configuring [12-9](#)
  - and MSTP [12-6](#)
  - configuration guidelines [12-7](#)
  - configuring interfaces [12-10](#)
  - convergence [12-4](#)
  - default configuration [12-7](#)
  - manual preemption, configuring [12-20](#)
  - neighbor offset numbers [12-5](#)
  - open segment [12-2](#)
  - ports [12-6](#)
  - preempt delay time [12-5](#)
  - primary edge port [12-4](#)
  - ring segment [12-2](#)
  - secondary edge port [12-4](#)
  - segments [12-1](#)
    - characteristics [12-2](#)
  - SNMP traps, configuring [12-21](#)
  - supported interfaces [12-1](#)
  - triggering VLAN load balancing [12-6](#)
  - verifying link integrity [12-4](#)
  - VLAN load balancing [12-4](#)
- RFC
  - 2475, DSCP [24-10](#)
  - 2597, AF per-hop behavior [24-10](#)
  - 2598, EF [24-10](#)
- RNC
  - in a RAN [1-2](#)

**S**

saving configuration changes [5-10](#)

scheduling, QoS [24-19](#)

secondary edge port, REP [12-4](#)

Secure Shell

- See SSH

security features [1-4](#)

service instance

- configuration mode [8-4](#)
- configuring [8-8](#)
- creating [8-3](#)
- defined [8-3](#)
- encapsulation [8-4](#)

service-policy command

- attaching policy maps [24-5](#)

set command

- for QoS marking [24-18](#)

setup command facility [3-1, 3-2](#)

shape average command, QoS [24-19, 24-20](#)

show and more command output, filtering [5-9](#)

SNMP

- in-band management [1-3](#)
- manager functions [1-3](#)

SNMP traps

- REP [12-21](#)

software

- verifying version [3-5](#)

speed, setting [7-2](#)

split-horizon group [8-6](#)

split-horizons on bridge domains [8-6](#)

SSH

- described [1-3](#)

static IP routing [1-5](#)

STP

- EtherChannel [9-4](#)

strict priority queuing

- defined [24-23](#)
- QoS [24-23](#)

Structure-agnostic TDM over Packet [21-3](#)

Structure-agnostic TDM over Packet (SaToP) [21-3](#)

SunNet Manager [1-3](#)

system message logging

- syslog facility [1-5](#)

**T**

table maps

- described [24-13](#)
- for QoS marking [24-18](#)
- types of [24-13](#)

TACACS+

- support for [1-4](#)

Telnet

- accessing management interfaces [5-9](#)
- number of connections [1-3](#)

templates, Ethernet OAM [10-42](#)

Terminal Access Controller Access Control System Plus

- See TACACS+

traceroute, LSP [17-2](#)

traceroute mpls ipv4 command [17-3, 17-4](#)

traffic class, defined [24-4](#)

traffic classification, typical values [24-10](#)

traffic marking [24-18](#)

traffic policies, elements in [24-4](#)

traffic shaping

- for QoS scheduling [24-19](#)
- QoS traffic control [24-19](#)

**V**

verifying

- hostname [3-6](#)
- password [3-6](#)
- software version [3-5](#)
- version of Cisco IOS software [3-5](#)

VLAN load balancing

REP [12-4](#)

triggering [12-6](#)

---

## Y

Y.1731

default configuration [10-26](#)

described [10-26](#)

terminology [10-26](#)

## Free Manuals Download Website

<http://myh66.com>

<http://usermanuals.us>

<http://www.somanuals.com>

<http://www.4manuals.cc>

<http://www.manual-lib.com>

<http://www.404manual.com>

<http://www.luxmanual.com>

<http://aubethermostatmanual.com>

Golf course search by state

<http://golfingnear.com>

Email search by domain

<http://emailbydomain.com>

Auto manuals search

<http://auto.somanuals.com>

TV manuals search

<http://tv.somanuals.com>