

CELVIANO

AP-45

USER'S GUIDE GUÍA DEL USUARIO



CASIO®

AP45ES1C

IMPORTANT SAFETY INSTRUCTIONS

1. Read these instructions.
2. Keep these instructions.
3. Heed all warnings.
4. Follow all instructions.
5. Do not use this apparatus near water.
6. Clean only with dry cloth.
7. Do not block any ventilation openings. Install in accordance with the manufacturer's instructions.
8. Do not install near any heat sources such as radiators, heat registers, stoves, or other apparatus (including amplifiers) that produce heat.
9. Do not defeat the safety purpose of the polarized or grounding-type plug. A polarized plug has two blades with one wider than the other. A grounding type plug has two blades and a third grounding prong. The wide blade or the third prong are provided for your safety. If the provided plug does not fit into your outlet, consult an electrician for replacement of the obsolete outlet.
10. Protect the power cord from being walked on or pinched particularly at plugs, convenience receptacles, and the point where they exit from the apparatus.
11. Only use attachments/accessories specified by the manufacturer.
12. Use only with the cart, stand, tripod, bracket, or table specified by the manufacturer, or sold with the apparatus. When a cart is used, use caution when moving the cart/ apparatus combination to avoid injury from tip-over.



13. Unplug this apparatus during lightning storms or when unused for long periods of time.
14. Refer all servicing to qualified service personnel. Servicing is required when the apparatus has been damaged in any way, such as power-supply cord or plug is damaged, liquid has been spilled or objects have fallen into the apparatus, the apparatus has been exposed to rain or moisture, does not operate normally, or has been dropped.

The apparatus shall not be exposed to dripping or splashing and that no objects filled with liquids, such as vases, shall be placed on the apparatus.

The power indicator being unlit does not mean the apparatus is completely disconnected from the MAINS. When you need to have the apparatus completely disconnected from the MAINS, you must unplug the power cord. For that purpose, locate the apparatus in a way that secures easy access to the power cord.



CAUTION

RISK OF ELECTRIC SHOCK DO NOT OPEN



CAUTION: TO REDUCE THE RISK OF ELECTRIC SHOCK, DO NOT REMOVE COVER (OR BACK). NO USER -SERVICEABLE PARTS INSIDE. REFER SERVICING TO QUALIFIED SERVICE PERSONNEL.



The lightning flash with arrowhead symbol, within an equilateral triangle, is intended to alert the user to the presence of uninsulated "dangerous voltage" within the product's enclosure that may be of sufficient magnitude to constitute a risk of electric shock to persons.



The exclamation point within an equilateral triangle is intended to alert the user to the presence of important operating and maintenance (servicing) instructions in the literature accompanying the product.

NOTICE

This equipment has been tested and found to comply with the limits for a Class B digital device, pursuant to Part 15 of the FCC Rules. These limits are designed to provide reasonable protection against harmful interference in a residential installation. This equipment generates, uses and can radiate radio frequency energy and, if not installed and used in accordance with the instructions, may cause harmful interference to radio communications. However, there is no guarantee that interference will not occur in a particular installation. If this equipment does cause harmful interference to radio or television reception, which can be determined by turning the equipment off and on, the user is encouraged to try to correct the interference by one or more of the following measures:

- Reorient or relocate the receiving antenna.
- Increase the separation between the equipment and receiver.
- Connect the equipment into an outlet on a circuit different from that to which the receiver is connected.
- Consult the dealer or an experienced radio/TV technician for help.

FCC WARNING

Changes or modifications not expressly approved by the party responsible for compliance could void the user's authority to operate the equipment.

TO REDUCE THE RISK OF FIRE OR ELECTRIC SHOCK, REFER SERVICING TO QUALIFIED SERVICE PERSONNEL.



This mark applies in EU countries only.



CASIO Europe GmbH
Bornbarch 10, 22848 Norderstedt, Germany

This mark applies to the AP-45V only.
Please keep all information for future reference.

Safety Precautions

Congratulations on your selection of the CASIO Digital Piano. This digital piano is a sophisticated musical instrument that blends the very best of traditional piano feel and sound quality with the latest that modern electronics technology has to offer.

- Before using the instrument, be sure to carefully read through the instructions contained in this manual.
- Please keep all information for future reference.

Symbols

Various symbols are used in this user's guide and on the product itself to ensure that the product is used safely and correctly, and to prevent injury to the user and other persons as well as damage to property. Those symbols along with their meanings are shown below.

WARNING

This indication stipulates matters that have the risk of causing death or serious injury if the product is operated incorrectly while ignoring this indication.

CAUTION

This indication stipulates matters that have the risk of causing injury as well as matters for which there is the likelihood of occurrence of physical damage only if the product is operated incorrectly while ignoring this indication.

Symbol Examples



This triangle symbol (\triangle) means that the user should be careful. (The example at left indicates electric shock caution.)



This circle with a line through it (\odot) means that the indicated action must not be performed. Indications within or nearby this symbol are specifically prohibited. (The example at left indicates that disassembly is prohibited.)



The black dot (\bullet) means that the indicated action must be performed. Indications within this symbol are actions that are specifically instructed to be performed. (The example at left indicates that the power plug must be unplugged from the electric socket.)

⚠ WARNING

Power Cord

- Improper use of the power cord can create the risk of fire and electric shock. Always be sure to observe the following precautions.
 - Use only the power cord specified for this digital piano.
 - Make sure that the power source you are using matches the rating marked on the instrument itself.
 - Do not use an extension cord to plug multiple devices into the same power outlet.
- Improper use of the power cord can create the risk of personal injury, material damage, fire and electric shock. Always be sure to observe the following precautions.
 - Do not place heavy objects on the power cord or subject it to heat.
 - Never try to modify the power cord or subject it to excessive bending.
 - Never twist or pull on the power cord.
 - Should the power cord or plug become damaged, contact your original retailer or an authorized CASIO service provider.
- Do not touch the plug with wet hands when it is plugged in. This may cause electric shock.
- Never allow the digital piano to get wet. Water creates the risk of fire and electric shock.
- Never place a vase or any other liquid container on the digital piano. Water creates the risk of fire and electric shock.

Do not locate the digital piano on an unstable surface.

Never locate the digital piano on a surface that is wobbly, tilted, or otherwise unstable*. An unstable surface can cause the digital piano to fall over, creating the risk of personal injury.

* Avoid areas where there are multiple layers of carpeting, and where cables are running under the digital piano.

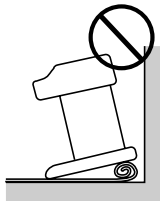

Always make sure you secure the digital piano to the stand with the screws that are provided. An unsecured the digital piano can fall from the stand, creating the risk of personal injury.

Never climb onto the digital piano or stand.

Never climb onto the digital piano or hang from its edges. Doing so can cause the digital piano to fall over, creating the risk of personal injury. Special care concerning this point is required in households where there are small children.



Never dispose of the digital piano by burning it.

Never dispose of the digital piano by burning it. Doing so creates the risk of fire and personal injury due to explosion.



Do not place containers containing water or other liquids on the instrument.

Do not place the following objects on the instrument. Placing such objects on the instrument may cause fire or electric shock if they spill and get inside the instrument.



- Containers filled with water or other liquids (including vases, potted plants, cups, cosmetics and medicines)
- Small metal objects (including hairpins, sewing needles and coins)
- Flammable objects
- Naked flame sources, such as lighted candles



In the event a foreign object should happen to get inside the instrument, please take the following actions:

1. Turn off power.
2. Unplug the power cord from the wall outlet.
3. Consult with the dealer where you purchased the instrument or with an authorized CASIO service provider.



Do not expose this digital piano to rain or moisture.

To reduce the risk of fire or electric shock, do not expose this digital piano to rain or moisture.

Never try to take the digital piano apart or modify it.

Never try to take the digital piano apart or modify it in any way. Doing so creates the risk of electric shock, burn injury, or other personal injury. Leave all internal inspection, adjustment, and repair up to your original retailer or an authorized CASIO service provider.



Precautions concerning smoke, abnormal odor, and other abnormalities

Continued use of the digital piano while it is emitting smoke or abnormal odor, or while it is displaying other abnormalities creates the risk of fire and electric shock. Immediately perform the following steps whenever you notice any abnormality.

1. Turn off the digital piano power.
2. Unplug the digital piano from its power outlet.
3. Contact your original retailer or an authorized CASIO service provider.



Avoid dropping the digital piano and other strong impact.

Continued use of the digital piano after it has been damaged by dropping or by other external impact creates the risk of fire and electric shock. Immediately perform the following steps whenever the digital piano is damaged by impact.

1. Turn off the digital piano power.
2. Unplug the digital piano from its power outlet.
3. Contact your original retailer or an authorized CASIO service provider.



Do not put plastic bags over your head or in your mouth.

Never allow the plastic bags that the digital piano and its accessories come in to be placed over the head or swallowed. Doing so creates the risk of suffocation. Special care concerning this point is required in households where there are small children.



Opening and closing the keyboard cover

Make sure that the keyboard cover is completely opened as far as it will go. When closing the keyboard cover, hold the front of the cover and close it slowly. Pinching your fingers between the digital piano and keyboard cover creates the risk of personal injury.

⚠ CAUTION

Power Outlet

To power the digital piano, use a power outlet that allows easy access when plugging in or unplugging the power cord.

Power Cord

Improper use of the power cord can create the risk of fire and electric shock. Always be sure to observe the following precautions.

- Never locate the power cord near a stove or other source of heat.
- When unplugging from an outlet, never pull on the cord.
(Always grasp the plug when pulling.)
- After use turn off the power switch of the instrument and unplug the power cord from the electrical outlet.



Power Plug

Improper use of the power plug can create the risk of fire and electric shock. Always be sure to observe the following precautions.

- Push the plug fully into the power outlet as far as it will go.
- Unplug from the power outlet during lightning storms, and when you do not plan to use the digital piano for a long time (such as before a long trip).
- After unplugging from the wall outlet, clean the area between the prongs of the plug to keep dust from building up.



Moving the digital piano

Be sure to perform the following steps before moving the digital piano. Failure to do so can damage the power cord, creating the risk of fire and electric shock.

1. Unplug the digital piano from its power outlet.
2. Unplug the pedal connecting cord, and all cords and other items connected to the back of the digital piano.



Cleaning

Before cleaning the digital piano, unplug it from the power outlet. Failure to do so can damage the power cord, creating the risk of fire and electric shock. It can also cause the digital piano to fall over, creating the risk of personal injury.



Never climb onto the digital piano or stand.

Doing so can cause the digital piano to fall over, creating the risk of personal injury. Special care concerning this item is required in households where there are small children.



Connector

Connect only the specified devices to the digital piano's connectors. Connecting non-specified items creates the risk of fire and electric shock.



Location

Avoid locating the digital piano in the following types of areas. Subjecting the digital piano to the conditions described below creates the risk of fire and electric shock.



- Areas expose to high humidity or large amounts of dust
- Near food preparation areas and other areas where it is exposed to oil smoke
- Near a heater, on a heated carpet, in direct sunlight, inside a closed automobile parked in the sun, and any other area subjected to very high temperature

Never place the digital piano directly onto furniture or other item that has a finished surface. The rubber feet on the bottom of the digital piano can react with the paint or other coatings, resulting in soiling of or damage to the finished surface. Be sure to lay felt or some other material on the finished surface before placing the digital piano on it.

Do not place heavy objects on the digital piano.

Never place heavy objects on top of the digital piano. Doing so can cause the stand to tip over and the object to fall, creating the risk of personal injury.



Volume setting

Do not play at very loud volumes for a long time. This precaution is especially important when using the headphones. Long-term exposure to very loud sound can damage your hearing.



Assemble the stand properly.

Failure to do so can cause the stand to fall over and the digital piano to fall from the stand, creating the risk of personal injury. Make sure you assemble the stand in accordance with the instructions that come with it, and ensure that all connections are secure. Also make sure that you choose an appropriate location for the stand.

- When placing the digital piano onto the stand, take care that you do not pinch your fingers between the digital piano and the stand.
- At least two people should lift the digital piano when placing it onto the stand or moving it. Trying to move the digital piano alone can cause the stand to fall over, creating the risk of personal injury.
- Do not drag the stand or tilt it forward or back when placing the digital piano onto the stand or moving it. Doing so can cause the digital piano to fall over, creating the risk of personal injury.
- Periodically check the screws that secure the digital piano to the stand for looseness. If a screw is loose, retighten it. Loose screws can cause the stand to tip over and the digital piano to fall, creating the risk of personal injury.





Main Features

□ 16 versatile tones

16 instrument tones including piano and pipe organ provide plenty of performance versatility.

An easy setting lets you control the brilliance of each tone, and a layer feature lets you assign two tones to sound simultaneously. Other features include digital effects that control the acoustical characteristic of tones, as well as three pedal effects for all the nuances of an acoustic piano.

□ Metronome

A simple operation lets you set the tempo and the beat of the metronome to suit the tune you want to play. It's the perfect practice tool for players of all levels.

□ 16 demo tunes

16 demo tunes demonstrate how to use each of the built-in tones.

□ Song Memory

Two independent memory areas let you separately record and playback tunes. You can record in one memory and later record in the other memory while playing back your original recording, or even play back from both memories at the same time.

□ Music Library

Playback with any one of 50 built-in Music Library tunes. Right hand and left hand parts are separate, so you can turn off play of either hand and practice along on the keyboard (Part Lesson).

□ Variable temperament, Baroque pitch

Select from a variety of temperament settings and Baroque pitch for realistic play of classical pieces.

□ Powerful keyboard setting functions

A selection of powerful keyboard setting functions helps you get create exactly the musical mood you want.

Transpose adjusts the key of the keyboard in semitone steps.

Tuning provides a means to tune with another musical instrument.

Touch Select adjusts the intensity of the output sound in accordance with the amount of pressure you apply to the keyboard.

□ MIDI terminal

Connecting to another MIDI musical instrument lets you play two instruments from the keyboard of this digital piano. You can also connect to a commercially available MIDI sequencer to increase the number of parts you can play.



Contents

Safety Precautions E-2

Main Features E-6

General Guide E-8

Connecting to a Power Outlet E-10

To connect to a power outlet E-10

Connections E-11

Accessories and Options E-11

Basic Operation E-12

Using Tones E-12

Using Digital Effects E-17

Using the Pedals E-18

Using the Metronome E-19

Using the Song Memory E-21

About the Song Memory E-21

Recording E-22

Playback E-23

Deleting Song Memory Contents E-23

Using Demo Tunes E-24

Playing the Demo Tunes in Sequence ... E-24

Playing a Specific Demo Tune E-24

Stopping Demo Tune Play E-24

Using Music Library E-25

Playing Back Music Library Tunes E-25

Practicing Individual Parts (Part Lesson) ... E-26

Keyboard Settings E-28

Using Touch Select E-28

Using Transpose E-28

Adjusting the Tuning of the Digital Piano ... E-29

Temperament E-29

Using Baroque Pitch E-31

MIDI E-32

What is MIDI? E-32

MIDI Connections E-32

Simultaneous Receive Over
Multiple Channels (Multi-Timbre) E-32

Specifying the Keyboard Channel E-32

Sending Song Memory Playback Data .. E-33

Turning Local Control On and Off E-33

MIDI Data Notes E-33

Troubleshooting E-35

Assembly Instructions E-36

Attachment of the Score Stand E-38

Specifications E-39

Operational Precautions E-40

Appendix A-1

Initial Power On Settings A-1

Music Library Tunes A-3

MIDI Data Format A-4

Channel Messages A-4

System Messages A-8

MIDI Implementation Chart

General Guide

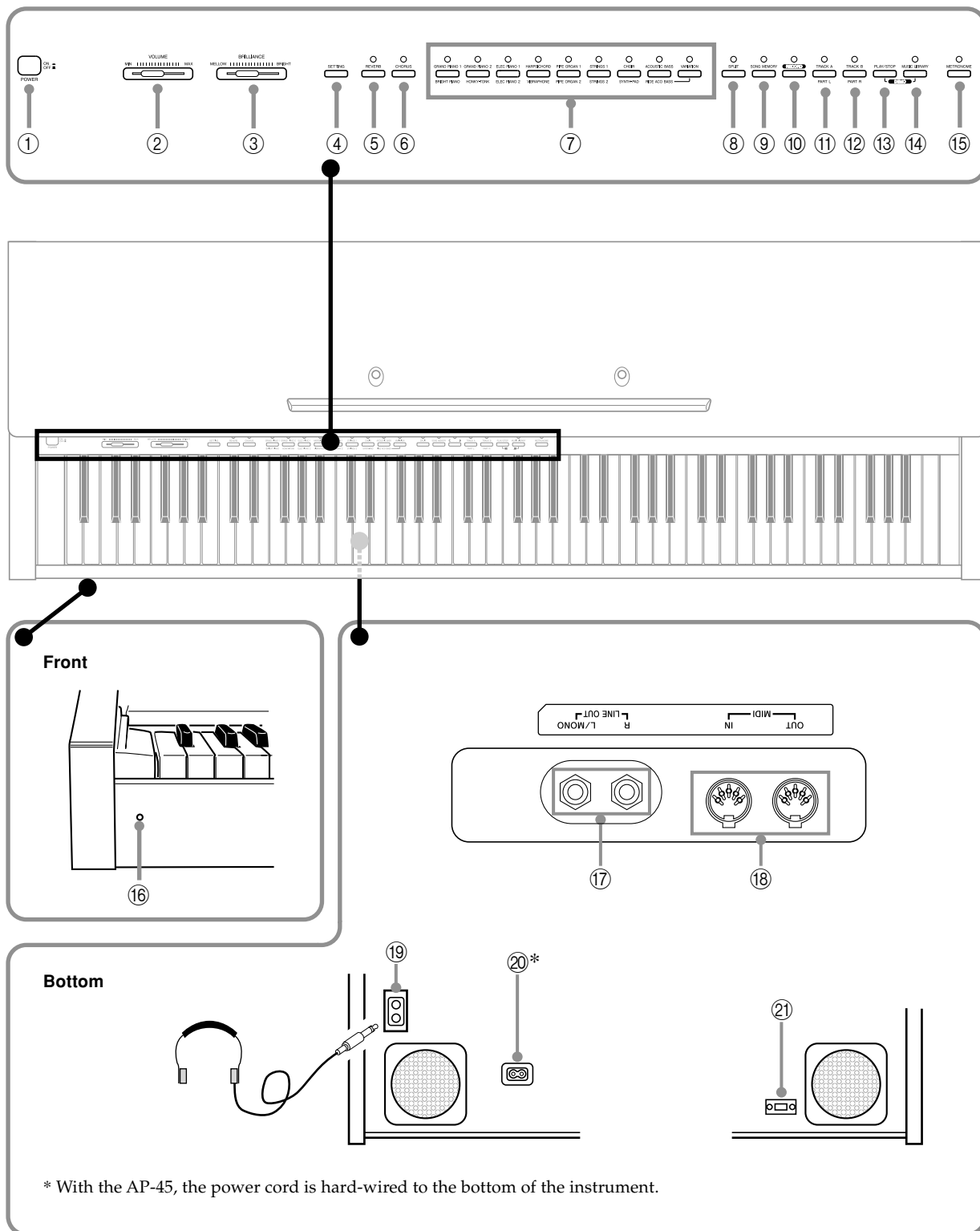



⚠ CAUTION

Make sure that the cover of the digital piano is fully open whenever you are playing on the keyboard. A partially open cover can suddenly close unexpectedly and pinch your fingers.

- ① POWER button
- ② VOLUME slider
- ③ BRILLIANCE slider
- ④ SETTING button
- ⑤ REVERB button
- ⑥ CHORUS button
- ⑦ Tone buttons
- ⑧ SPLIT button
- ⑨ SONG MEMORY button
- ⑩ RECORD button
- ⑪ TRACK A/PART L button
- ⑫ TRACK B/PART R button
- ⑬ PLAY/STOP button
- ⑭ MUSIC LIBRARY button
- ⑮ METRONOME button
- ⑯ Power Indicator
- ⑰ LINE OUT jacks (R, L/MONO)
- ⑱ MIDI IN terminal, MIDI OUT terminal
- ⑲ Headphone jacks
- ⑳ AC Power jack
- ㉑ Pedal Connector

NOTE

Note Names

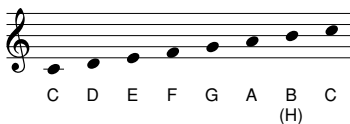

A value next to a note name indicates the relative position of the note on the keyboard as shown below.

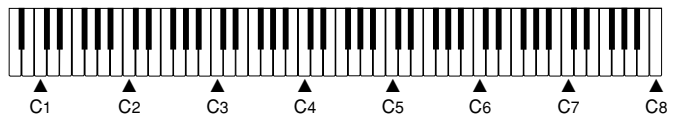

Connecting to a Power Outlet

You can power this digital piano by plugging it into a standard household power outlet.

Be sure you turn off power whenever the digital piano is not in use.

To connect to a power outlet

1 Check to make sure that the digital piano's POWER button is in the OFF position.

- If it is ON, press the POWER button to turn it OFF.

POWER button

ON 
Power indicator on.

OFF 
Power indicator off.

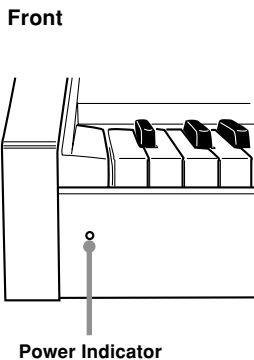

2 Attach the power cord that comes with the digital piano to the bottom of the digital piano.*

3 Plug the digital piano's power cord into a wall outlet.

* applies to the AP-45V.

IMPORTANT!

- Power should also be turned off before you unplug the digital piano from the wall outlet.
- The shapes of the digital piano's power cord and wall outlet should be different according to countries or regions. The illustrations are examples.
- With the AP-45, the power cord is hardwired to the bottom of the instrument.

Make sure the power indicator is completely turned off before unplugging the power cord from the power outlet. Be sure to read and observe all of the safety precautions concerning power supply.

Connections

Connecting to an audio or musical instrument amplifier provides even clearer, more powerful sound through external speakers.

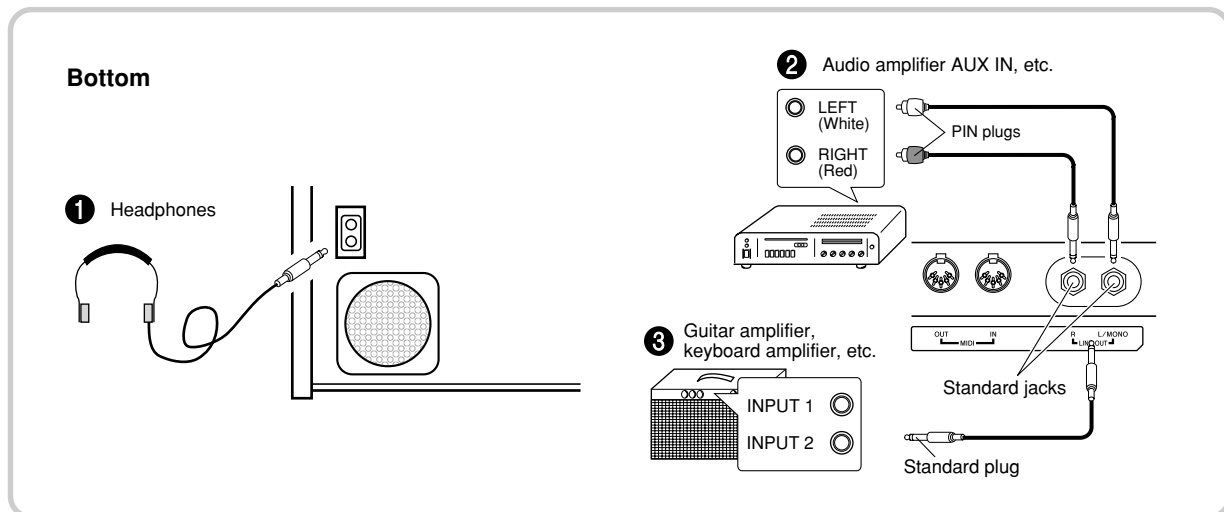

IMPORTANT!

- Whenever connecting external equipment, first set the VOLUME slider of the digital piano and the volume controller of the external equipment to relatively low volume settings. You can later adjust volume to the level you want after connections are complete.
- Be sure also to refer to the documentation that comes with the external equipment for its proper connection procedures.

Connecting Headphones ①

Connect commercially available headphones to the digital piano's headphones jack. This cuts off the built-in speakers, which means you can practice even late at night without disturbing others. To protect your hearing, make sure that you do not set the volume level too high when using headphones.

Connecting to Audio Equipment ②

Use commercially available cables to connect the external audio equipment to the digital piano's LINE OUT jacks as shown in Figure ②. R jack output is right channel sound, while L/MONO jack output is left channel sound. It is up to you to purchase connecting cables like the ones shown in the illustration for connection of audio equipment. Normally in this configuration you must set the audio equipment's input selector to the setting that specifies the terminal (such as AUX IN) to which the digital piano is connected. Use the digital piano's VOLUME slider to adjust the volume level.

Connecting to a Musical Instrument Amplifier ③

Use commercially available cables to connect the amplifier to the digital piano's LINE OUT jacks as shown in Figure ③. R jack output is right channel sound, while L/MONO jack output is left channel sound. Connecting to the L/MONO jack only outputs a mixture of both channels. It is up to you to purchase connecting cable like the one shown in the illustration for connection of the amplifier. Use the digital piano's VOLUME slider to adjust the volume level.

Accessories and Options

Use only the accessories and options specified for this digital piano. Use of non-authorized items creates the danger of fire, electric shock, and personal injury.

Basic Operation

Using Tones

The following procedures describe everything you need to know about selecting and using tones.

Selecting a Tone

This digital piano has a selection of 16 built-in tones.

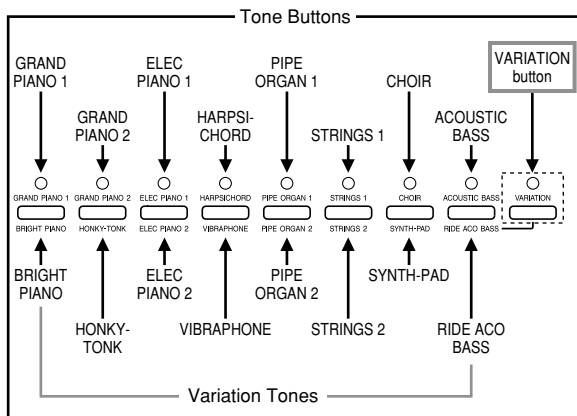

Variation Button

Each tone button is assigned two tones: a "normal tone" (whose name is above the tone button) and a "variation tone" (whose name is below the tone button). Which tone is selected when you press a tone button depends on the current status of the indicator lamp above the VARIATION button, as shown below.

To select this type of tone:	The VARIATION button lamp should be:
Normal tone	Off
Variation tone	On

- Press the VARIATION button to toggle its indicator lamp on and off.
- Pressing the tone button of the currently selected tone toggles it between the normal tone and the variation tone.

NOTE

- The tone buttons provide you with a selection of 16 tones that you can assign to and play on the keyboard.
- The GRAND PIANO 1 tone was recorded with stereo sampling.
- See "Selecting a Variation Tone" for information on selecting the tones whose names are marked below each tone button.

To select a tone

- 1 Press the POWER button to turn on the digital piano power.
- 2 Press one of the tone buttons to select the tone you want.
- 3 Use the VOLUME slider to adjust the volume.
 - It is a good idea to set the volume to a relatively low level at first.
 - Moving the slider towards MIN decreases volume, while moving it towards MAX increases volume.
- 4 Play something on the keyboard.
 - Adjust volume to the level you want as you play.
- 5 After you are finished playing, press the POWER button to turn off power.

NOTE

- The GRAND PIANO 1 tone is selected automatically whenever you turn on the digital piano power.

Selecting a Variation Tone

The tone buttons that are marked as shown below are for selecting variation tones.

- 1 Press the tone button for the tone you want to select.
- 2 Press the VARIATION button.
 - This causes the indicator lamp above the button to light, which indicates that the variation tone is selected.
- 3 To switch back from variation tone to normal tone, press the VARIATION button again to the indicator lamp goes out.



Using Layer

With layer you can assign two different tones (a main tone and a layered tone) to the keyboard, both of which play whenever you press a key.

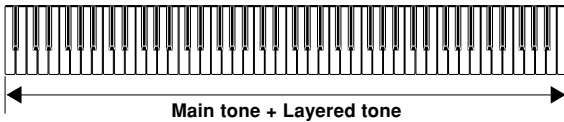

To layer two tones

NOTE

- To use the variation tone for the main tone and/or the layer tone, perform the required operation to turn on the variation tone(s) before starting the procedure below.

- 1 While holding down the tone button of the main tone, press the tone button for the layer tone.
 - This causes the indicator lamp of the main tone button to light, and the lamp of the layer tone button to flash.
 - Whether the normal tone or variation tone is selected for the main tone and layer tone depends on the normal tone/variation tone setting of the tone button you press. The indicator lamp above the VARIATION button is lit when the variation tone is selected for the main tone.
- 2 Now try playing something on the keyboard.
 - Note should sound using both of the tones you selected.
- 3 To cancel layering, press any tone button.

NOTE

- If you change or turn off a digital effect while layering is turned on, the setting you make is saved to the main tone's settings only.
- You cannot layer two tones that are assigned to the same tone button (for example: ELEC PIANO 1 + ELEC PIANO 2, or HARPSICHORD + VIBRAPHONE).

How digital effects are applied when layering is turned on

The following are the rules that determine what type of digital effects are applied to two tones that are layered.

These conditions:	Cause these digital effects to be applied to both the main tone and layered tone:
<ul style="list-style-type: none"> • Digital effects turned on for the main tone • Digital effects turned on or off for the layered tone 	Main tone digital effects
<ul style="list-style-type: none"> • Digital effects turned off for the main tone • Digital effects turned on for the layered tone 	Layered tone digital effects
<ul style="list-style-type: none"> • Digital effects turned off for the main tone • Digital effects turned off for the layered tone 	None

To adjust the volume of the main tone

- 1 Hold down the SETTING button, and keep it depressed until you reach step 4 of this procedure.
- 2 Press the GRAND PIANO 1 button.
 - This causes the indicator lamp above the button to flash.
- 3 Use one of the procedures below to set the main tone volume to a value in the range of 40 to 127.
 - To scroll the volume setting value: While holding down the SETTING button, use the + (increase) and – (decrease) keys to scroll the volume setting value. Holding down either key changes the setting at high speed. Pressing + and – at the same time automatically selects a volume setting value of 127.
 - To input the volume setting value: While holding down the SETTING button, use the number input keys to input a two-digit or three-digit volume setting value in the range of 40 to 127. You can input a two digit or a three-digit value. The level you input is applied to the volume setting value when you release the SETTING button. The volume setting does not change if you input a one-digit value or a value that is outside of the allowable range.

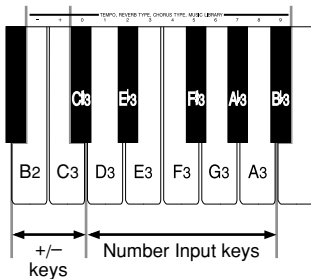

- A note does not sound when you press a keyboard key at this time.

- 4 Release the SETTING button to complete the procedure.

NOTE

- The setting you make for the main tone volume remains in effect even if you change to another tone.

To adjust the volume of the layer tone

- 1 Hold down the SETTING button, and keep it depressed until you reach step 4 of this procedure.
- 2 Press the GRAND PIANO 2 button.
 - This causes the indicator lamp above the button to flash.
- 3 Use one of the procedures below to set the layer tone volume to a value in the range of 40 to 127.
 - To scroll the volume setting value: While holding down the SETTING button, use the + (increase) and – (decrease) keys to scroll the volume setting value. Holding down either key changes the setting at high speed. Pressing + and – at the same time automatically selects a volume setting value of 72.
 - To input the volume setting value: While holding down the SETTING button, use the number input keys to input a two-digit or three-digit volume setting value in the range of 40 to 127. You can input a two digit or a three-digit value. The level you input is applied to the volume setting value when you release the SETTING button. The volume setting does not change if you input a one-digit value or a value that is outside of the allowable range.

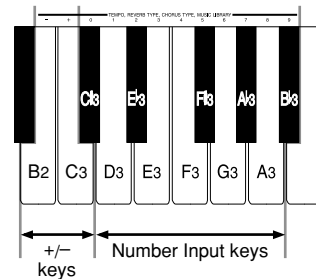

- A note does not sound when you press a keyboard key at this time.

- 4 Release the SETTING button to complete the procedure.

NOTE

- The setting you make for the layer tone volume remains in effect even if you change to another tone.

Using Split

With split you can assign two different tones (a main tone and a split tone) to either end of the keyboard, which lets you play one tone with your left hand and another tone with your right hand.

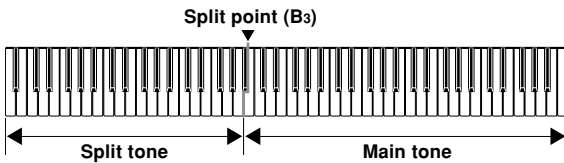

To split the keyboard

- 1 Select the main tone.
- 2 Press the SPLIT button.
 - This causes the indicator lamp above the button to light.
- 3 While holding down the SPLIT button, press the tone button of the tone you want to use as the split tone.
 - While holding down the SPLIT button, you can also press the VARIATION button to switch to the variation of the split tone.
 - The tone button lamp of the split tone you specify flashes. The indicator lamp above the VARIATION button also flashes when the variation tone is selected for the split tone.
- 4 Now try playing something on the keyboard.
 - The lower range (left side) of the keyboard is assigned the split tone, while the upper range (right side) is assigned the main tone.
 - The location on the keyboard where the changeover between the two tones occurs is called the split point. See "To change the location of the split point" on this page for details on changing the location of the split point.
- 5 Press the SPLIT button again to unsplit the keyboard and return it to normal.
 - This causes the indicator lamp above the button to go out.

NOTE

- If you change or turn off a digital effect while split is turned on, the setting you make is saved to the main tone's settings only.

How digital effects are applied when split is turned on

The following are the rules that determine what type of digital effects are applied to tones that are assigned to a split keyboard.

These conditions:	Cause these digital effects to be applied to both the main tone and split tone:
<ul style="list-style-type: none"> • Digital effects turned on for the main tone • Digital effects turned on or off for the split tone 	Main tone digital effects
<ul style="list-style-type: none"> • Digital effects turned off for the main tone • Layering turned on (page E-13) • Digital effects turned on for the layered tone 	Layered tone digital effects
<ul style="list-style-type: none"> • Digital effects turned off for the main tone • Layering turned on (page E-13), but digital effects turned off for the layered tone • Layering turned off • Digital effects turned on for the split tone 	Split tone digital effects

To change the location of the split point

The "split point" is the point on the keyboard that separates the low range (split tone) from the high range (main tone).

- 1 While holding down the SPLIT button, press the keyboard key where you want the highest note (the rightmost key) of the lower range (left side range) to be.
 - No sound is produced when the keys are pressed.

To adjust the volume of the split tone

- 1 Hold down the SETTING button, and keep it depressed until you reach step 4 of this procedure.
- 2 Press the ELEC PIANO 1 button.
 - This causes the indicator lamp above the button to flash.
- 3 Use one of the procedures below to set the split tone volume to a value in the range of 40 to 127.
 - To scroll the volume setting value: While holding down the SETTING button, use the + (increase) and – (decrease) keys to scroll the volume setting value. Holding down either key changes the setting at high speed. Pressing + and – at the same time automatically selects a volume setting value of 127.
 - To input the volume setting value: While holding down the SETTING button, use the number input keys to input a two-digit or three-digit volume setting value in the range of 40 to 127. You can input a two digit or a three-digit value. The level you input is applied to the volume setting value when you release the SETTING button. The volume setting does not change if you input a one-digit value or a value that is outside of the allowable range.

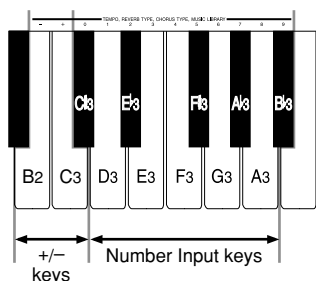

- A note does not sound when you press a keyboard key at this time.
- 4 Release the SETTING button to complete the procedure.

NOTE

- The setting you make for the split tone volume remains in effect even if you change to another tone.

More about tones

Polyphony

This digital piano can play up to 64 notes at the same time. Note, however, that the tones listed below are capable of only 32-note polyphony. GRAND PIANO 1, BRIGHT PIANO, HONKY-TONK, ELEC PIANO 1, HARPSICHORD, STRINGS 1, CHOIR, SYNTH-PAD, RIDE ACO BASS

Touch Response

The touch response feature causes changes in the volume and the sound of the tone in accordance with how much pressure you apply to the keyboard, just like an acoustic piano. Touch response affects the HARPSICHORD tone only slightly, because the original musical instrument normally produces the same sound, no matter how much pressure is applied.

Digitally Sampled Tones

The tones of this digital piano are produced using digitally recorded samples of actual musical instruments. Not all of the instruments, however, can produce tones across the entire range played by this digital piano (A0 through C8). In such a case, digital recordings are used for the range that actually can be produced by the original instrument, and synthesized tones are used for notes that cannot be produced naturally. Because of this, you may notice very slight differences between natural notes and synthesized notes in sound quality and in results produced when using effects. These differences are normal and do not indicate malfunction.

Adjusting the Brilliance of a Tone

You can use the BRILLIANCE slider to adjust the clarity and sharpness of a tone to suit your music and personal preferences.

- 1 Slide the BRILLIANCE slider left and right to adjust the brilliance of a tone to the level that you want.
 - Moving the slider towards MELLOW produces a more mellow sound, while moving it toward BRIGHT produces a brighter sound.

Using Digital Effects

This digital piano provides you with a selection of digital effects that you can apply to tones. The following provides general descriptions of each effect, but the best way to find out how they affect tones is to experiment for yourself.

Digital Effect Types

REVERB

The REVERB effect gives you a choice of the eight variations listed below. Each one simulates the acoustics of different environments.

The following table shows the name of each effect and the keyboard keys you press to select it.

Type	Keyboard Key Number*
Room 1	1
Room 2	2
Room 3	3
Stage	4
Hall 1	5
Hall 2	6
Delay	7
Pan Delay	8

* Number marked above keyboard key

CHORUS

The CHORUS effect adds depth and vibrato to notes.

The following are the eight chorus effects of this digital piano and the keyboard keys you press to select them.

Type	Keyboard Key Number*
Chorus 1	1
Chorus 2	2
Chorus 3	3
Chorus 4	4
F-back Chorus	5
Flanger	6
ShortDelay	7
ShortDelayFB	8

* Number marked above keyboard key

Keys Used for Configuring Digital Effect Settings

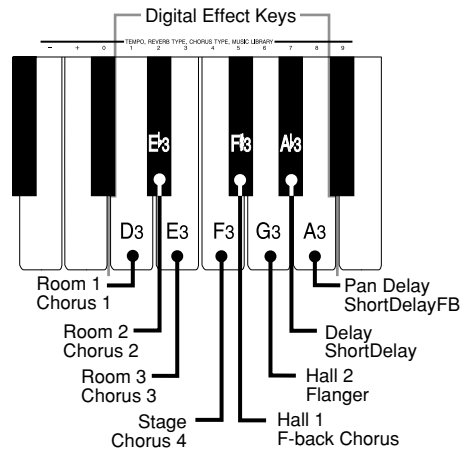

Turning Digital Effects On and Off

To turn this digital effect on or off:	Press this button:
Reverb	REVERB
Chorus	CHORUS

- The lamp above the corresponding button is lit when the digital effect is turned on, and unlit when the digital effect is turned off.

Selecting a Digital Effect

To select a reverb effect

- While holding down the REVERB button, press the keyboard key that corresponds to the number of the reverb effect you want to select.
 - A note does not sound when you press a keyboard key at this time.

To select a chorus effect

- While holding down the CHORUS button, press the keyboard key that corresponds to the number of the chorus effect you want to select.
 - A note does not sound when you press a keyboard key at this time.

Power on default effect settings

The table below shows the effect settings that are assigned to each tone whenever you turn on the digital piano power.

Tone Name	Digital Effect Setting	
	REVERB	CHORUS
GRAND PIANO 1	Hall 1	Off (Chorus 3)*
BRIGHT PIANO	Hall 1	Off (Chorus 3)*
GRAND PIANO 2	Hall 1	Off (Chorus 3)*
HONKY-TONK	Hall 1	Off (Chorus 3)*
ELEC PIANO 1	Hall 1	Chorus 3
ELEC PIANO 2	Hall 1	Chorus 3
HARPSICHORD	Hall 1	Off (Chorus 3)*
VIBRAPHONE	Hall 1	Chorus 3
PIPE ORGAN 1	Hall 1	Chorus 3
PIPE ORGAN 2	Hall 1	Off (Chorus 3)*
STRINGS 1	Hall 1	Chorus 3
STRINGS 2	Hall 1	Chorus 3
CHOIR	Hall 1	Chorus 3
SYNTH-PAD	Hall 1	Chorus 3
ACOUSTIC BASS	Hall 1	Off (Chorus 3)*
RIDE ACO BASS	Hall 1	Off (Chorus 3)*

* (): the initial setting of the chorus type when chorus effect is turned on.

- You can change the above digital effect settings after you turn on power.

NOTE

- Selecting a tone automatically selects the digital effects currently assigned to it.
- Changes you make to digital effect settings are assigned to the currently selected tone only.
- Digital effect settings remain in effect until you turn off the digital piano power.
- Demo tunes have their own digital effect settings, which are automatically selected whenever you select a demo tune.

Using the Pedals

This digital piano comes equipped with the three pedals shown in the illustration below.

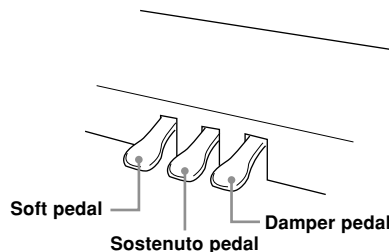

Pedal functions

- Damper pedal**
Pressing this pedal causes notes to reverberate and to sustain longer. In the case of the PIPE ORGAN and STRINGS tones, pressing this pedal sustains the notes played until you release the pedal.
- Soft pedal**
Pressing this pedal dampens notes and slightly reduces their volume. Only notes played after the pedal is depressed are affected, and any notes played before the pedal is pressed sound at their normal volume.
- Sostenuto pedal**
Like the damper pedal, this pedal causes notes to reverberate and to sustain longer. The difference between the two pedals is the timing when they are pressed. With the sostenuto pedal, you press the pedal after depressing the notes you want to sustain. Only the notes whose keyboard keys are depressed when the sostenuto pedal is pressed are affected.

NOTE

- The following shows how pedal effects are applied during different types of operations.

While you are performing this type of operation:	Pedal effects are applied to:
Song memory recording	Notes played on the keyboard only
Song memory playback	
Demo tune play	
Music Library play	

- Under the power on default setting, pedal effects are not applied to a split tone (page E-15). Perform the procedure below to apply pedal effects to a split tone.

To apply pedal effects to a split tone

- 1 While holding down the SETTING button, turn pedal effects on or off by pressing one of the keyboard keys shown in the illustration below.

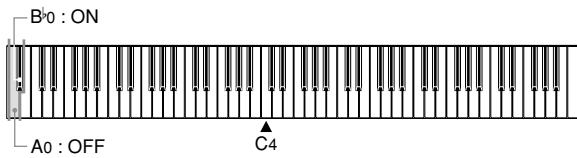

A0 : Pedal effects off
 B0 : Pedal effects on

- A note does not sound when you press a keyboard key while the SETTING button is depressed.

Using the Metronome

The metronome provides a reference beat that you can use during your performances or practice sessions. You can change the beat and the tempo of the metronome.

- The illustration below shows the keyboard keys you use when configuring metronome settings. The names of the settings are also marked above the keyboard keys to which they are assigned.

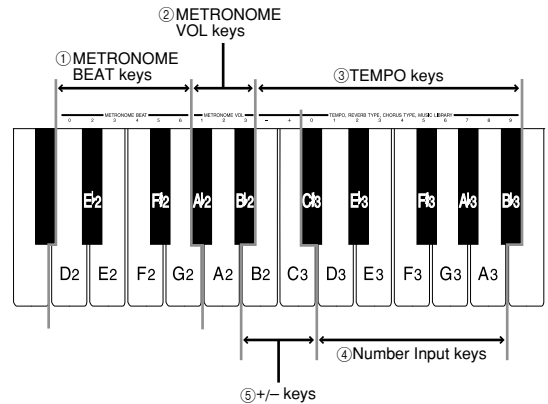

NOTE

- A note does not sound when you press any of the above keyboard keys while holding down the SETTING button.

Using the Metronome

PREPARATION

- Check to make sure that the indicator above the RECORD button is off. If the indicator is on, press the RECORD button to turn it off.
- See the section of this User's Guide covering the song memory for details on using the metronome in combination with the function.

To use the metronome

- 1 Press METRONOME to start the metronome.
- 2 Set the beat of the metronome.
 - While holding down the SETTING button, press the METRONOME BEAT key ① to select a beat setting.
 - A note does not sound when you press a keyboard key while holding down SETTING.
 - The first value of the beat can be set to a value of 2 through 6. The bell that normally indicates the first beat of a measure does not sound while a value of 0 is specified. All beats are indicated by a click sound. This setting lets you practice with a steady beat, without worrying about how many beats there are in each measure.
- 3 Use one of the procedures below to set the tempo to a value in the range of 30 to 255 beats per minute.
 - To scroll the tempo value: While holding down the SETTING button, use the TEMPO + (increase) and – (decrease) keys ⑤ to scroll the tempo value. Holding down either key changes the setting at high speed. Pressing + and – at the same time automatically selects a tempo value of 120.
 - To input the tempo value: While holding down the SETTING button, use the number input keys ④ to input a two-digit or three-digit tempo value in the range of 30 to 255. You can input a two digit or a three-digit value. The value you input is applied to the tempo when you release the SETTING button. The tempo setting does not change if you input a one-digit value or a value that is outside of the allowable range.
- 4 When you want to stop the metronome, press METRONOME again.
 - Pressing METRONOME again restarts the metronome sound using the current beat and tempo setting.
 - If you want to change both the tempo and the beat before restarting the metronome, perform the above procedure here.

NOTE

- You can change metronome beat and tempo settings at any time, even while the metronome is sounding.
- You can also use the metronome in combination with song memory play. See the section of this User's Guide covering the function for details.

Adjusting the Metronome Volume

Use the following procedure to increase and decrease the volume of the metronome beat.

To adjust the metronome volume

- 1 While holding down the SETTING button, use the METRONOME VOL keys ② to input 1, 2, or 3.

NOTE

- Metronome volume is automatically set to 2 whenever you turn on the digital piano.



Using the Song Memory

This section describes how to record keyboard play to memory and playback data from song memory.

About the Song Memory

Song Memory Capacity

- There are two song memory tracks named Track A and Track B. The two tracks can store a combined total of approximately 8,000 notes.
- Recording stops automatically and the indicator above the RECORD button goes out whenever memory becomes full.

Recorded Data

The following is a list of the data that can be recorded in song memory once recording starts.

- Anything you played on the keyboard (received MIDI data not recorded)
- Tone settings (including layered tones, layered tone volume, split tones, split tone volume, split point) and any tone setting changes
- Tempo and beat settings used during recording
- Pedal operations
- Reverb settings
- Chorus settings

Recorded Data Storage

This digital piano has a lithium battery to supply power to retain memory contents even while power is off.* The life of the lithium battery is five years after the date of manufacture of the digital piano. Be sure to contact your CASIO service provider about having the lithium battery replaced every five years.

* Never turn off piano power while a record operation is in progress.

IMPORTANT!

- If the data recorded in a single track uses up all the available Song Memory capacity, you will not be able to record anything in the other track.
 - Recording new data to a track automatically deletes any data previously stored in that track. A lit track indicator means that the track already contains data.
 - Turning off power while a record operation is in progress deletes anything recorded up to that point.
 - CASIO shall not be held responsible for any losses by you or any third party due to loss of data caused by malfunction or repair of this digital piano, or by battery replacement.
-

Recording

In addition to recording notes as they are played on the keyboard, you can also record to one track while playing back from the other track. The following procedures cover each of these operations.

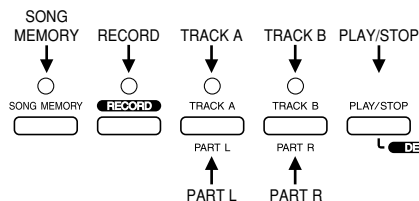

To record notes from the keyboard

PREPARATION

- Select the tone and digital effects you want to start with.
- Make sure that the indicator above the MUSIC LIBRARY button is not lit. If it is, press MUSIC LIBRARY to turn it off.
- Use the procedure under “Using the Metronome” on page E-19 for configure the tempo and beat settings you want to use during recording.

- 1 Press the SONG MEMORY button.
 - This causes the indicator lamp above the button to light.
 - If a track is already recorded, the indicator above its track button lights at this time.
 - If you want to use the metronome during recording, press the METRONOME button to start the metronome.
- 2 Press RECORD to put the digital piano into record standby.
 - The indicator above RECORD flashes.
 - If both tracks are empty (unrecorded), Track A is selected first for recording, which is indicated by the lamp above its button flashing. If only one of the tracks is empty, that track is selected first for recording.
 - If both tracks are already selected, the track recorded last is selected first. If both tracks are recorded and you have turned off power since recording, Track A is selected first.
 - You can also change the metronome’s beat setting at this time.

- 3 Press either of the TRACK buttons to select Track A or Track B.
 - The indicator above the button you press flashes to indicate that the track is selected for recording.
 - If the data recorded in a single track uses up all the available Song Memory capacity, you will not be able to record anything in the other track.
- 4 Play something on the keyboard to start recording.
 - What you play sounds from the speakers and is recorded into memory.
 - You can also start recording by pressing PLAY/STOP. In this case, blank space is inserted in memory from the point that you press PLAY/STOP up to the point you start to play on the keyboard.
 - The indicator lamp above the RECORD button changes from flashing to lit when recording starts.
- 5 After you are finished recording, press PLAY/STOP to stop the record operation.
 - At this time the indicator above RECORD goes out, while the indicator above the recorded track remains on.
 - Here you can press PLAY/STOP and playback the data you just recorded.
 - To exit the song memory mode, press the SONG MEMORY so its indicator lamp goes out.

To record to one track while playing back from the other track

This procedure is basically the same as that under “To record notes from the keyboard” on this page. The differences are as described below.

Example: To play back Track A while recording to Track B

- Before starting step 2 of the procedure on this page, press the TRACK A button so the indicator above it is lit.
- When you enter record standby, the indicator above the TRACK A button remains lit, while the indicator above the TRACK B button flashes. If the indicator above the TRACK A button is flashing at this time, press the TRACK B button so the indicator above it flashes.
- Performing step 4 of the procedure causes Track A playback and Track B recording to start at the same time. Play on the keyboard along with the playback of Track A.
- Once you enter record standby, you can also change the tempo and beat settings. It should be noted, however, that playback is performed following the last tempo and beat settings that were used for recording in either of the tracks.

Playback

Use the following procedure to play back from song memory.

To play back from song memory

- 1 Press the SONG MEMORY button.
 - This causes the indicator lamp above the button to light.
- 2 Press the TRACK button of the track you want to play back (A or B).
 - This causes the indicator lamp above the button of the track you select to light.
- 3 Press PLAY/STOP to start playback.
 - You can toggle the playback metronome sound on and off by pressing the METRONOME button.
 - To stop the metronome, press the METRONOME button.
 - Playback stops automatically when the end of the tune is reached.
 - To stop part way through, press PLAY/STOP.

NOTE

- If you want to playback song memory contents you have just recorded, simply press PLAY/STOP.
- You cannot change the tone when playing back from song memory.
- You can change the playback tempo while playing back from song memory.

Deleting Song Memory Contents

IMPORTANT!

- The delete operation cannot be undone. Make sure you play back song memory contents and confirm that you no longer need it before performing the following procedure.

To delete song memory contents

- 1 Press the SONG MEMORY button.
 - This causes the indicator lamp above the button of the track you select to light.
- 2 While holding down the SONG MEMORY button, press the button of the track (A or B) that you want to delete.
 - This deletes the contents of the track.
 - To exit the song memory mode, press the SONG MEMORY button.

Using Demo Tunes

This digital piano comes with 16 built-in demo tunes, each of which features one of the built-in tones.

Playing the Demo Tunes in Sequence

To play the demo tunes in sequence

- 1 While holding down the MUSIC LIBRARY button, press the PLAY/STOP button.
 - All the demo tunes play in sequence, starting from Tune 1.

Playing a Specific Demo Tune

To play a specific demo tune

- 1 After playback starts, press the tone button that corresponds to the tune you want to play.
 - Songs are played in sequence, in an endless loop, starting from the currently selected song.
 - Pressing the VARIATION button or the tone button of the current tone during demo tune play toggles the demo tune between its normal tone's tune and variation tone's tune.

Stopping Demo Tune Play

To stop demo tune play

- 1 Press the PLAY/STOP button to stop demo tune play.

NOTE

- You cannot change the tempo or tone, or turn on the metronome while a demo tune is playing.
- Playing on the keyboard during demo tune play plays notes using the demo tune's tone.
- You can adjust volume while demo playback is in progress.
- The setting below are changed automatically when a demo tune is played. These changes are temporary, and remain in effect only while the demo tune is playing.
 - Tone
 - Digital effect
 - Transpose
 - Tuning
 - Temperament : Equal Temperament
 - Baroque pitch : off
- Pedal operations performed during demo tune play are applied to notes played on the keyboard only. They are not applied to demo tune playback.
- Demo tune notes cannot be sent as MIDI data.

Demo Tune List

No.	Title	Composer	Tone	Time
1	Etude Op.10 No.12 "Revolutionary"	F.F.Chopin	GRAND PIANO 1	2'35"
2	Jesus Bleibet Meine Freude	J.S.Bach	PIPE ORGAN 2	1'18"
3	Original	—	ELEC PIANO 1	1'33"
4	Original	—	STRINGS 2	1'11"
5	Original	—	ACOUSTIC BASS	48"
6	Hungarian Dances No.5 (Duets)	J.Brahms	GRAND PIANO 2	2'24"
7	Original	—	VIBRAPHONE	1'10"
8	Mein junges Leben hat ein End	J.P.Sweelinck	CHOIR	1'18"
9	Original	—	BRIGHT PIANO	1'10"
10	Original	—	SYNTH-PAD	1'18"
11	HARMONIUS BLACKSMITH	G.F.HÄNDEL	HARPSICHORD	2'12"
12	Original	—	STRINGS 1	2'00"
13	Original	—	ELEC PIANO 2	1'55"
14	Original	—	RIDE ACO BASS	54"
15	Fantasia (Praeludium) und Fuga in G-Moll BWV542	J.S.Bach	PIPE ORGAN 1	1'48"
16	Scott Joplin's New Rag	S.Joplin	HONKY-TONK	1'04"

Using Music Library

Once you select one of the 50 built-in Music Library tunes, you can cut either the left-hand or right-hand part (primo and secondo part for duet tunes) and play along on the keyboard. You can adjust the tempo to play along at the pace that's comfortable for you, and you can use the metronome to help you keep in time.

See "Music Library Tunes" on page A-3 for full list of available Music Library tunes. Duet tunes are those marked "(Duets)".

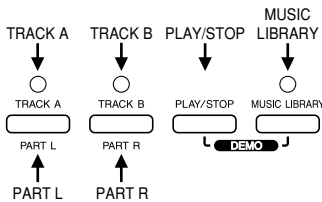

Playing Back Music Library Tunes

Use the following procedure when you want simply to play back a Music Library tune without playing along with it.

To play back a Music Library tune

- 1 Press the MUSIC LIBRARY button so the indicator above it is lit.
- 2 Turn the metronome on or off.

To turn the metronome off:

Press the METRONOME button so the indicator above it is not lit. With this setting, the pre-count prior to playback does not sound and metronome does not sound either. The indicator above the METRONOME button does, however, flash in time with tempo of the tune being played.

To turn the metronome on:

Press the METRONOME button so the indicator above it is lit. With this setting, a pre-count sounds before playback of the Music Library tune starts, and the metronome sounds during playback. The indicator above the METRONOME button flashes in time with tempo of the tune being played.

You can also configure the metronome so only a pre-count sounds prior to playback, without the metronome sounding during actual playback. See "To turn the metronome on or off during playback" for more information.

- 3 Select the number of the tune you want to play.
 - See "Music Library Tunes" on page A-3 for full list of available Music Library tunes.

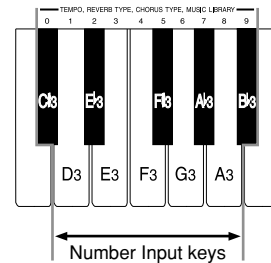

- While holding down the MUSIC LIBRARY button, use keyboard keys C₃ through B₃ (number input keys) to input the number of the song you want to play. A note does not sound when you press a keyboard key at this time. Input either a one-digit or a two-digit number. The number you input is registered when you release the MUSIC LIBRARY button.
 - Selecting a Music Library song causes the indicator lamps above both part buttons (L and R) to light.
 - To specify playback of all Music Library songs, specify 99 for the song number. The indicator lamp above the MUSIC LIBRARY button flashes during playback of all the Music Library songs.
- 4 Press PLAY/STOP to start playback.
 - If you turned on the metronome before starting this procedure, a count sounds before actual playback starts.
 - The tempo changes automatically to the preset tempo for the song being played back.
 - Notes played on the keyboard during Music Library tune playback are sounded using the tone setting of the selected tune.
 - 5 When you want to stop playback, press PLAY/STOP again.
 - If you selected a single tune, playback stops automatically when the end of the tune is reached.
 - If you selected "tune number 99", tune playback continues until you press PLAY/STOP.
 - To exit the Music Library mode, press the MUSIC LIBRARY so its indicator lamp goes out.

NOTE

- When you press the MUSIC LIBRARY button, the number of the song that was selected the last time you used the Music Library appears first.
- You can change the tempo of playback after you select a tune. You can return the tempo of a tune to its preset level by selecting the same tune again (step 2 of the above procedure).
- The following operations and settings can be performed while Music Library tune playback is in progress:
 - Volume
 - Brilliance
 - Tempo
 - Touch select
 - Tone
 - Left-hand part/right-hand part on and off
 - Metronome
 - Keyboard play
 - Pedal operations
- Receipt of MIDI IN data is enabled while Song Lesson playback is in progress.
- Pressing the PLAY/STOP button while in another mode besides the Music Library Mode or Song Memory Mode enters the Music Library Mode and starts playback.

To turn the metronome on or off during playback

- 1 While holding down the SETTING button, turn the metronome on or off by pressing one of the keyboard keys shown in the illustration below.

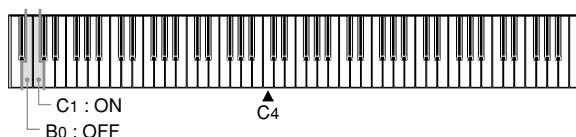

B0 : Off (Pre-count sounds prior to playback only, no metronome during playback)

C1 : On (Pre-count sounds prior to playback, and metronome sounds during playback)

- A note does not sound when you press a keyboard key while the SETTING button is depressed.

NOTE

- The power on default for the above setting is metronome on, which means that a pre-count sounds prior to playback, and the metronome sounds during playback.

Practicing Individual Parts (Part Lesson)

The left-hand part (or secondo part) and right-hand part (or primo part) are recorded separately for Music Library tunes. Because of this, you can turn off either part and play along with the other part on the keyboard. The terms “primo” and “secondo” refer to the parts of duet tunes.

PREPARATION

- Perform steps 1 and 2 of the procedure under “To play back a Music Library tune” on page E-25 to select the Music Library tune you want to practice.
- Set the tempo you want to use during the part lesson. Use the same procedure that you use to set the tempo of the metronome (page E-19).



To use Part Lesson

- 1 Press the PART L or PART R button to select the part you want to play on the keyboard.
 - Pressing either button causes the indicator above the other button to go out.
 - To practice the right-hand (or primo) part, press the PART R button.
 - PART R button indicator: Off
 - PART L button indicator: On
 - To practice the left-hand (or secondo) part, press the PART L button.
 - PART R button indicator: On
 - PART L button indicator: Off
- 2 Turn on the metronome, if you want.
 - Press METRONOME so the indicator above it is lit.
 - Leave the indicator above METRONOME off if you do not want to use the metronome during your practice session.
- 3 Press PLAY/STOP to start play of the Music Library tune and play along on the keyboard.
 - If you turned on the metronome, a count sounds for one measure before actual playback starts.
- 4 When you want to stop playback, press PLAY/STOP again.
 - Playback also stops automatically when the end of the tune is reached.

NOTE

- The beat of each Music Library tune is fixed, and cannot be changed.
- Recording to song memory (page E-21) cannot be started while playback of a Music Library tune is in progress.
- Pedal operations affect keyboard play only.
- See the notes under "Playing Back Music Library Tunes" on page E-25 for details on other operations.

Keyboard Settings

Using Touch Select

This setting lets you adjust the touch of the keyboard to suit your own playing style. This means you can select a stronger touch for those with powerful hands, and a lighter touch for beginners and anyone else with less strength. Use the keys shown below to change the Touch Select setting.

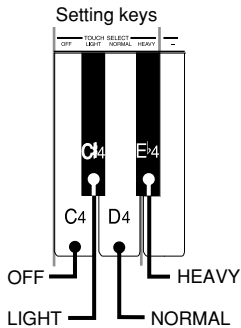

Touch Select Settings

OFF Off

LIGHT Light

This setting produces strong output, even when light pressure is applied to the keyboard.

NORMAL Normal

This is the standard setting.

HEAVY Heavy

This setting requires relatively strong keyboard pressure to produce normal output.

To change the Touch Select setting

- 1 While still holding down the SETTING button, select the key touch by pressing one of the keyboard keys.
 - A note does not sound when you press a keyboard key while holding down SETTING.

NOTE

- Touch select is automatically set to NORMAL whenever you turn on the digital piano power.

Using Transpose

Transpose lets you adjust the pitch of this digital piano in semitone steps.

This means you can change the key of the digital piano to suit the voice of a vocalist or the key of another musical instrument, without having to learn to play a piece in another key.

Use the keys shown below to change the transpose setting.

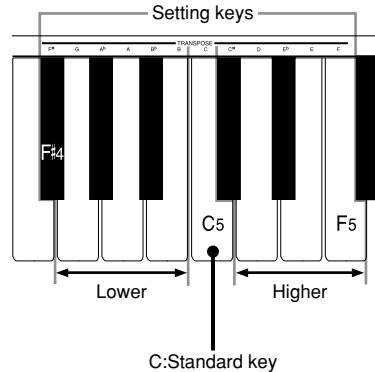

To change the transpose setting

- 1 While holding down the SETTING button, select a key by pressing one of the keyboard illustrated above.
 - The digital piano can be transposed within a range of F# to C to F.
 - A note does not sound when you press a keyboard key while holding down SETTING.

NOTE

- The transpose value is automatically set to 0 (C) whenever you turn on the digital piano power.

Adjusting the Tuning of the Digital Piano

You can adjust the overall tuning of the digital piano for play along with another instrument. You can adjust tuning within a range of ± 50 cents* from $A_4 = 440.0\text{Hz}$.

Use the keyboard keys noted below to adjust the tuning of the digital piano.

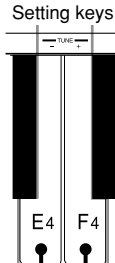

- : lowers the pitch + : raises the pitch

To adjust the tuning of the digital piano

1 While holding down the SETTING button, press keyboard key E4 (-) to lower the tuning or F4 (+) to raise it. Each press of a key changes the tuning by about 0.8 cents* (1/128 semitone).

- Holding down either key changes the setting at high speed.
- A note does not sound when you press a keyboard key while holding down SETTING.

NOTE

- Holding down the SETTING button and pressing keyboard keys E4 (-) and F4 (+) at the same time returns tuning to the standard $A_4 = 440.0\text{Hz}$.

* 100 cents is equivalent to one semitone.

Temperament

Modern pianos employ a tuning system called “Equal Temperament,” which is also used by your digital piano. Equal Temperament, however, is a relatively new tuning system, and different temperaments were in use during the times of Bach, Beethoven, and Chopin.

Your digital piano comes with the seven temperament settings listed below, which adjust the tuning of the keyboard to suit a variety of classical pieces.

Use the keys shown below to change the temperament setting.

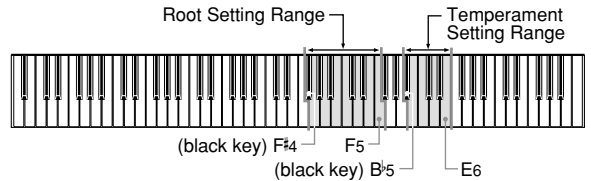

- B^b5 Equal Temperament
- B5 Kirnberger III
- C6 Werckmeister
- C[#]6 Mean-Tone System
- D6 Pythagorean System
- E^b6 Just Major Intonation
- E6 Just Minor Intonation

NOTE

- Equal temperament and a root of C are assigned as defaults whenever you turn on the digital piano power.
- See “About Temperaments” on page E-30 for further details.

To change the temperament

1 Hold down the SETTING button. Note that you must keep the SETTING button depressed until step 4, below.

2 While still holding down the SETTING button, select the temperament by pressing one of the keyboard keys illustrated below.

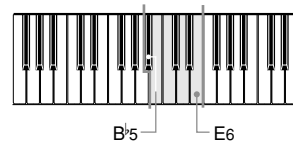

- No sound is produced when the keys are pressed.

3 Select a root by pressing one of the keys in the range shown in the illustration below. Remember to keep the **SETTING** button depressed.

- The note for the keyboard key you press is applied as the root. If you press key F5, for example, the root becomes F.

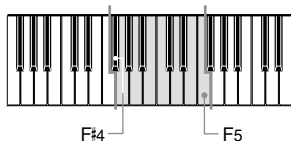

- No sound is produced when the keys are pressed.
- When Baroque Pitch (page E-31) is ON, the root is a half-note higher than the key you press. This means that to set a root of C, you should press B4.

4 Release the **SETTING** button to exit temperament setting.

NOTE

- If you select the temperament only without specifying the root in the above procedure, the root automatically becomes C.
- Temperament root settings are not affected when you change the Transpose setting.
- The keys you should press to set the root in step 3 of the above procedure are fixed. They are not affected by transpose settings, etc.

About Temperaments

● Equal Temperament

This tuning system is the most widely used for keyboard musical instruments in the world today. The octave is divided into 12 semitones that are equal in frequency ratio. With this system, you can perform in all the major and minor keys without any adjustment. Though we take this system for granted these days, it was a revolutionary development in the history of music. Equal Temperament tuning has been the most common system used in the world since the middle of the 18th Century.

● Kirnberger III

This is also one of the precursors to equal temperament. It is an evolution of just intonation and the mean-tone system, and all keys (from C-major to F#-major) can be used for keyboard play.

● Werckmeister

Werckmeister is a famous theorist who also did research on equal temperament. This particular system is said to be a precursor to equal temperament, and all keys (from C-major to F#-major) can be used for keyboard play.

● Mean-Tone System

This system was the first actually used for tuning of keyboard musical instruments. It was widely used starting from the Renaissance up until the second half of the 18th Century. During the days of Handel and Bach, it was employed for cembalos, organs, and pianos.

● Pythagorean System

This system was developed by the philosopher Pythagoras sometime during the 5th Century B.C. Most of the fifths in this system do not deviate from the "pure" (acoustically correct) intervals. The Pythagorean system is perfect within a small range of tones and in the simple keys, but it becomes inadequate in others. Despite this, this system was used for Middle Age religious music, which was performed (sung) using only the simple keys.

● Just Intonation

This system is one of the "pure" systems in which many of the fifths and thirds are acoustically correct. Try setting the root to C and playing C, E, G.

Using Baroque Pitch

During the Baroque Era, standard pitch (A₄) was lower than the modern standard. The Baroque pitch setting of your digital piano lets you play Baroque era music at the pitch it was written for.

Use the keys shown below to change the Baroque pitch setting.



- A^b₅ ON: Baroque pitch (A₄ = 415.3Hz)
- G₅ OFF: Modern standard (A₄ = 440.0Hz)

To turn Baroque pitch off and on

- 1 Hold down the SETTING button. Note that you must keep the SETTING button depressed until step 3, below.
- 2 While still holding down the SETTING button, switch baroque pitch on or off by pressing one of the keyboard keys illustrated below.

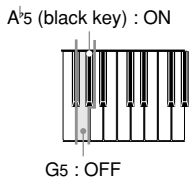

- No sound is produced when the keys are pressed.

- 3 Release the SETTING button.

NOTE

- The Baroque pitch setting you make is retained until you change it or until you switch power off. Whenever you switch power on, the default setting is off (A₄ = 440.0Hz).

MIDI

What is MIDI?

MIDI is a standard for digital signals and connectors that allows musical instruments, computers, and other devices, regardless of manufacturer, to exchange data with each other.

MIDI Connections

Connecting your computer or other external MIDI device to the digital piano's MIDI IN/OUT terminals makes it possible for them to exchange MIDI messages and record and playback keyboard notes on the connected device.

[Bottom]

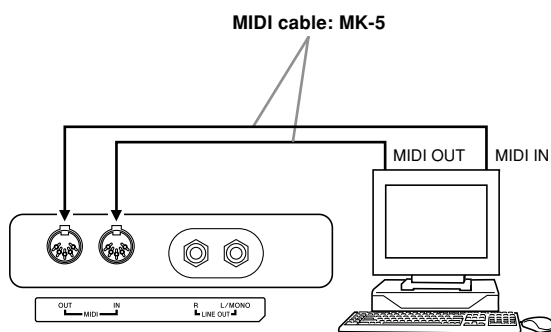

Simultaneous Receive Over Multiple Channels (Multi-Timbre)

The Multi-Timbre mode makes it possible to assign the digital piano's built-in tones to MIDI channels 1 through 16. Then you can simultaneously sound multiple channels to play from a commercially available multi-track sequencer.

NOTE

- See "Assigning Tones to Individual Channels" on this page for details on assigning tones to each channel.
- Up to 16 channels can be received simultaneously (Channel 1 through channel 16).
- The number of channels to be received simultaneously cannot be predetermined. If it becomes necessary to cancel a channel, the cancel operation must be performed on the sending side.

Specifying the Keyboard Channel

The keyboard channel is the channel used when sending MIDI messages to another MIDI device. You can specify any channel from 1 through 16 as the keyboard channel.

To specify the keyboard channel

- 1 While holding down the SETTING button, specify the keyboard channel by pressing one of the keyboard keys shown in the illustration below.

Example: Channel 8

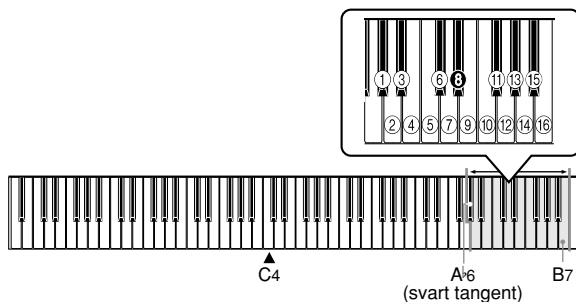

- A note does not sound when you press a keyboard key while holding down SETTING.

NOTE

- The keyboard channel is automatically set to 1 whenever you turn on the digital piano power.

Assigning Tones to Individual Channels

You can assign tones to channels using a Program Change message sent from a connected MIDI device. You cannot change the tone assigned to each channel from the digital piano.

NOTE

- The GRAND PIANO 1 tone is automatically assigned to all channels whenever you turn on the digital piano power.

Sending Song Memory Playback Data

You can send song memory playback as MIDI data. The send channel used depends on the keyboard channel setting, as shown in the table below.

Keyboard Play	Keyboard Channel
Keyboard main tone data	Keyboard Channel
Keyboard layer tone data	Keyboard Channel + 1*
Keyboard split tone data	Keyboard Channel + 2*
Main tone data inside of Track A playback data	Keyboard Channel + 3*
Layer tone data inside of Track A playback data	Keyboard Channel + 4*
Split tone data inside of Track A playback data	Keyboard Channel + 5*
Main tone data inside of Track B playback data	Keyboard Channel + 6*
Layer tone data inside of Track B playback data	Keyboard Channel + 7*
Split tone data inside of Track B playback data	Keyboard Channel + 8*

* Whenever adding the keyboard channel number to a value from 1 to 8 produces a result that is greater than 16, the send channel used is the one whose number is equal to the result minus 16.

NOTE

- Pedal effect data recorded to memory is applied to play back from song memory, and does not affect your performance on the keyboard. Likewise, pedal operations on the digital piano are applied to the keyboard only, and not to play back from the song memory.

Turning Local Control On and Off

This setting effectively determines whether or not the keyboard and pedals of the digital piano are connected to the digital piano's sound source.

To turn Local Control on and off

- 1 While still holding down the SETTING button, switch Local Control on and off by pressing one of the keyboard keys illustrated below.

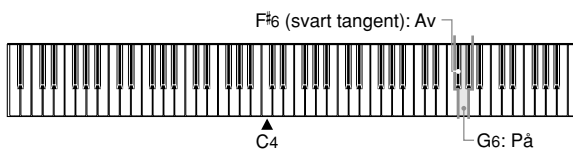

- A note does not sound when you press a keyboard key while holding down SETTING.

NOTE

- Note that no sound will be produced from the digital piano's speakers if you press the keyboard while Local Control is turned off.
- Local Control is turned on automatically whenever you turn on the digital piano power.

MIDI Data Notes

This section provides details about the MIDI data this digital piano sends and receives. You can also find further technical information in the "MIDI Data Format" on page A-4 and "MIDI Implementation Chart"* at the end of this User's Guide.

* The MIDI Implementation Chart is a standard format summary of how data is transferred between this digital piano and a connected MIDI device.

Keyboard Data (Note On, Note Off, Note Number, Velocity)

The following four types of keyboard data can be sent and received.

Data	Meaning
Note On	Keyboard key is pressed.
Note Off	Keyboard key is released.
Note Number	Which key is pressed.
Velocity	Pressure applied

Tone Change Data (Program Change)

A program number is data used for tone selection. Program numbers come in handy when using the tones of this digital piano to play MIDI data received from an external sequencer or other MIDI device. When the program number received from another device does not match one of the built-in tones of this digital piano, however, the tone change is ignored and play continues without a tone change.

The following shows the program numbers that are supported by this digital piano.

Tone Name	Send			Receive		
	Bank Select		Program numbers	Bank Select		Program numbers
	MSB	LSB		MSB	LSB	
GRAND PIANO 1	2	0	0	2	0	0
BRIGHT PIANO	2	0	1	2	0	1
GRAND PIANO 2	0	0	0	0	0	0
HONKY-TONK	0	0	3	0	0	3
ELEC PIANO 1	16	0	4	16	0	4
ELEC PIANO 2	0	0	4	0	0	4
HARPSICHORD	0	0	6	0	0	6
VIBRAPHONE	0	0	11	0	0	11
PIPE ORGAN 1	0	0	19	0	0	19
PIPE ORGAN 2	24	0	19	24	0	19
STRINGS 1	2	0	49	2	0	49
STRINGS 2	0	0	48	0	0	48
CHOIR	0	0	52	0	0	52
SYNTH-PAD	0	0	88	0	0	88
ACOUSTIC BASS	0	0	32	0	0	32
RIDE ACO BASS	32	0	32	32	0	32

Pedal and Effect Operation Data (Control Change and Universal System Exclusive Message)

Control Change is used to send and receive data about damper, soft, and sostenuto pedal depress and release operations, as well as data about digital effects.

Troubleshooting

Symptom	Possible Cause	Action	Reference
No sound produced when keyboard keys are pressed.	<ol style="list-style-type: none"> 1. VOLUME slider set to MIN. 2. Headphones connected to the digital piano. 3. Local Control turned off. 	<ol style="list-style-type: none"> 1. Move VOLUME slider more towards the MAX side. 2. Disconnect the headphones from the digital piano. 3. Turn on Local control. 	<p>Page E-12</p> <p>Page E-11</p> <p>Page E-33</p>
Keyboard out of tune.	<ol style="list-style-type: none"> 1. Transpose is set to a value other than 0. 2. Incorrect tuning setting 3. Baroque pitch is turned on. 	<ol style="list-style-type: none"> 1. Change the transpose setting to 0, or turn the digital piano power off and then back on again. 2. Correct the tuning setting, or turn the digital piano power off and then back on again. 3. Turn off baroque pitch or turn power off and then back on again. 	<p>Page E-28</p> <p>Page E-29</p> <p>Page E-31</p>
Pedal effect continues to be applied even though pedals are not pressed.	Problem with the connection between the pedals and the digital piano.	Turn off the digital piano power and then check to make sure that the pedal plug is securely connected to the digital piano's pedal connector.	Page E-38
No sound produced by demo tune play.	<ol style="list-style-type: none"> 1. VOLUME slider set to MIN. 2. Headphones connected to the digital piano. 	<ol style="list-style-type: none"> 1. Move VOLUME slider more towards the MAX side. 2. Disconnect the headphones from the digital piano. 	<p>Page E-12</p> <p>Page E-11</p>
Song Memory contents deleted.	Lithium battery is dead.	Contact your CASIO Service Provider for replacement of the lithium battery.	Page E-40
Song Memory track cannot be selected.	Data recorded in the other track uses up all available Song Memory capacity.	Delete the data recorded in the other track.	Page E-23
Chords or scales sound strange.	Wrong temperament	Return the temperament setting to equal temperament, or turn power off and then back on again.	Page E-29
No sound produced by connected external MIDI sound source when the digital piano keys are pressed.	<ol style="list-style-type: none"> 1. The digital piano Basic Channel does not match the Basic Channel of the MIDI sound source. 2. Volume or expression setting of the external sound source is set to 0. 	<ol style="list-style-type: none"> 1. Change the Basic Channel settings so they are identical. 2. Change the volume or expression setting of the external sound source to an appropriate value. 	<p>Page E-32</p> <p>See the documentation that comes with the external sound source.</p>

Assembly Instructions

⚠ CAUTION

- Take particular care to avoid injury when installing legs and pedals, and when mounting the keyboard onto the stand.
- When assembling, make sure that the sliding keyboard cover of the digital piano body is completely closed. If the cover is left open during assembly, it may close suddenly causing the fingers to be pinched between the digital piano body and cover.

Important!

- Be sure to assemble the stand on a flat surface.
- This stand does not include any of the tools required to assemble it. You should have a large Phillips head (+) screwdriver on hand for assembly.

Figure 1

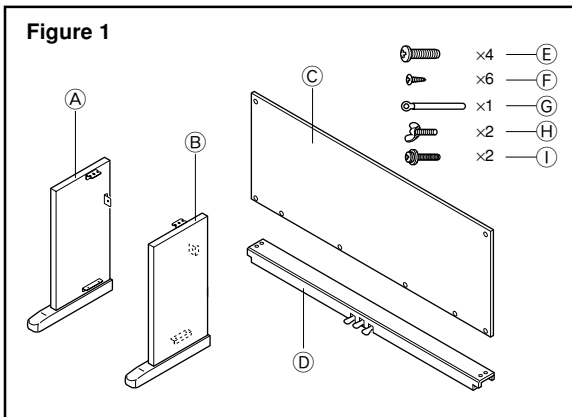

- Check the items that come with the unit to make sure that everything shown in Figure 1 (A through I) is included. All screws are in a plastic bag inside of the packing cardboard.

Figure 2

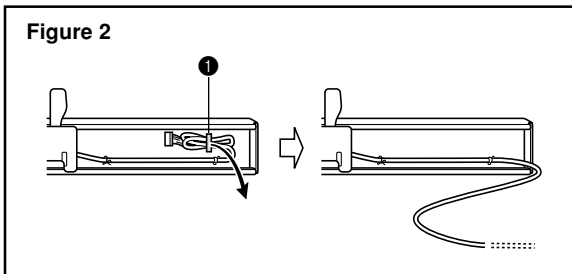

- Before starting actual assembly of the stand, undo the clip at location 1 (Figure 2) where the pedal cable comes out the back of crosspiece D.

1 Assembling the stand

Refer to Figures 3, 4 and 5 as you assemble the stand according to the following procedure.

Figure 3

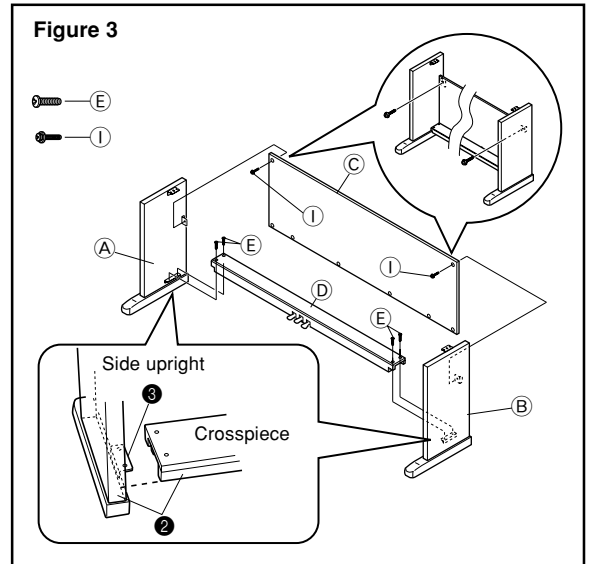

1. Attach side uprights (A) and (B) to crosspiece (D) using the four (E) screws (Figure 3).

- When joining the two pieces marked 2, the metal pieces 3 on the insides of side uprights (A) and (B) should fit into the slots at the ends of crosspiece (D). Make sure the metal pieces are pushed into the slots as far as they will go. If they are not, the metal pieces 3 and the screws (E) will not match up correctly, which can cause stripping of the screws.

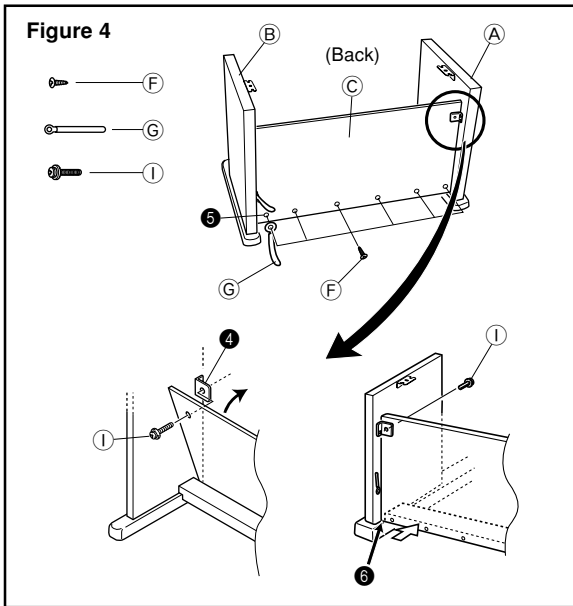

2. Attach back panel **C** to the **4** brackets and crosspiece **D**. Note that the back panel **C** should be installed so it is in front of the **4** brackets (Figure 4). Use the two **I** screws, six **F** screws to secure the back panel in place (Figures 3 and 4). Note that you must also install the **G** clip at this time as shown in the illustration.

- First, install the topmost **I** screws on the left and right sides of the back panel **C**. Note that you should slip the **G** clip onto the **F** screw at point **5** before you screw in the **F** screw.
- The back panel **C** should rest on the feet of side uprights **A** and **B** as indicated by **6** in the illustration. Press the back panel **C** against crosspiece **D** while installing the **I** screws.

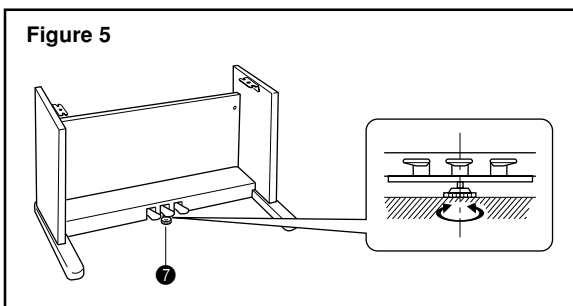

3. Rotate height adjustment screw **7** until it supports crosspiece **D**, preventing the crosspiece from bending when you press the pedals (Figure 5).

Important!

- Be sure to rotate adjustment screw **7** and perform the adjustment procedure described above before depressing the pedals. Failure to do so can result in damage to crosspiece **D**.

2 Installing the Keyboard onto the Stand

CAUTION

Take care that you do not pinch your fingers between the keyboard and stand!

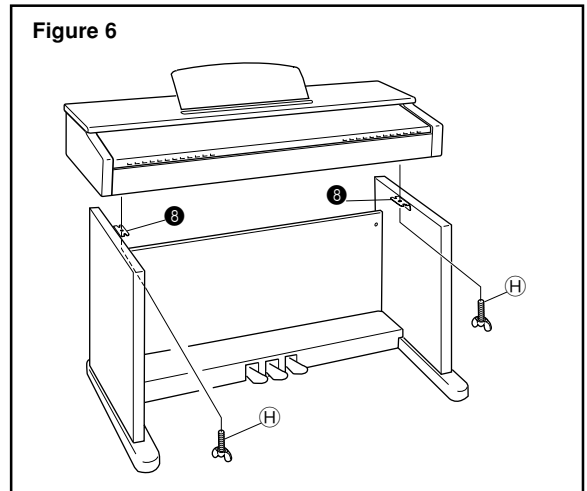

Be sure that you securely anchor the keyboard to the stand using the **H** butterfly bolts (Figure 6).

- Slide the screws on the bottom of the keyboard into the slots in the two angle brackets **8**. Next, secure the keyboard to the stand with two butterfly bolts **H** (Figure 7).

Figure 7

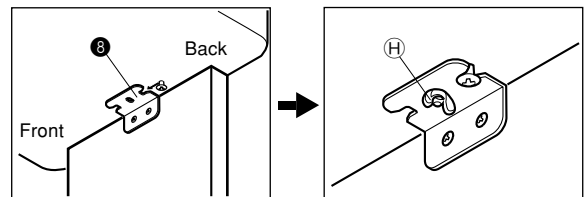

- The butterfly bolts keep the keyboard from falling from the stand. Be sure that you always secure the keyboard with the butterfly bolts.

3 Connecting the Pedal

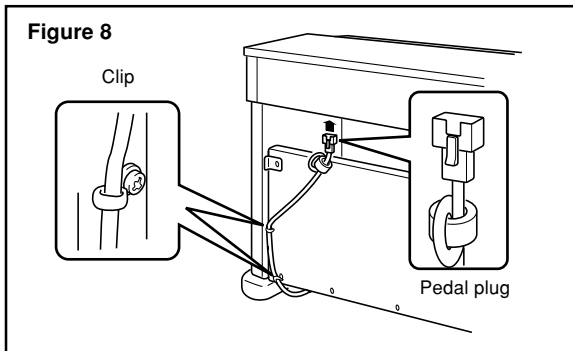

Position the pedal plug as shown in Figure 8 and insert it into the pedal connector on the bottom of the digital piano. Secure the pedal cable to the upright of the stand using the clips (Figure 8).

4 Connecting to a Power Supply

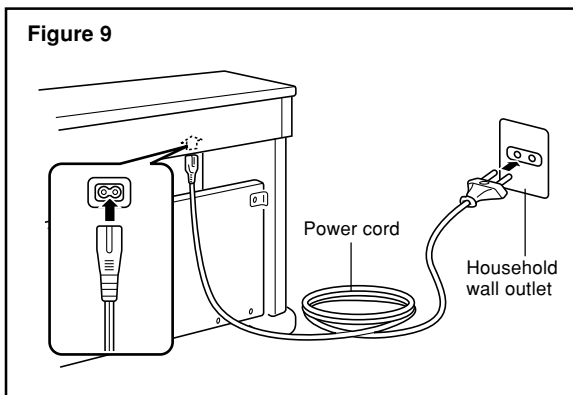

1. Check to make sure that the digital piano's POWER button is in the OFF position. If it is ON, press the button to switch it OFF.
2. Attach the power cord that comes with the digital piano to the bottom of the digital piano.*
3. Plug the digital piano's power cord into a wall outlet (Figure 9).

* applies to the AP-45V.

Important!

- The shapes of the digital piano's power cord and wall outlet should be different according to countries or regions. The illustrations are examples.
- With the AP-45, the power cord is hard-wired to the bottom of the instrument.

CAUTION

- The screws that you use to assemble the stand may become loose after a long period due to changes in temperature and humidity, or vibration caused by normal use, etc. Periodically check the screws used to fasten the stand and the butterfly bolts used to fasten the stand and the digital piano, and tighten them whenever necessary.

Power Outlet

- To power the digital piano, use a power outlet that allows easy access when plugging in or unplugging the power cord.

Attachment of the Score Stand

Install the music stand by inserting its pegs into the holes in the top of the piano.

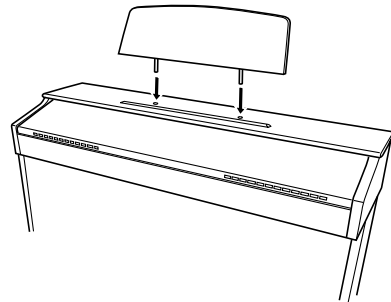

Specifications

All of the items in these specifications apply to the AP-45 and AP-45V, unless specifically noted otherwise.

Models:	AP-45/AP-45V
Keyboard:	88 piano keys (with touch response)
Polyphony:	64 notes, maximum
Tones:	<ul style="list-style-type: none"> • 16 • Layer: Adjustable volume • Split: Split point, adjustable volume
Digital Effects:	Reverb (8 types), Chorus (8 types), Brilliance
Demo Tunes:	<ul style="list-style-type: none"> • Number of Tunes: 16 • Playback: Repeat (all tunes, one tune)
Song Memory:	<ul style="list-style-type: none"> • Operations: Real-time recording, playback • Number of Tracks: 2 (Track A, Track B) • Capacity: Approximately 8,000 notes (total of 2 tracks) • Memory Backup: Built-in lithium battery (Battery Life: Approximately 5 years)
Music Library:	<ul style="list-style-type: none"> • Number of Tunes: 50 • Playback: All song repeat, specific song • Part Off: L, R
Pedals:	Damper, Soft, Sostenuto
Other Functions:	<ul style="list-style-type: none"> • Metronome: Beat (6 types), Tempo (\downarrow = 30 to 255) • Touch Select: 3 types, off • Transpose: 1 octave (F# to C to F) • Tuning: A4 = 440.0Hz \pm50 cents (adjustable) • Temperament: 7 types • Baroque pitch
MIDI:	16 multi-timbre receive
Input/Output:	<ul style="list-style-type: none"> • Headphones: Stereo standard jacks \times 2 • LINE OUT (R, L / MONO): Standard jacks \times 2 Output Impedance ; 1.1KΩ Output Voltage ; 1.3V (RMS) MAX • MIDI (OUT) (IN)
Speakers:	\varnothing 16cm \times 2, \varnothing 5cm \times 2 (Output: 20 W + 20 W)
Power Supply:	AP-45: 120V AP-45V: 220-240V
Power Consumption:	AP-45: 60W AP-45V: 60W
Dimensions:	<ul style="list-style-type: none"> • Digital Piano (without stand): 136.9 \times 43.9 \times 23.0 cm (53 $\frac{15}{16}$ \times 17 $\frac{5}{16}$ \times 9 $\frac{1}{16}$ inch) • Digital Piano: 137.9 \times 44.8 \times 83.8 cm (54 $\frac{5}{16}$ \times 17 $\frac{10}{16}$ \times 33 inch)
Weight:	<ul style="list-style-type: none"> • Digital Piano (without stand): approximately 34.0 kg (75.0 lbs) • Digital Piano: approximately 46.0 kg (101.4 lbs)

- Design and specifications are subject to change without notice.
- AP-45 has hardwired power cords.
- AP-45V has detachable power cords.



Operational Precautions

Locating the Unit

Avoid the following locations.

- Areas exposed to direct sunlight and high humidity
- Areas subjected to very low temperatures
- Near a radio, TV, video deck, or tuner (unit can cause interference with audio or video signals)

Care of the Unit

- Never use benzene, alcohol, thinner or other such chemicals to clean the exterior of the unit.
- To clean the keyboard, use a soft cloth dampened with a weak solution of a mild neutral detergent and water. Wring out all excess moisture from the cloth before wiping.

Lithium Battery

This unit is equipped with a lithium battery to provide power needed to retain memory contents while unit power is turned off. Should the lithium battery go dead, all memory contents will be lost whenever you turn unit power off. The normal life of the lithium battery is about five years from the time that the battery was installed. Be sure to periodically contact your retailer or authorized service provider to have the lithium battery replaced. Note that you will be charged separately for lithium battery replacement.

- Note that CASIO COMPUTER CO., LTD. shall not be held liable for any damages or losses or any claims by third parties arising from corruption or loss of data caused by malfunction or repair of the unit, or from battery replacement.

You may notice lines in the finish of the case of this product. These lines are the result of the molding process used to shape the plastic of the case. They are not cracks or breaks in the plastic, and are no cause for concern.

NOTE

- Unauthorized reproduction of this manual in its entirety or in part is expressly forbidden. All rights reserved.
 - CASIO COMPUTER CO., LTD. shall not be held liable for any damages or losses or any claims by third parties arising from use of this product or this manual.
 - The contents of this manual are subject to change without notice.
-

Appendix/Appendice

Initial Power On Settings

The table below shows the initial settings of the digital piano whenever power is turned on.

Item		Setting
Tone		GRAND PIANO 1
Digital Effect	Reverb	Hall 1 (GRAND PIANO 1)
	Chorus	Off (GRAND PIANO 1)
Layer		Off (Layer Volume: 72)
Split		Off (Split Volume: 127), Split point: B ₃
Metronome	Volume	2
	Tempo	120
	Beat	4
Playback Track		Recorded track
Touch Select		Normal
Transpose		C
Tuning		A4 = 440.0Hz
Temperament		Equal Temperament, Root C
Baroque Pitch		Off
Music Library		Off
	Song Number	1
	Part L	On
	Part R	On
MIDI	Keyboard Channel	Channel 1
	Local Control	On
	Tone Assigned to Each Channel	GRAND PIANO 1

Ajustes iniciales al activarse la alimentación

La tabla siguiente muestra los ajustes iniciales del piano digital siempre que se activa la alimentación.

Item		Ajuste
Sonido		GRAND PIANO 1
Efecto digital	Reverberación	Hall 1 (GRAND PIANO 1)
	Chorus	Off (GRAND PIANO 1)
Estratificador		Desactivado (Volumen del estratificador: 72)
División		Desactivado (volumen de división: 127), Punto de división: B3
Metrónomo	Volumen	2
	Tempo	120
	Tiempo	4
Pista de reproducción		Pista grabada
Selección de toque		Normal
Transposición		C
Afinación		A4 = 440,0Hz
Temperamento		Temperamento uniforme, nota fundamental C
Altura tonal barroca		Desactivado
Biblioteca musical		Desactivado
	Número de canción	1
	Parte L (izquierda)	Activado
	Parte R (derecha)	Activado
MIDI	Canal de teclado	Canal 1
	Control local	Activado
	Sonido asignado a cada canal	GRAND PIANO 1

Music Library Tunes/Melodías de la biblioteca musical

Tune Number/ Número de melodía	Tune Name/Nombre de melodía	Composer/ Compositor	Tune Number/ Número de melodía	Tune Name/Nombre de melodía	Composer/ Compositor
1	Klavierbüchlein für Anna Magdalena Bach "Menuet"	J.S.Bach	24	Etude Op.10 No.3 "Chanson de l'adieu"	F.F.Chopin
2	Invention No.1	J.S.Bach	25	Etude Op.10 No.5 "Black Keys"	F.F.Chopin
3	Invention No.8	J.S.Bach	26	Etude Op.10 No.12 "Revolutionary"	F.F.Chopin
4	Invention No.13	J.S.Bach			
5	Wohltemperierte Klavier I Praeludium 1	J.S.Bach	27	Prelude Op.28 No.7	F.F.Chopin
			28	Valse Op.64 No.1 "Petit Chien"	F.F.Chopin
6	Goldberg-Variationen Aria	J.S.Bach	29	Valse Op.64 No.2	F.F.Chopin
7	Goldberg-Variationen Var.30	J.S.Bach	30	Fröhlicher Landmann	R.Schumann
8	Sonata K.545 1st Mov.	W.A.Mozart	31	Von fremden Ländern und Menschen	R.Schumann
9	Sonata K.331 1st Mov. Theme	W.A.Mozart			
10	Sonata K.331 3rd Mov. "Turkish March"	W.A.Mozart	32	Träumerei	R.Schumann
			33	Arabesque	F.Burgmüller
11	Variations on "Ah, Vous DiRai-je, Maman" K.265	W.A.Mozart	34	La Chevaleresque	F.Burgmüller
			35	La Prière d'une Vierge	T.Badarzewska
12	Sonatina Op.36 No.1 1st Mov.	M.Clementi	36	Liebesträume No.3	F.Liszt
13	Sonata Op.13 "Pathétique" 1st Mov.	L.v.Beethoven	37	Blumenlied	G.Lange
			38	Hungarian Dances No.5 (Duets)	J.Brahms
14	Sonata Op.13 "Pathétique" 2nd Mov.	L.v.Beethoven	39	Rhapsodie No.2	J.Brahms
			40	Waltz Op.39 No.15 (Duets)	J.Brahms
15	Sonata Op.13 "Pathétique" 3rd Mov.	L.v.Beethoven	41	Promenade From "Tableaux d'une Exposition"	M.Mussorgsky
16	Sonata Op.27 No.2 "Moonlight" 1st Mov.	L.v.Beethoven	42	Berceuse (Duets)	G.Fauré
			43	Passepied	C.A.Debussy
17	Sonata Op.31 No.2 "Tempest" 3rd Mov.	L.v.Beethoven	44	La Fille aux Cheveux de Lin	C.A.Debussy
			45	Arabesque No.1	C.A.Debussy
18	Für Elise	L.v.Beethoven	46	The Entertainer	S.Joplin
19	Moments Musicaux Op.94 No.3	F.P.Schubert	47	Maple Leaf Rag	S.Joplin
20	Impromptu Op.142 No.3 "Thema"	F.P.Schubert	48	Gymnopédies No.1	E.Satie
21	Marche Militaire No.1 (Duets)	F.P.Schubert	49	Gnossiennes No.1	E.Satie
22	Nocturne Op.9 No.2	F.F.Chopin	50	Je Te Veux	E.Satie
23	Fantaisie-Impromptu Op.66	F.F.Chopin			

Items marked “★” are receive only.

Channel Messages

Note Messages

Note Off

Recognition

Format

Byte 1	Byte 2	Byte 3
8nH	kkH	vvH
9nH	kkH	00H

n Voice Channel Number = 0H to FH (Ch1 to Ch16)
 kk Note Number = 00H to 7FH
 vv Note Off Velocity = 00H to 7FH

Remarks

Note Off Velocity value is ignored.

Send

Format

Byte 1	Byte 2	Byte 3
8nH	kkH	vvH

n Voice Channel Number = 0H to FH (Ch1 to Ch16)
 kk Note Number = 15H to 6CH
 vv Note Off Velocity = 40H

Note On

Recognition

Format

Byte 1	Byte 2	Byte 3
9nH	kkH	vvH

n Voice Channel Number = 0H to FH (Ch1 to Ch16)
 kk Note Number = 00H to 7FH
 vv Note On Velocity = 00H to 7FH

Send

Format

Byte 1	Byte 2	Byte 3
9nH	kkH	vvH

n Voice Channel Number = 0H to FH (Ch1 to Ch16)
 kk Note Number = 15H to 6CH
 vv Note On Velocity = 01 to 7FH

Control Change

Bank Select

Format

Byte 1	Byte 2	Byte 3
BnH	00H	mmH (Bank Select MSB)
BnH	20H	llH (Bank Select LSB)

n Voice Channel Number = 0H to FH (Ch1 to Ch16)
 mm Bank Number MSB = 00H
 ll Bank Number LSB = 00H

Send

A Bank Select message is sent at the same time when you select a tone on the instrument.

Modulation Wheel ★

Format

Byte 1	Byte 2	Byte 3
BnH	01H	vvH

n Voice Channel Number = 0H to FH (Ch1 to Ch16)
 vv Modulation Depth = 00H to 7FH

Portamento Time ★

Format

Byte 1	Byte 2	Byte 3
BnH	05H	vvH

n Voice Channel Number = 0H to FH (Ch1 to Ch16)
 vv Portamento Time = 00H to 7FH

Data Entry

Format

Byte 1	Byte 2	Byte 3
BnH	06H	mmH (Data Entry MSB)
BnH	26H	llH (Data Entry LSB)

n Voice Channel Number = 0H to FH (Ch1 to Ch16)
 mm Data entry MSB value for the parameter that is selected by RPN and NRPN
 ll Data entry LSB value for the parameter that is selected by RPN and NRPN

Channel Volume ★

Format

Byte 1	Byte 2	Byte 3
BnH	07H	vvH

n Voice Channel Number = 0H to FH (Ch1 to Ch16)
 vv Volume = 00H to 7FH

Pan ★

Format

Byte 1	Byte 2	Byte 3
BnH	0AH	vvH

n Voice Channel Number = 0H to FH (Ch1 to Ch16)
 vv Pan = 00H (left) to 40H (center) to 7FH (right)

Expression Controller ★

Format

Byte 1	Byte 2	Byte 3
BnH	0BH	vvH

n Voice Channel Number = 0H to FH (Ch1 to Ch16)
 vv Expression = 00H to 7FH

Hold 1 (Damper Pedal)

Format

Byte 1	Byte 2	Byte 3
BnH	40H	vvH

Recognition
 n Voice Channel Number = 0H to FH (Ch1 to Ch16)
 vv Hold 1 = 00H to 7FH (00H to 3FH:OFF, 40H to 7FH:ON)

Send

n Voice Channel Number = 0H to FH (Ch1 to Ch16)
 vv Hold 1 = 00H,7FH(00H:OFF,7FH:ON)

Portamento ★

Format

Byte 1	Byte 2	Byte 3
BnH	41H	vvH

Recognition
 n Voice Channel Number = 0H to FH (Ch1 to Ch16)
 vv Portamento = 00H to 7FH (00H to 7FH:OFF, 7FH:ON)

Sostenuto

Format

Byte 1	Byte 2	Byte 3
BnH	42H	vvH

Recognition
 n Voice Channel Number = 0H to FH (Ch1 to Ch16)
 vv Sostenuto = 00H to 7FH (00H to 3FH:OFF, 40H to 7FH:ON)

Send

n Voice Channel Number = 0H to FH (Ch1 to Ch16)
 vv Sostenuto = 00H, 7FH (00H:OFF, 7FH:ON)

Soft

Format

Byte 1	Byte 2	Byte 3
BnH	43H	vvH

Recognition
 n Voice Channel Number = 0H to FH (Ch1 to Ch16)
 vv Soft = 00H to 7FH (00H to 3FH:OFF, 40H to 7FH:ON)

Send

n Voice Channel Number = 0H to FH (Ch1 to Ch16)
 vv Soft = 00H, 7FH (00H:OFF, 7FH:ON)

Resonance

Format

Byte 1	Byte 2	Byte 3
BnH	47H	vvH

n Voice Channel Number = 0H to FH (Ch1 to Ch16)
 vv Filter Resonance = 00H to 7FH

Release Time

Format

Byte 1	Byte 2	Byte 3
BnH	48H	vvH

n Voice Channel Number = 0H to FH (Ch1 to Ch16)
 vv AMP Release Time = 00H to 7FH

Attack Time

Format

Byte 1	Byte 2	Byte 3
BnH	49H	vvH

n Voice Channel Number = 0H to FH (Ch1 to Ch16)
 vv AMP Attack Time = 00H to 7FH

Brightness

Format

Byte 1	Byte 2	Byte 3
BnH	4AH	vvH

n Voice Channel Number = 0H to FH (Ch1 to Ch16)
 vv Filter Cutoff Frequency = 00H to 7FH

Portamento Control

Format

Byte 1	Byte 2	Byte 3
BnH	54H	kkH

n Voice Channel Number = 0H to FH (Ch1 to Ch16)
 kk Source Note Number = 00H to 7FH

Effect 1 Depth (Reverb Send Level)

Format

Byte 1	Byte 2	Byte 3
BnH	58H	vvH

n Voice Channel Number = 0H to FH (Ch1 to Ch16)
 vv Reverb Send Level = 00H to 7FH

Effect 3 Depth (Chorus Send Level)

Format

Byte 1	Byte 2	Byte 3
BnH	5DH	vvH

n Voice Channel Number = 0H to FH (Ch1 to Ch16)
 vv Chorus Send Level = 00H to 7FH

NRPN (Non-Registered Parameter Numbers)

Format

Byte 1	Byte 2	Byte 3
BnH	63H	pmH (MSB)
BnH	62H	plH (LSB)

n Voice Channel Number = 0H to FH (Ch1 to Ch16)
 pm MSB of NRPN
 pl LSB of NRPN

Recognition

- NRPN messages not defined by the instrument can also be received, but subsequent data entry values after undefined NRPN messages are ignored.
- After the NRPN MSB and LSB are received and the applicable control parameters settings are made, the value is set by receipt of the MSB of the subsequent data entry. The data entry LSB is ignored.

Vibrato Rate

NRPN MSB = 01H
 NRPN LSB = 08H
 Data Entry MSB = mmH
 mm Vibrato Rate = 00H to 40H to 7FH (-64 to 0 to +63)

Recognition

When the instrument receives this message, the preset Vibrato Rate value for the tone is changed to the Vibrato Rate value that corresponds to the data entry MSB of the received message. There is no change when the value of the data entry MSB is 40H(0).

Vibrato Depth

NRPN MSB = 01H
 NRPN LSB = 09H
 Data Entry MSB = mmH
 mm Vibrato Depth = 00H to 40H to 7FH (-64 to 0 to +63)

Recognition

When the instrument receives this message, the preset Vibrato Depth value for the tone is changed to the value that corresponds to the data entry MSB of the received message. There is no change when the value of the data entry MSB is 40H(0).

Vibrato Delay

NRPN MSB = 01H
 NRPN LSB = 0AH
 Data Entry MSB = mmH
 mm Vibrato Delay = 00H to 40H to 7FH (-64 to 0 to +63)

Recognition

When the instrument receives this message, the preset Vibrato Delay value for the tone is changed to the value that corresponds to the data entry MSB of the received message. There is no change when the value of the data entry MSB is 40H(0).

Filter Cut Off Frequency

NRPN MSB = 01H
NRPN LSB = 20H
Data Entry MSB = mmH

mm Filter Cut Off Frequency = 00H to 40H to 7FH (-64 to 0 to +63)

Recognition

When the instrument receives this message, the preset Filter Cut off Frequency value for the tone is changed to the value that corresponds to the data entry MSB of the received message. There is no change when the value of the data entry MSB is 40H(0).

Filter Resonance

NRPN MSB = 01H
NRPN LSB = 21H
Data Entry MSB = mmH

mm Resonance = 00H to 40H to 7FH (-64 to 0 to +63)

Recognition

When the instrument receives this message, the preset Filter Resonance value for the tone is changed to the value that corresponds to the data entry MSB of the received message. There is no change when the value of the data entry MSB is 40H(0).

Filter/AMP Envelope Attack Time

NRPN MSB = 01H
NRPN LSB = 63H
Data Entry MSB = mmH

mm Filter/AMP Envelope Attack Time = 00H to 40H to 7FH (-64 to 0 to +63)

Recognition

When the instrument receives this message, the preset Filter/AMP Envelope Attack Time value for the tone is changed to the value that corresponds to the data entry MSB of the received message. There is no change when the value of the data entry MSB is 40H(0).

Filter/AMP Envelope Decay Time

NRPN MSB = 01H
NRPN LSB = 64H
Data Entry MSB = mmH

mm Filter/AMP Envelope Decay Time = 00H to 40H to 7FH (-64 to 0 to +63)

Recognition

When the instrument receives this message, the preset Filter/AMP Envelope Decay Time value for the tone is changed to the value that corresponds to the data entry MSB of the received message. There is no change when the value of the data entry MSB is 40H(0).

Filter/AMP Envelope Release Time

NRPN MSB = 01H
NRPN LSB = 66H
Data Entry MSB = mmH

mm Filter/AMP Envelope Release Time = 00H to 40H to 7FH (-64 to 0 to +63)

Recognition

When the instrument receives this message, the preset Filter/AMP Envelope Release Time value for the tone is changed to the value that corresponds to the data entry MSB of the received message. There is no change when the value of the data entry MSB is 40H(0).

RPN (Registered Parameter Numbers)

Format

Byte 1	Byte 2	Byte 3
BnH	65H	qmH (MSB)
BnH	64H	qlH (LSB)

n Voice Channel Number = 0H to FH (Ch1 to Ch16)

qm MSB of RPN

ql LSB of RPN

Recognition

- RPN messages not defined by the instrument can also be received, but subsequent data entry values after undefined RPN messages are ignored.
- After the MSB and LSB of an RPN are received and the applicable control parameters settings are made, the value is set by receipt of the MSB of the subsequent data entry. The data entry LSB is ignored.

Send

An RPN is sent whenever an operation that changes the parameter assigned to the RPN is performed.

Pitch Bend Sensitivity ★

RPN MSB = 00H
RPN LSB = 00H
Data Entry MSB = mmH

mm Pitch Bend Sensitivity = 00H to 18H (0 to 24 semitones)

Recognition

The data entry LSB is always ignored.

Master Fine Tuning

RPN MSB = 00H
RPN LSB = 01H
Data Entry MSB = mmH
Data Entry LSB = llH

mm ll Master Fine Tuning = 00 00H to 40H 00H to 7FH 7FH (-100 to 0 to +99.99 cents)

Master Coarse Tuning

RPN MSB = 00H
RPN LSB = 02H
Data Entry MSB = mmH

mm Master Coarse Tuning = 28H to 40H to 58H (24 to 0 to +24 semitones)

Recognition

The data entry LSB is always ignored.

RPN Null

RPN MSB = 7FH
RPN LSB = 7FH

Recognition

Once an RPN Null is sent, all received data entry MSBs and LSBs are ignored until another RPN message other than RPN Null or an NRPN message is received.

Program Change

Format

Byte 1	Byte 2
ChH	ppH

pp Program Number = 00H to 7FH

Send

Program Change messages are sent when you select a tone on the instrument.

Pitch Bend Change ★

Format

Byte 1	Byte 2	Byte 3
EnH	llH	mmH

n Voice Channel Number = 0H to FH (Ch1 to Ch16)

ll Pitch Bend Change LSB = 00H to 7FH

mm Pitch Bend Change MSB = 00H to 7FH

Recognition

- The value llH mmH is 00H 00H at the lowest pitch, 00H 40H at mid-pitch, and 7FH 7FH at the highest pitch.
- You have to set both the LSB and MSB together to form a 14-bit value and make a Pitch Bend Change message recognized by the instrument.

Channel Mode Message

All Sound Off ★

Format

Byte 1	Byte 2	Byte 3
BnH	78H	00H

n Voice Channel Number = 0H to FH (Ch1 to Ch16)

Recognition

Receipt of this message immediately mutes all tones playing over the MIDI channels.

Reset All Controller ★

Format

Byte 1	Byte 2	Byte 3
BnH	79H	00H

n Voice Channel Number = 0H to FH (Ch1 to Ch16)

Recognition

Receipt of the Reset All Controller message causes the following controllers to be reset.

Controller Name	Reset Value
Modulation Wheel	vvH = 00H
Expression Controller	vwH = 7FH
Hold 1	vvH = 00H
Portamento	vvH = 00H
Sostenuto	vvH = 00H
Soft	vvH = 00H
NRPn	msb = 7FH, lsb = 7FH
RPN	msb = 7FH, lsb = 7FH
Pitch Bend Change	llH mmH = 00H 40H

All Note Off

Format

Byte 1	Byte 2	Byte 3
BnH	7BH	00H

n Voice Channel Number = 0H to FH (Ch1 to Ch16)

Recognition

Receipt of the All Note Off message mutes all tones being played by data received over the MIDI channels (note off). If Hold 1 or Sostenuto is turned on when the All Note Off message is received, notes are sustained in accordance with the corresponding pedal operation.

Send

This message is sent when the CONTROL button is pressed and when song memory playback is stopped.

Omni Mode Off ★

Format

Byte 1	Byte 2	Byte 3
BnH	7CH	00H

n Voice Channel Number = 0H to FH (Ch1 to Ch16)

Recognition

Receipt of an Omni Mode On message does not turn on the instrument Omni Mode. Receipt of an Omni Mode On message is treated as an All Note Off message.

Omni Mode On ★

Format

Byte 1	Byte 2	Byte 3
BnH	7DH	00H

n Voice Channel Number = 0H to FH (Ch1 to Ch16)

Recognition

Receipt of an Omni Mode On message does not turn on the instrument Omni Mode. Receipt of an Omni Mode On message is treated as an All Note Off message.

Mono Mode On ★

Format

Byte 1	Byte 2	Byte 3
BnH	7EH	vvH

n Voice Channel Number = 0H to FH (Ch1 to Ch16)
 vv Number of Mono Mode Channels = 00H to 10H

Recognition

Receipt of a Mono Mode On message does not turn on the instrument Mono Mode. Receipt of a Mono Mode On message is treated as an All Sound Off message and All Note Off message.

Poly Mode On ★

Format

Byte 1	Byte 2	Byte 3
BnH	7FH	00H

n Voice Channel Number = 0H to FH (Ch1 to Ch16)

Receive

Receipt of a Poly Mode On message by the instrument sets Channel n to Mode 3 and is processed as if an All Sound Off message and All Note Off message were received.

Universal System Exclusive Message

GM System On ★

Format

F0H 7EH 7FH 09H 01H F7H

Send

This message cannot be sent.

Reverb Type

Format

F0 7F 7F 04 05 01 01 01 01 pp vv F7

Reverb Type

pp = 0;
vv = 0: Room1
= 1: Room2
= 2: Room3
= 3: HallI
= 4: Hall2
= 6: Delay
= 7: Pan Delay
= 8: Stage

Send

This message is sent when a reverb switch operation or other reverb type setting operation is performed.

Receive

Receipt of this message sets the reverb type.

Chorus Type

Format

F0 7F 7F 04 05 01 01 01 02 pp vv F7

Chorus Type

pp = 0;
vv = 0: Chorus1
= 1: Chorus2
= 2: Chorus3
= 3: Chorus4
= 4: F-backChorus
= 5: Flanger
= 6: Short Delay
= 7: ShortDelayFB

Send

This message is sent when a chorus switch operation or other chorus type setting operation is performed.

Receive

Receipt of this message sets the chorus type.

Function ...	Transmitted	Recognized	Remarks
Basic Channel Default Changed	1 1-16	1-16 1-16	
Mode Default Messages Altered	Mode 3 X *****	Mode 3 X *****	
Note Number True voice	21-108 *****	0-127 0-127	
Velocity Note ON Note OFF	0 9nH V = 1-127 X 8nH V = 64	0 9nH V = 1-127 X 9nH V = 0,8nH V=**	** = no relation ** = sin relación
After Touch Key's Ch's	X X	X X	
Pitch Bender	X	O	
Control Change 0,32 1 5 6.38 7 10 11 64 65 66 67 71	O X X O*1 X X X X X O O O X	O O O O*1 O O O O O O O O O	Bank select Modulation Portamento Time Data entry Volume Pan Expression Dampner Portamento Sostenuto Soft Resonance

72 73 74 84 91 93 98,99 100,101 120 121	X X X X O O X O X X	O O O O O O O O O O	Release Time Attack Time Portamento Control Brightness Reverb send Chorus send RPN LSB, MSB All sound off Reset all controller
Program Change : True #	O *****	O *2	
System Exclusive	O	O	
System Common : Song Pos : Song Sel : Tune	X X X	X X X	
System Real Time : Clock : Commands	X X	X X	
Aux Messages : Local ON/OFF : All notes OFF : Active Sense : Reset	X O X X	X O O X	
Remarks	<p>*1: Fine tune and coarse tune send/receive, and RPN Null, pitch bend sense, vibrato rate, vibrato depth, vibrato delay, Filter cut off frequency, Filter resonance, Filter/AMP envelope attack time, Filter/AMP envelope decay time and Filter/AMP envelope release time receives</p> <p>*1: Envío/recepción de afinación fina y de afinación gruesa, y RPN nulo, velocidad de vibrato, profundidad de vibrato, retardo de vibrato, frecuencia de corte del filtro, resonancia de filtro, recepción de tiempo de ataque de envolvente de Filtro/AMP, de tiempo de extinción de envolvente de Filtro/AMP, y de tiempo de liberación de envolvente de Filtro/AMP.</p> <p>*2: See the program numbers' table on page E-34.</p> <p>*2: Vea la Tabla de números de programa de la página S-34.</p>		

Mode 1 : OMNI ON, POLY
Mode 3 : OMNI OFF, POLY

Mode 2 : OMNI ON, MONO
Mode 4 : OMNI OFF, MONO

O : Yes
X : No



This recycle mark indicates that the packaging conforms to the environmental protection legislation in Germany.

Esta marca de reciclaje indica que el empaquetado conforma a la legislación de protección ambiental en Alemania.

CASIO®

CASIO COMPUTER CO.,LTD.

6-2, Hon-machi 1-chome
Shibuya-ku, Tokyo 151-8543, Japan

 MA0703-C Printed in China
AP45ES1C

Free Manuals Download Website

<http://myh66.com>

<http://usermanuals.us>

<http://www.somanuals.com>

<http://www.4manuals.cc>

<http://www.manual-lib.com>

<http://www.404manual.com>

<http://www.luxmanual.com>

<http://aubethermostatmanual.com>

Golf course search by state

<http://golfingnear.com>

Email search by domain

<http://emailbydomain.com>

Auto manuals search

<http://auto.somanuals.com>

TV manuals search

<http://tv.somanuals.com>