

# CELVIANO

# AP-420

ES

English

Español

## USER'S GUIDE

## GUÍA DEL USUARIO

Please keep all information for future reference.  
Guarde toda información para tener como referencia futura.

### **Safety Precautions**

Before trying to use the piano, be sure to read the separate "Safety Precautions".

### **Precauciones de seguridad**

Antes de intentar usar el piano, asegúrese de leer las "Precauciones de seguridad" separadas.

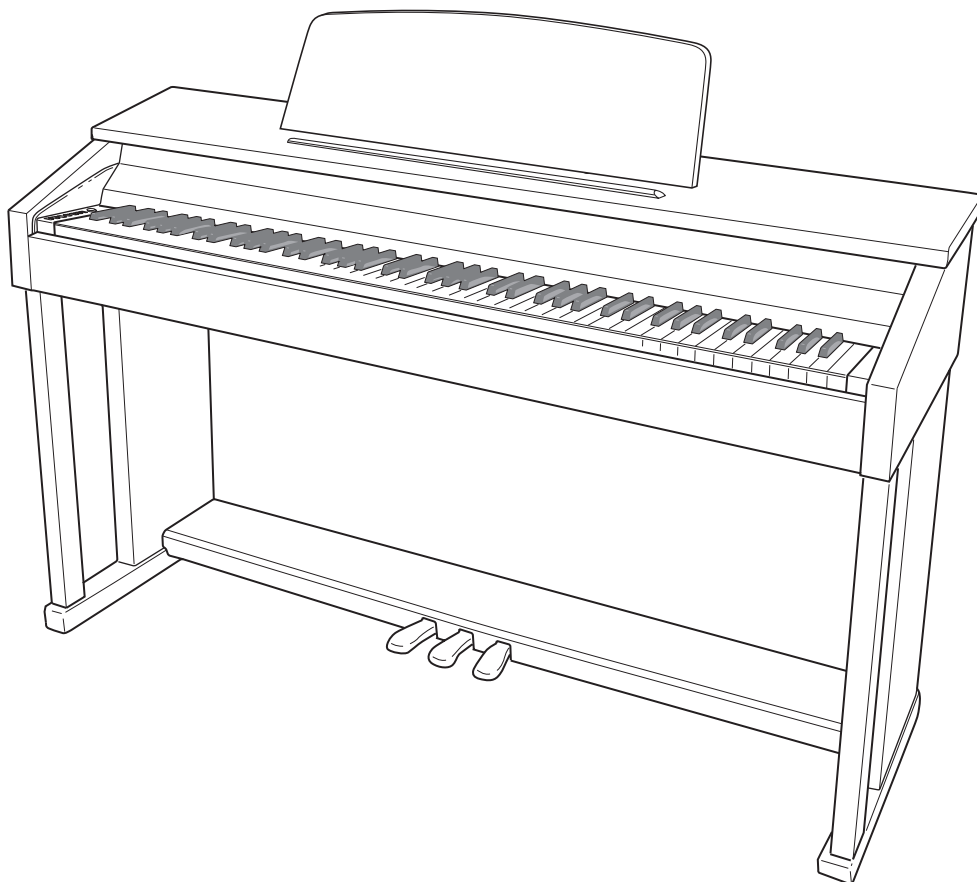

AP420ES1A

**CASIO**

## IMPORTANT SAFETY INSTRUCTIONS

1. Read these instructions.
  2. Keep these instructions.
  3. Heed all warnings.
  4. Follow all instructions.
  5. Do not use this apparatus near water.
  6. Clean only with dry cloth.
  7. Do not block any ventilation openings. Install in accordance with the manufacturer's instructions.
  8. Do not install near any heat sources such as radiators, heat registers, stoves, or other apparatus (including amplifiers) that produce heat.
  9. Do not defeat the safety purpose of the polarized or grounding-type plug. A polarized plug has two blades with one wider than the other. A grounding type plug has two blades and a third grounding prong. The wide blade or the third prong are provided for your safety. If the provided plug does not fit into your outlet, consult an electrician for replacement of the obsolete outlet.
  10. Protect the power cord from being walked on or pinched particularly at plugs, convenience receptacles, and the point where they exit from the apparatus.
  11. Only use attachments/accessories specified by the manufacturer.
  12. Use only with the cart, stand, tripod, bracket, or table specified by the manufacturer, or sold with the apparatus. When a cart is used, use caution when moving the cart/apparatus combination to avoid injury from tip-over.
- 
13. Unplug this apparatus during lightning storms or when unused for long periods of time.
  14. Refer all servicing to qualified service personnel. Servicing is required when the apparatus has been damaged in any way, such as power-supply cord or plug is damaged, liquid has been spilled or objects have fallen into the apparatus, the apparatus has been exposed to rain or moisture, does not operate normally, or has been dropped.

The apparatus shall not be exposed to dripping or splashing and that no objects filled with liquids, such as vases, shall be placed on the apparatus.

The power indicator being unlit does not mean the apparatus is completely disconnected from the MAINS. When you need to have the apparatus completely disconnected from the MAINS, you must unplug the power cord. For that purpose, locate the apparatus in a way that secures easy access to the power cord.

## NOTICE

This equipment has been tested and found to comply with the limits for a Class B digital device, pursuant to Part 15 of the FCC Rules. These limits are designed to provide reasonable protection against harmful interference in a residential installation. This equipment generates, uses and can radiate radio frequency energy and, if not installed and used in accordance with the instructions, may cause harmful interference to radio communications. However, there is no guarantee that interference will not occur in a particular installation. If this equipment does cause harmful interference to radio or television reception, which can be determined by turning the equipment off and on, the user is encouraged to try to correct the interference by one or more of the following measures:

- Reorient or relocate the receiving antenna.
- Increase the separation between the equipment and receiver.
- Connect the equipment into an outlet on a circuit different from that to which the receiver is connected.
- Consult the dealer or an experienced radio/TV technician for help.

## FCC WARNING

Changes or modifications not expressly approved by the party responsible for compliance could void the user's authority to operate the equipment.

## Declaration of Conformity

Model Number: AP-420  
Trade Name: CASIO COMPUTER CO., LTD.  
Responsible party: CASIO AMERICA, INC.  
Address: 570 MT. PLEASANT AVENUE, DOVER, NEW JERSEY 07801  
Telephone number: 973-361-5400

This device complies with Part 15 of the FCC Rules, Operation is subject to the following two conditions:

(1) This device may not cause harmful interference, and (2) this device must accept any interference received, including interference that may cause undesired operation.

## Important!

Please note the following important information before using this product.

- Before using the AD-E24250LW Adaptor to power the unit, be sure to check the AC Adaptor for any damage first. Carefully check the power cord for breakage, cuts, exposed wire and other serious damage. Never let children use an AC adaptor that is seriously damaged.
- The product is not intended for children under 3 years.
- Use only CASIO AD-E24250LW adaptor.
- The AC adaptor is not a toy.
- Be sure to disconnect the AC adaptor before cleaning the product.



This mark applies in EU countries only.



Manufacturer:  
CASIO COMPUTER CO., LTD.  
6-2, Hon-machi 1-chome, Shibuya-ku, Tokyo 151-8543, Japan  
Responsible within the European Union:  
CASIO EUROPE GmbH  
Casio-Platz 1, 22848 Norderstedt, Germany

# Contents

## **Getting Ready.....E-32**

Assembling the Stand .....	E-32	Connecting Headphones.....	E-36
To connect the cables .....	E-34	Connecting Audio Equipment or an Amplifier .....	E-37
To install the music stand and headphones hook....	E-35	Bundled and Optional Accessories .....	E-37
Power Outlet.....	E-36		

## **General Guide ..... E-2**

FUNCTION Button .....	E-3
Saving Settings and Using Operation Lock .....	E-3

## **Playing with Different Tones ..... E-4**

Selecting and Playing a Tone .....	E-4
To adjust the brilliance of a tone .....	E-5
Layering Two Tones .....	E-6
Using Effects.....	E-7
Using the Digital Piano's Pedals .....	E-7
Using the Metronome .....	E-8
Playing a Piano Duet .....	E-9

## **Playing Back Built-in Songs..... E-10**

Playing Back All of the Built-in Songs.....	E-10
Playing Back a Specific Music Library Song.....	E-10
Practicing with a Music Library Song.....	E-11

## **Recording and Play Back..... E-12**

Tracks .....	E-12
To record to a specific track of a song .....	E-13
To record to one track of a song while listening to the playback of the other track.....	E-14
Playing Back from Digital Piano Memory.....	E-14
Deleting Recorded Data .....	E-15

## **Configuring Settings with the Keyboard ..... E-16**

To configure settings with the keyboard .....	E-16
Keyboard Keys Used for Configuring Settings .....	E-17
Parameter List .....	E-18
Reverb.....	E-18
Chorus.....	E-18
Tone selection .....	E-18
Brilliance (BRILLIANCE) .....	E-18
Layer balance.....	E-18
Tempo (TEMPO).....	E-18
Song select (SONG SELECT).....	E-18
Song volume (SONG VOLUME) .....	E-18
Metronome volume (METRONOME VOLUME) ....	E-18
Metronome beat (METRONOME BEAT).....	E-18
Keyboard key (Transpose).....	E-19
Keyboard tuning (Tuning).....	E-19
Octave shift .....	E-19
Temperament (TEMPERAMENT) .....	E-19
Temperament select (TEMPERAMENT SELECT) .....	E-19
Temperament Base note (BASE NOTE).....	E-19

Touch response (TOUCH RESPONSE).....	E-19
USB device mode (USB DEVICE MODE) .....	E-20
Send channel.....	E-20
Local control .....	E-20
Card menu (CARD MENU).....	E-20
Operation tone .....	E-20
Back up.....	E-20
Operation lock.....	E-20

## **Using a Memory Card..... E-21**

Loading and Removing a Memory Card .....	E-22
Formatting a Memory Card .....	E-22
Saving a Recorded Song to a Memory Card .....	E-23
Loading Song Data from a Memory Card into Digital Piano Memory .....	E-23
Deleting Memory Card Data.....	E-24
Simple Play Back of a Song on a Memory Card .....	E-25
Saving Data to Digital Piano Memory (Internal Area) Instead of a Memory Card.....	E-25
Error Indicators.....	E-26

## **Connecting to a Computer..... E-28**

Minimum Computer System Requirements .....	E-28
Connecting the Digital Piano to Your Computer .....	E-28
Using MIDI .....	E-29
Transferring Song Data with a Computer.....	E-29

## **Reference..... E-38**

Troubleshooting .....	E-38
Product Specifications.....	E-39
Operating Precautions .....	E-40

## **Appendix..... A-1**

Tone List .....	A-1
Song List .....	A-1

## **MIDI Implementation Chart**

Company and product names used in this manual may be registered trademarks of others.

# General Guide

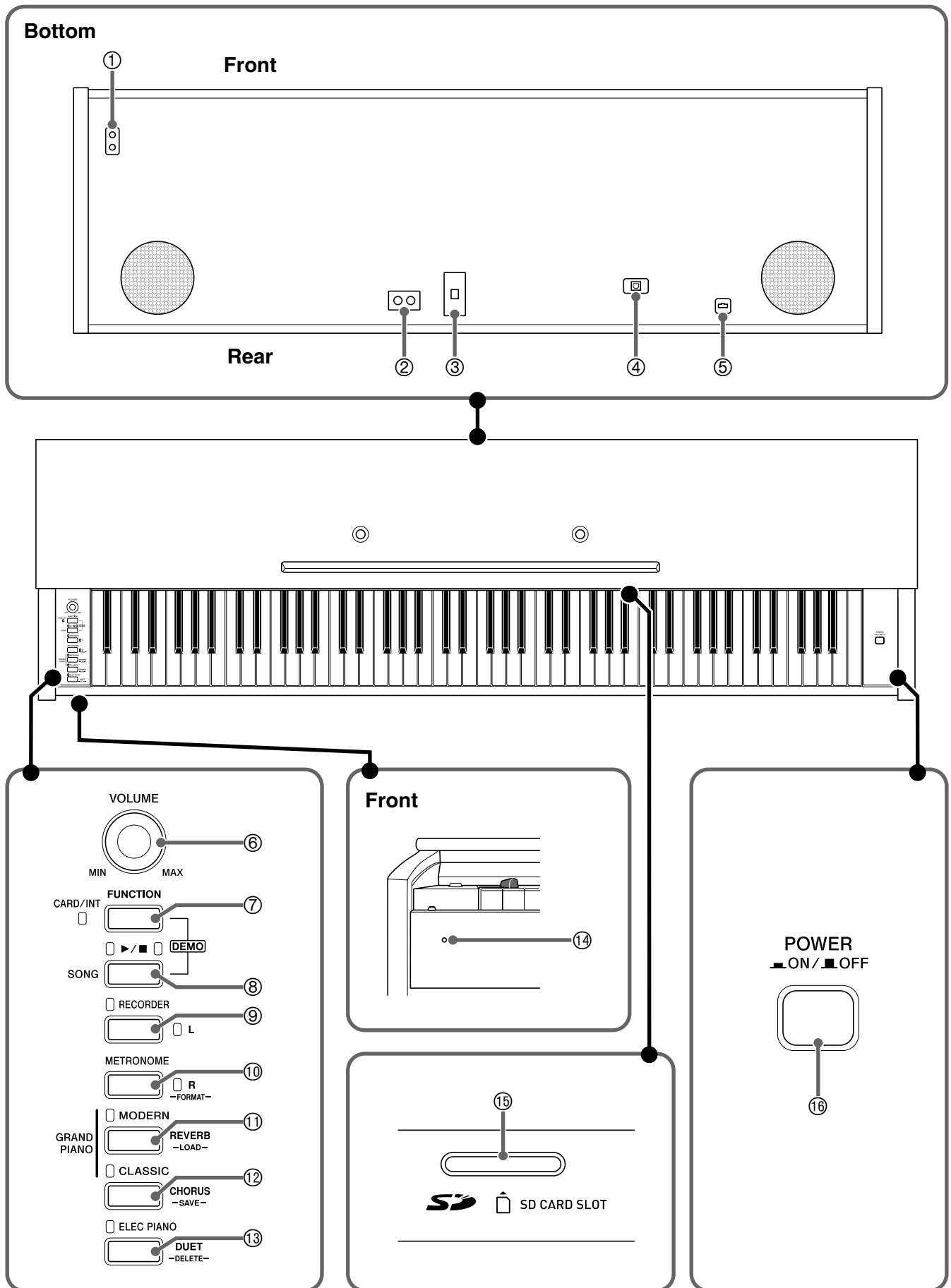

**⚠ CAUTION**

- Make sure that the cover is fully open whenever you are playing on the keyboard. A partially open cover can suddenly close unexpectedly and pinch your fingers.

**📌 NOTE**

- The names shown here are always indicated in bold when they appear within the text of this manual.

- |                                    |                                       |
|------------------------------------|---------------------------------------|
| ① <b>PHONES</b> jacks              | ⑨ <b>RECORDER (L)</b> button          |
| ② <b>LINE OUT R, L/MONO</b> jacks  | ⑩ <b>METRONOME (R)</b> button         |
| ③ DC 24V terminal                  | ⑪ <b>GRAND PIANO (MODERN)</b> button  |
| ④ <b>USB</b> port                  | ⑫ <b>GRAND PIANO (CLASSIC)</b> button |
| ⑤ Pedal connector                  | ⑬ <b>ELEC PIANO</b> button            |
| ⑥ <b>VOLUME</b> controller         | ⑭ Power lamp                          |
| ⑦ <b>FUNCTION, CARD/INT</b> button | ⑮ <b>SD CARD SLOT</b>                 |
| ⑧ <b>SONG</b> ▶/■ button           | ⑯ <b>POWER</b> button                 |

## FUNCTION Button

The **FUNCTION** button is used when configuring a variety of different digital piano settings. The following are **FUNCTION** button basics.

- To change a setting, hold down the **FUNCTION** button as you press the keyboard key that is assigned the setting you want to select.

*Example: "To select a tone" on page E-4*

**📌 NOTE**

- For details about operations and settings, see "Configuring Settings with the Keyboard" on page E-16.



## Saving Settings and Using Operation Lock

Your digital piano lets you save its current settings and lock its buttons to protect against operation errors. For details, see "Parameter List" on pages E-18 - E-20.

# Playing with Different Tones

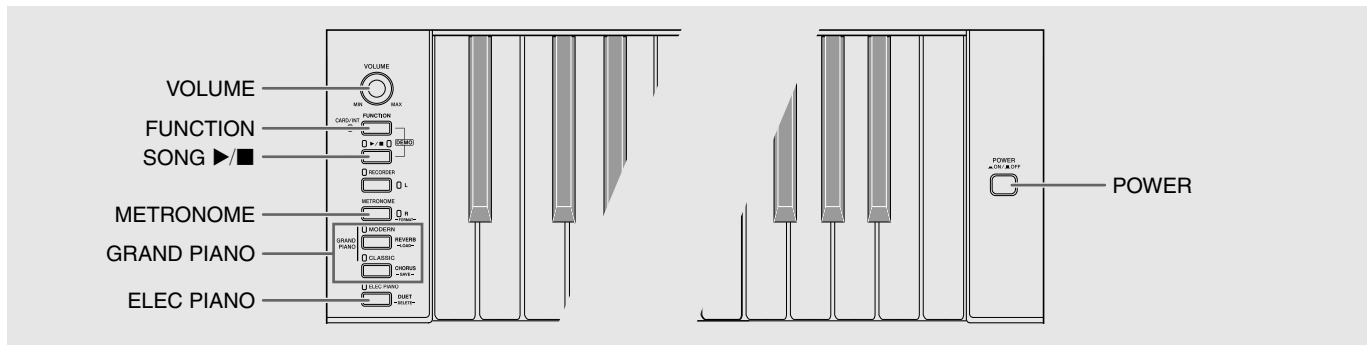

## Selecting and Playing a Tone

The piano comes with 16 built-in tones.

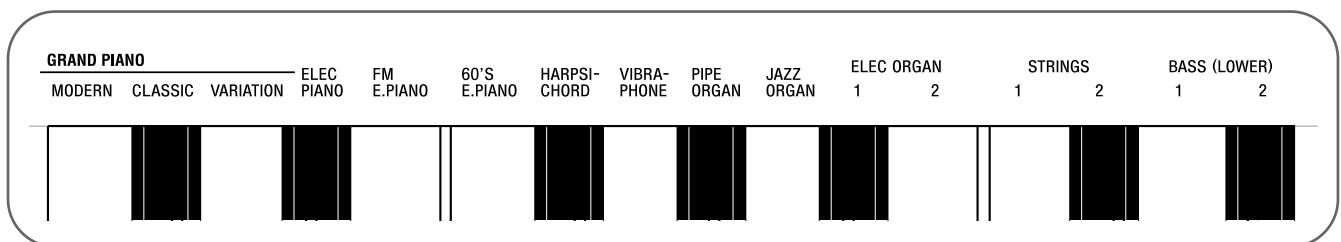

- The names of the tones are marked above the keyboard keys to which they are assigned.

### To select a tone

1. Press the **POWER** button.

#### **IMPORTANT!**

- When you turn on the digital piano, it performs a power up operation in order to initialize its system. During system initialization the tone button lamps cycle on and off in the sequence for about seven seconds to let you know that system initialization is in progress.

2. Select the tone you want.

- To select GRAND PIANO (MODERN or CLASSIC) or ELEC PIANO
  - Press one of the **GRAND PIANO** buttons (MODERN or CLASSIC) or the **ELEC PIANO** button to select the one you want.
- To select one of the other tones
  - While holding down the **FUNCTION** button, press the keyboard key that corresponds to the tone you want to select.

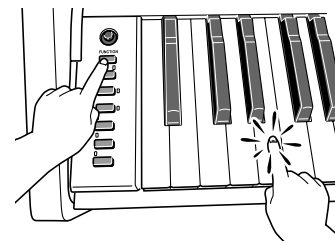
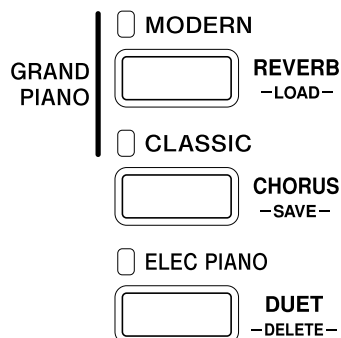

- The button lamp of the selected tone will light.

**3.** Use the **VOLUME** controller to adjust the volume.

**NOTE**

- **GRAND PIANO** tones (**MODERN**, **CLASSIC**)  
Your digital piano has a total of 16 built-in tones. The **MODERN** and **CLASSIC** tones are stereo sampled tones that can be selected using the **GRAND PIANO** buttons. Try using the **GRAND PIANO** tones to familiarize yourself with their distinctive sounds and characteristics.

Tone Name	Characteristics
MODERN	This tone provides a bright grand piano sound. The volume and timbre of this tone is quick to respond to different keyboard pressures, and it has relatively strong reverb. This tone is a good choice for dynamic and lively performances.
CLASSIC	This is a natural piano tone that closely resembles the sound of an acoustic grand piano. Reverb and other effects are kept to a minimum in order to enhance the impact of piano pedals operations (acoustic resonance), for musically delicate expressions. This tone is a good choice for lesson and practice sessions.

- The **GRAND PIANO** tone (**VARIATION**) is best for playing along with an accompaniment.

**Bass Tones (BASS 1, BASS 2)**

Selecting either of the two **BASS (LOWER)** tones (1 or 2) in step 2 of the above procedure will assign the selected bass tone to the low range (left side) of the keyboard. The high range (right side) will be assigned the tone that was selected when you pressed the **BASS 1** or **BASS 2** key.

- **BASS 1** and **BASS 2** let you effectively split the keyboard between two different tones.

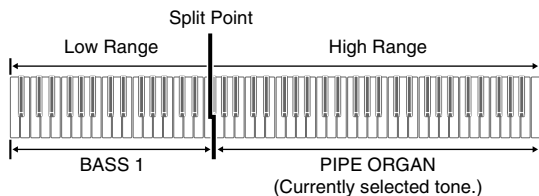

**NOTE**

- To return the keyboard to a single tone, select any tone other than **BASS 1** or **BASS 2**.
- You cannot select **BASS 1** or **BASS 2** when recording to Track 2.

**To adjust the brilliance of a tone**

1. While holding down the **FUNCTION** button, use the **BRILLIANCE** keys to specify a brilliance value in the range of -3 to 0 to 3.

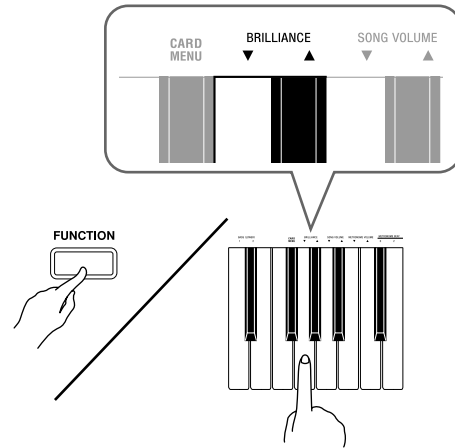

For this type of sound:	Press this keyboard key:
Mellower and softer	▼
Brighter and harder	▲

**NOTE**

- To return a tone to its initial default setting "0", press ▼ and ▲ at the same time.

## Layering Two Tones

Use the following procedure to layer two tones, so they sound at the same time.

When specifying two tones for layering, first tone you select will be the main tone, while the second tone will be the layered tone.

1. While holding down the **FUNCTION** button, hold down the keyboard key for the main tone as you press the keyboard key for the layered tone.

*Example:* To layer HARPISCHORD and STRINGS 1

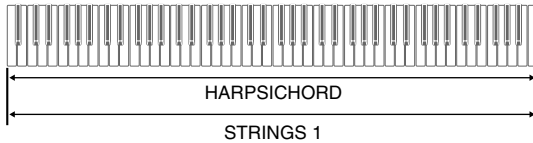
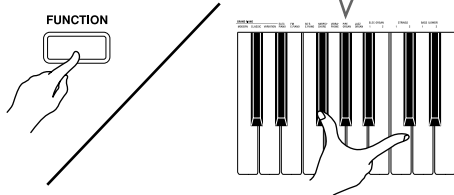
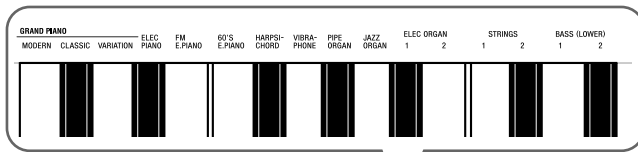

2. To unlayer the keyboard, select another tone by pressing the **GRAND PIANO** button or by using the procedure under “Selecting and Playing a Tone” (page E-4).

### NOTE

- You also can layer piano tones by holding down one of the **GRAND PIANO** buttons (**MODERN** or **CLASSIC**) as you press the **ELEC PIANO** button.
- You cannot layer the **BASS 1** or **BASS 2** tone with another tone.
- You cannot perform the layer operation when recording to Track 2.

## To adjust the volume balance between two layered tones

1. While holding down the **FUNCTION** button, use the keyboard keys shown below to adjust the volume of the layered tones.

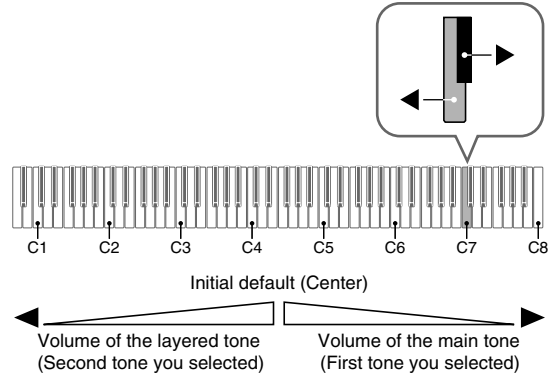

- To return the volume setting to its initial default, hold down the **FUNCTION** button and press both of the keys at the same time.



## Using Effects

Reverb : Makes your notes resonate.  
 Chorus : Adds more breadth to your notes.

### To turn reverb on and off

1. While holding down the **FUNCTION** button, press the **MODERN** button to toggle reverb on (lamp lit) and off (lamp unlit).

### To turn chorus on and off

1. While holding down the **FUNCTION** button, press the **CLASSIC** button to toggle chorus on (lamp lit) and off (lamp unlit).

### To configure reverb and chorus effect settings

1. While holding down the **FUNCTION** button, press one of the Reverb or Chorus keyboard keys.

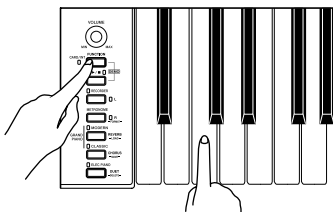
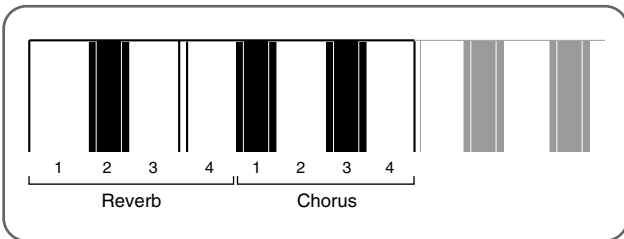

Example: Selecting Reverb 4

- Reverb Value

To do this:	Select this setting:
Turn on reverb	1: Room 2: Small Hall 3: Large Hall 4: Stadium

- Chorus Value

To do this:	Select this setting:
Turn on chorus	1: Light Chorus 2: Medium Chorus 3: Deep Chorus 4: Flanger (Whooshing effect)

## About DSP

DSP makes it possible to digitally produce complex acoustic effects. The DSP is assigned to each tone whenever you turn on digital piano power.

## Using the Digital Piano's Pedals

Your digital piano comes equipped with three pedals: damper, soft, and sostenuto

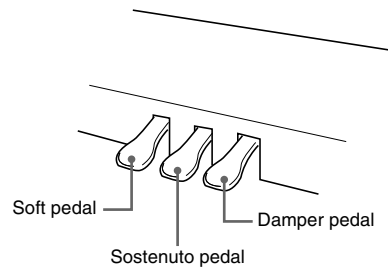

### Pedal Functions

#### ● Damper Pedal

Pressing the damper pedal while playing will cause the notes you play to reverberate for a very long time.

- When a GRAND PIANO tone (MODERN, CLASSIC, VARIATION) is selected as the tone, pressing this pedal will cause notes to reverberate (with acoustic resonance) just like the damper pedal on an acoustic grand piano. Half-pedal operation (pressing the pedal part way) is also supported.

#### ● Soft Pedal

Pressing this pedal while playing suppresses notes played on the keyboard after the pedal was pressed, and makes them sound softer.

#### ● Sostenuto Pedal

Only the notes of the keys that are depressed when this pedal is pressed are sustained until the pedal is released.

## Using the Metronome

### 1. Press the **METRONOME** button.

- This starts the metronome.
- The lamp above the **SONG** ▶/■ button flash in time with the metronome beat.

### 2. To change the beat, hold down the **FUNCTION** button as you press one of the **METRONOME BEAT** keys to select a beat setting.

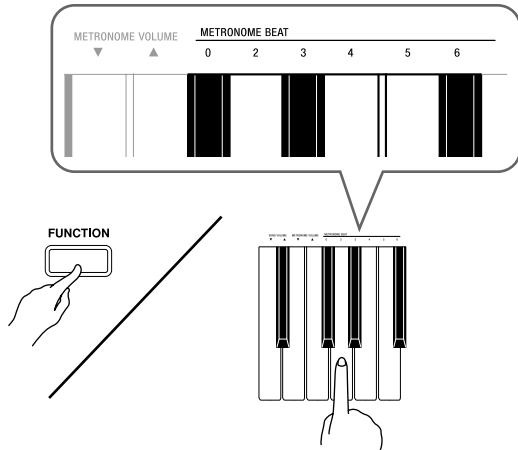

- You can specify beats per measure value of 0, 2, 3, 4, 5, or 6. Specifying 0 as the setting plays a straight click, without any chime. This setting lets you practice with a steady beat.

### 3. While holding down the **FUNCTION** button, use the **TEMPO** keys to specify a tempo value in the range of 20 to 255 beats per minute.

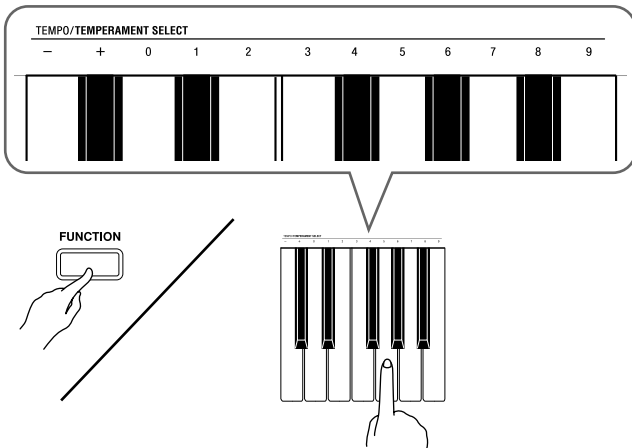

- Each press of the + or – key raises or lowers the tempo value by 1.
- You can use the value input keys (0 to 9) to enter a specific three-digit. Be sure to input all three digits.

*Example:* To enter “96”, press keys 0, 9, 6.

### 4. Press the **METRONOME** button or **SONG** ▶/■ button to turn off the metronome.

#### NOTE

- To return the tempo setting to the default tempo of the currently selected Music Library tune, press the + and – keys at the same time in step 3. Pressing + and – while recording will return the tempo value to 120.

## To adjust the metronome volume

#### NOTE

- You can perform the following procedure at any time, regardless of whether or not the metronome is sounding.

### 1. While holding down the **FUNCTION** button, use the **METRONOME VOLUME** keys to specify a volume value in the range of 0 to 42.

- For details about using the keyboard keys for settings, see “Keyboard Keys Used for Configuring Settings” on page E-17.
- Each press of the ▼ or ▲ key raises or lowers the metronome volume value by 1.

#### NOTE

- To return to the initial default setting, press ▼ and ▲ at the same time.

## Playing a Piano Duet

You can use the Duet Mode to split the piano's keyboard in the center so two people can play a duet.

### Keyboard

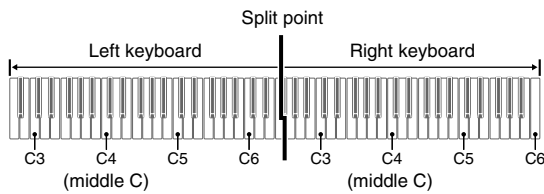

The left and right side keyboards have virtually the same range. The left pedal operates as the left side damper pedal, while the right pedal is the right side damper pedal.

### Pedals

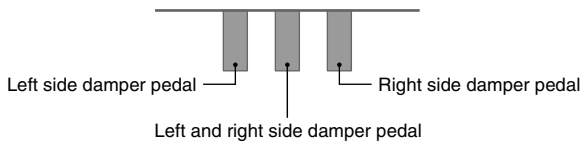

The Duet Mode is the perfect way to conduct lessons, with the teacher playing on the left side as the student playing the same song on the right side.

### NOTE

- Only the damper pedal for the right side keyboard supports half-pedal operations.

## 1. Select the piano tone you want to use for the duet.

*Example:* GRAND PIANO (MODERN)

## 2. While holding down the **FUNCTION** button, press the **ELEC PIANO** button to toggle duet on (lamp lit) and off (lamp unlit).

### IMPORTANT!

- You cannot use the Duet Mode while recording ([page E-12](#)).

## Changing the Octaves of the duet keyboards

You can change the ranges of the left and right keyboards in octave units from their initial default settings. This comes in handy, for example, if the initial default range is not enough when one person is playing the left hand part and another person is playing the right hand part.

## 1. While holding down the **FUNCTION** and **ELEC PIANO** buttons, press the keyboard C key that you want located at C4 (middle C) of the left keyboard.

- This will sound the note assigned to C4 and change the octave of the left keyboard.

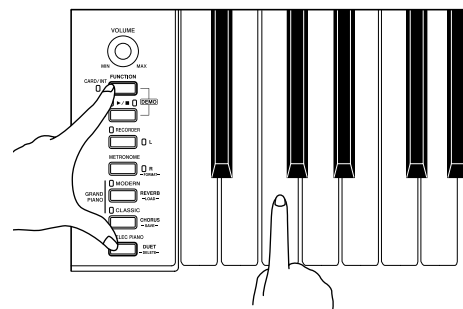

*Example:* Press the keyboard key of the leftmost C (C4) will assign the range shown below.

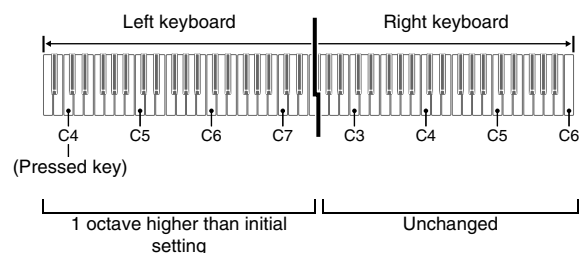

## 2. While holding down the **FUNCTION** and **ELEC PIANO** buttons, press the keyboard C key that you want located at C4 (middle C) of the right keyboard.

- This will sound the note assigned to C4 and change the octave of the right keyboard.

### NOTE

- You can return the keyboards to their initial default ranges by exiting and then re-entering the Duet Mode.

# Playing Back Built-in Songs

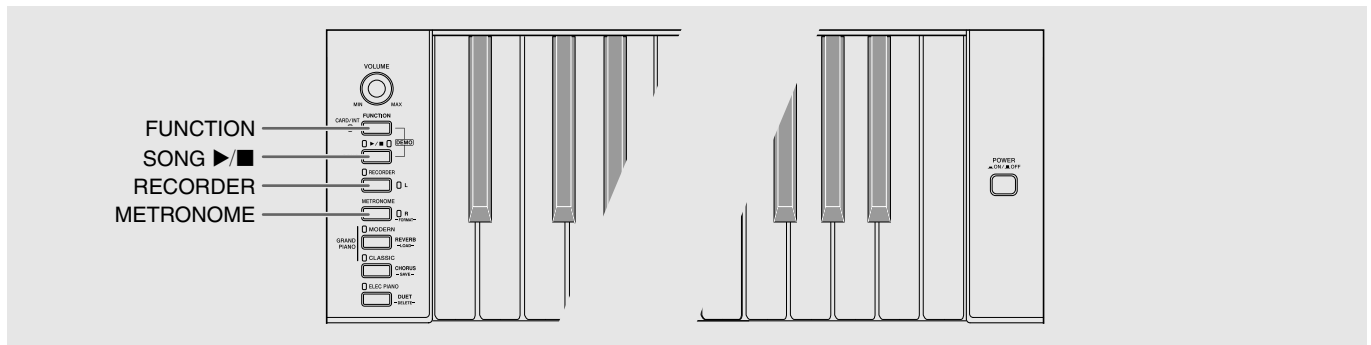

Your digital piano comes with a Music Library of 60 built-in tunes. You can play all 60 tunes in sequence, from beginning to end.

## Playing Back All of the Built-in Songs

1. While holding down the **FUNCTION** button, press the **SONG** ►/■ button.
  - This will start repeat demo playback of the built-in songs in sequence, from 01 through 60.
  - You can play along with a song on the keyboard as it is playing. The tone assigned to the keyboard is the one that is preset for the song that is playing.
  - You can select a specific song during demo playback. For details, see step 2 under “Playing Back a Specific Music Library Song”.
2. Press the **SONG** ►/■ button again to stop built-in song play.

### NOTE

- The tune selection and playback stop operations described above are the only operations that are possible during demo tune play.

## Playing Back a Specific Music Library Song

The Music Library includes both built-in songs (01 to 60), plus one song (61) that have been saved to digital piano memory from a computer\*. You can use the procedure below to select one of these songs and play it back.

\* You can download music data from the Internet and then transfer it from your computer to digital piano memory. See “Transferring Song Data with a Computer” on page E-29 for more information.

1. Find the song number of the song you want to play in the song list on page A-1.
2. To change to another song, hold down the **FUNCTION** button as you use the **SONG SELECT** keys to specify a song number.

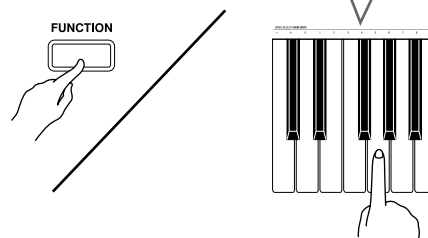
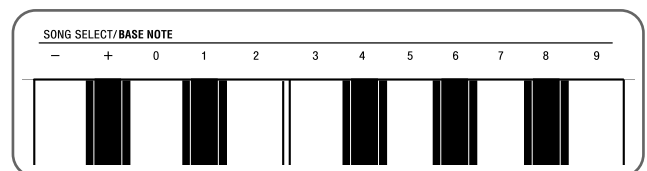

- Each press of the + or – key raises or lowers the song number by 1.
- You can use the value input keys (0 to 9) to enter a specific two-digit song number. Be sure to input both digits.

*Example:* To select song 08, enter 0 and then 8.

3. Press the **SONG** ►/■ button.
  - This starts the playback of the song.

#### 4. To stop playback, press the **SONG** ►/■ button again.

- Playback will stop automatically when the end of the song is reached.

#### NOTE

- Pressing the + and – keys at the same time will select song number 01.
- You also can adjust the playback tempo and volume of the song. See “Configuring Settings with the Keyboard” on page E-16 for more information.

## Practicing with a Music Library Song

You can turn off the left hand part or right hand part of a song and play along on the piano.

#### NOTE

- The Music Library includes a number of duets. While a duet is selected, you can turn off the first piano <Primo> or second piano <Secondo> tone and play along with the song.

#### PREPARATION

- Select the song you want to practice and adjust the tempo. See “Configuring Settings with the Keyboard” on page E-16.
- A number of tunes have tempo changes part way through in order to produce specific musical effects.

#### 1. While holding down the **FUNCTION** button, press the **RECORDER (L)** button or **METRONOME (R)** button to select the part you want to turn off.

- Pressing a button toggles its part on (button lamp on) and off (button lamp off).

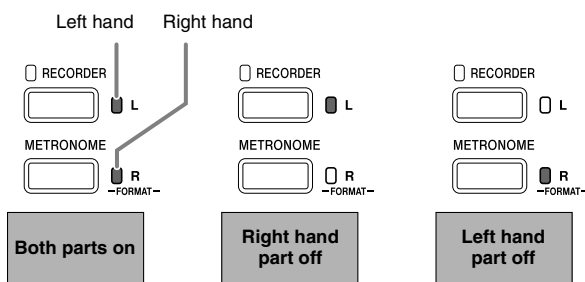

#### 2. Press the **SONG** ►/■ button.

- This starts playback, without the part you turned off in step 1.

#### 3. Play the missing part on the keyboard.

#### 4. To stop playback, press the **SONG** ►/■ button again.

# Recording and Play Back

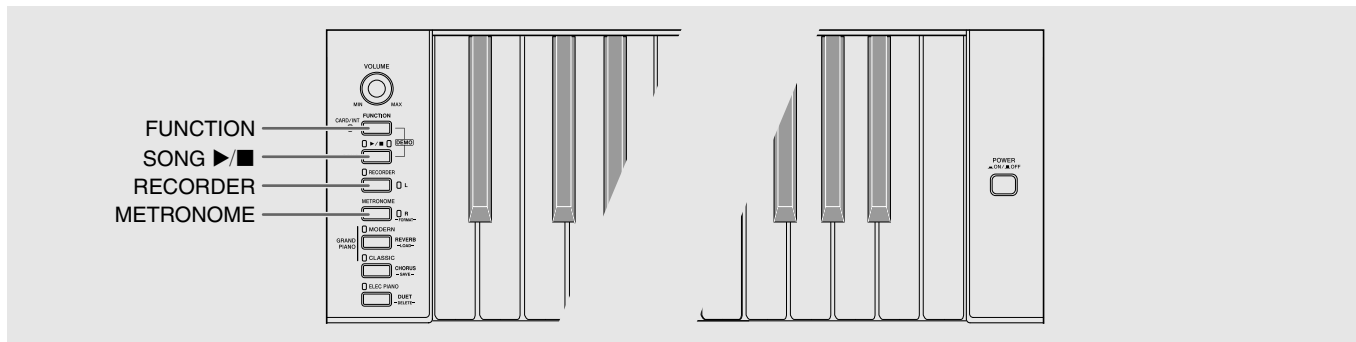

You can store the notes you play in digital piano memory for later playback.

## Tracks

A track is a container of recorded data, and a song consists of two tracks: Track 1 and Track 2. You can record each track separately and then combine them so they play back together as a single song.

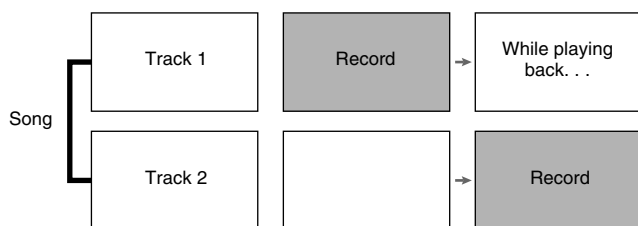

## Memory Capacity

- You can record approximately 5,000 notes in digital piano memory.
- The **RECORDER** button lamp will flash at high speed when memory runs low.
- Recording stops automatically if the number of notes in memory exceeds the maximum.

## Recorded Data

- Keyboard play
- Tone used
- Pedal operations
- Reverb and chorus settings (Track 1 only)
- Tempo setting (Track 1 only)
- Layer setting (Track 1 only)
- Split setting (Track 1 only)
- Temperament and base note settings (Track 1 only)
- Octave shift setting (Track 1 only)

## Recording Data Storage

- Starting a new recording deletes any data that was previously recorded in memory.
- Should power fail during recording, all of the data in the track you are recording will be deleted.

### IMPORTANT!

- CASIO COMPUTER CO., LTD. takes no responsibility for any damages, lost profits, or claims by third parties arising from the deletion of recorded data due to malfunction, repair, or for any other reason.

## Using the RECORDER Button

Each press of the **RECORDER** button cycles through the recording options in the sequence shown below.

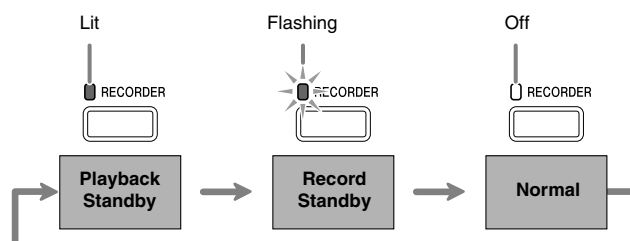

## To record to a specific track of a song

After recording to either of the tracks of a song, you can record to the other track while listening to playback what you recorded in the first track.

1. Press the **RECORDER** button twice so its lamp is flashing.

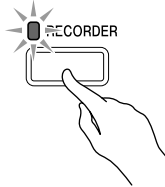

- At this time the **L** lamp will flash to indicate that the digital piano is standing by for recording to Track 1.

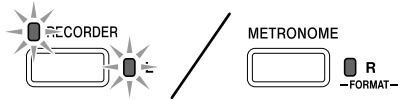

2. While holding down the **FUNCTION** button, press the **RECORDER (L)** button or **METRONOME (R)** button to select the track you want to record.

- Make sure that the indicator lamp for the record track is flashing.  
Track 1: **L** lamp  
Track 2: **R** lamp

*Example:* Track 1 selected

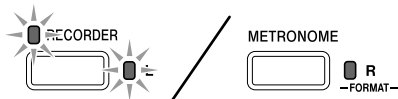

3. Select the tone and effects (Track 1 only) you want to use in your recording.

- Tone (page E-4)
- Effects (page E-7)

### NOTE

- If you want the metronome to sound while you are recording, configure the beat and tempo settings, and then press the **METRONOME** button. See "Using the Metronome" on page E-8 for more information.

4. Start playing something on the keyboard.
  - Recording will start automatically.
5. To stop recording, press the **SONG** ►/■ button.
  - This will cause the **RECORDER** button lamp and the lamp of the track you recorded to change from flashing to lit.
  - To play back the track you just recorded, press the **SONG** ►/■ button.
6. After you are finished recording or playing back, press the **RECORDER** button so its lamp goes out.

## To record to one track of a song while listening to the playback of the other track

1. Press the **RECORDER** button so its lamp is lit.

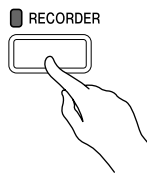

2. While holding down the **FUNCTION** button, press the **RECORDER (L)** button or **METRONOME (R)** button to select the track you want to play back while recording.

3. Press the **RECORDER** button so its lamp is flashing.
  - This will cause the L lamp to flash.

4. While holding down the **FUNCTION** button, press the **RECORDER (L)** button or **METRONOME (R)** button to select the track you want to record.
  - Make sure that the indicator lamp for the record track is flashing.

*Example:* To listen to playback of Track 1 as you record to Track 2

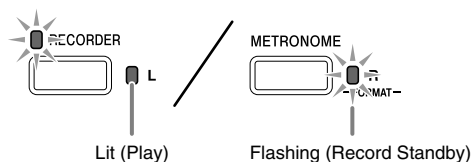

5. Select the tone and effects (Track 1 only) you want to use for your recording.
6. Press the **SONG ▶/■** button or play something on the keyboard.
  - This will start both playback of the recorded track and recording to the other track.
7. To stop recording, press the **SONG ▶/■** button.

## Playing Back from Digital Piano Memory

1. Press the **RECORDER** button so its lamp is lit.

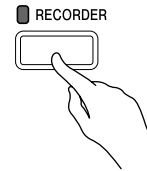

### NOTE

- When a song has something recorded in both tracks, you can turn off one track and play back just the other track, if you want.

2. Press the **SONG ▶/■** button.

- This starts playback of the song and/or track you selected.

### NOTE

- You can change the tempo setting as a track is playing.
- Press the **SONG ▶/■** button again to stop playback.



## Deleting Recorded Data

The following procedure deletes a specific track of a song.



### IMPORTANT!

- The procedure below deletes all of the data of the selected track. Note that the delete operation cannot be undone. Check to make sure you really do not need the data in digital piano memory before you perform the following steps.

1. Press the **RECORDER** button twice so its lamp is flashing.

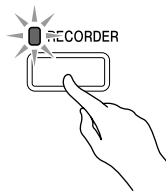

2. While holding down the **FUNCTION** button, press the **RECORDER (L)** button or **METRONOME (R)** button to select the track you want to delete.

3. Press the **RECORDER** button until its lamp is lit.

- This will cause the lamp of the track you selected in step 2 of this procedure to flash.

*Example:* If you selected Track 2 for deletion

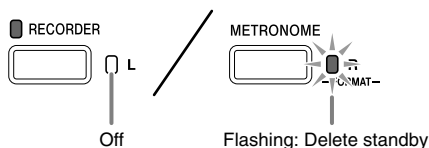

4. Once again, hold down the **FUNCTION** button and press the button that corresponds to the track you want to delete (**RECORDER (L)** or **METRONOME (R)**).

- This deletes the selected track and enters playback standby.
- To cancel the delete operation at any time, press the **RECORDER** button twice so its lamp is unlit.



### NOTE

- Only the Digital Piano's **METRONOME (R)** button and **RECORDER (L)** button are operational from step 3 until you actually perform the delete operation in step 4. No other button operation can be performed.

# Configuring Settings with the Keyboard

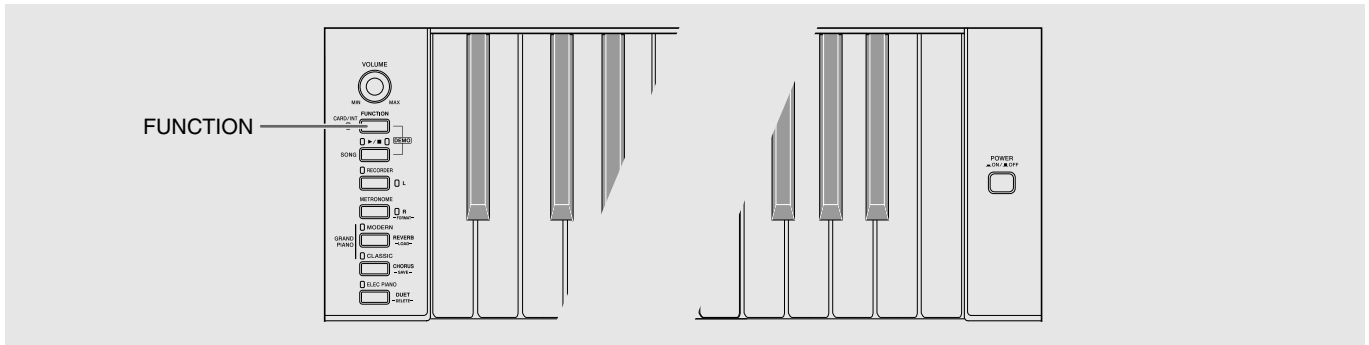

In addition to selecting tones and Music Library tunes, you also can use the **FUNCTION** button in combination with the keyboard keys to configure effect, keyboard touch, and other settings.

## To configure settings with the keyboard

1. Use the “Parameter List” on pages E-18 - E-20 to find the setting you want to configure, and note its details.
2. Use “Keyboard Keys Used for Configuring Settings” on page E-17 to find the location on the keyboard for configuring the setting you want.
3. While holding down the **FUNCTION** button, press the keyboard key for the setting you want to configure.
  - The digital piano will sound an operation tone after it configures the setting.

*Example:* To lower the transpose setting by one semitone

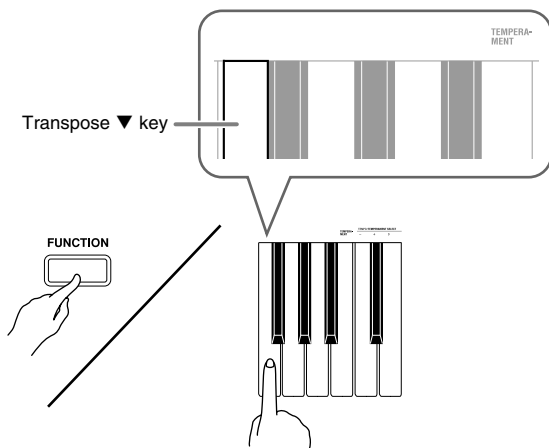

4. Release the **FUNCTION** button to complete the setting procedure.

### NOTE

- You can configure the digital piano so no operation tone sounds in step 3. For details, see “@ Operation tone” under “Parameter List” on pages E-18 - E-20.

## Keyboard Setting Operation Types

There are three types of operations that you can perform while configuring settings with the keyboard keys: Type A, Type B, and Type C.

### Type A: Direct input

*Example:* Pressing the STRINGS keyboard key to select the STRINGS 1 tone

### Type B: Raising or lowering a setting using the + and - or ▼ and ▲ keyboard keys

- Holding down a key raises or lowers the setting at high speed.
- To return to the initial default setting, press both keys at the same time.

### Type C: Value input using the numeric keys (0 to 9)

*Example:* To enter “120”, press keys 1, 2, 0.

### NOTE

- You can find out what operation type applies to each setting by checking the “Operation Type” in the “Parameter List” on pages E-18 - E-20.

# Keyboard Keys Used for Configuring Settings

• The numbers ① through ⑳ correspond to the same numbers in the “Parameter List” on pages E-18 - E-20.

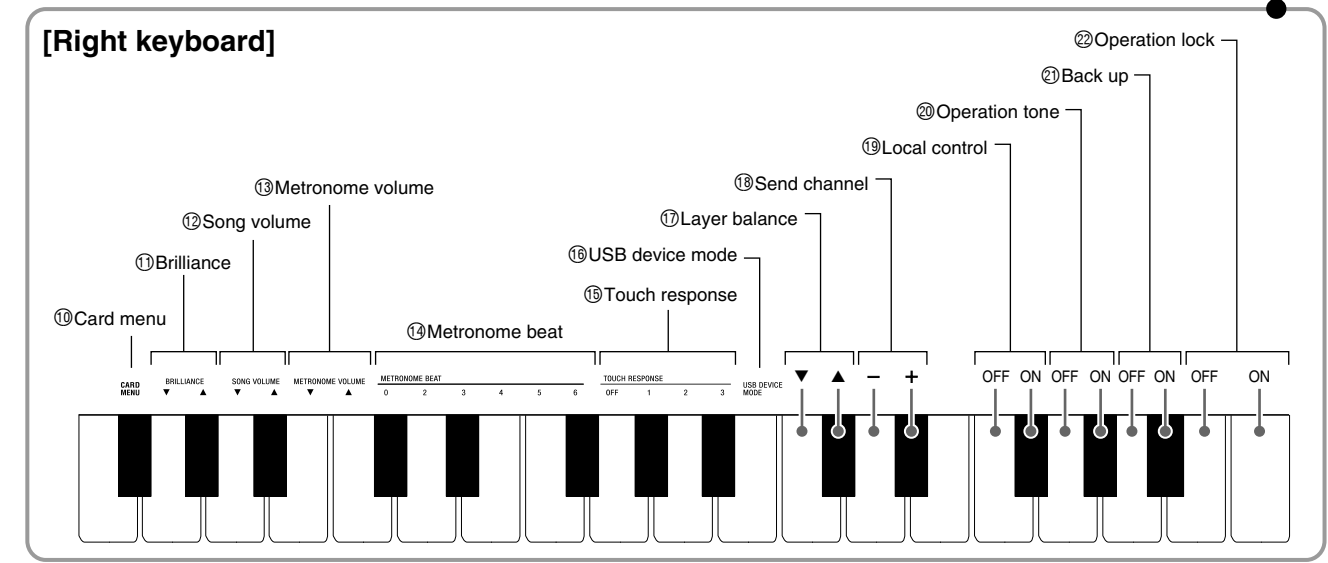
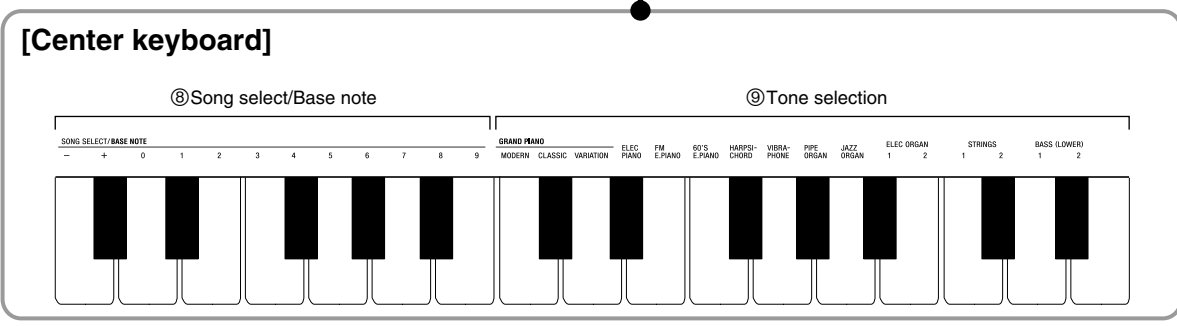
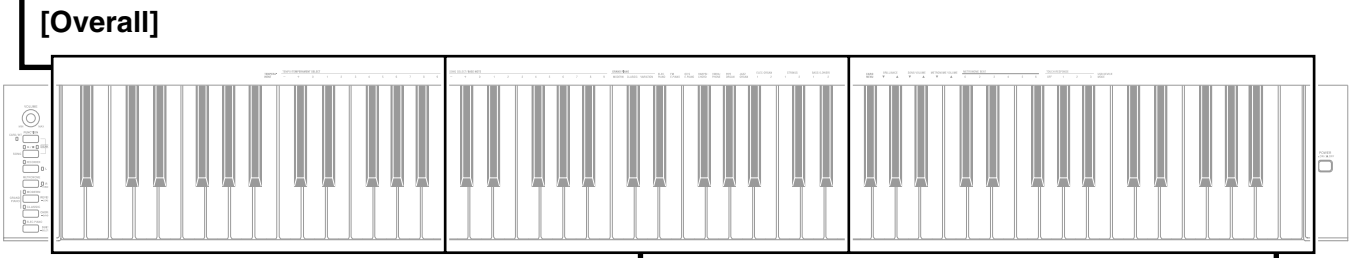
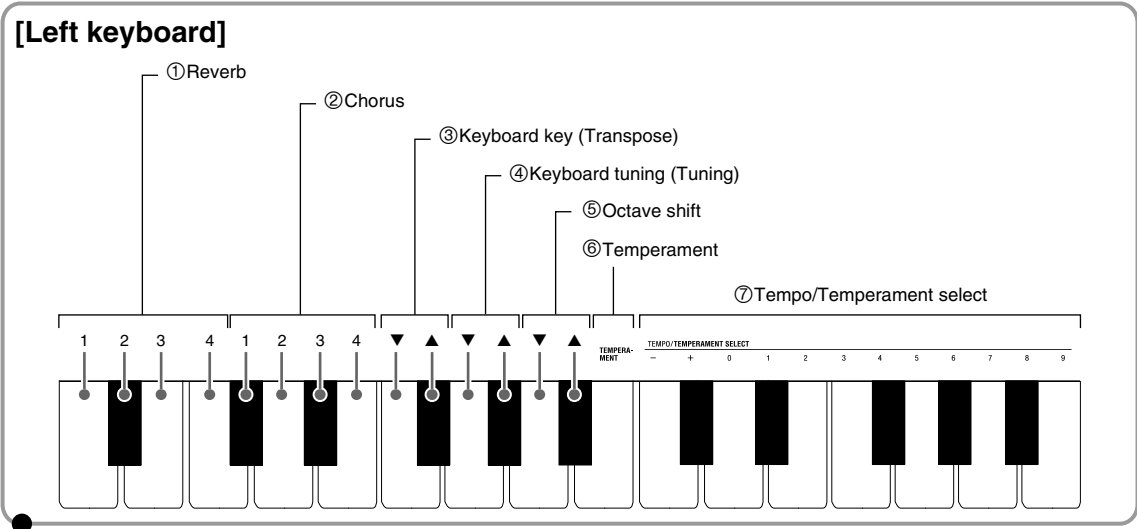

## Parameter List

### ■ Tones

Parameter	Settings	Operation Type (page E-16)	Description	Remarks
① Reverb	1 to 4 Default: 2	A	Specifies the reverb of notes. (page E-7)	
② Chorus	1 to 4 Default: 2	A	Controls the breadth of notes. (page E-7)	
⑨ Tone selection	See page E-4. Default: GRAND PIANO (MODERN)	A	Assigns a tone to the keyboard. (page E-4)	
⑩ Brilliance (BRILLIANCE)	-3 to 0 to 3 Default: 0	B	Specifies the brilliance of notes. (page E-5)	
⑰ Layer balance	-24 to 0 to 24 Default: 0	B	Specifies the volume balance between the main tone and the layered tone. (page E-6)	

### ■ Song/Metronome

Parameter	Settings	Operation Type (page E-16)	Description	Remarks
⑦ Tempo (TEMPO)	20 to 255 Default: 120	B (+/-) C (0 to 9)	Specifies the tempo of Music Library songs, the metronome, recording and playback, etc. (page E-8)	<ul style="list-style-type: none"> <li>Always enter three digits when using the number keys (0 to 9) to input a value. <i>Example:</i> To input 90, enter 0, 9, 0 (leading zero required).</li> <li>During recording, pressing + and - at the same time sets a value of 120.</li> </ul>
⑧ Song select (SONG SELECT)	01 to 61 Default: 01	B (+/-) C (0 to 9)	Selects a Music Library tune. (page E-10)	<ul style="list-style-type: none"> <li>Always enter two-digits when using the number keys (0 to 9) to input a value. <i>Example:</i> To input 8, enter 0, 8 (leading zero required).</li> <li>This setting cannot be changed while recording.</li> </ul>
⑫ Song volume (SONG VOLUME)	00 to 42 Default: 42	B	Sets the volume level of Music Library playback.	
⑬ Metronome volume (METRONOME VOLUME)	00 to 42 Default: 36	B	Specifies the metronome volume. (page E-8)	
⑭ Metronome beat (METRONOME BEAT)	0, 2, 3, 4, 5, 6 Default: 4	A	Specifies the metronome beat. (page E-8)	<ul style="list-style-type: none"> <li>The metronome beat setting cannot be changed while playback of a Music Library tune is in progress.</li> </ul>

## Keyboard

Parameter	Settings	Operation Type (page E-16)	Description	Remarks
③ Keyboard key (Transpose)	-12 to 0 to 12 Default: 0	B	Raises or lowers the tuning of the digital piano in semitone steps.	<ul style="list-style-type: none"> <li>The transpose setting cannot be configured while Music Library playback is in progress or while in the Duet Mode.</li> <li>Raising the key of the digital piano can cause notes the highest part of the range to become distorted.</li> </ul>
④ Keyboard tuning (Tuning)	-99 to 0 to 99 Default: 0	B	Raises or lowers the overall pitch of the digital piano in 1-cent steps (100 cents = 1 semitone) from the standard pitch of A4 = 440 Hz.	<ul style="list-style-type: none"> <li>The pitch setting cannot be changed while playback of a Music Library tune is in progress.</li> </ul>
⑤ Octave shift	-2 to 0 to 2 Default: 0	B	Change the range of the keyboard in octave units.	<ul style="list-style-type: none"> <li>You can configure octave shift settings for the main tone part and layered tone part.</li> <li>You cannot configure octave shift settings for split tone parts.</li> </ul>
⑥ Temperament (TEMPERAMENT) ⑦ Temperament select (TEMPERAMENT SELECT) ⑧ Temperament Base note (BASE NOTE)	Temperament: 00 to 16 Base note: -, +, 0 to 9 (C to B) Defaults: Temperament: 00 (Equal Temperament) Base note: C	Hold down <b>FUNCTION</b> as you press each of the following keyboard keys. 1. TEMPERAMENT (⑥) 2. TEMPERAMENT SELECT (⑦) 3. BASE NOTE (⑧)	You can change the scale (tuning system) of the keyboard from standard equal temperament to another tuning that is more suitable for playing Indian music, Arabic music, classical pieces, etc.	<b>&lt;Temperaments&gt;</b> 00: Equal / 01: Pure Major / 02: Pure Minor / 03: Pythagorean / 04: Kirnberger 3 / 05: Werckmeister / 06: Mean-Tone / 07: Rast / 08: Bayati / 09: Hijaz / 10: Saba / 11: Dashti / 12: Chahargah / 13: Segah / 14: Gurjari Todi / 15: Chandrakauns / 16: Charukeshi <b>&lt;Base notes&gt;</b> -: C / +: C# / 0: D / 1: E♭ / 2: E / 3: F / 4: F# / 5: G / 6: A♭ / 7: A / 8: B♭ / 9: B
⑨ Touch response (TOUCH RESPONSE)	Off (OFF), 1 to 3 Default: 2	A	Specifies the relative touch of the keyboard keys. Setting a smaller value causes lighter touch to produce more powerful sound.	

## ■ MIDI and Other Settings

Parameter	Settings	Operation Type (page E-16)	Description	Remarks
⑮ USB device mode (USB DEVICE MODE)	MIDI, Storage Default: MIDI	—	The digital piano enters MIDI mode automatically when it is connected to a computer by a USB cable. Select storage when saving Recorder memory song data to a computer or when loading computer song data to digital piano memory. (page E-29)	<ul style="list-style-type: none"> <li>While storage is selected for this setting, the <b>GRAND PIANO (MODERN, CLASSIC)</b> and <b>ELEC PIANO</b> button lamps flash, and all other lamps are unlit.</li> <li>All digital piano operations are disabled at this time.</li> <li>Each press of the USB device mode keyboard key toggles between the MIDI and storage modes.</li> </ul>
⑰ Send channel	01 to 16 Default: 01	B	Specifies one of the MIDI channels (1 through 16) as the Send channel, which is used for sending MIDI messages to an external device.	
⑱ Local control	Off, On Default: On	A	Selecting "Off" for Local control cuts off the digital piano's sound source, so no sound is produced by the digital piano when keys are pressed.	<ul style="list-style-type: none"> <li>The Local control setting cannot be changed while playback of a Music Library tune is in progress.</li> </ul>
⑩ Card menu (CARD MENU)	Off, On Default: Off	—	Specifies the card function as save, load, delete, or format (page E-21).	
⑳ Operation tone	Off, On Default: On	A	Selecting "Off" disables sounding of the operation tone whenever a keyboard key is pressed while the <b>FUNCTION</b> button is depressed.	<ul style="list-style-type: none"> <li>This setting is retained even when the digital piano is turned off.</li> <li>The operation tone setting cannot be changed while Music Library playback is in progress, while the metronome is sounding, and during recording.</li> </ul>
㉑ Back up	Off, On Default: Off	A	When "On" is selected for this setting, the digital piano will remember <u>its current settings</u> <sup>*1</sup> , and restore them when it is turned on again. When "Off" is selected, settings <sup>*2</sup> are reset to their initial defaults whenever the digital piano is turned on.	<ul style="list-style-type: none"> <li>The back up setting cannot be changed while Music Library playback is in progress, while the metronome is sounding, in the Duet Mode, and during recording.</li> </ul> <p>*1 The following settings are not remembered.</p> <ul style="list-style-type: none"> <li>Duet Mode</li> <li>Tune LR (part)</li> <li>Local control</li> </ul> <p>*2 Except for the operation tone on/off setting.</p>
㉒ Operation lock	Off, On Default: Off	A	Selecting "On" for this setting locks the digital piano's buttons (except for the power button and the buttons required for unlock), so no operation can be performed. Turn on operation lock when you want to protect against unintentional button operations.	<ul style="list-style-type: none"> <li>The operation lock setting cannot be changed while Music Library playback is in progress, while the metronome is sounding, and during recording.</li> </ul>

# Using a Memory Card

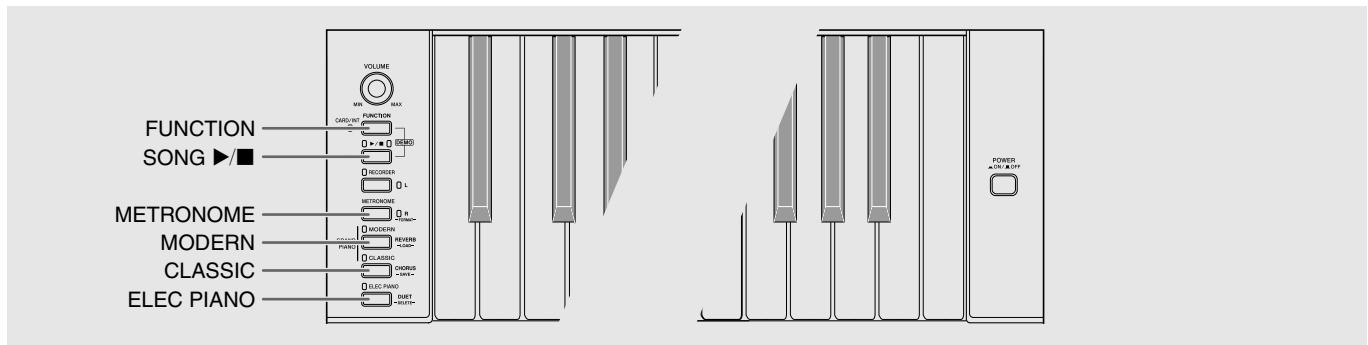

You can use the procedures in this section to save songs you recorded on the Digital Piano (recorder songs) to a memory card, and to use a memory card to load songs to user song memory (Music Library 61).

- Use a memory card with a capacity of 2GB or less. Use of a card with a capacity that is greater than 2GB or other types of memory cards is not supported.
- In this manual, mentions of a “memory card” refer to an SD memory card.

## ■ Types of Data

Data Type	Description (File Name Extension)	Supported Operations	
		Save to Memory Card	Load from Memory Card
User songs (page E-29)	One of the following two types of music data 1. CASIO format data (CM2) 2. Standard MIDI files (MID) SMF Format 0 or Format 1	–	○
Recorder songs (page E-12)	Song data recorded on this Digital Piano (MID)	○*	–

\* Can be converted to a standard MIDI file (SMF Format 0, file name extension MID) and saved.

## Card and Card Slot Precautions

### IMPORTANT!

- Be sure to observe the precautions provided in the documentation that comes with the memory card.
- Memory cards have a write-protect switch. Use it when you want to protect the data on the card from accidental deletion.
- Avoid using a memory card under the following conditions. Such conditions can corrupt data stored on the memory card.
  - Areas subjected to high temperature, high humidity, or corrosive gas
  - Areas subjected to strong electrostatic charge and digital noise
- Never touch the contacts of a memory card when loading it or removing it from the Digital Piano.
- Never eject the memory card while data is being written to or loaded from it. Doing so can corrupt the data on the memory card and damage the memory card slot.
- Never insert anything besides a memory card into the card slot. Doing so creates the risk of malfunction.
- Electrostatic charge from your fingers or the memory card to the card slot can cause malfunction of the Digital Piano. If this happens, turn the Digital Piano off and then back on again.
- A memory card can become quite warm after very long use in the memory card slot. This is normal and does not indicate malfunction.

## Loading and Removing a Memory Card

### IMPORTANT!

- A memory card must be positioned correctly when being loaded into the Digital Piano. Trying to force an improperly oriented memory card into the slot can damage the memory card and the slot.

1. With the top of the memory card facing upwards (so you can see it), carefully insert it into the Digital Piano's memory card slot (15) until stops with a click.

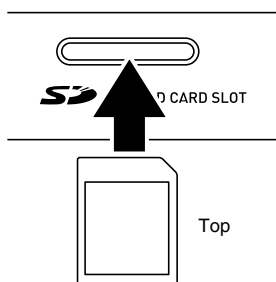

2. To remove the memory card first press it into the slot further.

This will cause the memory card to disengage and eject partially. Pull the memory card the rest of the way out of the slot.

## Formatting a Memory Card

### IMPORTANT!

- Format a memory card before using it for the first time.
- Before formatting a memory card, make sure it does not have any valuable data stored on it.
- The memory card format operation performed by this Digital Piano is a "quick format". If you want to completely delete all of the data on the memory card, format it on your computer or some other device.

1. Insert the memory card you want to format into the Digital Piano's memory card slot.  
Make sure the write-protect switch of the memory card is not in the write-protect position so writing is enabled.

2. While holding down the **FUNCTION** button, press the **CARD MENU** keyboard key. The **CARD** lamp will flash.

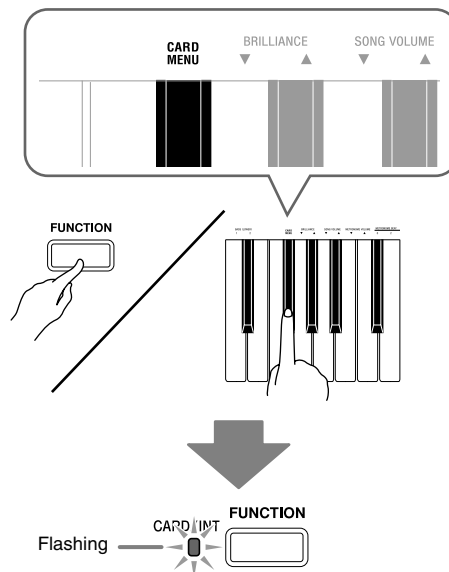

3. Press the **METRONOME (FORMAT)** button.

The **FORMAT** lamp will light, which indicates the format mode.

- To exit the format mode, press the **FUNCTION** button.

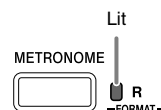

4. Press the **SONG** ►/■ button.

This starts formatting.

- Formatting is finished when the **FORMAT** lamp and **CARD** lamp go out. The Digital Piano exits the format mode at this time.

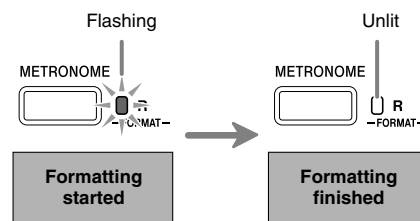



## Saving a Recorded Song to a Memory Card

Use the procedure below to save data you recorded on the Digital Piano to a memory card as a MIDI file (SMF Format 0).

1. Insert a memory card into the Digital Piano's memory card slot.
2. While holding down the **FUNCTION** button, press the **CARD MENU** keyboard key. The **CARD** lamp will flash.

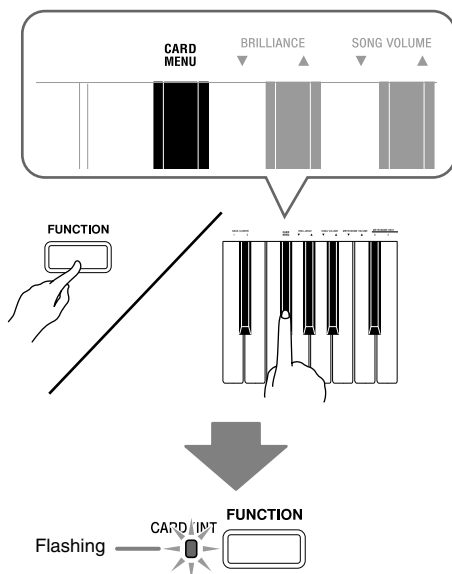

3. Press the **CLASSIC (SAVE)** button. The **SAVE** lamp will light, which indicates the data save mode.
  - To exit the data save mode, press the **FUNCTION** button.

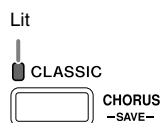

4. Press the **SONG** ►/■ button.
  - This starts the data save operation.
  - Data save is finished when the **SAVE** lamp and **CARD** lamp go out. The Digital Piano exits the data save mode at this time.

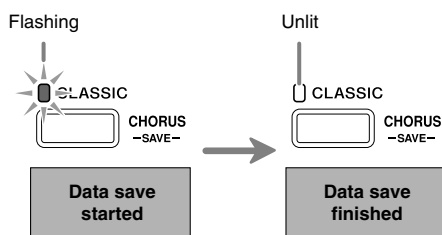

## Memory Card Data Storage

The above procedure stores Digital Piano data in a folder named **MUSICDAT** on the memory card.

- The **MUSICDAT** folder is created automatically when you format the memory card on the Digital Piano (page E-22).
- Note that files not in the **MUSICDAT** folder cannot be loaded, deleted, or renamed by this Digital Piano. You also will not be able to load or delete any file stored in any subfolder inside the **MUSICDAT** folder.

## Loading Song Data from a Memory Card into Digital Piano Memory

You can use the procedure below to load user song data (page E-29) from a memory card to Digital Piano Music Library song number 61. After that, you can play back the user song or use it for lesson play.

1. On your computer, copy the song data into the "**MUSICDAT**" folder.
  - The Digital Piano recognizes only the first 99 files in the "**MUSICDAT**" folder (sorted by file name).
2. Insert the memory card into the piano's memory card slot.
3. Press the **FUNCTION** button. The **CARD** lamp will light.
  - Note that the **CARD** lamp will not remain lit if you hold down the **FUNCTION** button too long.

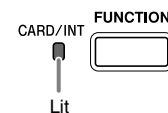

4. While holding down the **FUNCTION** button, use the **SONG SELECT** – and + keys to scroll between songs.
  - You also can jump to a specific song by using the **SONG SELECT** keys to specify a sequential file number from 01 to 99. Note, however, that file numbers are not indicated in the file name.

5. While holding down the **FUNCTION** button, press the **CARD MENU** keyboard key. The **CARD** lamp will flash.

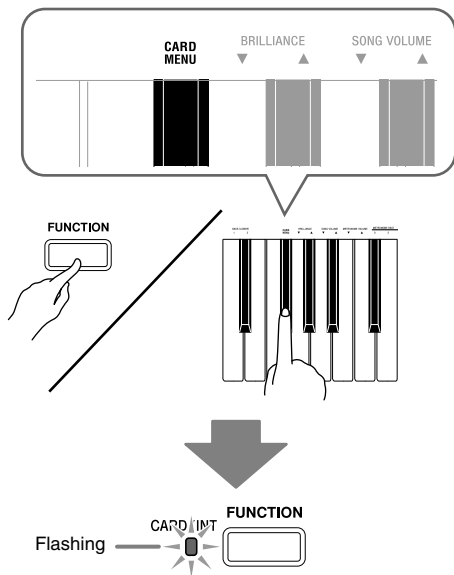

6. Press the **MODERN (LOAD)** button. The **LOAD** lamp will light, which indicates the data load mode.
- To exit the data load mode, press the **FUNCTION** button.

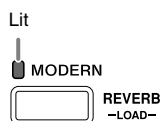

7. Press the **SONG** ►/■ button.

This starts loading of the data to the Music Library song number 61 (user song).

- Data loading is finished when the **LOAD** lamp and **CARD** lamp go out. At this time you can play back the loaded song by pressing the **SONG** ►/■ button.

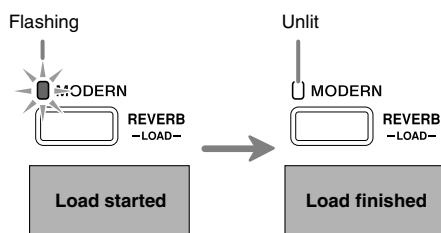

## Deleting Memory Card Data

You can use the procedure below to delete song data stored in the memory card's "MUSICDAT" folder.

- Insert the memory card into the piano's memory card slot.
- Press the **FUNCTION** button. The **CARD** lamp will light.
  - Note that the **CARD** lamp will not remain lit if you hold down the **FUNCTION** button too long.
- While holding down the **FUNCTION** button, use the **SONG SELECT -** and **+** keys to scroll between songs in the "MUSICDAT" folder and select the one you want.
  - You also can jump to a specific song by using the **SONG SELECT** keys to specify a sequential file number from 01 to 99. Note, however, that file numbers are not indicated in the file name.
- While holding down the **FUNCTION** button, press the **CARD MENU** keyboard key. The **CARD** lamp will flash.

- Press the **ELEC PIANO (DELETE)** button. The **DELETE** lamp will light, which indicates the data delete mode.
  - To exit the data delete mode, press the **FUNCTION** button.

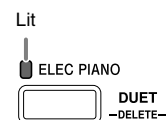

- Press the **SONG** ►/■ button.

This starts deletion of the selected data.

- Data delete is finished when the **DELETE** lamp and **CARD** lamp go out. The Digital Piano exits the data delete mode at this time.

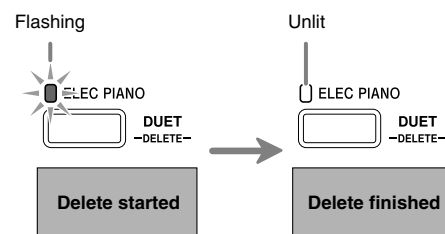

## Simple Play Back of a Song on a Memory Card

You can use the procedure below to play back a user song (page E-29) stored on a memory card without loading the song into Digital Piano memory (Music Library song number 61).

1. On your computer, copy the song data into the "MUSICDAT" folder.
  - The Digital Piano recognizes only the first 99 files in the "MUSICDAT" folder (sorted by file name) for playback.
2. Insert the memory card into the piano's memory card slot.
3. Press the **FUNCTION** button.
 

The CARD lamp will light.

  - Note that the CARD lamp will not remain lit if you hold down the **FUNCTION** button too long.

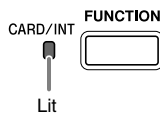

4. Press the **SONG** ►/■ button.
 

This will start playback of the first file in the folder.

  - Press the **SONG** ►/■ button again to stop playback.
5. While holding down the **FUNCTION** button, use the **SONG SELECT** – and + keys to scroll between songs.
  - You also can jump to a specific song by using the **SONG SELECT** keys to specify a sequential file number from 01 to 99. Note, however, that file numbers are not indicated in the file name.
6. To exit the card song playback mode, press the **FUNCTION** button so the **CARD** lamp goes out.
  - Note that the **CARD** lamp will not go out if you hold down the **FUNCTION** button too long.

## Saving Data to Digital Piano Memory (Internal Area) Instead of a Memory Card

Even when you do not have a memory card loaded in the Digital Piano's memory card slot, you can save up to about 4MB of data in the Digital Piano's internal memory area. You also can load and delete internal memory area data using the same procedures that you use with a memory card.

1. Remove the memory card from the Digital Piano's memory card slot (page E-22).
  - Removing the memory card from the slot enables internal memory area data operations (save, load, delete, playback).

To do this	Perform this operation
Save data to the internal memory area	From step 2 under "Saving a Recorded Song to a Memory Card" on page E-23
Load data from the internal memory area	From step 3 under "Loading Song Data from a Memory Card into Digital Piano Memory" on page E-23
Delete data from the internal memory area	From step 2 under "Deleting Memory Card Data" on page E-24
Play back a song in the internal memory area	From step 3 under "Simple Play Back of a Song on a Memory Card" on page E-25

## Error Indicators

The following shows how the lamps indicate the error type when an error occurs due to data transfer failure or some other reason.

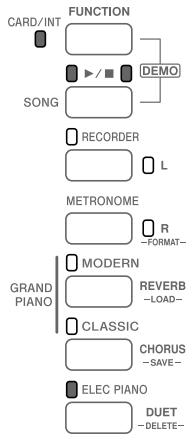
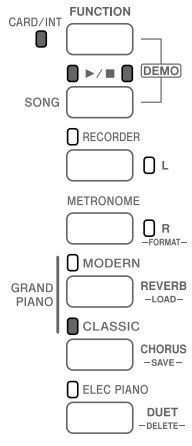
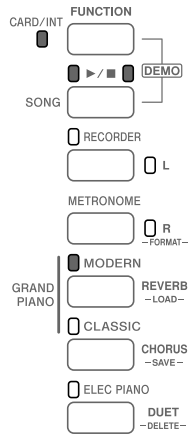
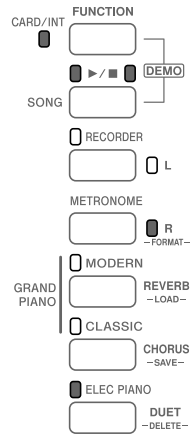
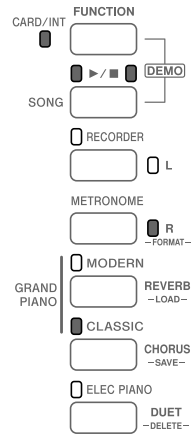
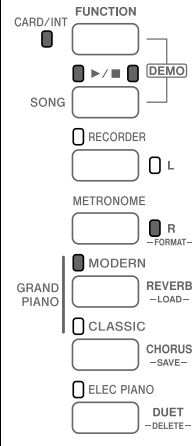
Lamps						
Error Type	No Card	No File	No Data	Protect	ReadOnly	MediaFull
Cause	<ol style="list-style-type: none"> <li>The memory card is not loaded correctly in the Digital Piano's memory card slot.</li> <li>The memory card was removed while some operation was in progress.</li> </ol>	<ol style="list-style-type: none"> <li>There is no MUSICDAT folder (page E-23) on the memory card.</li> <li>There is no loadable or playable file in the MUSICDAT folder.</li> </ol>	<p>You are attempting to save data to a memory card when there is no data to save.</p>	<p>The memory card is write-protected.</p>	<p>A read-only file with the same name you are trying to use is already stored on the memory card.</p>	<ol style="list-style-type: none"> <li>There is not enough room available on the memory card.</li> <li>There is not enough room available in Digital Piano memory.</li> </ol>
Action	<ol style="list-style-type: none"> <li>Correctly load the memory card into the memory card slot.</li> <li>Do not remove the memory card while any operation is in progress.</li> </ol>	<ol style="list-style-type: none"> <li>Create a MUSICDAT folder on the memory card or format the memory card on the Digital Piano (page E-22).</li> <li>Move the file you want to load or play into the memory card's MUSICDAT folder.</li> </ol>	<p>Record something before performing a save operation.</p>	<p>Use the memory card's write protect switch to enable writing.</p>	<ul style="list-style-type: none"> <li>Use a different name to save the new file.</li> <li>Remove the read-only attribute from the existing file and overwrite it with the new file.</li> <li>Use a different memory card.</li> </ul>	<ol style="list-style-type: none"> <li>Delete some of the files on the memory card to make room for new data (page E-24), or use a different card.</li> <li>Delete some or all user data from Digital Piano memory to make room for new data.</li> </ol>

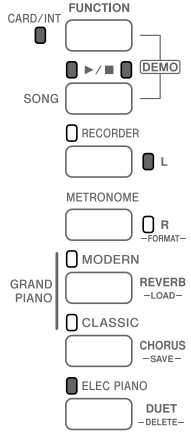
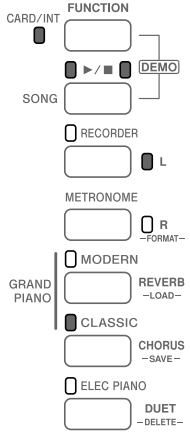
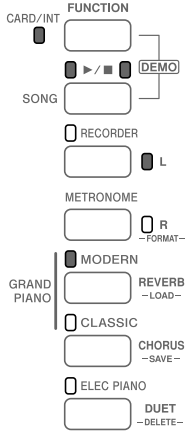
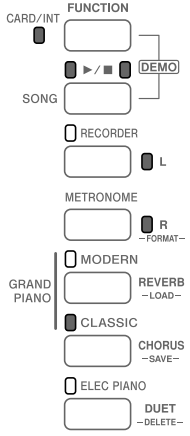
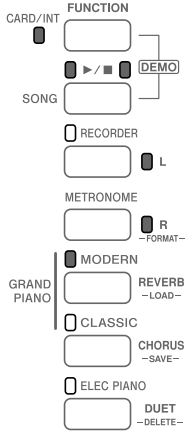
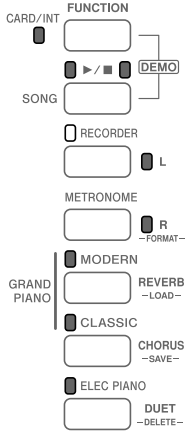
<b>Lamps</b>						
<b>Error Type</b>	<b>Not SMF01</b>	<b>SizeOver</b>	<b>WrongDat</b>	<b>Convert</b>	<b>Format</b>	<b>Media R/W</b>
<b>Cause</b>	You are attempting to play back SMF Format 2 song data.	The data on the memory card is too big to play.	<ol style="list-style-type: none"> <li>1. The memory card data is corrupted.</li> <li>2. The memory card contains data that is not supported by this Digital Piano.</li> </ol>	There is not enough Digital Piano memory available to convert a recorder song (page E-12) to SMF data and store it on the memory card.	<ol style="list-style-type: none"> <li>1. The current memory card format is not compatible with this Digital Piano.</li> <li>2. The memory card capacity is greater than 2GB.</li> <li>3. Memory card data is corrupted.</li> </ol>	<ol style="list-style-type: none"> <li>1. Memory card data is corrupted.</li> <li>2. Digital Piano memory is corrupted.</li> </ol>
<b>Action</b>	This Digital Piano supports playback of SMF Format 0 or Format 1 only.	This Digital Piano supports playback of song data files with a maximum size of 65 Kbytes.	—	Reduce the size of the recorder song data by deleting unneeded tracks (page E-15), if there are any.	<ol style="list-style-type: none"> <li>1. Format the memory card on the Digital Piano (page E-22).</li> <li>2. Use a memory card with a capacity of 2GB or less.</li> <li>3. Use a different memory card.</li> </ol>	<ol style="list-style-type: none"> <li>1. Use a different memory card.</li> <li>2. Back-up Digital Piano memory data by copying it to your computer, and then turn the Digital Piano off and then back on again. Note that you may not be able to back-up Digital Piano data in certain cases.</li> </ol>

# Connecting to a Computer

You can connect the Digital Piano to a computer and exchange MIDI data between them. You can send play data from the Digital Piano to music software running on your computer, or you can send MIDI data from your computer to the Digital Piano for playback.

## Minimum Computer System Requirements

The following shows the minimum computer system requirements for sending and receiving MIDI data. Check to make sure that your computer complies with these requirements before connecting the Digital Piano to it.

### ● Operating System

Windows® XP (SP2 or later)\*1

Windows Vista® \*2

Mac OS® X (10.3.9, 10.4.11 or later, 10.5.6 or later)

\*1: Windows XP Home Edition

Windows XP Professional (32-bit)

\*2: Windows Vista (32-bit)

### ● USB port



#### IMPORTANT!

- Never connect to a computer that does not conform to the above requirements. Doing so can cause problems with your computer.

## Connecting the Digital Piano to Your Computer



#### IMPORTANT!

- Make sure you follow the steps of the procedure below exactly. Connecting incorrectly can make data send and receive impossible.

### 1. Turn off the Digital Piano and then start up your computer.

- Do not start up the music software on your computer yet!

### 2. After starting up your computer, use a commercially available USB cable to connect it to the Digital Piano.

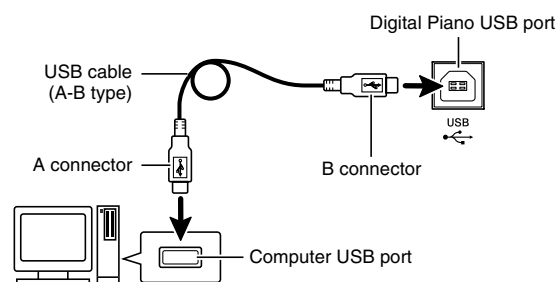

### 3. Turn on the Digital Piano.

- If this is the first time you are connecting the Digital Piano to your computer, the driver software required to send and receive data will be installed on your computer automatically.

### 4. Start up your computer's music software.

### 5. Configure the music software settings to select one of the following as the MIDI device.

CASIO USB-MIDI : (For Windows Vista, Mac OS X)

USB Audio Device: (For Windows XP)

- For information about how to select the MIDI device, see the user documentation that comes with the music software you are using.



#### IMPORTANT!

- Be sure to turn on the Digital Piano first before starting up your computer's music software.



#### NOTE

- Once you are able to connect successfully, there is no problem with leaving the USB cable connected when you turn off your computer and/or Digital Piano.
- For detailed specifications and connections that apply to MIDI data send and receive by this Digital Piano, see the latest support information provided by the website at the following URL.

<http://world.casio.com/>

## Using MIDI

### What is MIDI?

The letters MIDI stand for Musical Instrument Digital Interface, which is the name of a worldwide standard for digital signals and connectors that makes it possible to exchange musical data between musical instruments and computers (machines) produced by different manufacturers.

#### NOTE

- For detailed information about MIDI Implementation, visit the CASIO website at: <http://world.casio.com/>.

See “Send channel” and “Local control” on page E-20.

## Transferring Song Data with a Computer

Use the procedures in this section to transfer Recorder memory data to a computer for storage, and to load songs to user song memory (Music Library 61).

#### IMPORTANT!

- Turning off the Digital Piano while data is being saved or loaded can cause all data currently stored in Digital Piano memory (recorded songs, etc.) to be deleted. Take care so power is not turned off accidentally during data save and load operations. If data is deleted, it will take longer than normal for the Digital Piano to power up the next time you turn it on (page E-4).

- Remove the memory card from the Digital Piano's memory card slot (page E-22).
  - You will not be able to transfer data between the Digital Piano and a computer if a card is in the card slot.
- Perform steps 1 through 3 of the procedure under “Connecting the Digital Piano to Your Computer” on page E-28.

- Change the digital piano's USB device mode to storage.

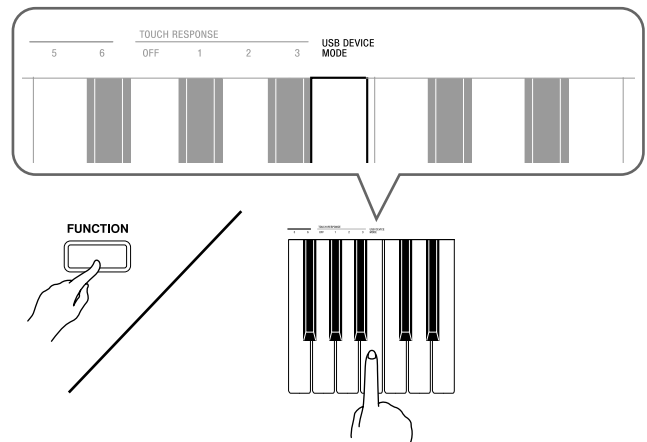

- While holding down the **FUNCTION** button, press the keyboard key that corresponds to the USB device mode.
- After this setting is changed, the **GRAND PIANO (MODERN, CLASSIC)** and **ELEC PIANO** button lamps flash, and all other lamps are unlit.
- See “USB device mode (USB DEVICE MODE)” on page E-20 for more information.

- On your computer, perform the required operation to display your computer's storage devices.

If your computer is running this operating system:	Do this:
Windows XP	Double-click “My Computer”.
Windows Vista	Double-click “Computer”.
Mac OS	Skip step 4 and double-click “PIANO” on your Mac desktop.

- The memory of this digital piano will appear as “PIANO” under “Devices with Removable Storage”.

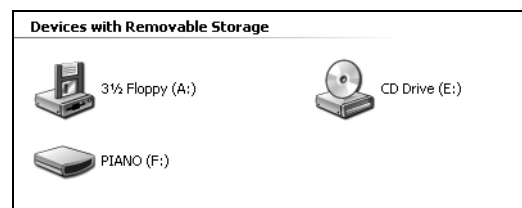

## 5. Double-click "PIANO".

- "PIANO" contains folders named MUSICLIB and RECORDER. Use MUSICLIB to load a song into the piano's user song memory (Music Library 61), and RECORDER to transfer Recorder memory data to and from your computer.



Data Type	Folder Name	File Name and Extension*
User songs	MUSICLIB	BIDSNG01.MID: SMF format data (format 0/1) BIDSNG01.CM2: CASIO original format data
Recorder memory data	RECORDER	BIDREC01.CSR: CASIO original format data

\* Before starting a store or load operation, first check the file name and extension to ensure it matches the ones shown in this column.

### IMPORTANT!

- The initial default configuration for Windows XP and Windows Vista is to hide file name extensions. Perform one of the following operations on your computer to show file name extensions.

To show file name extensions under Windows XP

1. Open the folder you want.
2. On the [Tools] menu, click [Folder Options].
3. Click the [View] tab. In the [Advanced settings] list, clear the check box next to [Hide extensions for known file types].
4. Click [OK].

To show file name extensions under Windows Vista

1. Open Folder Options by clicking the [Start] button, clicking [Control Panel], clicking [Appearance and Personalization], and then clicking [Folder Options].
2. Click the [View] tab. Under [Advanced settings] clear the [Hide extensions for known file types] check box.
3. Click [OK].

## ■ To load a song into user song memory (Music Library 61)

1. Copy the file (.MID or .CM2) you want to load into user song memory to the MUSICLIB folder.
  2. Change the name of the file to BIDSNG01, with a file name extension of .MID or .CM2.
- If there are two files with the names BIDSNG01.MID and BIDSNG01.CM2 in the MUSICLIB folder, only the BIDSNG01.MID data will be loaded into user song memory. If you want the BIDSNG01.CM2 file to be loaded in this case, change the name of the BIDSNG01.MID to something else.

### NOTE

- The message "Cannot rename MIDIDATA" will appear on your computer screen if you try to change the name of the copied file to BIDSNG01.MID while there is already a file in the MUSICLIB folder named BIDSNG01.MID. Change the name of the current BIDSNG01.MID to something else and then rename the copied file to BIDSNG01.MID.

## ■ To transfer Recorder memory data between the digital piano and your computer

To transfer the digital piano's current Recorder memory data to your computer, copy the contents of the RECORDER folder to your computer.

To return Recorder data you previously saved to your computer back to Recorder memory, copy it back to the RECORDER folder (and replace the current RECORDER folder contents).

## 6. After the file copy operation is complete, return the USB device mode to MIDI.

- If you are using a Macintosh, perform the eject operation (drag them to the trash can).
- While holding down the **FUNCTION** button, press the applicable keyboard key. See "USB device mode (USB DEVICE MODE)" on page E-20 for more information.
- Returning the USB device mode to MIDI will load the contents of MUSICLIB into user song memory and the contents of RECORDER into Recorder memory.

### IMPORTANT!

- A data conversion error is indicated when both of the **SONG** ►/■ button lamps, and the **GRAND PIANO (MODERN)** button, **GRAND PIANO (CLASSIC)** button, and **ELEC PIANO** button lamps are all lit, and all other lamps are unlit.



## Simple Playback of a User Song in Digital Piano Memory PIANO Drive

You can use the procedure below at any time to copy user song data to the PIANO drive (without putting it in the MUSICLIB folder) for simplified playback on the Digital Piano.

- When you copy a user song data file to the MUSICLIB folder, you need to rename it according to specified format (step 5, above). You do not need to rename the file if you use the procedure below.

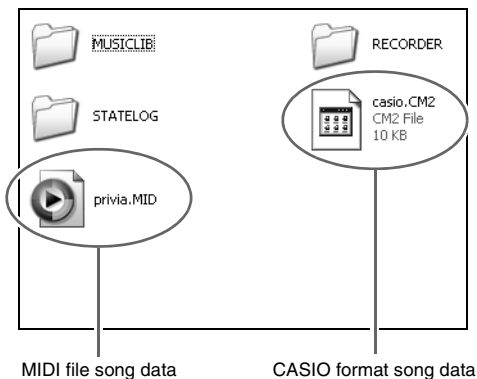

1. Perform the previous procedure (“To transfer Recorder memory data between the digital piano and your computer”) to copy the user song data file to the PIANO drive (Digital Piano memory).
  - The Digital Piano recognizes only the first 99 files in the PIANO drive (sorted by file name) for playback.
2. Press the Digital Piano’s **FUNCTION (CARD/INT)** button.  
The CARD lamp will light.
3. Next, perform step 4 through 6 of the procedure under “Simple Play Back of a Song on a Memory Card” (page E-25).

## Using Your Digital Piano as a Memory Card Reader

You can display the contents of the memory card currently loaded in the Digital Piano’s card slot and perform copy, delete, and other card operations from your computer.

1. Insert the memory card into the Digital Piano’s card slot.
2. Perform the procedure starting from step 2 on page E-29.

In step 4 of the procedure, “SD\_MMC” will appear in place of “PIANO”. You can double-click “SD\_MMC” to display the contents of the card loaded in the Digital Piano card slot, and change it as you like.

### Copyrights

The rights of creators and copyright holders of music, images, computer programs, databases, and other data are protected by copyright laws. You are allowed to reproduce such works for personal or non-commercial use only. For any other purpose, all reproduction (including data format conversion), modification, transfer of reproductions, distribution over a network, or any other use without permission of the copyright holder exposes you to claims for damages and criminal prosecution for copyright infringement and violation of the author’s personal rights. Be sure to reproduce and otherwise use copyrighted works only in accordance with applicable copyright laws.

# Getting Ready

## Assembling the Stand

Before assembling the stand, first take a few moments to check that all of the items shown below are present.

- This stand does not include any of the tools required for assembly. It is up to you to prepare a large Philips head (+) screwdriver for assembly.

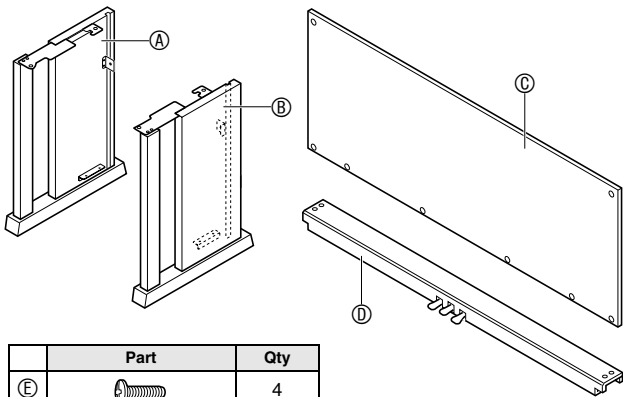

	Part	Qty
E		4
F		6
G		2
H		2
I		2
J		4
K		2
L		1
M		1
N		1

### IMPORTANT!

- If anything is missing or damaged, contact your local CASIO service provider.
- Do not use any screws other than those that come with the stand. Doing so risks damage to the stand and/or Digital Piano.

### CAUTION

- Assembly of the stand should be performed by at least two people working together.
- This stand should be assembled on a flat surface.
- Do not remove the tape securing the keyboard cover in place until assembly is complete. Removing the tape can cause the keyboard cover to open and close during assembly, creating the risk of personal injury to your hands and fingers.
- Take care that you do not pinch your fingers between parts when assembling them.

1. Unfasten the band 1 that bundles the pedal cable to the back of crosspiece ④ and pull the pedal cord out from the crosspiece.

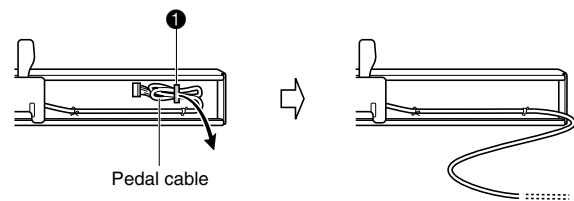

2. Attach side panels A and B to crosspiece ④. Secure the side panels using four screws E.

- When installing part 2, slide the brackets 3 into the slots in either end crosspiece ④. If the brackets 3 are not inserted into the ends of the crosspiece ④ as far as they will go, the screws E will not be able to enter into the screw holes of the brackets 3, which can strip the threads of the screws.
- Cover the screw heads with the caps ④.

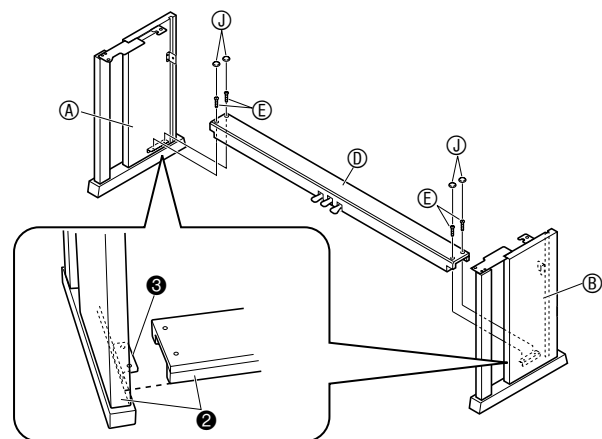

3. Slide back panel C into the grooves 4 of the side panels.

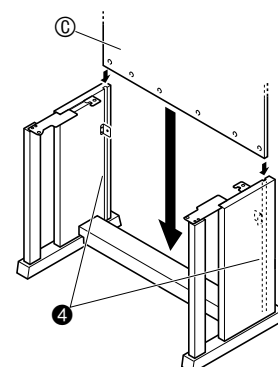

4. Use the two screws ① to secure the top left and right edges of the back panel ③ to the brackets ⑤ of side panels ④ and ⑤.

- At location ⑥, slip the clip ⑥ onto the screw ① before installing the screw.

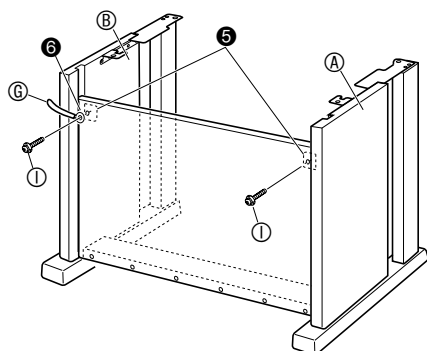

5. Next, secure the bottom of the back panel ③ with the six ⑦ screws.

- Place one of the clips ⑥ onto the leftmost screw ⑦ as shown in the illustration below.

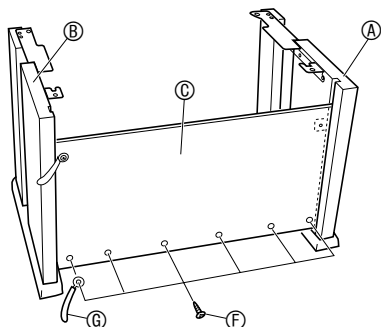

6. Adjust the height adjustment screw ⑦ to provide support so crosspiece ⑩ does not bow downwards when the pedals are pressed.

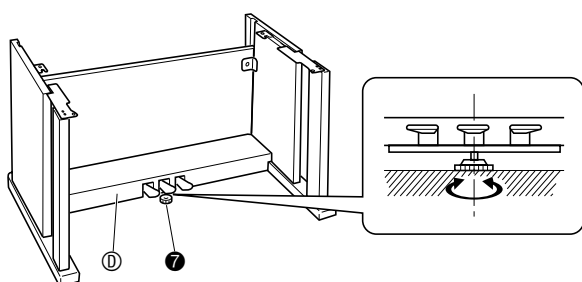

**IMPORTANT!**

- Pressing the pedals without adjusting height adjustment screw ⑦ can result in damage to crosspiece ⑩. Always make sure you adjust height adjustment screw ⑦ before operating the pedals.

7. Place the piano onto the stand.

**IMPORTANT!**

- In order to ensure you do not get your fingers pinched between the piano and the stand, grasp the piano on its sides (not its ends) at the locations marked with stars (★) in the illustration.

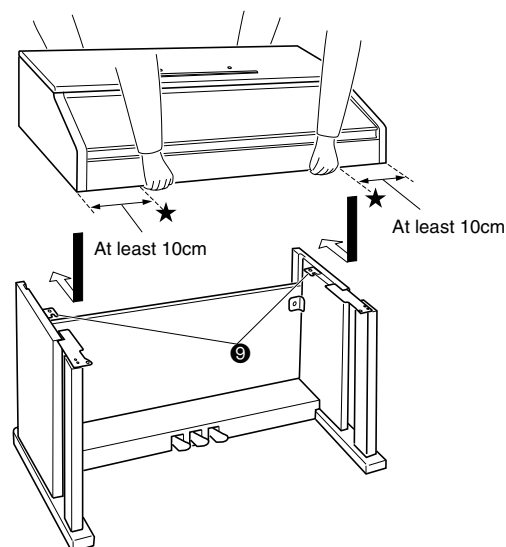

- At this time the screws on the bottom of the piano ⑧ should hook into the cutouts in the stand brackets ⑨.

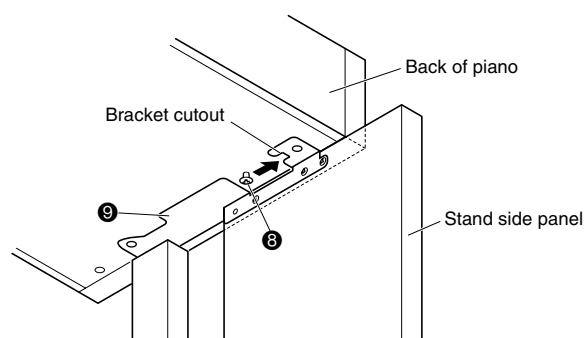

8. First, use the two butterfly bolts (H) to secure the back of the piano to the stand. Next, use the two screws (K) to secure the front of the piano.

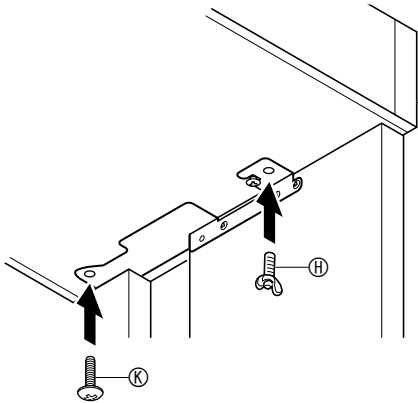

**IMPORTANT!**

- The butterfly bolts (H) and screws (K) keep the piano from slipping off the stand. Never use the piano without the butterfly bolts (H) and screws (K) installed.

9. Affix the adaptor cord clip (N) next to the power terminal (DC24V).

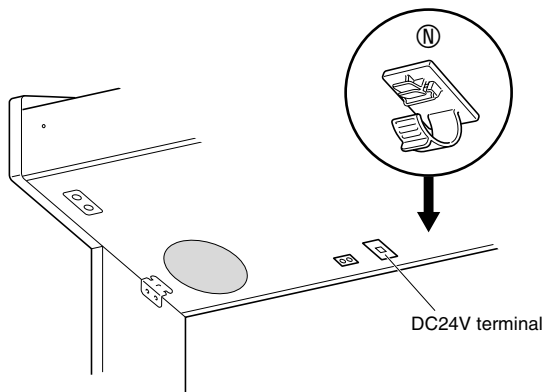

## To connect the cables

1. Insert the plug of the AC adaptor that comes with the Digital Piano into its power terminal (DC24V).

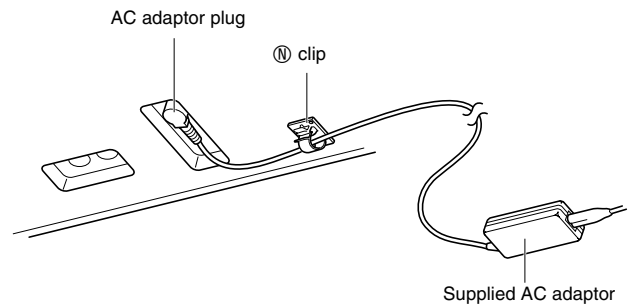

\* **Using the Clip (N)**

● **To fasten the clip**

As shown in the illustration, press down on (a) to force the tip of the clip into the slot. Press down until you hear the clip click securely into place.

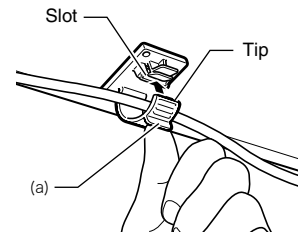

● **To release the clip**

As shown in the illustration, press (b) in the direction indicated by the arrow.

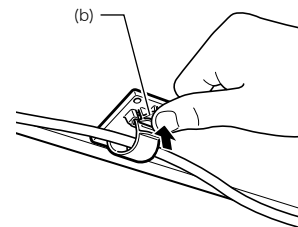

2. Orienting the pedal plug as shown in the illustration, plug it into the pedal connector on the bottom of the piano.

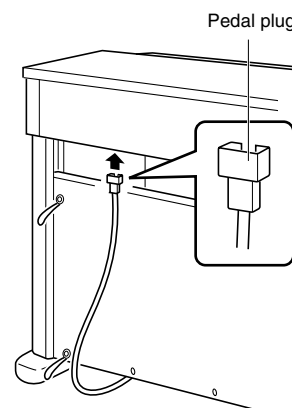

- 3.** Bundle the AC adaptor and pedal cables together and use clips ⑥ to secure them at the two points shown in the illustration below.

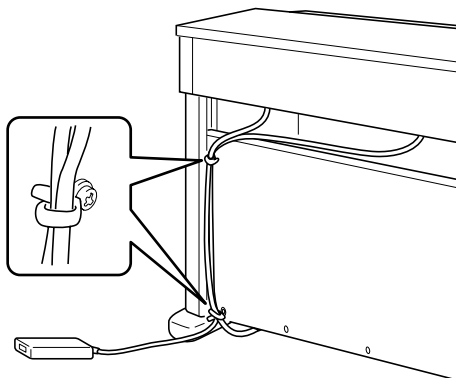

- 4.** Plug the power cord of the AC adaptor that comes with the Digital Piano into a household power outlet as shown in the illustration below.

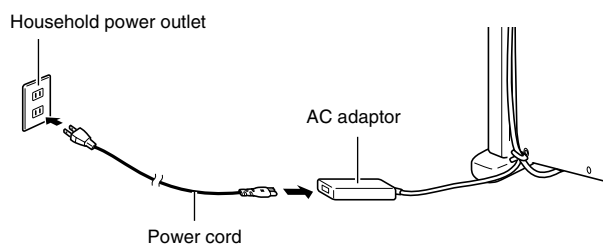

## To install the music stand and headphones hook

- 1.** Install the music stand by inserting its pegs into the holes in the top of the piano.

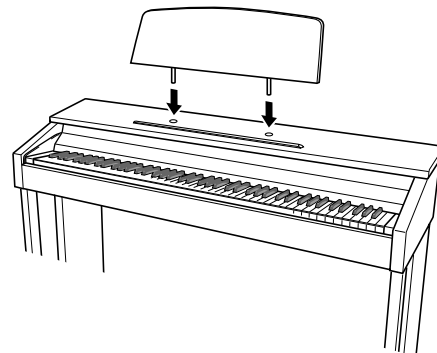

- 2.** Install the headphones hook.

**2-1.** Insert the headphones hook ① into the two holes on the bottom of the piano.

**2-2.** Use screw ② to secure the headphones hook in place.

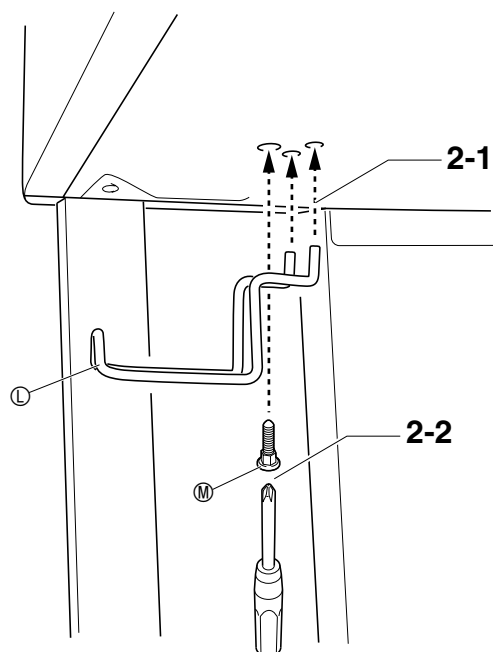

## Power Outlet

Your digital piano runs on standard household power. Be sure to turn off power whenever you are not using the digital piano.

### Using an AC Adaptor

Use only the AC adaptor (JEITA Standard, with unified polarity plug) that comes with this digital piano. Use of a different type of AC adaptor can cause malfunction of the digital piano.

**Specified AC Adaptor: AD-E24250LW**

### ■ About the AC adaptor that comes with the Digital Piano

Note the following important precautions to avoid damage to the AC adaptor and power cord.

- Never pull on the cord with excessive force.
- Never repeatedly pull on the cord.
- Never twist the cord at the base of the plug or connector.
- Before moving the digital piano, be sure to unplug the AC adaptor from the power outlet.
- Loop and bundle the power cord, but never wind it around the AC adaptor.

#### **IMPORTANT!**

- Never connect the AC adaptor that comes with this digital piano to any other device besides this piano. Doing so creates the risk of malfunction.
- Make sure the digital piano is turned off before plugging in or unplugging the AC adaptor.
- The AC adaptor will become warm to the touch after very long use. This is normal and does not indicate malfunction.
- Use the AC adaptor so its label surface is pointed downwards. The AC adaptor becomes prone to emitting electromagnetic waves when the label surface is facing upwards.

## Connecting Headphones

### Bottom

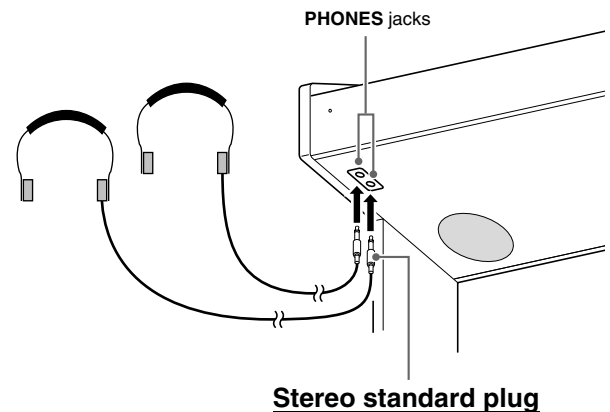

Connect commercially available headphones to the **PHONES** jacks. Connecting headphones to either of the **PHONES** jack cuts off output to the speakers, which means you can practice even late at night without bothering others. To protect your hearing, make sure that you do not set the volume level too high when using headphones.

#### **NOTE**

- Be sure to push the headphones plug into the **PHONES** jacks as far as it will go. If you don't, you may hear sound from only one side of the headphones.
- If the plug of the headphones you are using does not match the **PHONES** jacks, use the applicable commercially available adaptor plug.
- If you are using headphones that require an adaptor plug, make sure you do not leave the adaptor plugged in when you unplug the headphones. If you do, nothing will sound from the speakers when you play.

## Connecting Audio Equipment or an Amplifier

You can connect audio equipment or a music amplifier to the Digital Piano and then play through external speakers for more powerful volume and better sound quality.

### IMPORTANT!

- The Digital Piano automatically adjusts sound output to optimize for headphone output (when headphones are connected) or built-in speaker output (when headphones are not connected). This also will cause a change in the output quality from the Digital Piano's **LINE OUT R** and **L/MONO** jacks.
- Whenever connecting a device to the Digital Piano, first use the **VOLUME** controller to set the volume to a low level. After connecting, you can adjust the volume to the level you want.
- Whenever you connect any device to the Digital Piano, be sure to read the user documentation that comes with the device.

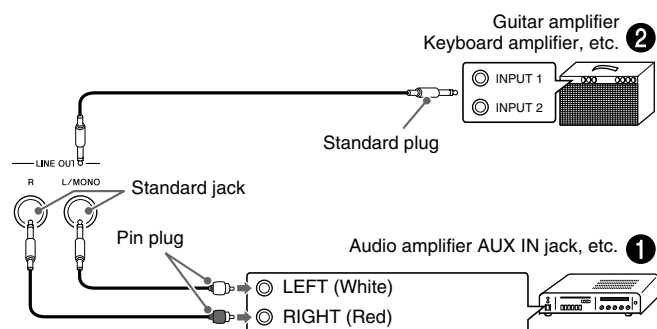

### Connecting to Audio Equipment ①

Use commercially available cables to connect the external audio equipment to the piano's **LINE OUT** jacks as shown in Figure ①. **LINE OUT R** jack output is right channel sound, while **LINE OUT L/MONO** jack output is left channel sound. It is up to you to purchase connecting cables like the ones shown in the illustration for connection of audio equipment. Normally in this configuration you must set the audio equipment's input selector to the setting that specifies the terminal (such as AUX IN) to which the piano is connected. Use the piano's **VOLUME** controller to adjust the volume level.

### Connecting to a Musical Instrument Amplifier ②

Use commercially available cables to connect the amplifier to the piano's **LINE OUT** jacks as shown in Figure ②. **LINE OUT R** jack output is right channel sound, while **LINE OUT L/MONO** jack output is left channel sound. Connecting to the **LINE OUT L/MONO** jack only outputs a mixture of both channels. It is up to you to purchase connecting cable like the one shown in the illustration for connection of the amplifier. Use the piano's **VOLUME** controller to adjust the volume level.

### Bundled and Optional Accessories

Use only accessories that are specified for use with this Digital Piano.

Use of unauthorized accessories creates the risk of fire, electric shock, and personal injury.

### NOTE

- You can get information about accessories that are sold separately for this product from the CASIO catalog available from your retailer, and from the CASIO website at the following URL.

<http://world.casio.com/>

# Reference

## Troubleshooting

Problem	Cause	Action	See Page
No sound is produced when I press a keyboard key.	<ol style="list-style-type: none"> <li>1. The <b>VOLUME</b> controller is set to "MIN".</li> <li>2. Headphones or an adaptor plug is plugged into one of the <b>PHONES</b> jacks.</li> <li>3. MIDI Local control is turned off.</li> </ol>	<ol style="list-style-type: none"> <li>1. Rotate the <b>VOLUME</b> controller more towards "MAX".</li> <li>2. Disconnect whatever is connected to the <b>PHONES</b> jacks.</li> <li>3. Turn on the Local control setting.</li> </ol>	<p>☞ E-5</p> <p>☞ E-36</p> <p>☞ E-20</p>
The pitch of the digital piano is off.	<ol style="list-style-type: none"> <li>1. The digital piano's key setting is something other than "0".</li> <li>2. Digital piano tuning is incorrect.</li> <li>3. Octave shift is enabled.</li> <li>4. A non-standard temperament setting is being used.</li> </ol>	<ol style="list-style-type: none"> <li>1. Change the key setting to "0", or turn digital piano power off and then back on again.</li> <li>2. Adjust digital piano tuning, or turn the digital piano off and then back on again.</li> <li>3. Change the octave shift setting to 0.</li> <li>4. Change the temperament setting to "00: Equal", which is the standard modern tuning.</li> </ol>	<p>☞ E-19</p> <p>☞ E-19</p> <p>☞ E-19</p> <p>☞ E-19</p>
Nothing happens when I press a pedal.	The pedal unit cable is not connected.	Connect the cable correctly.	☞ E-34
Tones and/or effects sound strange. Turning power off and then back on again does not eliminate the problem. <i>Example: Note intensity does not change even though I alter key pressure.</i>	The "Back up" feature is turned on.	Turn off "Back up". Next, turn power off and then back on again.	☞ E-20
I cannot transfer data after connecting the digital piano to a computer.	–	<ol style="list-style-type: none"> <li>1. Check to make sure that the USB cable is connected to the digital piano and computer, and that the correct device is selected with your computer's music software.</li> <li>2. Turn off the digital piano and then exit the music software on your computer. Next, turn the digital piano back on and then restart the music software on your computer.</li> </ol>	☞ E-28
I cannot store data to a memory card or load data from a memory card.	–	See "Error Indicators" on page E-26.	–
It takes a long time before I can use the Digital Piano after I turn it on.	Digital Piano memory data was corrupted because a data transfer operation with a computer was in progress the last time you turned off the piano. When this happens, the Digital Piano performs a memory format operation the next time you turn it on. You cannot perform any other operation while a format operation is in progress.	It takes about 20 seconds after you turn on power to perform the memory format operation. Wait until the format operation is complete. Note that you should take care to avoid turning off the Digital Piano while a data transfer operation with a computer is in progress.	☞ E-29
A tone's quality and volume sounds slightly different depending where it is played on the keyboard.	This is an unavoidable result of the digital sampling process,* and does not indicate malfunction. * Multiple digital samples are taken for the low range, middle range, and high range of the original musical instrument. Because of this, there may be very slight differences in tonal quality and volume between sample ranges.		
When I press a button, the note that is sounding cuts out momentarily or there is a slight change in how effects are applied.	This happens when the sounds of multiple parts are sounding at the same time while using layer, using the Duet Mode, playing back a built-in tune, recording, etc. Pressing a button when one of these conditions exists will cause the effect setting that is built into the tone to change automatically, which causes notes to cut out momentarily or causes a slight change in how effects are being applied.		



## Product Specifications

Model	AP-420BK/AP-420BN
Keyboard	88-key piano keyboard, with Touch Response
Maximum Polyphony	128 notes
Tones	16 <ul style="list-style-type: none"> <li>• Layer (excluding bass tones)</li> <li>• Split (Low-range bass tones only)</li> </ul>
Effects	Brilliance (-3 to 0 to 3), Reverb (4 types), Chorus (4 types), DSP, Acoustic Resonance
Metronome	<ul style="list-style-type: none"> <li>• Beats: 0, 2, 3, 4, 5, 6</li> <li>• Tempo Range: 20 to 255</li> </ul>
Duet	Adjustable tone range (-1 to 2 octaves)
Music Library	<ul style="list-style-type: none"> <li>• Number of Songs: 60, User Songs: 1 (memory capacity; up to 65KB)*</li> <li>* Based on 1 KB = 1024 bytes, 1 MB = 1024<sup>2</sup> bytes</li> <li>• Song volume: Adjustable</li> <li>• Part On/Off: L, R</li> </ul>
Recorder	<ul style="list-style-type: none"> <li>• Functions: Real-time recording, playback</li> <li>• Number of Song: 1</li> <li>• Number of Tracks: 2</li> <li>• Capacity: Approximately 5,000 notes total</li> <li>• Recorded Data Protection: Built-in flash memory</li> </ul>
Pedals	Damper (with half-pedal operation), Soft, Sostenuto
Other Functions	<ul style="list-style-type: none"> <li>• Touch Select: 3 types, Off</li> <li>• Transpose: 2 octaves (-12 to 0 to 12)</li> <li>• Tuning: A4 = 440.0 Hz ±99 cents (variable)</li> <li>• Temperament</li> <li>• Octave shift</li> <li>• Operation Lock</li> </ul>
MIDI	16-channel multi-timbre receive
SD Memory Card	<ul style="list-style-type: none"> <li>• SD memory card slot</li> <li>• Supported SD Memory Cards: Up to 2GB</li> <li>• Functions: SMF playback, file storage, file recall, card format</li> </ul>
Inputs/Outputs	<ul style="list-style-type: none"> <li>• <b>PHONES</b> jacks: Stereo standard jacks × 2</li> <li>• Power: 24V DC</li> <li>• <b>LINE OUT R, L/MONO</b> jacks: Standard jacks × 2 Output impedance: 2.3KΩ Output voltage: 1.1V (RMS) MAX</li> <li>• USB port: TYPE B</li> <li>• Pedal connector</li> </ul>
Speakers	∅ 12cm × 2 + ∅ 5cm × 2 (Output 20W + 20W)
Power Requirements	AC Adaptor: AD-E24250LW
Power Consumption	24V --- 60W
Dimensions	Digital Piano and Stand: 139.5 (W) × 42.7 (D) × 83.5 (H) cm (54 <sup>15</sup> / <sub>16</sub> × 16 <sup>13</sup> / <sub>16</sub> × 32 <sup>14</sup> / <sub>16</sub> inch)
Weight	Digital Piano and Stand: approximately 40.0kg (88.2 lbs)

- Specifications and designs are subject to change without notice.

## Operating Precautions

Be sure to read and observe the following operating precautions.

### ■ Location

Avoid the following locations for this product.

- Areas exposed to direct sunlight and high humidity
- Areas subjected to temperature extremes
- Near a radio, TV, video deck, or tuner

The above devices will not cause malfunction of the product, but the product can cause interference in the audio or video of a nearby device.

### ■ User Maintenance

- Never use benzine, alcohol, thinner, or other chemical agents to clean the product.
- To clean the product or its keyboard, wipe with a soft cloth moistened in a weak solution of water and a mild neutral detergent. Wring all excess moisture from the cloth before wiping.

### ■ Included and Optional Accessories

Use only accessories that are specified for use with this product. Use of unauthorized accessories creates the risk of fire, electric shock, and personal injury.

### ■ Weld Lines

Lines may be visible on the exterior of the product. These are "weld lines" that result from the plastic molding process. They are not cracks or scratches.

### ■ Musical Instrument Etiquette

Always be aware of others around you whenever using this product. Be especially careful when playing late at night to keep the volume at levels that do not disturb others. Other steps you can take when playing late at night are closing the window and using headphones.

- Any reproduction of the contents of this manual, either in part or its entirety, is prohibited. Except for your own, personal use, any other use of the contents of this manual without the consent of CASIO is prohibited under copyright laws.
- IN NO EVENT SHALL CASIO BE LIABLE FOR ANY DAMAGES WHATSOEVER (INCLUDING, WITHOUT LIMITATION, DAMAGES FOR LOSS OF PROFITS, BUSINESS INTERRUPTION, LOSS OF INFORMATION) ARISING OUT OF THE USE OF OR INABILITY TO USE THIS MANUAL OR PRODUCT, EVEN IF CASIO HAS BEEN ADVISED OF THE POSSIBILITY OF SUCH DAMAGES.
- The contents of this manual are subject to change without notice.

### ■ AC Adaptor Handling Precautions

- Use a power outlet that is easily accessible so you can unplug the AC adaptor when a malfunction occurs or whenever else you need to do so.
- The AC adaptor is intended for indoor use only. Do not use it where it might be exposed to splashing or moisture. Do not place any container, such as a flower vase, that contains liquid on the AC adaptor.
- Store the AC adaptor in a dry place.
- Use the AC adaptor in an open, well-ventilated area.
- Never cover the AC adaptor with newspaper, a table cloth, a curtain, or any other similar item.
- Unplug the AC adaptor from the power outlet if you do not plan to use the Digital Piano for a long time.
- Never try to repair the AC adaptor or modify it in any way.
- AC adaptor operating environment  
Temperature: 0 to 40°C  
Humidity: 10% to 90% RH
- Output polarity: 

## AC Adaptor Handling Precautions

### Model: AD-E24250LW

1. Read these instructions.
2. Keep these instructions on hand.
3. Heed all warnings.
4. Follow all instructions.
5. Do not use this product near water.
6. Clean only with a dry cloth.
7. Do not install near radiators, heat registers, stoves, or any other source of heat (including amplifiers).
8. Use only attachments and accessories specified by the manufacturer.
9. Refer all servicing to qualified service personnel. Servicing is required after any of the following occurs: when the product is damaged, when the power supply cord or plug is damaged, when liquid is spilled into the product, when a foreign object falls into the product, when the product is exposed to rain or moisture, when the product does not operate normally, when the product is dropped.
10. Do not allow the product to be exposed to dripping or splashing liquid. Do not place any object containing liquid on the product.
11. Do not allow the electrical load output to exceed the label rating.
12. Make sure the surrounding area is dry before plugging into a power source.
13. Make sure the product is oriented correctly.
14. Unplug the product during lightning storms or when you do not plan to use it for a long time.
15. Do not allow product ventilation openings to become blocked. Install the product in accordance with the manufacturer's instructions.
16. Take care the power cord is located where it will not be stepped upon or bent severely, particularly in locations close to plugs and convenience receptacles, and in locations where it exits from the product.
17. The AC adaptor should be plugged into a power outlet as close to the product as possible to allow immediate disconnection of the plug in case of emergency.

The symbol below is an alert indicating un-insulated hazardous voltage inside the product's enclosure, which may be sufficient to constitute the risk of electric shock to users.



The symbol below is an alert indicating the presence of important operating and maintenance (servicing) instructions in the documentation that accompanies the product.



# Appendix/Apéndice

## Tone List/Lista de tonos

Tone Name/ Nombre de tonos	Program Change/ Cambio de programa	Bank Select MSB/ MSB de selección de banco
GRAND PIANO MODERN	0	2
GRAND PIANO CLASSIC	0	1
GRAND PIANO VARIATION	0	0
ELEC PIANO	4	0
FM E.PIANO	5	0
60'S E.PIANO	4	1
HARPSICHORD	6	0
VIBRAPHONE	11	0
PIPE ORGAN	19	0
JAZZ ORGAN	17	0
ELEC ORGAN 1	16	0
ELEC ORGAN 2	16	1
STRINGS 1	49	0
STRINGS 2	48	0
BASS (LOWER) 1	32	0
BASS (LOWER) 2	32	1

## Song List/Lista de canciones

No./Nº	Song Name/Nombre de canciones
01	Nocturne Op.9-2
02	Fantaisie-Improptu Op.66
03	Étude Op.10-3 "Chanson de l'adieu"
04	Étude Op.10-5 "Black Keys"
05	Étude Op.10-12 "Revolutionary"
06	Étude Op.25-9 "Butterflies"
07	Prélude Op.28-7
08	Valse Op.64-1 "Petit Chien"
09	Valse Op.64-2
10	Moments Musicaux 3
11	Improptu Op.90-2
12	Marche Militaire 1 (Duet)
13	Frühlingslied [Lieder Ohne Worte Heft 5]
14	Fröhlicher Landmann [Album für die Jugend]
15	Von fremden Ländern und Menschen [Kinderszenen]
16	Träumerei [Kinderszenen]
17	Tambourin
18	Menuet BWV Anh.114 [Clavierbüchlein der Anna Magdalena Bach]
19	Inventio 1 BWV 772
20	Inventio 8 BWV 779
21	Inventio 13 BWV 784
22	Praeludium 1 BWV 846 [Das Wohltemperierte Klavier 1]
23	Le Coucou
24	Gavotte
25	Sonatina Op.36-1 1st Mov.
26	Sonatine Op.20-1 1st Mov.
27	Sonate K.545 1st Mov.
28	Sonate K.331 3rd Mov. "Turkish March"
29	Rondo K.485
30	Für Elise
31	Marcia alla Turca
32	Sonate Op.13 "Pathétique" 1st Mov.
33	Sonate Op.13 "Pathétique" 2nd Mov.
34	Sonate Op.13 "Pathétique" 3rd Mov.
35	Sonate Op.27-2 "Moonlight" 1st Mov.
36	Rhapsodie 2
37	Waltz Op.39-15 (Duet)
38	Liebesträume 3
39	Blumenlied
40	La Prière d'une Vierge
41	Csikos Post
42	Humoresque Op.101-7
43	Melodie [Lyrische Stücke Heft 2]
44	Sicilienne Op.78
45	Berceuse [Dolly] (Duet)
46	Arabesque 1
47	La Fille aux Cheveux de Lin [Préludes]
48	Passepied [Suite bergamasque]
49	Gymnopédie 1
50	Je Te Veux
51	Salut d'Amour
52	The Entertainer
53	Maple Leaf Rag
54	L'arabesque [25 Étüden Op.100]
55	La Styrienne [25 Étüden Op.100]
56	Ave Maria [25 Étüden Op.100]
57	Le retour [25 Étüden Op.100]
58	La chevaleresque [25 Étüden Op.100]
59	No.13 [Études de Mécanisme Op.849]
60	No.26 [Études de Mécanisme Op.849]





This recycle mark indicates that the packaging conforms to the environmental protection legislation in Germany.

Esta marca de reciclaje indica que el empaquetado se ajusta a la legislación de protección ambiental en Alemania.

**CASIO®**

## Free Manuals Download Website

<http://myh66.com>

<http://usermanuals.us>

<http://www.somanuals.com>

<http://www.4manuals.cc>

<http://www.manual-lib.com>

<http://www.404manual.com>

<http://www.luxmanual.com>

<http://aubethermostatmanual.com>

Golf course search by state

<http://golfingnear.com>

Email search by domain

<http://emailbydomain.com>

Auto manuals search

<http://auto.somanuals.com>

TV manuals search

<http://tv.somanuals.com>