

# EXILIM

E

Digital Camera

## ***EX-S20/EX-M20***

### **User's Guide**

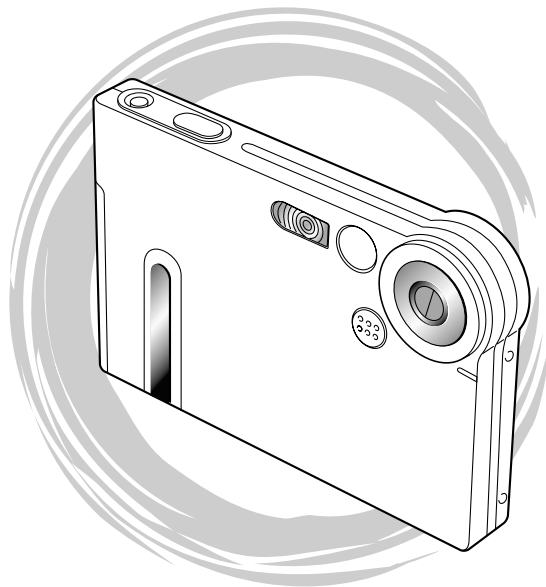

EX-M20

Thank you for purchasing this CASIO Product.

- Before using it, be sure to read the precautions contained in this User's Guide.
- Keep the User's Guide in a safe place for future reference.
- For the most up-to-date information about this product, visit the official Exilim Website at <http://www.exilim.com/>.

K858PCM1DMX

# CASIO®

# INTRODUCTION

## Unpacking

Check to make sure that all of the items shown below are included with your camera. If something is missing, contact your dealer as soon as possible.

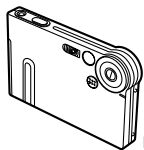

EX-M20

Camera

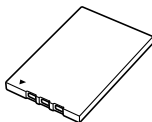

Rechargeable lithium ion battery  
(NP-20)

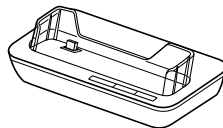

USB Cradle (CA-23)

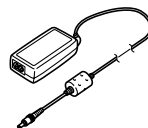

Special AC Adaptor  
(AD-C51G)

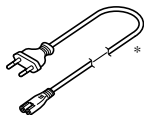

\* The shape of the AC power cord plug varies according to country or geographic area.

AC power cord \*

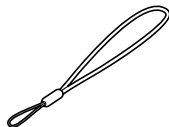

Strap



CD-ROM

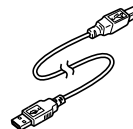

USB Cable



\* Comes with EX-M20 only

LCD Remote Controller

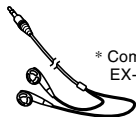

\* Comes with EX-M20 only

Stereo Headphones



Basic Reference

## Contents

**2 INTRODUCTION**

Unpacking .....	2
Features .....	9
Precautions .....	11
General Precautions .....	11
Data Error Precautions .....	13
Operating conditions .....	13
Condensation .....	14
Lens .....	14
Other .....	15

**16 QUICK START GUIDE**

First, charge the battery! .....	16
To configure display language and clock settings .....	17
To record an image .....	18
To view a recorded image .....	18
To delete an image .....	19

**20 GETTING READY**

About This Manual .....	20
General Guide .....	21
Camera .....	21
USB Cradle .....	22
Monitor Screen Contents .....	23
REC mode .....	23
PLAY mode .....	24
Changing the Contents of the Monitor Screen .....	25
Indicator Lamps .....	25
Attaching the Strap .....	26
Power Requirements .....	26
To load the battery .....	26
To charge the battery .....	28
Power Supply Precautions .....	32
Turning the Camera On and Off .....	35
Auto Power Off (APO) .....	36
Using the On-screen Menus .....	37
Configuring Display Language and Clock Settings ...	39
To configure display language and clock settings .....	40

## INTRODUCTION

### 43 BASIC IMAGE RECORDING

Recording an Image .....	43
Aiming the Camera .....	43
Recording an Image .....	44
About the REC Mode Monitor Screen .....	45
Recording Precautions .....	45
Using Zoom .....	46
Using the Flash .....	47
Flash Precautions .....	49
Recording Macro Images .....	50
Using the Self-timer .....	51
Specifying Image Size and Quality .....	52
To specify the image size .....	52
To specify image quality .....	53

### 55 OTHER RECORDING FUNCTIONS

Exposure Compensation (EV Shift) .....	55
Adjusting White Balance .....	56
Adjusting White Balance Manually .....	57
Using the BESTSHOT Mode .....	58
Creating Your Own BESTSHOT Setup .....	60
Combining Shots of Two People into a Single Image (Coupling Shot) .....	62
Recording a Subject onto an Existing Background Image (Pre-shot) .....	64

Using the Movie Mode .....	66
Recording Audio (EX-M20 Only) .....	67
Adding Audio to a Snapshot .....	67
Recording Your Voice .....	69
Using the Histogram .....	70
REC Mode Camera Settings .....	72
Specifying ISO Sensitivity .....	72
Turning the On-screen Grid On and Off .....	73
Turning Image Review On and Off .....	73
Assigning Functions to the [◀] and [▶] Keys .....	74
Assigning Functions to the [▲] and [▼] Keys .....	75
Specifying Power On Default Settings .....	76
Resetting the Camera .....	77

### 78 PLAYBACK

Basic Playback Operation .....	78
Playing an Audio Snapshot (EX-M20 Only) .....	79
Flipping the Display .....	80
Zooming the Display Image .....	81
Resizing an Image .....	82
Cropping an Image .....	83
Playing a Movie .....	84
Displaying the Calendar Screen .....	86

## INTRODUCTION

Playing a Slide Show .....	87
To specify the slideshow images .....	88
To specify the slideshow time .....	89
To set the slideshow interval .....	90
Using the Photo Stand Feature .....	90
Rotating the Display Image .....	91
Using Image Roulette .....	92
Adding Audio to a Snapshot (EX-M20 Only) .....	93
To re-record audio .....	94
Playing Back a Voice Recording File (EX-M20 Only) .....	95

## 97 DELETING FILES

Deleting a Single File .....	97
Deleting All Files .....	98

## 99 FILE MANAGEMENT

Folders .....	99
Memory Folders and Files .....	99
Protecting Files .....	100
To protect a single file .....	100
To protect all files in memory .....	101
DPOF .....	101
To configure print settings for a single image .....	102
To configure print settings for all images .....	103

PRINT Image Matching II .....	104
Exif Print .....	104
Using USB DIRECT-PRINT .....	105
Using the FAVORITE Folder .....	107
To copy a file to the FAVORITE folder .....	107
To display a file in the FAVORITE folder .....	108
To delete a file from the FAVORITE folder .....	109
To delete all files from the FAVORITE folder .....	110

## 111 OTHER SETTINGS

Turning the Key Tone On and Off (EX-S20) .....	111
Configuring Sound Settings (EX-M20) .....	111
To configure sound settings .....	111
To set the volume level .....	112
Specifying an Image for the Startup Screen .....	113
Configuring Power Down Image Settings .....	114
Specifying the File Name Serial Number Generation Method .....	116
Using the Alarm .....	117
To set an alarm .....	117
Stopping the Alarm .....	118
Setting the Clock .....	118
To select your Home Time zone .....	118
To set the current time and date .....	119
Changing the Date Format .....	120

## INTRODUCTION

Using World Time .....	120
To display the World Time screen	120
To configure World Time settings	121
To configure summer time (DST) settings	122
Changing the Display Language .....	123
Formatting Built-in Memory .....	123

## 125 USING A MEMORY CARD

Using a Memory Card .....	126
To insert a memory card into the camera	126
To remove a memory card from the camera	126
Formatting a Memory Card	127
Memory Card Precautions	128
Copying Files .....	129
To copy all the files in built-in memory to a memory card	129
To copy a file from a memory card to built-in memory	130

## 131 VIEWING IMAGES ON A COMPUTER

Using the Camera with a Windows Computer .....	131
USB Connection Precautions	136
Using the Camera with a Macintosh Computer .....	136
USB Connection Precautions	140
Operations You Can Perform from Your Computer ...	140
Using a Memory Card to Transfer Images to a Computer .....	141

Memory Data .....	142
DCF Protocol	142
Memory Directory Structure	142
Image Files Supported by the Camera	144
Built-in Memory and Memory Card Precautions	144

## 145 USING THE CAMERA WITH A COMPUTER

Using the Album Feature .....	145
Creating an album	145
Selecting an Album Layout	146
Configuring Detailed Album Settings	147
Viewing Album Files	149
Saving an Album	152
Installing the Software from the CD-ROM .....	152
About the bundled CD-ROM	152
Computer System Requirements	153
Installing Software from the CD-ROM in Windows ...	154
Getting Started	154
Selecting a Language	154
Viewing the Contents of the "Read me" File	155
Installing an Application	155
Viewing User Documentation (PDF Files)	156
User Registration	156
Exiting the Menu Application	156
Installing Software from the CD-ROM on a Macintosh .....	157
Installing Software	157
Viewing User Documentation (PDF Files)	158

## INTRODUCTION

### 159 PLAYING AN AUDIO FILE (EX-M20 Only)

Transferring Audio Files to the Camera .....	159
Preparing the Camera for Audio Player Operation ...	160
Using the Camera as an Audio Player .....	161
General Guide .....	161
Basic Remote Controller Operations .....	163
Playing Back Audio Files .....	164
Specifying the Audio Playback Mode .....	164
Playing Back Tracks Randomly .....	164
Selecting a Specific Track for Playback .....	165
Specifying the Track Playback Sequence .....	166
Using BASS BOOST .....	168
Deleting MP3 Files from File Memory .....	169
Deleting a Single MP3 File .....	170
Deleting All MP3 Files .....	171
Disabling Remote Controller Button Operations .....	171
LCD Remote Control Error Messages .....	172
Audio Playback Precautions .....	172

### 173 APPENDIX

Menu Reference .....	173
Indicator Lamp Reference .....	175
Camera Indicator Lamps .....	175
USB Cradle Indicator Lamps .....	177
Troubleshooting Guide .....	178
Display Messages .....	181
Specifications .....	182
Main Specifications .....	182

## INTRODUCTION

### ►► IMPORTANT! ◀◀

- The contents of this manual are subject to change without notice.
- CASIO COMPUTER CO., LTD. assumes no responsibility for any damage or loss resulting from the use of this manual.
- CASIO COMPUTER CO., LTD. assumes no responsibility for any loss or claims by third parties which may arise through the use of the EX-S20/EX-M20.
- CASIO COMPUTER CO., LTD. shall not be held liable for any damages or losses suffered by you or any third party due to the use of Photo Loader and/or Photohands.
- CASIO COMPUTER CO., LTD. assumes no responsibility for any damage or loss caused by deletion of data as a result of malfunction, repairs, or battery replacement. Be sure to back up all important data on other media to protect against its loss.
- *The SD logo is a registered trademark.*
- *Windows, Internet Explorer, and DirectX are registered trademarks of Microsoft Corporation.*
- *Macintosh is a registered trademark of Apple Computer, Inc.*
- *MultiMediaCard is a trademark of Infineon Technologies AG of Germany, and licensed to the MultiMediaCard Association (MMCA).*
- *Acrobat and Acrobat Reader are trademarks of Adobe Systems Incorporated.*

- *The USB driver (mass storage) uses Phoenix Technologies Ltd. software.  
Compatibility Software Copyright © 1997  
Phoenix Technologies Ltd., All Rights Reserved.*
- *MPEG Layer-3 audio decoding technology licensed from Fraunhofer IIS and Thomson Multimedia.*
- *Other company, product and service names used herein may also be trademarks or service marks of others.*
- *Photo Loader and Photohands are the property of CASIO COMPUTER CO., LTD. Except as stipulated above, all copyrights and other related rights to these applications revert to CASIO COMPUTER CO., LTD.*

### ■ Copyright Restrictions

Except for the purposes of your own personal enjoyment, unauthorized copying of snapshot files, movie files, audio files, and music files violates copyright laws and international contracts. Distribution to third parties of such files over the Internet without permission of the copyright holder, whether for profit or for free, violates copyright laws and international contracts.



### Features

- **2.0 million Effective Pixels**  
A high-resolution megapixel CCD provides 2.0 million effective pixels (2.11 million total pixels) for images that print beautifully.
- **Fixed focus lens for quick operation**  
Fixed focus eliminates the need for lens movement, which shortens startup time and shooting time.
- **Macro Function**  
Text images come out clear and easy-to read.
- **Compact electric lens barrier**  
Protects the lens against damage.
- **1.6-inch TFT color LCD monitor screen**
- **4X digital zoom**
- **10MB Flash memory**  
Images can be recorded without using a memory card.
- **Support for SD memory cards and MMC (MultiMedia Cards) for memory expansion**
- **Easy Charging**  
Just place the camera onto the USB cradle to charge its battery.
- **Easy Image Transfer**  
Transfer images to a computer simply by placing the camera onto the USB cradle.
- **Photo Stand feature**  
A slideshow of images in file memory can be played while the camera is on its USB cradle.
- **BESTSHOT**  
Simply select the sample scene that matches the type of image you are trying to record and the camera performs troublesome setups automatically for beautiful pictures every time.
- **Coupling Shot and Pre-shot**  
Coupling Shot lets you combine two subjects into a single image, while Pre-shot lets you add a subject to a previously recorded background image. This means you can create images that include you and your friend, even if you are the only two people around. You can use Coupling Shot and Pre-shot by selecting the applicable sample images in the BESTSHOT mode.
- **Image Roulette Feature**  
Images cycle like a slot machine on the display until one of them remains.
- **Triple Self-timer mode**  
The self-timer can be set up to repeat three times, automatically.

## INTRODUCTION

- **Real-time histogram**  
An on-screen histogram lets you adjust exposure as you view the effect on overall image brightness, which makes shooting under difficult lighting conditions easier than ever before.
- **World Time**  
A simple operation sets the current time for your current location. You can select from among 162 cities in 32 time zones.
- **Alarm**  
A built-in alarm helps to keep you on time for important events, and even can be used in place of an alarm clock. You can also have a specific image appear on the monitor screen when the alarm time is reached.
- **Album Function**  
HTML files are generated automatically to create an album of recorded images. Album contents can be viewed and printed using a standard Web browser. Images can also be incorporated into Web pages quickly and easily.
- **Calendar screen**  
A simple operation displays a full-month calendar on the camera's monitor screen. Each day of the full-month calendar shows a thumbnail of the first image recorded for that date, which helps to make searching for a particular image quicker and easier.
- **DCF Data Storage**  
DCF (Design rule for Camera File system) data storage protocol provides image inter-compatibility between the digital camera and printers.
- **Digital Print Order Format (DPOF)**  
Images can be printed easily in the sequence you want using a DPOF compatible printer. DPOF can also be used when specifying images and quantities for printing by professional print services.
- **PRINT Image Matching II Compatible**  
Images include PRINT Image Matching II data (mode setting and other camera setup information). A printer that supports PRINT Image Matching II reads this data and adjusts the printed image accordingly, so your images come out just the way you intended when you recorded them.
- **USB DIRECT-PRINT support**  
Your camera supports USB DIRECT-PRINT, which was developed by Seiko Epson Corporation. When connected directly to a printer that supports USB DIRECT-PRINT, you can select images to print and start the print operation directly from the camera.
- **Bundled with Photo Loader and Photohands**  
Your camera comes bundled with Photo Loader, the popular application that automatically loads images from your camera to your PC. Also included is Photohands, an application that makes image retouching quick and easy.

## INTRODUCTION

### \* EX-M20 Only

- Snapshot + Audio Mode  
Adds audio to a snapshot.
- Movie + Audio Mode
- Voice Recording  
Quick and easy recording of voice input.
- After Recording  
Adds audio to images after they are recorded.
- Audio Player Capabilities  
Use the camera to play back music data from standard MP3 (MPEG-1 Audio Layer-3/MPEG-2 Audio Layer-3) files.
- Selectable Sound Settings  
You can configure different sounds to play whenever you turn on the camera, press the shutter release button, or perform a key operation.

## Precautions

### General Precautions

Be sure to observe the following important precautions whenever using the EX-S20/EX-M20.

All references in this manual to “this camera” and “the camera” refer to the CASIO EX-S20/EX-M20 Digital Camera.

- Never try to take pictures or use the built-in display while operating a motor vehicle or while walking. Doing so creates the danger of serious accident.
- Never try to open the case of the camera or attempt your own repairs. High-voltage internal components create the risk of electric shock when exposed. Always leave maintenance and repair work up to a CASIO authorized service center.
- Never look at the sun or any other bright light through the camera’s viewfinder. Doing so can damage your eyesight.
- Keep the small parts and accessories of this camera out of the reach of small children. If swallowed accidentally, contact your physician immediately.
- Never fire the flash in the direction of a person operating a motor vehicle. Doing so can interfere with the driver’s vision and create the danger of accident.

## INTRODUCTION

- Never fire the flash while it is too close to the subject's eyes. Intense light from the flash can cause eye damage if it is fired too close to the eyes. This is especially true with young children. When using the flash, the camera should be at least one meter (3.3') from the eyes of the subject.
- Keep the camera away from water and other liquids, and never let it get wet. Moisture creates the danger of fire and electric shock. Never use the camera outdoors in the rain or snow, at the seashore or beach, in the bathroom, etc.
- Should foreign matter or water ever get into the camera, immediately turn it off. Next, remove the camera's battery and/or unplug the AC adaptor power cord from the power outlet, and contact your dealer or nearest CASIO authorized service center. Using the camera under these conditions creates the danger of fire and electric shock.
- Should you ever notice smoke or a strange odor coming out of the camera, immediately turn it off. Next, taking care you do not burn your fingers, remove the camera's battery and/or unplug the AC adaptor power cord from the power outlet, and contact your dealer or nearest CASIO authorized service center. Using the camera under these conditions creates the danger of fire and electric shock. After making sure there is no more smoke coming from the camera, take it to your nearest CASIO authorized service center for repair. Never attempt your own maintenance.
- Never use the AC adaptor to power any other device besides this camera. Never use any other AC adaptor besides the one that comes with this camera.
- Never cover the AC adaptor with a quilt, blanket, or other cover while it is in use, and do not use it near a heater.
- At least once a year, unplug the AC adaptor power cord from the power outlet and clean the area around the prongs of the plug. Dust build up around the prongs can create the danger of fire.
- If the camera's case should ever become cracked due to dropping it or otherwise subjecting it to rough treatment, immediately turn it off. Next, remove the camera's battery and/or unplug the AC adaptor power cord from the power outlet, and contact your dealer or nearest CASIO authorized service center.
- Never use the camera inside of an aircraft or in any other areas where its use is prohibited. Doing so can result in an accident.
- Physical damage and malfunction of this camera can cause the data stored in its memory to be deleted. Be sure to always keep backup copies of data by transferring them to personal computer memory.
- Never open the battery cover, disconnect the AC adaptor from the camera, or unplug the AC adaptor from the wall socket while recording images. Doing so will not only make storage of the current image impossible, it can also corrupt other image data already stored in file memory.

### Data Error Precautions

- Your digital camera is manufactured using precision digital components. Any of the following creates the risk of corruption of data in file memory.
  - Removing the battery or memory card, or setting the camera onto the USB cradle while the camera is performing a record or memory access operation
  - Removing the battery, removing the memory card, or placing the camera onto the USB cradle while the operation/flash charge lamp is still flashing after you turn off the camera
  - Disconnecting the USB cable, removing the camera from the USB cradle, or disconnecting the AC adaptor from the USB cradle while a data communication operation is being performed
  - Using low battery
  - Other abnormal operations

Any of the above conditions can cause an error message to appear on the monitor screen (page 181). Follow the instructions provided by the message to eliminate the cause of the error.

### Operating conditions

- This camera is designed for use in temperatures ranging from 0°C to 40°C (32°F to 104°F).
- Do not use or keep the camera in the following areas.
  - In areas subject to direct sunlight
  - In areas subject to high humidity or dust
  - Near air conditioners, heaters, or other areas subject to temperature extremes
  - Inside of a closed vehicle, especially one parked in the sun
  - In areas subject to strong vibration

### Condensation

- When you bring the camera indoors on a cold day or otherwise expose it to a sudden change of temperature, there is the possibility that condensation can form on the exterior or on interior components. Condensation can cause malfunction of the camera, so you should avoid exposing it to conditions that might cause condensation.
- To keep condensation from forming, place the camera into a plastic bag before moving it into a location that is much warmer or colder than your current location. Leave it in the plastic bag until the air inside the bag has a chance to reach the same temperature as the new location. If condensation does form, remove the battery from the camera and leave the battery cover open for a few hours.

### Lens

- Never apply too much force when cleaning the surface of the lens. Doing so can scratch the lens surface and cause malfunction.
- Fingerprints, dust, or any other soiling of the lens can interfere with proper image recording. Never touch the lens with your fingers. You can remove dust particles from the lens surface by using a lens blower to blow them off. Next, wipe the surface of the lens with a soft lens cloth.

### Other

- Take care never to sit down with the camera in the pocket of your slacks or otherwise subject the camera to severe stress. Doing so can crack the LCD monitor screen.
- The camera may become slightly warm during use. This does not indicate malfunction.
- If the exterior of the camera needs cleaning, wipe it with a soft, dry cloth.

# QUICK START GUIDE

First, charge the battery!

## 1. Load the battery (page 26).

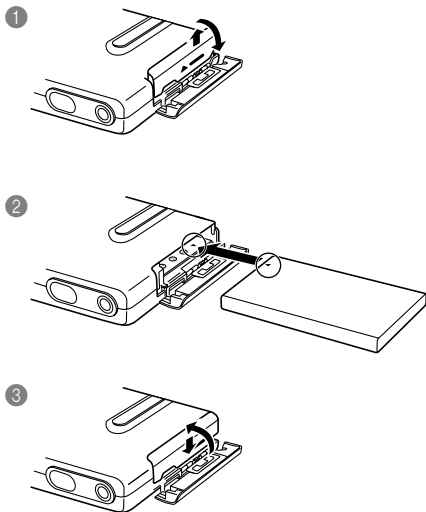

## 2. Place the camera onto the USB cradle to charge the battery (page 28).

- It takes about two hours to achieve a full charge.

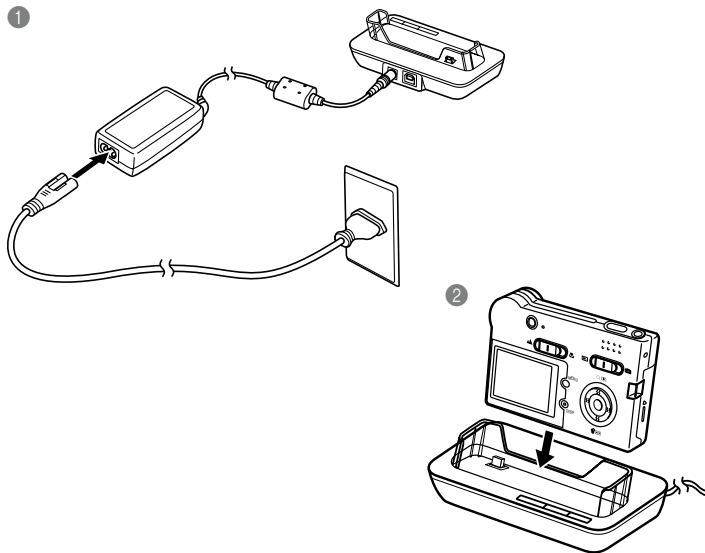



### To configure display language and clock settings

#### ►► IMPORTANT! ◀◀

- Be sure to configure the following settings before using the camera to record images (See page 40 for details).

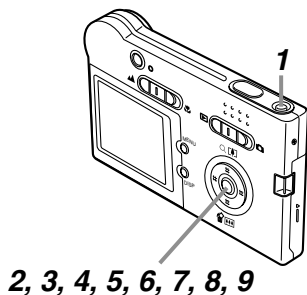

1. Press the power button to turn on the camera.
2. Press [▲], [▼], [◀], and [▶] to select the language you want.
3. Press [SET] to register the language setting.
4. Use [▲], [▼], [◀], and [▶] to select the geographical area you want, and then press [SET].
5. Use [▲] and [▼] to select the city you want, and then press [SET].
6. Use [▲] and [▼] to select the summer time (DST) setting you want, and then press [SET].
7. Use [▲] and [▼] to select the date format setting you want, and then press [SET].
8. Set the date and the time.
9. Press [SET] to register the clock settings and exit the setting screen.

### To record an image

(See page 44 for details.)

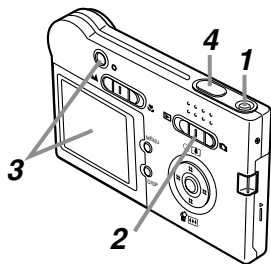

1. Press the power button to turn on the camera.
2. Align the mode selector with “” (REC).
3. Point the camera at the subject, use the monitor screen or viewfinder to compose the image.
4. Holding the camera still, gently press the shutter release button.

### To view a recorded image

(See page 78 for details.)

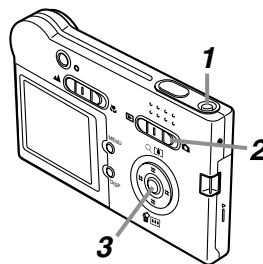

1. Press the power button to turn on the camera.
2. Align the mode selector with “” (PLAY).
3. Use [◀] and [▶] to scroll through the images on the monitor screen.

## To delete an image

(See page 97 for details.)

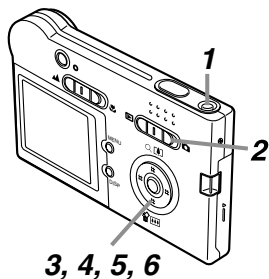

- 1. Press the power button to turn on the camera.**
- 2. Align the mode selector with “▶” (PLAY).**
- 3. Press [▼] (⏏).**
- 4. Use [◀] and [▶] to display the image you want to delete.**
- 5. Use [▲] and [▼] to select “Delete”.**
  - To exit the image delete operation without deleting anything, select “Cancel”.
- 6. Press [SET] to delete the image.**

# GETTING READY

This section contains information about things you need to know about and do before trying to use the camera.

## About This Manual

This section contains information about the conventions used in this manual.

## Terminology

The following table defines the terminology used in this manual.

This term as used in this manual:	Means this:
"this camera" or "the camera"	The CASIO EX-S20/EX-M20 Digital Camera
"file memory"	The location where the camera is currently storing images you record (page 44)
"battery"	The NP-20 Rechargeable Lithium Ion Battery
"optional charger unit"	The optionally available CASIO BC-10L Charger Unit

## Button Operations

Button operations are indicated by the button name inside of brackets ([ ]).

## On-screen Text

On-screen text is always enclosed by double quotation marks (" ").

## File Memory

The term "file memory" in this manual is a general term that refers to the location where your camera is currently storing the images you record. File memory can be any one of the following three locations.

- The camera's built-in Flash memory
- An SD memory card loaded in the camera
- A MultiMediaCard loaded in the camera

For more information about how the camera stores images, see page 99.

## General Guide

The following illustrations show the names of each component, button, and switch on the camera.

- All the illustrations in this manual show the EX-M20. See the text that accompanies the illustrations for information about how the EX-S20 and EX-M20 differ from each other.

## Camera

### ■ Front

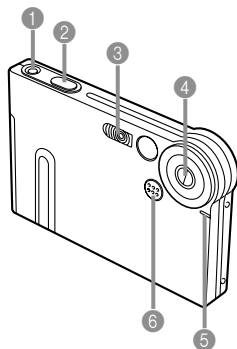

- 1 Power button
- 2 Shutter release button
- 3 Flash
- 4 Lens
- 5 Self-timer lamp
- 6 Microphone (EX-M20 only)

### ■ Back

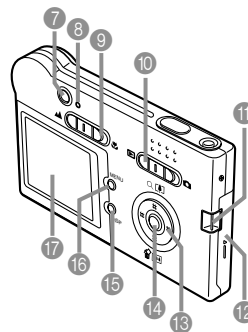

- 7 Viewfinder
- 8 Operation/Flash charge lamp
- 9 Normal (▲) / Macro (▼) selector
- 10 Mode selector
- 11 Strap bar
- 12 Battery cover
- 13 [▲][▼][◀][▶]
- 14 [SET] button
- 15 [DISP] button
- 16 [MENU] button
- 17 Monitor Screen

## GETTING READY

### Bottom

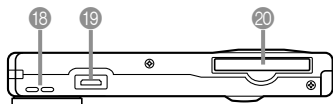

- 18 Speaker (EX-M20 only)
- 19 Connector
- 20 Memory card slot

### USB Cradle

Simply placing your CASIO digital camera onto the USB cradle lets you perform the following tasks.

- Battery charging (page 28)
- Automatic transfer of images to a computer (page 131)
- Viewing of images using the Photo Stand slideshow feature (page 90).

### Front

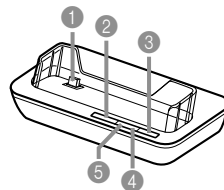

- 1 Camera connector
- 2 [PHOTO] button
- 3 [USB] button
- 4 [USB] lamp
- 5 [CHARGE] lamp

### Back

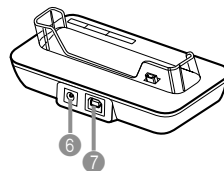

- 6 [DC IN 5.3V]  
(AC adaptor connector)
- 7 [USB]  
(USB port)

### NOTE

- See "Using the Camera as an Audio Player" on page 161 for information about the LCD remote controller that comes with the EX-M20.

## Monitor Screen Contents

The monitor screen uses various indicators and icons to keep you informed of the camera's status.

### REC mode

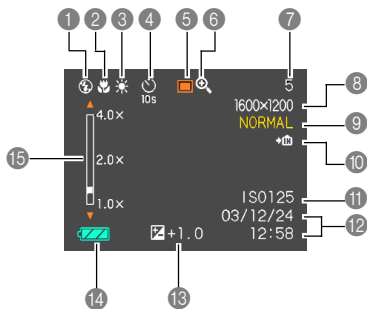

#### 1 Flash Mode indicator

- None
- Auto
- Flash Off
- Flash On
- Red-eye reduction

#### 2 Focus Mode indicator

- None
- Normal
- Macro

#### 3 White balance indicator

- None
- Auto
- Sunlight
- Shade
- Light Bulb
- Fluorescent
- Manual

#### 4 Self-timer

- None
- 1-Image
- Self-timer 10 sec
- Self-timer 2 sec
- Triple self-timer

#### 5 REC modes

- Snapshot
- BESTSHOT
- Movie
- Snapshot Audio (EX-M20 only)
- Voice Recording (EX-M20 only)

#### 6 Digital zoom indicator

#### 7 Memory capacity (Remaining number of storable images)

#### 8 Image size

- 1600 × 1200 pixels
- 1600 × 1072 pixels
- 1280 × 960 pixels
- 640 × 480 pixels
- Movie Recording: recording time (seconds)

#### 9 Quality

- FINE
- NORMAL
- ECONOMY

#### 10 Built-in memory selected for data storage. Memory card selected for data storage.

#### 11 ISO sensitivity

#### 12 Date and time

#### 13 EV value



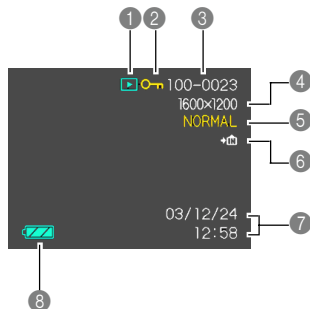

#### 14 Battery capacity

#### 15 Digital zoom factor

## PLAY mode



## 1 PLAY mode file type

-  Snapshot
-  Movie
-  Snapshot Audio (EX-M20 only)
-  Voice Recording (EX-M20 only)

## 2 Image protection indicator



## 3 Folder number/File number

## 4 Image size

- 1600 × 1200 pixels
- 1600 × 1072 pixels
- 1280 × 960 pixels
- 640 × 480 pixels

## 5 Quality

- FINE
- NORMAL
- ECONOMY

- 6  Built-in memory selected for data storage.
-  Memory card selected for data storage.

## 7 Date and time

## 8 Battery capacity

## ▶▶ IMPORTANT! ◀◀

- Some information may not display properly if you display an image that was recorded using a different digital camera model.



## Changing the Contents of the Monitor Screen

Each press of the [DISP] button changes the contents of the monitor screen as shown below.

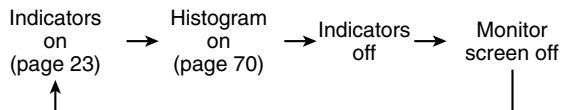

### ▶▶ IMPORTANT! ◀◀

- You cannot turn off the monitor screen in the following cases:  
In the PLAY mode, in the BESTSHOT mode, when not recording in the Movie mode
- You cannot use the [DISP] button to change the contents of the monitor screen while a movie is being recorded, or while standing by for or performing audio recording.
- In the Voice Recording mode, you can only turn indicators on and off.

## Indicator Lamps

You can find out the operational status of the camera and the USB cradle at a glance by checking the color of the indicator lamps, and whether a lamp is lit or flashing. For details, see “Indicator Lamp Reference” on page 175.

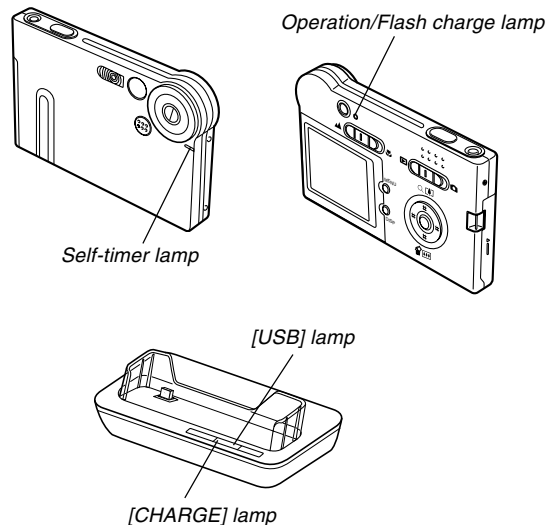

## GETTING READY

### Attaching the Strap

Attach the strap to the strap bar as shown in the illustration.

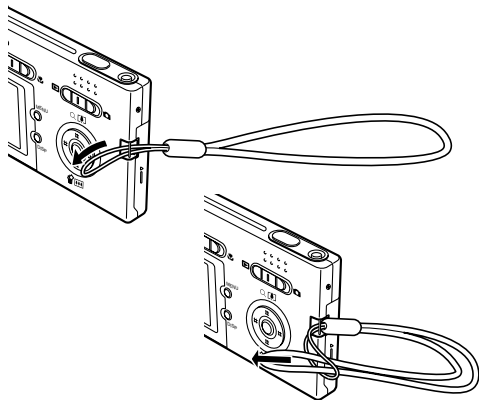

### ►► IMPORTANT! ◀◀

- Be sure to keep the strap around your wrist when using the camera to protect against accidentally dropping it.
- The supplied strap is intended for use with this camera only. Do not use it for any other purpose.
- Never swing the camera around by the strap.

### Power Requirements

Your camera is powered by a rechargeable lithium ion battery (NP-20).

### To load the battery

1. Pressing the battery cover on the side of the camera, slide it in the direction indicated by the ▲ mark and then swing it open.

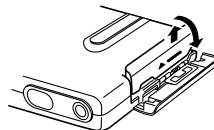

## GETTING READY

- Align the arrow mark on the battery with the arrow mark on the camera as shown in the illustration, and slide the battery into the battery compartment.

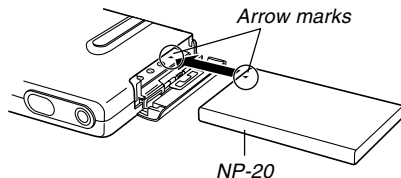

- Swing the battery cover closed, and then slide it in the direction indicated by the arrow while pressing down on it.

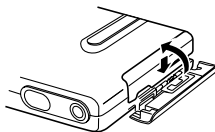

### IMPORTANT!

- Use only the special NP-20 rechargeable lithium ion battery to power this camera. Use of any other type of battery is not supported.

### NOTE

- To remove the battery, open the battery cover. Taking care that the battery does not suddenly fall out of the camera, tilt the camera towards the side. When the battery slides out part way, pull it out by hand.

The battery is not charged when you purchase the camera. You need to charge the battery before using the camera for the first time.

## To charge the battery

1. Connect the AC power cord to the bundled AC adaptor.
2. Plug the other end of the AC power cord into a household power outlet.
3. Connect the AC adaptor to the [DC IN 5.3V] connector of the USB cradle.

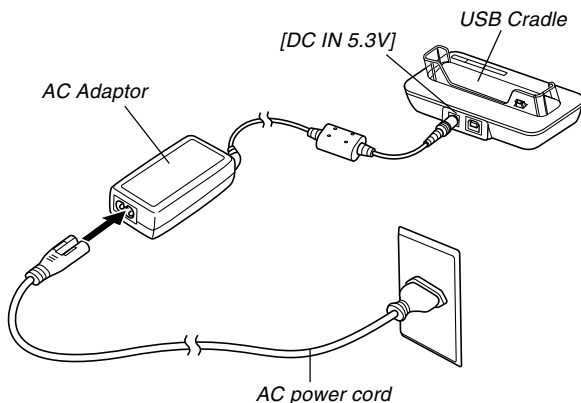

## 4. Turn off the camera.

## 5. Set the camera onto the USB cradle.

- Do not place the camera onto the USB cradle while it is turned on.
- The [CHARGE] lamp on the USB cradle should turn red, indicating that charging has started. When charging is complete, the [CHARGE] lamp will turn green.

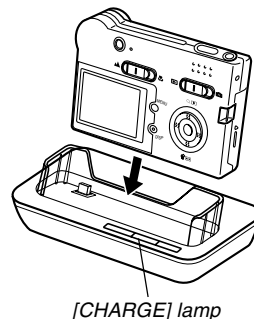

## 6. After charging is complete, remove the camera from the USB cradle.

- While holding the USB cradle in one hand, use your other hand to lift the left side from the USB cradle first (as if you were rotating it clockwise vertically). This ensures that you properly disengage the connector on the bottom of the camera from the USB cradle's connector.

## GETTING READY

### ►► IMPORTANT! ◀◀

- It takes about two hours to achieve a full charge. Actual charging time depends on current battery capacity and charging conditions.
- Use only the USB cradle (CA-23) or the optionally available charger unit (BC-10L) to charge the special NP-20 rechargeable lithium ion battery. Never use any other charging device.
- Use only the bundled AC adaptor. Never use any other type of AC adaptor. Do not use optionally available AD-C40, AD-C620 and AD-C630 AC adaptors with this camera.
- Make sure that the camera connector of the USB cradle is securely inserted into the camera's connector as far as it will go.
- The [CHARGE] lamp may remain amber colored and the charge operation may not start right away if you try to charge immediately after using the camera (which causes battery to become warm) or when it is too hot or too cold where you are performing the charge operation. If this happens, simply wait until the battery reaches normal temperature. The [CHARGE] lamp will turn red and charging will start when the battery temperature returns to the allowable charging temperature range.

- If the [CHARGE] lamp starts flashing red, it means that an error occurs while charging. An error can be caused by any of the following: a problem with the USB cradle, a problem with the camera, or a problem with the battery or how it is loaded. Remove the camera from the USB cradle and see if it works normally.
- You can use the USB cradle to charge the camera's battery, to exchange data with a computer over a USB connection, or when using the Photo Stand feature only.

### ►► NOTE ◀◀

- The bundled AC adaptor is designed for operation with any power supply in the range of 100V to 240V AC. Note, however, that the shape of the AC power cord plug varies according to country or geographic area. If you plan to use the AC adaptor in a geographic area where the power receptacle shape is different from that in your area, replace the AC power cord with one of the other ones that comes with the camera, or purchase a commercially available AC power cord that is compatible with the power outlets in that area.

## ■ If the camera works normally

1. **Continue using the camera until the current charge is used up, and then charge the battery.**

## ■ If the camera does not work normally

This can mean there is a problem with how the battery is loaded.

1. **Remove the battery from the camera and check the battery contacts for dirt. If the contacts are dirty, wipe them clean with a dry cloth.**
2. **Check to make sure that the AC adaptor's power cord is connected securely to the power outlet and USB cradle.**
  - If the same symptoms occur again when you place the camera on the USB cradle after taking the above steps, contact a CASIO authorized service center.

## ■ Battery Life Guidelines

The battery life guideline values given below indicate the amount of time under the conditions defined below the table, until power automatically turns off due to battery failure. They do not guarantee that the battery will provide the amount of service indicated. Low temperatures and continued use reduce battery life.

Operation	Approximate Battery Life
Number of Shots, Continuous Recording* <sup>1</sup> (Recording Time)	720 shots (120 minutes)
Number of Shots, Normal Recording* <sup>2</sup> (Recording Time)	190 shots (95 minutes)
Continuous Playback* <sup>3</sup> (Continuous Snapshot Recording)	180 minutes
Continuous Voice Recording* <sup>4</sup>	170 minutes
Continuous Audio Playback* <sup>5</sup>	450 minutes

Supported Battery: NP-20 (Rated Capacitance: 680mAh)

### \*1 Continuous Recording Conditions

- Temperature: 23°C (73°F)
- Monitor screen: On
- Flash: Off
- Image recorded about every 10 seconds

## GETTING READY

### \*2 Normal Recording Conditions

- Temperature: 23°C (73°F)
- Monitor screen: On
- Flash: On (one flash every two shots)
- Image recorded about every 30 seconds
- Power off/on every 10 shots

### \*3 Continuous Playback Conditions

- Temperature: 23°C (73°F)
- Scroll one image about every 10 seconds

### \*4 Voice recording times are based on continuous recording.



### \*5 Audio playback times are based on continuous output (through headphones).





- Voice recording and audio playback times apply to the EX-M20 only.
- The above values are based on a new battery starting from a full charge. Repeated charging shortens battery life.
- Battery life is greatly affected by how much you use flash, zoom and other functions, and how long you leave power turned on.

## ■ Tip to Make the Battery Last Longer

- If you do not need the flash while recording, select  (flash off) for the flash mode. See page 47 for more information.
- You can also conserve battery power by using the [DISP] button to turn off the monitor screen.

## ■ Low Battery Indicator

The following shows how the battery capacity indicator on the monitor screen changes as battery power is used. The  indicator means that remaining battery power is low. Note that you will not be able to record images while the battery indicator is . Charge the battery immediately whenever either of these indicators appears.

Battery Level	High ←————→ Low
Indicator	 →  →  → 

### Power Supply Precautions

Note the following precautions when handling or using the battery and the optional charger unit.

#### ■ Battery Handling Precautions

##### ● SAFETY PRECAUTIONS

Be sure to read the following Safety Precautions before trying to use the battery for the first time. Keep these safety precautions and all operating instructions on hand for future reference.

##### ))) NOTES (((

- The term “battery” in this manual refers to the CASIO NP-20 Rechargeable Lithium Ion Battery.
- The term “optional charger unit” in the following precautions refers to the optionally available CASIO BC-10L Charger Unit.

- Failure to observe any of the following precautions while using the battery creates the risk of over-heating, fire, and explosion.
  - Never use any other type of charger except the optional charger unit specified for the battery.
  - Never try to use the battery to power any other device other than this camera.
  - Never use or leave the battery near open flame.
  - Never place the battery in a microwave oven, throw it into fire, or otherwise expose it to intense heat.
  - Make sure the battery is oriented correctly when you load it into the camera or attach it to the optional charger unit.
  - Never carry or store the battery together with items that can conduct electricity (necklaces, pencil lead, etc.)
  - Never try to take the battery apart, modify it in any way, or expose it to strong impact.
  - Do not immerse the battery in fresh water or salt water.
  - Do not use or leave the battery under direct sunlight, in an automobile parked in the sun, or in any other area subject to high temperatures.



## GETTING READY

- Should you ever notice leakage, strange odor, heat generation, discoloration, deformation, or any other abnormal condition while using, charging, or storing a battery, immediately remove it from the camera or optional charger unit and keep it away from open flame.
- If the battery does not achieve full charge after the normal charging time has passed, stop charging. Continued charging creates the risk of overheating, fire, and explosion.
- Battery fluid can damage your eyes. Should battery fluid get into your eyes accidentally, immediately rinse them with clean tap water and then consult a physician.
- Be sure to read page 28 of this User's Guide and the instructions that come with the optional charger unit before using or charging the battery.
- If the battery is to be used by young children, make sure that a responsible adult makes them aware of the precautions and proper handling instructions and make sure that they handle the battery correctly.
- Should fluid from the battery accidentally get onto clothing or your skin, immediately rinse it off with clean tap water. Prolonged contact with battery fluid can cause skin irritation.

## ● PRECAUTIONS DURING USE

- The battery is designed for use with this CASIO digital camera only.
- Use only the USB cradle that comes with the camera or the specified optional charger unit to charge the battery. Never use any other type of charger unit for charging.
- A new battery is not charged. Be sure to charge the battery before using it for the first time.
- Use of a battery in cold environments shortens the operating time you can expect on a full charge. Charge the battery in a location where the temperature is in the range of 10°C to 35°C (50°F to 95°F). Charging outside this temperature range can cause charging to take longer than normal or even cause charging to fail.
- Very limited operation following a full charge indicates that the battery has reached the end of its service life. Replace the battery with a new one.
- Never wipe the battery with thinner, benzene, alcohol, or other volatile agents or chemically treated rags. Doing so can cause deformation of the battery and lead to malfunction.

## GETTING READY

### ● BATTERY STORAGE PRECAUTIONS

- Make sure you remove the battery when you do not plan to use the camera for a long time. A battery left in the camera discharges very small amounts of power even when power is turned off, which can lead to a dead battery or the need for longer charging before the next use.
- Store the battery in a cool, dry place (20°C (68°F) or lower).

### ● USING THE BATTERY

- See page 28 of this manual or the instructions that come with the optional charger unit for information about charging procedures and charging times.
- When transporting a battery, keep it either loaded in the camera or stored in its case.

### ■ USB Cradle and AC Adaptor Precautions



- Never use an electrical outlet whose voltage is outside the rating marked on the AC adaptor. Doing so can create the danger of fire or electric shock. Use only the bundled AC adaptor specified for this camera.
- Do not allow the AC adaptor cord to become cut or damaged, do not place heavy objects on it, and keep it away from heat. A damaged power cord creates the risk of fire and electric shock.
- Never try to modify the AC adaptor cord, or subject it to severe bending, twisting, or pulling. Doing so creates the risk of fire and electric shock.
- Never touch the AC adaptor while your hands are wet. Doing so creates the risk of electric shock.
- Do not overload extension cords or wall outlets. Doing so creates the danger of fire and electric shock.
- Should the cord of the AC adaptor become damaged (exposed internal wiring), request a replacement from a CASIO authorized service center. A damaged AC adaptor cord creates the danger of fire or electric shock.

## GETTING READY



Caution!

- Use the AC adaptor where it will not be splashed with water. Water creates the risk of fire and electric shock.
- Do not place a vase or any other container filled with liquid on top of the AC adaptor. Water creates the risk of fire and electric shock.
- Make sure you always remove the camera from the USB cradle before connecting or disconnecting the AC adaptor.
- Charging, USB data communication, and using the Photo Stand feature can cause the AC adaptor to become warm. This is normal and does not indicate malfunction.
- Unplug the AC power cord from the power outlet whenever you are not using it.
- Never place a blanket or any other cover on the AC adaptor. Doing so creates the risk of fire.

## Turning the Camera On and Off

Press the power button to turn the camera on and off. Pressing the power button to turn on the camera causes the operation/flash charge lamp to turn green. Press the power button again to turn off the camera.

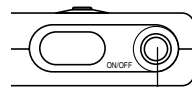



Power button

### ►► IMPORTANT! ◀◀

- If camera power is turned off by the Auto Power Off feature, press the power button to turn it back on again.

## Auto Power Off (APO)

Auto Power Off (APO) automatically turns off the camera when you do not perform any operation for a certain amount of time.

1. Turn on the camera, and then align the mode selector with “” (REC) or “” (PLAY).
2. Press [MENU].
3. Use [◀] and [▶] to select the “Set Up” tab.
4. Use [▲] and [▼] to select “Auto Power Off”, and then press [▶].
  - See page 37 for information about how to use menus.

## 5. Use [▲] and [▼] to change the currently selected setting, and then press [SET].

To do this:	Select this setting:
Set the Auto Power Off trigger time to 2 minutes	2 min
Set the Auto Power Off trigger time to 5 minutes	5 min

### ►► IMPORTANT! ◀◀

- Auto Power Off is automatically disabled under any one of the following conditions.
  - While the camera is connected to a computer via the USB cradle
  - While a slideshow is playing
  - While playing back a voice recording file (EX-M20 only)

## Using the On-screen Menu

Pressing [MENU] displays menus on the monitor screen that you can use to perform various operations. The menu that appears depends on whether you are in the REC mode or the PLAY mode. The following shows an example menu procedure in the REC mode.

1. Turn on the camera, and then align the mode selector with “” (REC) to enter the REC mode.

- If you want to enter the PLAY mode instead, you would align the mode selector with “” (PLAY).

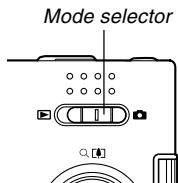

2. Press [MENU].

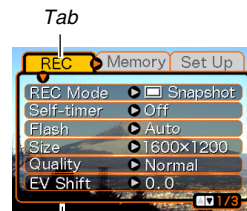
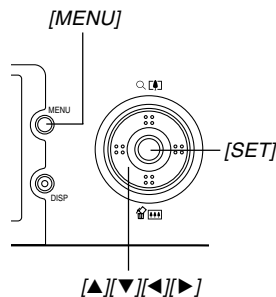

### Settings

Selection cursor (indicates the currently selected item)

## GETTING READY

### ● Menu Screen Operations

When you want to do this:	Do this:
Move between tabs	Press [◀] and [▶].
Move from the tab to the settings	Press [▼].
Move from the settings to the tab	Press [▲].
Move between the settings	Press [▲] and [▼].
Display the options available for a setting	Press [▶] or press [SET].
Select an option	Press [▲] and [▼].
Register an option selection and exit the menu screen	Press [SET].
Register an option selection and return to the menu screen	Press [◀].
Exit the menu screen	Press the [MENU] button.

**3. Press [◀] or [▶] to select the tab you want, and then press [SET] to move the selection cursor from the tab to the settings.**

**4. Use [▲] and [▼] to select the feature whose setting you want to configure, and then press [▶].**

- Instead of pressing [▶], you could also press [SET].



*Example: To select the "Flash" item.*

**5. Use [▲] and [▼] to change the currently selected setting.**

## 6. Perform one of the following operations to apply the setting you configured.

To do this:	Perform this key operation:
Apply the setting and exit the menu screen.	Press [SET].
Apply the setting and return to feature selection in step 4.	Press [◀].
Apply the setting and return to tab selection in step 3.	1. Press [◀]. 2. Use [▲] to move back up to tab selection.

- See “Menu Reference” on page 173 for more information about menus.

## Configuring Display Language and Clock Settings

Be sure to configure the following settings before using the camera to record images.

- Display language
- Home city
- Date Style
- Date and time

Note that the current date and time settings are used by the camera to generate the date and time that are stored along with image data, etc.

### ▶▶ IMPORTANT! ◀◀

- The camera's clock settings are cleared whenever power is totally cut off. This can happen if the battery goes dead while the camera is not being supplied power by the USB cradle. The clock setting screen will appear automatically the next time you turn on power after the settings are cleared. Set the date and time before using the camera.
- The current date and time settings will be cleared if the battery remains dead without being charged for about two days.
- Recording images without configuring the clock settings causes incorrect time information to be registered. Be sure to configure the clock settings before using the camera.

## To configure display language and clock settings

1. Press the power button to turn on the camera.
2. Use [▲], [▼], [◀], and [▶] to select the language you want, and then press [SET].



日本語 : Japanese

English : English

Français : French

Deutsch : German

Español : Spanish

Italiano : Italian

Português : Portuguese

中國語 : Chinese (Complex)

中国語 : Chinese (Simplified)

한국어 : Korean



## GETTING READY

3. Use [▲], [▼], [◀], and [▶] to select the geographical area where you live, and then press [SET].



4. Use [▲] and [▼] to select the name of the city where you live, and then press [SET].



5. Use [▲] and [▼] to select the summer time (DST) setting you want, and then press [SET].

When you want to do this:	Select this setting:
Keep time using summer time (Daylight Saving Time)	On
Keep time using standard time	Off

6. Use [▲] and [▼] to change the date format setting, and then press [SET].

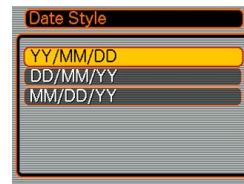

Example: December 24, 2003

To display the date like this:	Select this format:
03/12/24	YY/MM/DD
24/12/03	DD/MM/YY
12/24/03	MM/DD/YY

## GETTING READY

### 7. Set the current date and the time.

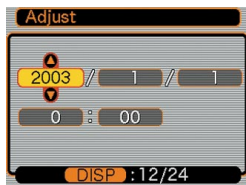

To do this:	Do this:
Change the setting at the current cursor location	Press [▲] and [▼].
Move the cursor between settings	Press [◀] and [▶].
Toggle between 12-hour and 24-hour timekeeping	Press [DISP].

### 8. Press [SET] to register the settings and exit the setting screen.

# BASIC IMAGE RECORDING

This section describes the basic procedure for recording an image.

## Recording an Image

### Aiming the Camera

Use both hands to hold the camera still when shooting an image. Holding the camera with one hand increases the chance of movement, which can blur your images.

- Horizontal

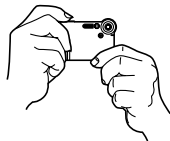

Hold the camera still in both hands, with your arms firmly against your sides.

- Vertical

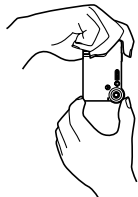

When holding the camera vertically, make sure that the flash is above the lens. Hold the camera still with both hands.

### IMPORTANT!

- Make sure your fingers or the strap does not block the flash or lens.

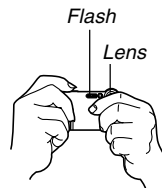

### NOTE

- Your image will be blurred if you move the camera when pressing the shutter release button. Press the shutter release button carefully, taking care that there is no camera movement. This is especially important when available lighting is low, which slows down the shutter speed.

### Recording an Image

Your camera automatically adjusts shutter speed in accordance with the brightness of the subject. Images you record are stored in the camera's built-in memory, or to a memory card if you have one loaded in the camera.

- When an optionally available SD memory card or MultiMediaCard (MMC) is loaded in the camera, images are stored on the card (page 125).

#### 1. Press the power button to turn on the camera.

- This causes an image or a message to appear on the monitor screen.

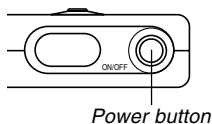

#### 2. Align the mode selector with "REC" (REC).

- This enters the REC mode for image recording.

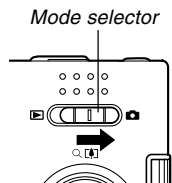

#### 3. Compose the image on the monitor screen.

- You can compose images using either the monitor screen or the optical viewfinder.
- When using the optical viewfinder, you can turn off the monitor screen to save power (page 25).

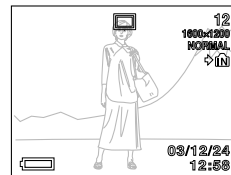

#### 4. Press the shutter release button to record the image.

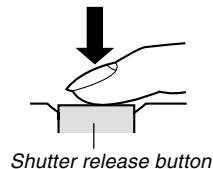

- The number of images that can be stored in memory depends on the resolution setting you are using (pages 52, 183).
- Depending on the distance or angle between the subject and the camera, the image you see in the viewfinder may not be exactly the image that is recorded.

### About the REC Mode Monitor Screen

- The image shown on the monitor screen in the REC mode is a simplified image for composing purposes. The actual image is recorded in accordance with the image quality setting currently selected on your camera. The image saved in file memory has much better resolution and detail than the REC mode monitor screen image.
- Certain levels of subject brightness can cause the response of the REC mode monitor screen to slow down, which causes some static noise in the monitor screen image.

### Recording Precautions

- Never open the battery cover or place the camera onto the USB cradle while the operation/flash charge lamp is flashing. Doing so not only causes the current image to be lost, it can also corrupt images already stored in file memory and even lead to malfunction of the camera.
- Never remove the memory card while an image is being recorded to the memory card.
- Fluorescent lighting actually flickers at a frequency that cannot be detected by the human eye. When using the camera indoors under such lighting, you may experience some brightness or color problems with recorded images.
- When "Auto" is selected for the ISO sensitivity setting (page 72), the camera automatically adjusts its sensitivity in accordance with the brightness of the subject. This can cause some static noise to appear in images of relatively dark subjects.
- When "Auto" is selected for the ISO sensitivity setting (page 72), the camera raises the sensitivity and uses a faster shutter speed. Because of this, you need to guard against camera movement if you have flash turned off (page 47) when recording a dimly lit subject.
- If unwanted light is shining on the lens, shade the lens with your hand when recording the image.

### Using Zoom

You can use the digital zoom feature of your camera to zoom in on the center of an image. Performing a zoom operation toggles the zoom factor between 1X and 4X.

1. In the REC mode, press [MENU].
2. Use [◀] and [▶] to select the “REC” tab.
3. Use [▲] and [▼] to select “Digital Zoom”, and then press [▶].
4. Use [▲] and [▼] to select “On”, and then press [SET].
  - Selecting “Off” disables digital zoom.

5. In the REC mode, use [▲] and [▼] to change the digital zoom factor.

[▲] : Zoom in.

[▼] : Zoom out.

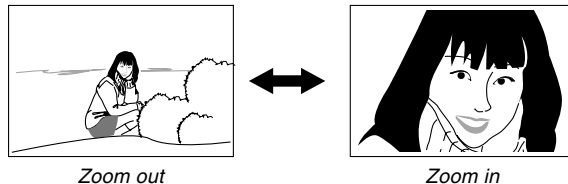

6. Record the image.

## BASIC IMAGE RECORDING

### ►► IMPORTANT! ◀◀

- Zoom is disabled whenever the monitor screen is turned off (page 25).
- Using digital zoom can cause degradation of the recorded image.
- To disable digital zoom, select “Off” for the “Digital Zoom” setting on the “REC” tab.



### ►► NOTE ◀◀

- You can use the key customization feature (page 75) to configure the camera so the digital zoom factor changes whenever you press [▲] and [▼] while in the REC mode.

## Using the Flash

Perform the following steps to select the flash mode you want to use.

- 1. In the REC mode, press [MENU].**
- 2. Use [◀] and [▶] to select the “REC” tab.**
- 3. Use [▲] and [▼] to select “Flash”, and then press [▶].**
- 4. Use [▲] and [▼] to select the flash mode you want, and then press [SET].**

To do this:	Select this setting:
Have the flash fire automatically when required (Auto Flash)	Auto
Turn off the flash (Flash Off)	
Always fire the flash (Flash On)	
Fire a pre-flash followed by image recording with flash, reducing the chance of red-eye in the image (Red-eye reduction). Have the flash fire automatically when required.	

### 5. Record the image.

#### ▶▶ IMPORTANT! ◀◀

- The flash unit of this camera fires a number of times when you record an image. The initial flashes are pre-flashes, which the camera uses to obtain information it uses for exposure settings. The final flash is for recording. Make sure that you keep the camera still until the shutter releases.
- Image recording may not be performed if you press the shutter release button while the operation/flash charge lamp is flashing amber.

#### ▶▶ NOTE ◀◀

- You can use the key customization feature (pages 74, 75) to configure the camera so the flash mode changes whenever you press [◀] and [▶], or [▲] and [▼] while in the REC mode.

### ■ About Red-eye Reduction

Using the flash to record at night or in a dimly lit room can cause red spots inside the eyes of people who are in the image. This is caused when the light from the flash reflects off of the retina of the eye. Red-eye reduction fires a pre-flash, which causes the irises in the eyes of any people in the image to close. This is followed by another flash operation when the image is actually recorded.

#### ▶▶ IMPORTANT! ◀◀

Note the following important points when using red-eye reduction.

- Red-eye reduction does not work unless the people in the image are looking directly at the camera (flash). Before pressing the shutter release button, call out to the subjects so they all look at the camera.
- Red-eye reduction may not work very well if the subjects are located far away from the camera.



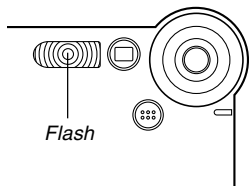

### Flash Precautions

Take care that your fingers do not block the flash when you hold the camera. Covering the flash with your finger can greatly reduce its effectiveness.



- The approximate effective range of the flash is shown below. The flash is unable to adequately illuminate a subject that is outside this range.  
0.8 meter to 1.5 meters (2.6' to 4.9') (ISO Sensitivity : "Auto")
- The flash takes anywhere from a few seconds as long as 10 seconds to attain full charge after being fired. The actual time required depends on the battery level, temperature, and other conditions.
- The flash does not fire during movie recording. This is indicated by  on the monitor screen.

- The flash unit may not be able to charge when battery power is low. Low battery power is indicated by the  on the monitor screen, and when the flash fails to fire properly resulting in poor image exposure. When these symptoms occur, charge the camera's battery as soon as possible.
- When the red-eye reduction mode () is selected, flash intensity is adjusted automatically in accordance with the exposure. The flash may not fire at all when the subject is brightly lit.
- Using flash in combination with another light source (daylight, fluorescent light, etc.) can result in abnormal image colors.

### Recording Macro Images

You can select either normal or macro (close-up) recording using the selector located on the left side of the camera. The table below describes the two settings available with the selector.

To do this:	Select this setting:
Shoot normal images, at a distance of about 1m (39.4") to infinity (Normal)	▲
Shoot close-ups, at a distance of about 30cm (11.8") (Macro)	🌸

- The distances indicated above represent the distance from the camera's lens surface to the subject.

**1. Align the Normal (▲)/  
Macro (🌸) selector with  
"🌸".**

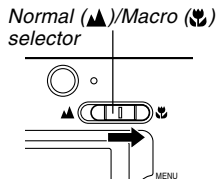

**2. Record the image.**

### ▶▶ IMPORTANT! ◀◀

- Selecting the macro mode causes the 🌸 indicator to appear on the monitor screen.
- Normally, you should leave the Normal (▲)/Macro (🌸) selector setting at "▲".

## Using the Self-timer

The self-timer lets you select either a 2-second or 10-second delay of the shutter release after you press the shutter release button. A Triple Self-timer feature lets you perform three consecutive self-timer operations to record three images.

1. In the REC mode, press [MENU].
2. Use [◀] and [▶] to select the “REC” tab.
3. Use [▲] and [▼] to select “Self-timer”, and then press [▶].
4. Use [▲] and [▼] to select the self-timer time you want to use, and then press [SET].
  - Selecting “Off” in step 4 disables the self-timer.

To do this:	Select this setting:
Specify a 10-second self-timer	10 sec
Specify a 2-second self-timer	2 sec
Specify Triple Self-timer	X3
Disable the self-timer	Off

- With the Triple Self-timer, the camera records a series of three images in the sequence described below.
  1. The camera performs a 10-second countdown and then records the first image.
  2. The camera prepares to record the next image. The amount of time required for preparation depends on the camera’s current “Size” and “Quality” settings, the type of memory (built-in or card) you are using for image storage, and whether or not the flash is charging.
  3. After preparation is complete, the indicator “1sec” appears on the monitor screen, and another image is recorded one second later.
  4. Steps 2 and 3 are repeated once more to record the third image.

### 5. Record the image.

- When you press the shutter release button, the self-timer lamp flashes and the shutter releases after the self-timer reaches the end of its countdown.
- You can interrupt an ongoing self-timer countdown by pressing the shutter release button while the self-timer lamp is flashing.

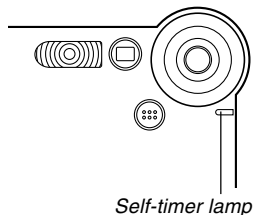

### Specifying Image Size and Quality

You can specify the image size and image quality to suit the type of image you are recording.

#### To specify the image size

1. In the REC mode, press [MENU].
2. Use [◀] and [▶] to select the “REC” tab.
3. Use [▲] and [▼] to select “Size”, and then press [▶].
4. Use [▲] and [▼] to select the setting you want, and then press [SET].

1600 x 1200	:	1600 x 1200 pixels
1600 x 1072 (3:2)	:	1600 x 1072 pixels
1280 x 960	:	1280 x 960 pixels
640 x 480	:	640 x 480 pixels

#### »» NOTES ««

- The “2 sec” self-timer setting is best when shooting with a slow shutter speed, because it helps to avoid blurring of images due to hand movement.
- You can use the key customization feature (page 75) to configure the camera so the self-timer setting changes whenever you press [▲] and [▼] while in the REC mode.

### »» NOTES ««

- If you plan to make large prints of your images or otherwise use them in applications where high-resolution is your top priority, select the “1600 x 1200” image size.
- If you plan to send images as e-mail attachments or otherwise use them in applications where data economy is your top priority, select the “640 x 480” image size.
- Selecting the “1600 x 1072 (3:2)” image size records images with a 3:2 (vertical : horizontal) aspect ratio, which is optimal for printing on paper with an aspect ratio of 3:2.

### To specify image quality

1. In the REC mode, press [MENU].
2. Use [◀] and [▶] to select the “REC” tab.
3. Use [▲] and [▼] to select “Quality”, and then press [▶].
4. Use [▲] and [▼] to select the setting you want, and then press [SET].

To get this:	Select this setting:
Very high quality, but large file size	Fine
Normal quality	Normal
Small file size, but low quality	Economy

## BASIC IMAGE RECORDING

### »» NOTE ««

- Use the “Fine” setting when image quality is your top priority and file size is secondary. Conversely, use the “Economy” setting when file size is your top priority and image quality is secondary.

### »» IMPORTANT! ««

- Actual file size depends on the type of image you record. This means that the remaining image capacity noted on the monitor screen may not be exactly accurate (pages 23, 183).

# OTHER RECORDING FUNCTIONS

This chapter describes the other powerful features and functions that are available for recording.

## Exposure Compensation (EV Shift)

Exposure compensation lets you change the exposure setting (EV value) manually to adjust for the lighting of your subject. This feature helps to achieve better results when recording a backlit subject, a strongly lit subject indoors, or a subject that is against a dark background.

EV Shift Range: -2.0EV to +2.0EV  
Steps: 1/3EV

1. In the REC mode, press [MENU].

2. Select the "REC" tab, select "EV Shift", and then press [▶].

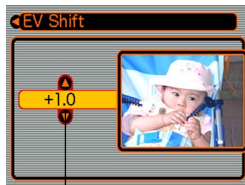

Exposure compensation value

3. Use [▲] and [▼] to change the exposure compensation value, and then press [SET].

- Pressing [SET] registers the displayed value.



EV value

[▲] : Increases the EV value. A higher EV value is best used for light-colored subjects and backlight subjects.

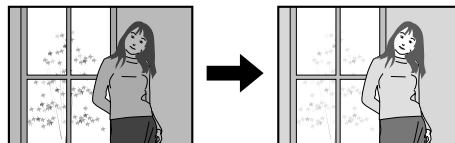

[▼] : Decreases the EV value. A lower EV value is best for dark-color subjects and for shooting outdoors on a clear day.

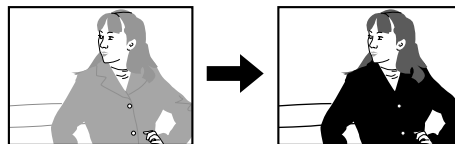

## OTHER RECORDING FUNCTIONS

- To cancel EV Shift, adjust the value until it becomes 0.0.

### 4. Record the image.

#### ▶▶ IMPORTANT! ◀◀

- When shooting under very dark or very bright conditions, you may not be able to obtain satisfactory results even after performing exposure compensation.

#### ▶▶ NOTES ◀◀

- Performing an EV shift operation causes the metering mode to switch automatically to center weighted metering. Returning the EV shift value to 0.0 causes the metering mode to change back to multi-pattern metering.
- You can use key customization (page 74) to configure the camera to perform exposure compensation whenever you press [◀] and [▶] while in the REC mode.

## Adjusting White Balance

The wavelengths of the light produced by various light sources (sunlight, light bulb, etc.) can affect the color of a subject when it is recorded. White balance lets you make adjustments to compensate for different lighting types, so the colors of an image appear more natural.

1. In the REC mode, press [MENU].





2. Select the “REC” tab, select “White Balance”, and then press [▶].





## OTHER RECORDING FUNCTIONS

### 3. Use [▲] and [▼] to select the setting you want, and then press [SET].

When shooting under these conditions:	Select this setting:
Normal conditions	Auto
Outdoor daylight	
Shade	
Incandescent light bulb (reddish tinge)	
Fluorescent light (greenish tinge)	
Difficult lighting that requires manual control (See "Adjusting White Balance Manually".)	Manual

#### ►► NOTES ◀◀

- Selecting "Manual" changes white balance to the settings achieved the last time a manual white balance operation was performed.
- You can use the key customization feature (pages 74, 75) to configure the camera so the white balance setting changes whenever you press [◀] and [▶], or [▲] and [▼] while in the REC mode.

## Adjusting White Balance Manually

Under some light sources, automatic white balance under the "Auto" setting can take a long time to complete. Also, the auto white balance range (color temperature range) is limited. Manual white balance helps to ensure that colors are recorded correctly for a particular light source. Note that you must perform manual white balance under the same conditions you will be shooting under. You must also have a white piece of paper or other similar object on hand in order to perform manual white balance.

1. In the REC mode, press [MENU].
2. Select the "REC" tab, select "White Balance", and then press [▶].
3. Use [▲] and [▼] to select "Manual".

- This causes the object you last used to adjust manual white balance to appear on the monitor screen.



4. Point the camera at a white piece of paper or similar object under the lighting conditions for which you want to set the white balance, and then press the shutter release button.

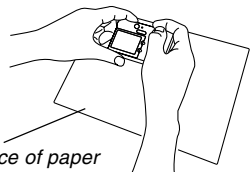

*A white piece of paper*

- This starts the white balance adjustment procedure. The message “Complete” appears on the monitor screen after white balance adjustment is complete.
  - Dim lighting or pointing the camera at a dark colored object while performing manual white balance adjustment can cause the procedure to take a long time to complete.
5. Press [SET].
    - This registers the white balance settings and returns to the REC mode.

### Using the BESTSHOT Mode

Selecting one of the 15 BESTSHOT scenes automatically sets up the camera for recording a similar type of image.

#### ■ Example Sample Scene

- Portrait



- Scenery



- Night Scene



- Night Scene Portrait



## OTHER RECORDING FUNCTIONS

1. In the REC mode, press [MENU].
2. Select the “REC” tab, select “REC Mode”, and then press [▶].
3. Use [▲] and [▼] to select “**BS** BESTSHOT”, and then press [SET].
  - This enters the BESTSHOT mode and displays a sample scene.
4. Use [◀] and [▶] to select the sample scene you want, and then press [SET].
5. Record the image.

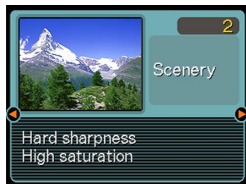

### ►► IMPORTANT! ◀◀

- Sample scene number 4 is Coupling Shot scene (page 62). Sample scene number 5 is a Pre-shot scene (page 64).
- BESTSHOT scenes were not recorded using this camera. They are provided as samples only.
- Images recorded using a BESTSHOT scene may not produce the results you expected due to shooting conditions and other factors.
- After selecting a BESTSHOT scene, you can change to a different one by using [◀] and [▶] to scroll through available scenes. When the one you want is displayed, press [SET].

### ►► NOTE ◀◀

- You can use the key customization feature (page 74) to configure the camera to enter the BESTSHOT mode whenever you press [◀] or [▶] while in the REC mode.  
Operation guidance and the currently selected BESTSHOT scene appear on the display for about two seconds after you enter the BESTSHOT mode this way, or if the camera is in the BESTSHOT mode when you turn it on.



## Creating Your Own BESTSHOT Setup

You can use the procedure below to save the setup of an image you recorded for later recall when you need it again. Recalling a setup you save automatically sets up the camera accordingly.

1. In the REC mode, press [MENU].
2. Select the “REC” tab, select “REC Mode”, and then press [▶].
3. Use [▲] and [▼] to select “**BS** BESTSHOT”, and then press [SET].
  - This enters the BESTSHOT mode and displays a sample scene.
4. Use [◀] and [▶] to display “Register User Scene”.



5. Press [SET].

6. Use [◀] and [▶] to display the image whose setup you want to register as a BESTSHOT scene.

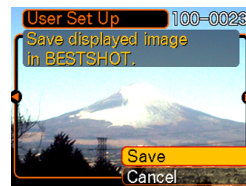

7. Use [▲] and [▼] to select “Save”, and then press [SET].

- This registers the setup.
- Now you can use the procedure on page 59 to select your user setup for recording.

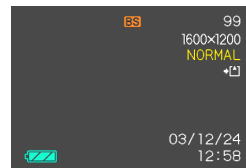

## OTHER RECORDING FUNCTIONS

### ►► IMPORTANT! ◀◀

- BESTSHOT user setups are located in the camera's built-in memory after the built-in sample scenes.
- Note that formatting the built-in memory (page 123) deletes all BESTSHOT user setups.

### ►► NOTES ◀◀

- The following are the settings that are included in a BESTSHOT user setup: EV shift value, white balance mode, flash mode, and ISO sensitivity.
- Note that images recorded with this camera only can be used to create a BESTSHOT user setup.
- You can have up to 999 BESTSHOT user setups in the camera's built-in memory at one time.
- You can check the current setup of a scene by displaying the various setting menus.
- When you register a BESTSHOT user setup, it is automatically assigned a file name using one of the formats shown below, depending on your camera model.

EX-S20 : UES20nnn.JPE (n = 0 to 9)

EX-M20 : UEM20nnn.JPE (n = 0 to 9)

### ■ To delete a BESTSHOT user setup

1. In the REC mode, press [MENU].
2. Select the "REC" tab, select "REC Mode", and then press [▶].
3. Use [▲] and [▼] to select "BS BESTSHOT", and then press [SET].
  - This enters the BESTSHOT mode and displays a sample scene.
4. Use [◀] and [▶] to display the user setup you want to delete.
5. Press [▼] (🏠) to delete the user setup.
  - You can also delete a user setup by using your computer to delete its file in the "SCENE" folder in the camera's built-in memory (page 142).

### Combining Shots of Two People into a Single Image (Coupling Shot)

The Coupling Shot mode lets you record images of two people and combine them into a single image. This makes it possible for you to include yourself in group images, even when there is no one else around to record the image for you. Coupling Shot is available in the BESTSHOT mode (page 58).

- First Image



This is the part of the image that does not include the person who is recording the first image.



- Second Image



Making sure that the background of the image is aligned correctly, record the image of the person who recorded the first image.

- Combined Images

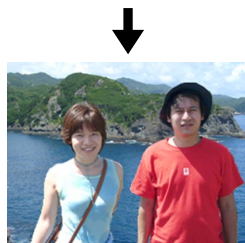

1. In the REC mode, press [MENU].
2. Select the "REC" tab, select "REC Mode", and then press [▶].
3. Use [▲] and [▼] to select "[BS] BESTSHOT", and then press [SET].
4. Use [◀] and [▶] to select "Coupling Shot", and then press [SET].

## OTHER RECORDING FUNCTIONS

### 5. Use the monitor screen to compose and record the left side of the image.

- The exposure, white balance, zoom, and flash settings are fixed for this type of image.

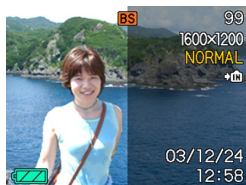

### 6. Next, use the monitor screen to compose the right side of the image, taking care to align the actual background with the semi-transparent image of the background of the left-side image, which remains on the monitor screen. When everything is aligned correctly, record the image.

- Pressing [MENU] any time after step 5 of the above procedure cancels the first image and returns to step 5.



*Semi-transparent image*

## OTHER RECORDING FUNCTIONS

### Recording a Subject onto an Existing Background Image (Pre-shot)

Pre-shot helps you get the background you want, even if you need to ask someone else to record the image for you. Basically, Pre-shot is a two-step process.

1. You compose the background you want and press the shutter release button, which causes a semi-transparent image of the background to remain on the monitor screen.
2. Ask someone else to record a shot of you against your original background, telling them to compose the image by using the semi-transparent monitor screen image as a guide.
  - The camera stores the image produced by step 2 only.
  - Depending on how the image is actually composed in step 2, its background may not be exactly the same as the one you composed in step 1.

Note that Pre-shot is available in the BESTSHOT mode only (page 58).

- Freeze the background on the monitor screen.



- Record the image, using the background on the monitor screen as a guide.



- This records the image.





## OTHER RECORDING FUNCTIONS

1. In the REC mode, press [MENU].
2. Select the “REC” tab, select “REC Mode”, and then press [▶].
3. Use [▲] and [▼] to select “BS BESTSHOT”, and then press [SET].

4. Use [◀] and [▶] to select “Pre-shot”, and then press [SET].

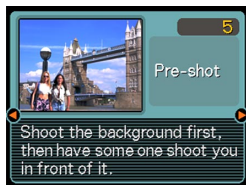

5. Freeze the background on the monitor screen.

- Though a semi-transparent image of the background appears on the monitor screen in step 6, the background image is not saved in memory at this time.
- The exposure, white balance, zoom, and flash settings are fixed for this type of image.

6. Next, use the monitor screen to compose the subject with the semi-transparent background shown on the monitor screen. When everything is aligned correctly, record the image.



*Semi-transparent image*

- This records the image composed on the monitor screen in step 6. The reference background image is not recorded.
- Pressing [MENU] any time after step 5 of the above procedure cancels the background image and returns to step 5.

## Using the Movie Mode

You can record movies up to 60 seconds long. The EX-M20 even lets you record audio along with your movies.

- File Format: AVI  
AVI format conforms to the Motion JPEG format promoted by the Open DML Group.
- Image Size: 320 x 240 pixels
- Movie File Size: Approximately 160KB/second.
- Maximum Movie Length
  - One Movie: 60 seconds
  - Total Movie Time:  
60 seconds with built-in memory; 380 seconds with 64MB SD memory card

**1. In the REC mode, press [MENU].**

**2. Select the “REC” tab, select “REC Mode”, and then press [▶].**

**3. Use [▲] and [▼] to select “Movie”, and then press [SET].**

- “Remaining capacity” shows how many 60-second movies can still be recorded to memory.

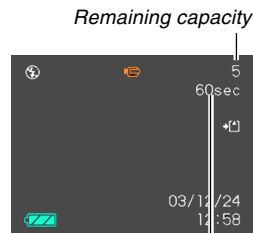

*Remaining recording time*

**4. Point the camera at the subject and then press the shutter release button.**

- Movie recording continues for 60 seconds, or until you stop it by pressing the shutter release button again.
- The remaining recording time value counts down on the monitor screen as you record.
- When movie recording is complete, the movie file is stored in file memory.
- To cancel storage of the movie file, use [▼] to select “Delete” while file storage is being performed, and then press [SET].

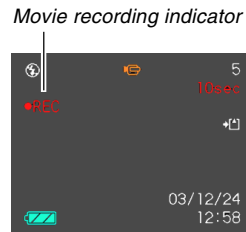

### ▶▶ IMPORTANT! ◀◀

- The flash does not fire in the Movie mode.
- The EX-M20 also records audio. Note the following points when recording a movie.

- Take care that you do not block the microphone with your fingers.

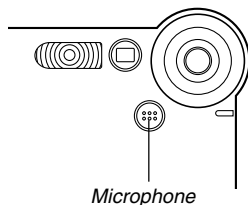

- Good recording results are not possible when the camera is too far from the subject.
- Operating camera buttons during recording can cause button noise to be included in the audio.
- Movie audio is recorded in monaural.

## Recording Audio (EX-M20 Only)

### Adding Audio to a Snapshot

You can add audio to a snapshot after you record it.

- **Image Format: JPEG**  
JPEG is an image format that provides efficient data compression.  
The file extension of a JPEG file is “.JPG”.
- **Audio Format: WAVE/ADPCM recording format**  
This is the Windows standard format for audio recording.  
The file extension of a WAVE/ADPCM file is “.WAV”.
- **Recording Time:**  
Up to about 30 seconds per image
- **Audio File Size:**  
Approximately 240KB (30-second recording of approximately 8KB per second)

## OTHER RECORDING FUNCTIONS

1. In the REC mode, press [MENU].
2. Select the “REC” tab, select “REC Mode”, and then press [▶].
3. Use [▲] and [▼] to select “🎵 (📷+🎤)”, and then press [SET].
  - This enters the Snapshot Audio Mode.

**4. Press the shutter release button to record the image.**

- After the image is recorded, the camera enters audio recording standby, with the image you just recorded on the monitor screen.
- You can cancel audio recording standby by pressing [MENU].

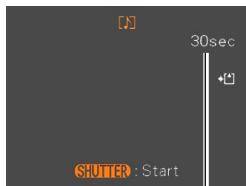

*Remaining recording time*

**5. Press the shutter release button to start audio recording.**

- The operation/flash charge lamp flashes green as recording is performed.
- Even if you have the monitor screen turned off (page 25), the monitor screen turns on while you are adding audio to a snapshot.

**6. Recording stops after about 30 seconds or when you press the shutter release button.**

## Recording Your Voice

The Voice Recording Mode provides quick and easy recording of your voice.

- **Audio Format:** WAVE/ADPCM recording format  
This is the Windows standard format for audio recording. The file extension of a WAVE/ADPCM file is “.WAV”.
- **Recording Time:**  
Approximately 40 minutes with built-in memory
- **Audio File Size:**  
Approximately 240KB (30-second recording of approximately 8KB per second)

1. In the REC mode, press [MENU].
2. Select the “REC” tab, select “REC Mode”, and then press [▶].
3. Use [▲] and [▼] to select “Voice”, and then press [SET].

- This enters the Voice Recording Mode.

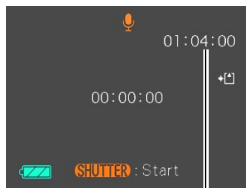

*Remaining recording time*

### 4. Press the shutter release button to start voice recording.

- The remaining recording time value counts down on the monitor screen and the operation/flash charge lamp flashes green as recording is performed.
- Pressing the [DISP] button during voice recording turns off the monitor screen. The monitor screen turns back on automatically when recording is complete.
- You can insert index marks while recording by pressing [SET]. See page 96 for information about jumping to an index mark during playback.

### 5. Recording stops when you press the shutter release button, when memory becomes full, or when the battery goes dead.

### ■ Audio Recording Precautions

- Keep the microphone on the front of the camera pointed at the subject.
- Take care that you do not block the microphone with your fingers.
- Good recording results are not possible when the camera is too far from the subject.
- Operating camera buttons during recording can cause button noise to be included in the audio.
- Pressing the power button or changing the mode selector setting stops recording at that point and stores any audio recorded up to that point.
- You can also perform “after-recording” to add audio to a snapshot after recording it, and also change the audio recorded for an image. See page 93 for more information.

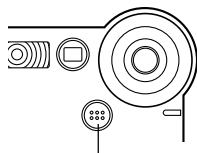

*Microphone*

### Using the Histogram

You can use the [DISP] button to display a histogram on the monitor screen. The histogram lets you check exposure conditions as you record images (page 25). You can also display the histogram of a recorded image in the PLAY mode.

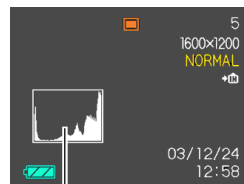

*Histogram*

A histogram is a graph that represents the lightness of an image in terms of the number of pixels. The vertical axis indicates the number of pixels, while the horizontal axis indicates lightness. You can use the histogram to determine whether an image includes the shadowing (left side), mid tones (center), and highlighting (right side) required to bring out sufficient image detail. If the histogram appears too lopsided for some reason, you can use EV shift (exposure compensation) to move it left or right in order to achieve better balance. Optimum exposure can be achieved by correcting exposure so the graph is as close to the center as possible.

## OTHER RECORDING FUNCTIONS

- When the histogram is too far to the left, it means that there are too many dark pixels. This type of histogram results when the overall image is dark. A histogram that is too far to the left may result in “black out” of the dark areas of an image.

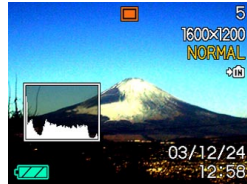

- When the histogram is too far to the right, it means that there are too many light pixels. This type of histogram results when the overall image is light. A histogram that is too far to the right may result in “white out” of the light areas of an image.

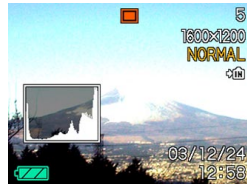

- A centered histogram indicates that there is good distribution of light pixels and dark pixels. This type of histogram results when the overall image is at optimal lightness.

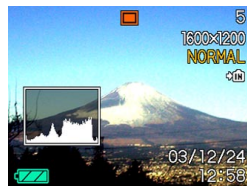

### ▶▶ IMPORTANT! ◀◀

- Note that the above histograms are shown for illustrative purposes only. You may not be able to achieve exactly the same shapes for particular subjects.
- A centered histogram does not necessarily guarantee optimum exposure. The recorded image may be over-exposed or under-exposed, even though its histogram is centered.
- You may not be able to achieve an optimum histogram configuration due to the limitations of EV shift.
- Use of the flash as well as certain shooting conditions can cause the histogram to indicate exposure that is different from the actual exposure of the image when it was recorded.
- This histogram does not appear when you are using Coupling Shot (page 62).

## REC Mode Camera Settings

## Specifying ISO Sensitivity

Use the following procedure to select the ISO sensitivity setting that suits the type of image you are recording.

1. In the REC mode, press [MENU].
2. Select the “REC” tab, select “ISO”, and then press [▶].
3. Use [▲] and [▼] to select the setting you want and then press [SET].

To get this:	Select this setting:
Automatic sensitivity selection	Auto
Conforms to ISO 64	ISO 64
Conforms to ISO 125	ISO 125
Conforms to ISO 250	ISO 250
Conforms to ISO 500	ISO 500

## ▶▶ IMPORTANT! ◀◀

- Increasing ISO sensitivity can cause static to appear inside an image. Select the ISO sensitivity setting that suits your shooting needs.
- Using a high ISO sensitivity setting along with the flash to shoot a nearby subject may result in improper illumination of the subject.

## ▶▶ NOTE ◀◀

- You can use the key customization feature (page 74) to configure the camera so the ISO sensitivity setting changes whenever you press [◀] and [▶] while in the REC mode.



## Turning the On-screen Grid On and Off

You can display gridlines on the monitor screen to help you compose images and ensure that the camera is straight when recording.

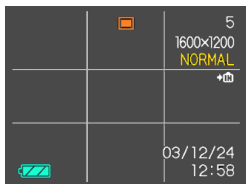

1. In the REC mode, press [MENU].
2. Select the “REC” tab, select “Grid”, and then press [▶].
3. Use [▲] and [▼] to select the setting you want, and then press [SET].

To do this:	Select this setting:
Display the grid	On
Hide the grid	Off

## Turning Image Review On and Off

Image review displays an image on the monitor screen as soon as you record it. Use the following procedure to turn image review on and off.

1. In the REC mode, press [MENU].
2. Select the “REC” tab, select “Review”, and then press [▶].
3. Use [▲] and [▼] to select the setting you want, and then press [SET].

To do this:	Select this setting:
Display images on the monitor screen for about one second immediately after they are recorded	On
Do not display images immediately after they are recorded	Off

## Assigning Functions to the [◀] and [▶] Keys

A “key customization” feature lets you configure the [◀] and [▶] keys so they change camera settings whenever they are pressed in the REC mode. After you configure the [◀] and [▶] keys, you can change the setting assigned to them without going through the menu screen.

1. In the REC mode, press [MENU].
2. Select the “REC” tab, select “L/R Key”, and then press [▶].
3. Use [▲] and [▼] to select the setting you want, and then press [SET].

When you want to assign this function to [◀] and [▶] keys:	Select this:
Recording mode • [◀] and [▶] cycle through recording modes. • EX-S20: Snapshot, BESTSHOT, Movie • EX-M20: Snapshot, BESTSHOT, Movie, Snapshot Audio, Voice Recording (page 173)	REC Mode
Flash mode • [◀] and [▶] cycle through the flash mode settings (page 47).	Flash
EV shift • [◀] decreases compensation, [▶] increases compensation (page 55).	EV Shift
White balance setting • [◀] and [▶] cycle through white balance settings (page 56).	White Balance
ISO sensitivity • [◀] and [▶] cycle through ISO sensitivity settings (page 72).	ISO
No function assigned	Off

### NOTE

- The initial default setting is “REC Mode”.

## Assigning Functions to the [▲] and [▼] Keys

A “key customization” feature lets you configure the [▲] and [▼] keys so they change camera settings whenever they are pressed in the REC mode. After you configure the [▲] and [▼] keys, you can change the setting assigned to them without going through the menu screen.

1. In the REC mode, press [MENU].
2. Select the “REC” tab, select “U/D Key”, and then press [▶].
3. Use [▲] and [▼] to select the setting you want, and then press [SET].

When you want to assign this function to [▲] and [▼] keys:	Select this:
Recording mode • [▲] and [▼] cycle through recording modes. • EX-S20: Snapshot, BESTSHOT, Movie • EX-M20: Snapshot, BESTSHOT, Movie, Snapshot Audio, Voice Recording (page 173)	REC Mode
Digital Zoom • [▲] increases the digital zoom factor, [▼] decreases the digital zoom factor (page 46).	Digital Zoom
Flash mode • [▲] and [▼] cycle through the flash mode settings (page 47).	Flash
White balance setting • [▲] and [▼] cycle through white balance settings (page 56).	White Balance
Self-timer mode • [▲] and [▼] cycle through self-timer modes (page 51).	Self-timer
No function assigned	Off

### NOTE

- The initial default setting is “Digital Zoom”.

## Specifying Power On Default Settings

The camera's "mode memory" feature lets you specify the power on default settings individually for the REC mode, flash mode, white balance mode, ISO sensitivity, and digital zoom mode. Turning on mode memory for a mode tells the camera to remember the status of that mode when you turn off the camera, and restore it the next time you turn the camera back on. When mode memory is turned off, the camera automatically restores the initial factory default setting for the applicable mode.

The following table shows what happens when you turn mode memory on or off for each mode.

Function	On	Off
REC Mode	Setting when camera is turned off	 Snapshot
Flash		Auto
White Balance		Auto
ISO		Auto
Digital Zoom		On

1. In the REC mode, press [MENU].
2. Select the "Memory" tab, select the item you want to change, and then press [▶].
3. Use [▲] and [▼] to select the setting you want, and then press [SET].

To do this:	Select this setting:
Turn on mode memory so settings are restored at power on	On
Turn off mode memory so settings are initialized at power on	Off

### »» IMPORTANT! ««

- Note that BESTSHOT mode settings take priority over mode memory settings. If you turn the camera off while in the BESTSHOT mode, the camera's Flash, White Balance, and ISO Sensitivity will be configured according to the BESTSHOT sample scene when you turn it back on again, regardless of mode memory on/off setting.
- If you turn the camera off while in the Movie mode, the flash will be turned off when you turn the camera back on again, regardless of mode memory on/off setting.

### Resetting the Camera

Use the following procedure to reset all of the camera's settings to their initial defaults as shown under "Menu Reference" on page 173.

- 1. In the REC mode or the PLAY mode, press [MENU].**
- 2. Select the "Set Up" tab, select "Reset", and then press [▶].**
- 3. Use [▲] and [▼] to select "Reset", and then press [SET].**
  - To cancel the procedure without resetting, select "Cancel" and press [SET].

# PLAYBACK

You can use the camera's built-in monitor screen to view images after you record them.

## Basic Playback Operation

Use the following procedure to scroll through files stored in the camera's memory.

### 1. Press the power button to turn on the camera.

- This causes an image or a message to appear on the monitor screen.

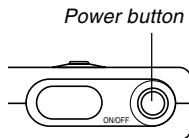

### 2. Align the mode selector with "▶" (PLAY).

- This enters the PLAY mode.

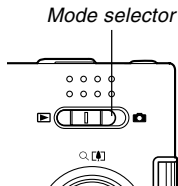

### 3. Use [▶] (forward) or [◀] (back) to scroll through files on the monitor screen.



### NOTES

- Holding down [◀] or [▶] scrolls images at high speed.
- In order to allow for faster playback image scrolling, the image that initially appears on the monitor screen is a preview image, which is of somewhat lower quality than the actual display image. The actual display image appears a short while after the preview image. This does not apply to images copied from another digital camera.

## Playing an Audio Snapshot (EX-M20 Only)

Perform the steps below to display an audio snapshot (indicated by a  indicator) and play its audio.

**1. In the PLAY mode, use [◀] and [▶] until the image you want is displayed.**

**2. Press [SET].**

- This plays back the audio that accompanies the displayed image.
- You can perform the following operations while audio is playing.



To do this:	Do this:
Fast forward or fast reverse the audio	Hod down [◀] or [▶].
Pause and unpause audio playback	Press [SET].
Adjust audio volume	Press [▲] or [▼].
Cancel playback	Press [MENU].

### ▶▶ IMPORTANT! ◀◀

- Audio volume can be adjusted only when playback is being performed or is paused.
- When you have the LCD remote controller connected to the camera, audio is output through the stereo headphones (page 160) instead of the camera's speaker. Output through the headphones is monaural.
- The volume of audio recorded with the camera cannot be adjusted using the LCD remote controller. Use the camera's controller to adjust volume level in this case.

## Flipping the Display

The following procedure flips the image 180 degrees. This comes in handy when you want to show someone standing in front of you an image on the monitor screen.

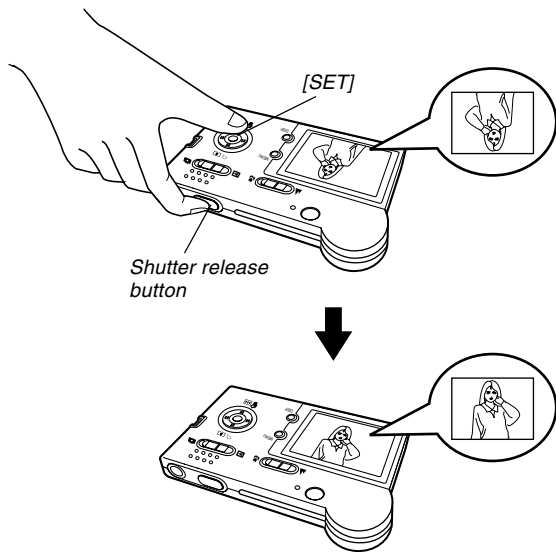

**1. In the PLAY mode, use [◀] and [▶] to scroll through images on the monitor screen and display the one you want.**

**2. Press the shutter release button and [SET] at the same time.**

- This flips the image 180 degrees. The histogram or any other display information you had displayed is cleared automatically whenever you flip the image.
- While an image is flipped, you can use [◀] and [▶] to scroll to another image, if you want.

**3. To return the image to its normal orientation, press any button other than [▲], [▼], [◀], or [▶].**

### ▶▶ IMPORTANT! ◀◀

- Note that you cannot play a movie, an audio snapshot (EX-M20 only), or a voice recording file (EX-M20 only) on the monitor screen while a flipped image is displayed.
- You cannot use the above procedure to flip an image while a zoomed image, calendar screen image, a movie image, an audio snapshot (EX-M20 only), or a voice recording file image (EX-M20 only) is on the display.



## Zooming the Display Image

Perform the following procedure to zoom the image currently on the monitor screen up to four times its normal size.

**1. In the PLAY mode, use [◀] and [▶] to display the image you want.**

**2. Press [▲] (Q) to enlarge the image.**

- This displays an indicator that shows the current zoom factor.

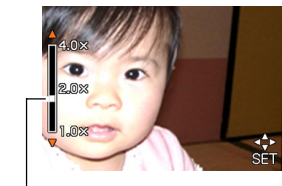

Current zoom factor

**3. To scroll the image on the display, press [SET], and then press [▲], [▼], [◀], or [▶].**

- To display the indicator for further zooming, press [SET] again.



**4. Press [MENU] to return the image to its original size.**

### ▶▶ IMPORTANT! ◀◀

- You cannot enlarge a movie image.
- Depending on the original size of the recorded image, you may not be able to zoom a display image the full four times its normal size.

## Resizing an Image

You can use the following procedure to change a snapshot image to either SXGA size (1280 x 960 pixels) or VGA size (640 x 480 pixels).

- VGA is the optimum image size for attachment to e-mail messages or incorporation into Web pages.

1. In the **PLAY** mode, press **[MENU]**.
2. Select the **“PLAY”** tab, select **“Resize”**, and then press **[▶]**.
3. Use **[◀]** and **[▶]** to scroll through images and display the one you want to resize.



4. Use **[▲]** and **[▼]** to select the setting you want, and then press **[SET]**.

To do this:	Select this:
Resize to 1280 x 960 pixels (SXGA)	1280 x 960
Resize to 640 x 480 pixels (VGA)	640 x 480
Cancel the resizing operation	Cancel

### ►► IMPORTANT! ◀◀

- Resizing an image creates a new file that contains the image in the size you select. The file with the original image also remains in memory.
- Images smaller than 640 x 480 pixels cannot be resized.
- An image recorded using the 1600 x 1072 (3:2) pixel size cannot be resized.
- Note that you can resize snapshots recorded with this camera only.
- If the message “This function is not supported for this file.” appears, it means that the current image cannot be resized.
- The resize operation cannot be performed if there is not enough memory to store the resized image.

## Cropping an Image

Use the following procedure when you want to crop a portion of an enlarged image and use the remaining part of the image as an e-mail attachment, Web page image, etc.

1. In the **PLAY** mode, use [**◀**] and [**▶**] to scroll through images and display the one you want to crop.

2. Press [**MENU**].

3. Select the “**PLAY**” tab, select “**Trimming**”, and then press [**▶**].

- This causes a cropping boundary to appear.

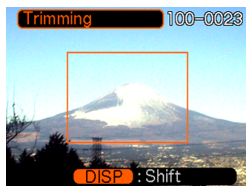

4. Use [**▲**] and [**▼**] to make the cropping boundary smaller or larger.

- The size of the cropping boundary depends on the size of the image on the display.

5. When the cropping boundary is the size you want, press [**DISP**] to lock it.

- After pressing [**DISP**] to lock the size of the cropping boundary, you can press [**DISP**] again to unlock it. After that, you can repeat steps 4 and 5 to change the cropping boundary size.

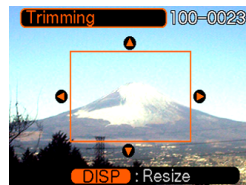

6. Use [**▲**], [**▼**], [**◀**], and [**▶**] to move the cropping boundary up, down, left, or right until the area of the image you want to extract is within the boundary.

7. Press [**SET**] to extract the part of the image enclosed in the cropping boundary.

- If you want to cancel the procedure at any point, press [**MENU**].

### ▶▶ IMPORTANT! ◀◀

- Cropping an image creates a new file that contains the cropped image. The file with the original image also remains in memory.
- An image recorded using the 1600 x 1072 (3:2) pixel size cannot be cropped.
- Movie and voice recording file images (EX-M20 only) cannot be cropped.
- An image recorded using another camera model cannot be cropped.
- If the message “This function is not supported for this file.” appears, it means that the current image cannot be cropped.
- The cropping operation cannot be performed if there is not enough memory to store the cropped image.

### Playing a Movie

Use the following procedure to play back a movie that was recorded in the movie mode.

- 1. In the PLAY mode, press [◀] and [▶] to scroll through images until the movie you want to play is displayed.**

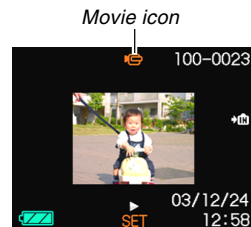

- 2. Press [SET].**

- This start playback of the movie.

## PLAYBACK

- You can perform the following operations while a movie is playing.

To do this:	Do this:
Fast forward or fast reverse the movie	Hold down [◀] or [▶].
Pause and unpause movie playback	Press [SET].
Skip forward or back one frame while paused	Press [◀] or [▶].
Cancel playback	Press [MENU].
Adjust audio volume (EX-M20 only)	Press [▲] or [▼].

### ▶▶ IMPORTANT! ◀◀

- You cannot repeat play a movie. To play a movie more than once, repeat the steps of the above procedure.
- The EX-M20 can also play back audio recordings. Note the following points when playing back audio.
  - Audio volume can be adjusted only when playback is being performed or is paused.
  - When you have the LCD remote controller connected to the camera, audio is output through the stereo headphones (page 160) instead of the camera's speaker. Output through the headphones is monaural.
  - The volume of audio recorded with the camera cannot be adjusted using the LCD remote controller. Use the camera's controller to adjust volume level in this case.

## Displaying the Calendar Screen



Use the following procedure to display a 1-month calendar. While the calendar is on the display, you can select a date, which displays the first image recorded on that date. This helps to make it easy to find the images you want.

1. In the **PLAY** mode, press **[MENU]**.
2. Select the **“PLAY”** tab, select **“Calendar”**, and then press **[▶]**.
3. Use **[▲]**, **[▼]**, **[◀]**, and **[▶]** to move the date selection cursor.

- Use the procedure under “Changing the Date Format” on page 120 to specify the date format.
- The image displayed on the calendar for each date is the first image that was recorded on that date.



Month/Year  
Date selection cursor

- Pressing **[▲]** while the date selection cursor is located anywhere in the top line of the calendar causes the previous month to appear.
  - Pressing **[▼]** while the date selection cursor is located anywhere in the bottom line of the calendar causes the next month to appear.
  - To exit the calendar screen, press **[MENU]**.
  -  is displayed in the calendar screen to indicate voice recording file images (page 95, EX-M20 only).
  -  appears in place of the image when the date contains data that cannot be displayed by this camera.
4. To view the large version of a date’s image, move the date selection cursor to the date, and then press **[SET]**.
    - This displays the first image that was recorded on the selected date.

## Playing a Slide Show

Slide Show automatically plays back images in sequence at a fixed interval.



1. In the **PLAY** mode, press **[MENU]**.
2. Select the “**PLAY**” tab, select “**Slideshow**”, and then press **[▶]**.

### 3. Configure the slideshow settings.

- See the pages indicated below for more information.

For information about configuring this setting:	Go here:
Images	“To specify the slideshow images” on page 88
Time	“To specify the slideshow time” on page 89
Interval	“To set the slideshow interval” on page 90

### 4. Use **[▲]** and **[▼]** to select “**Start**”, and then press **[SET]**.

- This starts the slide show.

### 5. To stop Slide Show, press **[SET]**.

- The slideshow will also stop automatically after the amount of time you specified for “Time” elapses.

**▶▶ IMPORTANT! ◀◀**

- Note that all buttons are disabled while an image change is in progress. Wait until an image is stopped on the monitor screen before performing a button operation, or hold down the button until the image stops.
- When the slideshow comes to a movie file, it plays the movie once and advances to the next file.
- When the slideshow comes to an audio snapshot or voice recording file, it plays the audio once and then advances to the next file (EX-M20 only).
- While audio is playing, you can use [▲] and [▼] to adjust the volume level (EX-M20 only).
- Images copied from another digital camera or a computer may take longer time to appear than the slideshow interval time you specify.

**To specify the slideshow images**

1. Use [▲] and [▼] to select “Images”, and then press [▶].
2. Use [▲] and [▼] to select the setting you want, and then press [SET].

To do this:	Select this setting:
Include all files in file memory in the slideshow	All images
Display a single file	One Image
Include all files in the FAVORITE folder (page 142) in the slideshow	Favorites

3. Use [▲] and [▼] to select “Start”, and then press [SET].

- This starts the slideshow.
- With the EX-M20, the audio of audio snapshot and voice recording files is also played back.



## ■ Selecting a Particular Image for a Slideshow

When you select “One image” as the slideshow type, the slide show displays only one image, without changing it. Use this setting when you want a particular image to remain on the display while the camera is on the USB cradle (Photo Stand feature).

1. Select “One image”, and then press [▶].
2. Use [◀] and [▶] to scroll through the images until the one you want to use is on the monitor screen.
3. Press [SET] to register your selection and return to the menu screen.
  - Pressing [MENU] instead of [SET] returns to the menu screen without registering the setting.



## To specify the slideshow time

1. Use [▲] and [▼] to select “Time”.
2. Use [◀] and [▶] to specify the time setting you want, and then press [SET].
  - You can specify a time in the range of 1 to 60 minutes.
3. Use [▲] and [▼] to select “Start”, and then press [SET].
  - This starts the slideshow.

## To set the slideshow interval

1. Use [▲] and [▼] to select “Interval”.
2. Use [◀] and [▶] to specify the interval setting you want, and then press [SET].
  - You can specify “MAX”, or a value in the range of 1 to 30 seconds as the interval.
  - When “MAX” is selected for the interval, only the first frame of movie files is played.
3. Use [▲] and [▼] to select “Start”, and then press [SET].
  - This starts the slideshow.

## Using the Photo Stand Feature

The “Photo Stand” feature lets you specify what should appear on the camera’s monitor screen while the camera is on its USB cradle. You can play a Photo Stand slideshow without worrying about remaining battery power, or you can specify display of a particular image. Photo Stand feature operations are performed in accordance with slideshow setting. See page 87 for information about configuring slideshow settings to suit your needs.

1. **After making sure the camera is turned off, place the camera onto the USB cradle.**
  - Do not place the camera onto the USB cradle while it is turned on.
2. **Press the USB cradle’s [PHOTO] button.**
  - This starts the Photo Stand slideshow with the images or image you specified under “To specify the slideshow images” (page 88).

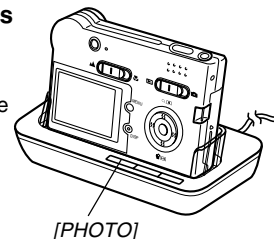

## PLAYBACK

- Pressing [MENU] displays a screen for configuring slideshow settings. To restart the slideshow, press [MENU] while the menu screen is displayed, or select “Start” and then press [SET].
- While audio is playing, you can use [▲] and [▼] to adjust the volume level (EX-M20 only).

### 3. To stop the Phot Stand slideshow, press [PHOTO] again.

#### ▶▶ IMPORTANT! ◀◀

- The battery is not charged while a Photo Stand slideshow is in progress. To charge the battery, stop the slideshow.

## Rotating the Display Image

Use the following procedure to rotate the image 90 degrees and register the rotation information along with the image. After you do this, the image is always displayed in its rotated orientation whenever it appears during a slideshow (page 87) or on your computer screen. Note that the image is rotated automatically during a slideshow only. Rotating an image ensures that images you recorded with the camera held sideways appear correctly during a slideshow.

1. In the PLAY mode, press [MENU].
2. Select the “PLAY” tab, select “Rotation”, and then press [▶].
3. Use [◀] and [▶] to scroll through images until the one you want to rotate is on the monitor screen.

**4. Use [▲] and [▼] to select “Rotate”, and then press [SET].**

- This rotates the image 90 degrees to the right.

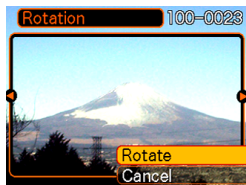

**5. After you are finished configuring settings, press the [MENU] button to exit the setting screen.**

**▶▶ IMPORTANT! ◀◀**

- You cannot rotate an image that is protected. To rotate such an image, first unprotect it.
- You may not be able to rotate a digital image that was recorded with another type of digital camera.
- You cannot rotate movie or voice record images (EX-M20 only).

## Using Image Roulette

Image Roulette cycles images like a slot machine on the display, before stopping at one of them. When you start an Image Roulette operation, images scroll randomly on the screen. At first, images scroll at high speed. Then the scrolling gradually slows down until a single image is stopped on the screen. The image that finally appears is random, and subject to no rules or system.

- 1. Align the mode selector with “▶” (PLAY).**
- 2. While the camera is turned off, hold down [◀] as you press the power button to turn it on.**
  - Keep [◀] held down until images appear on the monitor screen.
  - This starts the Image Roulette operation, scrolling images on the display, finally stopping at one.
- 3. Press [◀] or [▶] to restart the Image Roulette operation.**
- 4. To turn off Image Roulette, align the mode selector with “📷” (REC) to enter the REC mode or press the power button to turn off the camera.**

### ▶▶ IMPORTANT! ◀◀

- Image Roulette does not play movie files or display voice recording images (EX-M20 only).
- Image Roulette is disabled when there is only one snapshot image available.
- Note that Image Roulette works only with images recorded with this camera. Image Roulette may not operate properly when other types of images are in memory.
- If you do not start another Image Roulette operation for about one minute after the final image appears, the camera enters its normal PLAY mode.

### Adding Audio to a Snapshot (EX-M20 Only)

The “after-recording” feature lets you add audio to snapshots after they are recorded. You can also re-record an audio image (one with a  icon on it).

- **Audio Format: WAVE/ADPCM recording format**  
This is the Windows standard format for audio recording. The file extension of a WAVE/ADPCM file is “.WAV”.
- **Recording Time:**  
Up to about 30 seconds per image
- **Audio File Size:**  
Approximately 240KB (30-second recording of approximately 8KB per second)

1. In the PLAY mode, use [◀] and [▶] to scroll through snapshots until the one to which you want to add audio is displayed.
2. Press [MENU].
3. Select the “PLAY” tab, select “Dubbing”, and then press [▶].
4. Press the shutter release button to start audio recording.
5. Recording stops after about 30 seconds or when you press the shutter release button.



## To re-record audio

1. In the PLAY mode, use [◀] and [▶] to scroll through snapshots until the one whose audio you want to re-record is displayed.
2. Select the “PLAY” tab, select “Dubbing”, and then press [▶].
3. Use [▲] and [▼] to select “Delete”, and then press [SET].
  - If you merely want to delete the audio with re-recording, press [MENU] here to complete the procedure.
4. Press the shutter release button to start audio recording.
5. Recording stops after about 30 seconds or when you press the shutter release button.
  - This deletes the previous recording and replaces it with a new one.

### ▶▶ IMPORTANT! ◀◀

- Keep the microphone on the front of the camera pointed at the subject.
  - Take care that you do not block the microphone with your fingers.
- 
- Microphone*
- Good recording results are not possible when the camera is too far from the subject.
  - Operating camera buttons during recording can cause button noise to be included in the audio.
  - The (Audio) icon appears on the monitor screen after audio recording is complete.
  - You will not be able to record audio when remaining memory capacity is low.
  - The following types of audio recording are not supported.
    - Adding audio to a movie image
    - Adding audio to a protected snapshot (page 100)
  - Audio that is re-recorded or deleted cannot be recovered. Make sure you no longer need audio before re-recording or deleting it.

### Playing Back a Voice Recording File (EX-M20 Only)

Perform the following steps to play back a voice recording file.

**1. In the PLAY mode, use [◀] and [▶] to display the voice file (a file with on it) you want to play.**

**2. Press [SET].**

- This starts playback of the voice recording file through the camera's speaker.
- You can perform the following operations while audio is playing.

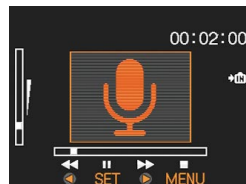

To do this:	Do this:
Fast forward or fast reverse the audio	Hold down [◀] or [▶].
Pause and unpause audio playback	Press [SET].
Adjust audio volume	Press [▲] or [▼].
Cancel playback	Press [MENU].

### ▶▶ IMPORTANT! ◀◀

- Audio volume can be adjusted only when playback is being performed or is paused.
- If your recording has index marks (page 69) inside it, you can jump to the index mark before or after the current playback location by pausing playback and then pressing [◀] or [▶]. Next, press [SET] to resume playback from the index mark position.
- When you have the LCD remote controller connected to the camera, audio is output through the stereo headphones (page 160) instead of the camera's speaker. Output through the headphones is monaural.
- The volume of audio recorded with the camera cannot be adjusted using the LCD remote controller. Use the camera's controller to adjust volume level in this case.



# DELETING FILES

You can delete a single file, or you can delete all files currently in memory.

## »» IMPORTANT! ««

- Note that file deletion cannot be undone. Once you delete a file, it is gone. Make sure you really do not need a file anymore before you delete it. Especially when deleting all files, make sure you check all the files you have stored before proceeding.
- A protected file cannot be deleted. To delete a protected file, unprotect it first (page 100).
- Delete cannot be performed when all the files in memory are protected (page 101).
- On the EX-M20, deleting an audio snapshot deletes both the image file and the audio file attached to it.

## Deleting a Single File

Perform the following steps when you want to delete a single file.

1. In the **PLAY** mode, press [▼] (🗑️).



2. Use [◀] and [▶] to scroll through files and display the one you want to delete.
3. Use [▲] and [▼] to select “Delete”.
  - To exit the file delete operation without deleting anything, select “Cancel”.
4. Press [SET] to delete the file.
  - Repeat steps 2 through 4 to delete other files, if you want.
5. Press [MENU] to exit the menu screen.

## DELETING FILES

### ►► IMPORTANT! ◀◀

- If a file cannot be deleted for some reason, the message “This function is not supported for this file.” appears when you try to delete it.

### Deleting All Files

The following procedure deletes all unprotected files currently in memory.

- 1. In the PLAY mode, press [▼] (🏠).**
- 2. Use [▲] and [▼] to select “All Files Delete”, and then press [SET].**
- 3. Use [▲] and [▼] to select “Yes”.**
  - To exit the file delete operation without deleting anything, select “No”.
- 4. Press [SET] to delete all the files.**

# FILE MANAGEMENT

The file management capabilities of the camera make it easy to keep track of images. You can protect files against deletion, and even use its DPOF feature to specify images for printing.

## Folders

Your camera automatically creates a directory of image storage folders in its built-in Flash memory or on the memory card.

## Memory Folders and Files

An image you record is automatically stored in a folder, whose name is a serial number. You can have up to 900 folders in memory at the same time. Folder names are generated as shown below.

Example: Name of the 100th folder.

100CASIO

*Serial number (3 digits)*

Each folder can hold files numbered up to 9,999. Trying to store the 10,000th file in a folder causes the next serially numbered folder to be created. Folder names are generated as shown below.

Example: Name of the 26th file

CIMG0026.JPG

*Extension*

*Serial number (4 digits)*

- The actual number of files you will be able to store on a memory card depends on the image quality settings, capacity of the card, etc.
- For details about the directory structure, see “Memory Directory Structure” on page 142.

## Protecting Files

Once you protect a file it cannot be deleted (page 97). You can protect files individually or you can protect all files in memory with a single operation.

### To protect a single file

1. In the **PLAY** mode, press **[MENU]**.
2. Select the “**PLAY**” tab, select “**Protect**”, and then press **[▶]**.
 
3. Use **[◀]** and **[▶]** to scroll through files and display the one you want to protect.

4. Use **[▲]** and **[▼]** to select “**On**”, and then press **[SET]**.

- A file that is protected is indicated by the  mark.
- To unprotect a file, select “**Off**” in step 4, and then press **[SET]**.



5. Press **[MENU]** to exit the menu screen.

## To protect all files in memory

1. In the **PLAY** mode, press **[MENU]**.
2. Select the **“PLAY”** tab, select **“Protect”**, and then press **[▶]**.
3. Use **[▲]** and **[▼]** to select **“All Files : On”**, and then press **[SET]**.
  - To unprotect all files, press **[SET]** in step 3 so the setting shows **“All Files : Off”**.
4. Press **[MENU]** to exit the menu screen.

## DPOF

The letters “DPOF” stand for “Digital Print Order Format”, which is a format for recording on a memory card or other medium which digital camera images should be printed and how many copies of the image should be printed. Then you can print on a DPOF-compatible printer or at a professional print service in accordance with the file name and number of copies settings recorded on the card.

With this camera, you should always select images by viewing them on the monitor screen. Do not specify images by file name without viewing the file contents.



### ■ DPOF Settings

File Name,  
number of copies,  
date

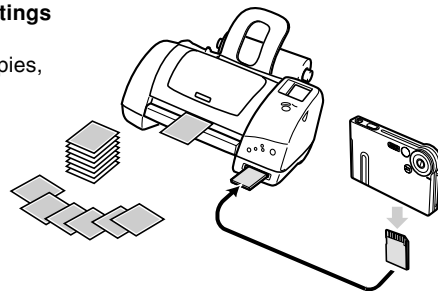

## To configure print settings for a single image

1. In the PLAY mode, press [MENU].
2. Select the “PLAY” tab, select “DPOF”, and then press [▶].



3. Use [▲] and [▼] to select “Select images”, and then press [▶].
4. Use [◀] and [▶] to display the image you want.



5. Use [▲] and [▼] to specify the number of copies.

- You can specify up to 99 for the number of copies. Specify 00 if you do not want to have the image printed.

6. To turn on date stamping for the prints, press [DISP] so  is displayed.

- To turn off date stamping for the prints, press [DISP] so  is not displayed.
- Repeat steps 4 through 6 if you want to configure other images for printing.



7. After all the settings are the way you want, press [SET] to apply them.

## To configure print settings for all images

1. In the PLAY mode, press [MENU].
2. Select the “PLAY” tab, select “DPOF”, and then press [▶].
3. Use [▲] and [▼] to select “All images”, and then press [▶].
4. Use [▲] and [▼] to specify the number of copies.

- You can specify up to 99 for the number of copies. Specify 00 if you do not want to have the image printed.



5. To turn on date stamping for the prints, press [DISP] so  is displayed.
  - To turn off date stamping for the prints, press [DISP] so  is not displayed.
6. After all the settings are the way you want, press [SET] to apply them.

### PRINT Image Matching II

Images include PRINT Image Matching II data (mode setting and other camera setup information). A printer that supports PRINT Image Matching II reads this data and adjusts the printed image accordingly, so your images come out just the way you intended when you recorded them.

\* Seiko Epson Corporation holds the copyright for PRINT Image Matching and PRINT Image Matching II.



### Exif Print

Exif Print is an internationally supported, open standard file format that makes it possible to capture and display vibrant digital images with accurate colors. With Exif 2.2, files include a wide range of shooting condition information that can be interpreted by an Exif Print printer to produce better-looking prints.



#### ▶▶ IMPORTANT! ◀◀

- Information about the availability of Exif Print compatible printer models can be obtained from each printer manufacturer.



### Using USB DIRECT-PRINT

Your camera supports USB DIRECT-PRINT, which was developed by Seiko Epson Corporation. When connected directly to a printer that supports USB DIRECT-PRINT, you can select images to be printed and start the print operation directly from the camera.

DPOF settings (page 101) are used to determine which images and how many copies should be printed.



1. Use the DPOF procedure on page 101 to specify the images in file memory that you want to print.
2. Use the USB cable that comes with the camera to connect the USB cradle to a printer.

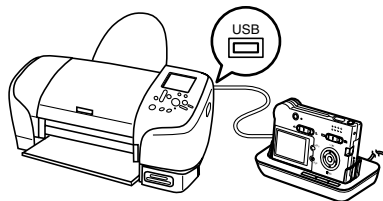

- Also, connect the AC adaptor to the USB cradle and plug the AC adaptor into an electrical outlet.
3. Set the camera on the USB cradle.
  4. Turn on the printer.
  5. Load paper for printing the images into the printer.

## 6. Press the USB cradle [USB] button.

- This displays the print menu on the camera's monitor screen.

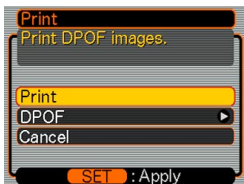

## 7. On the camera's monitor screen, use [▲] and [▼] to select "Print", and then press [SET].

- This automatically starts printing of the images you specified with the DPOF procedure.
- If you want to print the same batch of images again, press the [USB] button on the USB cradle.
- A message appears on the monitor screen, followed by the DPOF setting screen (page 102), if there are no DPOF settings currently configured on the camera to control the printing operation. If this happens, configure the required DPOF settings and then perform step 6 of the above procedure again.
- If you want to change the current DPOF settings, select "DPOF" on the print menu to display the DPOF setting screen (page 102).

## 8. After printing is complete, turn off the camera and remove it from the USB cradle.

## »» IMPORTANT! ««

- See the documentation that comes with your printer for information about print quality and paper settings.
- Contact your printer manufacturer for information about models that support USB DIRECT-PRINT, upgrades, etc.
- Never disconnect the USB cable, or perform any camera or USB cradle operation while printing is in progress. Doing so causes a printer error.
- To interrupt an ongoing print operation, perform the required operation on the printer.
- The camera's monitor screen will go blank after printing starts. A blank monitor screen does not necessarily mean that printing is complete. Check the status of your printer to find out if printing is complete.

## Using the FAVORITE Folder

You can copy scenery shots, photos of your family, or other special images from a file storage folder (page 142) to the FAVORITE folder in built-in memory (page 142). Images in the FAVORITE folder are not displayed during normal playback, so it helps to keep your personal image private as you carry them around. FAVORITE folder images are not deleted when you change memory cards, so you can always keep them on hand.

### To copy a file to the FAVORITE folder

1. In the PLAY mode, press [MENU].
2. Select the "PLAY" tab, select "Favorites", and then press [▶].

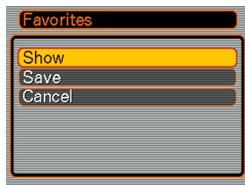

3. Use [▲] and [▼] to select "Save", and then press [SET].

- This displays the names of the files in built-in memory or on the loaded memory card.



4. Use [◀] and [▶] to select the file you want to copy to the FAVORITE folder.

5. Use [▲] and [▼] to select "Save", and then press [SET].

- This copies the displayed file to the FAVORITE folder.

6. After copying all of the files you want, use [▲] and [▼] to select "Cancel", and then press [SET] to exit.

### »» NOTES ««

- Copying an image file with the above procedure creates a 320 x 240-pixel QVGA-size image in the FAVORITE folder.
- A file copied into the FAVORITE folder is automatically assigned a file name that is a serial number. Though the serial number starts from 0001 and can go as high as 9999, the actual upper end of the range depends on built-in memory capacity. Remember that the maximum number of images that can be stored in built-in memory depends on the size of each image and other factors.

### To display a file in the FAVORITE folder

1. In the PLAY mode, press [MENU].
2. Select the “PLAY” tab, select “Favorites”, and then press [▶].
3. Use [▲] and [▼] to select “Show”, and then press [SET].
  - If the FAVORITE folder is empty, the message “No Favorites file!” appears.
4. Use [▶] (forward) and [◀] (back) to scroll through the files in the FAVORITE folder.
5. After you are finished viewing files, press [MENU] twice to exit.



### ►► NOTE ◀◀

- Holding down [◀] or [▶] scrolls images at high speed.

### ►► IMPORTANT! ◀◀

- Note that a FAVORITE folder is created in the camera's built-in memory only. No FAVORITE folder is created on a memory card when you use one. If you want to view the contents of the FAVORITE folder on your computer screen, you need to remove the memory card from the camera (if you are using one) before placing the camera onto the USB cradle to start data communication (pages 131, 142).

## To delete a file from the FAVORITE folder

1. In the PLAY mode, press [MENU].
2. Select the "PLAY" tab, select "Favorites", and then press [▶].
3. Use [▲] and [▼] to select "Show", and then press [SET].
4. Press [▼] (📁).
5. Use [◀] and [▶] to select the file you want to delete from the FAVORITE folder.
6. Use [▲] and [▼] to select "Delete", and then press [SET].
  - To exit the file delete operation without deleting anything, select "Cancel".
7. After deleting all of the files you want, use [▲] and [▼] to select "Cancel", and then press [SET] to exit.

### ▶▶ IMPORTANT! ◀◀

- You cannot use the delete operations on page 97 to delete images from the FAVORITE folder. Performing the memory format operation (page 123), however, does delete FAVORITE folder files.

## To delete all files from the FAVORITE folder

1. In the PLAY mode, press [MENU].
2. Select the “PLAY” tab, select “Favorites”, and then press [▶].
3. Use [▲] and [▼] to select “Show”, and then press [SET].
4. Press [▼] (🗑️).
5. Use [▲] and [▼] to select “All File Delete”, and then press [SET].

### ▶▶ IMPORTANT! ◀◀

- You cannot use the delete operations on page 97 to delete images from the FAVORITE folder. Performing the memory format operation (page 123), however, does delete FAVORITE folder files.

# OTHER SETTINGS

## Turning the Key Tone On and Off (EX-S20)

Use the following procedure to turn the tone that sounds when you press a key on and off.

1. In the REC mode or the PLAY mode, press [MENU].
2. Select the “Set Up” tab, select “Beep”, and then press [▶].
3. Use [▲] and [▼] to change the setting, and then press [SET].

To do this:	Select this setting:
Turn on the key tone	On
Turn off the key tone	Off

## Configuring Sound Settings (EX-M20)

With the EX-M20, you can configure separate sounds for startup, shutter release, and key operations.

### To configure sound settings

1. In the REC mode or the PLAY mode, press [MENU].
2. Select the “Set Up” tab, select “Sounds”, and then press [▶].
3. Use [▲] and [▼] to select the sound whose setting you want to configure, and then press [▶].

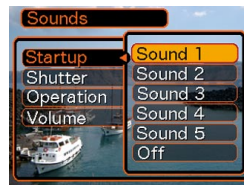

## OTHER SETTINGS

4. Use [▲] and [▼] to change the setting, and then press [SET].

To do this:	Select this setting:
Select a built-in sound	Sound 1 through Sound 5
Turn off the sound	Off

### NOTE

- The default sound setting for all operations is “Sound 1”.

## To set the volume level

1. In the REC mode or the PLAY mode, press [MENU].
2. Select the “Set Up” tab, select “Sounds”, and then press [▶].
3. Use [▲] and [▼] to select “Volume”.
4. Use [◀] and [▶] to specify the volume setting you want, and then press [SET].
  - You can set the volume in the range of 0 (no sound) to 7 (loudest).

### NOTE

- The initial default volume setting is 3.



## Specifying an Image for the Startup Screen

You can specify an image you recorded with the camera as the startup screen image, which causes it to appear on the monitor screen for about two seconds whenever you turn on the camera.

1. In the **REC** mode or the **PLAY** mode, press **[MENU]**.
2. Select the “Set Up” tab, select “Startup”, and then press **[▶]**.
3. Use **[◀]** and **[▶]** to display the image you want to use as the startup image.
4. Use **[▲]** and **[▼]** to change the setting, and then press **[SET]**.

To do this:	Select this setting:
Use the currently displayed image as the startup screen image	On
Disable the startup screen	Off

### ►► IMPORTANT! ◀◀

- You can select any one of the following types of image as the startup image.
  - The camera’s built-in startup image
  - A snapshot you recorded with the camera
  - An audio snapshot you recorded with the camera (EX-M20 only)
  - A movie you recorded with the camera 200KB or less in size
- The snapshot image or movie that you select as the startup image is stored in a special memory location called “startup image memory”. Only one image can be stored in startup image memory at one time. Selecting a new startup image overwrites anything that is already stored in startup image memory. Because of this, if you want to return to a previous startup image, you need to have a separate copy of that image in the camera’s standard image memory.
- The startup image is deleted by the format operation (page 123).
- If you store an audio snapshot to startup image memory (EX-M20 only), the image’s audio is not played when the image is displayed at startup.

### Configuring Power Down Image Settings

With the Power Down Image feature, you can configure the camera so a specific image stored in camera image memory appears whenever you turn off power. You can specify a snapshot or a movie as the power down image.

#### ■ To configure power down image settings

- 1. Use the USB cable to connect the camera to your computer (page 131).**
- 2. Move the image data that you want to use for the power down image to the top (root) directory of the camera's built-in Flash memory.**
  - The file name extension will not be displayed if your computer is configured to hide file name extensions.  
Example: CIMG0001
  - If your power down image is stored on a memory card, be sure to copy the image to built-in memory before removing the memory card from the camera.

#### **3. Change the name of the file to one of the following.**

Snapshot Image: ENDING.JPG

Movie Image: ENDING.AVI

- Input the following file name only (without file name extension) if your computer is configured to hide file name extensions.  
File Name: ENDING
- Your camera is now configured to display a power down image. The power down image will appear any time you press the power button to turn off the camera. The power down image appears regardless of whether or not your camera has a memory card loaded in it.

### ▶▶ IMPORTANT! ◀◀

- Only a snapshot (JPEG) or movie (AVI) file can be used as the power down image.
- Note that the Power Down Image feature works only with images recorded with this camera. The Power Down Image feature may not operate properly when another type of image is specified as the power down image.
- Formatting the camera's Flash memory deletes the power down image.
- When both a still image and a movie are present for the power down image, only the movie is used.
- Note that a power down image display operation cannot be interrupted once it starts. Because of this, you should select a relatively short movie when using a movie file as the power down image.

### ■ To cancel Power Down Image settings

- 1. Use the USB cable to connect the camera to your computer (page 131).**
- 2. Change the name of the current power down image from ENDING.JPG or ENDING.AVI to something else, or delete the current power down image from Flash memory.**

### Specifying the File Name Serial Number Generation Method

Use the following procedure to specify the method for generating the serial number used for file names (page 99).

1. In the **REC** mode or the **PLAY** mode, press **[MENU]**.
2. Select the “Set Up” tab, select “File No.,” and then press **[▶]**.
3. Use **[▲]** and **[▼]** to change the setting, and then press **[SET]**.

To do this for a newly saved file:	Select this setting:
Store the last file number used and increment it, regardless of whether files are deleted or whether the memory card is replaced with a new one	Continue
Find the highest file number in the current folder and increment it	Reset

### Using the Alarm

You can configure up to three alarms that cause the camera to beep and display a specified image at the time you specify.

#### To set an alarm

1. In the **PLAY** mode, press **[MENU]**.
2. Select the **“PLAY”** tab, select **“Alarm”**, and then press **[▶]**.
3. Use **[▲]** and **[▼]** to select the alarm whose setting you want to configure, and then press **[▶]**.
4. Use **[◀]** and **[▶]** to select the setting you want to change, and then use **[▲]** and **[▼]** to change the selected setting.
  - You can set an alarm time and configure the alarm to sound either once or at the same time everyday. You can also turn the alarm on or off.

#### 5. Press **[DISP]**.

- You could press **[SET]** in place of **[DISP]** if you want to configure the alarm without an image.

#### 6. Use **[◀]** and **[▶]** to select the scene you want to appear at the alarm time, and then press **[SET]**.

#### 7. After all the settings are the way you want, press **[SET]**.

- You can configure up to three alarms, named “Alarm 1”, “Alarm 2”, and “Alarm 3”.

## Stopping the Alarm

When an alarm time is reached while the camera is turned off, the alarm will sound for about one minute (or until you stop it), and then the camera will turn on. To stop the alarm after it starts to sound, press any button. If the camera is on the USB cradle when an alarm sounds, you can stop it by pressing the USB cradle [USB] button or [PHOTO] button, or any camera button.

### ▶▶ IMPORTANT! ◀◀

- Note that the alarm sounds only if the alarm time is reached when any one of the following conditions exists.
  - While the camera is turned on
  - While a USB data communication operation is in progress
  - While a Photo Stand operation is in progress

## Setting the Clock

Use the procedures in this section to select a Home Time Zone, and to change its date and time settings.

### ▶▶ IMPORTANT! ◀◀

- Make sure you select your Home Time zone (the zone where you are currently located) before changing the time and date settings. Otherwise, the time and date setting will change automatically when you select another time zone.

## To select your Home Time zone

1. In the REC mode or the PLAY mode, press [MENU].
2. Select the “Set Up” tab, select “World Time”, and then press [▶].
  - This displays the current World Time zone.
3. Use [▲] and [▼] to select “Home”, and then press [▶].

## OTHER SETTINGS

4. Use [▲] and [▼] to select “City”, and then press [▶].
5. Use [▲], [▼], [◀], and [▶] to select the geographical area that contains location you want to select as your Home Time zone, and then press [SET].
6. Use [▲] and [▼] to select the city you want, and then press [SET].
7. After selecting the city you want, press [SET] to register its zone as your Home Time zone.

## To set the current time and date

1. In the REC mode or the PLAY mode, press [MENU].
2. Select the “Set Up” tab, select “Adjust”, and then press [▶].
3. Set the current date and the time.

To do this:	Do this:
Change the setting at the current cursor location	Press [▲] or [▼].
Move the cursor between settings	Press [◀] or [▶].
Toggle between 12-hour and 24-hour timekeeping	Press [DISP].

4. When all the settings are the way you want, press [SET] to register them and exit the setting screen.

## Changing the Date Format

You can select from among three different formats for display of the date.

1. In the **REC** mode or the **PLAY** mode, press **[MENU]**.
2. Select the “Set Up” tab, select “Date Style”, and then press **[▶]**.
3. Use **[▲]** and **[▼]** to change the setting, and then press **[SET]**.

Example: December 24, 2003

To display the date like this:	Select this format:
03/12/24	YY/MM/DD
24/12/03	DD/MM/YY
12/24/03	MM/DD/YY

## Using World Time

You can use the World Time screen to view a time zone that is different from the home time zone when you go on a trip, etc. World Time can display the time in one of 162 cities in 32 time zones.

### To display the World Time screen

1. In the **REC** mode or the **PLAY** mode, press **[MENU]**.
2. Select the “Set Up” tab, select “World Time”, and then press **[▶]**.
  - This displays the current World Time zone.
3. Use **[▲]** and **[▼]** to select “World”.

To do this:	Select this:
Display the time in your home time zone	Home
Display the time in a different time zone	World

4. Press **[SET]** to exit the setting screen.



## To configure World Time settings

1. In the REC mode or the PLAY mode, press [MENU].
2. Select the “Set Up” tab, select “World Time”, and then press [▶].
  - This displays the current World Time zone.
3. Use [▲] and [▼] to select “World”, and then press [▶].
4. Use [▲] and [▼] to select “City”, and then press [▶].
5. Use [▲], [▼], [◀], and [▶] to select the geographical area you want, and then press [SET].



6. Use [▲] and [▼] to select the city you want, and then press [SET].

- This displays the current time in the city you select.



7. When the setting is the way you want, press [SET] to apply it and exit the setting screen.

## To configure summer time (DST) settings

1. In the REC mode or the PLAY mode, press [MENU].
2. Select the “Set Up” tab, select “World Time”, and then press [▶].
  - This displays the current World Time Settings.
3. Use [▲] and [▼] to select “World”, and then press [▶].
  - If you want to configure Home Time settings, select “Home” instead.
4. Use [▲] and [▼] to select “DST”, and then press [▶].
5. Use [▲] and [▼] to select the summer time (DST) setting you want.

To do this:	Select this:
Advance the current time setting by one hour	On
Display the current time as-is	Off

6. After the setting is the way you want, press [SET].

- This displays the current time in accordance with your setting.

7. Press [SET] again to exit the setting screen.

## Changing the Display Language

You can use the following procedure to select one of ten languages as the display language.

1. In the **REC mode** or the **PLAY mode**, press **[MENU]**.
2. Select the “Set Up” tab, select “Language”, and then press **[▶]**.
3. Use **[▲]**, **[▼]**, **[◀]**, and **[▶]** to change the setting, and then press **[SET]**.

日本語	: Japanese
English	: English
Français	: French
Deutsch	: German
Español	: Spanish
Italiano	: Italian
Português	: Portuguese
中國語	: Chinese (Complex)
中国語	: Chinese (Simplified)
한국어	: Korean

## Formatting Built-in Memory

Formatting built-in memory deletes any data stored in it.

### ▶▶ IMPORTANT! ◀◀

- Note that data deleted by a format operation cannot be recovered. Check to make sure you do not need any of the data in memory before you format it.
- Formatting built-in memory deletes all files, including files in the FAVORITE folder (page 107), protected files (page 100), and BESTSHOT user setups (page 60).
- The startup screen image (page 113) is deleted by formatting memory.

1. **Check to make sure there is no memory card loaded in the camera.**
  - If there is a memory card loaded in the camera, remove it (page 126).
2. In the **REC mode** or the **PLAY mode**, press **[MENU]**.

## OTHER SETTINGS

- 3. Select the “Set Up” tab, select “Format”, and then press [▶].**
- 4. Use [▲] and [▼] to select “Format”, and then press [SET].**
  - To exit the format operation without formatting, select “Cancel”.

# USING A MEMORY CARD

You can expand the storage capabilities of your camera by using a commercially available memory card (SD memory card or MultiMediaCard). You can also copy files from built-in flash memory to a memory card and from a memory card to flash memory.



- Normally, files are stored in built-in flash memory. When you insert a memory card, however, the camera automatically stores files to the card.
- Note that you cannot save files to built-in memory while a memory card is installed in the camera.

## ►► IMPORTANT! ◀◀

- Use only an SD memory card or a MultiMediaCard with this camera. Proper operation is not guaranteed when any other type of card is used.
- See the instructions that come with the memory card for information about how to use it.
- Certain types of cards can slow down processing speeds.
- SD memory cards have a write protect switch, which you can use to protect against accidental deletion of image data. Note, however, if you write protect an SD memory card, you must remove write protection whenever you want to record to it, format it, or delete any of its files.
- Electrostatic charge, electrical noise, and other phenomena can cause data to become corrupted or even lost. Always make sure that you always back up important data on other media (CD-R, CD-RW, MO disc, computer hard disk, etc.)

### Using a Memory Card

#### ▶▶ IMPORTANT! ◀◀

- Make sure you turn off the camera before inserting or removing a memory card.
- Be sure to orient the card correctly when inserting it. Never try to force a memory card into the slot when you feel resistance.

### To insert a memory card into the camera

1. Positioning the memory card so its back is facing in the same direction as the camera's lens, carefully slide it into the card slot.

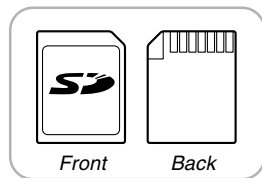
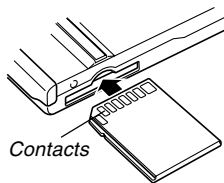

### To remove a memory card from the camera

1. Press the memory card into the camera and then release it. This will cause the card to come part way out of the camera.
2. Pull the memory card out of the slot.

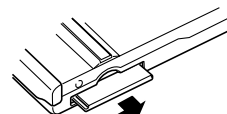
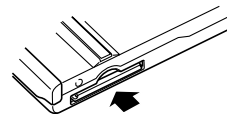

### ▶▶ IMPORTANT! ◀◀

- Never insert any other object besides a memory card into the camera's card slot. Doing so creates the risk of damage to the camera and card.
- Should water or any foreign object ever get into the card slot, immediately turn off the camera, remove the battery, and contact your dealer or nearest CASIO authorized service center.
- Never remove a card from the camera while the operation/flash charge lamp is flashing. Doing so can cause the file save operation to fail, and even damage the memory card.

## Formatting a Memory Card

Formatting a memory card deletes any data already stored on it.

### ▶▶ IMPORTANT! ◀◀

- Be sure to use the camera to format a memory card. Formatting a memory card on a computer and then using it in the camera can slow down data processing by the camera. In the case of an SD card, formatting on a computer can result in non-conformity with the SD format, causing problems with compatibility, operation, etc.
- Note that data deleted by a memory card format operation cannot be recovered. Check to make sure you do not need any of the data on the memory card before you format it.
- Formatting a memory card that contains files deletes all the files, even those that are protected (page 100).

1. Load the memory card into the camera.
2. Turn on the camera. Next, enter the REC mode or PLAY mode and press [MENU].
3. Select the “Set Up” tab, select “Format”, and then press [▶].
4. Use [▲] and [▼] to select “Format”, and then press [SET].
  - To exit the format operation without formatting, select “Cancel”.

## Memory Card Precautions

- If a memory card starts to behave abnormally, you can restore normal operation by reformatting it. However, we recommend that you always take along more than one memory card whenever using the camera far away from the home or office.
- We recommend that you format a memory card before using it for the first time after purchasing it, or whenever the card you are using seems to be the cause of abnormal images.
- Before starting a format operation, check to make sure that the battery is fully charged. Power interruption during the format operation can result in improper formatting, and even damage the memory card and make it unusable.



### Copying Files

Use the procedures below to copy files between built-in memory and a memory card.

#### ►► IMPORTANT! ◀◀

- Only snapshot, movie files, audio snapshot (EX-M20 only), and voice recording files (EX-M20 only) recorded with this camera can be copied. Other files cannot be copied.
- Copying an audio snapshot (EX-M20 only) copies both the image file and the audio file.

### To copy all the files in built-in memory to a memory card

1. Load the memory card into the camera.
2. Turn on the camera. Next, enter the PLAY mode and press [MENU].
3. Select the “PLAY” tab, select “Copy”, and then press [▶].



4. Use [▲] and [▼] to select “Built-in → Card”, and then press [SET].
  - This starts the copy operation and displays the message “Busy.... Please wait...”.
  - After the copy operation is complete, the monitor screen shows the last file in the folder.

### To copy a file from a memory card to built-in memory

With this procedure you can copy one file at a time.

- 1. Perform steps 1 through 3 of the procedure under “To copy all the files in built-in memory to a memory card”.**
- 2. Use [▲] and [▼] to select “Card → Built-in”, and then press [SET].**
- 3. Use [◀] and [▶] to select the file you want to copy.**
- 4. Use [▲] and [▼] to select “Copy”, and then press [SET].**
  - This starts the copy operation and displays the message “Busy.... Please wait...”.
  - The file reappears on the monitor screen after the copy operation is complete.
  - Repeat steps 3 through 4 to copy other images, if you want.
- 5. Press [MENU] to exit the copy operation.**

#### NOTE

- Files are copied to the folder in built-in memory whose name has the largest number.

# VIEWING IMAGES ON A COMPUTER

After using the USB cradle to establish a USB connection between the camera and your computer, you can use your computer to view images in file memory and copy images to your computer's hard disk or other storage media. In order to do this, you first need to install the USB driver located on the CD-ROM that comes bundled with the camera onto your computer.

Note that the procedure you need to perform depends on whether you are using computer running under Windows (see below) or a Macintosh (see page 136).

## Using the Camera with a Windows Computer

The following are the general steps for viewing and copying files from a computer running under Windows. You can find details about each operation in the procedures that follow below. Note that you should also refer to the documentation that comes with your computer for other information about USB connections, etc.

1. If you are running Windows 98, Me, or 2000, install the USB driver onto your computer.
  - You need to perform this step only once, the first time you connect to your computer.
  - If you are running Windows XP, you do not need to install the USB driver.



2. Use the USB cradle to establish a connection between the camera and computer.



3. View and copy the images you want.

## VIEWING IMAGES ON A COMPUTER

### »» IMPORTANT! ««

- Do not try to establish a connection between the camera and computer before installing the USB driver onto the computer.
- If you want to transfer files from the camera's built-in memory to a computer, make sure there is no memory card loaded in the camera before you place it onto the USB cradle.

### 1. What you should do first depends on whether your computer is running under Windows 98/Me/2000 or Windows XP.

#### ■ Windows 98/Me/2000 Users

- Start from step 2 to install the USB driver.
- Note that the example installation presented here uses Windows 98.

#### ■ Windows XP Users

- Installation of the USB driver is not required, so jump directly to step 6.

### 2. Set the bundled CD-ROM into the CD-ROM drive of your computer.

### 3. On the menu screen that appears, click “English”.



### 4. Click [USB driver] and then [Install].

- This starts installation.
- The following steps show installation under the English version of Windows.

### 5. On the screen that appears after installation is complete, select the “Yes, I want to restart my computer now.” check box and then click [Finish] to restart your computer.

## VIEWING IMAGES ON A COMPUTER

6. Connect the AC power cord to the bundled AC adaptor, and then plug the other end of the AC power cord into a household power outlet.
7. Connect the AC adaptor to the [DC IN 5.3V] connector of the USB cradle.

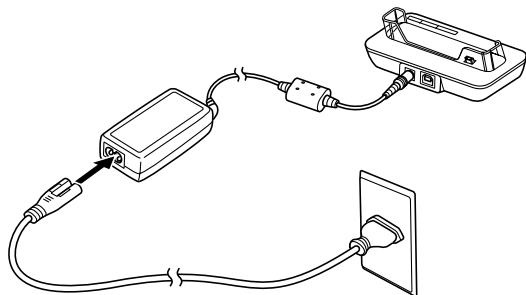

8. Connect the USB cable that comes bundled with the camera to the USB cradle and your computer's USB port.

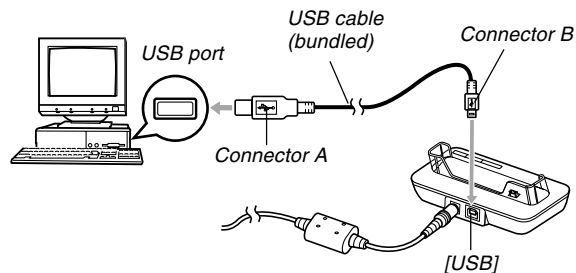

- Take care when connecting the USB cable to the USB cradle or your computer. USB ports and cable plugs are shaped for proper positioning.
- Plug the USB cable plugs into the ports securely, as far as they will go. Proper operation is not possible if connections are not correct.

### 9. After making sure the camera is turned off, place the camera onto the USB cradle.

- Do not place the camera onto the USB cradle while it is turned on.

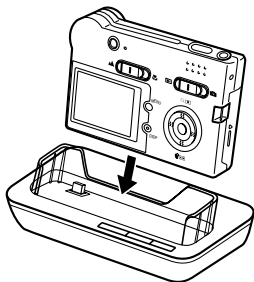

### 10. Press the USB cradle's [USB] button.

- This will cause the “Add New Hardware...” dialog box to appear on the computer screen as the computer automatically detects the camera’s file memory. After you install the USB driver, “Add New Hardware...” dialog box will no longer appear when you perform the above steps to establish a USB connection.
- Pressing the [USB] button enters the USB mode, which causes the USB cradle’s [USB] lamp to light green (page 177).
- At this point, some operating systems will display a “Removable Disk” dialog box. If your operating system does, close the dialog box.

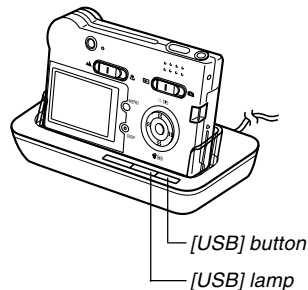

11. On your computer, double-click “My Computer”.
12. Double-click “Removable Disk”.
  - Your computer sees the camera’s file memory as a removable disk.
13. Double-click the “Dcim” folder.
14. Double-click the folder that contains the image you want.
15. Double-click the file that contains the image you want to view.
  - For information about file names, see “Memory Directory Structure” on page 142.
16. To copy all the files in file memory to your computer’s hard disk, drag the “Dcim” folder from “Removable Disk” to the “My Documents” folder on your computer.

### ▶▶ IMPORTANT! ◀◀

- Never use your computer to edit, delete, move, or rename images stored in file memory. Doing so can cause problems with the image management data used by the camera, which may make it impossible to display images on the camera or it may cause a large error in the number of images value displayed by the camera. Always copy images to your computer memory before performing any edit, delete, move, or rename operation.
17. Depending on the version of Windows you are running, use one of the following procedures to terminate the USB connection.
    - **WindowsMe/98 Users**
      - After pressing the USB cradle [USB] button and making sure that the [USB] lamp is not lit, remove the camera from the USB cradle.
    - **Windows2000/XP Users**
      - Click card services in the task tray on your computer screen, and disable the drive number assigned to the camera. After pressing the USB cradle [USB] button and making sure that the [USB] lamp is not lit, remove the camera from the USB cradle.

### USB Connection Precautions

- Be sure to read the documentation that comes with your computer for other important information about USB connections.
- Be sure to connect the AC adaptor to the USB cradle to supply power to the camera.
- USB data communication is performed regardless of the current setting of the camera's mode selector.
- Do not leave the same image displayed on your computer screen for a long time. Doing so can cause the image to "burn in" on the screen.
- Never disconnect the USB cable, or perform any camera or USB cradle operation while data communication is in progress. Doing so can cause data to become corrupted.

### Using the Camera with a Macintosh Computer

The following are the general steps for viewing and copying files from a Macintosh.

You can find details about each operation in the procedures that follow below. Note that you should also refer to the documentation that comes with your Macintosh for other information about USB connections, etc.

#### ▶▶ IMPORTANT! ◀◀

- This camera does not support operation with a computer running Mac OS 8.6 or lower, or Mac OS X 10.0. If you have a Macintosh running Mac OS 9 or OS X (10.1, 10.2 or higher), use the standard USB driver that comes with your OS.

1. Use the USB cradle to establish a connection between the camera and your Macintosh.



2. View and copy the images you want.



## VIEWING IMAGES ON A COMPUTER

### ►► IMPORTANT! ◀◀

- If you want to transfer files from the camera's built-in memory to a computer, make sure there is no memory card loaded in the camera before you place it onto the USB cradle.

- 1. Connect the AC power cord to the bundled AC adaptor, and then plug the other end of the AC power cord into a household power outlet.**
- 2. Connect the AC adaptor to the [DC IN 5.3V] connector of the USB cradle.**

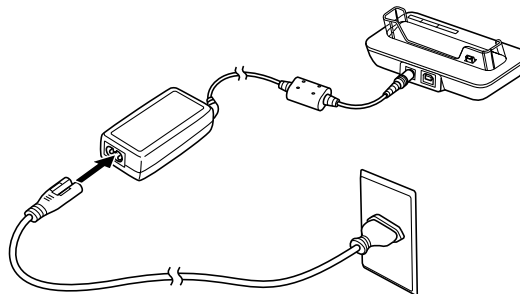

## VIEWING IMAGES ON A COMPUTER

### 3. Connect the USB cable that comes bundled with the camera to the USB cradle and your computer's USB port.

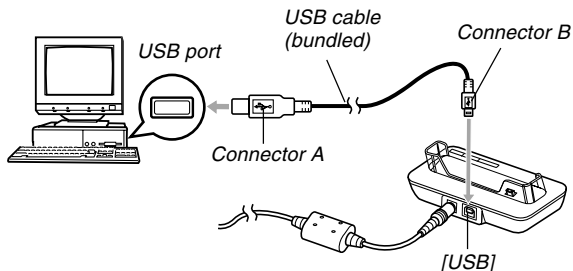

- Take care when connecting the USB cable to the USB cradle or your computer. USB ports and cable plugs are shaped for proper positioning.
- Plug the USB cable plugs into the ports securely, as far as they will go. Proper operation is not possible if connections are not correct.

### 4. After making sure the camera is turned off, place the camera onto the USB cradle.

- Do not place the camera onto the USB cradle while it is turned on.

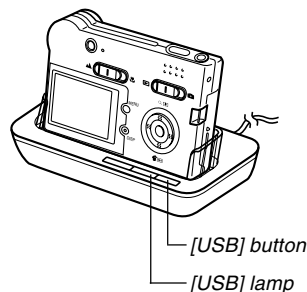

### 5. Press the USB cradle's [USB] button.

- Pressing the [USB] button enters the USB mode, which causes the USB cradle's [USB] lamp to light green (page 177).

### 6. Your Macintosh will see the camera's file memory as a drive.

- The appearance of the drive icon depends on the Mac OS version you are using.
- After installing the USB driver, your Macintosh will see the camera's file memory as a drive whenever you establish a USB connection between them.

### 7. Double-click the drive icon for the camera's file memory, the "DCIM" folder, and then the folder that contains the image you want.

### 8. Double-click the file that contains the image you want to view.

- For information about file names, see "Memory Directory Structure" on page 142.

### 9. To copy all the files in file memory to your Macintosh hard disk, drag the "DCIM" folder to the folder to which you want to copy it.

#### ▶▶ IMPORTANT! ◀◀

- Never use your computer to edit, delete, move, or rename images stored in file memory. Doing so can cause problems with the image management data used by the camera, which may make it impossible to display images on the camera or it may cause a large error in the number of images value displayed by the camera. Always copy images to your computer memory before performing any edit, delete, move, or rename operation.

### 10. To terminate the USB connection, drag the drive icon that represents the camera to Trash. After pressing the USB cradle [USB] button and making sure that the [USB] lamp is not lit, remove the camera from the USB cradle.

### USB Connection Precautions

- Be sure to read the documentation that comes with your computer for other important information about USB connections.
- Be sure to connect the AC adaptor to the USB cradle to supply power to the camera.
- USB data communication is performed regardless of the current setting of the camera's mode selector.
- Do not leave the same image displayed on your computer screen for a long time. Doing so can cause the image to "burn in" on the screen.
- Never disconnect the USB cable, or perform any camera or USB cradle operation while data communication is in progress. Doing so can cause data to become corrupted.

### Operations You Can Perform from Your Computer

The following are the operations you can perform while there is a USB connection between your camera and computer. See the referenced pages for more information about each operation.

- View images in album format  
.... See "Using the Album Feature" on page 145.
- Print images in album format  
.... See "Using the Album Feature" on page 145.
- Automatically transfer images to your computer and manage images  
.... See "Installing the Software from the CD-ROM" on page 152 for information about installing Photo Loader.
- Retouch images  
.... See "Installing the Software from the CD-ROM" on page 152 for information about installing Photohands.

### Using a Memory Card to Transfer Images to a Computer

The procedures in this section describe how to transfer images from the camera to your computer using a memory card.

#### Using a Computer with a Built-in SD Memory Card Slot

Insert the SD memory card directly into the slot.

#### Using a Computer with a Built-in PC Card Slot

Use a commercially available PC card adapter (for an SD memory card/MMC). For full details, see the user documentation that comes with the PC card adapter and your computer.

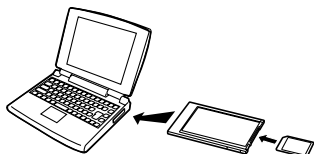

#### Using a Commercially Available SD Memory Card Reader/Writer

See the user documentation that comes with the SD memory card reader/writer for details about how to use it.

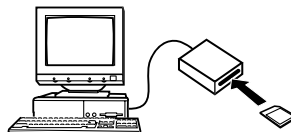

#### Using a Commercially Available PC Card Reader/Writer and PC Card Adapter (for SD Memory Cards and MMCs)

See the user documentation that comes with the PC card reader/writer and PC card adapter (for an SD memory card/MMC) for details about how to use them.

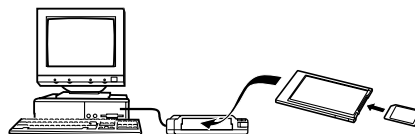

## Memory Data

Images recorded with this camera and other data are stored in memory using DCF (Design rule for Camera File System) protocol. DCF protocol is designed to make it easier to exchange image and other data between digital cameras and other devices.

## DCF Protocol

DCF devices (digital cameras, printers, etc.) can exchange images with each other. DCF protocol defines camera format for image file data and the directory structure for file memory, so images can be viewed using another manufacturer's DCF camera or printed on a DCF printer.

## Memory Directory Structure

### ■ Directory Structure

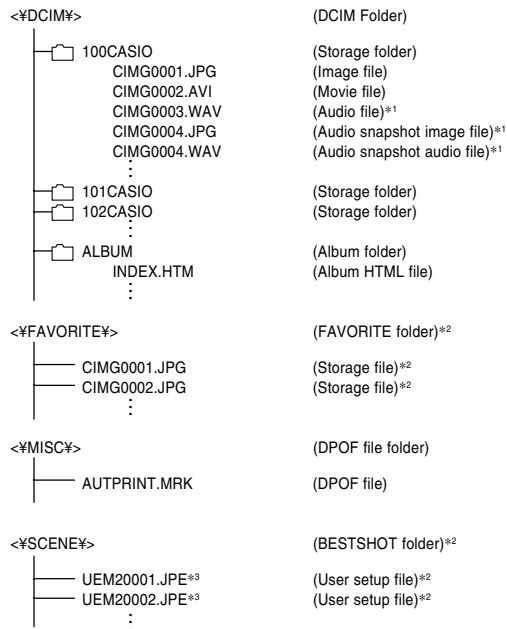

## VIEWING IMAGES ON A COMPUTER

<¥AUDIO¥>	(MP3 file folder)*1
├── *****.MP3	(MP3 file)*1
└── LASTPLAY	(LASTPLAY file)*1

\*1 These folders and files are for the EX-M20 only.

\*2 These folders are created in built-in memory only.

\*3 These file names are part of the EX-M20 file structure only.

With the EX-S20, files are named UES20001.JPE,  
UES20002.JPE, etc.

### ■ Folder and File Contents

- DCIM folder  
Folder that stores all of the digital camera files
- Storage folder  
Folder for storing files created by the digital camera
- Image file  
File that contains an image recorded with the digital camera (File Name Extension: JPG)
- Movie file  
File that contains a movie recorded with the digital camera (File Name Extension: AVI)
- Audio file (EX-M20 only)  
File that contains an audio recording (File Name Extension: WAV).

- Audio snapshot image file (EX-M20 only)  
File that contains the image part of an audio snapshot (File Name Extension: JPG).
- Audio snapshot audio file (EX-M20 only)  
File that contains the audio part of an audio snapshot (File Name Extension: WAV).
- Album folder  
Folder that contains files used by the album function
- Album HTML file  
File used by the album function (File Name Extension: HTM)
- FAVORITE folder (Built-in memory only)  
Folder that contains Favorites image files (Image Size: 320 x 240 pixels)
- DPOF file folder  
Folder that contains DPOF files
- BESTSHOT folder (Built-in memory only)  
Folder that contains BESTSHOT user setup files.
- User setup files (Built-in memory only)  
Files that contain BESTSHOT user setups

- MP3 files folder (EX-M20 only)  
Folder that contains MP3 files.
- LASTPLAY file (EX-M20 only)  
File that contains information about the last played MP3 file.

### Image Files Supported by the Camera

- Image files recorded with the CASIO EX-S20/EX-M20 Digital Camera
- DCF protocol image files

Certain DCF functions may not be supported. When displaying an image recorded on another camera model, it may take a long time for the image to appear on the display.

### Built-in Memory and Memory Card Precautions

- Note that the folder named “DCIM” is the parent (top) folder of all the files in memory. When transferring memory contents to a hard disk, CD-R, MO disk, or other external storage, treat all the contents inside a DCIM folder as a set and always keep them together. You can change the name of the DCIM folder on your computer. Changing the name to a date is a good way to keep track of multiple DCIM folders. However, if you even want to copy the folders back to the camera’s file memory, be sure you change the name of the DCIM folder back to “DCIM” first. The camera does not recognize any folder name other than DCIM.
- We also strongly recommend that after transferring data from file memory to other external storage that you reformat the camera’s file memory and delete its contents before using it to store more files. Remember that formatting memory deletes all of its contents. Check to make sure that you no longer need any of the files in memory before you format it.



# USING THE CAMERA WITH A COMPUTER

The album feature of the camera creates files that make it possible for you to view images on your computer in a photo album layout. You can also use the applications contained on the CD-ROM that comes bundled with the camera to automate image transfer and to retouch images.

## Using the Album Feature

The album feature creates an HTML photo album layout that displays your images. You can use the HTML layout to post your images on a Web page, or for printing the images.

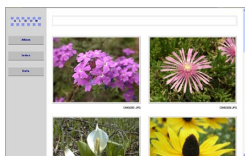

*Album*



*Index*



*Info*

- You can use the Web browser shown below to view or print the contents of an album. Note that to view a movie on a computer running Windows 2000 or 98, you need to install DirectX.

Microsoft Internet Explorer Ver 5.5 or later

## Creating an album

1. In the **PLAY** mode, press **[MENU]**.
2. Select the **“PLAY”** tab, select **“Create Album”**, and then press **[▶]**.

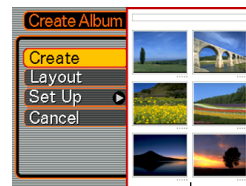

*Sample layout*

3. Use **[▲]** and **[▼]** to select **“Create”**, and then press **[SET]**.
  - This starts creation of the album, and causes the message **“Busy.... Please wait...”** to appear on the monitor screen.

## USING THE CAMERA WITH A COMPUTER

- The PLAY mode screen reappears after creation of the album is complete.
- Creating an album causes a file folder named “ALBUM”, which contains a file named “INDEX.HTM” plus other files to be created in camera memory or on the memory card.

### ▶▶ IMPORTANT! ◀◀

- Never open the battery cover or remove the memory card from the camera while an album is being created. Doing so not only runs the risk of certain album files being skipped, it can also result in image data and other data in memory being corrupted.
- If memory becomes full while an album is being created, the message “Memory Full” appears on the monitor screen and album creation is terminated.
- Album creation will not be performed properly if the battery goes dead while album creation is in progress.
- You can also configure the camera to create albums automatically (page 148). However, performing the above procedure creates an album regardless of whether automatic album creation is turned on or off.

## Selecting an Album Layout

You can select from among 10 different display layouts for an album.

- 1. In the PLAY mode, press [MENU].**
- 2. Select the “PLAY” tab, select “Create Album”, and then press [▶].**
- 3. Use [▲] and [▼] to select “Layout”.**
- 4. Use [◀] and [▶] to select the layout you want.**
  - Changing the layout causes the layout sample on the right side of the screen to change.

### ▶▶ IMPORTANT! ◀◀

- The sample layout shows the arrangement of items and the background color. It does not show whether the layout uses a list view or detailed view, or the current Image Type setting.

## Configuring Detailed Album Settings

1. In the **PLAY** mode, press **[MENU]**.
2. Select the “**PLAY**” tab, select “**Create Album**”, and then press **[▶]**.
3. Use **[▲]** and **[▼]** to select “**Set Up**”, and then press **[▶]**.
4. Use **[▲]** and **[▼]** to select the item whose setting you want to change, and then press **[▶]**.



- Details about each of the settings are provided in the following sections.

5. Use **[▲]** and **[▼]** to change the setting, and then press **[SET]**.

### ■ Background Color

You can specify white, black, or gray as the color of the album background using the procedure under “Configuring Detailed Album Settings”.

### ■ Album Type

There are two album types: Normal and Index/Info.

**Normal Type** : This type of album displays images in accordance with the currently selected layout.

**Index/Info Type** : In addition to the normal album screen, this type of album also includes thumbnails of images and detailed information about each image.

### ■ Image Use

This setting lets you select from among three different image uses, as described below. Select the image use that best suits the way you plan to use the image.

For this purpose:	Select this setting:
Smaller images for album browsing, Website thumbnails, or archiving on a CD-R or other media, with the full-size image displayed when a thumbnail is clicked <ul style="list-style-type: none"> <li>This setting can be used for browsing with the thumbnails. Clicking a thumbnail displays a larger version for viewing or printing.</li> </ul>	View
Small image files only for album browsing, or uploading to a Website, etc. <ul style="list-style-type: none"> <li>This option displays only the small-file images (located in the camera's "ALBUM" folder). Smaller files upload to the Internet faster.</li> <li>You cannot enlarge images by clicking a thumbnail or play movies while this image is selected.</li> </ul>	WEB
Printing (high resolution) <ul style="list-style-type: none"> <li>High-resolution images take longer to display on your computer screen.</li> <li>You cannot enlarge images by clicking a thumbnail or play movies while this image is selected.</li> </ul>	Print

### ■ Auto Album Creation On/Off

This setting controls whether an album is created automatically whenever you turn off the camera.

To do this:	Select this option:
Turn on auto album creation	On
Turn off auto album creation	Off

- When auto album creation is turned on, an album is created automatically in built-in memory or on the memory card whenever you turn off the camera.

### ⓘ IMPORTANT! ⓘ

- When you turn off the camera while auto album creation is turned on, the monitor screen turns off, but the operation/flash charge lamp continues to flash for a few seconds to indicate that the album creation process is being performed. Never open the battery cover or remove the memory card while the operation/flash charge lamp is flashing green.

### NOTE

- Depending on the number of images in memory, it can take quite a bit of time to complete auto album creation when you turn off the camera. If you do not plan to use the album feature, we suggest that you keep auto album creation turned off, which shortens the amount of time the camera takes to power down completely.

## Viewing Album Files

You can view and print album files using your computer's Web browser application.

1. Use your computer to access the data in built-in memory or on the memory card, or access a memory card with your computer (pages 131, 141).
2. Open the built-in memory "ALBUM" folder or the memory card "ALBUM" folder, which is located inside the folder named "DCIM".
3. Use your computer's Web browser to open the file named "INDEX.HTM".

- This displays a list of folders in built-in memory or on the memory card.

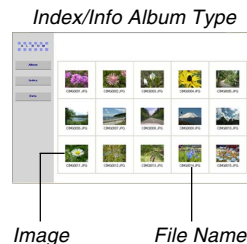

## USING THE CAMERA WITH A COMPUTER

### 4. If you created the album after selecting “Normal” type or “Index/Info” as the album type under “Configuring Detailed Album Settings” on page 147, you can click one of the following display options.

Album: Displays an album created by the camera.

Index : Displays a list of images stored in a folder.

Info : Displays information about each image.

- If “View” is selected for “Use” (page 148), you can double-click an image on your computer screen to display the full-size version.

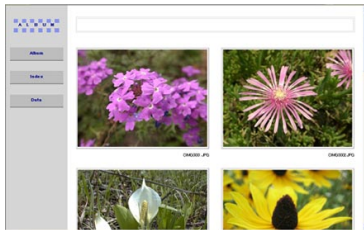

*Album*



*Index*

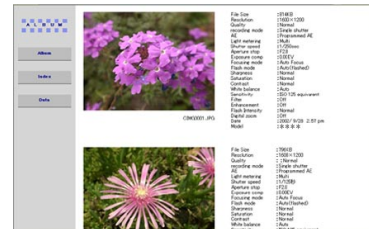

*Info*

## USING THE CAMERA WITH A COMPUTER

- The following describes the information that appears on the Info Screen.

This Info Screen item:	Shows this:
File Size	Image file size
Resolution	Resolution
Quality	Quality
Drive mode	Drive mode
AE	Exposure mode
Light metering	Metering mode
Shutter speed	Shutter speed
Aperture stop	Aperture stop
Exposure comp	EV shift
Focusing mode	Focusing mode
Flash mode	Flash mode
Sharpness	Sharpness
Saturation	Saturation
Contrast	Contrast
White balance	White balance
Sensitivity	Sensitivity
Filter	Filter setting
Enhancement	Enhancement setting
Flash intensity	Flash intensity
Digital zoom	Digital zoom setting
World	Location
Date	Recording date and time
Model	Camera model name

### »» NOTES ««

- When printing an album page, you should set up your Web browser as described below.
  - Select the browser frame where the images are located.
  - Set margins to the lowest possible values.
  - Set the background color to a printable color.
- See the user documentation that came with your Web browser application for details about printing and configuring settings for printing.

### **5. After you are finished viewing the album, exit your Web browser application.**

### Saving an Album

- To save an album, copy the “DCIM” folder from camera memory or the memory card to your computer’s hard disk, a CD-R, an MO disk, or some other storage medium. Note that copying only the “ALBUM” folder, does not copy image data and other necessary files.
- After copying the “DCIM” folder, do not change or delete any of the files inside of it. Adding new images or deleting existing images may lead to abnormal album display.
- If you plan to use a memory card again after saving its album, first delete all of its files or format it before loading it into the camera.
- When you have “WEB” selected for the “Use” setting, the album shows only the smaller image files stored in the “ALBUM” folder. Such images can be uploaded to the Internet more quickly.

### Installing the Software from the CD-ROM

#### About the bundled CD-ROM

The CD-ROM that comes bundled with the camera contains the applications described below. Installation of these applications is optional, and you should install only the ones you want to use.

#### USB Driver for Mass Storage (for Windows)

This is the software that makes it possible for the camera to “talk” to your personal computer over a USB connection. If you are using Windows XP, do not install the USB driver from the CD-ROM. With these operating systems, you will be able to perform USB communication simply by connecting the camera to your computer with the USB cable.

#### Photo Loader (for Windows/Macintosh)

This application loads image data saved in JPEG and AVI format from a digital camera to your computer. With the EX-M20, you can also load audio snapshot and voice recording WAV files to your computer.

#### Photohands (for Windows)

This application is for retouching and printing image files.



### DirectX (for Windows)

This software provides an extended tool set including a codec that allows Windows 98 and 2000 to handle movie files recorded using a digital camera. You do not need to install DirectX if you are running Windows XP or Me.

### Acrobat Reader (for Windows)

This is an application that lets you read PDF files. Use it to read the user documentation for the camera, Photo Loader, and Photohands, all of which is included on the bundled CD-ROM.

### NOTE

- See the user documentation files (PDF) on the bundled CD-ROM for details about using Photo Loader and Photohands. See “Viewing User Documentation (PDF files)” on page 156 (Windows) and page 158 (Macintosh) of this manual for more information.

## Computer System Requirements

Computer system requirements depend on each of the applications, as described below.

### Windows

See the “Readme” file on the bundled CD-ROM.

### Macintosh

See the “readme” file on the bundled CD-ROM.

### Installing Software from the CD-ROM in Windows

Use the procedures in this section to install the software from the bundled CD-ROM to your computer.

#### NOTE

- If you already have one of the bundled applications installed on your computer, check its version. If the bundled version is newer than the one you have, you should install the newer version.

The CD-ROM includes the software and user documentation for various languages. Check the CD-ROM menu screen to see if applications and user documentation are available for a particular language.

### Getting Started

Start up your computer and insert the CD-ROM into its CD-ROM drive. This will automatically launch the menu application, which displays a menu screen on your computer.

- The menu application may not start up automatically on some computers. If this happens, navigate to the CD-ROM and double-click “menu.exe” to launch the menu application.

### Selecting a Language

First select a language. Note that some software is not available in all languages.

- 1. On the menu screen, click the tab for the language you want.**

### Viewing the Contents of the “Read me” File

You should always read the “Read me” file for any application before installing it. The “Read me” file contains information you need to know when installing the application.

#### 1. Click the “Read me” button for the application you are going to install.

#### »» IMPORTANT! ««

- Before upgrading or reinstalling Photo Loader, or before installing it onto another computer, be sure to read the “Read me” file for information about retaining existing libraries.

### Installing an Application

1. Click the “Install” button for the application you want to install.
2. Follow the instructions that appear on your computer screen.

#### »» IMPORTANT! ««

- Be sure to follow the instructions carefully and completely. If you make a mistake when installing Photo Loader, you may not be able to browse your existing library information and HTML files that are created automatically by Photo Loader. In some cases, image files may be lost.
- When using an operating system other than Windows XP, never connect the camera to your computer without installing the USB driver from the CD-ROM first.

## Viewing User Documentation (PDF Files)

1. In the “Manual” area, click the name of the manual you want to read.

### »» IMPORTANT! ««

- You need to have Adobe Acrobat Reader installed on your computer to read user documentation files. If you do not already have Adobe Acrobat Reader installed, you can install it from the bundled CD-ROM.

## User Registration

You can perform user registration over the Internet. To do so, of course, you need to be able to connect to the Internet with your computer.

1. Click the “Register” button.

- This starts up your Web browser and accesses the user registration website. Follow the instructions that appear on your computer screen to register.

2. After registering, terminate your connection to the Internet.

## Exiting the Menu Application

1. On the menu screen, click “Exit” to exit the menu.

### Installing Software from the CD-ROM on a Macintosh

Use the procedures in this section to install the software from the bundled CD-ROM to your computer.

### Installing Software

Use the following procedures to install the software.

#### ■ To install Photo Loader

1. Open the folder named “Photo Loader”.
2. Open the folder named “English”, and then open the file named “Important”.
3. Open the folder named “Installer”, and then open the file named “readme”.
4. Follow the instructions in the “readme” file to install Photo Loader.

#### ▶▶ IMPORTANT! ◀◀

- If you are upgrading to the new version of Photo Loader from a previous version and you want to use library management data and HTML files created using the old version of Photo Loader, be sure to read the “Important” file in the “Photo Loader” folder. Follow the instructions in the file to use your existing library management files. Failure to follow this procedure correctly can result in loss or corruption of your existing files.

### Viewing User Documentation (PDF Files)

To perform the following procedures, you must have Acrobat Reader installed on your Macintosh. You can download the latest version of Adobe Acrobat Reader by visiting the Adobe Systems website.

#### ■ To view the camera user's guide

1. On the CD-ROM, open the "Manual" folder.
2. Open the "Digital Camera" folder, and then open the folder for the language whose user's guide you want to view.
3. Open the file named "camera\_xx.pdf".
  - "xx" is the language code.

#### ■ To read the Photo Loader user's guide

1. On the CD-ROM, open the "Manual" folder.
2. Open the "Photo Loader" folder and then open the "English" folder.
3. Open "PhotoLoader\_english".

#### ■ To register as a user

Internet registration only is supported. Visit the following CASIO website to register:

<http://world.casio.com/qv/register/>

# PLAYING AN AUDIO FILE (EX-M20 Only)

You can transfer MP3 music data files from your computer to the camera and then use the camera as a portable audio player.

- MP3 stands for MPEG Audio Layer-3, which is the name of audio compression technology.
- Supported Files  
An “MP3 file” is a Windows file whose name is followed by the extension “.MP3”. The following describes the types of MP3 files that are supported by this camera.
  - MPEG-1 Audio Layer-3  
Bit Rate: 32 to 320 kbps, VBR-compatible  
Sampling Frequencies: 32, 44.1, 48kHz
  - MPEG-2 Audio Layer-3  
Bit Rate: 8 to 160 kbps, VBR-compatible  
Sampling Frequencies: 16, 22.05, 24kHz
- Maximum Number of Playback Files: 999

## ▶▶ IMPORTANT! ◀◀

- Depending on the MP3 file format, some music data may not be playable.
- A bit rate of 128kbps and a sampling frequency of 44.1kHz are recommended for MP3 files.
- It is up to you to obtain software for creating MP3 files and to create the MP3 files you want to play.

## Transferring Audio Files to the Camera

Use the following procedure to import an MP3 audio file from your computer to the camera.

- 1. Establish a USB connection between the camera and your computer (page 131).**
  - If you plan to transfer MP3 audio files to a memory card, load the card into the camera.
- 2. Perform one of the following operations to open camera memory or the memory card.**
  - **Windows XP Users**  
Click “My Computer” and then “Removable Disk”.
  - **Mac OS 9 Users**  
Click “untitled”.
- 3. Open the “AUDIO” folder, and then transfer the MP3 files you want to play into it.**
  - If there is no “AUDIO” folder, create one at the location indicated in “Memory Directory Structure” on page 142.
- 4. This terminates the USB connection between the camera and your computer (page 131).**

»» NOTES ««

- If you are using a "PLAYLIST.TXT" file (page 166), you need to edit the contents of the file accordingly whenever you add or delete an MP3 file.
- See the user documentation that comes with your computer for information about moving, and copying files.

## Preparing the Camera for Audio Player Operation

Perform the following steps to prepare the camera for operation as an audio player.

- 1. Turn off the camera.**
- 2. Connect the LCD remote controller to the camera's connector, and then plug the stereo headphones into the Headphones jack of the LCD remote controller.**

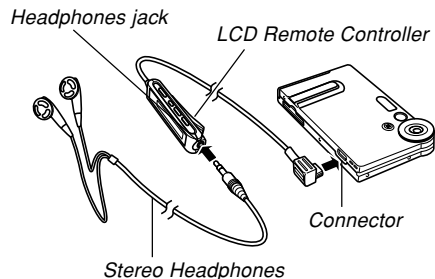



### 3. On the LCD remote controller, press the [▶/■] button.

- This turns on the camera, enters the AUDIO mode, and starts playback.

#### ▶▶ IMPORTANT! ◀◀

- Pressing the LCD remote controller's [▶/■] button enters the AUDIO mode, regardless of the camera's mode selector setting.
- Entering the AUDIO mode causes the camera's monitor screen to turn off. Pressing [MENU] or [DISP] on the camera while playback is stopped or paused causes the monitor screen to turn on.
- Never try to connect any other type of remote controller besides the one that comes with the camera. Also, never try to use the supplied remote controller with any other type of device.
- You cannot play MP3 file data through the camera's built-in speaker.

## Using the Camera as an Audio Player

### General Guide

#### ● LCD Remote Controller

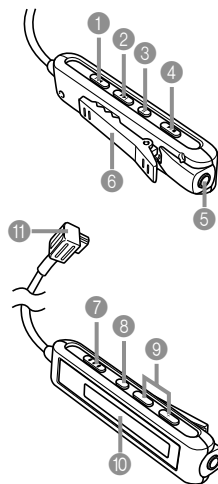

- 1 [◀◀] (Skip Back/Fast Reverse)
- 2 [▶▶] (Skip Forward/Fast Forward)
- 3 [||] (Pause)
- 4 [▶/■] (Play/Stop)
- 5 Headphones jack (ø3.5mm stereo mini jack)
- 6 Clip
- 7 Lock switch
- 8 Playback mode button
- 9 Volume buttons
- 10 LCD
- 11 Camera connector

## PLAYING AN AUDIO FILE (EX-M20 Only)

### ● Display

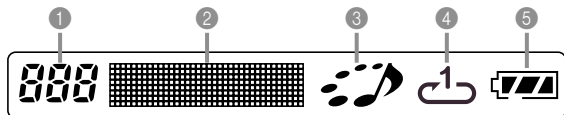

- 1 Track number**  
Shows the track number of the current track.
- 2 Track name, artist name, playback time, volume level, BASS BOOST settings**
  - Shows the ID3 tag (ID3V1), which is the track name and artist name (alphabetic characters only), contained in the file.
  - During fast forward and fast reverse, shows the elapsed play time.
  - During volume level adjustment, shows the current volume level.
  - When BASS BOOST is selected, shows the current BASS BOOST setting (BASS 0, BASS 1, BASS 2).

- 3 Playback status indicator**  
This icon indicates the current playback status.

This type of icon:	Indicates this:
Rotation clockwise while flashing	Playback is in progress.
Flashing	Playback is paused.
Steady and unmoving	Playback is stopped.

- 4 Playback mode indicator**  
This icon indicates the playback mode.

This type of icon:	Indicates this:
None	Normal playback
	All track repeat
	1-track repeat

- 5 Battery level indicator**

## Basic Remote Controller Operations

### ● To start playback

Press the [▶/■] button. The remote controller beeps to indicate that playback has started.

- Pressing the [▶/■] button while the camera is off turns on power and starts playback.

### ● To pause playback

Press the [⏸] button (remote controller beeps).

Pressing the [▶/■] button or the [⏸] button resumes playback (remote controller beeps).

- If the Auto Power Off trigger time (about two minutes or five minutes) is reached while playback is paused, the camera will automatically turn off.

### ● To fast forward the playback

Hold down the [▶▶] button for a few seconds until fast forward starts.

### ● To fast reverse the playback

Hold down the [◀◀] button for a few seconds until fast reverse starts.

### ● To skip to the beginning of the current track

Press the [◀◀] button (remote controller beeps).

To skip to the beginning of a previous track, press the [◀◀] button multiple times (remote controller beeps).

The current track number is shown on the LCD.

### ● To skip to the beginning of the next track

Press the [▶▶] button (remote controller beeps).

To keep skipping forward, press the [▶▶] button multiple times (remote controller beeps). The current track number is shown on the LCD.

### ● To stop playback

Press the [▶/■] button (remote controller beeps).

- Pressing the [▶/■] button again will restart playback from the beginning of the track where it was stopped.

### ● To adjust volume

Press the [+] or [-] volume buttons to adjust volume to the desired level. The LCD shows the current volume level.

### ● To turn off power

Press the camera's power button.

- Camera power also turns off automatically if you do not perform an operation for about 10 seconds after playback is stopped.

### ▶▶ IMPORTANT! ◀◀



- The button operation tone does not sound if the camera's button tone function is turned off (page 111).
- You cannot use fast forward, fast reverse, or skip while the current volume level is shown on the LCD.

## Playing Back Audio Files

### Specifying the Audio Playback Mode

You can use the following procedure to select one of three playback modes: normal playback, all-track repeat, or one-track repeat.

1. On the LCD remote controller, press **[▶/■]** to start playback.
2. Press the LCD remote controller's playback mode button to cycle through the playback modes.

To do this:	Select this mode:	Which is indicated by this icon:
Play all tracks in order and then stop	Normal	None
Play all tracks in order in an endless loop	All-track repeat	
Play the current track in an endless loop	1-track repeat	

### NOTE

- The initial default mode is normal playback. The camera remembers the last playback mode you selected, even if you turn the camera off.

### Playing Back Tracks Randomly

Use the following procedure to configure audio playback for random play of the audio files in file memory.

1. On the LCD remote controller, press the **[▶/■]** button or the **[||]** button to stop or pause playback.
  - You could also enter the PLAY mode on the camera, press [MENU], select the "PLAY" tab and then "Audio Player", and then press **[▶]**.
2. Use **[▲]** and **[▼]** to select "Random", and then press **[▶]**.

### 3. Use [▲] and [▼] to select “On”, and then press [SET].

To do this:	Select this setting:
Turn on random play	On
Turn off random play	Off

#### ▶▶ IMPORTANT! ◀◀

- Random play is not performed if you have “1-track repeat” selected as the playback mode (page 164).

## Selecting a Specific Track for Playback

You can use the following procedure to select the specific track you want to play from a list of tracks on the camera's monitor screen.

### 1. On the LCD remote controller, press the [▶/■] button or the [||] button to stop or pause playback.

### 2. On the camera, press the [DISP] button.

- This causes an MP3 file list showing track numbers, track names, and play time to appear on the camera's monitor screen.



001	POLICE TECH	04:14
002	PLANET DURAN EARTH	03:58
003	DO DO DO THE ICE	04:20
004	YOUNG RINK	03:06

### 3. Use [▲] and [▼] to move the highlighting to the name of the MP3 file you want to play.

### 4. To start playback of the selected track, press [▶/■] on the LCD remote controller or the [SET] button on the camera.

### ►► IMPORTANT! ◀◀

- The monitor screen turns off automatically if you do not perform any operation for about 10 seconds.

## Specifying the Track Playback Sequence

Normally, audio files are played back in the sequence that they are stored in file memory. You can also create a text file that lists the MP3 files to be played and the sequence for playing them. Then, simply name the file "PLAYLIST.TXT" and place it into the camera's "AUDIO" folder. The camera will play back files accordingly.

- 1. Use your computer's word processor or text editor to create a text file like the one shown below, and name it "PLAYLIST.TXT".**
- 2. Establish a USB connection between the camera and your computer (page 131).**
- 3. Open the folder in camera memory named "AUDIO", and place the "PLAYLIST.TXT" file inside it.**
- 4. Terminate the USB connection between the camera and your computer (page 131).**
  - Now when you perform a playback operation, MP3 files will be played in the sequence you specified in your play list.

## ■ Example Folder Structure

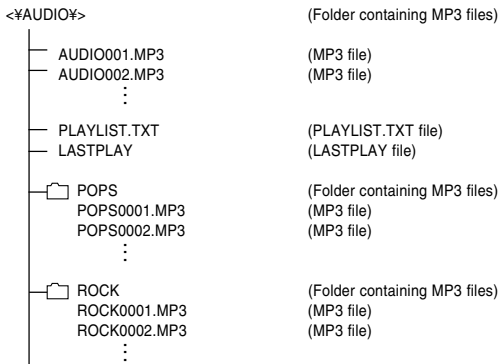

### ▶▶ IMPORTANT! ◀◀

- Playback will include all the files in the “AUDIO” folder and all the files in any folders inside the “AUDIO” folder. Any files nested deeper will not be played. If the “AUDIO” folder contains another folder named “POPS”, and there is another folder named “JAZZ” inside of the “POPS” folder, playback will include all the files in the “AUDIO” folder and the “POPS” folder, but not the files inside the “JAZZ” folder.

## ■ Example PLAYLIST.TXT File Contents

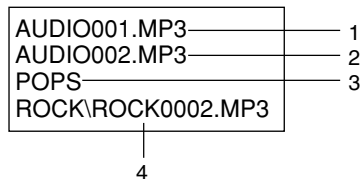

The above PLAYLIST.TXT file specifies the following playback sequence.

1. Playback the MP3 file named AUDIO001.MP3.
2. Playback the MP3 file named AUDIO002.MP3.
3. Playback all the files in the folder named POPS.
4. Playback the MP3 file named ROCK0002.MP3, which is located in folder named ROCK.

►► IMPORTANT! ◀◀

- Any files and folders that are not included in the “PLAYLIST.TXT” file are skipped during playback.
- If there is no file named “PLAYLIST.TXT” in the camera’s “AUDIO” folder, all audio files are played in the sequence they are stored.
- If you want to change the files that are played or their sequence, simply edit the contents of the “PLAYLIST.TXT” file.
- The contents of the “PLAYLIST.TXT” file are ignored when random playback is turned on (page 164).

## Using BASS BOOST

BASS BOOST enhances the low range of the audio for a more powerful sound.

- 1. On the LCD remote controller, press the [▶/■] button or the [||] button to stop or pause playback.**
  - You could also enter the PLAY mode on the camera, press [MENU], select the “PLAY” tab and then “Audio Player”, and then press [▶].
- 2. Use [▲] and [▼] to select “BASS BOOST”, and then press [▶].**
- 3. Use [▲] and [▼] to select the setting you want, and then press [SET].**
  - Available settings are BASS 0, BASS 1, and BASS 2. A higher number provides more powerful sound.



### ▶▶ IMPORTANT! ◀◀

- When using BASS BOOST, playing at loud volume can cause distortion. If this happens, lower the volume level.
- During playback, you can change the BASS BOOST setting using the camera's [▲] and [▼] buttons.

### Deleting MP3 Files from File Memory

You can delete a single MP3 file from camera memory or on the memory card, or you can batch delete all the MP3 files.

### ▶▶ IMPORTANT! ◀◀

- Note that file deletion cannot be undone. Once you delete a file it is gone. Make sure you really do not need an MP3 file anymore before you delete it. Especially when deleting all MP3 files, make sure you check all the files you currently have in memory before proceeding.
- If you are using a "PLAYLIST.TXT" file (page 166), you need to edit the contents of the file accordingly whenever you delete an MP3 file.

## Deleting a Single MP3 File

Use the following procedure to delete a single MP3 file from file memory or a memory card.

- 1. On the LCD remote controller, press the [▶/■] button or the [||] button to stop or pause playback.**
  - You could also enter the PLAY mode on the camera, press [MENU], select the "PLAY" tab and then "Audio Player", and then press [▶].
- 2. Use [▲] and [▼] to select "Delete", and then press [SET].**
  - This causes an MP3 file list showing track numbers, track names, and play time to appear on the camera's monitor screen.
- 3. Use [◀] and [▶] to display the MP3 file you want to delete.**

- 4. Use [▲] and [▼] to select "Delete".**

- To exit the delete operation without deleting anything, select "Cancel".

- 5. Press the [SET] button to delete the file.**

- Repeat steps 3 through 5 to delete other MP3 files, if you want.

- 6. Press [MENU] to exit the delete operation.**

## Deleting All MP3 Files

The following procedure deletes all MP3 files currently in file memory.

1. On the LCD remote controller, press the **[▶/■]** button or the **[||]** button to stop or pause playback.
  - You could also enter the PLAY mode on the camera, press [MENU], select the "PLAY" tab and then "Audio Player", and then press [▶].
2. Use **[▲]** and **[▼]** to select "All File Delete", and then press **[SET]**.
3. Use **[▲]** and **[▼]** to select "Yes".
  - To exit the delete operation without deleting anything, select "No".
4. Press **[SET]** to display all MP3 files in file memory.

## Disabling Remote Controller Button Operations

The remote controller has a lock switch that you can use to disable button operations to guard against accidental operation. To disable all remote controller button operations, slide the lock switch in the direction indicated by the ▶ mark.

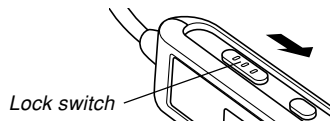

- To re-enable remote controller button operations, slide the lock switch back in the other direction.

### NOTE

- The camera's power button continues to be operational, even while remote controller button operations are disabled.

### LCD Remote Control Error Messages

The following describes the error messages that appear on the LCD remote controller's display.

	Cause	Action
<b>NoData</b>	Playback attempted when there is no MP3 data in memory.	Transfer MP3 file data to the "AUDIO" folder of built-in memory or the memory card.

#### »» NOTE ««

- The message "There are no files." appears on the camera monitor screen if there are no MP3 files in memory.

### Audio Playback Precautions

- Listening to audio at a high volume for long periods can damage your hearing. Particular care is required when first starting a playback operation.
- Never use the headphones, try to perform fine adjustment, or look at the monitor screen while driving a car, riding a motorcycle, or operating any other type of motor vehicle. Doing so creates the risk of traffic accident. When walking, take special care to remain aware of traffic and road conditions around you.

# APPENDIX











## Menu Reference





The following shows lists of menus that appear in the REC mode and PLAY mode, and their settings.

- The settings that are underlined in the following table are initial defaults.
- Menu items marked with an asterisk (\*) appear on the EX-M20 only.

### ■ REC mode

#### ● REC tab menu

REC Mode	EX-S20:  Snapshot /  BESTSHOT /  Movie
	EX-M20:  Snapshot /  BESTSHOT /  Movie /  Voice /  Voice
Self-timer	10 sec / 2 sec / X3 / <u>Off</u>
Flash	<u>Auto</u> /  (Flash Off) /  (Flash On) /  (Red-eye reduction)
Size	<u>1600 x 1200</u> / 1600 x 1072 (3:2) / 1280 x 960 / 640 x 480
Quality	Fine / <u>Normal</u> / Economy
EV Shift	-2.0 / -1.7 / -1.3 / -1.0 / -0.7 / -0.3 / <u>0.0</u> / +0.3 / +0.7 / +1.0 / +1.3 / +1.7 / +2.0

White Balance	<u>Auto</u> /  (Sunlight) /  (Shade) /  (Light Bulb) /  (Fluorescent) / Manual
ISO	<u>Auto</u> / ISO 64 / ISO 125 / ISO 250 / ISO 500
Grid	On / <u>Off</u>
Digital Zoom	<u>On</u> / Off
Review	<u>On</u> / Off
L/R Key	<u>REC Mode</u> / Flash / EV shift / White Balance / ISO / Off
U/D Key	REC Mode / <u>Digital Zoom</u> / Flash / White Balance / Self-timer / Off

#### ● Memory tab menu

REC Mode	<u>On</u> / Off
Flash	<u>On</u> / Off
White Balance	On / <u>Off</u>
ISO	On / <u>Off</u>
Digital Zoom	<u>On</u> / Off

## APPENDIX

### ● Set Up tab menu

Beep (EX-S20)	<u>On</u> / Off
Sounds (EX-M20)	<u>Startup</u> / Shutter / Operation / Volume
Startup	On (Selectable image) / <u>Off</u>
File No.	<u>Continue</u> / Reset
World Time	<u>Home</u> / World Home time setup (city, DST, etc.) World Time setup (city, DST, etc.)
Date Style	YY/MM/DD / DD/MM/YY / MM/DD/YY
Adjust	Time setting
Language	日本語 / English / Français / Deutsch / Español / Italiano / Português / 中國語 / 中国語 / 한국어
Auto Power Off	<u>2 min</u> / 5 min
Format	Format / <u>Cancel</u>
Reset	Reset / <u>Cancel</u>

### ■ PLAY mode

#### ● PLAY tab menu

Slideshow	<u>Start</u> / Images / Time / Interval
Calender	–
Favorites	<u>Show</u> / Save / Cancel
Create Album	<u>Create</u> / Layout / Set Up / Cancel
DPOF	<u>Select images</u> / All images / Cancel
Protect	<u>On</u> / All Files : On / Cancel
Rotation	<u>Rotate</u> / Cancel
Resize	<u>1280 x 960</u> / 640 x 480 / Cancel
Trimming	–
Dubbing*	–
Alarm	Alarm setups
Copy	<u>Built-in</u> → Card / Card → Built-in / Cancel
Audio Player*	<u>Random</u> / BASS BOOST / Delete

## ● Set Up tab menu

Beep (EX-S20)	<u>On</u> / Off
Sounds (EX-M20)	<u>Startup</u> / Shutter / Operation / Volume
Startup	On (Selectable image) / <u>Off</u>
File No.	<u>Continue</u> / Reset
World Time	<u>Home</u> / World Home time setup (city, DST, etc.) World Time setup (city, DST, etc.)
Date Style	YY/MM/DD / DD/MM/YY / MM/DD/YY
Adjust	Time setting
Language	日本語 / English / Français / Deutsch / Español / Italiano / Português / 中國語 / 中国語 / 한국어
Auto Power Off	<u>2 min</u> / 5 min
Format	Format / <u>Cancel</u>
Reset	Reset / <u>Cancel</u>

## Indicator Lamp Reference

## Camera Indicator Lamps

The camera has two indicator lamps: an operation/flash charge lamp and a self-timer lamp. These lamps light and flash to indicate the current operational status of the camera.

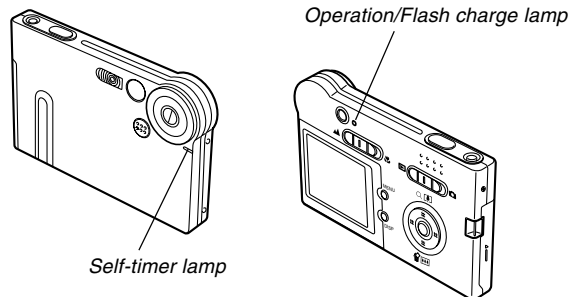

\* There are two lamp flash patterns. Pattern 1 flashes once per second, while Pattern 2 flashes twice per second. The table below explains what each flash pattern indicates.

## ■ REC Mode

Operation/Flash Charge Lamp		Self-timer Lamp		Meaning
Color	Status	Color	Status	
Green	Lit			Power on
Amber	Pattern 1			Flash charging
Green	Lit			Monitor screen off
Green	Pattern 2			Storing image
Green	Pattern 1	Red	Pattern 1	Self-timer countdown (10 to 3 seconds)
Green	Pattern 2	Red	Pattern 2	Self-timer countdown (3 to 1 seconds)
Red	Lit			Memory error
Red	Lit			Memory full
Red	Pattern 1			Low battery alert
Red	Pattern 1			Monitor screen disabled
Green	Pattern 2			Powering down

### ▶▶▶ IMPORTANT! ◀◀◀

- Never remove the memory card from the camera while the operation/flash charge lamp is flashing. Doing so will cause recorded images to be lost.

## ■ PLAY Mode

Operation/Flash Charge Lamp		Self-timer Lamp		Meaning
Color	Status	Color	Status	
Green	Lit			Power on
Green	Pattern 2			Deleting image
Red	Lit			Memory error
Red	Pattern 1			Low battery alert
Green	Pattern 2			Formatting
Green	Pattern 2			Powering down



## USB Cradle Indicator Lamps

The USB cradle has two indicator lamps: a [CHARGE] lamp and a [USB] lamp. These lamps light and flash to indicate the current operational status of the USB cradle and camera.

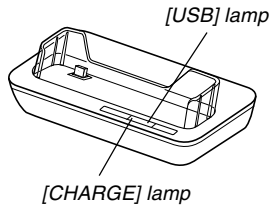

[CHARGE] lamp		[USB] lamp		Meaning
Color	Status	Color	Status	
Red	Lit			Charging
Green	Lit			Charging complete
Amber	Lit			Charge standby
Red	Flashing			Charge error
		Green	Lit	USB connection
		Green	Flashing	Accessing memory

## Troubleshooting Guide

	Symptom	Possible Cause	Action
Power Supply	Power does not turn on.	<ol style="list-style-type: none"> <li>1) The battery is not oriented correctly.</li> <li>2) The battery is dead.</li> </ol>	<ol style="list-style-type: none"> <li>1) Orient the battery correctly (page 26).</li> <li>2) Charge the battery (page 28). If the battery goes dead soon after being charged, it means the battery has reached the end of its life and needs to be replaced. Purchase a separately available NP-20 rechargeable lithium ion battery.</li> </ol>
	Camera suddenly powers down.	<ol style="list-style-type: none"> <li>1) Auto Power Off activated (page 36).</li> <li>2) The battery is dead.</li> </ol>	<ol style="list-style-type: none"> <li>1) Turn power back on.</li> <li>2) Charge the battery (page 28).</li> </ol>
Image Recording	Image is not recorded when the shutter release button is pressed.	<ol style="list-style-type: none"> <li>1) The mode selector is set to "▶" (PLAY).</li> <li>2) Flash unit is being charged.</li> <li>3) Memory is full.</li> </ol>	<ol style="list-style-type: none"> <li>1) Align the mode selector with "📷" (REC).</li> <li>2) Wait until the flash unit finishes charging.</li> <li>3) Transfer files you want to keep to your computer and then delete files from image memory, or use a different memory card.</li> </ol>
	Camera powers down during self-timer countdown.	The battery is dead.	Charge the battery (page 28).
	Recorded images are not saved in memory.	<ol style="list-style-type: none"> <li>1) Camera powers down before the save operation is complete.</li> <li>2) Removing the memory card before the save operation is complete.</li> </ol>	<ol style="list-style-type: none"> <li>1) When the battery indicator shows , charge the battery as soon as possible (page 28).</li> <li>2) Do not remove the memory card before the save operation is complete.</li> </ol>

## APPENDIX

	Symptom	Possible Cause	Action
Playback	Color of the playback image is different from the image on the monitor screen during recording.	Sunlight or light from another source is shining directly into the lens during recording.	Position the camera so sunlight does not shine directly into the lens.
	Images are not displayed.	A memory card with non-DCF images recorded with another camera is loaded in the camera.	This camera cannot display non-DCF images recorded onto a memory card using another digital camera.
Audio Playback	Cannot playback audio, cannot hear audio, or cannot control the audio playback using the remote controller.	<ol style="list-style-type: none"> <li>1) There is no MP3 file data in memory. This is indicated by the message "NoData" on the remote controller LCD.</li> <li>2) Stereo headphones are not connected correctly.</li> <li>3) Volume setting is too low.</li> <li>4) The battery is dead.</li> <li>5) The remote controller buttons are locked.</li> </ol> <ol style="list-style-type: none"> <li>6) There are no playable files.</li> <li>7) Improper PLAYLIST.TXT file contents</li> </ol>	<ol style="list-style-type: none"> <li>1) Transfer MP3 files to the camera's AUDIO folder.</li> <li>2) Correctly connect the headphones to the headphones jack.</li> <li>3) Adjust the volume to a higher level.</li> <li>4) Charge the battery (page 28).</li> <li>5) Slide the remote controller lock switch in the opposite direction of the arrow marking to unlock the controls.</li> <li>6) Check the files you are trying to play (page 159).</li> <li>7) Check to make sure the PLAYLIST.TXT file lists the MP3 files you want to play.</li> </ol>
	Playback time is short.	The battery is dead.	Charge the battery (page 28).

\* Note that audio player capabilities are available with the EX-M20 only.

## APPENDIX

	Symptom	Possible Cause	Action
Other	All buttons and switches are disabled.	Circuit problem caused by electrostatic charge, impact, etc. while the camera was connected to another device.	Remove the battery from the camera, reinsert it, and then try again.
	Monitor screen is off.	<ol style="list-style-type: none"> <li>1) USB communication is in progress.</li> <li>2) The monitor screen is turned off (in the REC mode).</li> </ol>	<ol style="list-style-type: none"> <li>1) After the computer stops accessing camera file memory, press the [USB] button on the USB cradle. Check to make sure that the [USB] lamp on the USB cradle is off, and then remove the camera from the USB cradle.</li> <li>2) Press [DISP] to turn on the monitor screen.</li> </ol>
	Cannot transfer files over a USB connection.	<ol style="list-style-type: none"> <li>1) Camera is not set securely on the USB cradle.</li> <li>2) USB cable is not connected securely.</li> <li>3) USB driver is not installed.</li> <li>4) Camera is turned off.</li> </ol>	<ol style="list-style-type: none"> <li>1) Check the connection between the camera and USB cradle.</li> <li>2) Check all connections.</li> <li>3) Install the USB driver on your computer (page 131).</li> <li>4) Press the [USB] button on the USB cradle.</li> </ol>

## Display Messages

---

**Alarm setting complete.** This message appears after you change the alarm setting.

---

**Battery is low.** The battery is dead.

---

**Cannot register any more files.**

- You are attempting to register a BESTSHOT setup when the "SCENE" folder already contains 999 setups.
- You are attempting to register a FAVORITE file when the "FAVORITE" folder already contains 9999 files.

---

**Card ERROR** Some problem occurred with the memory card. Turn off the camera, and remove and then reinsert the memory card. If the same message appears, format the memory card (page 127).

---

**»» IMPORTANT! ««**

Formatting the memory card deletes all files on the memory card. Before formatting, try transferring recoverable files to a computer or some other storage device.

---

**File could not be saved because battery is low.** The battery is dead, so the recorded image could not be saved.

---

**Folder cannot be created.** This message appears when you try to record an image while there are 9,999 files stored in the 999th folder. If you want to record more files, delete files you no longer need (page 97).

---



---

**Memory Full** Memory is full. If you want to record more files, delete files you no longer need (page 97).

---

**No Favorites file!** There is no FAVORITE file.

---

**Printing Error** One of the following problems occurred during printing.

- Printer power off
- Out of paper
- Out of ink
- Printer internal error

---

**Record Error** Image compression could not be performed during image data storage for some reason. Record the image again.

---

**SYSTEM ERROR** Your camera system is corrupted. Contact your retailer or a CASIO service center.

---

**The card is locked.** The LOCK switch of the SD memory card is locked. You cannot store images to or delete images from a memory card that is locked.

---

**This function is not supported for this file.** The function you are trying to perform is not supported for the file on which you are trying to perform it.

---

**There are no files.** There are no files in built-in memory or on the memory card.

---

<b>There are no printing images.</b>	There are no DPOF settings specifying images and the number of copies of each for printing.
<b>Set up DPOF.</b>	Configure the required DPOF settings (page 101).
<b>There is no file to register.</b>	You are trying to save an invalid file as a BESTSHOT user setup, or as an original startup image.
<b>This card is not formatted.</b>	The memory card is not formatted. Format the memory card (page 127).
<b>This file cannot be played.</b>	The image file or audio file is corrupted, or is a type that cannot be displayed by this camera.
<b>This function cannot be used.</b>	You attempted to copy files from built-in memory to a memory card while there is no memory card loaded in the camera (page 126).

## Specifications

### Main Specifications

**Product** ..... Digital Camera

**Model** ..... EX-S20/EX-M20

### ■ Camera Functions

#### Image Files Format

Snapshots: ..... JPEG (Exif Version 2.2); DCF (Design Rule for Camera File System)1.0 standard; DPOF compliant

Movies: ..... AVI (Motion JPEG)

Audio: ..... WAV (EX-M20 only)

**Recording Media:** ..... 10MB built-in flash memory  
SD Memory Card  
MultiMediaCard

#### Image Size

Snapshots: ..... 1600 x 1200 pixels  
1600 x 1072 (3:2) pixels  
1280 x 960 pixels  
640 x 480 pixels

Movies: ..... 320 x 240 pixels

## APPENDIX

### Approximate Memory Capacity and File sizes

#### • Snapshots

File Size (pixels)	Quality	Approximate Image File Size	Built-in flash memory 10MB	SD Memory Card* 64MB
1600 x 1200 (UXGA)	Fine	1050KB	8 shots	57 shots
	Normal	710KB	12 shots	77 shots
	Economy	370KB	24 shots	151 shots
1600 x 1072 (3:2)	Fine	910KB	9 shots	59 shots
	Normal	610KB	14 shots	89 shots
	Economy	300KB	27 shots	173 shots
1280 x 960 (SXGA)	Fine	680KB	12 shots	81 shots
	Normal	460KB	19 shots	124 shots
	Economy	250KB	34 shots	217 shots
640 x 480 (VGA)	Fine	190KB	46 shots	289 shots
	Normal	140KB	60 shots	379 shots
	Economy	90KB	96 shots	607 shots

#### • Movies (320 x 240 pixels)

Data Size	160KB/second max.
Recording Time	One Movie: 60 seconds maximum Total Movie Time: 60 seconds maximum (built-in memory) 380 seconds maximum (SD 64MB memory card)*

\* Based on Matsushita Electric Industrial Co., Ltd. products. Capacity depends on card manufacturer.

\* To determine the number of images that can be stored on a memory card of a different capacity, multiply the capacities in the table by the appropriate value.

**Delete** ..... Single-file, all files (with protection)

**Effective Pixels:** ..... 2.0 million

**Imaging Element:** ..... 1/2.7-inch square pixel color CCD  
(Total pixels: 2.11 million)

**Lens/Focal Distance** ..... F3.5/f = 5.6mm  
(Equivalent to 37mm on a 35mm film camera.)

**Zoom** ..... 4X digital zoom

**Focusing** ..... Fixed focus with macro mode

**Focus Range** ..... Normal focus: Approximately 0.8 m to ∞  
(2.6' to ∞)  
Macro focus: Approximately 30cm  
(11.8") (Optimum field of view at A4-size.)

#### Exposure Control

Metering: ..... Multi-pattern by imaging element

Exposure: ..... Program AE

Exposure Compensation: ... -2EV to +2EV (in 1/3EV steps)

**Shutter** ..... CCD shutter, mechanical shutter  
1/8 to 1/8000 second  
(Depends on REC mode and ISO sensitivity setting being used.)  
• Shutter speed is different for the following BESTSHOT scenes.  
Night Scene: 1 to 1/8000 second  
Fireworks: 2 seconds (fixed)

**Aperture:** ..... F3.5 fixed

**White Balance** ..... Automatic/fixed (4 modes) /Manual

## APPENDIX

**Self-timer** ..... 10 seconds, 2 seconds, Triple Self-timer

### Built-in Flash

Flash Modes: ..... Auto, Off, On, Red-eye reduction  
Approximate Flash Range: ... 0.8 meter to 1.5 meters (2.6' to 4.9')  
(ISO Sensitivity: "Auto")

**Recording Functions** ..... Snapshot (with audio for EX-M20 only); Macro; self-timer; BESTSHOT; Movie (with audio for EX-M20 only); voice recording (EX-M20 only)  
\* Audio is monaural

### Audio Recording Time (EX-M20 only)

Audio Snapshot: ..... Approximately 30 seconds maximum per image  
Voice Recording: ..... Approximately 40 minutes with built-in memory  
After Recording: ..... Approximately 30 seconds maximum per image

**Monitor Screen** ..... 1.6-inch TFT color LCD  
84,960 pixels (354 x 240)

**Viewfinder** ..... Monitor screen and optical viewfinder

**Timekeeping Functions** .... Built-in quartz digital clock  
Date and Time: ..... Recorded with image data  
Auto Calendar: ..... To 2049

**World Time:** ..... City; Date; Time; Summer time;  
162 cities in 32 time zones

**Input/Output Terminals** .... Cradle connector  
(EX-M20 connector is also used for connection of remote controller.)

**Microphone** ..... Monaural (EX-M20 only)

**Speaker** ..... 13mm round, monaural (EX-M20 only)

## ■ Audio Player Function (EX-M20 Only)

### Data Compression/

**Decompression** ..... MP3 (MPEG-1 Audio Layer-3 / MPEG-2 Audio Layer-3)

**Sampling Frequencies** ..... 32/44.1/48kHz  
(MPEG-1 Audio Layer-3)  
16/22.05/24kHz  
(MPEG-2 Audio Layer-3)

**Bit Rates** ..... 32 to 320kbps, VBR-compatible  
(MPEG-1 Audio Layer-3)  
8 to 160kbps, VBR-compatible  
(MPEG-2 Audio Layer-3)

**Play Mode** ..... Normal, all track repeat, 1-track repeat, random play

### Practical Maximum

**Headphone Output** ..... 11mW + 11mW (16 Ω)

A bit rate of 128kbps and a sampling frequency of 44.1kHz are recommended for MP3 files.



## APPENDIX

### ■ Power Supply

**Power Requirements** ..... Rechargeable lithium ion battery (NP-20) x 1

#### Approximate Battery Life:

Number of Shots,Continuous Recording*1 (Recording Time)	720 shots (120 minutes)
Number of Shots,Normal Recording*2 (Recording Time)	190 shots (95 minutes)
Continuous Playback*3 (Continuous Snapshot Recording)	180 minutes
Continuous Voice Recording*4	170 minutes
Continuous Audio Playback*5	450 minutes

The above values indicate the amount of time under the conditions defined below, until power automatically turns off due to battery failure. They do not guarantee that you will be able to achieve this level of operation. Low temperatures shorten battery life.

\*1 Continuous Recording Conditions

- Temperature: 23°C (73°F)
- Monitor screen: On
- Flash: Off
- Image recorded about every 10 seconds

\*2 Normal Recording Conditions

- Temperature: 23°C (73°F)
- Monitor screen: On
- Flash: On (one flash every two shots)
- Image recorded about every 30 seconds
- Power off/on every 10 shots

\*3 Continuous Playback Conditions

- Temperature: 23°C (73°F)
- Scroll one image about every 10 seconds

\*4 Voice recording times are based on continuous recording.

\*5 Audio playback times are based on continuous output (through headphones).

- Voice recording and audio playback times apply to the EX-M20 only.

**Power Consumption** ..... DC 3.7V Approximately 2.5W

### ■ Other

#### Dimensions

EX-S20: ..... 83(W) x 53(H) x 11.3(D) mm  
(3.3"(W) x 2.1"(H) x 0.44"(D))  
(excluding projections)

EX-M20: ..... 83(W) x 53(H) x 12.4(D) mm  
(3.3"(W) x 2.1"(H) x 0.49"(D))  
(excluding projections)

#### Weight

EX-S20: ..... Approximately 78 g (2.8 oz)  
(excluding battery and accessories)

EX-M20: ..... Approximately 80 g (2.8 oz)  
(excluding battery and accessories)

**Bundled Accessories** ..... Rechargeable lithium ion battery (NP-20); USB Cradle (CA-23); Special AC Adaptor (AD-C51G); AC power cord; Strap; USB cable; LCD Remote Controller (bundled with EX-M20 only); Stereo Headphones (bundled with EX-M20 only); CD-ROM; Basic Reference

## APPENDIX

### ■ Rechargeable Lithium Ion Battery (NP-20)

**Rated Voltage:** ..... 3.7 V

**Rated Capacitance:** ..... 680 mAh

#### **Operating Temperature**

**Range:** ..... 0°C to 40°C (32°F to 104°F)

**Dimensions:** ..... 33 (W) x 50 (H) x 4.7 (D) mm  
(1.3" (W) x 2.0" (H) x 0.19" (D))

**Weight:** ..... Approximately 16 g (0.56 oz)

### ■ USB Cradle (CA-23)

**Input/Output Terminals** .... Camera connector; USB port; AC adaptor terminal (DC IN 5.3V)

**Power Consumption** ..... DC 5.3V Approximately 3.2W

**Dimensions** ..... 101(W) x 32(H) x 58(D) mm  
(4.0"(W) x 1.3"(H) x 2.3"(D))  
(excluding projections)

**Weight** ..... Approximately 58 g (2.0 oz)

### ■ Special AC Adaptor (AD-C51G)

**Power Requirement** ..... 100 to 240V AC, 50/60Hz, 83mA

**Output** ..... 5.3V DC, 650mA

**Dimensions** ..... 78(W) x 20(H) x 39(D) mm  
(3.1"(W) x 0.78"(H) x 1.5"(D))  
(excluding projections and cable)

**Weight** ..... Approximately 90 g (3.2 oz)

### ■ LCD Remote Controller (Bundled with EX-M20 Only)

**Input/Output Terminals** .... Camera connector; headphones jack  
(ø3.5mm stereo mini jack)

**Cord Length** ..... Approximately 0.8m (31.5")

**Dimensions** ..... 74.5(W) x 16(H) x 11(D) mm  
(2.9"(W) x 0.63"(H) x 0.43"(D))  
(excluding projections, excluding cradle)

**Weight** ..... Approximately 28 g (1.0 oz)

## APPENDIX

### Power Supply

- Use only the special NP-20 rechargeable lithium ion battery to power this camera. Use of any other type of battery is not supported.
- This camera does not require a battery for the clock. The date and time settings of the camera are cleared whenever power supplied by both the battery and USB cradle is interrupted. Be sure to reconfigure these settings after power is interrupted (page 39).

### LCD Panel

- The LCD panel is a product of the latest LCD manufacturing technology that provides a pixel yield of 99.99%. This means that less than 0.01% of the total pixels are defective (they do not turn on or always remain turned on).

### Lens

- You may sometimes notice some distortion in certain types of images, such as a slight bend in lines that should be straight. This is due to the characteristics of lens, and does not indicate malfunction of the camera.

## Free Manuals Download Website

<http://myh66.com>

<http://usermanuals.us>

<http://www.somanuals.com>

<http://www.4manuals.cc>

<http://www.manual-lib.com>

<http://www.404manual.com>

<http://www.luxmanual.com>

<http://aubethermostatmanual.com>

Golf course search by state

<http://golfingnear.com>

Email search by domain

<http://emailbydomain.com>

Auto manuals search

<http://auto.somanuals.com>

TV manuals search

<http://tv.somanuals.com>