

CASIO®

Handheld Terminal DT-X30 Series

User's Guide

Be sure to read "Safety Precautions" inside this guide before trying to use your Handheld Terminal.

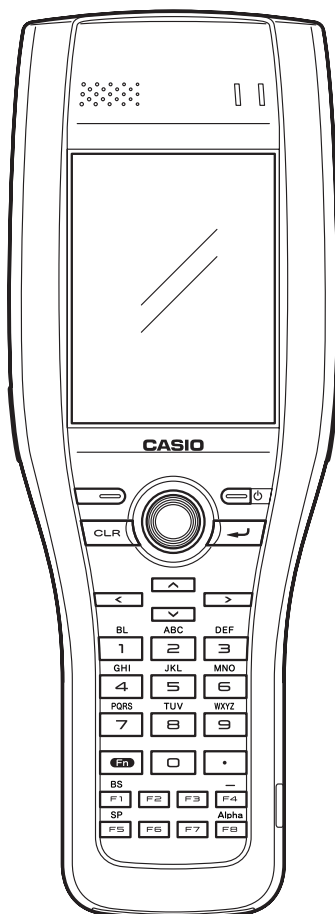

-
- This Product is equipped with the Brycen BL-RAPPORE Stack and My Wirefree Network Bluetooth User Interface Application, the use of which is governed by a license granted by Brycen Co., Ltd.



- BLUETOOTH is a registered trademark owned by Bluetooth SIG, Inc. and licensed to CASIO COMPUTER CO., LTD.
- Microsoft and Windows are either registered trademarks or trademarks of Microsoft Corporation in the United States and/or other countries.

Information in this document is subject to change without advance notice. CASIO Computer Co., Ltd. makes no representations or warranties with respect to the contents or use of this manual and specifically disclaims any express or implied warranties of merchantability or fitness for any particular purpose.

Contents

Safety Precautions	E-3
Operating Precautions	E-9
Important	E-9
After Service	E-9
Regulatory Information	E-10
Handheld Terminal System Configuration	E-13
General Guide	E-15
Loading and Removing the Battery Pack	E-18
Loading	E-19
Removing	E-20
Charging the Battery Pack	E-21
USB Cradle/Ethernet Cradle/Cradle-type Battery Charger	E-21
Dual Battery Charger	E-21
Car Mounted-type Battery Charger.....	E-22
Attaching the Hand Belt	E-23
Configuring Handheld Terminal Settings	E-24
Calibrating Touch Screen Alignment.....	E-24
Using the Laser Scanner (Laser Models)	E-25
Using the C-MOS Imager (Imager Models)	E-26
Warning Label	E-27
Laser Beam	E-27
Adjusting the Laser Light Emission Width	E-28
Performing Communications	E-30
IR Communication.....	E-30
Bluetooth® Communication	E-31
GSM Communication	E-32
GPS	E-32
Handling microSD Cards	E-33
Installing.....	E-33
Removing.....	E-34
Handling SIM Cards	E-35
Installing.....	E-35
Removing.....	E-36

Resetting the Handheld Terminal	E-37
DT-X30 Specifications	E-38
Using the USB Cradle (HA-G60IO)	E-42
General Guide	E-42
Specifications	E-44
Using the Ethernet Cradle (HA-G62IO)	E-45
General Guide	E-45
Specifications	E-47
Using the Cradle-type Battery Charger (HA-G30CHG)	E-48
General Guide	E-48
Specifications	E-49
Using the Car Mounted-type Battery Charger (HA-G35CHG)	E-50
General Guide	E-50
Specifications	E-51
Using the Dual Battery Charger (HA-G32DCHG)	E-52
General Guide	E-52
Connecting Multiple Dual Battery Chargers.....	E-54
Specifications	E-55
Using Rechargeable Battery Pack	E-56
Specifications	E-56

Safety Precautions

Congratulations upon your selection of this CASIO product. Be sure to read the following Safety Precautions before trying to use it for the first time.

Your neglect or avoidance of the warning and caution statements in the subsequent pages causes the danger of fire, electric shock, malfunction and damage on the goods as well as personal injury.

Markings and Symbols

The following are the meanings of the markings and symbols used in these Safety Precautions.



This symbol indicates information that, if ignored or applied incorrectly, creates the danger of death or serious personal injury.



This symbol indicates information that, if ignored or applied incorrectly, creates the possibility of death or serious personal injury.



This symbol indicates information that, if ignored or applied incorrectly, creates the possibility of personal injury or property damage.



- A diagonal line indicates something you should not do. The symbol shown here indicates you should not try to take the unit apart.



- A black circle indicates something you should do. The symbol shown here indicates you should unplug the unit from the wall outlet.



Disassembly and Modification



- Never try to disassemble or modify the Handheld Terminal and its options including battery pack and battery in any way.

Abnormal Conditions



- Should the Handheld Terminal and/or its options including battery pack and battery become hot or start to emit smoke or a strange odor, immediately turn off the power and contact your dealer or distributor whom you purchased the product from, or an authorized CASIO service provider.

Warning

Dust and Moisture

-  • Though the Handheld Terminal is dust and water splash resistant, its options including the battery pack are not. Keep loose metal objects and containers filled with liquid away from your Handheld Terminal and the options. Also, never handle the Handheld Terminal and the options while your hands are wet.

Laser Light

-  • This product with the integrated laser scanning module scans bar codes using laser light. Never look directly into the laser light or shine the laser light into the eyes.

Warning

Interference with the Operation of Other Equipment (Using Wireless Data Communication)

-  • Keep your Handheld Terminal at least 22 centimeters (8¹¹/₁₆") away from anyone wearing a pacemaker. Radio waves emitted by the Handheld Terminal can affect the operation of a pacemaker.
- Before the use in aircraft, be sure to consult with cabin crew for interference the Handheld Terminal emits.
- Before the use in medical facility, be sure to consult with the facility management or the manufacture of a specific medical equipment that the Handheld Terminal may interfere with.
- Do not use the Handheld Terminal nearby gas pump or chemical tank or any other places flammable or explosive.

Caution

Foreign Objects

-  • Take care to ensure that metals or combustible objects are not inserted into the openings of the Handheld Terminal or its options, and not to allow moisture to get inside of them.

Location



-  • Install the cradle properly on a flat and stable surface so that it cannot fall down onto floor.

LCD Screen

-  • Never apply strong pressure to the screen or subject it to strong impact. Doing so can crack the LCD Screen.

Warning

Avoiding Traffic Accidents



-  • Never use your Car Mounted-type Battery Charger while operating a motor vehicle. Park your vehicle in a safe place before performing any operation.
-  • Never locate the Car Mounted-type Battery Charger where it might interfere with proper operation of the vehicle.
-  • Locate connecting cables as instructed by the manual, avoiding locations that can interfere with driving operations.

Car Battery Power

-  • Should the Car Power Cable become damaged, replace it immediately with a new Car Power Cable when using the Car Mounted-type Battery Charger.



Caution

Installing in Vehicle



-  • To save your vehicle's battery from running down, be sure that the Car Power Cable should be unplugged from the cigarette lighter socket when you do not use the Car Mounted-type Battery Charger and that the use of the battery charger should be avoid while the vehicle's engine is turned off.
-  • Do not handle the Car Power Cable with wet hands.
-  • Install the Car Mounted-type Battery Charger at location in a vehicle where strong vibration, unstable, excessive of humidity and dust, and under direct sunlight can be avoid. Also, avoid the area where the air bag inflates or any other area where your safe driving is blocked.
- Do not leave the Handheld Terminal in vehicle for a long period of time.

Optional Lithium-ion Battery Pack

Danger

-  • Never use the Handheld Terminal and its option including the battery pack and battery next to open flame, near a stove, or any other area exposed to high heat, or leave them for a long period of time in a vehicle parked in direct sunlight.
- Never use the battery pack with any device other than the Handheld Terminal.
- Never dispose of the battery pack by incinerating it or otherwise expose it to heat.
- Never transport or store the battery pack together with metal objects that may result in shorting positive (+) and negative (-) terminals of the battery pack. Be sure to place the battery pack in its case whenever transporting or storing it.
- Never throw the battery pack or otherwise subject it to strong impact.
- Never pierce the battery pack with nails, hit it with a hammer, or step on it.
-  • Use only the specified battery charger to charge the battery pack.

Warning



-  • Never place the battery pack in a microwave oven or any other high-voltage device.
-  • If the amount of time period the battery pack can serve becomes considerably short even after it has been fully charged for the specified time period, stop using it.
- Should the battery pack start to leak or emit a strange odor, immediately move it away from any flame nearby. Leaking battery fluid is combustible.
- Should fluid from the battery pack accidentally get into your eyes or on the skin, do not rub it. Immediately rinse it off with clean tap water and then consult a physician.

Caution





-  • Replace only with the same type of battery pack recommended by CASIO. Dispose of used battery packs according to the local regulation.
- Keep the battery pack out of the reach of small children.

Power Supply / AC Adaptor

Warning

-  Do not use the Handheld Terminal at a voltage other than the specified voltage. Also, do not connect the Handheld Terminal to a multi-plug power strip.
- Never modify, sharply bend, twist, or pull on the power cord.
- Never use a detergent to clean AC adaptor and its power cable, especially on the plug and the jack.
-  When using the battery chargers and the cradles, be sure to use the respective AC adaptors.

Caution

-  Never pull on the power cord when unplugging it. Always hold the plug when unplugging it from the wall outlet.
- Never touch the plug while your hands are wet.
-  Be sure to unplug the power cord from the wall outlet before cleaning the battery chargers and the cradles.
- Unplug the power cord from the wall outlet whenever leaving the battery chargers and the cradles unattended for a long period.
-  The housing of the AC adaptor can become warm during normal use.
-  At least once a year, unplug the AC adaptor from the wall outlet and clean any dust that builds up between the prongs of the plug. Dust built up between the prongs can lead to the danger of fire.

Backup Copies of All Important Data

Caution



- Note that CASIO Computer Co., Ltd. shall not be held liable to you or any third party for any damages or loss caused by deletion or corruption of data due to use of the Handheld Terminal, malfunction or repair of the Handheld Terminal or its peripherals, or due to the batteries going dead.
- The Handheld Terminal employs electronic memory to store data, which means that memory contents can be corrupted or deleted if power is interrupted due to the batteries going dead or incorrect battery replacement procedures. Data cannot be recovered once it is lost or corrupted. Be sure to make backup copies of all important data. One way to do this is to use the separately sold cradles to transfer data to a computer.

Operating Precautions

Your Handheld Terminal and its options are precision. Improper operation or rough handling can cause problems with data storage and other problems. Note and observe the following precautions to ensure proper operation.

- **Do not leave dead battery pack in the Handheld Terminal for a long period.**

Dead battery pack can leak, leading to malfunction and damage to the Handheld Terminal.

- **Stop or avoid using the Handheld Terminal and its options in areas and conditions subject to the following.**

- Large amounts of static electricity
- Extreme heat or cold or humidity
- Sudden temperature change
- Large amount of dust
- After large amount of rain or water falls on the Handheld Terminal
- Pressing the screen or keys with excessive force when using in the rain

- **Dead Pixels**

The LCD panel employed in this product uses high precision and substantial number of components which commonly cause a small number of the pixels not to light or to remain lit all the time. This is due to the characteristics of LCD panel yield in accuracy over 99.99% and permissible.

Important

- This guide does not include any information about programming and download procedures. See the applicable separate documentation for information about the procedures.

After Service

- Should this product ever malfunction, contact your original retailer providing information about the product name, the date you purchased it, and details about the problem.



This mark applies to EU countries and Turkey only.

Regulatory Information

The USA and Canada

GUIDELINES LAID DOWN BY FCC RULES FOR USE OF THIS UNIT IN THE U.S.A. (not applicable to other areas).

NOTICE

This equipment has been tested and found to comply with the limits for a Class B digital device, pursuant to Part 15 of the FCC Rules. These limits are designed to provide reasonable protection against harmful interference in a residential installation. This equipment generates, uses and can radiate radio frequency energy and, if not installed and used in accordance with the instructions, may cause harmful interference to radio communications. However, there is no guarantee that interference will not occur in a particular installation. If this equipment does cause harmful interference to radio or television reception, which can be determined by turning the equipment off and on, the user is encouraged to try to correct the interference by one or more of the following measures:

- Reorient or relocate the receiving antenna.
- Increase the separation between the equipment and receiver.
- Connect the equipment into an outlet on a circuit different from that to which the receiver is connected.
- Consult the dealer or an experienced radio/TV technician for help.

FCC WARNING

Changes or modifications not expressly approved by the party responsible for compliance could void the user's authority to operate the equipment.

Proper connectors must be used for connection to host computer and/or peripherals in order to meet FCC emission limits.

Caution Exposure to radio frequency radiation (below is for portable device)

To comply with FCC RF exposure compliance requirements, this device must not be co-located or operating in conjunction with any other antenna or transmitter.

Declaration of Conformity

Model Number: HA-G60IO, HA-G62IO
Trade Name: CASIO
Responsible party: Casio America, Inc. Industrial Handheld Division
Address: (10710 Baxter Avenue, Los Altos, California 94024 USA)
Telephone number: (408-738-8220)



This device complies with Part 15 of the FCC Rules. Operation is subject to the following two conditions:
(1) This device may not cause harmful interference, and (2) this device must accept any interference received, including interference that may cause undesired operation.

For Users in Canada

These Class B digital apparatuses comply with Canadian ICES-003.

Cet appareil numérique de la classes B est conforme à la norme NMB-003 du Canada.

These devices comply with RSS 210 of Industry Canada (IC).

Operation is subject to the following two conditions:

- (1) These devices may not cause interference, and
- (2) These devices must accept any interference, including interference that may cause undesired operation of this device.

L'utilisation de ce dispositif est autorisée seulement aux conditions suivantes :

(1) il ne doit pas produire de brouillage et

(2) l'utilisateur du dispositif doit être prêt à accepter tout brouillage radioélectrique reçu, même si ce brouillage est susceptible de compromettre le fonctionnement du dispositif.

Exposure to radio frequency radiation

The installer of this radio equipment must ensure that the antenna is located or pointed such that it does not emit RF field in excess of Health Canada limits for the general population; consult Safety Code 6, obtainable from Health Canada's website at http://www.hc-sc.gc.ca/ewh-semt/pubs/radiation/99ehd-dhm237/index_e.html

Europe

DECLARATION OF CONFORMITY

We, the under signed, CASIO Europe GmbH, hereby declare that the following equipment:

Product: Handheld Terminal

Models: DT-X30G, DT-X30GR, DT-X30E and DT-X30R

Brand: CASIO

are in conformity with all the provisions of the following EC directive with meeting the related test standards:

Council Directive: 1999/5/EC (R&TTE Directive):

Standards for all models:

EN 60950-1: 2001

EN 50371: 2002

EN 301 489-17 v1.2.1 (2002-08)

EN 300 328 v1.7.1 (2006-10)

Standards for DT-X30G and DT-X30GR only:

EN 50360:2002

EN 301 511 v9.0.2

EN 301 489-7 v1.3.1 (2005-11)

Hereunder, that this declaration is based on the above standards have been complied fully, constructing into a Technical File and reviewing by the Notified Body, Compliance Certification Services (NB Number; 0984).

Certificate/Expert Opinion issued by Compliance Certificate Services is available.

Manufacturer:

CASIO COMPUTER CO., LTD.

6-2, Hon-machi 1-chome, Shibuya-ku, Tokyo 151-8543, Japan

Representative within the European Union:

CASIO Europe GmbH

Casio-Platz 1, 22848 Norderstedt, Germany

Products are for distribution within
all member states of the EU.

CE 0984 

France limited to 2446.5-2483.5 MHz Indoor use.

Belgium limited to 2400-2483.5 MHz Indoor, 2460-2483.5 MHz Outdoor use.

The information described above dates from January 2008 and may be subjected to future changes.

Optional models HA-G60IO, HA-G62IO, HA-G30CHG, HA-G32DCHG and HA-G21BAT are in conformity with the Council Directive 2004/108/EC.

	Manufacturer:
	CASIO COMPUTER CO., LTD. 6-2, Hon-machi 1-chome, Shibuya-ku, Tokyo 151-8543, Japan
	Representative within the European Union:
	CASIO EUROPE GmbH Casio-Platz 1, 22848 Norderstedt, Germany

The CASIO DT-X30 models are designed, tested and found to meet the relevant regulatory standards described below.

DT-X30R

International standards:

IEC 60825-1

IEC 60529, IP64 level

Europe standards:

EN 60950-1

EN 60825-1

EN 300 328

EN 301 489-17

EN 50371

DT-X30GR

International standards:

IEC 60825-1

IEC 60529, IP64 level

Europe standards:

EN 60950-1

EN 60825-1

EN 300 328

EN 301 489-17

EN 301489-7

EN 301 511

EN 50371

EN 50360

Handheld Terminal System Configuration

DT-X30 Series

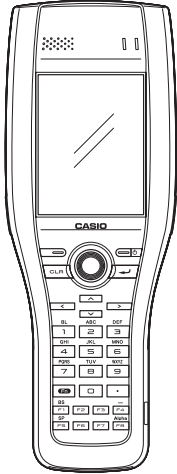

Bundled Items

Please check the contents in the box before using the Handheld Terminal for the first time.

Handheld Terminal

Hand Belt

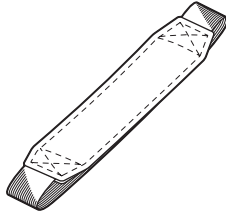

Stylus

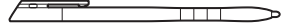

The stylus is attached to the Handheld Terminal.

User's Guide

Options

USB Cradle

HA-G60IO

The illustration shows the USB Cradle(HA-G60IO).

Ethernet Cradle

HA-G62IO

Cradle-type Battery Charger

HA-G30CHG

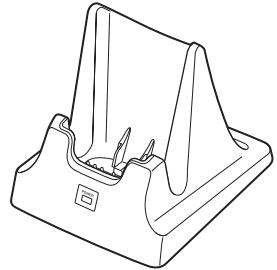

Car Mounted-type Battery Charger

HA-G35CHG

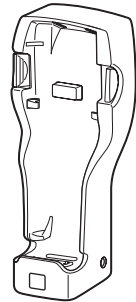

Options

Battery Pack

HA-G20BAT
(Battery Pack)

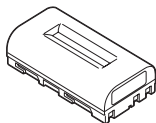

Soft Case

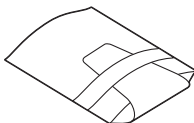

Dual Battery Charger

HA-G32DCHG

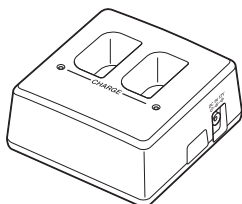

**AC Adaptor for USB Cradle/Ethernet Cradle/
Dual Battery Charger**

AD-S42120B-N

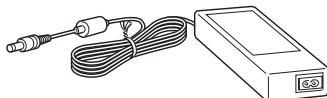

Power Cord for Europe

AC-CORD-EU

Power Cord for North America

AC-CORD-US

Power Cord for Taiwan

AC-CORD-TW

Power Cord for Korea

AC-CORD-KR

Power Cord for Australia

AC-CORD-AU

Screen Protect Sheet

HA-G90PS5



Cable

DT-380USB

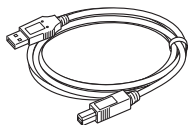

General Guide

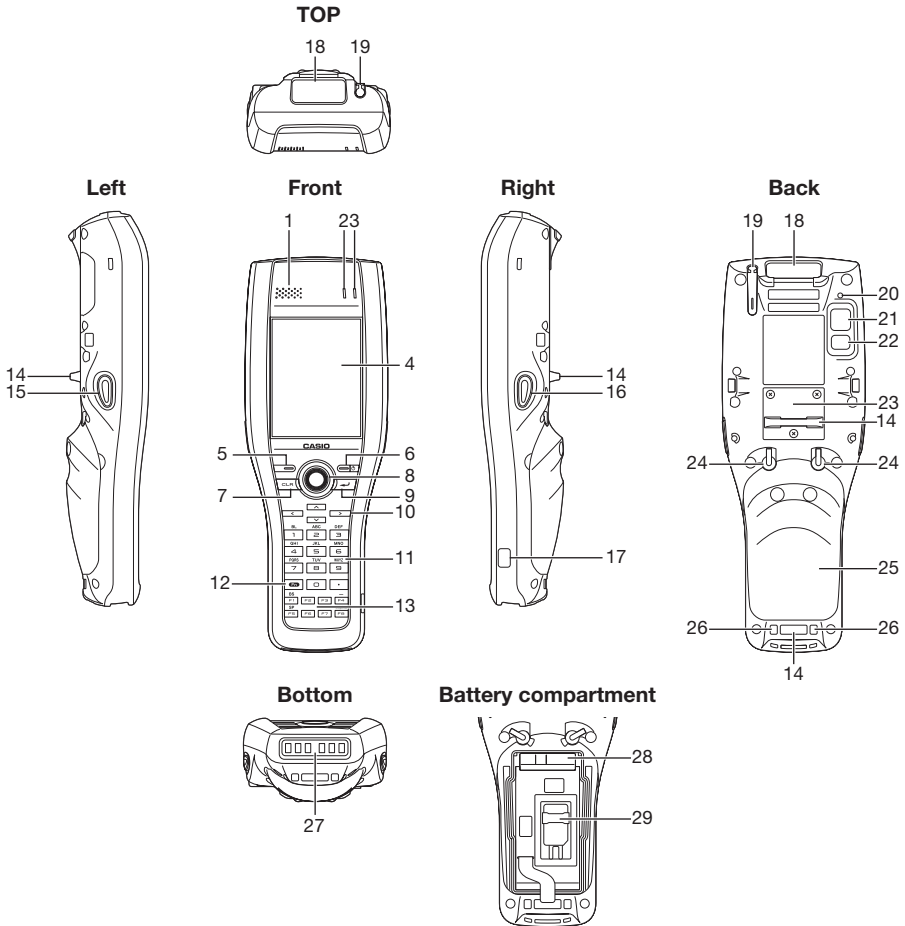

1	Speaker	Generates audio and buzzer tones.
2	Indicator 1	Orange: Charging Green: Charging complete Red: Battery pack error or the surrounding temperature is out of the charging temperature range.
3	Indicator 2	Flashes blue when operating via Bluetooth or orange when operating via W-LAN, GPS or W-WAN. Lights red when there is a bar code scanning error and lights green when a bar code scans successfully. Lights red when the alarm function is activated.

4	Screen	Displays text and operating instructions. In addition, operations can be performed and data can be input using the stylus provided.
5	Microphone	Used for audio input (including voice).
6	Power Key	Turns the power on and off.
7	CLR Key	Used to clear one letter to the left of the cursor.
8	Center Trigger Key	Used to perform bar code reading. Can be assigned an arbitrary function.
9	Enter Key	Press when finishing entering numerical values or when moving to the next step.
10	Cursor Keys	Perform the same functions as the up and down arrow keys on a PC keyboard.
11	Numeric Keys	Used to enter numeric values and decimal points.
12	Fn Key	Used to make various settings in combination with the function keys or numeric keys or when starting a pre-registered application.
13	Function Keys (Windows CE models)	<p>Various functions other than bar code reading can be assigned to these keys.</p> <p>The default key assignments are as follows.</p> <p>F1: Clears one letter to the left of the cursor.</p> <p>F2: Not assigned.</p> <p>F3: Not assigned.</p> <p>F4: Enters a “-” (minus symbol).</p> <p>F5: Enters a space.</p> <p>F6: Not assigned.</p> <p>F7: Not assigned.</p> <p>F8: Selects text entry mode.</p> <p>(The mode changes in order of Numeric → Uppercase letter → Lowercase letter.)</p>
	Function Keys (Windows Mobile models)	<p>Various functions other than bar code reading can be assigned to these keys.</p> <p>The default key assignments are as follows.</p> <p>F1: Left soft key.</p> <p>F2: Right soft key.</p> <p>F3: Not assigned.</p> <p>F4: Not assigned.</p> <p>F5: Not assigned.</p> <p>F6: Raises sound volume.</p>

		F7: Lowers sound volume. F8: Not assigned. Fn + F8: Selects text entry mode. (The mode changes in order of Numeric → Uppercase letter → Lowercase letter.)
14	Hand Belt Holes	Used to attach the hand belt.
15	L Trigger Key	Used to perform bar code reading.
16	R Trigger Key	Used to perform bar code reading.
17	IR Port	Used for communication with another Handheld Terminal.
18	Barcode Reader Port	Laser light or LED light is emitted from this window that reads bar codes.
19	Stylus Holder	Holds the stylus.
20	Reset Switch	Used to reset the Handheld Terminal.
21	Camera Lens (Camera models)	Takes photos.
22	Flash LED (Camera models)	Used for taking photos.
23	Expansion Port	Provided for future expansion.
24	Battery Pack Cover Lock Switch	Used to lock the battery cover and to release.
25	Battery Pack Cover	Used to cover the battery compartment that holds the battery pack inside.
26	Strap Holes	Used to attach the hand strap.
27	Power Contacts	Used to receive power provided by the USB Cradle or Ethernet Cradle. Also used for data communication.
28	MicroSD Card Slot	microSD card slot. (Remove the battery pack to load a card.)
29	SIM Card Slot (WWAN models)	SIM card slot. (Remove the battery pack to load the SIM card.)

Loading and Removing the Battery Pack

Your Handheld Terminal uses two types of battery: a battery pack and a memory backup battery.

The battery pack is used to power normal operations and to store data, while the memory backup battery (built-in) provides the power required to maintain memory contents when the battery pack power is unable to supply power for some reason.

When the battery pack power goes low, immediately charge it or replace it with a charged battery pack.

You can use either Dual Battery Charger, Cradle-type Battery Charger, USB Cradle, or Ethernet Cradle to charge a battery pack. See the respective user's guides for information about how to charge.

Important!

- **Remaining capacity on a battery pack when you purchase it may be depleted due to testing at the factory or natural discharge during shipment and storage. Be sure to charge the battery pack before you use it.**
- **The life of a battery pack is limited, and charging a battery pack causes it to gradually lose its ability to maintain the charge. If your battery pack seems to require charging very frequently, it probably means it is time to purchase a new one.**
- **If a battery pack is used past the end of its service life, it may swell up in size. In such a case, replace the battery pack with a new one.**
- **When the battery pack is attached, it takes 30 minutes for the backup battery to obtain enough charge for maintaining memory (RAM) contents for 10 minutes. It takes four days for the backup battery to achieve a full charge.**
- **Before replacing the battery pack, make sure that the power on the Handheld Terminal is completely shut down. When you turn off the Handheld Terminal, there is the case that the screen is off, but the Indicator 2 is still blinking. This indicates that the power off process of the GSM function has not been finished yet. If this is the case, never remove the battery pack cover until the indicator is turned off.**

Loading

1. Turn over the Handheld Terminal.
2. Remove the battery pack cover as follows:
 - 1 Slide the left and right lock switches for the battery pack cover to the “FREE” position.
 - 2 Hook your fingertips into the notches in the Handheld Terminal and lift the battery pack cover up in the direction indicated by the arrow.

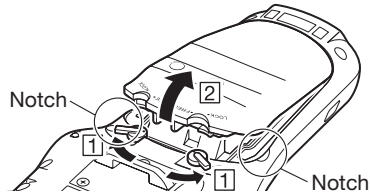

3. Load a battery pack (HA-G20BAT). Take care that the battery pack is oriented correctly when you load it. In addition, load the battery pack while making sure that the end of the battery pack removal tape is protruding above the battery pack.

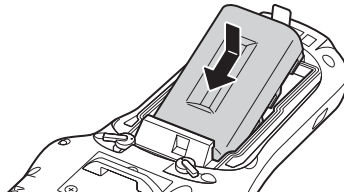

4. Put back the battery pack cover in the compartment as instructed by the arrows, 1 and 2 in the illustration and then return the battery pack cover lock switches to the “LOCK” position.

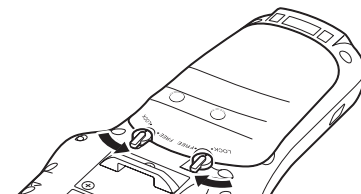
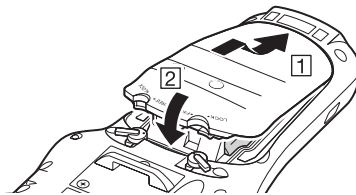

Removing

1. Make sure that the Handheld Terminal is turned off.
If the power is on, press the power key to turn it off.
2. Turn over the Handheld Terminal.
3. Refer to “Loading” on the previous page and remove the battery pack cover.
4. Remove the battery pack by pulling up the removal tape as shown in the illustration.

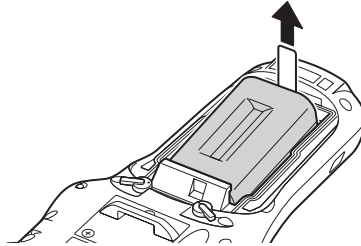

Important!

- **Before starting to use the Handheld Terminal, ensure that the battery pack cover is properly closed. If not, the power is not turned on or is turned off abruptly while it is in use.**

Charging the Battery Pack

To charge the battery pack, use one of the cradles and the battery chargers following the procedure described below. Be sure to use the separately sold AC adaptor (AD-S42120B-N) to power the cradle or charger.

Or, if you use the Car Mounted-type Battery Charger in a vehicle, use the accompanied Car Power Cable to power the charger.

USB Cradle/Ethernet Cradle/Cradle-type Battery Charger

The power LED on the front of the Cradle will light green if the Handheld Terminal has been properly mounted.

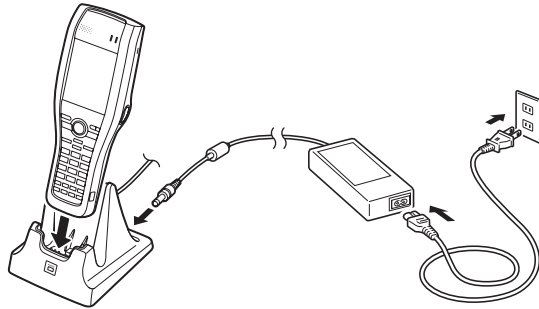

Status of Indicator 1 on DT-X30:

Orange: Charging

Red: Standby due to battery pack error or the surrounding temperature is out of the charging temperature range
(charging begins when the temperature is within the charging temperature range)

Green: Charging complete

Dual Battery Charger

Taking care that the battery pack is oriented correctly, insert it into the Dual Battery Charger.

This causes the Charge Indicator LED to light in red, indicating that charging has started.

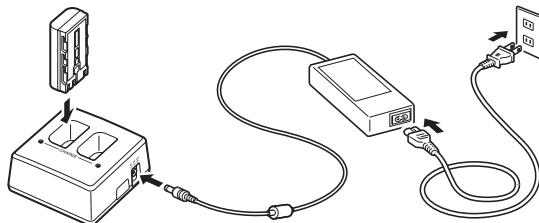

Status of Charge Indicator LED

Off: Not charging

Red: Charging

-
- Red Flashing: Battery pack problem
 - Green: Charging complete
 - Green Flashing: Standby due to the surrounding temperature being beyond the specified temperature range (Approximately 0°- 40°C) (charging resumes when the temperature reaches the range.)

Car Mounted-type Battery Charger

Plug in the Car Power Cable accompanied in the box to the Car Mounted-type Battery Charger as illustrated below and the other end to the cigarette lighter socket in vehicle. The power LED on the front of the Car Mounted-type Battery Charger will light green if the Handheld Terminal has been properly mounted.

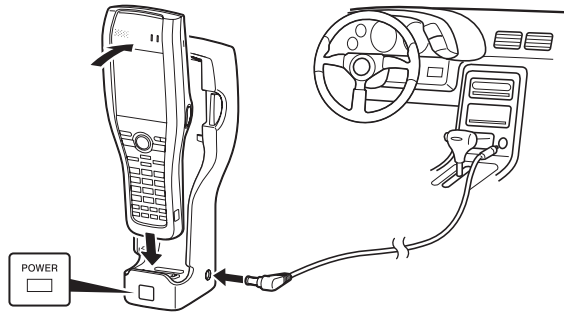

Status of Indicator 1 on DT-X30:

- Orange: Charging
- Red: Standby due to battery pack error or the surrounding temperature is out of the charging temperature range
(charging begins when the temperature is within the charging temperature range)
- Green: Charging complete

Attaching the Hand Belt

The hand belt can be used to prevent the Handheld Terminal from dropping when carrying it around. Attach the hand belt according to the procedure described below.

To attach the hand belt

1. Thread the belt through the hand belt hole as shown in the figure. Then fold it back and secure using the hook-loop fastener.

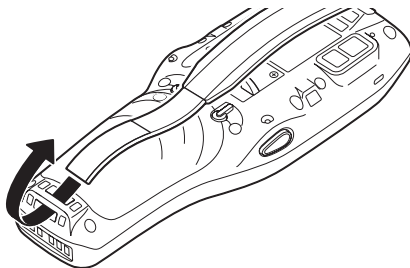

2. Thread the other end of the belt through the hand belt hole and adjust the length so that it fits comfortably on your hand. Then secure using the hook-loop fastener.

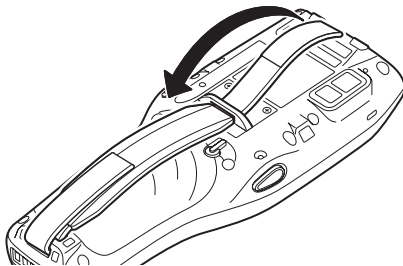

Important!

- Stick the hook-loop fastener down straight.
 - Ensure that the folded-back part does not overlap.
- See "Bad" example at right.

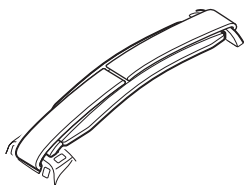

Good

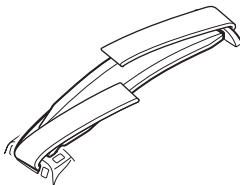

Bad

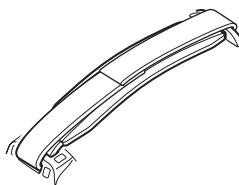

Bad

Configuring Handheld Terminal Settings

Calibrating Touch Screen Alignment

Whenever the response of the touch screen is poor, or the operations being executed do not match with the location you are tapping on the touch screen, please recalibrate the alignment of the touch screen using the following method.

- Press the “Fn” key and then press the “4” key after confirming that “F” is displayed in the lower right corner of the screen. The following screen is displayed. (Windows CE models)

* You can also display this screen by navigating as follows:

Windows CE models: Start → Settings → Stylus
→ Calibration

Windows Mobile models: Start → Settings → System
→ Screen → Align Screen

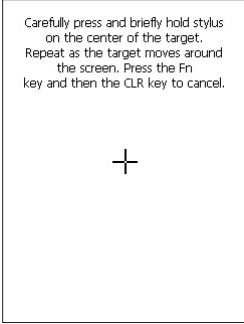

Carefully press and briefly hold stylus on the center of the target. Repeat as the target moves around the screen. Press the Fn key and then the CLR key to cancel.

* For Windows Mobile models, the screen is different.

- Press the stylus against the center of the target mark (+ mark) as indicated on the screen. The screen shown below appears after you press the stylus against the target at five different locations.

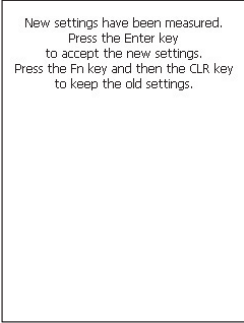

New settings have been measured. Press the Enter key to accept the new settings. Press the Fn key and then the CLR key to keep the old settings.

* For Windows Mobile models, the screen is different.

- Press the Enter key or tap anywhere on the touch screen. (Windows CE models)

Using the Laser Scanner (Laser Models)

1. After turning on the power, position the laser scanner close to a bar code and then press the trigger key.

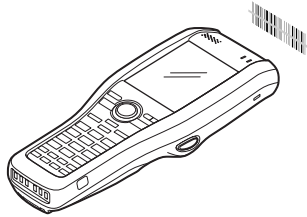

2. The laser emits light and scans the bar code. If scanning is completed normally, Indicator 2 displays a green light.

Important!

- **If you are unable to scan a bar code, try changing the angle at which the scanner is held or distance from the scanner to the bar code, and then try scanning again.**
- **This Handheld Terminal is capable of scanning bar codes at a distance of about 40-410 mm ($1^{9}/16''$ - $16^{1}/8''$). Furthermore, the distance at which scanning is possible may vary according to the bar code symbology.**

Using the C-MOS Imager (Imager Models)

1. Turn on the Handheld Terminal, position its C-MOS Imager reader port near the bar code or 2D code, and then press the Trigger Key.

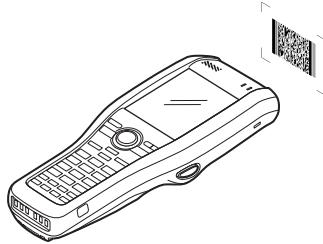

2. The Handheld Terminal reads the code by emitting laser and red lights. Indicator 2 (read operation indicator lamp) lights in green when the reading is successful.

Bar code and stacked 2D code Reading Guide

When you press the Trigger key, LEDs in the Handheld Terminal emit laser and red lights. Align the laser frame with the center of the bar code or 2D code you are trying to read. Take particular care aligning the light when there are other bar codes nearby.

When reading a bar code in large size, adjust the position of the Handheld Terminal so that the entire code is enclosed within the laser frame. For small size, move the Handheld Terminal closer to it.

Important!

- **If you have problem not properly reading a code, change the angle and/or the distance between the code and the Handheld Terminal and try reading it again.**
- **A bar code can be read from a distance of 40mm to 410mm ($1\frac{9}{16}$ " to $16\frac{1}{8}$ "), and a stacked 2D code can be read from a distance of 50mm to 250mm ($1\frac{15}{16}$ " to $9\frac{13}{16}$ ") and matrix 2D code can be read from a distance of 60mm to 150mm ($2\frac{3}{8}$ " to $5\frac{15}{16}$ "). The actual reading distance depends on the symbology and the resolution.**
- **Note that a special reader application is required to read bar codes and 2D codes.**
- **The DT-X30R-30/R-35/G-35U/GR-30/GR-30C/GR-35/GR-35C/G-35UC support reading of 2D code symbologies.**
- **Fingerprints, dust, dirt, or stain on the C-MOS Imager reader port can cause abnormal reading. Should the reader port become dirty, wipe it clean with a soft and dry cloth.**

Warning Label

Laser Beam



- This label is a warning and caution label for Class 2 laser products that comply with IEC60825-1:1993+A1:1997+A2:2001.
- Although Class 2 laser light is only emitted momentarily, never look directly into the beam light.
- The laser light emitted by this laser scanner has a maximum output of less than 1 mW and a wavelength of 650 nm.
- Use of controls or adjustments or performance of procedures other than those specified herein may result in hazardous radiation exposure.

Warning!

■ Never look directly into the laser light.



- This product with the integrated laser scanning module scans bar codes using laser light. Never look directly into the laser light or shine the laser light into the eyes.

Adjusting the Laser Light Emission Width

The emission width of the laser light emitted by the Handheld Terminal can be adjusted. Adjust the emission width when it has been changed.

1. Tap the menus in the following sequence:

Windows CE models: Start → Settings → Control Panel

Windows Mobile models: Start → Settings → System

The Control Panel appears as shown in the screen.

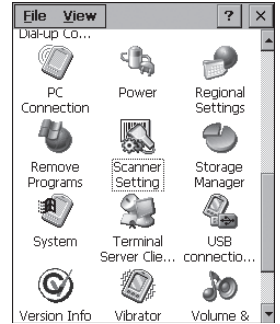

2. Double-tap the [Scanner Setting] icon (or, tap the icon for Windows Mobile models). The Setting screen appears as shown in the screen.

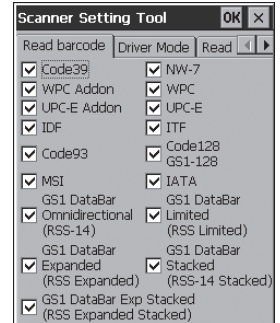

3. Tap the [Others] tab in the Scanner Setting screen.

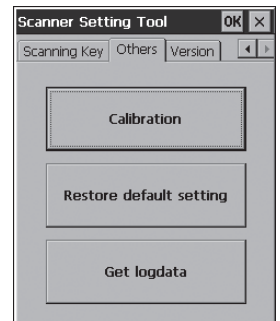

* Note that for Windows Mobile models, the screens for the adjustment steps 1 to 3 are different.

4. Tap the [Calibration] button. The display appears as shown at right.

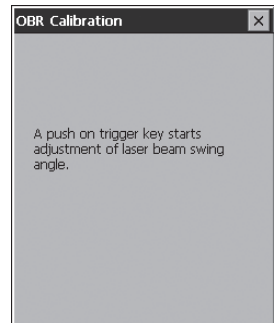

5. Press the Trigger Key to emit laser light, and align the light with the barcode for adjusting emission width.
- Align the laser light with the narrow bars on both sides.
 - The message appears as shown at right when adjustment is completed.
 - Repeat the setting if "Setting failed" message appears.

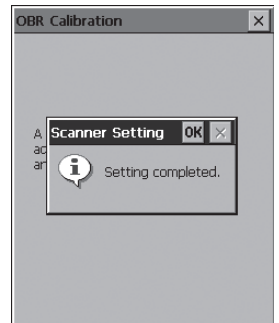

Emission Width Adjustment Bar code

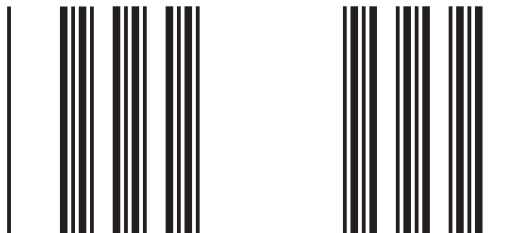

Performing Communications

IR Communication

IR communication can be used to transfer data between two Handheld Terminals. When performing IR communication, orient the IR ports of both Handheld Terminals so they are pointing directly at each other.

The ports can be in direct contact with each other, or they can be separated by up to 30cm (11¹³/₁₆") (up to 20cm (7⁷/₈") for communication between units).

Important!

- **A high-sensitivity communication element is used during IR communication.**
- **In order to ensure successful communication, avoid using cellular phones or other devices that emit radio wave in the area where you are performing IR communication.**
- **If you need to use such a device, move away from the communicating Handheld Terminals. In case of a cellular phone, keep it at least 30cm (11¹³/₁₆") away.**

Bluetooth® Communication

Bluetooth® interface can also be used to transfer data between two Handheld Terminals. With Bluetooth® the two Handheld Terminals should be located within about three meters (9'10³/₈") from each other, as long as there is nothing blocking the path between them.

Important!

Observe the following precautions to help ensure that Bluetooth communication is successful.

- **Make sure two Handheld Terminals face each other within three meters (9'10³/₈"). Surroundings (obstacles) between the Handheld Terminals may cause a shorter distance.**
- **Make sure there is at least two meters (6'7") between the Handheld Terminal and other equipment (electrical appliances, audio-visual equipment, OA equipment, and digital cordless telephones, facsimile machines, etc.). (Take special care with microwave ovens. Allow at least three meters (9'10³/₈) between the Handheld Terminals in wireless operation and a microwave oven.) When approaching such a device when its power is turned on, proper communication may prove impossible while this may also cause interference with TV and radio reception (images produced by certain UHF and broadcast satellite channels may become blurry).**
- **Normal communication may not be possible in an area near a broadcast transmitter or wireless transmitter. If this happens, move the Handheld Terminal to a different location. Normal communication may not be possible in areas exposed to strong radio waves.**

• RF Wireless LAN Interference

Because Bluetooth® and RF wireless LAN use the same frequency band (2.4GHz), radio interference can occur if there is a wireless LAN device nearby. This can result in lower communication speeds, or even make it impossible to establish a connection. If this happens, try the following countermeasures.

- **Move at least 10 meters (32'10³/₄") away from the wireless LAN device.**
- **If you cannot keep the distance at least 10 meters (32'10³/₄") or more between the Handheld Terminal and a wireless LAN device, turn off the power of either the Handheld Terminal or the wireless LAN device.**
- **Although the Handheld Terminal enables wireless LAN and Bluetooth® communication to be used simultaneously as a result of being equipped with Bluetooth® Ver.2.0, communication may not be possible depending on the surrounding radio wave environment.**

GSM Communication

To use the GSM functions, you must receive service from a wireless service provider. Available GSM functions may be dependent on the service provider to which you connect. Please consult your service provider for details about network service.

If you use GSM and WLAN at the same time, the communication speed of WLAN may be reduced, or the reception of WLAN signals may be disconnected, due to the operational state of GSM.

GPS

When you use the Handheld Terminal for the first time or after an extended period of no use, it may take a long time before the Handheld Terminal determines its positioning. In such a case, operate the GPS mode where there are no obstacles in the surroundings and wait for at least 15 minutes or longer.

The GPS module integrated in the Handheld Terminal uses signals emitted by the satellites operated by the government of the United States. The accuracy of positioning information you obtain on the Handheld Terminal may be affected by the condition of these satellites.

The GPS module integrated in the Handheld Terminal receives signal from satellites, and it may not be able to receive the signals in locations such as inside a building or in a tunnel. If you are installing the device in your car, determine the installation location after making sure that it can receive the signals.

Handling microSD Cards

The Handheld Terminal supports microSD card.

Since the microSD card slot is located inside the battery pack compartment, first remove the battery pack when installing or removing a microSD card.

Refer to pages 18 to 20 for information on “Loading and Removing the battery pack”.

Install (or replace) a microSD card according to the procedure described below.

Installing

1. Check that the power is turned off. If the power is on, always make sure to turn it off by pressing the Power Key.
2. Remove the battery pack.
3. Insert the microSD card with the top of the card (containing lettering) facing up by properly aligning with the slot.
 - Although some resistance may be felt when the card is inserted, gently insert the card all the way into the slot until it contacts the back of the slot.
 - Do not push in the card on the angle.

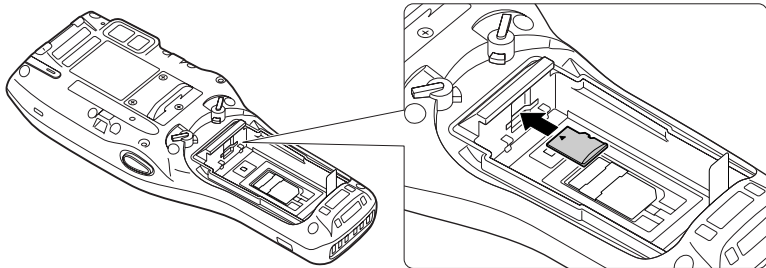

4. Load the battery pack.

Removing

1. Check that the power is turned off.
If the power is on, always make sure to turn it off by pressing the Power Key.
2. Remove the battery pack.
3. Push in the card. Slowly remove the card after it slightly pops out.

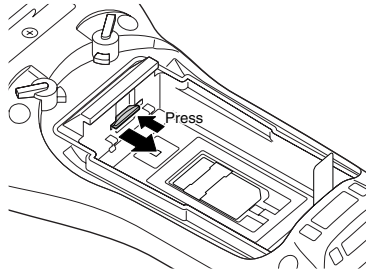

4. Load the battery pack.

Important!

- A microSD card must be inserted with the top and bottom properly aligned and in the proper direction. Attempting to insert it with an excessive force in the incorrect orientation can risk damage to the connectors and slot. Be careful when inserting a microSD card.
- The battery pack will not be able to be properly installed if the microSD card is not properly installed. Reinstall the microSD card properly if this happens.

Handling SIM Cards

The Handheld Terminal supports SIM card.

Since the SIM card slot is located inside the battery pack compartment, first remove the battery pack when installing or removing a SIM card.

Refer to pages 18 to 20 for information on “Loading and Removing the battery pack”.

Install (or replace) a SIM card according to the procedure described below.

Installing

1. Check that the power is turned off. If the power is on, always make sure to turn it off by pressing the Power Key.
2. Remove the battery pack.
3. Load the SIM card into the SIM card slot.
 - As shown in the figure, install the card by placing it in the slot with the terminals facing downwards and then sliding it up under the metal plate until it stops.
 - Do not push in the card on the angle.

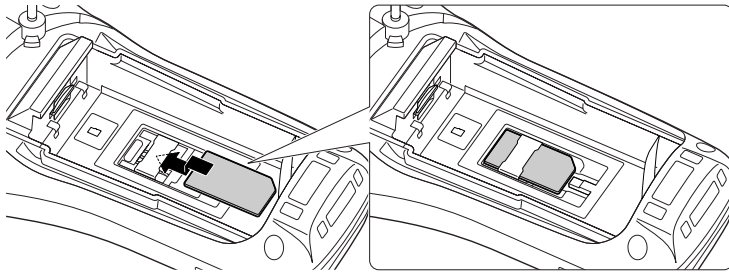

4. Load the battery pack.

Removing

1. Check that the power is turned off.

If the power is on, always make sure to turn it off by pressing the Power Key.

2. Remove the battery pack.

3. Pressing down on the stopper (1), slide the SIM card in the direction of the arrow (2) and remove.

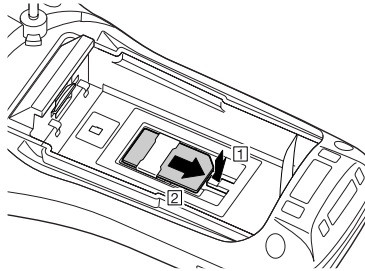

4. Load the battery pack.

Important!

- A SIM card must be inserted with the top and bottom properly aligned and in the proper direction. Attempting to insert it with an excessive force in the incorrect orientation can risk damage to the connectors and slot. Be careful when inserting a SIM card.
- The battery pack will not be able to be properly installed if the SIM card is not properly installed. Reinstall the SIM card properly if this happens.

Resetting the Handheld Terminal

Resetting the Handheld Terminal is the same as resetting a PC. Performing a reset causes all unsaved inputs and edits to be lost, but data that is already stored in the memory as well as all settings should be unaffected.

Use reset to restore normal operation whenever the Handheld Terminal operates abnormally due to misoperation or some other reason.

Use a stylus to press the reset switch on the back of the DT-X30.

This starts the reset operation.

* Do not use a toothpick or pencil or other sharp object whose tip may break off the reset switch.

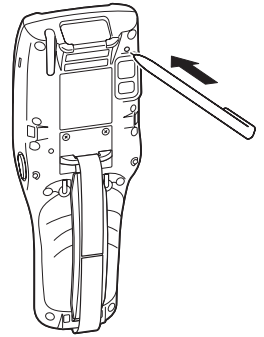

If reset does not find a memory problem

The Handheld Terminal restarts, and normal operation is restored.

If reset finds a memory problem

A message like the one shown below appears on the display when the reset operation discovers a memory problem.

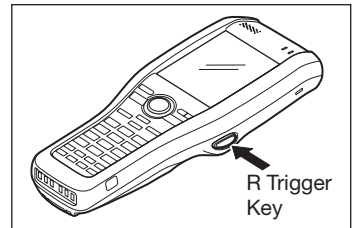
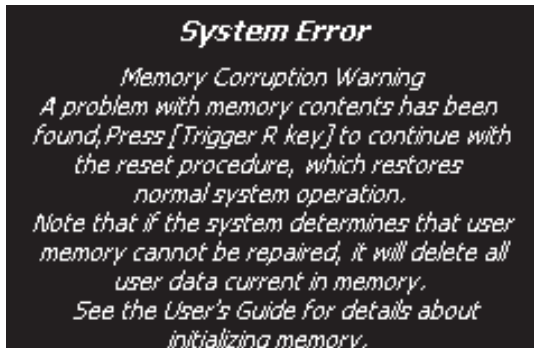

When this message appears, press the Trigger key to continue with the reset operation.

DT-X30 Specifications

Model:	DT-X30R-10/R-30/R-15/R-35 DT-X30GR-10/GR-10C/GR-30/GR-30C/GR-15/GR-15C/GR-35/ GR-35C/G-35U/G-35UC
CPU:	Marvell® PXA320 624MHz
Memory:	128MB RAM, 128MB Flash ROM (user defined: 80MB)
OS:	Microsoft® Windows® CE6.0R2 operating system, English Version (DT-X30R-10/R-30/GR-10/GR-10C/GR-30/GR-30C) Microsoft® Windows Mobile® 6.1 operating system, English Version (DT-X30R-15/R-35/GR-15/GR-15C/GR-35/GR-35C/G-35U/G-35UC)
Display:	3.5-inch, 320 × 240-dot 2-Way TFT color LCD
Laser Scanner (DT-X30R-10/R-15/GR-10/GR-10C/GR-15/GR-15C):	
Readable symbologies:	UPC-A/UPC-E/EAN8 (JAN8)/EAN13 (JAN13)/Codabar (NW-7)/ Code39/Interleaved 2 of 5 (ITF)/MSI/Industrial 2 of 5/Code93/ Code128 (EAN128 (GS1-128))/IATA/RSS-14 (GS1 DataBar Omnidirectional)/RSS Limited (GS1 DataBar Limited)/RSS Expanded (GS1 DataBar Expanded)/RSS-14 Stacked (GS1 DataBar Stacked)/RSS Expanded Stacked (GS1 DataBar Expanded Stacked)
Scanning distance:	Within approximately 40-400 mm (1 ⁹ / ₁₆ "-15 ³ / ₄ ")
C-MOS Imager (DT-X30R-30/R-35/GR-30/GR-30C/GR-35/GR-35C/G-35U/G-35UC):	
Readable symbologies:	1D: UPC-A/UPC-E/EAN8 (JAN8)/EAN13 (JAN13)/Codabar (NW-7)/Code39/Interleaved 2 of 5 (ITF)/MSI/Code93/ Code128 (EAN128 (GS1-128))/Code11/IATA/RSS-14 (GS1 DataBar Omnidirectional)/RSS Limited (GS1 DataBar Limited)/ RSS Expanded (GS1 DataBar Expanded) Stacked 2D: PDF417/Micro PDF/CODE49/Composite/Codablock F/ TLC39/RSS Expanded Stacked (GS1 DataBar Expanded Stacked)/ RSS-14 Stacked (GS1 DataBar Stacked) Matrix 2D: Aztec/DataMatrix/Maxicode/QR Code
Scanning distance:	1D: 40 – 410 mm (1 ⁹ / ₁₆ "-16 ¹ / ₈ ") Stacked 2D: 50 – 250 mm (19 ¹¹ / ₁₆ "-9 ¹³ / ₁₆ ") Matrix 2D: 60 – 150 mm (2 ³ / ₈ "-5 ⁷ / ₈ ")
IR Port:	
Interface:	IrDA Ver. 1.3 LowPower
Synchronization:	Asynchronous, frame synchronization
Transmission Rate:	Up to 4Mbps (max.)
Bluetooth®:	
Protocol:	Bluetooth® Specification Ver.2.0 + EDR
Range:	Approximately 3 m (9'10 ³ / ₈ "") (depends on radio wave conditions and environment)
Output:	4dBm max. (PowerClass2)

WLAN (DT-X30R-10/R-30/R-15/R-35/GR-10/GR-10C/GR-30/GR-30C/GR-15/GR-15C/GR-35/GR-35C):

Standards: IEEE 802.11b/g
Diffusion Modulation: DS: 802.11b
DS/OFDM: 802.11g
Frequency: 802.11b/g: 2.400-2.4835 GHz
Transmission Rate: 802.11b: Max. 11 Mbps
802.11g: Max. 54 Mbps
Communication Range: 50 m indoors, 150 m outdoors (varies according to usage environment and transmission rate)

GSM (DT-X30GR-10/GR-10C/GR-30/GR-30C/GR-15/GR-15C/GR-35/GR-35C/G-35U/G-35UC):

Standard: GSM release 99
Communication functions: Packet data
Packet: GPRS (General Packet Radio Service)
Multi-slot class 12
Mobile station class B
Coding scheme CS1-4
EDGE/EGPRS
Multi-slot class 10
Mobile station class B
Coding scheme MCS1-9
Modulation system: GMSK/8-PSK (EDGE/EGPRS)
Wireless frequencies: GSM 850:
Uplink: 824~849 MHz
Downlink: 869~894 MHz
E-GSM 900:
Uplink: 880~915 MHz
Downlink: 925~960 MHz
GSM1800:
Uplink: 1710~1785 MHz
Downlink: 1805~1880 MHz
GSM1900:
Uplink: 1850~1910 MHz
Downlink: 1930~1990 MHz
No. of channels: GSM 850: 124
E-GSM900: 174
GSM1800: 374
GSM1900: 299
Channel interval: 200 KHz
Channel bandwidth: 200 KHz
Output: GSM 850: 33 dBm
E-GSM 900: 33 dBm
GSM1800: 30 dBm
GSM1900: 30 dBm

GPS (DT-X30GR-10/GR-10C/GR-30/GR-30C/GR-15/GR-15C/GR-35/GR-35C/G-35U/G-35UC):

General specifications: 16-channel receiver, L1 1575.42 MHz, C/A code
Protocol: NMEA-0183
Sensitivity: Acquisition sensitivity: -141 dBm
Tracking sensitivity: -158 dBm

SIM card:

Standard: ISO 7816 IC Card standard
General specifications: Support for 3 V and 1.8 V SIM cards

Camera (DT-X30GR-10C/GR-30C/GR-15C/GR-35C/G-35UC):

Approx. 2,000,000 pixels
Autofocus function

Power Requirements:

Power Source: HA-G20BAT Battery Pack
Memory Backup: Rechargeable Lithium Battery (Built-in)
Consumption Current: DC 1.8A (DT-X30R-10/R-30/R-15/R-35)
DC 2.2A (DT-X30G-35U/G-35UC)
DC 2.4A (DT-X30GR-10/GR-10C/GR-30/GR-30C/GR-15/GR-15C/GR-35/
GR-35C/G-35UC)

Battery Life:

Battery pack:
Approximately 18 hours*
Approximately 10 hours**

* under the conditions that CPU speed is set to the auto power save mode, backlight is set to off, and the ratio of cyclic operation of “Standby, Key input, and Scanning” is set at 20:1:1.

** under the conditions that CPU speed is set to the auto power save mode, backlight is set to off, and the ratio of cyclic operation of “Standby, Scanning, and WLAN” is set at 6.5:1.5:2.

Memory backup: 10 minutes for protection of data in memory
3 days for backup of built-in clock

Operating Temperature: -20°C to 50°C (-4°F to 122°F)

Operating Humidity: 10% to 80% RH (non-condensation)

Dust and Water Splash Proof:

IEC60529 standard, IP64 level

Dimensions:

Refer to “Dimensional Drawing” on the next page.

Weight:

DT-X30R-10/R-30/R-15/R-35:

Approximately 550g (19.4oz) (when battery pack is installed)
DT-X30GR-10/GR-30/GR-15/GR-35/G-35U:

Approximately 590g (20.8oz) (when battery pack is installed)
DT-X30GR-10C/GR-30C/GR-15C/GR-35C/G-35UC:

Approximately 595g (21oz) (when battery pack is installed)

Dimensional Drawing

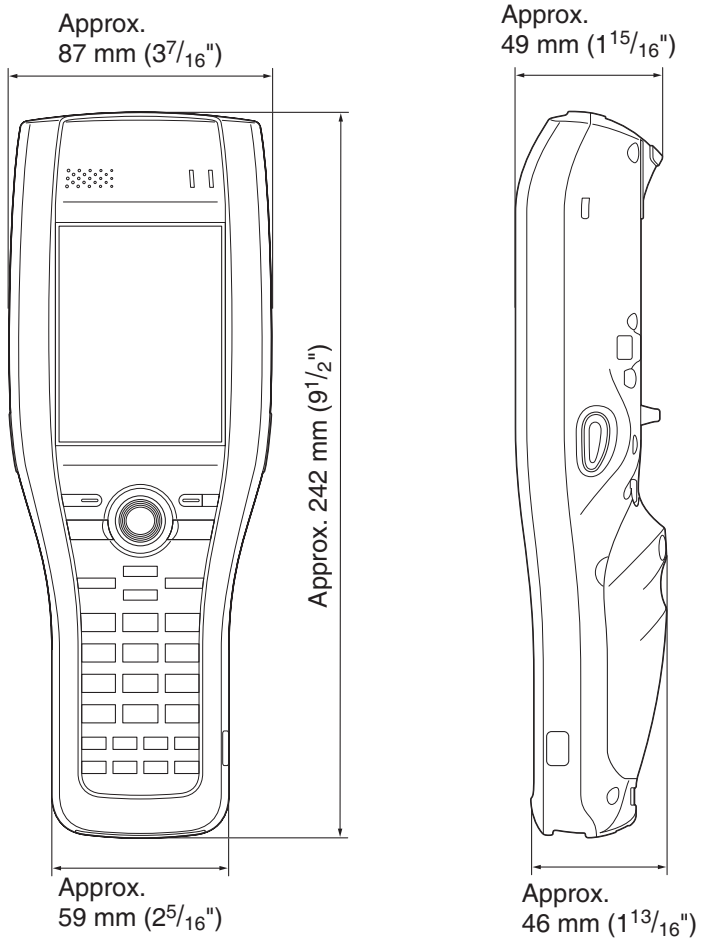

Using the USB Cradle (HA-G60IO)

The optionally available USB Cradle (HA-G60IO) makes it possible to transmit system data and file data between the Handheld Terminal and a PC via a USB connection (download or upload). You can also use the USB Cradle to charge the battery pack installed in the Handheld Terminal.

General Guide

Top

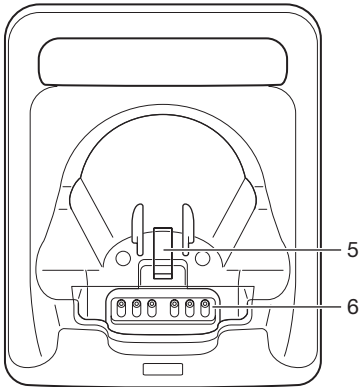

Front

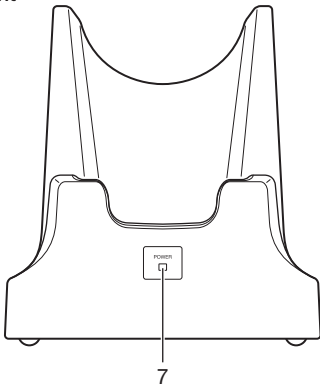

Back

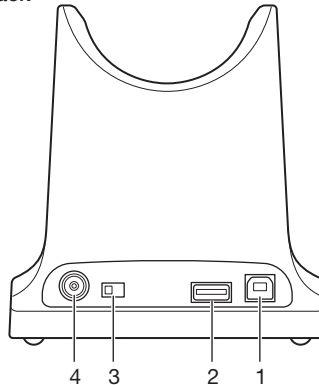

1	USB Client Port	This port is used to transmit system data and file data (download, upload) by connecting the Cradle to a PC using a USB cable (DT-380USB). A dedicated driver must be installed in the PC before connecting the Cradle to the PC.
2	USB Host Port	This port is used to connect a corresponding USB peripheral device.
3	Selector Switch	This switch is used to switch between the USB host port and USB client port. Set the switch to the “A” position when using the unit as a USB host, or set it to the “B” position when using the unit as a USB client.
4	AC Adaptor Jack	Connect the AC adaptor (sold separately) here.
5	Terminal Detect Switch	This switch detects when the DT-X30 is seated correctly on the Cradle.
6	Power Contacts	Power is supplied to the DT-X30 via these contacts. Also used for data communication.
7	Power LED	This LED indicates the power status and the mounting status of the DT-X30. Off: DT-X30 is not installed. Green: Power on, DT-X30 mounted correctly.

Important!

- Always make sure to first remove the Handheld Terminal from the USB Cradle when switching the selector switch.
- Allowing the power contacts become wet can cause an electric shock or fire. In addition, if the contacts become soiled, contact may be impaired resulting in poor charging. For reasons of safety and maintaining charging battery pack(s) in optimum condition, clean the power contacts by wiping with a dry cloth or cotton swab after disconnecting the AC adaptor.
- Never short out the power contacts of the USB Cradle. This can damage the USB Cradle.
- Do not subject the Handheld Terminal and USB Cradle to vibration or impact during communication. This can cause communication to be interrupted.
- When placing the DT-X30 into the cradle, make sure that it is seated properly and that the power LED at the front of the USB Cradle is lit in green. Charging and communication will not proceed properly if the Handheld Terminal is not seated properly.
- Always cap ports that are not being used. Using the USB Cradle while the ports are uncapped can cause damage.

Specifications

1. USB

Protocol: USB Ver1.1 Standard
Transfer Rate: 12Mbps (max.)

2. Charging

Charging Method: Constant current/voltage
Charge Period: Approximately 5 hours

3. Power Supply

Power Source: AC adaptor (AD-S42120B)
Consumption Current: 12V DC approximately 3.0A
Output to Handheld Terminal: 9.5V DC 2.7A (max.)
USB Host Output: 5V DC 0.5A (max.)

4. AC Adaptor

Model: AD-S42120B
Input: 100V to 240V AC 50/60Hz 1.2A
Output: 12V DC 3.5A

5. Dimensions and Weight

Dimensions: Approximately 120(W) × 144(D) × 129(H) mm
(4³/₄"W × 5¹¹/₁₆"D × 5¹/₁₆"H)
Weight: Approximately 300g (10.6oz)

6. Operating Environment

Temperature: 0°C to 40°C (32°F to 104°F)
Humidity: 30% to 80% RH (non-condensation)

The AD-S42120 series comes available in the following models depending on area or region where you are in.

Model no. of AC Adaptor	Area/Region	Compliance
AD-S42120BE AD-S42120B-N	All except China	Compliant with CE, UL, FCC, and Energy Efficiency Standards.
AD-S42120BE-CN	China only	Compliant with Energy Efficiency Standards and CCC.

Using the Ethernet Cradle (HA-G62IO)

The optionally available Ethernet Cradle (HA-G62IO) makes it possible to transmit system data and file data between the Handheld Terminal and a PC via a USB or LAN connection (download or upload). You can also use the Ethernet Cradle to charge the battery pack installed in the Handheld Terminal.

General Guide

Top

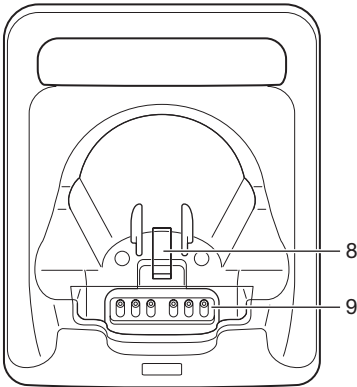

Front

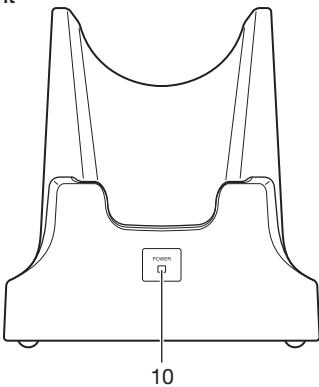

Back

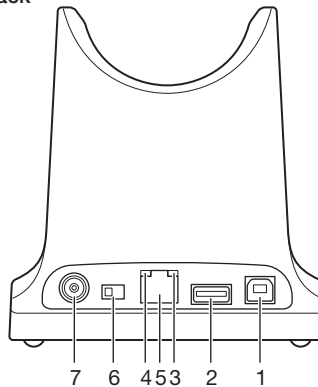

1	USB Client Port	This port is used to transmit system data and file data (download, upload) by connecting the Ethernet Cradle to a PC using a USB cable (DT-380USB). The dedicated driver must be installed in the PC before connecting the Ethernet Cradle to the PC.
2	USB Host Port	This port is used to connect a corresponding USB peripheral device.
3	LAN Connection Status LED	This LED shows the status of the LAN connection. Off: LAN cable not connected correctly. Lit orange: LAN cable connected correctly.
4	LAN Communication Status LED	This LED shows the LAN operation status. Off: No communication. Blinking: Communication in progress.
5	LAN Port	This port is used for connecting the cradle to a PC or hub via a LAN cable so that system data and file data can be transmitted (uploaded or downloaded). The special driver software must be installed in the DT-X30.
6	Selector Switch	This switch is used to switch between a USB connection and a LAN connection. LAN: LAN A: USB host B: USB client
7	AC Adaptor Jack	Connect the AC adaptor (sold separately) here.
8	Terminal Detect Switch	This switch detects when the DT-X30 is seated correctly on the Ethernet Cradle.
9	Power Contacts	Power is supplied to the DT-X30 via these contacts.
10	Power LED	This LED indicates the power status and the mounting status of the DT-X30. Off: DT-X30 is not installed. Green: Power on, DT-X30 mounted correctly.

Important!

- **Never short out the contacts of the Ethernet Cradle. This can damage the Ethernet Cradle.**
- **Allowing the power contacts become wet can cause an electric shock or fire. In addition, if the contacts become soiled, contact may be impaired resulting in poor charging. For reasons of safety and maintaining charging battery pack(s) in optimum condition, clean the power contacts by wiping with a dry cloth or cotton swab after disconnecting the AC adaptor.**

- **Do not subject the Handheld Terminal and Ethernet Cradle to vibration or impact during communication. This can cause communication to be interrupted.**
- **When placing the DT-X30 into the cradle, make sure that it is seated properly and that the power LED at the front of the Ethernet Cradle is lit in green. Charging and communication will not proceed properly if the Handheld Terminal is not seated properly.**
- **Always cap ports that are not being used. Using the Ethernet Cradle while the ports are uncapped can cause damage.**

Specifications

1. LAN Specifications

Communications protocol: IEEE 802.3
Media type: 10base-T/100base-TX auto-switched

2. USB

Protocol: USB Ver1.1 Standard
Transmission Rate: 12Mbps (max.)

3. Charging

Charging Method: Constant current/voltage (the charging circuit is built in DT-X30)

Charge Period: Approximately 5 hours

4. Power Supply

Power Source: AC adaptor (AD-S42120B*)
Consumption Current: 12V DC approximately 3.0A
Output to Handheld Terminal: 9.5V DC 2.7A (max.)
USB Host Output: 5V DC 0.5A (max.)

5. AC Adaptor

Model: AD-S42120B
Input: 100V to 240V AC 50/60Hz 1.2A
Output: 12V DC 3.5A

6. Dimensions and Weight

Dimensions: Approximately 120(W) × 144(D) × 129(H) mm
(4³/₄"W × 5¹¹/₁₆"D × 5¹/₁₆"H)

Weight: Approximately 300g (10.6oz)

7. Operating Environment

Temperature: 0°C to 40°C (32°F to 104°F)
Humidity: 30% to 80% RH (non-condensation)

*See page 44.

Using the Cradle-type Battery Charger (HA-G30CHG)

The optionally available Cradle-type Battery Charger (HA-G30CHG) lets you charge the Handheld Terminal's battery simply by placing the Handheld Terminal onto the charger.

General Guide

Top

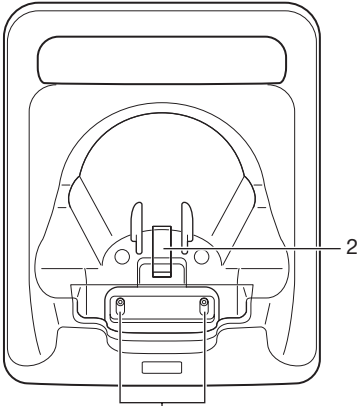

Front

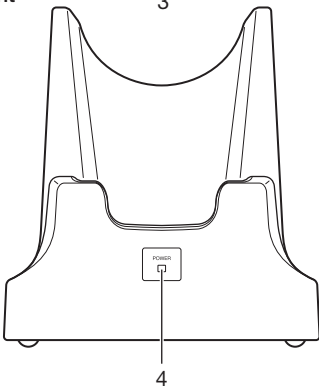

Back

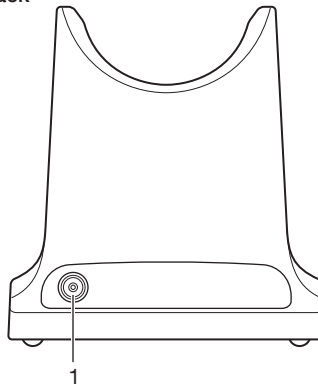

1	AC Adaptor Jack	Connect the AC adaptor (sold separately) here.
2	Terminal Detect Switch	This switch detects when the DT-X30 is mounted correctly on the charger.
3	Power Contacts	Power is supplied to the DT-X30 via these contacts.
4	Power LED	This LED indicates the power status and the mounting status of the DT-X30. Off: DT-X30 is not installed Green: Power on, DT-X30 mounted correctly

Important!

- Never short out the power contacts of the Cradle-type Battery Charger. This can damage the Cradle-type Battery Charger.
- Allowing the power contacts become wet can cause an electric shock or fire. In addition, if the contacts become soiled, contact may be impaired resulting in poor charging. For reasons of safety and maintaining charging battery pack(s) in optimum condition, clean the power contacts by wiping with a dry cloth or cotton swab after disconnecting the AC adaptor.
- When placing the DT-X30 into the cradle, make sure that it is seated properly and that the power LED at the front of the Cradle-type Battery Charger is lit in green. Charging and communication will not proceed properly if the Handheld Terminal is not seated properly.

Specifications

1. Charging Specifications

Charging Method: Constant current/voltage (the charging circuit is built in DT-X30)

Charge Period: Approximately 5 hours

2. Power Supply

Power Source: AC adaptor (AD-S42120B*)

Consumption Current: 12V DC 2.6A

Output to Handheld Terminal: 9.5V DC 2.7A (max.)

3. AC Adaptor

Model: AD-S42120B

Input: 100V to 240V AC 50/60Hz 1.2A

Output: 12V DC 3.5A

4. Dimensions and Weight

Dimensions: Approximately 120(W) × 144(D) × 129(H) mm
(4³/₄"W × 5¹¹/₁₆"D × 5¹/₁₆"H)

Weight: Approximately 300g (10.6oz)

5. Operating Environment

Temperature: 0°C to 40°C (32°F to 104°F)

Humidity: 30% to 80% RH (non-condensation)

* See page 44.

Using the Car Mounted-type Battery Charger (HA-G35CHG)

The optionally available Car Mounted-type Battery Charger (HA-G35CHG) can be used to charge the battery installed in the Handheld Terminal using power from the cigarette lighter in your car.

General Guide

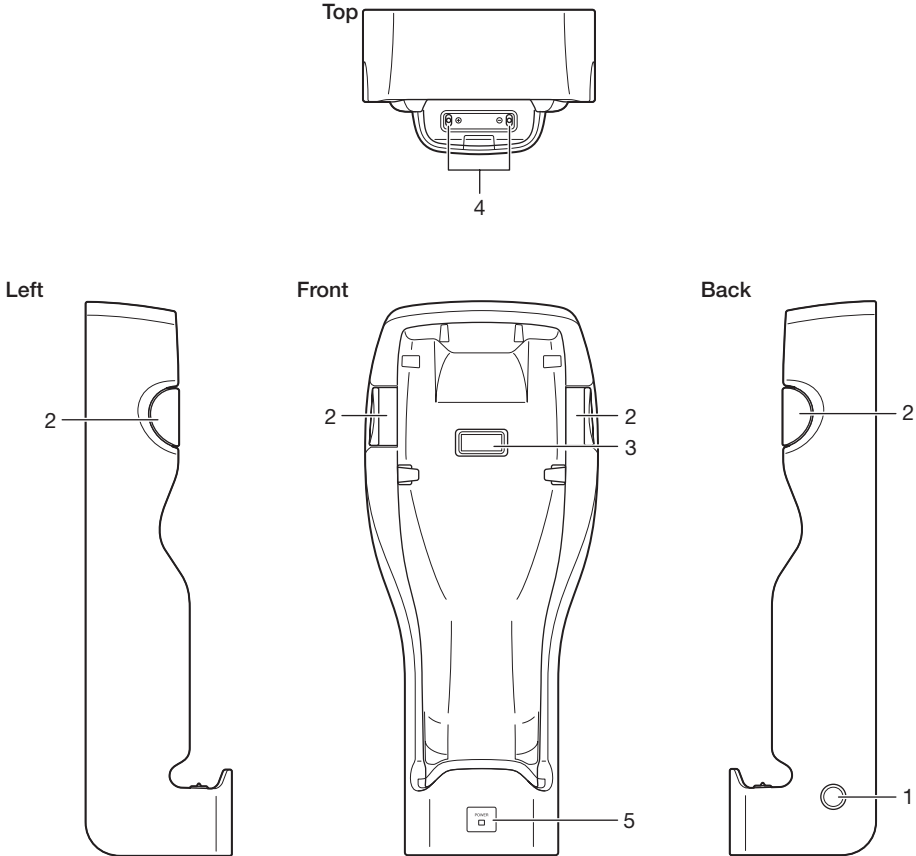

1	AC Adaptor Jack	Connect the Car Power Cable (bundled) here.
2	Removal Buttons	Press when removing the DT-X30.
3	Terminal Detect Switch	This switch detects when the DT-X30 is mounted correctly on the charger.
4	Power Contacts	Power is supplied to the DT-X30 via these contacts.
5	Power LED	This LED indicates the power status and the mounting status of the DT-X30. Off: DT-X30 is not installed Green: Power on, DT-X30 mounted correctly

Important!

- Take care to avoid allowing the power contacts to become connected to each other, which creates a short.
- Regarding the installation of HA-G35CHG in your car, no technical advice is available from CASIO. Consult with automotive parts store or specialized store regarding the installation method and mounting strength of the products installed in your car.
- Before installing the charger in vehicle, first find a particular spot in the vehicle where the Handheld Terminal can receive GPS signal in good condition while charging the battery pack using the charger.

Precaution

- The Car Power Cable cigarette lighter plug may not fit the cigarette lighter sockets of certain 12/24V DC vehicles.

Specifications

1. Charging

Charging System : Constant current/voltage (the charging circuit is built in DT-X30)
Charge time : Approximately 5 hours

2. Dimensions and Weight

Dimensions : Approximately 121(W) × 287(D) × 75(H) mm (4³/₄"W × 11⁵/₁₆"D × 2¹⁵/₁₆"H)
Weight : Approximately 620g (21.9oz) (not including brackets)

3. Operating Environment

Temperature : -20°C to 50°C (-4°F to 122°F)
Humidity : 30% to 80% RH (non-condensation)

Using the Dual Battery Charger (HA-G32DCHG)

The optionally available Dual Battery Charger (HA-G32DCHG) can be used to simultaneously charge two battery packs.

General Guide

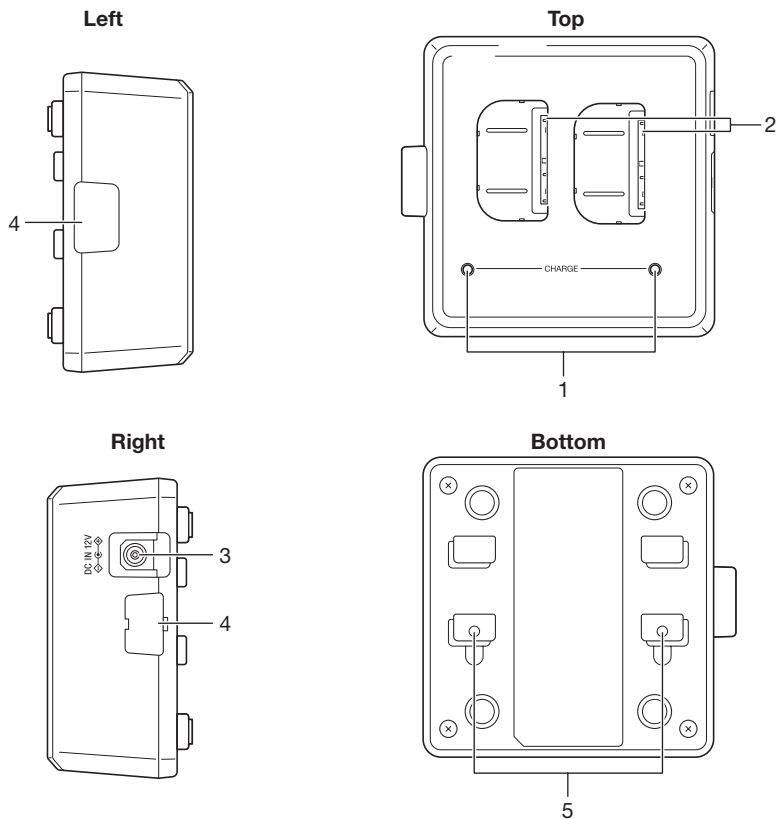

Bundled Items

Connection Bracket
2 screws

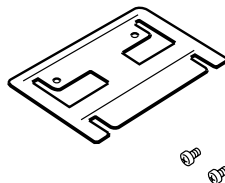

1	Charge Indicator LED	This LED indicates the charge status of the battery pack(s). Off: Not charging Red: Charging Red Flashing: Battery pack problem Green Flashing: Standby Green: Charging complete
2	Power Contacts	Power is supplied to the Handheld Terminal via these contacts.
3	AC Adaptor Jack	This is used to supply power by connecting the AC adaptor (sold separately).
4	Dual Battery Charger Connection Port	Use this port to connect multiple Dual Battery Chargers to each other.
5	Connection Bracket Attachment Holes	The connection bracket attaches here when you connect multiple Dual Battery Chargers to each other.

Important!

- **Allowing the power contacts become wet can cause an electric shock or fire. In addition, if the contacts become soiled, contact may be impaired resulting in poor charging. For reasons of safety and maintaining charging battery pack(s) in optimum condition, clean the power contacts by wiping with a dry cloth or cotton swab after disconnecting the AC adaptor.**
- **Although the battery may become warm during charging, this is normal and does not indicate a malfunction.**
- **Repeated “Mounting and Removing” of battery pack in excess of times may cause the quality deterioration of the battery pack.**
- **Each Dual Battery Charger comes with one connection bracket. Since only one connection bracket is required when you connect two Dual Battery Chargers, you will always have one left over. Simply keep the other connection bracket on hand as an extra, in case you ever need it.**

Connecting Multiple Dual Battery Chargers

You can connect up to three Dual Battery Chargers. Doing so makes it possible to supply power to all the Dual Battery Chargers using one dedicated AC adaptor.

1. As shown in the illustrations below, remove the connector covers of the Dual Battery Chargers you want to connect to each other.

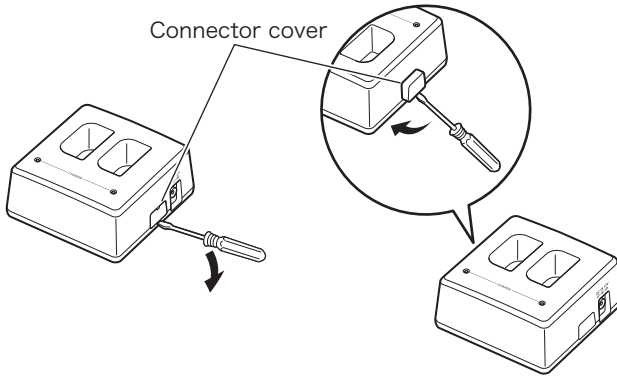

2. Connect the two Dual Battery Chargers as shown below.

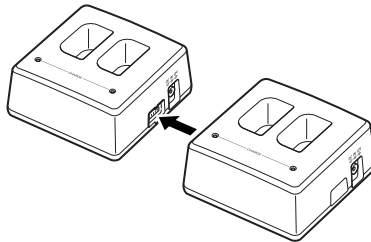

3. Turn over the connected Dual Battery Chargers and attach a connection bracket, securing it in place with screws.

You can repeat the above steps to connect up to 3 Dual Battery Chargers.

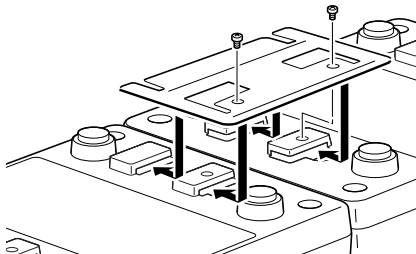

Specifications

1. Charging Specification

Charging Method:	Constant current/voltage
Charge Period:	Approx. 4 hours (1 standard battery pack, normal temperature) When charging two battery packs: Approx. 5.5 hours (2 standard battery packs, normal temperature)

2. Power Supply

Power Source:	AC adaptor (AD-S42120B*)
Consumption Current:	12V DC 3.5A
Output:	8.2V DC 1.0A (max.)

3. AC Adaptor

Model:	AD-S42120B
Input:	100V to 240V AC 50/60Hz 1.2A
Output:	12V DC 3.5A

4. Dimensions and Weight

Dimensions:	Approximately 104(W) × 100(D) × 50(H) mm (4 ¹ / ₈ "W × 3 ¹⁵ / ₁₆ "D × 1 ¹⁵ / ₁₆ "H)
Weight:	Approximately 168g (5.9oz)

5. Operating Environment

Temperature:	Approximately 0°C to 40°C (32°F to 104°F) (stand-alone) Approximately 0°C to 35°C (32°F to 95°F) (with 3 connected)
--------------	--

Humidity:	30% to 80% RH (non-condensation)
-----------	----------------------------------

*See page 44.

Using Rechargeable Battery Pack

HA-G20BAT

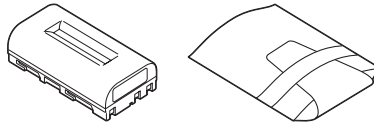

Important!

- Store a battery pack in its special soft case whenever you are not using it.
- If the battery pack has been left over unused for a long period of time, the capacity remained decreases due to spontaneous discharge or chemical decomposition by the battery pack itself. If the battery pack fails to hold its operating duration after it has been fully charged, replace it with a new one. The battery pack may reach the end of its service life.

Specifications

Model:	HA-G20BAT
Rated Capacity:	14.8WH (or 2000mAh)
Rated Voltage:	7.4V
Dimensions:	Approximately 39(W) × 72(D) × 21(H) mm (1 ⁹ / ₁₆ "W × 2 ¹³ / ₁₆ "D × 1 ³ / ₁₆ "H)
Weight:	Approximately 110g (3.9oz)
Bundled Item:	Soft case

Warning Label

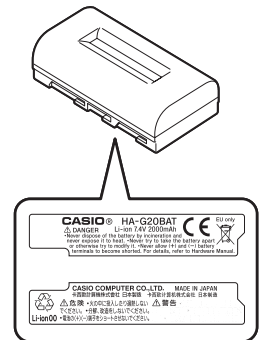

CASIO®

CASIO COMPUTER CO., LTD.

6-2, Hon-machi 1-chome
Shibuya-ku, Tokyo 151-8543, Japan

Free Manuals Download Website

<http://myh66.com>

<http://usermanuals.us>

<http://www.somanuals.com>

<http://www.4manuals.cc>

<http://www.manual-lib.com>

<http://www.404manual.com>

<http://www.luxmanual.com>

<http://aubethermostatmanual.com>

Golf course search by state

<http://golfingnear.com>

Email search by domain

<http://emailbydomain.com>

Auto manuals search

<http://auto.somanuals.com>

TV manuals search

<http://tv.somanuals.com>