

0215-69

Canon 814XL ELECTRONIC



INSTRUCTIONS

Download from Www.Somanuals.com. All Manuals Search And Download.

The 814XL Electronic is a precision Super 8 movie camera which incorporates a series of improvements to the Canon Auto Zoom 814 Electronic in reply to the requests of photographers who wish to make higher quality 8mm movies. Thus, the optical performances of the lens and viewfinder have been improved to give you better photographic effects. Mechanisms such as macro-cinematography and variable shutter opening angle enable you to make enjoyable and excellent movies.

Before Use

This camera is designed for easy operation and includes some special filming devices. Because this instruction manual contains all necessary instructions for operation of this camera and for movie filming, please read this manual thoroughly and become acquainted with the camera before starting to film in order to avoid mistakes when operating the camera's many special shooting mechanisms.

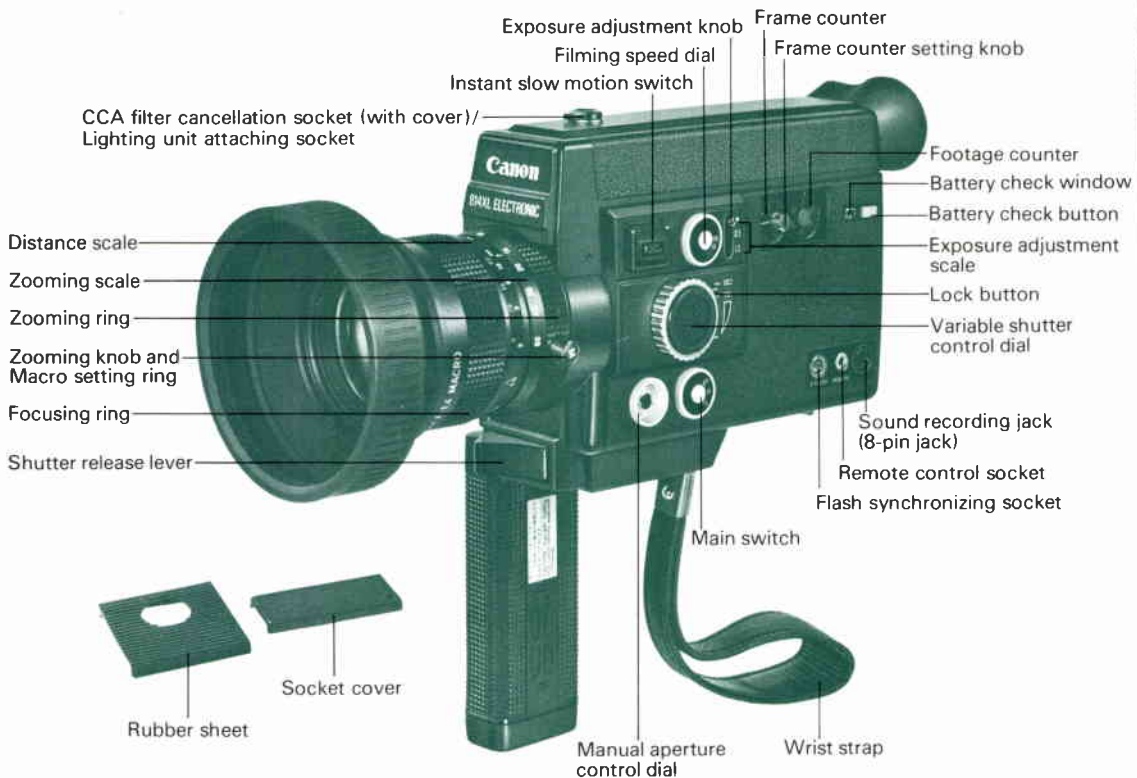

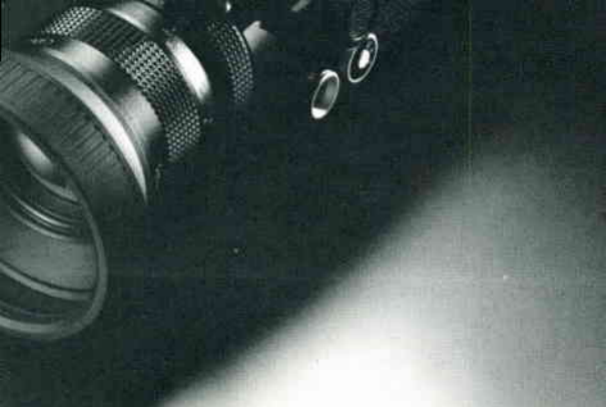

Download from [Www.Somanuals.com](http://www.Somanuals.com). All Manuals Search And Download

Outstanding Features

Variable Shutter Opening Angle Mechanism

The variable shutter opening angle mechanism sets the angle at 220° for XL filming, 150° for regular shooting and $150^\circ - 0^\circ$ for fading effects. Exposure is automatically set at either 220° or 150° to insure correct exposure. The variable shutter opening angle is a unique double-blade mechanism.

Synchronous Double Sound Recording System

Shooting with synchronous sound recording is possible because of a built-in pulse generator and by using exclusive adapter, stereo tape recorder for good quality sound.

XL Mechanism Excellent for Indoor Shooting

It is possible to film under dim light conditions, a dark room or at night because of this camera's features such as its acceptability of highly sensitive film, 220° shutter opening angle, exceptionally fast lens, highly sensitive exposure meter. The bright viewfinder and highly accurate range-finder are additional advantages for this kind of photography.

Viewfinder with Increased Brightness

An XL camera needs a viewfinder which is easy to see for easy focusing under dark conditions. In this camera, the viewfinder's brightness has been doubled by increasing the lens' effective aperture and exit pupil to allow a greater amount of light to reach the viewfinder. Aberrations are properly compensated, the angle of the split-image prism has been widened for easier viewing and the accurate metering range has been increased.

High Quality Lens for Faithful Color Reproduction

This is a new design, large aperture, zoom lens which gives top performance for both XL and general shooting. Especially, aberration in the telephoto range has been decreased and the ideal light transmission factor has been attained for high resolution, high contrast and perfect color balance throughout the zooming range. And the built-in macro-cinematography mechanism on the wide-angle end gives you a field-of-view of $33\text{mm} \times 45\text{mm}$. Changing from macro to zoom is always

possible, a technique that is perfect for scene changes.

Abundant Viewfinder Information

Aperture and over/under exposure warning marks, film transport indicator and film end warning are all indicated by lamps for easy confirmation under dim light conditions. And each lamp has been installed out of the visual field so as not to obstruct the viewfinder.

High Accuracy Servo EE

This is a TTL exposure metering system, with a servo meter to control the diaphragm. The film drive circuit (IC) has more power for increased reliability. This makes a diaphragm aperture of f/45 possible and stabilized performance even with changes of temperature or voltage.

Accessories to Widen Shooting Possibilities

You can use the self-timer and interval timer coupled to the magnetic shutter release mechanism. Single frame shooting with flash is possible by utilizing the flash synchronizing socket.

Others

- Exposure compensation system
- Instant slow motion
- Collapsible grip
- Constant voltage regulator
- Built-in collapsible hood

Specifications

Type: Super 8 SLR for silent XL filming with circuit and jack for double sound (pulse-sync) system shooting.

Picture Size: 5.8 × 4.2mm

Lens: f/1.4 zoom lens with focal length of 7.5mm – 60mm. Zooming ratio 8:1.

Lens Construction: 18 elements in 13 groups, Spectra Coating; filter thread size: 58mm; lens cap size: 60mm; built-in rubber hood.

Macro-cinematography Mechanism:

Macro-cinematography is possible using zooming ring in wide angle end of zooming range. With the distance scale at ∞, the shooting distance from the film plane indicator is 165mm. The minimum field of view is 33 × 45mm.

Focusing Adjustment: Rotating front component.

Distance Scale:

ft.	4	5	7	10	15	50	∞
m	1.2	1.5	2	3	5	10	

Zooming: Both power and manual zooming are possible. Power zooming



speed is about 5 seconds. Manual zooming is possible by rotating the zooming ring. Rotating angle is 121°30'.

Viewfinder: Single-lens reflex viewfinder with split image focusing screen.

Viewfinder Information: Aperture scale, over/under exposure warning marks, film transport indicator (green LED) and film end warning indicator (red LED).

Dioptic Adjustment: Adjustable from -4 to +2 diopters.

EE Mechanism: Automatic exposure mechanism coupled to ASA film speed and filming speed. Through-the-lens EE with CdS photocell, coupled to single frame shooting.

Light Metering Range: From ASA 400, f/1.4,  (220°), 9 fps. to ASA 25, f/4.5  (150°), instant slow motion of approx. 36 fps.

Film Speed:

Artificial light: ASA 25 – 400

Daylight: ASA 16 – 250

Film ASA Setting: Automatically set when cartridge is loaded.

Color Temperature Adjustment Filter:

Manually removed or automatically cancelled when daylight-type film is inserted, or when CCA filter cancellation adapter or lighting unit is used.

Exposure Compensation: Two possible compensations of +0.5 and +1.5 f/stops (These numbers are actual f/stops and not multiple exposure factors.)

Manual Exposure Control: Full manual exposure control is possible by using the manual aperture control dial.

Filming Speeds: Dial positions for 9, 18 fps., and single frame. Separate switch for instant SLOW MOTION (approx. 36 fps.)

Angle of Shutter Opening: 220° (effective angle) for XL filming and 150° for regular filming and these two angles are provided with a safety lock and click stop.

Shutter Angle Compensation: Automatic exposure adjustment at 220° () and 150° ().

Variable Shutter Control: 150° to 0° continuously by turning the spring-tensioned fading control downward. The dial will return automatically to the  position if it is released.

Shutter Release Mechanism: Built-in electromagnetic release system.

Drive System: High-performance electric micromotor.

Power Source: Four 1.5V penlight (size AA) batteries in the grip are used to power the film drive, power zooming and exposure metering.

Battery Check: A red LED lamp lights up when the battery check button is pressed if the batteries are in good condition.

Battery Life: More than 10 cartridges for 18 fps. shooting or more than one cartridge for single frame shooting.

Remote Control: By use of Remote Switch 60 or 3.

Main Switch: Dial positions for OFF, R (Running) and RL (Running Lock) on the main switch.

Footage Counter: Counts exposed footage from 0 to 50ft. and automatically resets itself when cartridge is removed. There is also a separate frame counter for 72 frames.

Film End Warning: A red LED lamp lights in the viewfinder about 2 ft. before the end of the film.

Recording System: Double sound (pulse-sync) system. 8 pronged jack for special use. Sound Recording is accomplished by a stereo tape recorder using a special cord or the designated cord. The DIN method of synchronous recording is possible with one pulse every 4 frames by using the cord 'BRP', the adapter 'Synvoton 1-4' and the cord 'SV 2209' made by Velmut Volland, and the Philips' '2209AV' tape recorder. Simultaneous starting and stopping of the tape

recorder and camera are possible.

Flash Synchronization: Possible at both 220° and 150° shutter angles. Synchronized with single frame shooting.

Grip: Collapsible, doubles as battery compartment.

Attaching Lighting Unit: Use screw type socket on the upper surface of the camera body. CCA filter is automatically cancelled when lighting unit is attached.

Dimensions and Weight: 265 × 118 × 92.5mm; (10-7/16" × 4-5/8" × 3-5/8"), 1520g (3 lbs. 6 ozs.) (including batteries).

Accessories: Included; Soft Case, Remote Switch 60, Lens Cap 60, Finder Cover, CCA Filter Cancellation Adapter, Rubber Sheet, Socket Cover, Optional; 58mm Filters, Close-up Lenses 450C-8-2 and 240C-8, Self-Timer E, Interval Timer E, Time Lapse Programmer, and Remote Switch 3.

Subject to change without notice.

Preparations Before Filming

1 Unfold the grip.

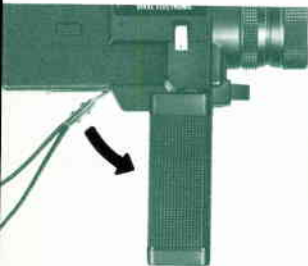

2 Insert batteries.

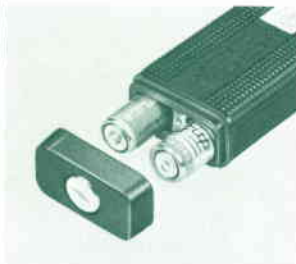

3 Check battery power level.

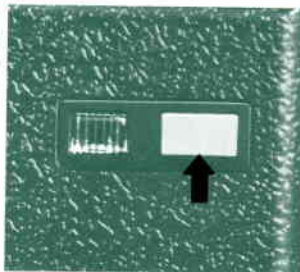

4 Adjust eyepiece.

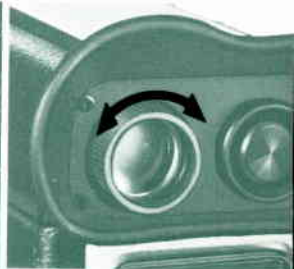

9 Set the filming speed at 18.

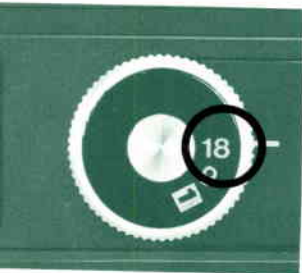

10 Set the exposure adjustment knob to the white dot.

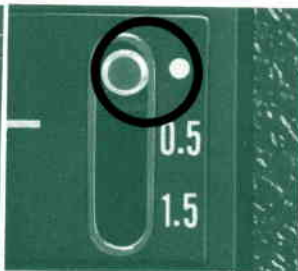

11 Push in the manual aperture control dial.

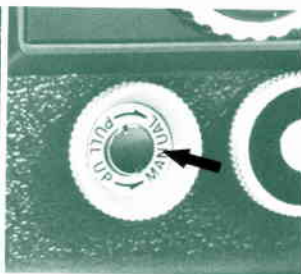

Actual Filming
12 Take the camera and look into the viewfinder.



5 Insert film.



6 Set the main switch to "R".



7 Confirm film advance.

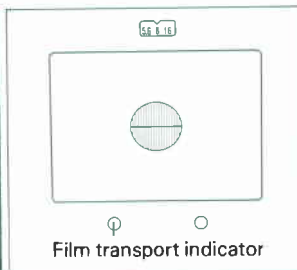

8 Set the variable shutter control dial to:
☉ for outdoors
☒ for indoors

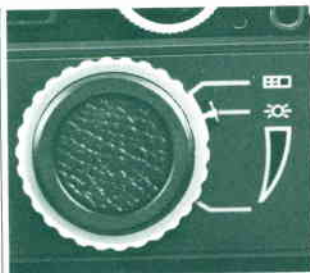

13 Adjust the focus in the telephoto range.



14 Decide composition. (Zoom as desired)

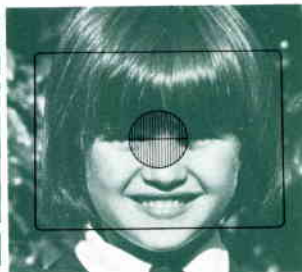

15 Confirm the exposure at the first step of the shutter release lever and shoot at the second step of the shutter release lever.

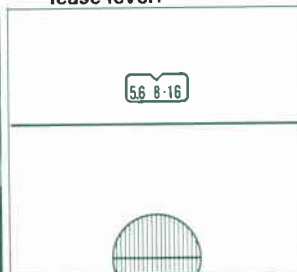

16 Remove the film after shooting.



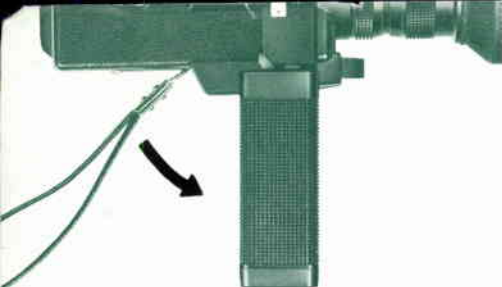

Hand Grip and Strap

The hand grip is collapsible and doubles as the battery compartment. When it is unfolded all the way, the hand grip will lock in place. It can be folded again by pushing the grip locking lever upward. When holding the camera, please make sure to put your hand through the strap for safety.



Lens Hood

The hood is collapsible. Please extend it before shooting.



Battery Loading

Both the drive system and the exposure metering of this camera are powered by the same batteries. Please make sure that the batteries are loaded before filming. Four penlight (size AA) batteries are used and are loaded into the grip.

1. Remove the battery compartment cover by unscrewing it as shown by the arrow.
 2. Follow the diagram on the side of the grip when loading the batteries.
 3. Replace the cover and tighten the screw.
- When changing batteries, be sure to load new batteries of the same brand and same kind at the same time. Please be careful when loading them because if they are loaded the wrong way, the reversed polarities may damage the camera. When filming in cold places, battery life will be shortened so please take extra batteries with you. The batteries must be kept warm before shooting in such places. When you shoot in temperatures below 0°C, Ni-Cd batteries are highly recommended. When not using the camera for a long period of time, take the batteries out to avoid damage to the camera from leaky batteries. When not filming please make sure to switch off the camera to prevent battery waste.

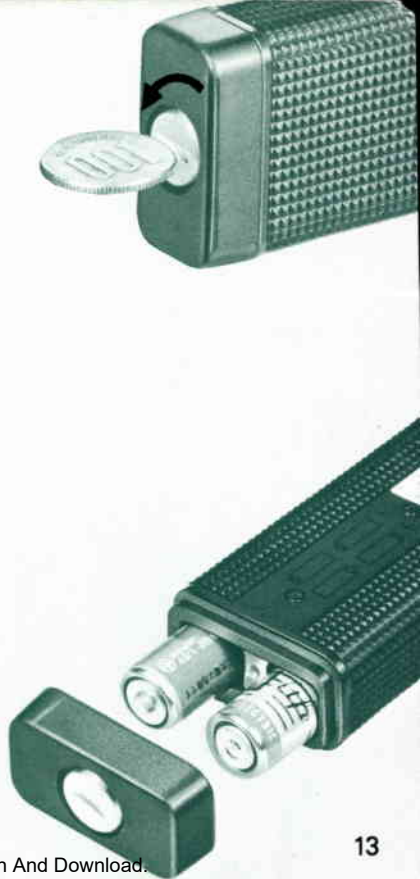

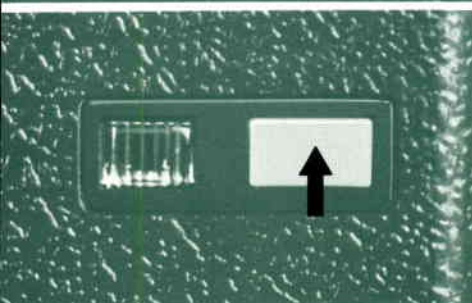

Battery Check

Check the battery's power before filming. Rotate the Main Switch at the side of the camera body to the 'R' setting and press the battery check button. If the lamp lights, battery power is sufficient and shooting is possible at any frame speed. If the lamp starts blinking, correct filming is possible only at 18 and 9 fps. If the lamp fails to light, the batteries must be changed. Please check the batteries if you have just changed batteries, you have filmed about 10 cartridges, you have not used the camera for a long time, and if you are filming in cold places.

Dioptric Adjustment

Dioptric adjustment is indispensable because blur will result if the eyepiece is not adjusted to the user's eyesight. The adjustable range is from -4 to $+2$ diopters.

1. Remove the cover and set the distance scale at ∞ .
2. Point the camera toward a window and look through the eyepiece.
3. Rotate the dioptric adjustment ring.
4. Stop rotating the dioptric adjustment ring when the line located in the center of the split-image screen can be clearly seen.

Film Loading

Please use ASA 40 film for outdoor daylight shooting and ASA 160 film for indoor shooting at night.

1. The rear cover will open if you press the rear cover opening button.
2. Insert the film cartridge so that the film label can be seen through the window.
3. Push the rear cover until it snaps shut.
4. When loading the film, the film speed will be automatically set.

Film Speed

Artificial Light: ASA 25 40 64 100 160 250 400

Daylight: ASA 16 25 40 64 100 160 250

Footage Counter

The footage counter indicates exposed footage and will automatically return to '0' when the cartridge is removed. It will not move unless a cartridge is inserted.

Frame Counter

The frame counter can count up to 72 frames (1 ft.) in one full turn and counts two frames per unit. To confirm exposed frames set the needle at '0' by rotating the frame counter setting knob. The counter can also be used for fading and single-frame shooting.

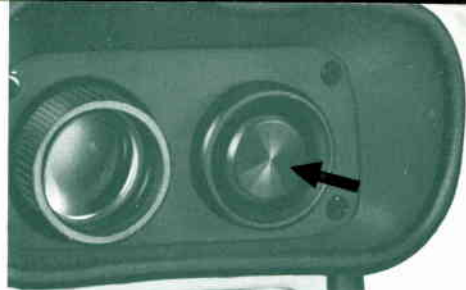



Main Switch

By rotating the Main Switch to the 'R' setting, all circuits will be turned on and the camera will be ready. When not using the camera, turn the Main Switch off to avoid battery waste. The 'RL' setting on the switch stands for running lock. This is used for continuous and remote-control shooting.

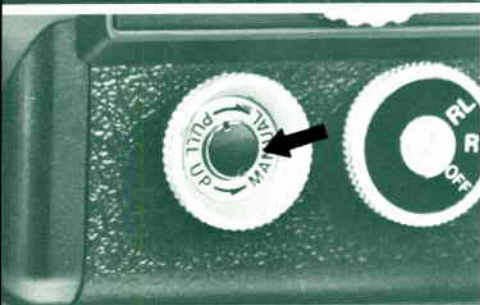

Manual Aperture Control Dial

Please leave this dial pushed in. If pulled out, the camera will be switched to manual exposure control.



Setting the Filming Speed

Normally, the camera is set at 18 fps. as this is the standard speed for Super 8 movies. Changing the speed to 9 fps., is used to speed up the subject's motion. This speed is also used to compensate for under-exposure of a still subject in dim light. Single frame shooting is used for purposes like animation photography which is single frame shooting that gives a feeling of motion.

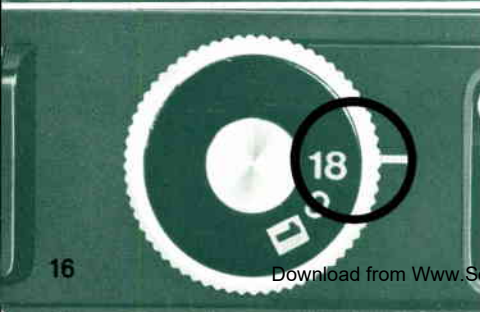

* Concerning slow motion shooting, please refer to page 42.



Variable Shutter Control Dial Settings

The dial is set on the  setting for normal daylight or rather bright indoor conditions, and is set on the indoor  setting for dim light conditions. To select a setting, rotate the variable shutter control dial while pressing the lock button in.

* When the variable shutter control dial rotates clockwise while pressing the lock button, the shutter blades will gradually close. They will be fully closed when the dial reaches its rotational limit. If you take your fingers away from the dial, it will be automatically returned to the  setting by a spring. (Refer to page 32.)

* The  setting has a shutter opening angle of 150° for regular shooting. The opening angle of 220° () is for XL shooting in dim light conditions.

* Be sure to set the  setting for filming a TV screen.

Exposure Adjustment Knob

This is an adjustment knob used for direct-light shooting. Set it on the white dot for regular shooting to obtain the correct exposure.

* The 0.5 and 1.5 settings are used for exposure compensation. (Refer to page 23.)

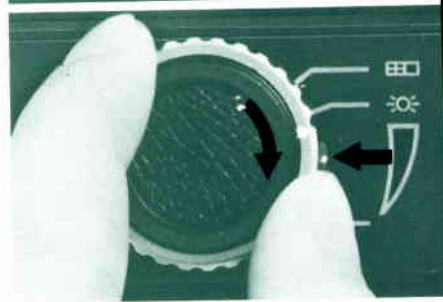
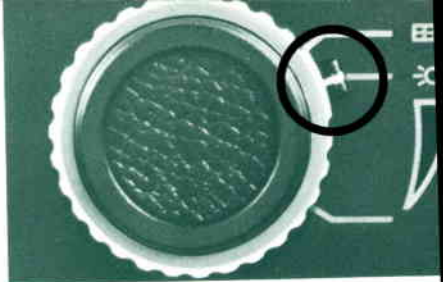

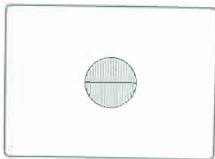

Film transport indicator



Film Transport Check

To check the film transport, slowly press the shutter release lever while looking through the viewfinder. The shutter release lever has two steps and only the second step will release the shutter. If the film transport indicator (green LED) located in the lower left of the viewfinder lights, then the film is being correctly transported. This check can be performed very easily. If the film is not being correctly transported, remove the cartridge and, using your finger, slightly wind the film clockwise by rotating the spool to take up slack. Then reload the cartridge.

How to Hold the Camera

Hold the grip in your right hand placing your index finger on the shutter release lever. For additional safety, put your right hand through the wrist strap before taking hold of the grip. Your right elbow should be tight against your body to avoid blur caused by camera movement. Your left hand is used to operate the focusing and zooming, and should be kept on the camera while shooting. Stand with your feet slightly apart and keep your upper body firm. When you wish to pan sideways, turn your upper body along with the camera. It is very important to

hold the camera steady to obtain a clear picture image. Please pay special attention to this when zooming or shooting in the telephoto range. On this occasion, it is best to use a large tripod for the camera and the Remote Switch 60. When using a tripod and not looking directly into the viewfinder for shooting, make sure to attach the finder cover to stop light from entering through the eyepiece. Especially when shooting with the light behind you, too much light can enter and cause improper exposure. So please be careful. The same thing can happen with single frames or title shooting.

Viewfinder Information

Since this camera's viewfinder is a single lens reflex type, what you see in the viewfinder is exactly what is being filmed. In the center of the viewfinder is a split-image focusing screen and at the top of the viewfinder the aperture scale and over/under exposure warning marks are located. The film end warning mark (red LED) is in the lower right and the film transport indicator (green LED) is in the left hand side. Information, all located outside the viewfinder screen, only lights during shooting.



Underexposure warning mark  Exposure indication window

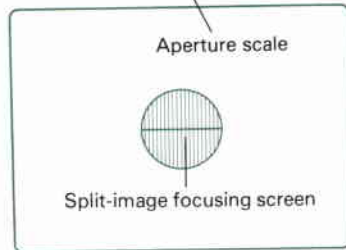

 Film transport indicator

 Film end warning indicator

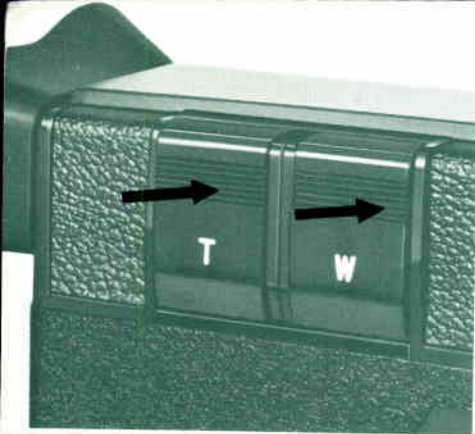

Zooming

The image in the viewfinder continuously changes as the zooming ring is rotated although the focus will remain the same. This is called "zooming", and is used to change the focal length. It can be also used for special shooting effects. Both power and manual zooming are possible with this camera.

Power Zooming

When the power zooming switch is pressed zooming will automatically start. When 'T' is pressed, the focal length changes to telephoto making the image larger. Pressing 'W' will change to shorter focal length giving a wide angle view. The former operation is known as zoom-up and the latter as zoom-back. Zooming time is about 5 seconds. Power zooming makes the zooming operation quite smooth. Power zooming cannot be operated past the limits of either range.

Manual Zooming

Manual zooming is performed by rotating the manual zooming ring. This can be used to adjust the focal length or change the picture image and framing, as well as to vary the zoom-

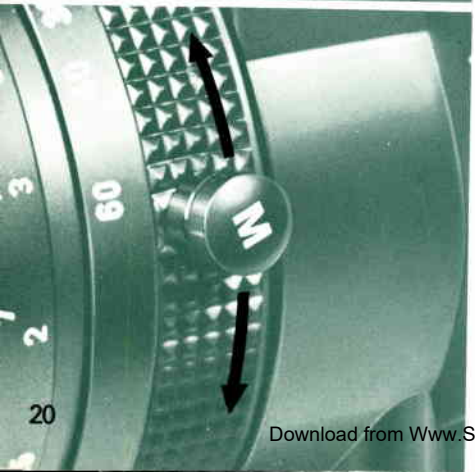

ing time. With practice you will become used to manual zooming.

* If you pull up the zooming ring and rotate past the wide-angle limit (7.5mm), you will get macro-cinematography range, which is different from zooming. (Concerning zooming, refer to page 45)

Focusing

Look through the viewfinder and rotate the focusing ring. When the images of the split-image screen match, the subject is in focus. The focus is now adjusted for any focal length. It is important to focus at the telephoto range (60mm) to insure a sharply focused image. You can then zoom as much as you wish.

Framing

Since the viewfinder is a single lens reflex type with no parallax, you can frame using the whole of the viewfinder. You can change the subject's size either by moving closer to or away from the subject or by zooming.

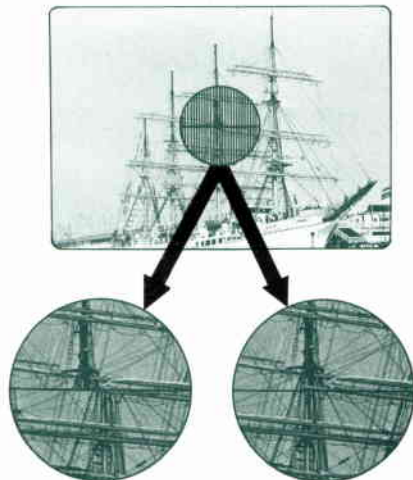
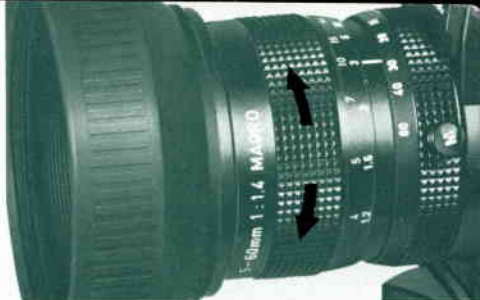

out of focus

in focus

Aperture scale

5.6 8 16

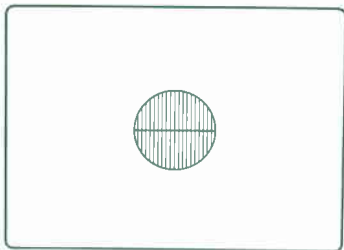

Film transport
indicator

Film end warning
indicator

Checking the Exposure Indicator

When pressing the shutter release lever one step, the light meter circuit is turned on and the exposure indication window in the viewfinder will light. If there is no red mark in the indication window you have the correct exposure. In that case, press the shutter release lever one step further. The number in the window shows which aperture is set. Read this number by looking at the index in the exposure indication window.

* In dim light, obtaining the correct exposure may take a little more time.

Shooting

After confirming the exposure, release the shutter. Avoid pulling it in one quick jerk or the beginning of the film may be incorrectly exposed.

* Please release the shutter smoothly.

Over/Under Exposure Warning

If the red mark is indicated in the exposure indication window the exposure must be corrected. If f/45 is indicated next to the red mark, you have overexposure. When this happens, set the shutter opening angle at the ∞ setting. If the red indication still does not go out, attach an ND filter to the lens.

* We recommend the Canon Filter ND 4 or ND 8

because they optically match Canon lenses.

Please do not use two filters together.

When f/1.4 shows up in red, conditions are too dim for shooting. Set the shutter control dial at the  setting and if that is not enough, use additional light.

* If the wrong kind of film is being used, incorrect exposure will be the result. Using high speed film for daylight shooting, for instance, may cause overexposure. Please make sure that you select the right kind of film.

Exposure Adjustment

When using EE to film a person at a window or with a blue sky or snow in the background, the main subject becomes underexposed. To avoid this, please use the exposure adjustment knob to adjust exposure. The adjustment of exposure has two settings of 0.5 and 1.5 f/stop. A person at a window will need 0.5 f/stop and a person with a blue sky or snow in the background will need 1.5 f/stop. However, the necessary adjustment differs depending on the intensity of light. It is advisable to control the aperture manually when you need the exact exposure or when shooting against a specially strong light. In this case, please meter the exposure of the subject and the



Underexposure warning mark

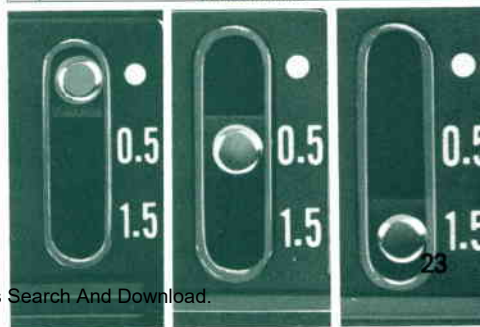

Overexposure warning mark

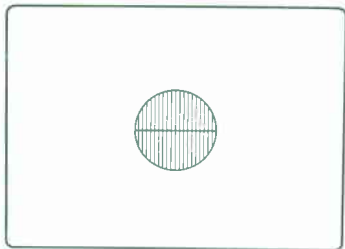



 Film transport indicator
  Film end warning indicator

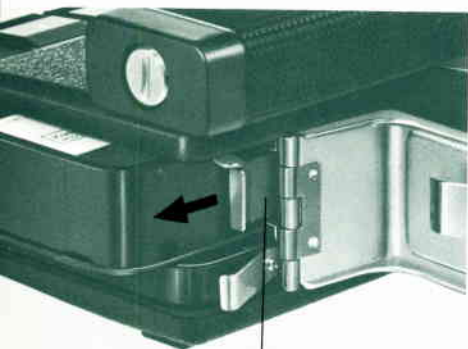

 Cartridge removal lever

subject position beforehand. Then set the exposure.

Film Transport and Film End Warning

When the film is being transported, the film transport indicator in the viewfinder will be blink. Two feet before film ends the warning lamp will light. When the film has reached the end, the film transport indicator will go out. Check the footage counter and if it indicates 50, remove the film cartridge.

Removal of Film Cartridge

Open the rear cover by pushing the opening button, pull out the cartridge removal lever located at the bottom of the film compartment and withdraw the film cartridge. You can tell that the film has been exposed by the cut on the perforations and by the word 'EXPOSED'.

Send your film to be developed as soon as possible.

Changing a Half-used Cartridge

Since Super 8 film comes in a cartridge, you can change to different types of film before one cartridge is totally finished. Footage wasted by changing cartridges is only about 6 frames including that part exposed to the light and a few frames before and after.

- * Before changing half-used film, please advance it slightly so that light will not fog any exposed portion.

- * Upon changing film cartridges, the footage counter will automatically return to '0'. Thus, it is best to write down the amount of exposed footage on the removed cartridge.

- * Since the film end warning indicator is coupled to the footage counter, if you insert a half-used cartridge, the lamp will not light. You can tell that the film has ended by looking at either the footage counter or the film transport indicator.



CCA Filter

A Super 8 type 8mm movie camera is usually designed for daylight shooting outdoors, using tungsten type film. Therefore, a CCA filter is built into the optical path of the lens to provide color temperature adjustment. When shooting indoors with artificial light, the CCA filter has to be removed from the optical path for the correct color temperature to be obtained. When G-type film, for both daylight and artificial light, and when daylight film are loaded in this camera, the filter is automatically cancelled because it is not necessary.

Chart for Switching the CCA Filter

Film Type	Filter	Daylight Shooting	Indoor Shooting
Type-A (For Artificial light)	In the optical path	In the optical path	Cancelled from the outside
Type-G or Daylight-type	Automatically cancelled	←	←

* Please follow the instructions given by the film manufacturer for more details.

Canceling the Filter from the Outside

Remove the CCA filter cancellation adapter that is placed in the bottom part of the camera, and attach it to the CCA filter cancellation socket on the upper part of the camera. Then, the CCA filter is removed from the optical path.

* When a lighting unit with tripod screw hole is attached to the CCA filter cancellation socket, the filter is cancelled.

* When a lighting unit is attached to the CCA filter cancellation socket, please use the rubber sheet to avoid any slipping.

* Since lighting units can become very hot, do not shoot closer than 1m distance from the subject. Please be careful to avoid burns.

* The CCA filter cancellation socket can not be used to attach a tripod for shooting titles.

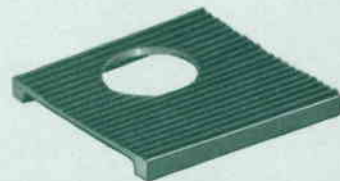

Rubber sheet

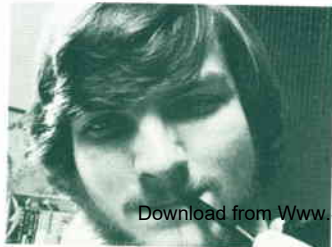

Macro-cinematography Shooting

Since this camera is capable of macro-cinematography shooting which is close-up shooting at extremely short distances, and at the wide-angle end of zooming, it can be very easily operated to shoot close-ups of small plants or insects. This can also be used for shooting titles.

1. The zooming knob stops at the focal length of 7.5mm. If you rotate while pulling the knob, it will be set for macro-cinematography shooting.

The Closest Distance and the field-of-view of macro-cinematography

Distance scale (m)	Distance between film plane indicator and subject (cm)	Field-of-View (cm)
∞	16.5	3.3 × 4.5
1.2	16.8	3.5 × 4.8

2. Focusing in this macro range can be done by rotating the zooming knob.

Focusing is checked through the viewfinder just as in regular shooting.

* When it is difficult to adjust focusing by means of the distance scale within the viewfinder, please use other adjustment available.

* In macro-cinematography shooting, it is better

to use a copy stand or tripod and the remote switch because, otherwise, blur can easily occur. When you shoot without looking through the viewfinder, please make sure to cover the finder cover.

* In macro-cinematography shooting, since the depth of field becomes extremely shallow, please be careful to adjust focusing correctly. The light should be strong so that an aperture smaller than $f/5.6$ can be set.

3. To reset from wide angle macro-cinematography, just turn the zooming knob.

Focusing in Macro-cinematography

The focus is adjusted by rotating the macro setting ring for macro-cinematography shooting in order to be able to shoot from the closest distance up to the regular shooting distance (the distance set on the distance scale of the lens), without interruption. For example, if you set the distance scale at 3m to rotate the zooming knob, the focusing position changes from the closest distance to 3m. If you zoom further, the macro-cinematography mechanism will be turned off, and the subject will be zoomed with focusing at 3m. This effect can be used for interesting scene changes which are different from simple

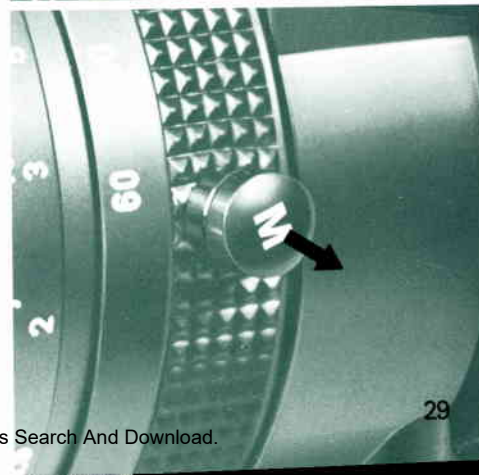
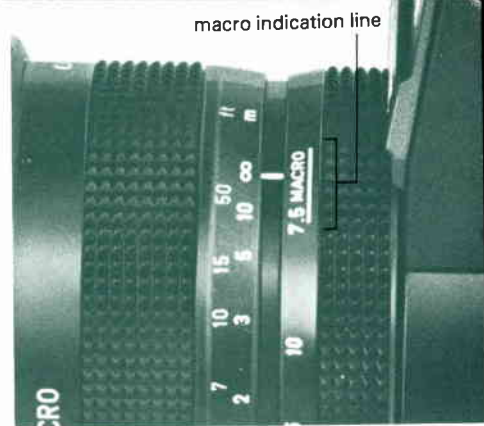



zooming.

* Power zooming can be used for zooming while focusing in the macro-cinematography range.

Depth of field when the subject is at 16.5 cm from the Film Plane Indicator

Diaphragm Aperture	Depth of Field (cm)	Diaphragm Aperture	Depth of Field (cm)
1.4	16.4 – 16.7	11	15.8 – 17.5
2	16.3 – 16.7	16	15.5 – 18.0
2.8	16.3 – 16.8	22	15.2 – 18.7
4	16.2 – 16.9	32	14.8 – 20.3
5.6	16.1 – 17.0	45	14.3 – 23.5
8	16.0 – 17.2		

* Please do not use a strobe or movie lighting unit for macro-cinematography.

Manual Aperture Control Shooting

When the manual aperture control dial is pulled out, the EE mechanism is cancelled and the exposure is manually set by rotating this dial. For manual aperture control shooting, too, exposure is checked through the viewfinder when you pull the shutter release lever one step. Manual aperture control is used when you want a certain exposure setting such as for single frame shooting or panning, or when you stress an exaggerated effect such as back lighting, high-key or low-key effects. When the manual aperture dial is pressed in, it is set for EE shooting.

- * When the manual aperture dial is rotated clockwise, the aperture becomes wider, and smaller when turned counterclockwise.
- * When the red exposure warning mark is indicated, the aperture does not change even if the dial is rotated further in the same direction. Doing so will not damage the mechanism.
- * When you change the filming speed from 18fps. to slow motion while manually controlling the aperture, stop shooting once and start shooting after opening the aperture one f/stop more.

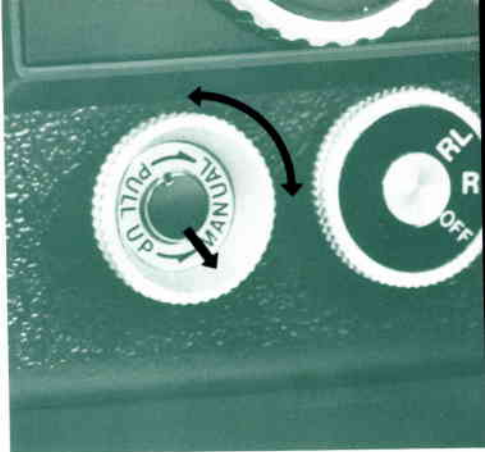

* In regular shooting with manual aperture control, the best effect is attained between $f/2$ and $f/11$.

* For shooting titles, please make the light stronger so that the aperture can be set at $f/5.6$ or smaller.

Variable Shutter Control Mechanism

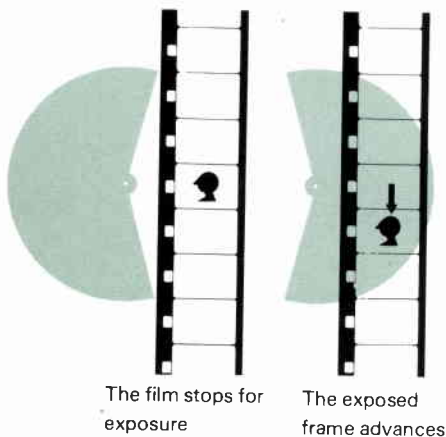

Exposure with this 8mm camera is controlled by the angle rotation of semi-circular shutter blades. One rotation gives the exposure for one frame. As the shutter rotates it alternately passes and blocks light from passing through the aperture and exposing the film. When the shutter blades cover the aperture, the film is advanced to the next frame and when the blades uncover the aperture, the film is stationary and is exposed. Therefore the exposure is changed depending upon the rotation speed and the opening of the shutter blades. The rotation speed is also called the filming speed and the opening of the shutter blades is called the shutter opening angle. This camera has a mechanism that controls the shutter opening angle, changing the opening angle to control exposure and fading when shooting.



The film stops for exposure

The exposed frame advances

Variable Shutter Control and Exposure Adjustment

The variable shutter control mechanism of this camera has a 2-setting exposure adjustment mechanism and fading mechanism. At the  setting, the opening angle is 220° , the shutter speed is about $1/30$ second at 18 fps. At the  setting, the shutter opening angle is 150° and the shutter speed is about $1/43$ second. Therefore, the  setting is more convenient for use under dim light conditions.

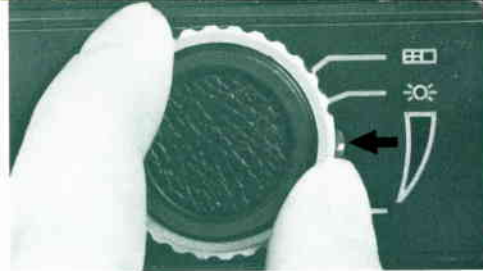

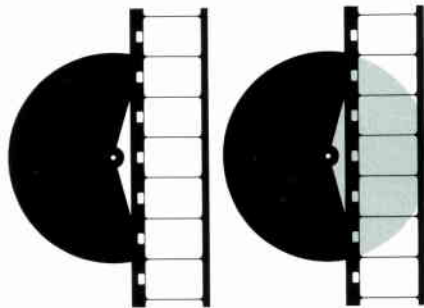

System of Shutter Opening Angle/Fading

Making the picture image gradually darken until it blacks out completely, or on the contrary, making it become brighter from a complete black-out condition until it can be seen normally, is the technique called fading which is often used in making movies. The former is called fade-out and the latter fade-in. With this camera, the shutter opening mechanism functions to perform fading. The shutter opening angle is variable from 150° to 0° (completely closed). The operation is performed by rotating the variable shutter control dial. Fading controlled by the variable shutter control dial is different from aperture-controlled fading. It can be operated without filters and fading time can be decided without any problem.





Fade-out



1. Start shooting after setting the variable shutter control dial while pressing the lock button at the  setting.
 2. Rotate the variable shutter control dial clockwise while pressing the lock button until it stops.
 3. Stop shooting. When you remove the finger, the variable shutter control dial will automatically return to the  setting. Thus, the picture image will give the fade-out effect, gradually becoming darker.
- * Please do not linger in the closed position in order to avoid film waste.

Fade-in

1. Start shooting after setting the variable shutter control dial while pressing the lock button in the closed position.

2. Return the variable shutter control dial to the  setting controlling the time with your finger.

3. When it is completely open, shoot as much as you wish. Thus the normal light amount exposes the picture image.

* Fading is not possible between the  setting and the  setting because the exposure adjustment is made automatically by the meter.

* Fading is an important technique for movie making, used for changing scenes, for the introduction or the end. During the movie, fading is used for big scene changes or to indicate the passing of time, so it should not be used too frequently. When fading is used for changing scenes, it should usually last from 2 to 3 seconds. At the beginning and the end of the movie, it should last about 4 to 6 seconds.



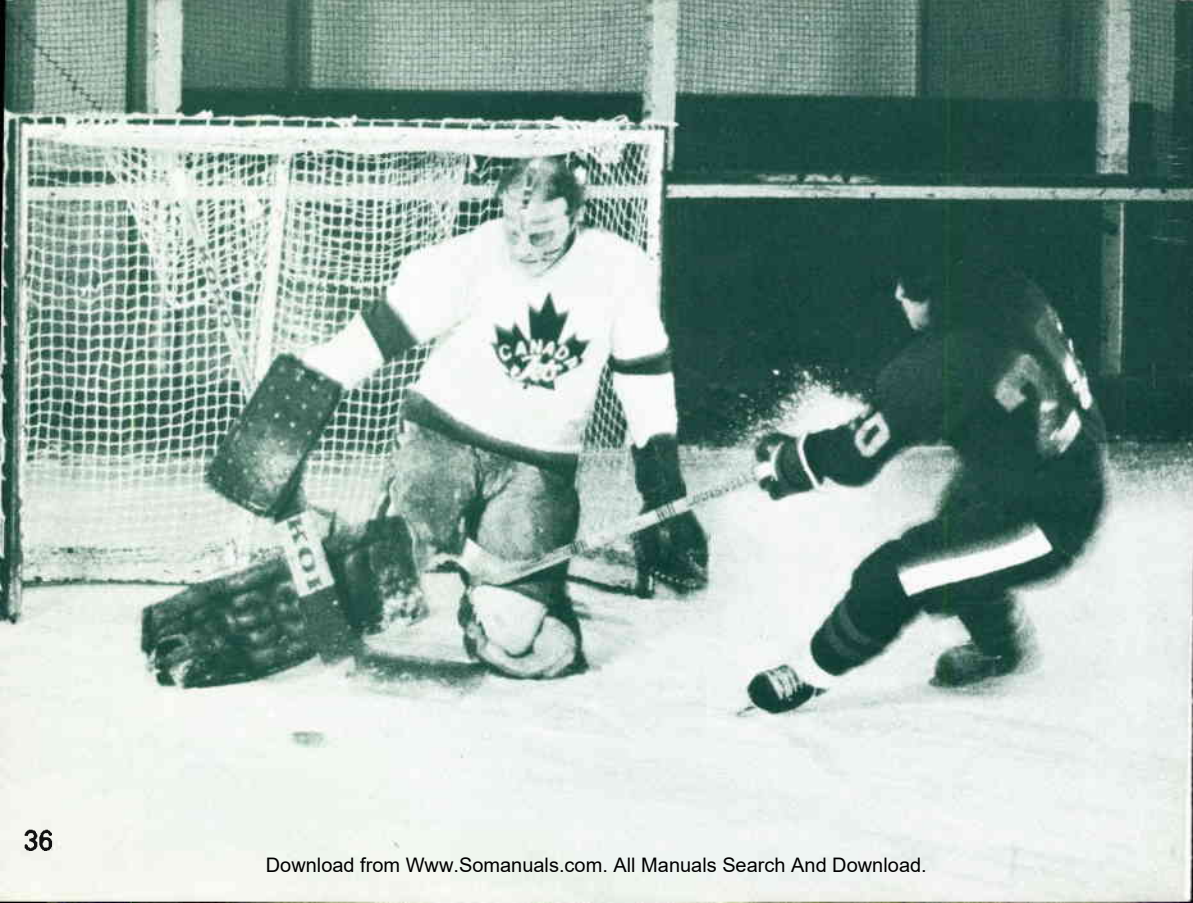

Running Lock

This is a lock for continuous shooting, used in remote control and single frame shooting as well as with the self-timer. Set the main switch at 'RL' and press the shutter lever to lock it. Then shooting can be continued even after your finger is removed. To release the running lock, set the main switch to 'R'.

* The main switch can be set at 'RL' after pulling the shutter lever for film drive. When the running lock is used, the exposure indication window lamp within the viewfinder goes out in order to save power. If the f/number has to be checked, please pull the shutter lever to light the lamp.

Remote Control

This mechanism allows to control the shutter from a distance using the remote switch 60 or 3, with which EE shooting is possible. This operation can be adopted for single frame shooting as well.

Preparations

1. Set the main switch at 'OFF' and insert the remote switch plug into the remote control socket of the camera.
2. Set the main switch at 'RL' and pull the shutter lever all the way. (The same position as running lock.)

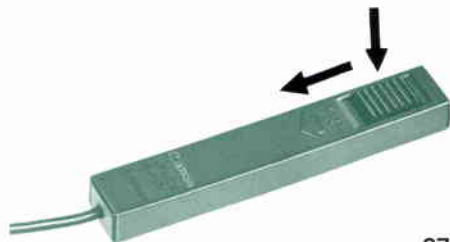
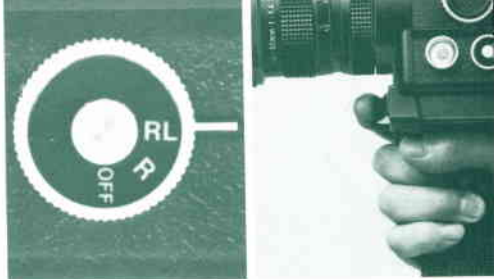

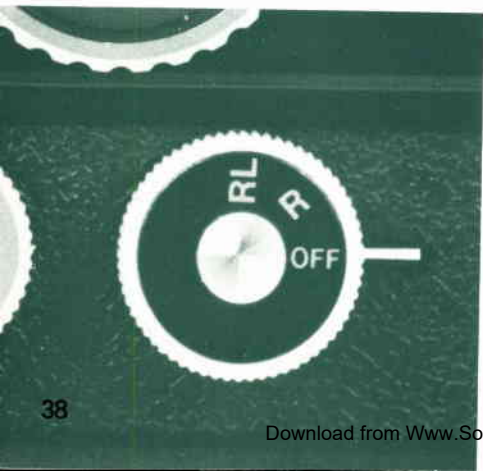

Shooting

Press down the remote switch button to begin advancing film. Slide the button forward to set the remote switch for running lock, which will provide continuous shooting even after your finger has been withdrawn. If you want to check exposure, pull the shutter lever, the same as running lock. Then the exposure indication in the viewfinder lights up for you to read the exposure. In manual aperture control shooting as well, the exposure value can be checked the same as above.

How to Release

First, rotate the main switch to either 'R' or 'OFF', and unplug the Remote Switch. If you unplug the remote switch first, the shutter is released and film will be wasted. Please follow this sequence.

* When remote control shooting is over, rotate the main switch to 'OFF'. If you leave the switch at 'RL', power consumption continues and shortens battery life. Therefore it is better to make the settings just before shooting.

* When you shoot from a distance, since you cannot verify the situation through the viewfinder, please check the subject condition well

beforehand, and set the camera position so that you don't make mistakes in framing.

* Please mount the finder cover when shooting.

Single Frame Shooting

Since this camera has a magnetic release mechanism, single frame shooting is possible with EE. In this case, please use the remote switch 60.

1. Set the main switch to 'OFF' and set the filming speed dial at **1**.
2. Plug in the Remote Switch 60 into the remote control socket.
3. Set the main switch at 'RL' and press the shutter release lever all the way in.
4. When you press the button of the remote switch, you can shoot single frames.
5. To reset it, please reset the main switch the same as when the remote control switch is being used.

* For single frame shooting, please use the frame counter.

* If you shoot single frames without using the remote switch, set the filming speed dial to **1** and pull the shutter release lever. Filming should be done with manual aperture control and not with EE.

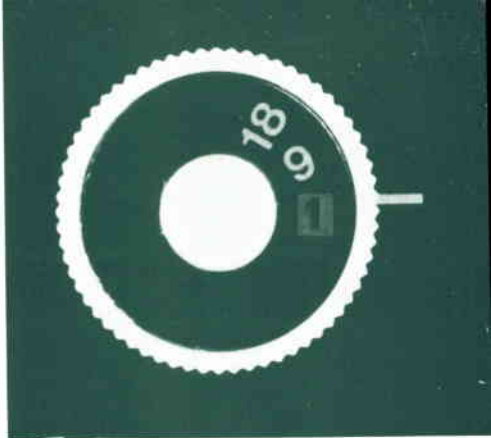

Single frame shooting is used to show in a short time subject changes that takes a long time, or to make animation movies. Please calculate the projection time and the frame numbers required. For example, if you want to show a flower that takes one hour to bloom in five seconds of projection time, the frame number required to shoot is 18 (the standard filming speed of 18 fps) times 5, which is 90. Therefore, 90 frames are needed for 5 seconds' projection. And since the flower takes 3600 seconds (1 hour) to bloom, and 3600 divided by 90 is 40, you shoot every 40 seconds to obtain 90 frames in one hour. The Interval Timer E is very convenient for this, instead of the remote switch. The Interval Timer E can operate shooting with intervals up to 60 seconds.

Self-Timer E

For unmanned shooting, it is plugged into the remote control socket of the camera, and, then, it enables the photographer to film himself as well. After the start button in the center is pressed, it will film for 10 seconds after a 10 seconds lag. If you press the button, you can shoot repeatedly as many times as you want. It is reset the same as the remote switch.





Interval Timer E

This is an electronic timer to shoot single frames with certain given intervals. Plugged into the remote control jack located at the side of the camera body, the interval timer can be set by the dial located in the center of the timer. This dial can be adjusted from 1 second to 60 seconds. This can be used for synchronized shooting with a flash as well. To reset, it can be done in the same way as after single frame shooting with the remote switch.

Strobe Shooting

Since this camera has a flash synchronizing jack, you can synchronize flash for single frame shooting for titles or animation. Then, shooting should be done with manual aperture control and the exposure is calculated by the guide number and the shooting distance, the same as regular strobe shooting. The guide number is read in either the instructions of the speedlite in use or the calculation chart.

* Flash can be synchronized with both shutter angle settings, either the  or the . Exposure time coincides with the flash duration. For strobe shooting, please make sure that exposure is adjusted correctly in order to obtain a



steady picture image in your movies. Because all frames must have the right exposure for this purpose, operation is different from still photography using a strobe. Regulated power flash should be used to insure even exposure from frame to frame. If you are using a strobe without safety circuit, please set the exposure every time by metering just before the pilot lamp turns on or use AC power.

* It is said that strobe flashtubes usually have a life of about 5000 operations, about 1.5 cartridges of Super 8 film. Keep this in mind in single frame shooting.

Slow Motion Shooting

- Slow motion is high speed shooting, operated at about 36 fps. When you press down the instant slow motion switch while shooting at 18 fps. or 9 fps., it automatically switches to slow motion. If you remove your finger from the switch, the filming speed returns to the previous speed and you can continue shooting. This is very good to bring out different effects in movies. If you want to start out the cut in slow motion, first press down the instant slow motion

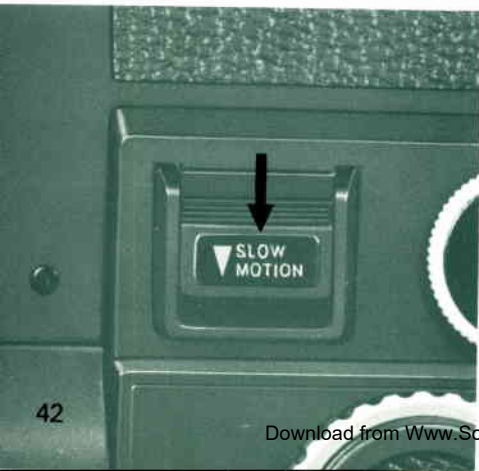

switch before pulling the shutter lever. To stop, first release the shutter lever and remove the finger from the instant slow motion switch.

* The instant slow motion switch only functions while you press the switch. It resets itself when you remove the finger. Please be careful not to accidentally let the switch loose while shooting.

* Operate this switch quickly, otherwise the relation between the exposure and filming speed does not match correctly.

* When shooting at 9 fps., you may notice a little unsteadiness when changing to slow motion, but this is unavoidable because of mechanical reasons.

* When it is set for single frames, there is no reason to operate the instant slow motion switch. If you operate the switch by mistake, overexposure will result.

* Slow motion makes the movement about twice slower and exposure time is half the real time in projection. Please use this for occasions such as:

- When you want to soften the movement.
- When you want to avoid blur with moving subjects or when panning.





Recording System (DIN System)

For example, the pulse generator 'Synvoton 1-4' should be used with the Volland 'BRP' and 'SV 2209' connecting cords and a Philips '2209AV' tape recorder. Press the camera's shutter release lever after setting the tape recorder to recording mode. When the tape recorder start switch, which is coupled to the shutter lever, is set to ON and the tape recorder starts, voice is recorded on 1 and 2 tracks of the tape. The one pulse per frame signal from the camera is converted to a one pulse per four frames signal by the 'Synvoton 1-4' and recorded on track 4 of the tape. If you withdraw your hand from the shutter release lever, the tape recorder also stops.

* The 18 fps. filming speed is used.

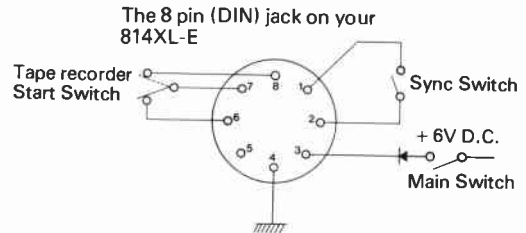
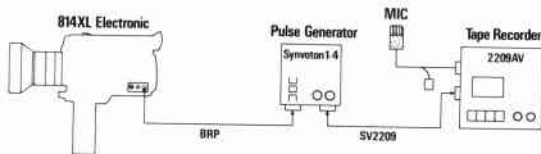

Caution: Do not short pins 3 and 4

Filming Techniques

There are various techniques involved in making movies. Although even the mere pressing of a shutter release is fun, if zooming or panning are added with inventive and creativity, movies turn out much better. Some examples follow so that you may consider them and try using these techniques.

Zooming

This can create a big effect in a movie. Scenes in which a subject gradually comes from far away until you can see it right in front of your very eyes, or inversely, a subject filling the whole screen and then diminishing into the distance away. The Canon 814XL Electronic has a power zoom system which allows free use of zooming techniques in filming with the greatest ease. By simply pushing a switch, the zooming effect is all yours, and since zooming causes no blur, filming is far more pleasant.

Remarks about Zooming

Zoom effects are great fun on the screen, but should be used in moderation. If there is too much of it, when projected on a screen, it can become a negative effect. When the lens is used



on the telephoto side, the same as the case of a normal telephoto lens, even a little blur is very noticeable on the screen, so please use a tripod for zooming.

1. The first thing to ascertain.

It is recommended to confirm the most effective time for zooming before pressing the shutter release.

2. Filming with various zooming speeds.

Manual zooming is used for short or slow zooming time. For example, when you zoom slowly, the change of image magnification is not too noticeable, but if you zoom quickly, you can cause a shocking effect. This is manual zooming's special realm.

3. A moving subject can be easily followed by zooming. The camera can follow a distant subject even from a stationary position. For example, by means of slow zooming, if magnification is kept constant to film the movement of a person coming towards you, the effect is that the image on the screen changes without any change in the size of the person.

4. Just a little zooming.

It is also rather effective to use zooming short of

maximum magnification and stop zooming then to film a planned scene on the way. After pause in zooming up and filming, start zooming up again to the maximum in one cut. This provides variety, too.



Panning

This technique can be used to give a wide view from a high place or to take in a whole room in one cut. Fix the camera on a point and move it sideways horizontally. Fix the camera on a tripod in order to avoid movement up or down. If your hand hold the camera, stand with your legs a little apart and turn the torso of your body only. It is necessary to adjust the filming speed adequately to prevent speeding up the movement. It takes less time to arrange this technique for important scenes. Keep panning speed constant and avoid panning too widely. Together with



zooming, it will stir up interest in your movies.

Tilting technique

Panning is a photographic technique consisting in a horizontal movement of the camera. Movement up and down is called tilting. Filming by moving the camera downwards is tilting down, and upwards is tilting up.

Filming Titles

The Canon 814XL Electronic can perform close-ups and copy work easily by means of the macro-cinematography mechanism. Please use it for filming titles. Pleasant titles can be made by animation and single frame shooting. If you project a spliced film, it can make the story boring. A title is necessary in order to show the purpose of filming, and for the sake of the audience as well as to have a concept understood. There can be many titles, for example, a main title to introduce a concept, a credit title to introduce a director, a title to explain a concept in writing, and an end title to bring everything to a finish. The main title and the end at least are needed. It is possible to substitute producer's mark or product initials for credit titles and print into a main title. Please study carefully various ideas before making a title.



Copy stand 4

Accessories

Close-up Lens C-8

The viewfinder is a single lens reflex type and has no parallax so that even in close-ups you can film just what you see. The Close-up Lens C-8 is specially designed for this 8mm camera and completely compensates chromatic aberration. If you screw this lens into the tip of lens, it increases power for titles, copying literature, filming plants, insects and so on. It is easy to use and convenient for the sky, and elusive small animals, since you can take close-ups from a distance. Distance adjustment is also easy.

* 58mm indicates the screw diameter, and 240 or 450 indicate the focal length. A subject that is 240mm (or 450mm) away from the tip of the lens will be in focus.



Close-up lens
450C-8-2



Close-up lens
240C-8

Shooting Distance and Field of View

58mm Close-up C-8

Type	Focusing Distance of Zoom Lenses	Distance Scale in the Focusing Ring	Distance from Subject to Film Plane	Field of View	Comparable Size
450	7.5mm	∞	609mm	339x251mm	B4
		1.2m	475mm	224x166mm	Between B5 and A5
	60mm	∞	609mm	45x33mm	Large size stamp
		1.2m	475mm	30x22mm	Stamp size
240	7.5mm	∞	394mm	179x132mm	B6
		1.2m	353mm	138x102mm	A4
	60mm	∞	394mm	24x17mm	Half size
		1.2m	353mm	18x13mm	Thumb nail

Filters

Exposure in this camera uses a TTL system which measures light through the lens. Therefore, when the filter is attached, exposure compensation is not required. Choose the Canon filter according to the shooting purpose. The filter thread diameter is 58mm and it is screwed on the tip of the lens.

Self-Timer E

Self-timer shooting can be performed with the timer attached to the remote control jack. Shooting continues for ten seconds after 10-second interval.

Interval Timer E

By using the Interval Timer E the time can be changed freely within one minute.

Copy Stand 4

Copy Stand 4 is convenient for macro-cinematography, title shooting and for copy works.

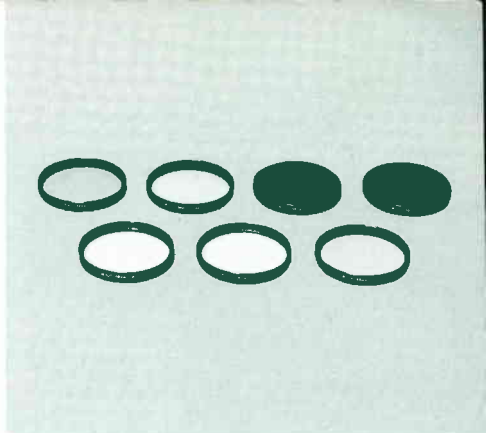

Notice

- **Warning**

The viewfinder cover is necessary when filming with your eye away from the viewfinder.

- **Cleaning**

Please periodically clean the film gate with a soft brush or blower.

- **When you store the camera**

Please store the camera in places where there is little humidity or dust. Do not place it near camphor or naphthalene. Remove the batteries. Storing the camera over long periods of time can harm the camera. It is good to use it from time to time. Periodical inspections every three years at a Canon service station are recommended.

- **Don't touch the lens with your fingers**

Dust must be removed with a blower or brushed away with a brush. If you leave a fingerprint on a lens, wipe it off lightly. It is possible to cause damage to a lens if you wipe it too strongly.

- **When the camera falls in the water**

Repair is practically impossible. Be careful not to have such a thing happen. If it does, please

take it to a service station immediately.

- **Safety Lock**

When you are not using it, the main switch has to be set at 'OFF'.

- **Caution with high temperatures**

The care of the camera demands that it never be left in a place with high temperatures such as a rear window or a trunk of a car. If you leave a camera at a place with high temperature, it can be damaged. Avoid such a case absolutely. If you leave it exposed without its cap, film may be exposed. Be careful about it, too.

- **Caution with low temperatures (The battery)**

The battery's power decreases suddenly below 0°C. It is recommended that you use full charged Ni-Cd batteries when filming below 0°C. It is convenient to have a spare battery and keep it warm with bodily heat, and use them alternately. Do not throw away a battery which did not function well in extreme cold. It may be usable at normal room temperatures. Please check the battery often in extremely cold places.

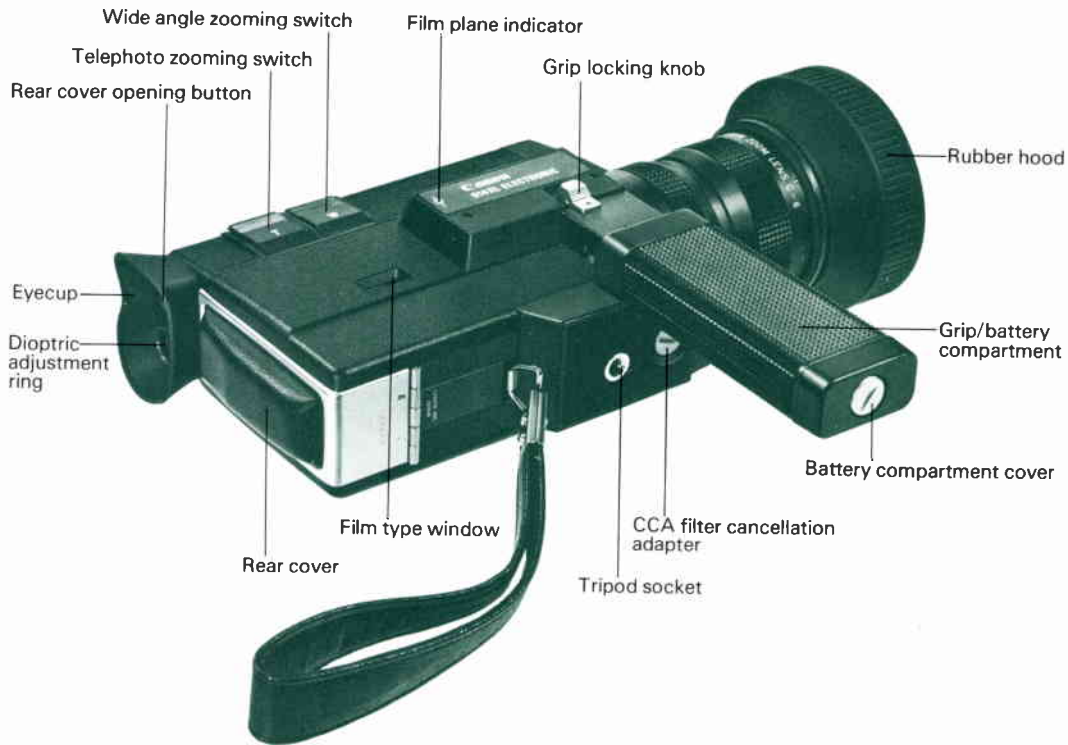



(Ambient temperature)

In very cold places, if you take a camera into a warm room coming back from the cold outside, drops of water adhere on the lens or the viewfinder because of the abrupt temperature change, so that good filming becomes impossible. Be careful about this.

In the light of considerable temperature changes, please gradually adapt the camera to the environment's temperature. A way to do so is to put the camera inside a vinyl bag, seal it up, and let it gradually adapt to the change in temperature.

Canon

CANON INC. 11-28, Mita 3-chome, Minato-ku, Tokyo 108, Japan

U.S.A. — **CANON U.S.A., INC. HEAD OFFICE**
10 Nevada Drive, Lake Success, Long Island, N.Y. 11040, U.S.A.

CANON U.S.A., INC. MANHATTAN OFFICE
600 Third Avenue, New York, N.Y. 10016, U.S.A.

CANON U.S.A., INC. ATLANTA SERVICE STATION
160 Peachtree Street, N.W., Atlanta, Georgia 30303, U.S.A.

CANON U.S.A., INC. CHICAGO OFFICE
140 Industrial Drive, Elmhurst, Illinois 60126, U.S.A.

CANON U.S.A., INC. LOS ANGELES OFFICE
123 Paularino Avenue East, Costa Mesa, California 92626, U.S.A.

CANON U.S.A., INC. LOS ANGELES SERVICE STATION
3407 West 6th Street, Los Angeles, California 90020, U.S.A.

CANON U.S.A., INC. SAN FRANCISCO SERVICE STATION
776 Market Street, San Francisco, California 94102, U.S.A.

CANON U.S.A., INC. HAWAII OFFICE
Bldg. B-2, 1050 Ala Moana Blvd., Honolulu, Hawaii 96814, U.S.A.

CANADA — **CANON OPTICS & BUSINESS MACHINES CANADA, LTD.**
HEAD OFFICE

3245 American Drive, Mississauga, Ontario, L4V 1N4, Canada

CANON OPTICS & BUSINESS MACHINES CANADA, LTD.
MONTREAL OFFICE

3070 Brabant-Marineau Street, St. Laurent, Quebec, H4S 1K7, Canada

CANON OPTICS & BUSINESS MACHINES CANADA, LTD.
VANCOUVER OFFICE

7351 Elmbridge Way, Richmond, B.C., V6X 1B8, Canada

**EUROPE AFRICA
& MIDDLE EAST** — **CANON AMSTERDAM N.V.**
Gebouw 70, Schiphol Oost, Holland

**CENTRAL &
SOUTH AMERICA** — **CANON LATIN AMERICA, INC. SALES DEPARTMENT**
P.O. Box 7022, Panama 5, Rep. of Panama

CANON LATIN AMERICA, INC. REPAIR SERVICE CENTER
P.O. Box 2019, Colon Free Zone, Rep. of Panama

SOUTHEAST ASIA — **CANON INC. HONG KONG BRANCH**
5th Floor 2-6, Fui Yiu Kok Street, Tsuen Wan, New Territories, Hong Kong

Free Manuals Download Website

<http://myh66.com>

<http://usermanuals.us>

<http://www.somanuals.com>

<http://www.4manuals.cc>

<http://www.manual-lib.com>

<http://www.404manual.com>

<http://www.luxmanual.com>

<http://aubethermostatmanual.com>

Golf course search by state

<http://golfingnear.com>

Email search by domain

<http://emailbydomain.com>

Auto manuals search

<http://auto.somanuals.com>

TV manuals search

<http://tv.somanuals.com>