

EN

User instructions

CE 104/1

CE 124/1

Candy 

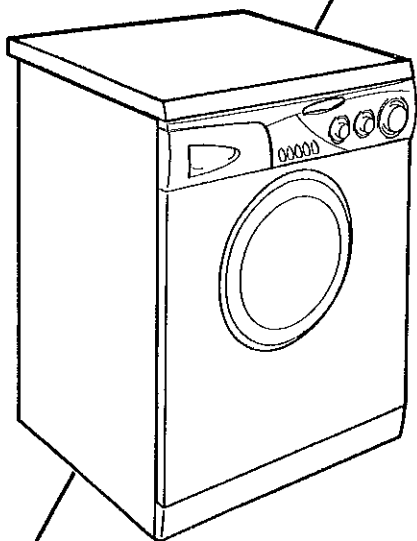



WITH OUR COMPLIMENTS

Thank you for choosing a Candy appliance.

Quality washing machines which guarantee high performance and reliability.

We also manufacture a comprehensive range of household appliances including dishwashers, washer dryers, tumble dryers, fridges, fridge freezers, freezers, cookers, hobs, microwaves and conventional ovens.

For further details contact your local retailer for a copy of a Candy brochure.

Please read this booklet carefully as it provides important guidelines for the safe installation, use and maintenance of your appliance, together with some useful advice on how to achieve the best results when using your washing machine.

For future reference please keep this instruction booklet in a safe place.

Always quote the model number of your appliance in any correspondence with a Candy Service Centre.

Warning: make sure the appliance is correctly installed and that the transit brackets are removed - see chapter 5.

Important: if you require any further guidance to the use/maintenance of your machine please telephone the Candy Advice line on:
08705-990011.

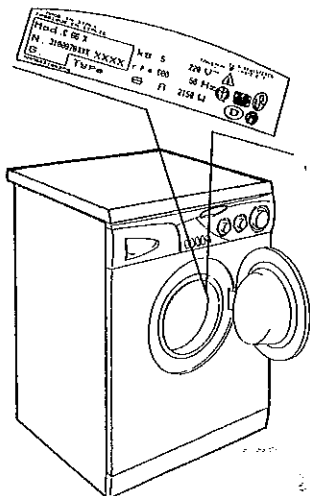
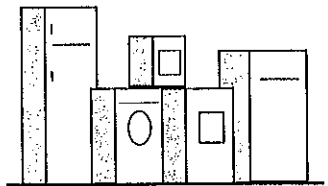
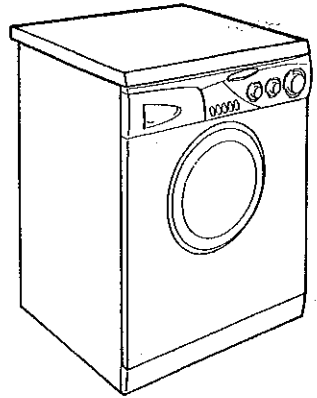

INDEX

CHAPTER

<i>Introduction</i>	
<i>General delivery points</i>	1
<i>Guarantee</i>	2
<i>Safety precautions</i>	3
<i>Technical data</i>	4
<i>Setting up and installation</i>	5
<i>Description of controls</i>	6
<i>Detergent drawer</i>	7
<i>Programme selection</i>	8
<i>About the appliance</i>	9
<i>Wash programme table</i>	10
<i>Customer Awareness / Completing a standard wash programme</i>	11
<i>Cleaning and routine maintenance</i>	12
<i>Reference check list "Before calling an Engineer"</i>	13

CHAPTER 1

GENERAL DELIVERY POINTS

On taking delivery of the appliance, check that the following has been included with the machine.

- A) AN INSTRUCTION MANUAL
- B) CUSTOMER SERVICE CENTRE ADDRESSES/TELEPHONE NO.
- C) A PRODUCT REGISTRATION CARD
- D) CAP
- E) BEND FOR THE OUTLET HOSE
- F) LIQUID DETERGENT COMPARTMENT

PLEASE KEEP THESE IN A SAFE PLACE

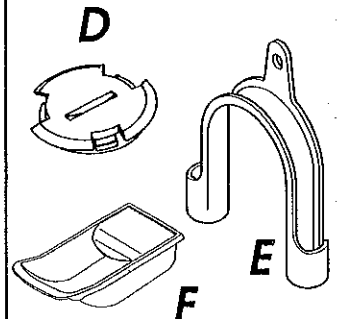
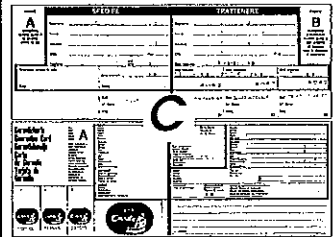
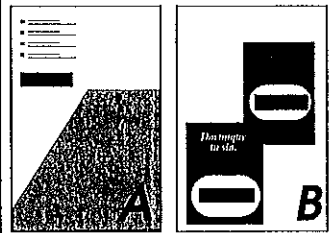
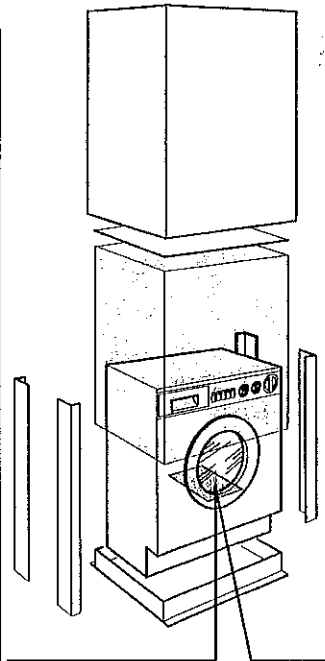

CHAPTER 2

GUARANTEE

Your new appliance is fully guaranteed by the manufacturer for 12 months against electrical/mechanical breakdown excluding:

- A. Any faults which occur due to bad installation or misuse of the machine.
- B. Any faults which occur due to repair of, or interference with, the machine by any person not authorised by the manufacturer to carry out service.
- C. Any faults which arise from parts fitted to the machine which are not the manufacturers original parts.
- D. Any faults arising from non-domestic use or unusual or abnormal use of the machine.
- E. Any faults arising from operation at an incorrect voltage.
- F. Any faults arising from incorrect operation of the machine.

The guarantee applies to Gt. Britain and Northern Ireland only, and is an addition to your statutory rights.

Your appliance is supplied with a registration card which should be completed and returned as indicated.

This should be kept in a safe place and presented to the Engineer if a service call is required.

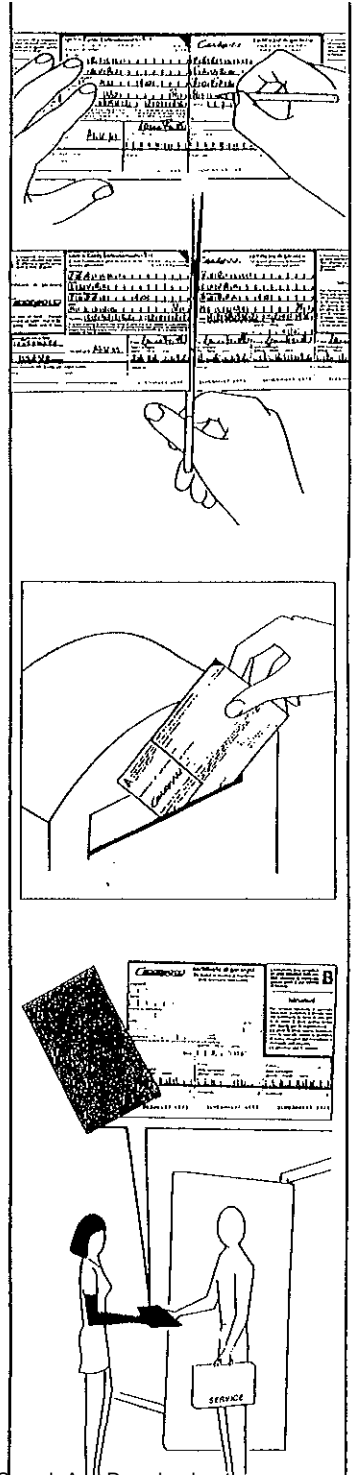

CHAPTER 3

SAFETY MEASURES

**IMPORTANT:
BEFORE CLEANING OR GENERAL MAINTENANCE**

- Remove the plug
- Turn off the water inlet tap.
- All Candy appliances are earthed, ensure that the main electricity circuit is earthed. Contact a qualified electrician if this is not the case.

CE This appliance complies with Directives 89/336/EEC, 73/23/EEC and the following changes.

- Do not touch the appliance with wet or damp hands or feet.
- Do not use the appliance when bare footed.

Warning: this appliance must be earthed.

WARNING: DURING THE WASH CYCLE, THE WATER CAN REACH A TEMPERATURE OF 90°C.

- Before opening the washing machine door, ensure that there is no water inside the drum.

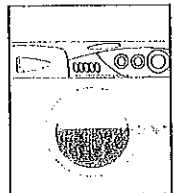
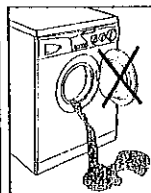
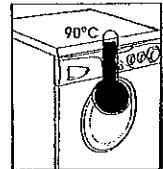
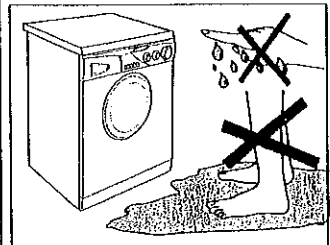
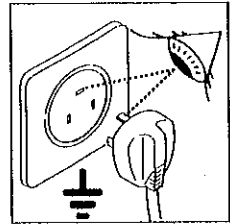
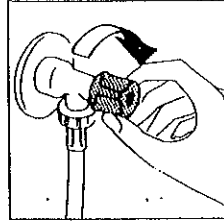
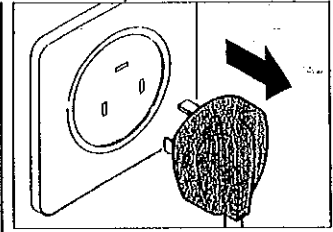



- Do not use adapters or multiple plugs.
- Do not allow the appliance to be used by children without supervision.
- Do not pull the mains lead or the machine itself in an attempt to remove the plug from the socket.
- Do not leave the appliance exposed to the natural elements (rain, sun, freezing etc.)

● **Important!**

When placed on carpet or carpet tiles care must be taken to ensure that there is no obstruction to the bottom vents.

● During transport do not lean the loading door against a trolley.

● Lift the appliance in pairs as illustrated in the diagram.

● In the event of appliance failure and/or incorrect operation, turn off the washing machine, disconnect the electrical supply and do not tamper with the appliance. Refer to the check list in chapter 13 for "possible reasons for the problem". Then if necessary contact the Candy Service Centre shown in the booklet supplied for repairs.

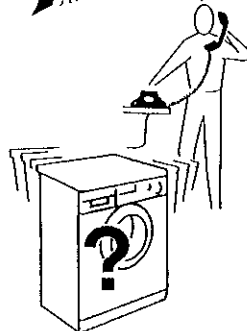
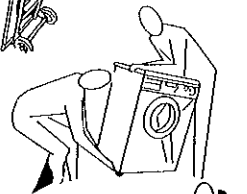
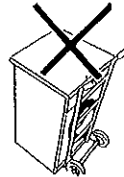
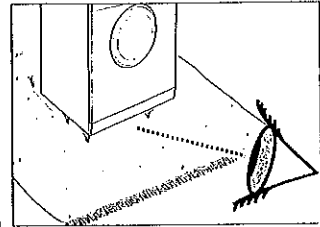
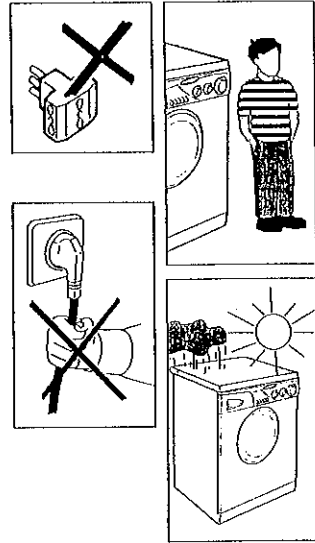

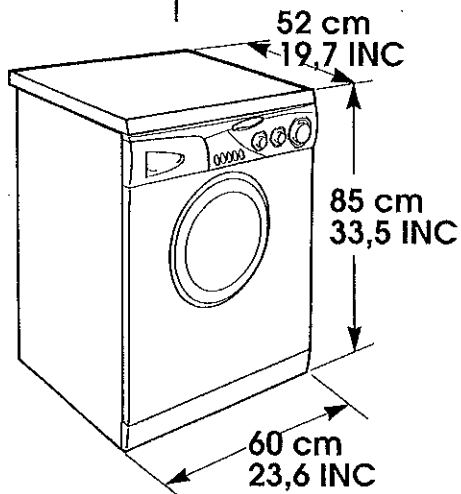

MAXIMUM DRY LOAD	lbs	10 (4.5 kg)
NORMAL WATER LEVEL	Gall	4.2 (19 l)
ECONOMIC WATER LEVEL	Gall	3 (15 l)
POWER INPUT	W	2050
ENERGY CONSUMPTION (PROG. <u>60</u> INTENS)	kWh	1.03
FUSE	A	13
SPIN SPEED	r.p.m.	400-1000 (CE 104/1)
SPIN SPEED	r.p.m.	400-1200 (CE 124/1)
SUPPLY VOLTAGE	V	240 (for U.K. only) 230 (others)
WATER PRESSURE	MPa	min. 0,05 max. 0,8

CHAPTER 5

SETTING UP INSTALLATION

Remove the polystyrene base and place the machine near its permanent position (diagram 1).

Carefully cut through the hose retaining clip at the rear of the appliance (diagram 2).

Unscrew the central bolt (A); unscrew the 4 lateral screws (B) and remove the cross piece (C) (diagram 3).

Lean the machine forward and remove the plastic bags containing the two polystyrene blocks at the sides, pulling downwards (diagram 4).

Press the plug (to be found in the envelope with the instructions) into the hole and rotate to lock into position (diagram 5).

WARNING:
DO NOT LEAVE THE PACKAGING IN THE REACH OF CHILDREN AS IT IS A POTENTIAL SOURCE OF DANGER.

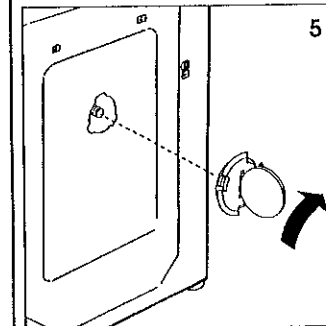
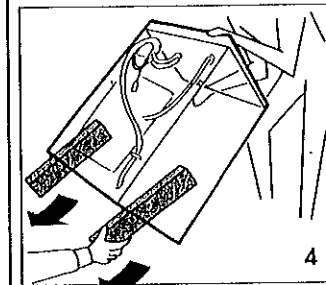
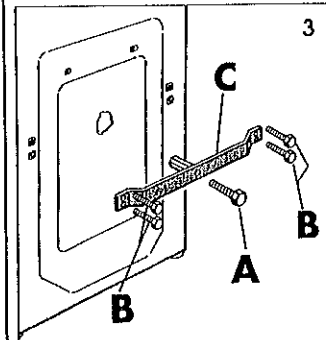
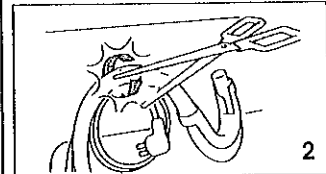
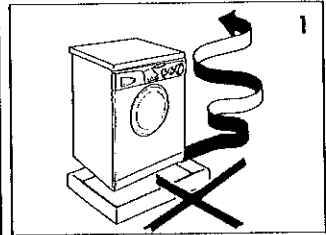



WATER CONNECTION

Your machine may either be plumbed in or connected to existing taps, using a tap adaptor with a 3/4 B.S.P. threaded end connection. The water supply hoses to be found inside the drum are terminated in two different ways. One end which has a 90° elbow is to be connected to the appliance water connection **E** while the straight end is to be connected to the domestic supply tap. The hose with the white collar should be connected to the cold tap, and the hose with the red collar to the hot tap. The appliance is not suitable for use with mixer taps.

Hook the end of the outlet hose over the rim of the sink or outlet pipe, making sure that it is not kinked. For better positioning of the outlet hose make use of the plastic bend provided.

Where possible, use a fixed discharge pipe with a diameter greater than that of the outlet hose this allows the air to escape.

The minimum height of the top of the outlet hose should be 50 cm.

Extending the outlet hose, especially if the extension is more than 1 metre, could lead to malfunctioning of the discharge.

The appliance outlet hose should discharge into the foul water drainage system and not into the surface water drainage system. Should you require further advice please contact your local water authority.

Apply the adhesive label supplied in the appropriate language onto the pull-out wash programme guide (R).
(See chapter 6 - description of control panel).

Level the machine by means of the front feet.

- Turn the nut clockwise to release the screw adjuster on the foot.
- Rotate the foot to raise or lower it until it stands firmly on the ground.
- Lock the foot in position by turning the nut anti-clockwise until it comes up against the bottom of the machine.

Ensure that the ON/OFF button (see page 12, button C) is not pressed and the load door is closed.

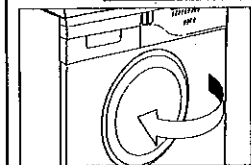
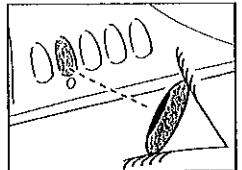
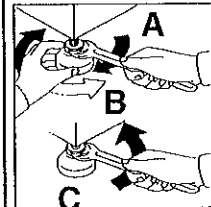
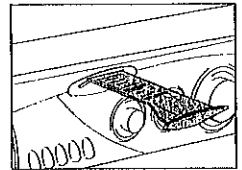
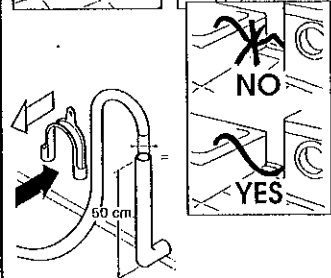
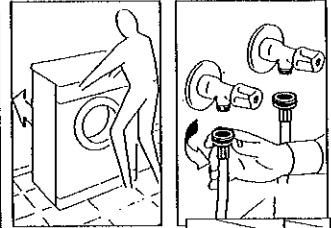
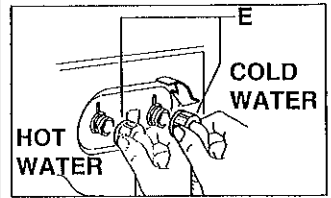



ELECTRICAL CONNECTIONS

If the plug we supply does not fit
CUT IT OFF AND DESTROY IT!
 You can't use it on other appliances, and the exposed wires
 could be dangerous if plugged in.
 To fit a replacement plug, proceed as follows:

Connect	to the terminal in the plug	
green and yellow wire	marked with the letter E, OR marked with the symbol, — — — — — 	
blue wire	marked N OR coloured black.	
brown wire	marked L OR coloured red.	

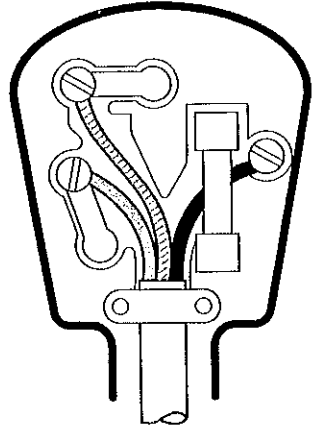

WARNING

This appliance must be earthed

Fuses and plugs

This appliance should be used only on a socket with a minimum rating of 13 Amp.

Our ready-fitted plug is already equipped with a 13 amp fuse which is BS 1362 ASTA approved. Any replacement should be exactly the same.

If the fuse cover is lost, do not use the plug until it is replaced. A correct replacement fuse cover (obtainable from your local retailer) must be the same colour as shown or named on the insert on the base of the plug.

Press the ON/OFF (page 12, button C) button. The power on (page 12, indicator G) light will light up. If this does not light up see faults search.

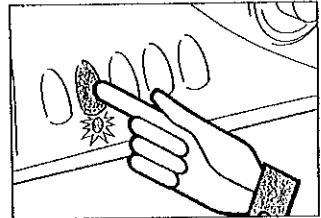

CHAPTER 6

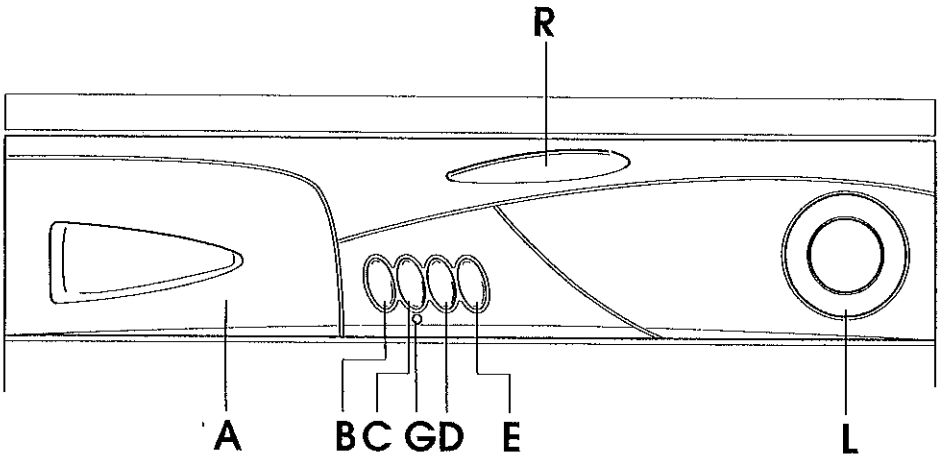

CONTROLS

Detergent drawer

Door open button

On/off button

Half load button

90°C wash button

ON/OFF indicator light

Wash programme dial

Pull-out wash programme guide

A
B
C
D
E
G
L
R

CHAPTER 9

ABOUT THE APPLIANCE**IMPORTANT:**

Do not spin heavy articles such as bed spreads or rugs.

Only woollens bearing a machine washable care label are suitable for machine washing.





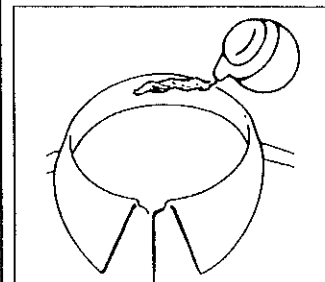
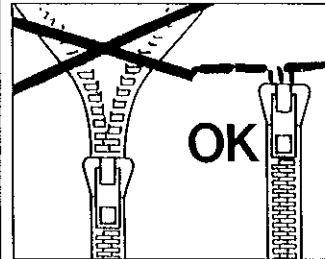
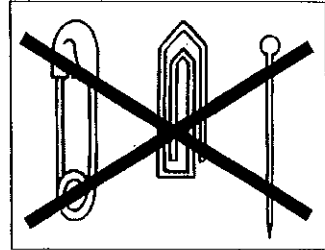
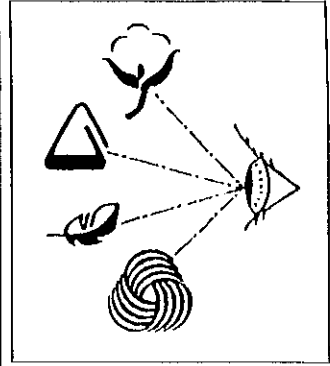





















When sorting items of laundry for washing always ensure that:

- you check pockets for metal objects, brooches, safety pins or loose coins.
- cushion covers are zipped or buttoned, loose belts are fastened.
- full attention has been paid to individual wash care labels.
- tough stains have been treated with a pre-wash stain remover prior to machine washing. Only use stain removers recommended on the wash care label.









CHAPTER 10

TABLE OF WASH PROGRAMMES







FABRIC	SYMBOL ON LABEL	PROGRAMMES	WEIGHT MAX kg	SELECT. PROG. (CONTROL)	TEMP. °C
Resistant fabrics Cottons, linens		White cottons Colour fast table cloths, towels, underwear	4.5		60 *
					60 *
Cottons, mixed cotton resistant fabrics		Colour fast cottons Coloured shirts, dressing gowns, sheets	4.5		60
Cottons, mixed cottons and resistant fabrics		Non colour fast cottons	3.5		40
Cottons		Rinses	-	R	-
Cottons, linens		Conditioner, fragrance, softener	-		-
		Spin	-		-
Mixtures and synthetics Mixed fabrics		White synthetics Shirts, sheets, underwear	2	 ⁽¹⁾	60
Cotton, mixed fabrics, synthetics		Mixtures and synthetics All types of lightly soiled laundry	2		50
Synthetics (nylon, viscose), mixed cottons		Quick wash Shirts, blouses, skirts with resistant colours	2		40
					
Mixed, fabrics and synthetics		Rinses	-	R	-
		Conditioner, fabric, softeners	-		-
		Spin	-		-
No spin fabrics		Drain only water discharge	-		-
Very delicate fabrics Woollens Synthetics (Dralon, Acrylic, Trevira)		"MACHINE WASHABLE" woollens  curtains	1	 ⁽¹⁾	40
		Rinses	-	R	-
		Conditioner, fabric, softeners	-		-
		Spin	-		-

CHAPTER 10

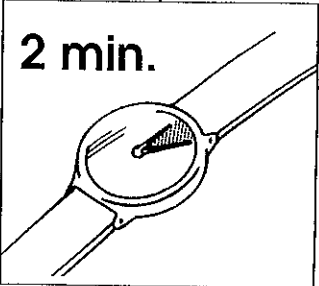
SUMMARY OF ITLC WASHING
SYMBOLS

Symbol	Wash Temperatures	Fabric	Benefits
	very hot 95° C to boll	White cotton and linen articles without special finishes	Ensures whiteness and stain removal
	hot 60° C	Cotton linen or viscose articles without special finishes where colours are fast at 60° C	Maintains colours
	hot 60° C	White nylon; white polyester/cotton mixtures	Prolongs whiteness -minimises creasing
	handhot 50° C	Coloured nylon; polyester cotton and viscose articles with special finishes; acrylic/cotton mixtures; coloured polyester/cotton mixtures	Safeguards colour & finish- minimises creasing
	warm 40° C	Cotton, linen or viscose articles where colours are fast at 40° C, but not at 60° C	Safeguards colour fastness
	warm 40° C	Acrylics; acetate and triacetate, including mixtures with wool; polyester/wool blends	Preserves colour & shape minimises creasing
	warm 40° C	Wool, including blankets, and wool mixtures with cotton or viscose; silk	Keeps colour, size and softness

DESCRIPTION OF CONTROLS

<p>DOOR OPEN BUTTON</p> <div style="border: 1px solid black; padding: 5px; margin: 10px 0;"> <p>IMPORTANT: A SPECIAL SAFETY DEVICE PREVENTS THE DOOR FROM BEING OPENED AT THE END OF THE WASH/SPIN CYCLE. WE RECOMMEND THAT YOU ALLOW TWO MINUTES TO ELAPSE BEFORE OPENING THE DOOR AT THE END OF THE FINAL SPIN CYCLE.</p> </div>	B	 
<p>ON/OFF BUTTON</p>	C	
<p>HALF LOAD BUTTON</p> <p>When washing a small load select the half load button to save on water, electricity and detergent. When this option is selected less water is introduced during the wash and rinse cycles.</p> <p>WARNING: NEVER press the  when washing PURE NEW WOOL, since wool absorbs water and therefore needs all the water the machine will hold. DO NOT use it for delicate fabrics either, since they need the extra water to float them and protect them.</p>	D	
<p>90°C WASH BUTTON</p> <p>By selecting this option the machine will wash at 90°C suitable for heavily soiled cottons (PROGRAMMES A -  INTENS).</p>	E	
<p>ON/OFF INDICATOR LIGHT</p>	G	

WASH PROGRAMME DIAL

IMPORTANT:
ALWAYS ROTATE THE KNOB IN A CLOCKWISE
DIRECTION, NEVER IN AN ANTI-CLOCKWISE
DIRECTION. DO NOT PRESS THE "ON" BUTTON (C)
BEFORE SELECTING THE PROGRAMME

Shown in chapter 10:

The information shown in the table in chapter 10 provides a complete guide and is based upon the standard wash care symbols used by the textile industry.

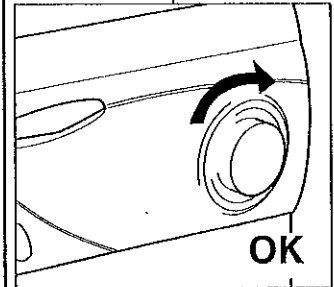
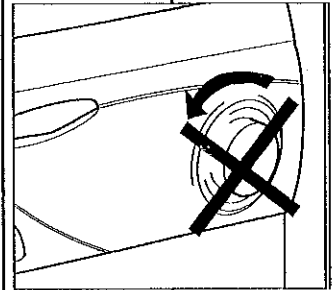

CHAPTER 7

DETERGENT DRAWER

The detergent drawer is divided into 4 compartments:

- The first I for pre-wash detergent
- The second II for main wash detergent

A special container is supplied for use with liquid detergents. This can be placed inside the drawer shown in fig. A.

IMPORTANT:
REMEMBER THAT SOME DETERGENTS CAN BE DIFFICULT TO REMOVE. IF THIS SHOULD OCCUR WE ADVISE THE USE OF A SPECIAL CONTAINER TO BE USED INSIDE THE DRUM.

- The third  bleaching compartment

IMPORTANT:
ONLY USE LIQUID PRODUCTS IN THE THIRD AND FOURTH COMPARTMENTS.

- The fourth  compartment is for special additives, fabric softeners, starches, whiteners, etc.

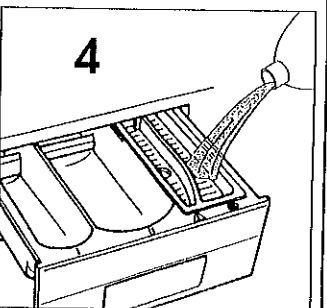
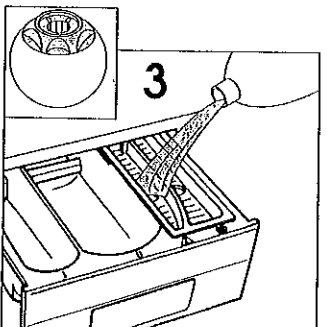
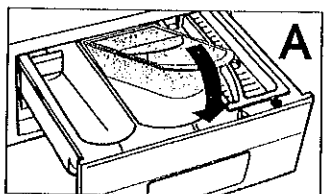
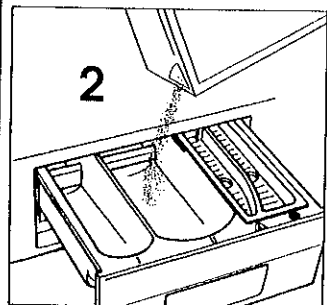
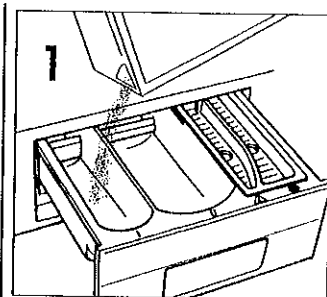

CHAPTER 8

PROGRAMME SELECTION

The wash programme dial is divided into three separate phases, according to different fabric types, the degree of soiling, temperature and length of cycle. (See table of wash programmes).

IC	NUMERO INCHIAVA	PROGRAMMA PER	CARICO MAX kg
III	95°	Molto sporca tessuto, svedaggio colorati e bianchi, asciugamento	5
II	95°	PROGRAMMA RAPIDO tessuto, svedaggio colorati bianchi, asciugamento	5
II	60°	Sporca normale Biancheria colorata, canotte, vestiti, maglia, lenzuola	5
I	60°	PROGRAMMA RAPIDO Biancheria colorata e bianchi, svedaggio	5
I	60°	Long & Soft Biancheria colorata, mediana sporca	3.5
III	40°	Biancheria di cotone, ingente, len- zuola	5
		Miscela opzionale	-
		Risciacquo anallergico	5

1 Resistant fabrics (mainly heavy cottons)

These programmes have been designed to give maximum wash. The gradual reduction of water temperature reduces fabric creasing and the final spin provides a more efficient removal of water.

2 Mixtures and synthetic fabrics

A combination of efficient washing, optimum drum rotation and 3 high water level rinses provides excellent cleaning results.

3 Special delicate fabrics

A new wash cycle which has been specifically designed for very delicate fabrics or machine washable woollens, alternates between very gentle washing and soaking cycles.



CHAPTER 11

CUSTOMER AWARENESS

A guide environmentally friendly and economic use of your appliance.

MAXIMISE THE LOAD SIZE

Achieve the best use of energy, water, detergent and time by using the recommended maximum load size. Save up to 50% energy by washing a full load instead of 2 half loads.

DO YOU NEED TO PRE-WASH?

For heavily soiled laundry only
SAVE detergent, time, water and between 5 to 15% energy consumption by **NOT** selecting Prewash for slight to normally soiled laundry.

IS A HOT WASH REQUIRED?

Pretreat stains with stain remover or soak dried in stains in water before washing to reduce the necessity of a hot wash programme. Save up to 50% energy by using a 60°C wash programme.

COMPLETING A STANDARD WASH PROGRAMME

- Comprehensive guidance is provided in the wash programme table, chapter 10.
- Always ensure that clothes are washed in accordance with the temperatures shown on the wash care labels.
- Open the loading door by depressing the button marked B in the diagram.
- Load the drum with a maximum of 4.5 Kg. of dry washing.
- Ensure that the door has been closed properly.
- Set the programme dial to the type of wash required.
- Push the On/Off button.

TO	BAROLO FRONTA	PROGRAMMA PER	CARICO MAX KG
III	95°	Molto sporco bianchi, lavaggio a colori scuro e bianchi, asciugamani bianchi	6
IIII	95°	PROGRAMMA RAPIDO lavaggio bianchi, lavaggio a colori scuro bianchi, asciugamani bianchi	6
IIIII	60°	Sporco normale bianchi a colori, cotone, misto maglie, lana (solo)	6
IIIIII	60°	PROGRAMMA RAPIDO lavaggio bianchi a colori e cotone normale maglie, lana (solo)	6
IIIIII	60°	Molto sporco, macchiato bianchi a colori, cotone, misto maglie, lana (solo)	3,5
IIIIII	40°	Più sporco di colore scuro, blue jeans	3
		Macchine opzionali	-

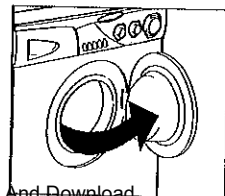
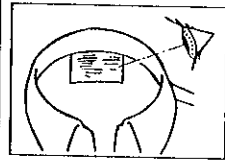

IMPORTANT:
WHEN SETTING THE PROGRAMME ENSURE THAT THE
ON/OFF BUTTON IS IN THE OFF POSITION.

EXAMPLE: CARRYING OUT A NORMAL WASH

1. Select the desired programme.
2. Choose the wash programme by rotating the knob I in a clockwise direction. The programme temperature on the dial should coincide with the temperature shown on the clothing (wash care symbol).
3. Open the detergent drawer (A).
4. Put 125 g. of detergent in the main wash compartment (ii).
5. Put 50 ml. of fabric softener in the additives compartment .
6. Close the detergent drawer (A).
7. Ensure that the water inlet taps are turned on.
8. And that the water discharge hose is in place
9. Press the On button (C).
10. The indicator light (G) will come on.
11. The washing machine will then carry out the set programme.
12. At the end of the programme, press the On/Off button (C) the Indicator light will go out.
13. Open the door and remove the laundry

**ALWAYS CONSULT THE PROGRAMME TABLE AND
FOLLOW THE STEPS IN THE ORDER INDICATED ABOVE.**

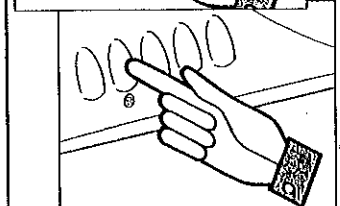
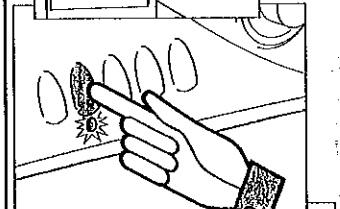
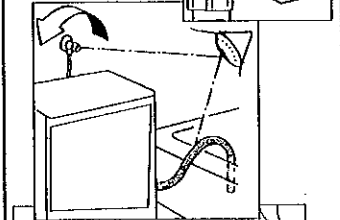
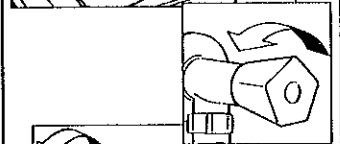
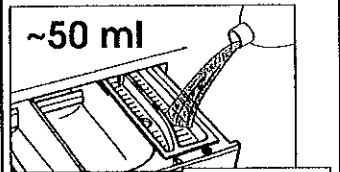
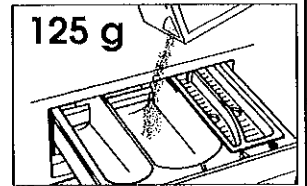
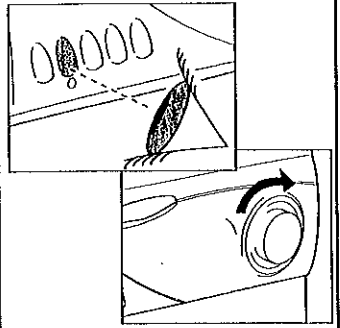

CHAPTER 12

CLEANING AND ROUTINE MAINTENANCE

Do not use abrasives, spirits or solvents on the machine exterior, simply wipe over with a damp cloth.

- Cleaning the detergent drawer.
- Guidance on transporting the appliance/storage instructions for long periods of inactivity.

CLEANING THE DETERGENT DRAWER COMPARTMENTS

Although not strictly necessary, it is advisable to clean each of the compartments occasionally.

Remove the drawer by pulling gently.

Clean with water.

Push the detergent drawer back into place

GUIDANCE ON TRANSPORTING THE APPLIANCE/STORAGE INSTRUCTIONS FOR LONG PERIODS OF INACTIVITY

The following instructions must be followed prior to moving the appliance or if the appliance is to be left un-used/stored for a long period.

- Switch off the appliance and unplug.
- Detach the drainage hose and drain over a bowl until all of the water is removed.
- Repeat the same operation with the water inlet hose.

SUGGESTED:

If transporting the appliance refit the transit brackets by following in reverse order the instructions given in chapter 5.

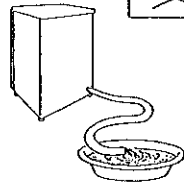
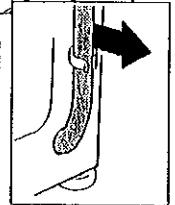
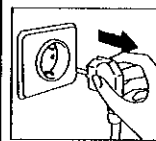
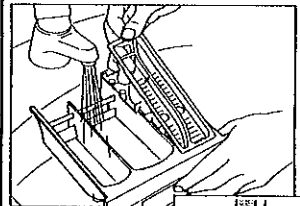
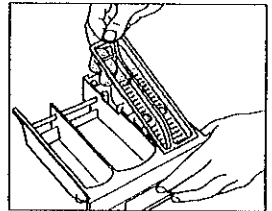
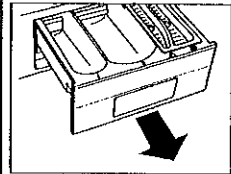
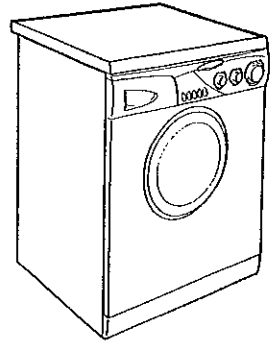
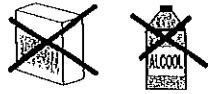

CHAPTER 13

FAULT	CAUSE	REMEDY
1. Does not function on any programme	Mains plug not plugged in	Insert plug
	Mains switch not on	Turn on mains switch
	No power	Check
	Electric circuit fuses failure	Check
	Load door open	Close load door
2. Does not load water	See cause 1	Check
	Inlet tap turned off	Turn on water inlet tap
	Timer not set correctly	Set timer on correct position
3. Does not discharge water	Discharge tube bent	Straighten discharge tube
4. Water on floor around washing machine	Leak from the washer between the tap and inlet tube	Replace washer and tighten the tube on the tap
5. Does not spin	The washing machine has not discharged water	Wait a few minutes until the machine discharges water
	"No spin" setting (some models only)	Turn the programme dial onto spin setting
	Some models feature an "out of balance" control to prevent spin under these conditions.	Distribute the washing evenly around the drum and reselect the spin programme
6. Strong vibrations during spin	Washing machine not perfectly level	Adjust special feet
	Transit brackets not removed	Remove transit brackets
	Wash load not evenly distributed	Distribute the washing evenly

If the fault should persist, contact a Candy Service Centre. For prompt servicing, give the model of the washing machine, to be found on the label placed on the cabinet inside of the porthole or on the guarantee certificate.

Important

1 The use of environment friendly detergents without phosphates may produce the following effects:

- The discharge rinse water may result cloudier due to the presence of zeolites in suspension. This does not compromise the efficiency of the rinses.
- The presence of white powder (zeolites) on the washing at the end of the washing cycle. This does not remain incorporated in the fabric and does not alter the colour.
- The presence of foam in the last rinse water which is not necessarily a sign of inadequate rinsing.
- The non-ionic surface-active agents present in the composition of washing machine detergents are often difficult to remove from the washing itself and, even in small quantities, may produce visible signs of the formation of foam.
- Carrying out further rinses, in cases such as this, is not useful.

2 If your washing machine fails to function, carry out the above-mentioned checks before calling the Candy Technical Assistance Service.

La Ditta costruttrice declina ogni responsabilità per eventuali errori di stampa contenuti nel presente libretto. Si riserva inoltre il diritto di apportare le modifiche che si renderanno utili ai propri prodotti senza compromettere le caratteristiche essenziali.

Le constructeur décline toute responsabilité pour les éventuelles erreurs d'imprimerie contenues dans le présent mode d'emploi. Il se réserve en outre le droit d'apporter toutes modifications qui se révéleraient utiles à ses propres produits sans pour autant en compromettre les caractéristiques essentielles.

The manufacturer declines all responsibility in the event of any printing mistakes in this booklet. The manufacturer also reserves the right to make appropriate modifications to its products without changing the essential characteristics.

Wir schließen die Haftung für alle evtl. Druckfehler aus. Kleinere Änderungen und technische Weiterentwicklungen im Detail vorbehalten.

Wij stellen ons niet aansprakelijk voor eventuele drukfouten. Kleine veranderingen en technische ontwikkelingen zijn voorbehouden.

La firma fabricante declina toda responsabilidad por los posibles errores de impresión que puedan haber en este libretto. Asimismo, se reserva el derecho de efectuar las modificaciones que se consideren útiles a sus propios productos sin comprometer las características esenciales.

O modelo e características indicados nesta folha podem ser alterados sem qualquer aviso.

CANDY ELETTRODOMESTICI s.r.l.
Brugherio (Milano)

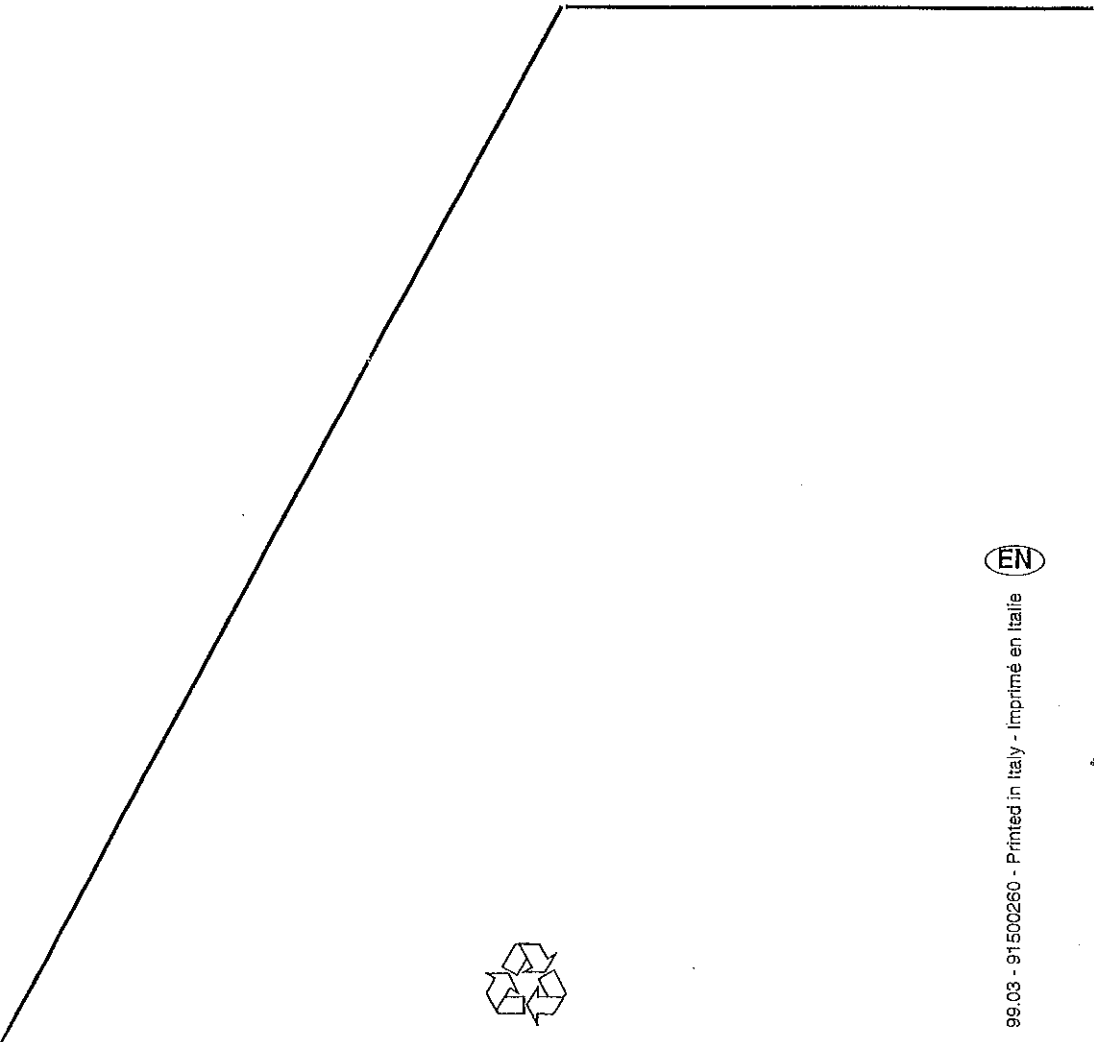

EN

99.03 - 91500260 - Printed in Italy - Imprimé en Italie

Free Manuals Download Website

<http://myh66.com>

<http://usermanuals.us>

<http://www.somanuals.com>

<http://www.4manuals.cc>

<http://www.manual-lib.com>

<http://www.404manual.com>

<http://www.luxmanual.com>

<http://aubethermostatmanual.com>

Golf course search by state

<http://golfingnear.com>

Email search by domain

<http://emailbydomain.com>

Auto manuals search

<http://auto.somanuals.com>

TV manuals search

<http://tv.somanuals.com>