

User's Guide

PlayWorks PS2000 Digital

Information in this document is subject to change without notice and does not represent a commitment on the part of Creative Technology Ltd. No part of this manual may be reproduced or transmitted in any form or by any means, electronic or mechanical, including photocopying and recording, for any purpose without the written permission of Creative Technology Ltd. The software described in this document is furnished under a license agreement and may be used or copied only in accordance with the terms of the license agreement. It is against the law to copy the software on any other medium except as specifically allowed in the license agreement. The licensee may make one copy of the software for backup purposes.

Copyright © 2000 by Creative Technology Ltd. All rights reserved.

Version 1.0
July 2000

© 2000 Cambridge SoundWorks, Inc. All rights reserved. Cambridge SoundWorks is a registered trademark, and PlayWorks is a trademark of Cambridge SoundWorks, Inc., Newton, MA. Creative, the Creative logo and Sound Blaster are registered trademarks, and EAX, the EAX logo, PC-DVD, Encore and Creative Multi-Speaker-Surround are trademarks of Creative Technology, Ltd. PlayStation is a trademark of Sony Computer Entertainment, Inc. Dolby, Dolby Digital, Pro Logic and AC-3 are trademarks of Dolby Laboratories. All rights reserved. All other brands and products names are trademarks or registered trademarks of their respective owners. All specifications are subject to change without prior notice. Actual contents may differ slightly from those pictured.

Safety & Regulatory Information

The following sections contain notices for various countries:

CAUTION: This device is intended to be installed by the user in a CSA/TUV/UL certified/listed IBM AT or compatible personal computers in the manufacturer's defined operator access area. Check the equipment operating/installation manual and/or with the equipment manufacturer to verify/confirm if your equipment is suitable for user-installed application cards.

Modifications

Any changes or modifications not expressly approved by the grantee of this device could void the user's authority to operate the device.

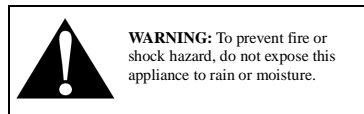

Compliance

This product conforms to the following Council Directive:

- Directive 89/336/EEC, 92/31/EEC (EMC).

Important Notice

The serial number for the *PlayWorks PS2000 Digital* is located on the subwoofer. Please write this number down and keep it in a secure area. This is for your security.

IMPORTANT SAFETY INSTRUCTIONS

READ INSTRUCTIONS - All safety and operating instructions should be read before the *PlayWorks PS2000 Digital* amplified subwoofer/satellite system is operated.

RETAIN INSTRUCTIONS - The safety and operating instructions should be retained for future reference.

HEED WARNINGS - All warnings on the subwoofer and in the operating instructions should be adhered to.

FOLLOW INSTRUCTIONS - All operating and use instructions should be followed.

CLEANING - Unplug the subwoofer from the wall outlet or other power source before cleaning. Do not use liquid cleaners or aerosol cleaners. Use a damp cloth for cleaning.

ATTACHMENTS - Do not use attachments not recommended by Cambridge SoundWorks as they may cause hazards.

WATER AND MOISTURE - Do not use the subwoofer near water—for example, near a bath tub, wash bowl, kitchen sink, or laundry tub; in a wet basement; or near a swimming pool; and the like.

ACCESSORIES - Do not place the *PlayWorks PS2000 Digital* system on an unstable cart, stand, tripod, bracket, or table. The subwoofer or satellites may fall, causing serious injury to a child or adult, and serious damage to the product. Use only with a cart, stand, tripod, bracket, or table recommended by Cambridge SoundWorks, or sold with the product. Any mounting of the satellites or subwoofer should follow the manufacturer's instructions, and should use a mounting accessory recommended by Cambridge SoundWorks.

VENTILATION - Slots and openings in the cabinet are provided for ventilation, to ensure reliable operation of the subwoofer and to prevent it from overheating; and these openings must not be blocked or covered. The openings should never be blocked by placing the product on a bed, sofa, rug, or other similar surface. The subwoofer should not be placed in a built-in installation such as a bookcase or rack unless proper ventilation is provided or Cambridge SoundWorks' instructions have been adhered to.

HEAT - The subwoofer should be situated away from heat sources such as radiators, heat registers, stoves, and other products (including amplifiers) that produce heat.

POWER SOURCES - The subwoofer should be operated only from the type of power source indicated on the marking label. If you are not sure of the type of power supply to your home, consult your product dealer or local power company. For products intended to operate from battery power or other sources, refer to the operating instructions.

POLARIZATION - The subwoofer may be equipped with a polarized alternating-current line plug (a plug having one blade wider than the other). This plug will fit into the power outlet only one way. This is a safety feature. If you are unable to insert the plug fully into the outlet, try reversing the plug. If the plug should still fail to fit, contact your electrician to replace your obsolete outlet. Do not defeat the safety purpose of the polarized plug.

POWER-CORD PROTECTION - Power-supply cords should be routed so that they are not likely to be walked on or pinched by items placed upon or against them, paying particular attention to cords at plugs, convenience receptacles, and the point where they exit from the subwoofer.

LIGHTNING - For added protection for the *PlayWorks PS2000 Digital* system during a lightning storm, or when it is left unattended and unused for long periods of time, unplug it from the wall outlet. This will prevent damage to the subwoofer due to lightning and power-line surges.

OVERLOADING - Do not overload wall outlets, extension cords, or integral convenience receptacles as this can result in a risk of fire or electric shock.

OBJECT AND LIQUID ENTRY - Never push objects of any kind into the subwoofer through openings as they may touch dangerous voltage points or short out parts that could result in a fire or electric shock. Never spill liquid of any kind on the subwoofer.

SERVICING - Do not attempt to service the subwoofer yourself as opening or removing covers may expose you to dangerous voltage or other hazards. Refer all servicing to qualified service personnel.

DAMAGE REQUIRING SERVICE - Unplug the subwoofer from the wall outlet or other power source and refer servicing to qualified service personnel under the following conditions:

a) When the power-supply cord or plug is damaged.

- b) If liquid has been spilled, or object have fallen into the subwoofer.
c) If the subwoofer has been exposed to rain or water.
d) If the subwoofer does not operate normally by following the operating instructions; or exhibits a distinct change in performance.
e) If the product has been dropped or damaged in any way.

REPLACEMENT PARTS - When replacement parts are required, be sure the service technician has used replacement parts specified by Cambridge SoundWorks or have the same characteristics as the original part. Unauthorized substitutions may result in fire, electric shock, or other hazards.

SAFETY CHECK - Upon completion of any service or repairs to the *PlayWorks PS2000 Digital* system, ask the service technician to perform safety checks to determine that the *PlayWorks PS2000 Digital* system is in proper operating condition.

WALL OR CEILING MOUNTING - The *PlayWorks PS2000 Digital* satellites should be mounted to a wall or ceiling only as recommended by Cambridge SoundWorks.

PlayWorks™ PS2000 Digital



Thank you for buying PlayWorks PS2000 Digital by Cambridge SoundWorks, a revolutionary two piece Dolby® Digital speaker solution for PlayStation 2™.

Contents

Inventory	5
Speaker System Connections	6
Signal Source Connections	6
System Connection Diagram	7
Dipole Unit Stand Installation	8
Speaker Placement	9
System Functions	11
Surround Reference	14
Applications	15
EAX	16
Specifications	16
Technical Support	17
Limited Warranty	20

Inventory

Examine each unit carefully for shipping damage. If there is any, do not install or use the system. Contact the retailer where the system was purchased. Save the shipping carton and inserts in case you have to transport the system later.



Subwoofer

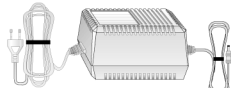

15V 3A DC Power Adapter



Remote Control



Optical Cable



Tandem Audio Cable



SPDIF Cable (RCA to RCA)



Dual RCA to RCA Cable

Paste this behind the Remote Control.

Paste this on the side of the Dipole Unit.



LED Indicator Labels



Dipole Unit

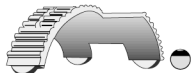

Dipole Unit Stand and Ball-fastener



"AA"- Size Battery (2)



Dual Female RCA Adapter



Stereo to Dual RCA Cable



Dipole DIN Cable

Speaker System Connections Signal Source Connections

Speaker Connections

Using the Dual RCA to RCA plug, connect the R (right) and L (left) Speaker inputs located on the back panel of the Dipole Unit to the corresponding Speaker outputs on the Subwoofer.

Using the Dipole DIN cable, connect the DIN jack of the Dipole Unit to the DIN jack of the Subwoofer.

For information on connections to signal sources, refer to "System Connection Diagram" on page 7.

Power Supply Adapter Connections

Confirm the power switch on the Subwoofer is in the "OFF" position. Insert the Power Adapter's AC plug into an appropriate receptacle. Insert the small DC connector into the **15V DC IN** jack on the back of the Subwoofer.

Dolby Digital source

Connect the Dolby Digital/SPDIF output of your signal source to the Subwoofer's **Dolby Digital (AC-3) SPDIF IN** jack using the **SPDIF Cable (RCA to RCA)** or the **Optical Cable**.

Game consoles

Connect the optical output of the game console (e.g. PlayStation 2) to the **Optical** input with the **Optical Cable**.

If the optical connection is not available or is being utilized, use the **Stereo to Dual RCA Cable** and the **Dual Female RCA Adapter** to connect to the game console's RCA output of the multiple A/V plug.

For devices with optical output

Connect the optical output of these devices (e.g. CD or MD players) to the **Optical** input with the **Optical Cable**.

Note: Optical connections have priority over coaxial (SPDIF RCA to RCA) connections.

For all other sound cards

Use the **Tandem Audio Cable**. Connect the lime-green stereo miniplugs from the Line Out minijack output of your sound card to the **Line In** minijack input of the Subwoofer. Connect the black stereo miniplugs from the Rear Out minijack output of your sound card (if present) to the **Rear In** minijack input of the Subwoofer.

System Connection Diagram

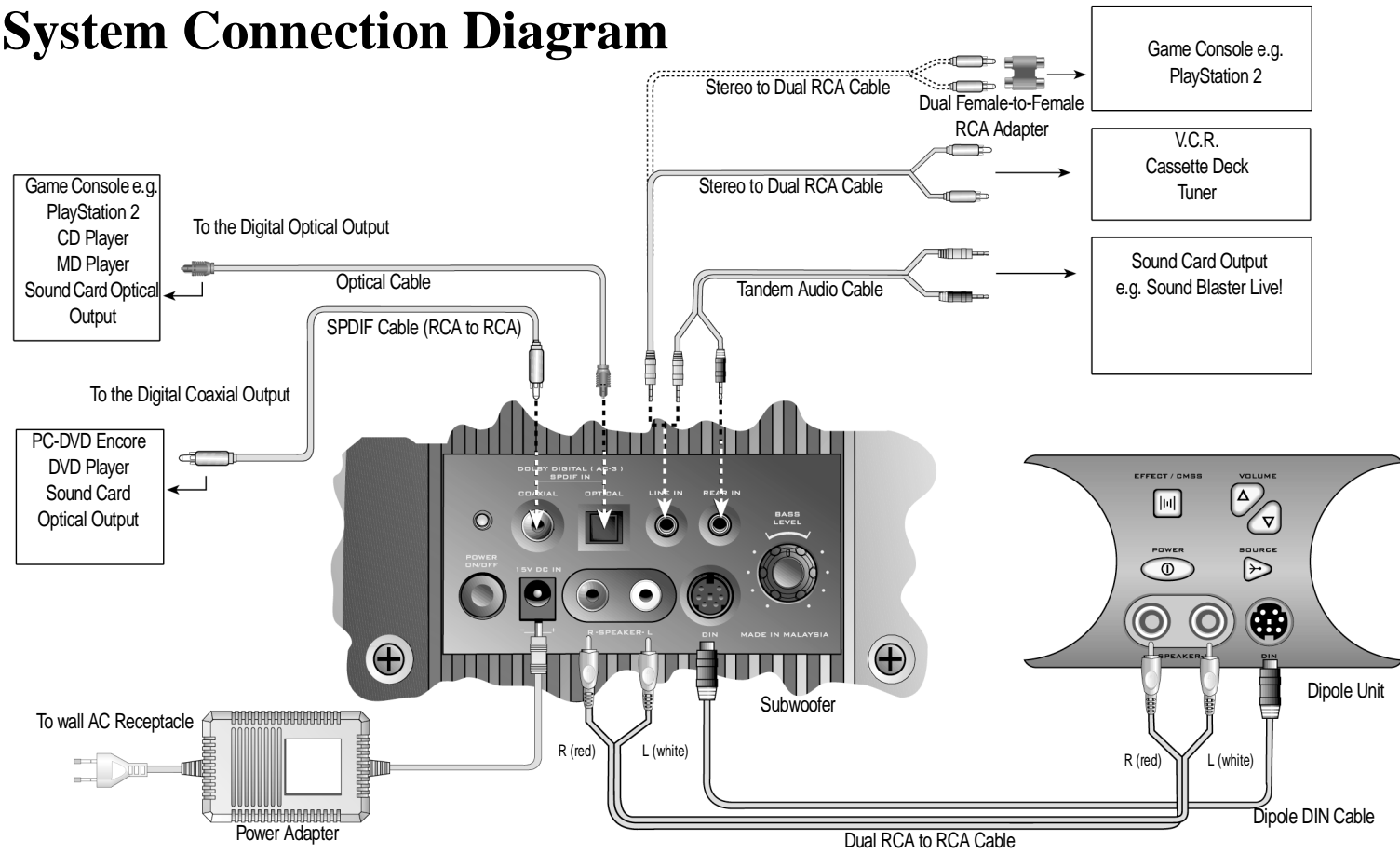

Dipole Unit Stand Installation

Dipole Unit Stand

Align the Dipole Unit Stand to the Dipole Unit. Using the Ball-fastener provided, attach the Dipole Unit Stand to the Dipole Unit, (see **diagram A**).

Tilting the Dipole Unit

Loosen the Ball-fastener below the Dipole Unit Stand to adjust the tilt of the Dipole Unit. The Dipole Unit can be angled to face you by moving the Dipole Unit back or forth (see **diagram B**). Tighten the Ball-fastener once the optimum tilt has been achieved (see **diagram C**).

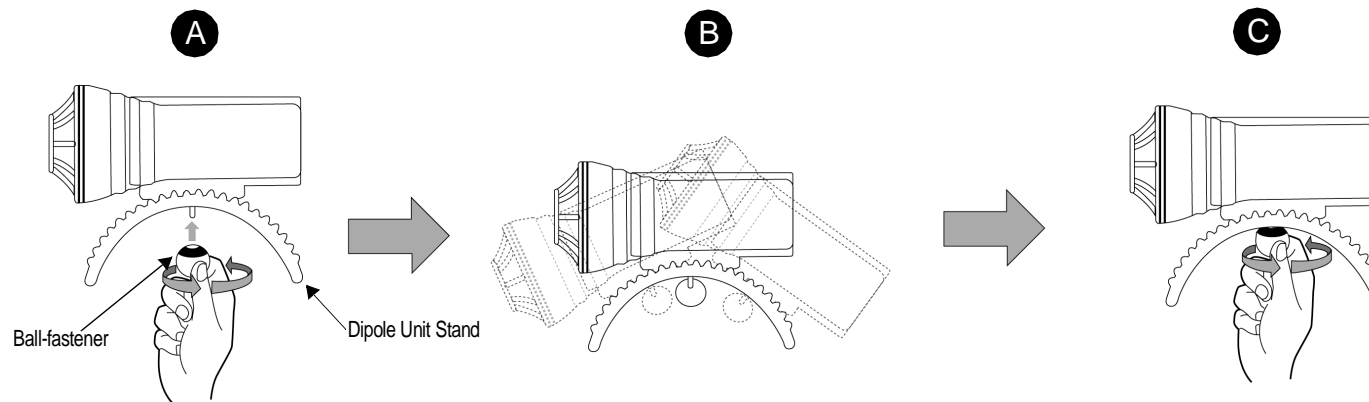

Speaker Placement

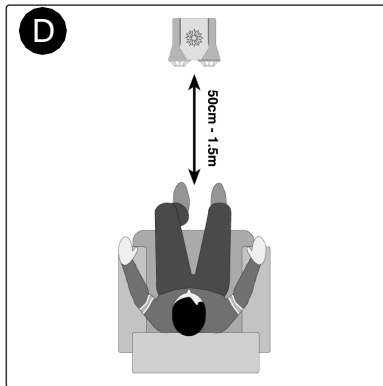

For the best listening effect, place the Dipole Unit between 50cm and 1.5m from the listening position and at ear level if possible.

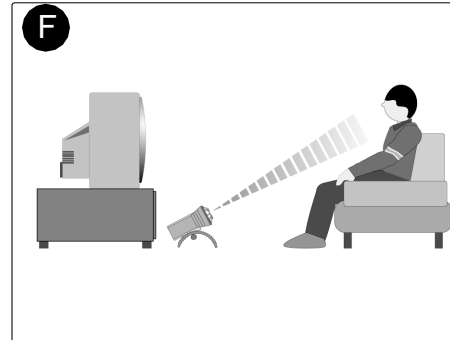

When placing the Dipole Unit in front of the T.V. or monitor, use the Dipole Unit Stand to tilt the unit upwards to your listening position. You can place the Dipole Unit on the floor, coffee table or desktop.

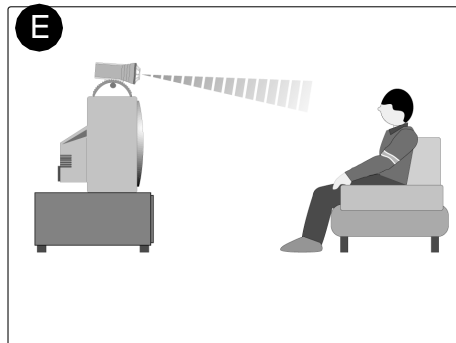

Use the Dipole Unit Stand to tilt the Dipole Unit downwards to your listening position when placing the Dipole Unit on your T.V. or monitor.

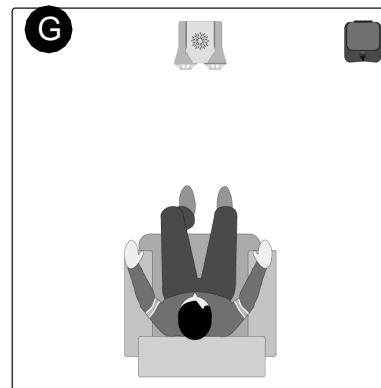

We highly recommend that you place the Subwoofer on the floor, leave at least 5 cm (2 inches) of space between the Subwoofer face and a wall.



Rear Panel of Subwoofer

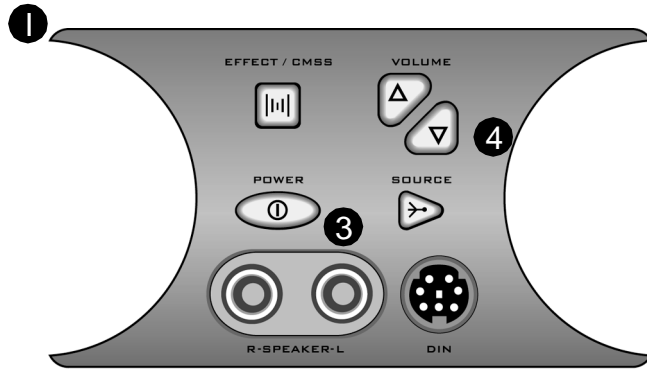

Rear Panel of Dipole Unit

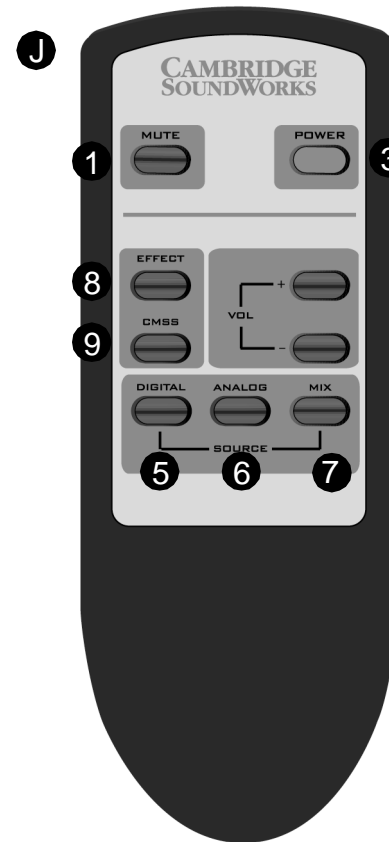

Remote Control

System Functions

1. **MUTE (On Remote Control):** Mutes all output from the *PS2000 Digital*. Press this button once to mute. Press a second time to restore audio output. You can also enable or disable the mute function by pressing both volume buttons on the Dipole Unit together.

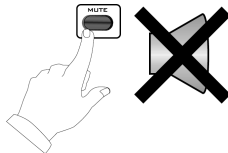

2. **POWER ON/OFF (On Subwoofer):** The POWER button on the Subwoofer controls the power supply input from the Power Adapter. This button must be depressed to activate the Dipole Unit.
3. **POWER (On Remote Control):** The POWER button on the Remote Control and Dipole Unit sets the system to power on and standby mode. When the system is turned on for the first time, the default input mode is "Digital" and the effects selection is "Prism". Subsequently, when the system is turned on from standby mode, the last input mode and effect selection is retained.

4. **VOLUME (On Dipole Unit):** Adjusts the volume of the entire system. Press the UP or DOWN button to increase or decrease the volume. (This function is also available on the Remote Control, use the + or - button)

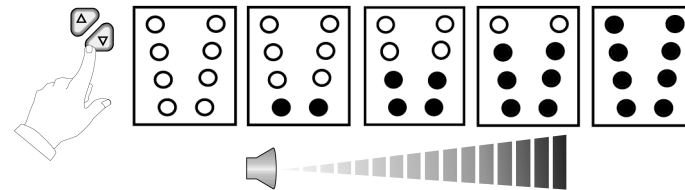

5. **DIGITAL (On Remote Control):** Selects the digital input source signal for the OPTICAL or COAXIAL input. Digital input is the default mode when the system is turned on. Optical input has priority. This button is located on the Remote Control. (This function is also available on the Dipole Unit, use the SOURCE button) The possible digital input signals are; PCM, 2-Ch AC-3 or 5.1 AC-3.

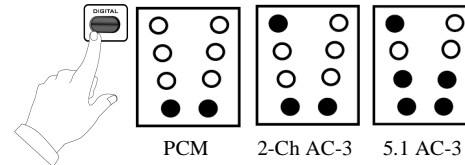

These signals are auto-detected.

6. **ANALOG (On Remote Control):** Selects the analog input source signal from the analog LINE IN input or both the analog LINE IN and REAR IN inputs for FourPointSurround sound. FourPointSurround sound is auto-selected when the front and rear analog inputs are connected. (This function is also available on the Dipole Unit, use the SOURCE button) The possible analog input signals are; Stereo, FourPointSurround (FPS) and CMSS. These signals are auto-detected.

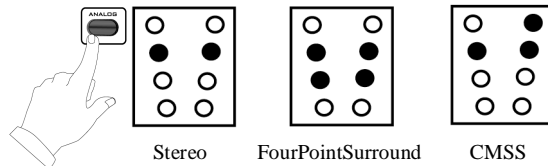

7. **MIX (On Remote Control):** Combines both digital and analog source signals. The LEDs blink when there is no AC-3 signal. (This function is also available on the Dipole Unit, use the SOURCE button) The possible mixed input signals are; Analog + 2-Ch PCM, Analog + 2-Ch AC-3, Analog + 5.1-Ch AC-3. These signals are auto-detected.

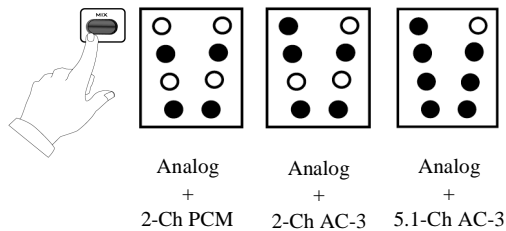

Note: For optimum sound reproduction, choose DIGITAL when connected to digital sources or ANALOG when connected to analog sources.

8. **EFFECT (On Remote Control):** Processes Digital program material. Repeated presses of this button step through five different operation modes: **PASS THROUGH>PRISM>CRYSTAL>GHOST>DIMENSION**. (This function is also available on the Dipole Unit, use the EFFECT/CMSS button)

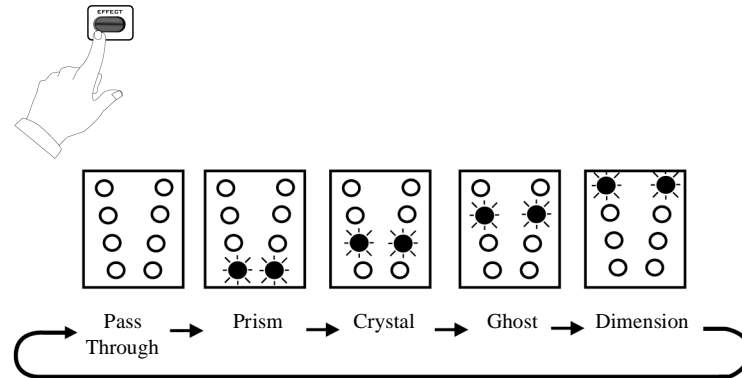

Recommended effects selection for 2-channel source materials:

Prism (default): General purpose including classical music.

Crystal: Jazz or pop.

Ghost: Games.

Dimension: Binaural.

Pass through: System check and Stereo Dipole pre-encoded materials.

Recommended effects selection for 5-channel source materials:

Prism (default): General purpose including music.

Crystal: Drama.

Ghost: Science Fiction or Adventure movies.

Dimension: Games.

Pass through: System check and Stereo Dipole pre-encoded materials.

9. **CMSS (On Remote Control):** CMSS (Creative Multi Speaker Surround) processes analog 2-channel program material. Repeated presses of this button step through two different operation modes: **Music>Movie**. The default mode is CMSS Music.

Music: Creates a 5.1 speaker soundfield appropriate for music from any analog sound source.

Movie: Creates a 5.1 speaker soundfield appropriate for movie or game enjoyment from an analog sound source. (This function is also available on the Dipole Unit, use the EFFECT/CMSS button)

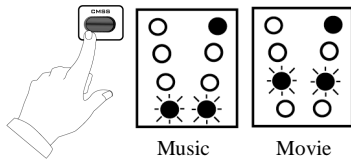

10. BASS LEVEL (On Subwoofer):

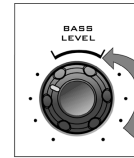

Turn the Bass Level knob counter-clockwise to reduce the bass output.

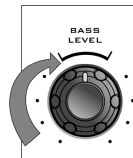

Turn the Bass Level knob clockwise to increase the bass output.

Surround Reference

Dolby Digital

Dolby Digital (earlier called AC-3) delivers five discrete full-range channels (left front, center, right front, left surround and right surround) plus a separate Low Frequency Effects (LFE) channel.

Many soundtracks on the latest generation laser discs, DVDs and High Definition Television (HDTV), are encoded with Dolby Digital technology.

When a 5.1 channel Dolby Digital program source is playing, such as from a game console, Creative PC-DVD player or DVD player, the Dolby Digital indicator light will illuminate automatically.

Note: Not every section of a DVD will be 5.1-channel encoded. On many DVDs, only the main movie program will be available in 5.1 channel sound. Other supporting chapters (like a "Director's Comment" section) may be in stereo or mono. These sections will not light the Dolby Digital indicator even though the sound will be properly reproduced by the *PS2000 Digital*.

Creative Multi Speaker Surround (CMSS)

CMSS is a 2-channel to 5.1-channel sound processor similar in some aspects to a Dolby Surround Pro Logic processor.

The Music and Movie modes create a virtual 5.1 audio experience.

Applications

The *PS2000 Digital* supports many signal source inputs, both analog and digital. For example:

1. Game consoles like the PlayStation 2 using the Optical or Line In connections.
2. DVD players with Dolby Digital (AC-3) optical outputs. DVD players with coaxial outputs (for example, the Creative labs PC-DVD Encore) may also be used.
3. Sound cards that support DirectSound®3D sound processing, including front and rear 2-channel minijack line outputs (like Sound Blaster Live! series or Creative Labs Sound Blaster PCI series).
4. Conventional 2-channel sound cards such as Sound Blaster 16 or the Sound Blaster AWE series can also be used with the *PS2000 Digital*, but these cards will not provide rear channel output when playing games using DirectSound®3D or its derivatives.

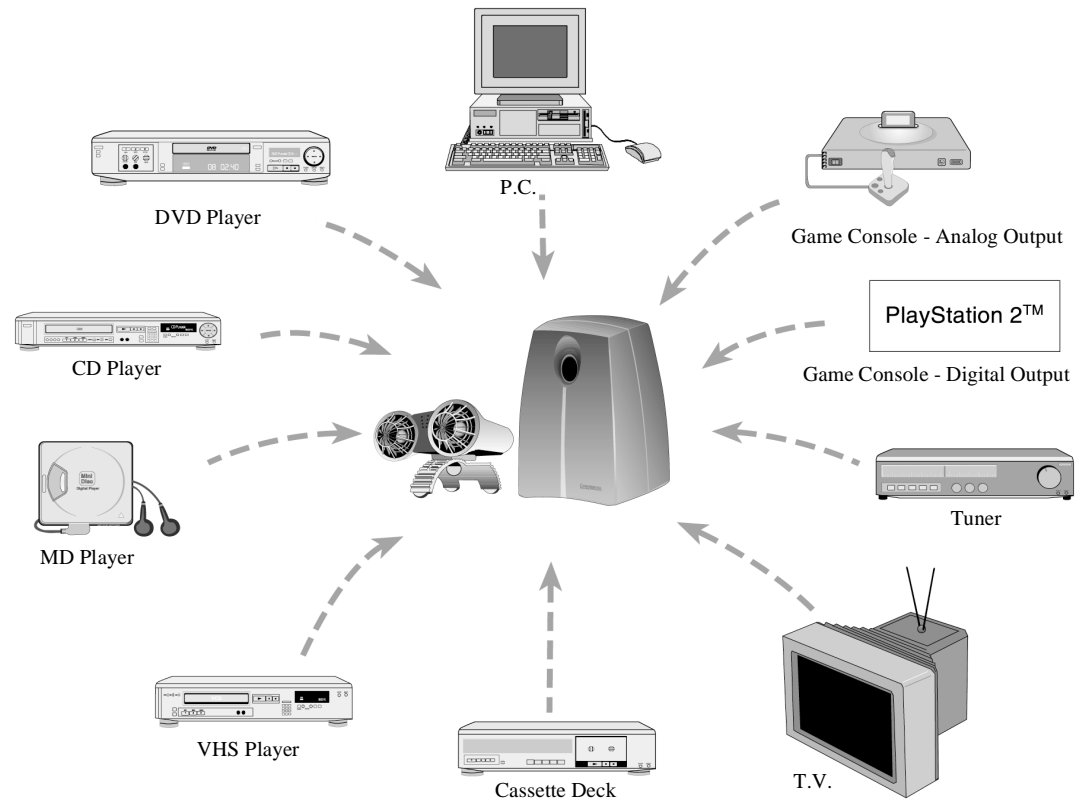

Specifications



PlayWorks PS2000 Digital

Dipole:
10 watts RMS

Subwoofer:
12 watts RMS

These specifications apply to *PS2000 Digital* operating from the supplied 15V 3A DC power adapter.

EAX is a collection of powerful, innovative audio technologies. Developed by Creative's world-class audio scientists and built into groundbreaking Personal Digital Entertainment (PDE) solutions, EAX is changing the way audio is experienced.

EAX offers advanced, interactive audio and high-definition sound to a new generation of portable audio appliances, audio applications, and internet services. Advanced technologies for incredible, cutting edge audio are built into powerful tools. EAX-enabled products let you shape and customize your audio experience, and include advanced audio features for music composition and sound design.

The PlayWorks PS2000 Digital is a highly affordable and extremely compact Dolby Digital 5.1 speaker solution targeted at PlayStation 2™. Also, when used with a 4 channel PC sound card, or set-top DVD player, the PS2000 Digital delivers a virtual 5.1 experience.

Featuring innovative 5.1 virtualization technology, full Dolby Digital decoding

is possible from the unique all-in-one dipole speaker design plus sub woofer. In addition, when used with a 4-channel sound card such as the Sound Blaster Live!, virtualized rear channels ensure a great listening experience for interactive 3D and EAX-enhanced game titles.

For more information on EAX, be sure to visit EAX.creative.com

Technical Support

We are committed to giving you the best product as well as the best technical support.

Note: Before contacting “European Help Line”, please ensure that you have read the ‘Troubleshooting’ Appendix. The Creative web site at www.creative.com gives you access to the latest drivers and troubleshooting tips.

For fast and efficient Technical Support solutions, please use the Creative Web Support services in the first instance. If your Creative product was pre-installed in your computer, your primary source of technical support is the Personal Computer supplier who provided the system.

The European support area on our web site at www.creative.com is continuously updated and contains the following:

- | | |
|--------------------------------|---|
| FAQ: | Access the latest information on Creative products with advice on how to resolve commonly asked questions |
| Solve Your Own Problem: | Enter keywords to search the comprehensive library of product and technical information |
| Download Drivers: | Quick access to the latest Creative drivers |
| Library: | Find the documents for a wide range of Creative products |
| Email Your Problem: | Complete the technical support web form and submit for a response |
| Telephone Support: | European Telephone Support contact details. See also European Helpline section in manual for contact details. |

If You Have a Problem

Please retain all contents including packaging and proof of purchase until you are fully satisfied with product.

If you have a problem installing or using your Creative product, please use the Creative Web Support and/or Telephone Support services for assistance. Note the following information for reference should you require technical assistance:

- The model and serial number of your Creative product
- Error information on the screen and how it came about
- Information on the adapter cards which may be causing a conflict
- Hardware configuration information such as the base I/O address, IRQ line, DMA channels used
- Motherboard information: BIOS manufacturer/version and chipset manufacturer
- Type and version of your operating system, e.g., DOS 6.0, Windows 3.1x, Windows 95, Windows 98 or Windows NT

If, after using the Creative support services, you believe your Creative product to be defective, you should verify the purchase date and the take the appropriate action as detailed below:

Less than 30 days since date of purchase

Should your store receipt indicate that the product is less than 30 days old, you have the option of returning the full product to the dealer/retailer for a replacement or credit. The 30-day time period may not apply in all instances, so please check the seller's replacement/credit terms.

More than 30 days since date of purchase

Contact European Technical Support to clarify the nature of the problem and to obtain details of our repair returns procedure. Creative Labs requires that all returns for repair/replacement must first be issued with an authorisation number.

Returning a product for repair

- Contact Technical Support to receive your authorisation number for repair/replacement of product.
- Technical Support will communicate how to return the product in question for repair/replacement.
- You should only return the hardware item in question and return it to the address detailed by Technical Support. Please retain all software, accessories and the original packaging.
- Please quote the authorisation number clearly on the outside of the packaging in which you return the hardware item in question.
- Upon receipt of the faulty item, Creative Labs will process your request and arrange a return or replacement.

Creative may replace or repair the product with new or re-conditioned parts, and the faulty parts will become the property of Creative. The warranty period for your repaired/replacement item is 90 days from the date of shipment from Creative, or what is left on the original item's warranty, whichever is longer.

To avoid tariffs when shipping a product to Creative Labs from outside the E.U., you must complete the relevant customs documentation before shipping the product (please allow 30 days).

Limited Warranty

Creative Labs (Ireland) Limited (“Creative”) warrants to you, the original purchaser only, that the hardware product will be free of defects in materials and workmanship for a period of two years after the date of purchase, or such other period as may be expressly specified by Creative or required by applicable law (“Warranty Period”).

Creative’s entire liability and your remedy will be, at Creative’s sole discretion, the repair or replacement (with the same or similar model) of any hardware or accompanying item(s) not meeting the “Limited Warranty” explained above that is returned to Creative’s authorised distributor or dealer during the Warranty Period with a copy of your receipt.

What this warranty does not cover

Note: This warranty gives you specific legal rights. You may have other rights which vary from country to country. Certain limitations in this warranty are not permitted by the jurisdiction of some countries, so some limitations here may not apply to you.

To the maximum extent permitted by applicable law, Creative disclaims all other warranties and conditions, expressed or implied, including the conditions of quality, merchantability or fitness for a particular purpose with respect to the use of this product. Creative also disclaims any obligation to support products for all operating environments - for example, by ensuring interoperability with future versions of software or hardware. In no event

shall Creative or its licensors be liable for any indirect, incidental, special or consequential loss or for any lost profits, savings or data arising from or relating to the use of this product, even if Creative or its licensors have been advised of the possibility of such loss.

Specifically, this warranty does not cover failures of the product which result from accident, abuse, misuse, alterations (by persons other than Creative or its authorized repair agents), moisture, corrosive environments, shipping, high voltage surges, or abnormal working conditions. This warranty does not cover normal wear and tear. You are specifically advised to take a backup copy of any software provided with the Creative product for security purposes.

Creative European Help Line

CREATIVE LABS (IRELAND) LTD.,

Technical Support Department,
Ballycoolin Business Park, Blanchardstown, Dublin 15,
Ireland.

Fax: +353 1 8205052

United Kingdom

Tel +44 1189 344 744

Germany

Tel +49 69-66982900

Ireland

Tel +353 1 820 7555

France

Tel +33 1 55 46 87 77

Spain

Tel +34 (91) 66 25 116

Italy

Tel +39 02 4828 0000

Austria

Tel +43 (01) 589 244 320

Belgium

Tel +32 (02) 7171 198

Denmark

Tel +45 3525 9498

Finland

Tel +358 (09) 2294 3101

Norway

Tel +47 2305 0401

Sweden

Tel +46 (08) 7519 147

Holland

Tel +31 (0) 205040616

Switzerland

Tel +41 (01) 2121 868

Portugal

Tel 800 8 53066

Czech Republic

Tel +353 1 8066964

Poland

Freephone 00 800 353 1229

Hungary

Freephone 06 800 1222

Russia

Tel +353 1 8066967

Operating Hours / Heures d'ouverture / Öffnungszeiten / Ore d'ufficio / Horario de oficina / Openingstijden / Horário de abertura

EUROPE

Mon-Fri	:	Business Hours	Sat-Sun & Public Holidays	:	Closed
Lun. au vend.	:	Heures de bureau	Sam., dim. et jours fériés	:	Fermé
Mo-Fr	:	Geschäftszeiten	Sa, So & gesetzl. Feiertage	:	Geschlossen
Lunedì-venerdì	:	Orario d'ufficio	Sabato, domenica e festivi	:	Chiuso
Lunes-Viernes	:	Horario de oficina	Sábados, domingos y festivos	:	Cerrado
Maandag-Vrijdag	:	Kantooruren	Zat.-Zon. & Nationale Feestdagen	:	Gesloten
Segunda a sexta-feira	:	Horário de expediente	Sábado, domingo e feriados	:	Fechado

Internet To receive technical support via the Internet, please e-mail: support@europe.creative.com

Web Site www.creative.com

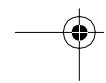
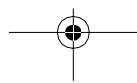
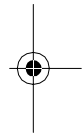
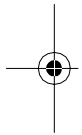
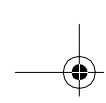

Free Manuals Download Website

<http://myh66.com>

<http://usermanuals.us>

<http://www.somanuals.com>

<http://www.4manuals.cc>

<http://www.manual-lib.com>

<http://www.404manual.com>

<http://www.luxmanual.com>

<http://aubethermostatmanual.com>

Golf course search by state

<http://golfingnear.com>

Email search by domain

<http://emailbydomain.com>

Auto manuals search

<http://auto.somanuals.com>

TV manuals search

<http://tv.somanuals.com>