

# Bushnell

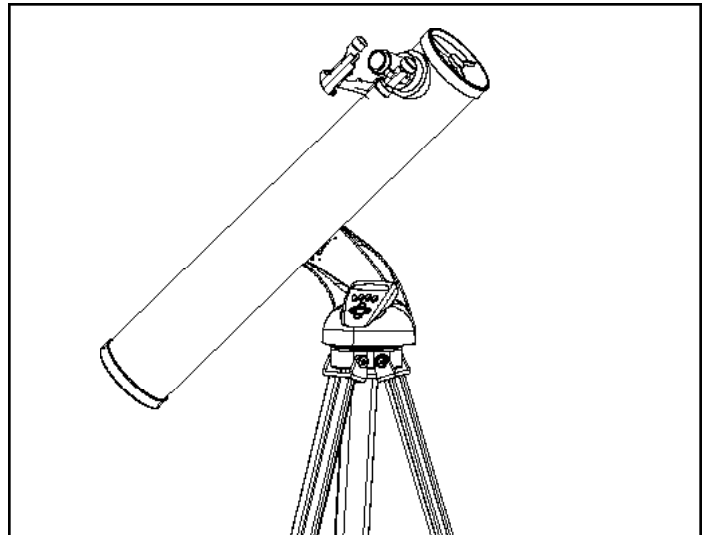

## Instruction Manual

**78-8830 76mm Reflector**



**78-8845 114mm Reflector**

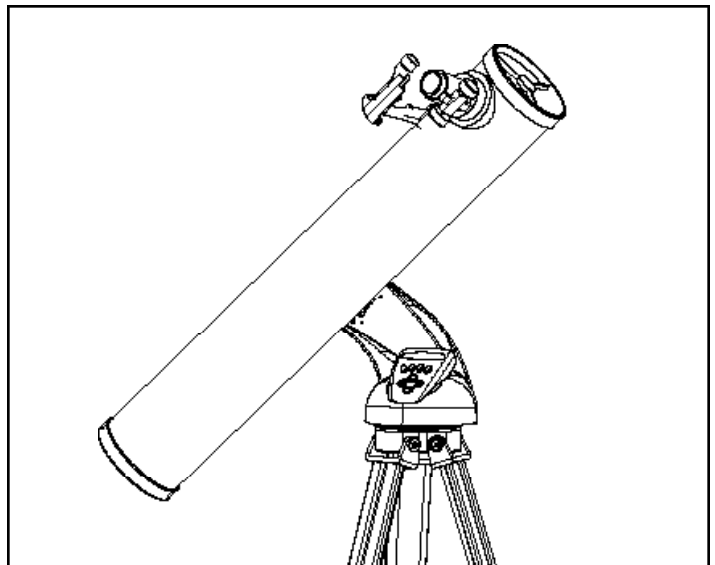

Lit.#: 91-0265/08-01

→  ←

Never Look Directly At The Sun  
With Your Telescope

Permanent Damage To Your Eyes  
May Occur



## WHERE DO I START?

Your Bushnell telescope can bring the wonders of the universe to your eye. While this manual is intended to assist you in the set-up and basic use of this instrument, it does not cover everything you might like to know about astronomy. Although Northstar will give a respectable tour of the night sky, it is recommended you get a very simple star chart and a flashlight with a red bulb or red cellophane over the end. For objects other than stars and constellations, a basic guide to astronomy is a must. Some recommended sources appear on our website at [www.bushnell.com](http://www.bushnell.com). Also on our website will be current events in the sky for suggested viewing. But, some of the standbys that you can see are:

**The Moon**—a wonderful view of our lunar neighbor can be enjoyed with any magnification. Try viewing at different phases of the moon. Lunar highlands, lunar maria (lowlands called "seas" for their dark coloration), craters, ridges and mountains will astound you.

**Saturn**—even at the lowest power you should be able to see Saturn's rings and moons. This is one of the most satisfying objects in the sky to see simply because it looks like it does in pictures. Imagine seeing what you've seen in textbooks or NASA images from your backyard!

**Jupiter**—the largest planet in our solar system is spectacular. Most noted features are its dark stripes or bands both above and below its equator. These are the north and south equatorial belts. Also interesting are Jupiter's four major moons. Pay close attention to their positions from night to night. They appear to be lined up on either side of Jupiter.

**Mars**—The Great Red Planet appears as a reddish-orange disk. Look at different times of the year and try to catch a glimpse of the white polar ice caps.

**Venus**—just like the moon, Venus changes phases from month to month. At times Venus appears brilliantly in the night sky, just as if you were looking at a distant crescent moon.

**Nebulae**—The Great Orion Nebula is a very well known night sky object. This and many others are brought to you by this telescope.

**Star Clusters**—View millions of stars densely packed in a cluster that resembles a ball.

**Galaxies**—One of the greatest and most interesting galaxies is our neighbor the Andromeda Galaxy. Enjoy this and many others.

## Parts Diagrams

### 78-8830 76mm and 78-8845 114mm Reflectors

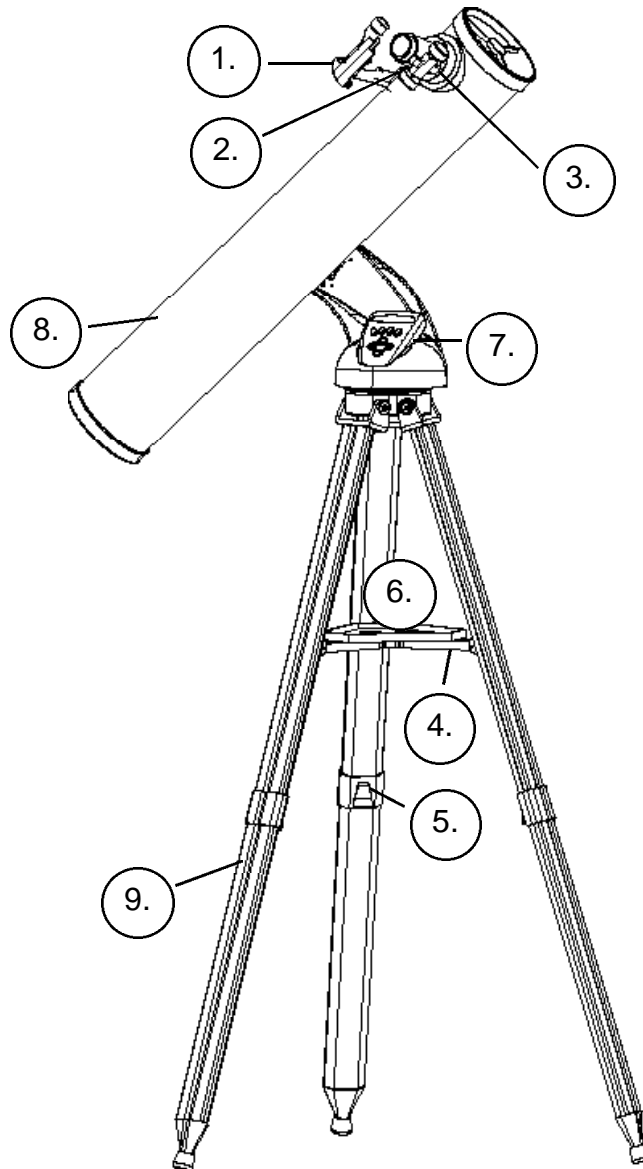

## Telescope Parts Diagram

- |                                       |   |
|---------------------------------------|---|
| 1. Red Dot Finderscope                | 6. Quick-Release Accessory Tray             |
| 2. 1.25" Format Eyepiece              | 7. Remote Computer Controller               |
| 3. Rack and Pinion Focusing Mechanism | 8. Main Telescope Tube                      |
| 4. Accessory Tray Brace               | 9. Quick-Release Adjustable Aluminum Tripod |
| 5. Quick-Release Tripod Leg Lever     |   |

## QUICK ASSEMBLY DIAGRAM

78-8830 76mm and 78-8845 114mm Reflectors

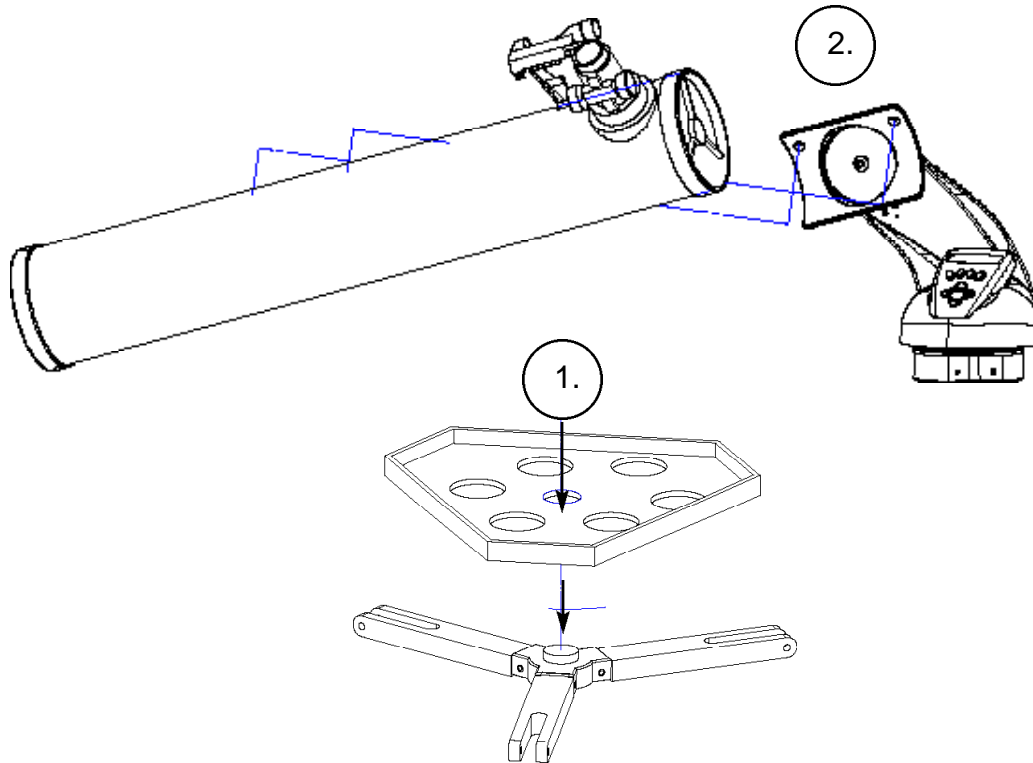

## PARTS LIST

- Adjustable Aluminum Tripod Assembly  
(Pre-assembled to Northstar Computerized Star Locator Base)
- Quick Release Accessory Tray
- Northstar Telescope with finger attachment nuts
- Red Dot Finderscope
- 20mm 1.25" Diameter Eyepiece
- 4mm 1.25" Diameter Eyepiece
- Barlow Lens

## DETAILED ASSEMBLY

No tools are required for assembly of your telescope.

Remove all components from the carton and identify all components. It is a good idea to lay all the parts out in front of you before assembly. Since your telescope is a precision optical system the parts require careful handling—particularly the onboard computer, telescope, eyepieces, and various accessory lenses.

### SET UP TRIPOD AND ACCESSORY TRAY

1. Stand Northstar Computerized Star Locator Assembly and attached tripod legs in the upright position. Spread tripod legs to a comfortable distance.
2. Fold down the accessory tray braces and place the Quick Release Accessory Tray on top of braces. (See Quick Assembly Diagram)
3. Turn accessory tray until it snaps into place.
4. Adjust tripod leg height to suit by opening tripod leg lever and extending tripod legs to desired height. Clamp Tripod Leg lever closed when complete.

### ATTACH TELESCOPE TUBE

1. Locate Main Telescope Tube.
2. Remove Telescope Tube Thumb Nuts from side of Telescope Tube. (See Quick Assembly Diagram)
3. Position Main Telescope Tube Attachment Bolts through Telescope Tube Bracket at the top of the Northstar Computerized Star Locator Assembly. Make sure the telescope is pointing in the correct direction. (Logo on telescope tube should be right-side up.)
4. Reattach Telescope Tube Thumb Nuts to Main Telescope Tube Attachment Bolts once Main Telescope Tube and Northstar Computerized Star Locator Assembly are assembled together.

### ATTACH FINAL TELESCOPE ACCESSORIES

1. Locate Red Dot Finderscope.

**For Reflector Telescopes:** Remove Finderscope attachment nuts from Main Telescope Tube. Place Finderscope Assembly over Finderscope Attachment Bolts and reattach Finderscope thumb nuts to Finderscope Mount Bolts.

**NOTE:** The large end of the finderscope should face the open end of telescope tube.

2. Attach Low Power Eyepiece.

**For Reflector Telescope Models:** Insert lowest power eyepiece in the focusing mechanism by backing out eyepiece set screw and inserting eyepiece fully.

3. Tighten all set screws to secure accessories.
4. Remove Objective Dust Cover exposing entire diameter of open end of telescope.

### SELECTING AN EYEPIECE

You should always start viewing with the lowest power eyepiece, which in this case is the 20 mm lens. Note: the base power of each eyepiece is determined by the focal length of the telescope objective lens. A formula can be used to determine the power of each eyepiece: telescope OBJECTIVE lens focal length divided by EYEPIECE focal length = MAGNIFICATION (e.g. Using the 20 mm lens, a sample calculation could look like this:  $750 \text{ mm} / 20 = 38x$  or 38 power. Telescope models will vary in focal length.)

Included with this telescope is a Barlow lens. Barlow lenses are used to double or triple the power of your telescope. Place your Barlow between the focusing tube and the eyepiece. Using the example above, your 3x Barlow lens would give you a total power of 114x or 114 power. ( $38 \times 3 = 114x$  or 114 power). The magnification calculation would look like this:  $750 \text{ mm} / 20\text{mm} = 38 \text{ power}$ .  $38 \text{ power} \times 3 = 114 \text{ power}$ .

6.

## DETAILED ASSEMBLY (CONTINUED)

### FOCUSING TELESCOPE

1. After selecting the desired eyepiece, aim main telescope tube at a land-based target at least 200 yards away (e.g. a telephone pole or building).
2. Fully extend Focusing Tube by turning Rack and Pinion Focusing Mechanism.
3. While looking through selected eyepiece (in this case the 20 mm), slowly retract Focusing Tube by turning Rack and Pinion Focusing Mechanism until object comes into focus.

### ATTACH REMOTE COMPUTER CONTROLLER AND BATTERY

1. Locate Remote Computer Controller and coil cord.
2. Locate Battery Door on Northstar Computerized Star Locator Base.
3. Remove Battery Door and insert one 9V battery.
4. Replace Battery Door.
5. Attach Remote Computer Controller with coil cord to Northstar Computerized Star Locator Base.

### ALIGNING FINDERSCOPE

Look through Main Telescope Tube and establish a well-defined target. (see Focusing Telescope section)

Remove plastic insulator from between Red Dot Finderscope battery and battery clip.

Turn Red Dot Finderscope on.

Looking through Red Dot Finderscope, turn adjustment wheels until the red dot is precisely centered on the same object already centered in Main Telescope Tube's field of view.

Now, objects located first with the Red Dot Finderscope will be centered in the field of view of the main telescope.

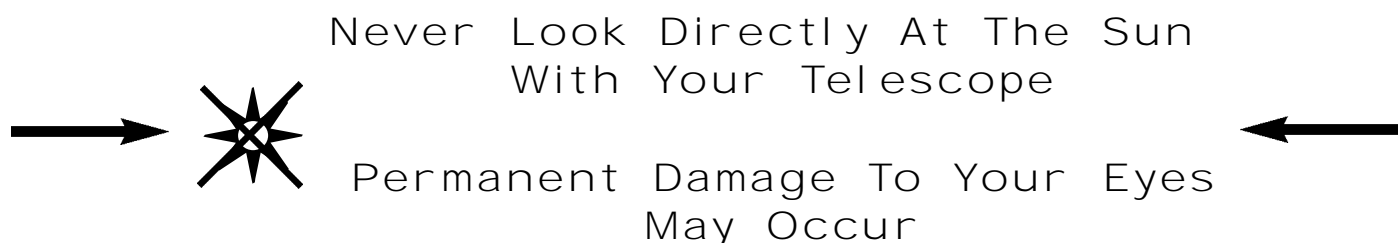

## ENJOYING YOUR NEW TELESCOPE

1. First determine your targeted object. Any bright object in the night sky is a good starting point. One of the favorite starting points in astronomy is the moon. This is an object sure to please any budding astronomer or experienced veteran. When you have developed proficiency at this level, other objects become good targets. Saturn, Mars, Jupiter, and Venus are good second steps to take.
2. The first thing you need to do after assembling the telescope as planned is center the desired object in the finderscope's cross hairs. Provided you did a reasonable job aligning the finderscope, a quick look through the main telescope tube at low power should reveal the same image. With the lowest power eyepiece (the one with the largest number printed on it) you should be able to focus the same image that you saw through the finderscope. Avoid the temptation to move directly to the highest power. The low power eyepiece will give you a wider field of view, and brighter image—thus making it very easy to find your target object. At this point with a focused image in both scopes, you've passed the first obstacle. If you don't see an image after attempting to focus it in, you might consider aligning your finderscope again. Once you pass this step, you'll will enjoy the time spent ensuring a good alignment. Every object you center in the finderscope will be easily found in the main telescope tube, which is important for continuing your exploration of the night sky.
3. The low power eyepieces are perfect for viewing the full moon, planets, star clusters, nebulae, and even constellations. These should build your foundation. However, for more detail, try bumping up in magnification to higher power eyepieces on some of these objects. During calm and crisp nights, the light/dark separation line on the moon (called the "Terminator") is marvelous at high power. You can see mountains, ridges and craters jump out at you due to the highlights. Similarly, you can move up to higher magnifications on the planets and nebulae. Star clusters and individual stars are best viewed through the low power no matter what.
4. The recurring astronomical theater we call the night sky is an ever-changing billboard. In other words, the same movie does not play all the time. Rather, the positions of the stars change not only hourly as they seem to rise and set, but also throughout the year. As the earth orbits the sun our perspective on the stars changes on a yearly cycle about that orbit. The reason the sky seems to move daily just as the sun and the moon "move" across our sky is that the earth is rotating about its axis. As a result you may notice that after a few minutes or a few seconds depending on what power you are viewing at, the objects in your telescope will move. At higher magnifications especially, you will notice that the moon or Jupiter will "race" right out of the field of view. To compensate, just move your telescope to "track" it in the necessary path.



## HELPFUL HINTS

1. Your telescope is a very sensitive instrument. For best results and fewer vibrations set your telescope up on a level location on the ground rather than your concrete driveway or your wooden deck. This will provide a more stable foundation for viewing, especially if you've drawn a crowd with your new telescope.
2. If possible view from a location that has relatively few lights. This will allow you to see much fainter objects. You'd be surprised how much more you'll see from your local lake or park when compared to a backyard in the city.
3. Using your telescope out a window is NEVER recommended.
4. View objects that are high in the sky if possible. Waiting until the object rises well above the horizon will provide a brighter and crisper image. Objects on the horizon are viewed through several layers of earth's atmosphere. Ever wonder why the moon appears orange as it sets on the horizon? It's because you are looking through a considerable more amount of atmosphere than you would directly overhead. (Note: If objects high in the sky are distorted or wavy, you are probably viewing on a very humid night.) During nights of unstable atmosphere, viewing through a telescope can be frustrating if not impossible. Astronomers refer to crisp, clear nights as nights of "good seeing."

## NORTHSTAR COMPUTER INTERFACE DIAGRAM

1. On/Off Button (On Northstar Base)
2. Back Button
3. Enter Button
4. Scroll Up Button
5. Scroll Down Button
6. LCD Display
7. "GO" Button
8. Motorized Movement Buttons (4)
9. Battery Door (On Northstar Base)

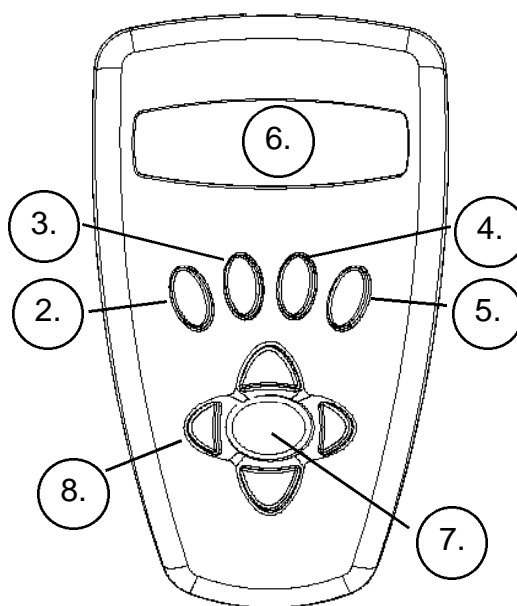

## BUTTON FUNCTIONS

**ALL BUTTONS ARE ILLUMINATED FOR NIGHTTIME USE.**

**On/Off Button:** The On/Off Button will turn the Northstar Computerized Star Locator on and off. This button flashes or strobos on and off during normal use. To turn the unit off, simply depress and hold the On/Off button for three seconds and release. (Note: The Northstar Computerized Star Locator will automatically turn itself off after 10 minutes of inactivity.)

**Back Button:** This button functions to navigate to the previous level within the operating framework and/or back to the previous level of input.

**Enter Button:** This button functions to select certain menu choices. By pressing the ENTER button Northstar will advance to the selected level. When an object name or number is listed on the screen, the ENTER button can also be pressed to display a scrolling text description of the object.

**Scroll Up Button:** This button functions to scroll up through various menus within Northstar. Anytime you encounter a blinking text/number option, the scroll button will display the various choices within that menu. (Note: To select an option that you have scrolled to, just press the ENTER button.)

**Scroll Down Button:** This button functions to scroll down through various menus within Northstar. Anytime you encounter a blinking text/number option, the scroll button will display the various choices within that menu. (Note: To select an option that you have scrolled to, just press the ENTER button.)

**"GO" Button:** The GO button will automatically center any object displayed on the LCD display. By pushing the "GO" button, the telescope will automatically find and follow the selected object until another object is selected and the "GO" button is pushed again.

**Motorized Movement Buttons:** These four multi-directional buttons will allow the user to override the tracking system and move the telescope utilizing the motors manually to another desired location. The longer these buttons are depressed, the faster the Northstar will move until it reaches its maximum speed.

## LCD DISPLAY

The Liquid Crystal Display (LCD) is a two-line, sixteen character display. The LCD is illuminated for use during nighttime viewing just like the buttons.

## MODE OVERVIEW OF PRODUCT

**Explore:** The Explore Mode of Northstar provides the ability to explore various astronomical objects categorized by object type. These objects would fall under one or more of the following types of objects: Deep Sky, Planets, Constellations, and Stars. Each of these subheadings would also have subcategories of objects beneath their menu structure. (See Menu Tree for full list of menu functions and options.)

**Sky Tour:** The Sky Tour Mode of Northstar provides the ability to take a quick tour of the best and brightest objects for any given month of the year. If the date has been input into the system, the Sky Tour Mode will automatically default to that month. Objects can be chosen by using the scroll up or down arrows and pressing ENTER. To find out more information about any given object press the ENTER button while that object is displayed to see the scrolling text message.

**Telescope:** The Telescope Mode of Northstar provides real-time data on where the telescope is pointing. Astronomical Coordinates for Right Ascension (RA) and Declination (DEC) as well as Altitude (ALT) and Azimuth (AZ) are displayed simultaneously. In addition, in the lower right-hand corner will be the abbreviation for the current constellation that the telescope is pointed at.

**Identify:** The Identify Mode of Northstar provides the ability to identify any object within your telescope field of view. Subcategories for different classes of identifiable objects are included as well as an Identify Any option.

**Align Earth:** The Align Earth Mode of Northstar provides the ability to easily align your telescope utilizing common information non-astronomers would readily know. By entering simple information such as time, date, city, etc. a first time telescope user can explore the immense Northstar database of astronomical objects within minutes.

**Align Star:** The Align Star Mode of Northstar provides the ability to align your telescope utilizing some astronomical knowledge. By knowing where two stars are located in the sky, a novice user can circumvent the city, date, and time input and quickly start utilizing the Northstar database to locate amazing astronomical objects.

**Align Object:** The Align Object Mode of Northstar provides the ability to refine your telescope alignment during the middle of your observing session. This might come in very handy if the family dog has just bumped the telescope out of alignment. By using this mode you can center the telescope on any known object and select align object to quickly recalibrate the Northstar alignment allowing continued enjoyment for the duration of the evening.

# MENU TREE

## BUSHNELL NORTHSTAR COMPUTER MENU STRUCTURE (For Step-By-Step Easy Use Refer to Quick Reference Guide)

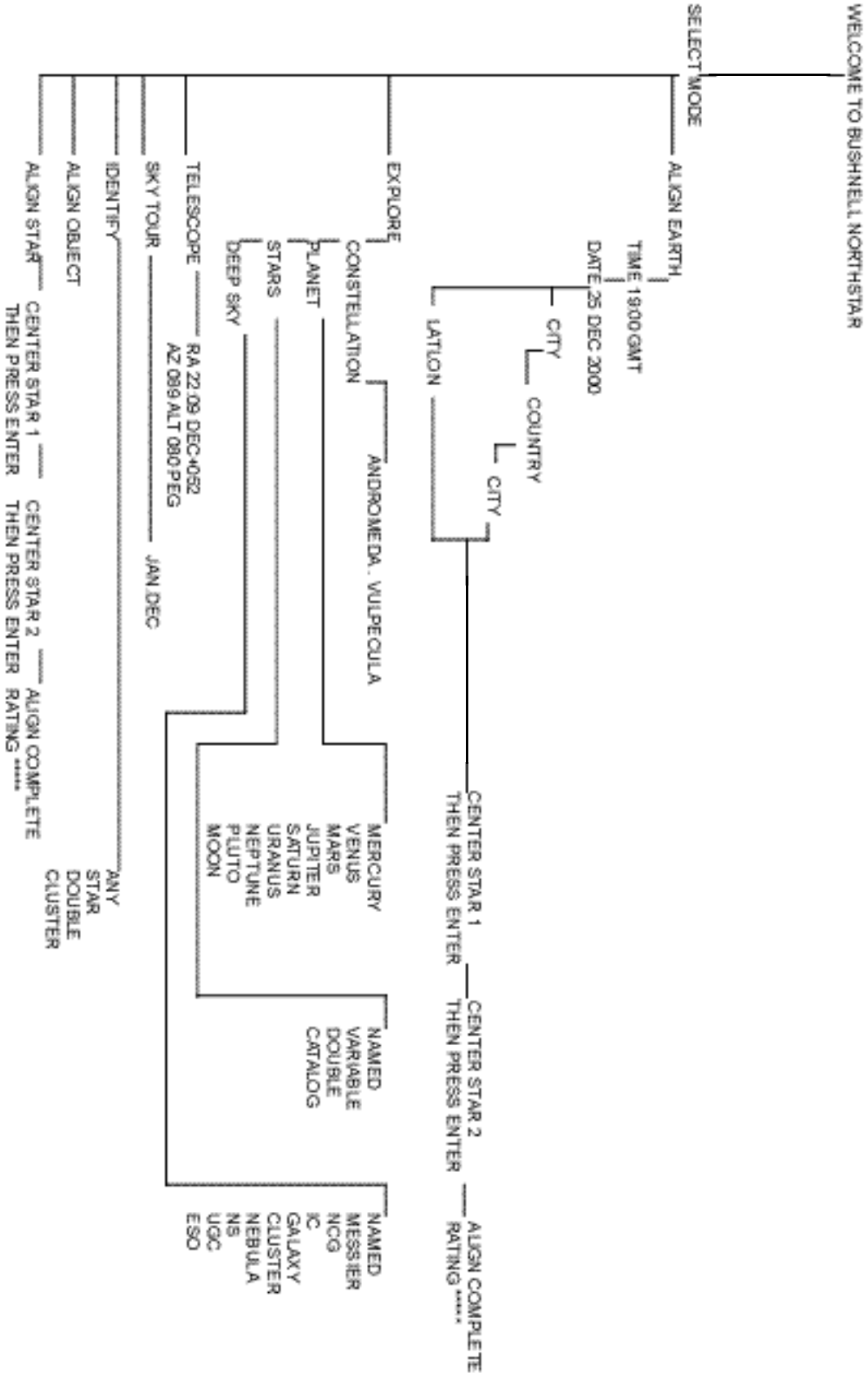

## ALIGNING NORTHSTAR FOR THE FIRST TIME

(NOTE: Make certain that the telescope is set up on a level surface.)

### STEP 1: POINT NORTH

Point the telescope in the direction of North.

NOTE: THE USER SHOULD JUST ATTEMPT TO GET THE TELESCOPE POINTED RELATIVELY CLOSE TO NORTH. THE ALIGNMENT WILL BE REFINED AS WE PROGRESS. HOWEVER, IF YOU CAN FIND THE BIG DIPPER AND USE THE "POINTER STARS", FOLLOW THE ARROW ON THE DIAGRAM TO THE NORTH STAR. THE NORTH STAR LIES DIRECTLY ABOVE DUE NORTH!

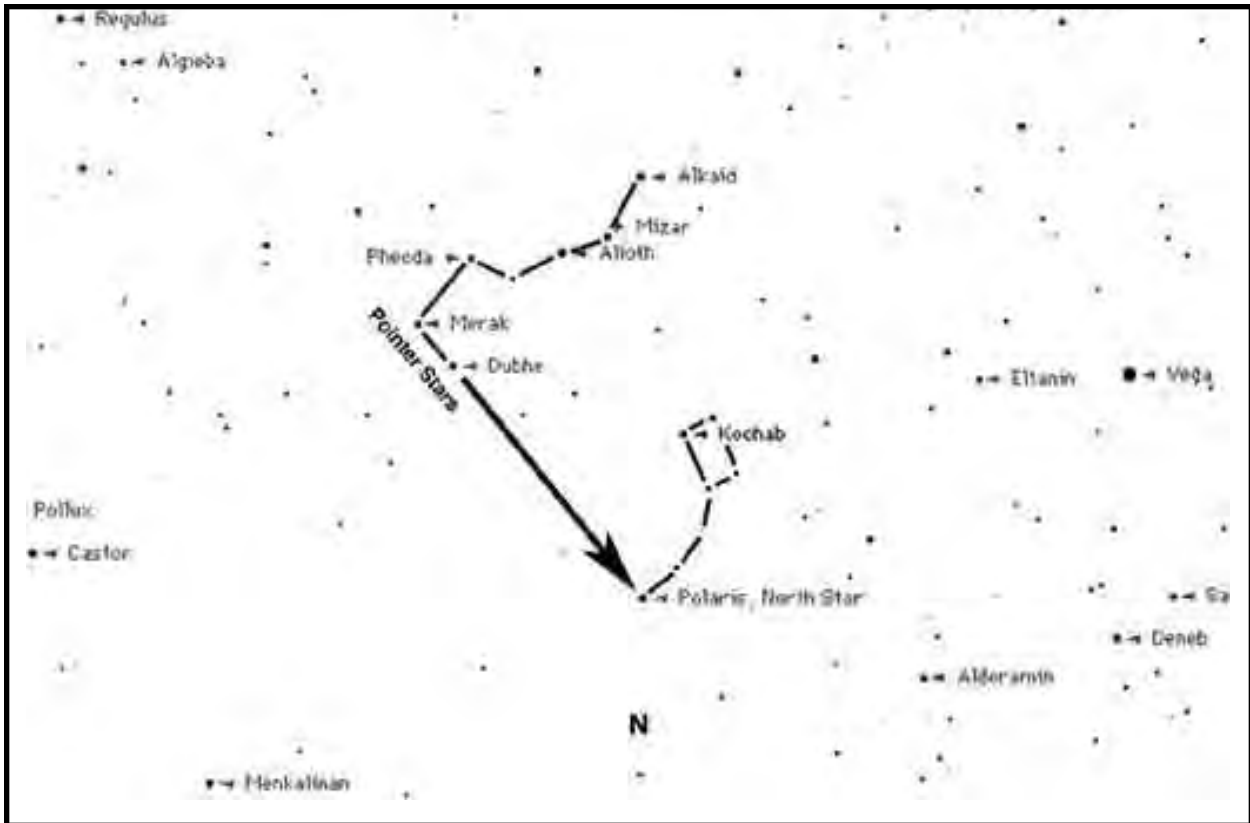

When you turn the telescope on, a scrolling message will appear:

```
BUSHNELL NORTHSTAR Ux.x
```

Following this message, the telescope will execute a diagnostic check and level the telescope tube in relation to the telescope mount.

Then the default menu will appear:

```
SELECT MODE  
ALIGN EARTH 44
```

This mode assumes that even if the telescope user is a first time user and does not know anything about astronomy that they can be successful aligning the telescope in a few simple steps.

The ALIGN EARTH option is flashing.

Press ENTER to choose ALIGN EARTH option.

NOTE: ANY FLASHING ITEM ON THE DISPLAY IS A MENU CHOICE. OTHER CHOICES ARE AVAILABLE BY USING THE SCROLL UP OR SCROLL DOWN BUTTONS.

## ALIGNING NORTHSTAR FOR THE FIRST TIME (Continued)

### **STEP 2: SET THE TIME**

By using the SCROLL UP and SCROLLDOWN buttons and the ENTER button, the time can easily be set as well as the time zone. Each flashing option will need to be changed to read the appropriate number. Once the appropriate number is displayed, accept the number by pressing ENTER. Then set the next flashing option until the time and time zone are set.

### **STEP 3: SET THE DATE**

Again by using the SCROLL UP and SCROLLDOWN buttons and the ENTER button, the date can easily be set. Each flashing option will need to be changed to read the appropriate number or month. Once the appropriate number is displayed, accept the number by pressing ENTER. Then set the next flashing option until the day, month and year are set.

### **STEP 4: SET THE LOCATION**

The next screen will display:

```
ALIGN EARTH  
CITY 44
```

CITY will be flashing. By pressing the ENTER button, the display will change to:

```
C O U  
U . S .
```

The country will be flashing.

Again by using the SCROLL UP and SCROLL DOWN buttons and the ENTER button, the COUNTRY can be chosen. When the appropriate Country is found and the ENTER button is pushed, choose the city that you are closest to by pressing ENTER when it is displayed.

**NOTE: CHOOSE THE CITY CLOSEST TO YOUR VIEWING LOCATION. THIS IS NOT A CRITICAL STEP AND THE ALIGNMENT WILL BE REFINED AUTOMATICALLY AS WE PROGRESS.**

After four simple criteria that any consumer should know, the telescope now knows where over 20,000 astronomical objects are in the night sky to a relative precision. With just two more steps, you will zero in on pinpoint accuracy.

Now the telescope will lead you through a simple two star alignment process. YOU DO NOT NEED TO KNOW WHERE ANY STARS ARE. You just simply follow the directions.

A scrolling message indicates to CENTER STAR 1 THEN PRESS ENTER

Then the display will read:

```
CENTER STAR 1  
41.20 452 MIZAR
```

Push the "GO" button and the telescope will automatically move to the general vicinity of the first guide star--in this case MIZAR

The guide stars will be the brightest stars found in that area of the sky. Northstar will automatically "zero out" the guide star and the display will read:

```
CENTER STAR 1  
0:0 0:0 MIZAR
```

Note as you move from greater than 10 degrees away from an object to under ten degrees, the display moves into tenths of degrees with the arrows acting as decimal points (Example 8:5:8.5 degrees below the object).

After getting the star zeroed in, you need to do as the screen told you—CENTER STAR 1. In other words, the star might appear in the lower left corner of your telescope's eyepiece.

By looking through the eyepiece, center the star in the field of view by using the Motorized Movement Buttons or move the telescope by hand and press ENTER.

## ALIGNING NORTHSTAR FOR THE FIRST TIME (Continued)

The distance the object is from the center is related to how far outside of a city you might be located or how accurately you aligned with north.

Repeat this process for STAR 2 and press ENTER.

After this step is completed, you will see a display that reads:

```
ALIGN COMPLETE
RATING ****
```

(Note: The more stars that appear on the second line of the display the better, up to 5)

After the two star alignment is complete, your Northstar now knows with pinpoint accuracy where all 20,000+ objects are!!

## USING NORTHSTAR FOR THE FIRST TIME

After EARTH ALIGN, the display will then read:

```
SELECT MODE
EXPLORE ++
```

Select EXPLORE by pressing ENTER. SCROLL UP and DOWN to see what flashing menu choices you have. Choose PLANET. These are the most interesting. Even if you are a first time telescope user, PLANET objects can be very exciting.

Press ENTER when the display reads:

```
E X P
P L A
```

This will take you into a list of named PLANET objects. By using the SCROLL UP or SCROLLDOWN buttons, you can explore several items in the object list.

```
P L A
JUPITER ++
```

Press ENTER to choose the PLANET you wish to view. The display will then be:

```
P L A
-120 +52 JUPITER
```

NOTE: IF AN OBJECT IS BELOW THE HORIZON, THE DISPLAY WILL PERIODICALLY DISPLAY THE WORD "HORIZON".

SCROLL UP or SCROLL DOWN to see other PLANETS in the list. Notice the display shows you directions to each object. But what if you are a first time user wanting to find out more about the object? Wouldn't it be nice to know what the object is before moving the telescope?

PRESS ENTER when:

```
P L A
-120 +52 JUPITER
```

any other PLANET item is displayed. You will see a scrolling message telling you the coordinates for the object, how bright it is, how big it is, what its proper name is, what constellation it is in, and a brief description of what the object is. For JUPITER it reads:

```
JUPITER fifth planet from sun.
Largest planet in solar system.
16 moons. Orbit is 11.86 years.
Diameter: 143,000 km. Named for roman king of gods.
```

## USING NORTHSTAR FOR THE FIRST TIME (Continued)

Now imagine that you are a parent trying to impress your children (or vice versa). Ten minutes into your first observing session you are already learning astronomical objects.

This is a great educational tool !!!!

To find the object, just press the "GO" button and that object will be right in the telescope's eyepiece!

By pressing the BACK button, you move back to the previous level each time the button is pressed. Press the button three times and you are back at the main level menu. The display will read:

```
SELECT MODE
EXPLORE ↵
```

SCROLL UP or SCROLL DOWN to select

```
SELECT MODE
SKY TOUR ↵
```

Press ENTER.

This mode will take you through the best and brightest objects for each month. If you have done the ALIGN EARTH alignment and entered the date, it will automatically take you to the current month. Don't know what some of these obscure objects and abbreviations mean? Just press the ENTER key for more information.

Press the BACK button until you get back to the main menu:

```
SELECT MODE
SKY TOUR ↵
```

SCROLLUP or SCROLL DOWN until the display reads:

```
SELECT MODE
IDENTIFY ↵
```

PRESS ENTER

This mode will default to the level

```
IDENTIFY ANY
```

By selecting this option with the ENTER key, it will IDENTIFY the object that you are currently viewing OR the closest object to where your telescope is currently pointed. You also have the options to choose other types of IDENTIFY menus. These will IDENTIFY the closest CLUSTERS, NEBULAS, etc. to your current telescope position.

To select the final mode press ENTER at the display:

```
SELECT MODE
TELESCOPE ↵
```

The display reads something like:

```
RA18:53 DEC+38.7
AZ280 ALT+62 LVR
```

The TELESCOPE mode gives you dynamic real-time information on your telescope's current position in terms of astronomical coordinates. Play around with this mode by moving the telescope around. Notice the three letter abbreviation in the lower right portion of the display. This dynamically displays the current CONSTELLATION that the telescope is pointing at. These names are abbreviated in this mode. Definitions for the abbreviations will be in the catalog index.



# Catalog Index

The following appendix information is more thorough information than that listed in the main instruction manual. For sake of space, the complete 20,000 object catalog is not listed. However, we have included the entire star list and the entire Messier object lists for your information. In addition, the constellation abbreviations are defined that are found in the Northstar system.

# Catalog Index

## CONSTELLATION ABBREVIATIONS

Andromeda (And)	Lacerta (Lac)
Antila (Ant)	Leo (Leo)
Apus (Aps)	Leo Minor (LMi)
Aquarius (Aqr)	Lepus (Lep)
Aquila (Aql)	Libra (Lib)
Ara (Ara)	Lupus (Lup)
Aries (Ari)	Lynx (Lyn)
Auriga (Aur)	Lyra (Lyr)
Bootes (Boo)	Mensa (Men)
Caelum (Cae)	Microscopium (Mic)
Camelopardis (Cam)	Monoceros (Mon)
Cancer (Cnc)	Musca (Mus)
Canes Venatici (CVn)	Norma (Nor)
Canis Major (CMa)	Octans (Oct)
Canis Minor (CMi)	Ophiuchus (Oph)
Capricornus (Cap)	Orion (Ori)
Carina (Car)	Pavo (Pav)
Cassiopeia (Cas)	Pegasus (Peg)
Centaurus (Cen)	Perseus (Per)
Cepheus (Cep)	Phoenix (Phe)
Cetus (Cet)	Pictor (Pic)
Chameleon (Cha)	Pisces (Psc)
Circinus (Cir)	Piscis Austrinus (PsA)
Columbia (Col)	Puppis (Pup)
Coma Berenices (Com)	Pyxis (Pyx)
Corona Australis (CrA)	Reticulum (Ret)
Corona Borealis (CrB)	Sagitta (Sge)
Corvus (Crv)	Sagittarius (Sgr)
Crater (Crt)	Scorpius (Sco)
Crux (Cru)	Sculptor (Scl)
Cygnus (Cyg)	Scutum (Sct)
Delphinus (Del)	Serpens (Ser)
Dorado (Dor)	Sextans (Sex)
Draco (Dra)	Taurus (Tau)
Equuleus (Equ)	Telescopium (Tel)
Eridanus (Eri)	Triangulum (Tri)
Fornax (For)	Triangulum Australe (TrA)
Gemini (Gem)	Tucana (Tuc)
Grus (Gru)	Ursa Major (UMa)
Hercules (Her)	Ursa Minor (UMi)
Horologium (Hor)	Vela (Vel)
Hydra (Hya)	Virgo (Vir)
Hydrus (Hyi)	Volcans (Vol)
Indus (Ind)	Vulpecula (Vul)

# Catalog Index

NAME - NAME

RA - RIGHT ASCENSION (hours min.min)

DEC - DECLINATION (degrees)

MAG - MAGNITUDE

SIZE - SIZE

CON - CONSTELLATION

## Messier Catalog

MESSIER CATALOG	NAME	RA	DEC	MAG	SIZE	CON	DESCRIPTION	
M001	Crab nebula supernova remnant	NGC 1952	05 34.5	+22.0	8.4	6'	Tau	nebula
M002		NGC 7089	21 33.5	-0.8	6	7'	Aqr	globular cluster highly resolved
M003		NGC 5272	13 42.2	+28.4	6	18'	Cvn	globular cluster highly resolved
M004		NGC 6121	16 23.6	-26.5	5.9	26'	Sco	globular cluster highly resolved
M005		NGC 5904	15 18.6	+02.1	6.2	13'	Ser	globular cluster highly resolved
M006	butterfly	NGC 6405	17 40.1	-32.2	4.6	25'	Sco	open cluster rich
M007		NGC 6475	17 53.9	-34.8	5	1°	Sco	open cluster bright scattered
M008	Lagoon	NGC 6523	18 03.8	-24.4	5	80'	Sgr	nebula with dust and cluster
M009		NGC 6333	17 19.2	-18.5	8	9'	Oph	globular cluster mottled
M010		NGC 6254	16 57.1	-4.1	7	8'	Oph	globular cluster highly resolved
M011	wild duck	NGC 6705	18 51.1	-6.3	6	12'	Sct	open cluster dense
M012		NGC 6218	16 47.2	-2	8	10'	Oph	globular cluster highly resolved
M013		NGC 6205	16 41.7	+36.5	5.7	23'	Her	globular cluster highly resolved
M014		NGC 6402	17 37.6	-3.3	9	6'	Oph	globular cluster
M015		NGC 7078	21 30.0	+12.2	6.5	10'	Peg	globular cluster highly resolved
M016	Eagle	NGC 6611	18 18.8	-13.8	6	7'	Ser	nebula with dust and cluster
M017	Swan	NGC 6618	18 20.8	-16.2	6	45'	Sgr	nebula
M018		NGC 6613	18 19.9	-17.1	8	7'	Sgr	open cluster bright scattered
M019		NGC 6273	17 02.6	-26.3	7	5'	Oph	globular cluster
M020	Trifid	NGC 6514	18 02.6	-23	6.3	25'	Sgr	nebula with dust
M021		NGC 6531	18 04.6	-22.5	7	10'	Sgr	open cluster rich
M022		NGC 6656	18 36.4	-23.9	6	18'	Sgr	globular cluster highly resolved
M023		NGC 6494	17 56.8	-19	7	30'	Sgr	open cluster dense
M024	small star cloud		18 15.9	-18.5	0	1.5°	Sgr	open cluster bright scattered
M025		IC 4725	18 31.6	-19.3	6	20'	Sgr	scattered group of stars
M026		NGC 6694	18 45.2	-9.4	9.5	9'	Sct	open cluster rich
M027	Dumbell	NGC 6853	19 59.6	+22.7	8	8'	Vul	planetary nebula irregular
M028		NGC 6626	18 24.5	-24.9	8	6'	Sgr	globular cluster highly resolved
M029		NGC 6913	20 23.9	+38.5	7	7'	Cyg	open cluster bright scattered
M030		NGC 7099	21 40.4	-23.2	8	6'	Cap	globular cluster highly resolved
M031	Great Andromeda Galaxy	NGC 224	00 42.7	+41.3	3.4	3°	And	very elongated galaxy dusty with bright core
M032		NGC 221	00 42.7	+40.9	8.2	8'	And	round galaxy with bright core
M033	Pinwheel	NGC 598	01 33.9	+30.7	5.7	60'	Tri	spiral galaxy structure with bright knots
M034		NGC 1039	02 42.0	+42.8	5.2	30'	Per	open cluster rich
M035		NGC 2168	06 08.9	+24.3	5.1	30'	Gem	open cluster rich
M036		NGC 1960	05 36.1	+34.1	6	12'	Aur	open cluster rich
M037		NGC 2099	05 52.4	+32.6	5.6	24'	Aur	open cluster dense
M038		NGC 1912	05 28.7	+35.8	6.4	21'	Aur	open cluster rich
M039		NGC 7092	21 32.2	+48.4	5	30'	Cyg	open cluster bright scattered
M040	Winnecke 4		12 19.8	+58.3	9	50"	UMa	double star
M041		NGC 2287	06 47.0	-20.7	4.5	38'	Cma	open cluster dense
M042	Great Orion nebula	NGC 1976	05 35.4	-5.5	4	1°	Ori	nebula
M043		NGC 1982	05 35.6	-5.3	9	20'	Ori	nebula bright with dust
M044	Behive	NGC 2632	08 40.1	+20.0	3.1	1.5°	Cnc	open cluster bright scattered
M045	Pleiades	Pleiades	03 47.0	+24.1	1.5	1.5°	Tau	scattered group of stars
M046		NGC 2437	07 41.8	-14.8	6.1	27'	Pup	open cluster dense
M047		NGC 2422	07 36.6	-14.5	4.4	30'	Pup	open cluster dense
M048		NGC 2548	08 13.8	-5.8	5.8	40'	Hya	open cluster rich
M049		NGC 4472	12 29.8	+08.0	8.4	8'	Vir	round galaxy with bright core
M050		NGC 2323	07 03.2	-8.3	6	20'	Mon	open cluster rich
M051	Whirlpool	NGC 5194	13 29.9	+47.2	8.1	11'	Cvn	spiral galaxy structure attached companion
M052		NGC 7654	23 24.2	+61.6	7	12'	Cas	open cluster dense
M053		NGC 5024	13 12.9	+18.2	8	10'	Com	globular cluster highly resolved
M054		NGC 6715	18 55.1	-30.5	9	6'	Sgr	globular cluster mottled
M055		NGC 6809	19 40.0	-31	7	15'	Sgr	globular cluster highly resolved
M056		NGC 6779	19 16.6	+30.2	8	5'	Lyr	globular cluster highly resolved
M057	Ring	NGC 6720	18 53.6	+33.0	9.7	80"	Lyr	planetary nebula ring with central star
M058		NGC 4579	12 37.7	+11.8	9.8	5'	Vir	round galaxy with bright core

M059		NGC 4621	12 42.0	+11.7	9.8	2'	Vir	elongated galaxy with bright core
M060		NGC 4649	12 43.7	+11.6	8.8	3.5'	Vir	round galaxy with bright core
M061		NGC 4303	12 21.9	+04.5	9.7	5'	Vir	spiral galaxy structure
M062		NGC 6266	17 01.2	-30.1	6.5	9'	Oph	globular cluster
M063	Sunflower	NGC 5055	13 15.8	+42.0	8.6	9'	Cvn	elongated galaxy with bright core
M064	Black eye	NGC 4826	12 56.7	+21.7	8.6	7.5'	Com	elongated galaxy dusty
M065	Leo triplet	NGC 3623	11 18.9	+13.1	9.3	10'	Leo	very elongated galaxy with bright core
M066	Leo triplet	NGC 3627	11 20.2	+13.0	9	9'	Leo	spiral galaxy structure
M067		NGC 2682	08 50.4	+11.8	7	30'	Cnc	open cluster dense
M068		NGC 4590	12 39.5	-26.8	8	9'	Hya	globular cluster highly resolved
M069		NGC 6637	18 31.4	-32.4	7.5	4'	Sgr	globular cluster
M070		NGC 6681	18 43.2	-32.3	8	4'	Sgr	globular cluster
M071		NGC 6838	19 53.8	+18.8	9	6'	Sge	globular cluster highly resolved
M072		NGC 6981	20 53.5	-12.5	8.6	3'	Aqr	globular cluster
M073		NGC 6994	20 59.0	-12.6	8.9	?	Aqr	asterism
M074		NGC 628	01 36.7	+15.8	9.2	10'	Psc	spiral galaxy structure
M075		NGC 6864	20 06.1	-21.9	8	3'	Sgr	globular cluster unresolved
M076	little dumbbell	NGC 650	01 42.4	+51.6	10.1	2'	Per	planetary nebula irregular
M077		NGC 1068	02 42.7	-0.1	8.8	7'	Cet	round galaxy with bright core
M078		NGC 2068	05 46.7	+00.1	8	8'	Ori	reflection nebula bright
M079		NGC 1904	05 24.5	-24.6	8.4	7.5'	Lep	globular cluster highly resolved
M080		NGC 6093	16 17.0	-23	7.2	9'	Sco	globular cluster mottled
M081	Bodes nebula	NGC 3031	09 55.6	+69.1	6.9	26'	Uma	spiral galaxy structure
M082		NGC 3034	09 55.8	+69.7	8.4	9'	Uma	very elongated galaxy with dust and bright knots
M083		NGC 5236	13 37.0	-29.9	8	10'	Hya	barred spiral galaxy structure
M084		NGC 4374	12 25.1	+12.9	9.3	4'	Vir	round galaxy with bright core
M085		NGC 4382	12 25.4	+18.2	9.3	5'	Com	round galaxy with bright core
M086		NGC 4406	12 26.2	+13.0	9.2	7'	Vir	round galaxy with bright core
M087		NGC 4486	12 30.8	+12.4	8.6	7'	Vir	round galaxy with bright core
M088		NGC 4501	12 32.0	+14.4	9.5	6'	Com	very elongated galaxy with bright core
M089		NGC 4552	12 35.7	+12.6	9.8	3'	Vir	round galaxy with bright core
M090		NGC 4569	12 36.8	+13.2	9.5	9'	Vir	very elongated galaxy with bright core
M091		NGC 4548	12 35.4	+14.5	10.2	4.5'	Com	elongated galaxy with bright core
M092		NGC 6341	17 17.1	+43.1	6.5	8'	Her	globular cluster highly resolved
M093		NGC 2447	07 44.6	-23.9	6.2	20'	Pup	open cluster dense
M094		NGC 4736	12 50.9	+41.1	8.2	5'	Cvn	elongated galaxy with bright core
M095		NGC 3351	10 44.0	+11.7	9.7	4'	Leo	barred spiral galaxy structure
M096		NGC 3368	10 46.8	+11.8	9.3	6'	Leo	round galaxy with bright core
M097	Owl	NGC 3587	11 14.8	+55.0	11	2.5'	Uma	planetary nebula irregular
M098		NGC 4192	12 13.8	+14.9	10	8.2'	Com	very elongated galaxy with bright core
M099		NGC 4254	12 18.8	+14.4	10	5'	Com	spiral galaxy structure
M100		NGC 4321	12 22.9	+15.8	9.4	7'	Com	round galaxy with bright core
M101		NGC 5457	14 03.2	+54.4	7.8	20'	Uma	spiral galaxy structure with bright knots
M102		NGC 5866	15 06.5	+55.8	10	3'	Dra	very elongated galaxy dusty with bright core
M103		NGC 581	01 33.2	+60.7	7.4	6'	Cas	open cluster rich
M104	sombrero	NGC 4594	12 40.0	-11.6	8.2	7'	Vir	edge on galaxy dusty
M105		NGC 3379	10 47.8	+12.6	9.3	4'	Leo	round galaxy with bright core
M106		NGC 4258	12 19.0	+47.3	8.3	18'	Cvn	spiral galaxy structure with bright knots
M107		NGC 6171	16 32.5	-13.1	9	7'	Oph	globular cluster
M108		NGC 3556	11 11.5	+55.7	10.1	8'	Uma	very elongated galaxy with dust and bright knots
M109		NGC 3992	11 57.6	+53.4	9.8	8'	Uma	elongated galaxy with bright core
M110		NGC 205	00 40.4	+41.7	8	17'	And	elongated galaxy

## Star Catalog

STAR CATALOG	NAME	RA	DEC	MAG	SIZE	CON	DESCRIPTION	
ST001	O 254	00 01.2	+60 21	7.6	59"	Cas	colored double star	
ST002	30	30 PSC	00 02.0	-6	4.4	*	Psc	red variable star
ST003	3053	00 02.6	+66 06	5.9	15"	Cas	colored double star	
ST004	SU	SU AND	00 04.6	+43.5	8	*	And	red variable star
ST005	Ced214	Cederblad 214	00 04.7	+67.2	7.8	30'	Cep	emission nebula
ST006	3062	ADS 61	00 06.3	+58.4	6.4	1.5"	Cas	double star challenge
ST007	Alpheratz	Alpha And	00 08.4	+29 05	2.1	*	And	star
ST008	2	Struve 2	00 09.3	+79.7	6.6	0.8"	Cep	double star challenge
ST009	Kappa	β 391	00 09.4	-28 00	6.2	2"	ScI	double star challenge
ST010	Algenib	Gamma PEG	00 13.2	+15.2	2.8	*	Peg	star
ST011	AD	AD Cet	00 14.5	-7.8	4.9	1.5°	Cet	red variable star
ST012	7	7 CET	00 14.6	-18.9	4.4	*	Cet	red variable star
ST013	35 Psc	12, UU Psc	00 15.0	+08 49	5.8	12"	Psc	colored double star
ST014	S	S SCL	00 15.4	-32.1	5.5	*	ScI	variable star
ST015	13	Struve 13	00 16.2	+76.9	7	0.9"	Cep	double star challenge
ST016	ST	ST CAS	00 17.6	+50.3	9	*	Cas	red variable star
ST017	Groombridge34	Groombridge 34	00 18.1	+44.0	8	39"	And	And double star
ST018	24	00 18.5	+26 08	7.6	5"	And	double star	

ST019	Iota	Iota CET	00 19.4	-8.8	3.5	*	Cet	star
ST020	VX	VX AND	00 19.9	+44.7	8	*	And	star
ST021	R		00 24.0	+38 35	5.8	Stellar	And	variable star
ST022	30		00 27.2	+49 59	6.9	15"	Cas	double star
ST023	AQ	AQ AND	00 27.6	+35.6	6.9	*	And	red variable star
ST024	Beta	Beta TUC	00 31.5	-63	4.4	27"	Tuc	double star
ST025	36	Struve 36	00 32.4	+06.9	5.7	28"	Psc	double star
ST026	Zeta	Zeta CAS	00 37.0	+53.9	3.7	*	Cas	star
ST027	Delta	Delta AND	00 39.3	+30.9	3.3	*	And	star
ST028	55		00 39.9	+21 26	5.4	6"	Psc	colored double star
ST029	Schedar	Alpha CAS	00 40.5	+56.5	2.2	*	Cas	star
ST030	O 18	ADS 588	00 42.4	+04.2	7.8	1.5"	Psc	double star challenge
ST031	HN	HN 122	00 45.7	+75.0	5.7	36"	Cas	double star
ST032	Delta	Delta PSC	00 48.7	+07.6	4.4	*	Psc	star
ST033	Eta		00 49.1	+57 49	3.4	12"	Cas	colored double star
ST034	65	65 PSC	00 49.9	+27.7	6.3	4.4"	Psc	colored double star
ST035	Do13	Dolidze 13	00 50.0	+64.1	11	13'	Cas	scattered group of stars
ST036	Lambda1	Lambda1 TUC	00 52.4	-69.5	6.5	21"	Tuc	double star
ST037	36	36 AND	00 55.0	+23.6	6	0.8"	And	double star challenge
ST038	Navi	Gamma CAS	00 56.7	+60.7	2.5	*	Cas	star
ST039	80		00 59.4	+00 47	8.4	26"	Cet	double star equal magnitude
ST040	79		01 00.1	+44 43	6	8"	And	double star equal magnitude
ST041	U		01 02.3	+81 51	6.8	Stellar	Cep	variable star
ST042	Psi-1	88, 74 Psc	01 05.6	+21 28	5.3	30"	Psc	double star equal magnitude
ST043	77	90	01 05.8	+04 55	6.8	33"	Psc	double star
ST044	Zeta	Zeta PHE	01 08.4	-55.3	3.9	6.4"	Phe	double star
ST045	Eta	Eta CET	01 08.6	-10.2	3.5	*	Cet	star
ST046	Lux Lydiae	Lux Lydiae	01 08.7	+86.3	4.3	*	Cep	star
ST047	Mirach	Beta AND	01 09.7	+35.6	2	*	And	star
ST048	Zeta	Zeta PSC	01 13.7	+07.6	5.6	23"	Psc	double star
ST049	Kappa	Kappa TUC	01 15.8	-68.9	5.1	5.4"	Tuc	double star
ST050	Z	Z PSC	01 16.2	+25.8	8.8	*	Psc	star
ST051	42	113	01 19.8	-00 31	6.4	1.6"	Cet	double star challenge
ST052	Psi	Psi CAS	01 25.9	+68.1	4.7	25"	Cas	double star magnitude contrast
ST053	R	R SCL	01 27.0	-32.5	6.1	*	Scl	variable star
ST054	Gamma	Gamma PHE	01 28.4	-43.3	3.4	4'	Phe	star
ST055	Achernar	Alpha Eri	01 37.7	-57 14	0.5	*	Eri	star
ST056	51	51 AND	01 38.0	+48.6	3.6	*	And	star
ST057	UV	UV CET	01 38.8	-18	7	*	Cet	variable star
ST058	p	p ERI	01 39.8	-56.2	5.8	11.5"	Eri	double star
ST059	Nu	Nu PSC	01 41.4	+05.5	4.4	*	Psc	star
ST060	44	44 CAS	01 43.3	+60.6	5.8	1.6"	Cas	double star
ST061	Phi	Phi PER	01 43.7	+50.7	4.1	*	Per	star
ST062	162		01 49.3	+47 54	5.8	2"	Per	triple star challenge
ST063	1	1 ARI	01 50.1	+22.3	6	2.6"	Ari	double star
ST064	163		01 51.3	+64 51	6.6	35"	Cas	colored double star
ST065	Zeta	Zeta CET	01 51.5	-10.3	3.7	3'	Cet	double star
ST066	178		01 52.0	+10 48	8.5	3"	Ari	double star equal magnitude
ST067	Gamma	Gamma ARI	01 53.5	+19.3	4.5	8"	Ari	double star equal magnitude
ST068	Psi	Psi PHE	01 53.6	-46.3	4.4	5°	Phe	red variable star
ST069	Epsilon	Epsilon CAS	01 54.4	+63.7	3.4	*	Cas	star
ST070	186	Struve 186	01 55.9	+01.9	6.8	1"	Cet	double star challenge
ST071	56	56 AND	01 56.2	+37.3	5.7	3'	And	double star
ST072	Lambda	Lambda ARI	01 57.9	+23.6	4.8	37"	Ari	double star
ST073	Upsilon	Upsilon CET	02 00.0	-21.1	4	*	Cet	star
ST074	Alpha	Alpha PSC	02 02.0	+02.8	4	1.6"	Psc	double star challenge
ST075	Almach	Gamma AND	02 03.9	+42.3	2.2	10"	And	colored double star
ST076	Hamal	Alpha ARI	02 07.2	+23.5	2	*	Ari	star
ST077	59 And		02 10.9	+39 02	5.6	16"	And	colored double star
ST078	Iota	Iota TRI	02 12.4	+30.3	5	3.8"	Tri	colored double star
ST079	231	Struve 231	02 12.8	-2.4	5.7	16.5"	Cet	double star
ST080	228	Struve 228	02 14.0	+47.5	6.6	1.1"	And	double star challenge
ST081	232		02 14.7	+30 24	8	7"	Tri	double star equal magnitude
ST082	239		02 17.4	+28 44	7	14"	Tri	double star
ST083	Mira	Omicron CET	02 19.3	-3	2	*	Cet	variable star
ST084	Iota	Iota CAS	02 29.1	+67.4	4	2.2"	Cas	triple star
ST085	268		02 29.4	+55 31	6.9	3"	Per	double star
ST086	274		02 31.5	+01 05	7.3	14"	Cet	double star equal magnitude
ST087	Polaris	Alpha UMi	02 31.8	+89 16	2	18"	UMi	double star
ST088	Omega	h 3506	02 33.9	-28 13	5	11"	For	double star
ST089	30		02 37.0	+24 38	6.5	39"	Ari	colored double star
ST090	R	R TRI	02 37.0	+34.3	5.4	*	Tri	variable star
ST091	Gamma	Gamma CET	02 43.3	+03.2	3.6	2.7"	Cet	double star
ST092	305		02 47.5	+19 22	7.4	3"	Ari	double star challenge
ST093	RZ		02 48.9	+69 38	6.2	Stellar	Cas	variable star

ST094	pi		02 49.3	+17 28	5.2	3"	Ari	triple star
ST095	Eta	307	02 50.7	+55 53	3.9	28"	Per	double star magnitude contrast
ST096	R	R HOR	02 53.9	-49.9	4.7	*	Hor	variable star
ST097	330	Struve 330	02 57.2	-0.6	7.3	9"	Cet	double star
ST098	Acamar	Theta ERI	02 58.3	-40.3	3.5	8"	Eri	double star
ST099	Epsilon	Epsilon ARI	02 59.2	+29.3	4.6	1.4"	Ari	double star challenge
ST100	Epsilon		02 59.2	+21 20	4.6	1"	Ari	double star challenge
ST101	331		03 00.8	+52 20	5.4	12"	Per	double star
ST102	Menkar	Alpha CET	03 02.3	+04.1	2.5	*	Cet	star
ST103	Rho	Rho PER	03 05.2	+38.8	3.4	*	Per	red variable star
ST104	320		03 06.2	+79 24	5.8	5"	Cep	colored double star
ST105	h3568	h3568	03 07.5	-79	5.6	15"	Hyi	double star
ST106	Algol	Beta PER	03 08.2	+41.0	2.2	*	Per	variable star
ST107	Alpha	Alpha FOR	03 12.1	-29	4	5"	For	double star
ST108	h3556	h3556	03 12.4	-44.4	6	3.5"	Eri	double star
ST109	362		03 16.3	+60 02	8.5	7"	Cam	double star equal magnitude
ST110	369		03 17.2	+40 29	6.7	3"	Per	colored double star
ST111	ADS2446	ADS 2446	03 17.7	+38.6	7.8	0.9"	Per	double star challenge
ST112	Zeta	Zeta RET	03 18.2	-62.5	5.2	5'	Ret	double star
ST113	Tau4	Tau4 ERI	03 19.5	-21.8	3.7	*	Eri	star
ST114	Toms Topaz	Tom's Topaz	03 20.3	+29.0	4.5	9°	Ari	star
ST115	Mirfak	Alpha Per	03 24.3	+49 52	1.8	*	Per	star
ST116	Y	Y PER	03 27.7	+44.2	8.1	*	Per	variable star
ST117	394		03 28.0	+20 27	7.1	7"	Ari	double star
ST118	385	Struve 385	03 29.1	+59.9	4.2	2.4"	Cam	double star
ST119	389		03 30.1	+59 21	6.5	2.7"	Cam	double star
ST120	Sigma	Sigma PER	03 30.6	+48.0	4.4	*	Per	star
ST121	401		03 31.3	+27 34	6.4	11"	Tau	double star equal magnitude
ST122	Epsilon	Epsilon ERI	03 32.9	-9.5	3.7	*	Eri	star
ST123	400	Struve 400	03 35.0	+60.0	6.8	1.4"	Cam	double star
ST124	O 36	O.Struve 36	03 40.0	+63.9	6.8	46"	Cam	double star
ST125	U1	U(1) CAM (?)	03 41.6	+62.6	8.1	0	Cam	variable star
ST126	Omicron	Omicron PER	03 44.3	+32.3	3.8	0	Per	star
ST127	Pi	Pi ERI	03 46.1	-12.1	4.4	*	Eri	red variable star
ST128	Gamma	Gamma HYI	03 47.2	-74.2	3.2	*	Hyi	star
ST129	30	30 TAU	03 48.3	+11.2	5	9"	Tau	double star
ST130	F	16	03 48.6	-37 37	4.9	8"	Eri	double star equal magnitude
ST131	BE	BE CAM	03 49.5	+65.5	4.5	*	Cam	star
ST132	Atik	Zeta PER	03 54.1	+31.9	2.9	*	Per	star
ST133	32	32 ERI	03 54.3	-3	5	7"	Eri	colored double star
ST134	Epsilon		03 57.9	+40 01	2.9	9"	Per	double star magnitude contrast
ST135	Gamma	Gamma ERI	03 58.0	-13.5	3	*	Eri	star
ST136	Lambda	Lambda TAU	04 00.7	+12.5	3.3	*	Tau	variable star
ST137	O 531	ADS 2995	04 07.6	+38.1	7.4	1.4"	Per	double star challenge
ST138	SZ	485	04 07.8	+62 20	7	90"	Cam	double star
ST139	Omicron2	Omicron2 ERI	04 15.2	-7.7	4.5	83"	Eri	triple star challenge
ST140	Epsilon	Epsilon RET	04 16.5	-59.3	4.4	*	Ret	star
ST141	Theta	Theta RET	04 17.7	-63.3	6.2	4"	Ret	double star
ST142	Phi	Phi TAU	04 20.4	+27.4	5	52"	Tau	double star
ST143	T		04 22.0	+19 32	8.4	Stellar	Tau	variable star
ST144	Chi	Chi TAU	04 22.6	+25.6	5.5	19.4"	Tau	double star
ST145	ADS3169	ADS 3169	04 22.7	+15.1	7.3	1.4"	Tau	double star challenge
ST146	43	43 ERI	04 24.0	-34	4	*	Eri	red variable star
ST147	β 184		04 27.9	-21 30	7.3	1.7"	Eri	double star challenge
ST148	552		04 31.4	+40 01	7	9"	Per	double star equal magnitude
ST149	1		04 32.0	+53 55	5.4	10"	Cam	colored double star
ST150	559		04 33.5	+18 01	6.9	3"	Tau	double star equal magnitude
ST151	46	46 ERI	04 33.9	-6.7	5.7	4'	Eri	double star
ST152	Aldebaran	Alpha TAU	04 35.9	+16.5	0.9	30"	Tau	colored double star
ST153	Nu	Nu ERI	04 36.3	-3.4	3.9	11°	Eri	star
ST154	53	53 ERI	04 38.2	-14.3	3.9	*	Eri	star
ST155	572		04 38.5	+26 56	7.3	4"	Tau	double star equal magnitude
ST156	54	54 ERI	04 40.4	-19.7	4.3	*	Eri	red variable star
ST157	R	R CAE	04 40.5	-38.2	6.7	*	CAE	variable star
ST158	55	590	04 43.6	-08 48	6.7	9"	Eri	double star equal magnitude
ST159	Iota	Iota PIC	04 50.9	-53.5	5.6	12"	Pic	double star
ST160	ST		04 51.2	+68 10	9.2	Stellar	Cam	red variable star
ST161	Pi4	Pi4 ORI	04 51.2	+05.6	3.7	*	Ori	star
ST162	TT	TT TAU	04 51.6	+28.5	8	*	Tau	variable star
ST163	Pi5	Pi5 ORI	04 54.2	+02.4	3.7	*	Ori	star
ST164	Omicron2	Omicron2 ORI	04 56.4	+13.5	4.1	*	Ori	star
ST165	Iota	Iota AUR	04 57.0	+33.2	2.7	*	Aur	star
ST166	Pi6	Pi6 ORI	04 58.5	+01.7	4.5	*	Ori	star
ST167	Omega	Omega AUR	04 59.3	+37.9	5	5.4"	Aur	double star

ST168	Hinds Crimson Star	R LEP	04 59.6	-14.8	5.9	*	Lep	variable star
ST169	627		05 00.6	+03 36	6.6	21"	Ori	double star equal magnitude
ST170	631	Struve 631	05 00.7	-13.5	7.5	5.5"	Lep	double star
ST171	630	Struve 630	05 02.0	+01.6	6.5	15"	Ori	double star
ST172	Epsilon		05 02.0	+43 49	2.9	Stellar	Aur	variable star
ST173	Zeta	Zeta AUR	05 02.5	+41.1	3.8	*	Aur	star
ST174	W	W ORI	05 05.4	+01.2	8.6	*	Ori	variable star
ST175	Epsilon	Epsilon LEP	05 05.5	-22.4	3.2	*	Lep	star
ST176	Eta	Eta AUR	05 06.5	+41.2	3.2	*	Aur	star
ST177	14	O 98	05 07.9	+08 29	5.9	0.7"	Ori	double star challenge
ST178	TX	TX AUR	05 09.1	+39.0	8.5	*	Aur	variable star
ST179	SY	SY ERI	05 09.8	-5.6	9	*	Eri	variable star
ST180	644		05 10.4	+37 17	6.8	2"	Aur	double star challenge
ST181	Iota	Iota LEP	05 12.3	-11.9	4.5	13"	Lep	double star
ST182	Rho		05 13.3	+02 52	4.5	7"	Ori	colored double star
ST183	Rigel	Beta ORI	05 14.5	-8.2	0	9.4"	Ori	double star magnitude contrast
ST184	653	Struve 653	05 15.4	+32.7	5.1	11"	Aur	triple star
ST185	Capella	Alpha Aur	05 16.7	+46 00	0.1	*	Aur	star
ST186	S 476		05 19.3	-18 30	6.2	39"	Lep	double star equal magnitude
ST187	h3750		05 20.5	-21 14	4.7	4"	Lep	double star magnitude contrast
ST188	UV	UV AUR	05 21.8	+32.5	7.4	*	Aur	variable star
ST189	ADS3954	ADS 3954	05 21.8	-24.8	5.5	3.2"	Lep	double star
ST190	696	Struve 696	05 22.8	+03.6	5	32"	Ori	double star
ST191	701	Struve 701	05 23.3	-8.4	6	6"	Ori	double star
ST192	Eta		05 24.5	-02 24	3.4	1.5"	Ori	double star challenge
ST193	Sigma	Sigma AUR	05 24.7	+37.4	5	9"	Aur	double star
ST194	Theta	Theta PIC	05 24.8	-52.3	6.8	38"	Pic	double star
ST195	Bellatrix	Gamma ORI	05 25.1	+06.3	1.6	*	Ori	star
ST196	698	Struve 698	05 25.2	+34.9	6.6	31"	Aur	double star
ST197	118	716	05 29.3	+25 09	5.8	5"	Tau	double star
ST198	31	31 ORI	05 29.7	-1.1	4.7	*	Ori	star
ST199	TL9	TL 9	05 30.0	+17.0	5	5°	Tau	asterism
ST200	Delta	Delta ORI	05 32.0	-0.3	2.2	53"	Ori	double star
ST201	119	119 TAU	05 32.2	+18.6	4.7	*	Tau	star
ST202	718		05 32.4	+49 24	7.5	8"	Aur	double star equal magnitude
ST203	RT	RT ORI	05 33.2	+07.2	8	*	Ori	variable star
ST204	747	Struve 747	05 35.0	-6	4.8	36"	Ori	double star
ST205	Lambda		05 35.1	+09 56	3.4	4"	Ori	double star magnitude contrast
ST206	Trapezium	Trapezium	05 35.3	-05 23	5.1	13"	Ori	quadruple star
ST207	Iota	752	05 35.4	-05 55	2.9	11"	Ori	double star magnitude contrast
ST208	Epsilon	Epsilon ORI	05 36.2	-1.2	1.7	*	Ori	star
ST209	Phi2	Phi2 ORI	05 36.9	+09.3	4	*	Ori	star
ST210	Zeta	Zeta TAU	05 37.6	+21.1	3	*	Tau	star
ST211	Sigma		05 38.7	-02 36	3.7	11"	Ori	quadruple star
ST212	Alpha	Alpha COL	05 39.6	-34.1	2.6	*	Col	star
ST213	Alnitak	Zeta ORI	05 40.8	-1.9	2	2.4"	Ori	double star magnitude contrast
ST214	U2	U(2) CAM (?)	05 42.2	+62.5	7.7	*	Cam	variable star
ST215	Gamma	Gamma LEP	05 44.5	-22.5	3.7	97"	Lep	double star
ST216	Y	Y TAU	05 45.7	+20.7	7.1	*	Tau	variable star
ST217	Mu	Mu COL	05 46.0	-32.3	5.2	*	Col	star
ST218	Kappa	Kappa ORI	05 47.8	-9.7	2	*	Ori	star
ST219	52	795	05 48.0	+06 27	6.1	1.3"	Ori	double star challenge
ST220	Beta	Beta COL	05 51.0	-35.8	3.1	*	Col	star
ST221	Delta	Delta LEP	05 51.3	-20.9	3.8	*	Lep	star
ST222	Nu	Nu AUR	05 51.5	+39.1	4	30'	Aur	star
ST223	817		05 54.9	+07 02	8.8	19"	Ori	double star equal magnitude
ST224	Betelgeuse	Alpha Ori	05 55.2	+07 24	0.5	Stellar	Ori	star
ST225	U	U ORI	05 55.8	+20.2	5.3	*	Ori	variable star
ST226	Theta		05 59.7	+37 13	2.6	3.5"	Aur	double star magnitude contrast
ST227	Pi	Pi AUR	05 59.9	+45.9	4.3	1°	Aur	red variable star
ST228	23		06 04.8	-48 27	7	2.7"	Pup	double star equal magnitude
ST229	855		06 09.0	+02 30	6	30"	Ori	double star
ST230	TU	TU GEM	06 10.9	+26.0	7.5	*	Gem	variable star
ST231	41	845	06 11.7	+48 42	6.1	8"	Aur	double star
ST232	SS	SS AUR	06 13.4	+47.0	10	*	Aur	variable star
ST233	Gamma	Gamma MON	06 14.9	-6.3	4	8°	Mon	star
ST234	Eta	Eta GEM	06 14.9	+22.5	3.3	*	Gem	star
ST235	872	Struve 872	06 15.6	+36.2	6.9	11"	Aur	double star
ST236	KS	KS MON	06 19.7	-5.3	9.5	*	Mon	variable star
ST237	Zeta	Zeta CMA	06 20.3	-30.1	3	8.5°	Cma	star
ST238	V	V MON	06 22.7	-2.2	6	*	Mon	variable star
ST239	Mirzam	Beta CMA	06 22.7	-18	2	*	Cma	star
ST240	Mu	Mu GEM	06 23.0	+22.5	2.9	*	Gem	star
ST241	8		06 23.8	+04 36	4.3	13"	Mon	colored double star
ST242	Canopus	Alpha Car	06 24.0	-52 42	-0.7	*	Car	star

ST243	BL	BL ORI	06 25.5	+14.7	8.5	*	Ori	variable star
ST244	15		06 27.8	+20 47	6.6	27"	Gem	double star
ST245	Beta		06 28.8	-07 02	3.8	3"	Mon	triple star
ST246	ADS5150	ADS 5150	06 31.8	+38.9	11.5	4.5"	Aur	double star
ST247	20	20 GEM	06 32.3	+17.8	6.3	20"	Gem	colored double star
ST248	ADS5188	ADS 5188	06 34.3	+38.1	6.7	43"	Aur	double star
ST249	CR	CR GEM	06 34.4	+16.1	8.5	*	Gem	variable star
ST250	928	ADS 5191	06 34.7	+38.4	7.6	3.5"	Aur	double star
ST251	ADS5201	ADS 5201	06 35.1	+37.1	7.4	2.6"	Aur	double star
ST252	929	ADS 5208	06 35.4	+37.7	7.4	6"	Aur	double star
ST253	939	Struve 939	06 35.9	+05.3	8.3	30"	Mon	double star
ST254	ADS5221	ADS 5221	06 36.2	+38.0	8.5	1.3"	Aur	double star challenge
ST255	Nu1	Nu1 CMA	06 36.4	-18.7	6	17.5"	Cma	colored double star
ST256	UU	UU AUR	06 36.5	+38.5	5.1	*	Aur	variable star
ST257	ADS5240	ADS 5240	06 36.9	+38.2	9.7	2.2"	Aur	double star
ST258	ADS5245	ADS 5245	06 37.3	+38.4	8.8	10"	Aur	double star
ST259	South529	South 529	06 37.6	+12.2	7.6	70"	Gem	double star
ST260	Innes5	Innes 5	06 38.0	-61.5	6.4	2.4"	Pic	double star
ST261	ADS5265	ADS 5265	06 38.4	+38.8	9.6	4.6"	Aur	double star
ST262	Innes1156	Innes 1156	06 39.1	-29.1	8	0.7"	Cma	double star challenge
ST263	SAO172106	SAO 172106	06 39.5	-30	7.8	2.5°	Cma	red variable star
ST264	953		06 41.2	+08 59	7.1	7"	Mon	double star
ST265	VV	VV GEM	06 42.2	+31.5	8.7	*	Gem	variable star
ST266	Sirius	Alpha CMA	06 45.1	-16.7	-1	9"	Cma	double star magnitude contrast
ST267	12	948	06 46.2	+59 27	4.9	2"	Lyn	triple star challenge
ST268	958		06 48.2	+55 42	5.5	5"	Lyn	double star equal magnitude
ST269	Kappa	Kappa CMA	06 49.8	-32.5	4	*	Cma	star
ST270	14	14 LYN	06 53.1	+59.5	5.7	0.4"	Lyn	double star challenge
ST271	GY	GY MON	06 53.2	-4.6	9.4	*	Mon	variable star
ST272	987		06 54.1	-05 51	7.1	1.3"	Mon	double star challenge
ST273	Omicron1	Omicron1 CMA		06 54.1	-24.2	3.9	*	Cmastar
ST274	Theta	Theta CMA	06 54.2	-12	4.1	*	Cma	star
ST275	38		06 54.6	+13 11	4.7	7"	Gem	colored double star
ST276	Mu	997	06 56.1	-14 02	5.3	2.8"	Cma	double star magnitude contrast
ST277	BG	BG MON	06 56.4	+07.1	9.2	*	Mon	variable star
ST278	O 80	O. Struve (P) 80		06 58.1	+14.2	7.3	2'	Gemasterism
ST279	RV	RV MON	06 58.4	+06.2	7	*	Mon	variable star
ST280	Epsilon	Epsilon CMA	06 58.6	-29	1.5	7.5"	Cma	double star
ST281	Sigma	Sigma CMA	07 01.7	-27.9	3.5	*	Cma	star
ST282	Omicron2	Omicron2 CMA		07 03.0	-23.8	3	*	Cmastar
ST283	Dunlop38	Dunlop 38	07 04.0	-43.6	5.6	20.5"	Pup	double star
ST284	Zeta	Zeta GEM	07 04.1	+20.6	3.7	*	Gem	variable star
ST285	1009		07 05.7	+52 45	6.9	4.1"	Lyn	double star equal magnitude
ST286	R	R GEM	07 07.4	+22.7	6	*	Gem	variable star
ST287	W		07 08.1	-11 55	6.4	Stellar	CMA	red variable star
ST288	Gamma	Gamma VOL	07 08.8	-70.5	4	13.6"	Vol	double star
ST289	Tau	Tau GEM	07 11.1	+30.2	4.4	1.9"	Gem	double star
ST290	1035		07 12.0	+22 17	8.2	4"	Gem	double star equal magnitude
ST291	1037	Struve 1037	07 12.8	+27.2	7.2	1.3"	Gem	double star challenge
ST292	Omega	Omega CMA	07 14.8	-26.8	3.9	*	Cma	star
ST293	h3945		07 16.6	-23 19	4.5	27"	CMA	colored double star
ST294	Tau	h 3948	07 18.7	-24 57	4.4	15"	CMA	triple star
ST295	Delta	55 Gem	07 20.1	+21 59	3.5	6"	Gem	double star magnitude contrast
ST296	19	1062	07 22.9	+55 17	5.6	15"	Lyn	triple star
ST297	Gamma	Gamma CMI	07 28.2	+08.9	4.3	*	Cmi	star
ST298	Sigma	Sigma PUP	07 29.2	-43.3	3.3	22"	Pup	double star
ST299	1093	Struve 1093	07 30.3	+50.0	8.8	0.8"	Lyn	double star challenge
ST300	n	HN19, h269	07 34.3	-23 28	5.1	10"	Pup	double star equal magnitude
ST301	Castor	Alpha GEM	07 34.6	+31.9	2	1.8"	Gem	double star challenge
ST302	Upsilon	Upsilon GEM	07 35.9	+26.9	4.1	2.5°	Gem	red variable star
ST303	1121		07 36.6	-14 29	7.9	7"	Pup	double star equal magnitude
ST304	K		07 38.8	-26 48	3.8	10"	Pup	double star equal magnitude
ST305	Procyon	Alpha CMi	07 39.3	+05 14	0.4	Stellar	CMi	star
ST306	Kappa	O 179	07 44.4	+24 23	3.7	7"	Gem	double star magnitude contrast
ST307	2	1138	07 45.5	-14 41	6.1	17"	Pup	double star equal magnitude
ST308	1127		07 47.0	+64 03	7	5"	Cam	triple star
ST309	1149		07 49.4	+03 13	7.9	22"	Cmi	double star
ST310	U		07 55.1	+22 00	8.2	Stellar	Gem	variable star
ST311	Chi	Chi CAR	07 56.8	-53	3.5	4°	Car	star
ST312	Dunlop59	Dunlop 59	07 59.2	-50	6.5	16"	Pup	double star
ST313	S-h86	S-h 86	08 02.5	+63.1	6	49"	Cam	double star
ST314	Zeta	Zeta PUP	08 03.6	-40	2.3	4°	Pup	star
ST315	RT	RT PUP	08 05.4	-38.8	8.5	*	Pup	variable star
ST316	RU	RU PUP	08 07.5	-22.9	8.9	*	Pup	variable star



ST317	Epsilon	Epsilon VOL	08 07.9	-68.6	4.4	6"	Vol	double star
ST318	Gamma	Gamma VEL	08 09.5	-47.3	1.9	41"	Vel	double star
ST319	Zeta		08 12.2	+17 39	4.7	0.6"	Cnc	triple star challenge
ST320	c	c CAR	08 15.3	-62.9	5.3	4"	Car	double star
ST321	Beta	Beta CNC	08 16.5	+09.2	3.5	*	Cnc	star
ST322	R	R CNC	08 16.6	+11.7	6.1	*	Cnc	variable star
ST323	Kappa	Kappa VOL	08 19.8	-71.5	5.4	65"	Vol	double star
ST324	AC	AC PUP	08 22.7	-15.9	8.9	*	Pup	variable star
ST325	31	31 LYN	08 22.8	+43.2	4.3	15°	Lyn	star
ST326	Beta	Beta VOL	08 25.7	-66.1	3.8	6°	Vol	star
ST327	h4903	h4903	08 26.3	-39.1	6.5	8"	Pup	double star
ST328	24	1224	08 26.7	+24 32	7.1	6"	Cnc	double star
ST329	Phi	1223	08 26.7	+26 56	6.3	5"	Cnc	double star equal magnitude
ST330	h4104	h4104	08 29.1	-47.9	5.5	3.6"	Vel	double star
ST331	70		08 29.5	-44 44	5	5"	Vel	double star
ST332	h4107		08 31.4	-39 04	6.4	4"	Vel	triple star
ST333	1245		08 35.8	+06 37	6	10"	Cnc	double star
ST334	Sigma	Sigma HYA	08 38.8	+03.3	4.4	*	Hya	star
ST335	h4128	h4128	08 39.2	-60.3	6.9	1.4"	Car	double star challenge
ST336	1254		08 40.4	+19 40	6.4	21"	Cnc	quadruple star
ST337	Alpha	Alpha PYX	08 43.6	-33.2	3.7	*	Pyx	star
ST338	Delta	Delta VEL	08 44.7	-54.7	2.1	2.6"	Vel	double star
ST339	1270	ADS 6977	08 45.3	-2.6	6.4	5"	Hya	double star
ST340	Iota	1268	08 46.7	+28 46	4	30"	Cnc	colored double star
ST341	Epsilon		08 46.8	+06 25	3.4	3"	Hyd	double star magnitude contrast
ST342	1282		08 50.8	+35 03	7.5	4"	Lyn	double star equal magnitude
ST343	X	X CNC	08 55.4	+17.2	5.6	*	Cnc	variable star
ST344	66	1298	09 01.4	+32 15	5.9	5"	Cnc	double star
ST345	Rho	Rho UMA	09 02.5	+67.6	4.8	1°	Uma	star
ST346	1311		09 07.5	+22 59	6.9	8"	Cnc	double star equal magnitude
ST347	Suhail	Lambda Vel	09 08.0	-43 26	2.2	Stellar	Vel	star
ST348	Sigma2		09 10.4	+67 08	4.8	4"	Uma	double star magnitude contrast
ST349	a	a CAR	09 11.0	-59	3.4	50'	Car	star
ST350	h4188	h4188	09 12.5	-43.6	6.7	2.7"	Vel	double star
ST351	h4191		09 14.4	-43 13	5.2	6"	Vel	double star magnitude contrast
ST352	1321		09 14.9	+52 42	8.1	18"	Uma	double star equal magnitude
ST353	g	g CAR	09 16.2	-57.5	4.3	5'	Car	star
ST354	RT	RT UMA	09 18.4	+51.4	8.6	*	Uma	variable star
ST355	38	1334	09 18.8	+36 48	3.9	3"	Lyn	double star challenge
ST356	1338		09 21.0	+38 11	6.6	1"	Lyn	double star challenge
ST357	Alpha	Alpha LYN	09 21.1	+34.4	3.1	*	Lyn	star
ST358	Kappa	Kappa VEL	09 22.1	-55	2.5	*	Vel	star
ST359	1347		09 23.3	+03 30	7.2	21"	Hya	double star
ST360	Kappa	Kappa LEO	09 24.7	+26.2	4.5	2.1"	Leo	triple star
ST361	1355		09 27.3	+06 14	7.5	2.3"	Hya	double star equal magnitude
ST362	Alphard	Alpha Hya	09 27.6	-08 40	2	Stellar	Hya	star
ST363	Omega	Omega LEO	09 28.5	+09.1	5.9	0.5"	Leo	double star challenge
ST364	Dunlop76	Dunlop 76	09 28.6	-45.5	7.8	61"	Vel	double star
ST365	1360		09 30.6	+10 35	8.3	14"	Leo	double star equal magnitude
ST366	Zeta		09 30.8	-31 53	5.8	8"	Ant	double star
ST367	N	N VEL	09 31.2	-57	3.1	*	Vel	star
ST368	23	1351	09 31.5	+63 03	3.8	23"	Uma	double star magnitude contrast
ST369	Lambda	Lambda LEO	09 31.7	+23.0	4.3	*	Leo	star
ST370	R	R CAR	09 32.2	-62.8	3.8	*	Car	variable star
ST371	1369	Struve 1369	09 35.4	+40.0	6.5	25"	Lyn	double star
ST372	Iota	Iota HYA	09 39.9	-1.1	3.9	*	Hya	star
ST373	Upsilon	Upsilon CAR	09 47.1	-65.1	3.1	5"	Car	double star
ST374	R		09 47.6	+11 26	4.4	Stellar	Leo	red variable star
ST375	W	W SEX	09 51.0	-2	9	*	Sex	variable star
ST376	Y	Y HYA	09 51.1	-23	8.3	*	Hya	variable star
ST377	Mu	Mu LEO	09 52.8	+26.0	3.9	*	Leo	star
ST378	h4262	ADS 7571	09 54.5	-12.9	8.7	8"	Hya	double star
ST379	Regulus	Alpha Leo	10 08.4	+11 58	1.4	Stellar	Leo	star
ST380	S	S CAR	10 09.4	-61.6	4.5	*	Car	variable star
ST381	ADS7704	ADS 7704	10 16.3	+17.7	7.2	1.4"	Leo	double star challenge
ST382	Zeta	Zeta LEO	10 16.7	+23.4	3.4	5.5'	Leo	double star
ST383	q	q CAR	10 17.1	-61.3	3.4	*	Car	star
ST384	h4306	h4306	10 19.1	-64.7	5.6	2.1"	Car	double star
ST385	Algieba	Gamma LEO	10 20.0	+19.8	2.5	4.4"	Leo	double star
ST386	Mu	Mu UMA	10 22.3	+41.5	3	*	Uma	star
ST387	Mu	Mu HYA	10 26.1	-16.8	3.8	*	Hya	star
ST388	Alpha	Alpha ANT	10 27.2	-31.1	4.3	*	Ant	star
ST389	45	45 LEO	10 27.6	+09.8	6	3.8"	Leo	double star
ST390	Delta	HN 50	10 29.6	-30 36	5.7	11"	Ant	double star magnitude contrast
ST391	p	p CAR	10 32.0	-61.7	3.3	*	Car	star

ST392	Rho	Rho LEO	10 32.8	+09.3	3.9	*	Leo	star
ST393	49		10 35.0	+08 39	5.7	2"	Leo	double star challenge
ST394	U	U ANT	10 35.2	-39.6	8.1	*	Ant	variable star
ST395	Gamma	Gamma CHA	10 35.5	-78.6	4.1	*	Cha	star
ST396	U	U HYA	10 37.6	-13.4	7	*	Hya	variable star
ST397	Dunlop95	Dunlop 95	10 39.3	-55.6	4.3	52"	Vel	double star
ST398	35	1466	10 43.4	+04 44	6.3	7"	Sex	double star
ST399	R	R UMA	10 44.6	+68.8	7.5	*	Uma	variable star
ST400	VY	VY UMA	10 45.1	+67.4	5.9	*	Uma	variable star
ST401	Delta	Delta CHA	10 45.8	-80.5	4.5	4.5'	Cha	double star
ST402	40	1476	10 49.3	-04 01	6.9	2.5"	Sex	double star
ST403	Nu	Nu HYA	10 49.6	-16.2	3.1	*	Hya	star
ST404	54	54 LEO	10 55.6	+24.8	4.5	6.8"	Leo	double star
ST405	SAO251342	SAO 251342	11 17.5	-63.5	7	7"	Car	double star magnitude contrast
ST406	Xi	Xi UMA	11 18.2	+31.5	4.5	1.3"	Uma	double star challenge
ST407	Nu	Nu UMA	11 18.5	+33.1	3.5	7"	Uma	double star
ST408	1529		11 19.4	-01 38	7	10"	Leo	double star
ST409	h4432	h4432	11 23.4	-65	5.1	2.3"	Mus	double star
ST410	Iota	Iota LEO	11 23.9	+10.5	4	1.3"	Leo	double star challenge
ST411	83	1540	11 26.8	+03 00	6.2	29"	Leo	triple star
ST412	Tau	Tau LEO	11 27.9	+02.9	5.5	1.5'	Leo	double star
ST413	Lambda	Lambda DRA	11 31.4	+69.3	3.8	20'	Dra	red variable star
ST414	88	1547	11 31.8	+14 21	6.4	16"	Leo	double star
ST415	N		11 32.3	-29 16	5.8	9"	Hyd	double star equal magnitude
ST416	Innes78	Innes 78	11 33.6	-40.6	6	1"	Cen	double star challenge
ST417	1552	1552	11 34.7	+16 48	6	3"	Leo	triple star
ST418	Nu	Nu VIR	11 45.9	+06.5	4	*	Vir	star
ST419	Denebola	Beta Leo	11 49.1	+14 34	2.1	Stellar	Leo	star
ST420	Beta	Beta HYA	11 52.9	-33.9	4.7	0.9"	Hya	colored double star
ST421	O 112	O.Struve 112	11 54.6	+19.4	8.4	73"	Leo	double star
ST422	65	1579	11 55.1	+46 29	6.7	4"	Uma	double star
ST423	Epsilon	Epsilon CHA	11 59.6	-78.2	5.4	0.9"	Cha	colored double star
ST424	1593		12 03.5	-02 26	8.7	1.3"	Vir	double star challenge
ST425	Zeta	Zeta COM	12 04.3	+21.5	6	3.6"	Com	double star
ST426	Delta	Delta CEN	12 08.4	-50.7	2.6	4.5'	Cen	double star
ST427	1604		12 09.5	-11 51	6.6	10"	Crv	triple star
ST428	Epsilon	Epsilon CRV	12 10.1	-22.6	3	*	Crv	star
ST429	Rumker14	Rumker 14	12 14.0	-45.7	5.6	2.9"	Cen	double star
ST430	Delta	Delta CRU	12 15.1	-58.7	2.8	*	Cru	star
ST431	2	2 CVN	12 16.1	+40.7	6	11.5"	Cvn	colored double star
ST432	Epsilon	Epsilon MUS	12 17.6	-68	4.1	*	Mus	red variable star
ST433	1627		12 18.1	-03 56	6.6	20"	Vir	double star equal magnitude
ST434	R	R CRV	12 19.6	-19.3	6.7	*	Crv	variable star
ST435	1633		12 20.6	+27 03	6.3	9"	Com	double star equal magnitude
ST436	Epsilon	Epsilon CRU	12 21.4	-60.4	3.6	*	Cru	star
ST437	M40	Winnecke 4	12 22.4	+58 05	9	50"	UMa	double star
ST438	17	17 VIR	12 22.5	+05.3	6.5	21"	Vir	double star
ST439	1639	Struve 1639	12 24.4	+25.6	6.8	1.6"	Com	double star challenge
ST440	S	S CEN	12 24.6	-49.4	9.2	*	Cen	variable star
ST441	SS		12 25.3	+00 48	6	Stellar	Vir	red variable star
ST442	AcruX	Alpha CRU	12 26.6	-63.1	1	4.4"	Cru	double star
ST443	3C273	3C 273	12 29.1	+02.0	12.8	*	Vir	asterism
ST444	Algorab	Delta CRV	12 29.9	-16.5	3	24"	Crv	double star
ST445	Gamma	Gamma CRU	12 31.2	-57.1	1.6	110"	Cru	double star
ST446	1649	Struve 1649	12 31.6	-11.1	8	15"	Vir	double star
ST447	24		12 35.1	+18 23	5	20"	CVn	colored double star
ST448	Alpha	Alpha MUS	12 37.2	-69.1	2.7	*	Mus	star
ST449	ADS8612	ADS 8612	12 37.7	-27.1	5.5	1.3"	Hya	double star challenge
ST450	1669		12 41.3	-13 01	5.3	5"	Crv	double star equal magnitude
ST451	Gamma	Gamma CEN	12 41.5	-49	2.2	1"	Cen	double star challenge
ST452	Porrima	Gamma VIR	12 41.7	-1.4	3.5	3"	Vir	double star
ST453	Y		12 45.1	+45 26	7.4	Stellar	CVn	red variable star
ST454	Iota	Iota CRU	12 45.6	-61	4.7	27"	Cru	double star
ST455	Beta	Beta MUS	12 46.3	-68.1	3.7	1.4"	Mus	double star challenge
ST456	Mimosa	Beta CRU	12 47.7	-59.7	1.3	*	Cru	star
ST457	32	1694	12 49.2	+83 25	5.3	22"	Cam	double star equal magnitude
ST458	35	1687	12 53.3	+21 14	5.1	29"	Com	double star magnitude contrast
ST459	Mu	Mu CRU	12 54.6	-57.2	4.3	35"	Cru	double star
ST460	Delta	Delta VIR	12 55.6	+03.4	3.4	*	Vir	red variable star
ST461	Cor Caroli	Alpha CVN	12 56.0	+38.3	3	19"	Cvn	double star
ST462	RY	RY DRA	12 56.4	+66.0	6.8	*	Dra	variable star
ST463	1699		12 58.7	+27 28	8.8	1.5"	Com	double star challenge
ST464	Delta	Delta MUS	13 02.3	-71.5	3.6	8'	Mus	star
ST465	Theta	Theta MUS	13 08.1	-65.3	5.7	5.3"	Mus	double star

ST466	Theta	51 Vir,	1724	13 09.9	-05 32	4.4	7"	Vir	triple star challenge
ST467	Alpha			13 10.0	+17 32	5	0.5"	Com	double star challenge
ST468	54			13 13.4	-18 50	6.8	5"	Vir	double star
ST469	J	J CEN		13 22.6	-61	4.7	1'	Cen	double star
ST470	Zeta	Mizar		13 23.9	+54 56	2.3	14"	Uma	double star
ST471	Spica	Alpha VIR		13 25.2	-11.2	1	*	Vir	star
ST472	O 123			13 27.1	+64 43	6.7	69"	Dra	colored double star
ST473	R			13 29.7	-23 17	4		Stellar	variable star
ST474	1755	Struve 1755		13 32.3	+36.8	7	4.4"	Cvn	double star
ST475	S	S VIR		13 33.0	-7.2	6	*	Vir	variable star
ST476	25	25 CVN		13 37.5	+36.3	5	1.8"	Cvn	double star magnitude contrast
ST477	1763	Struve 1763		13 37.6	-7.9	7.9	2.8"	Vir	double star
ST478	Epsilon	Epsilon CEN		13 39.9	-53.5	2.3	*	Cen	star
ST479	1	1772		13 40.7	+19 57	5.7	5"	Boo	double star magnitude contrast
ST480	Dunlop141	Dunlop 141		13 41.7	-54.6	5.3	5.3"	Cen	double star
ST481	T	T CEN		13 41.8	-33.6	5.5	*	Cen	variable star
ST482	Alkaid	Eta UMA		13 47.5	+49.3	1.9	*	Uma	star
ST483	1785	Struve 1785		13 49.1	+27.0	7.6	3.4"	Boo	double star
ST484	2	2 CEN		13 49.4	-34.5	4.2	*	Cen	star
ST485	Upsilon	Upsilon BOO		13 49.5	+15.8	4.1	*	Boo	star
ST486	3	3 CEN		13 51.8	-33	4.5	8"	Cen	double star
ST487	Zeta	Zeta CEN		13 55.5	-47.3	2.6	5°	Cen	star
ST488	Beta	Beta CEN		14 03.8	-60.4	0.6	*	Cen	star
ST489	Pi	Pi HYA		14 06.4	-26.7	3.3	*	Hya	star
ST490	Kappa	Kappa VIR		14 12.9	-10.3	4.2	*	Vir	star
ST491	Kappa			14 13.5	+51 47	4.4	13"	Boo	colored double star
ST492	1819			14 15.3	+03 08	7.8	0.8"	Vir	double star challenge
ST493	Arcturus	Alpha Boo		14 15.7	+19 11	0	Stellar	Boo	star
ST494	Iota	Iota BOO		14 16.2	+51.4	4.9	39"	Boo	double star
ST495	R	R CEN		14 16.6	-59.9	5.3	*	Cen	variable star
ST496	1834	Struve 1834		14 20.3	+48.5	8.1	1.3"	Boo	double star challenge
ST497	1833			14 22.6	-07 46	7.6	6"	Vir	double star equal magnitude
ST498	Dunlop159	Dunlop 159		14 22.6	-58.5	5	9"	Cen	colored double star
ST499	1835			14 23.4	+08 26	5.1	6"	Boo	double star
ST500	SHJ 179			14 25.5	-19 58	6.4	35"	Lib	double star
ST501	5	5 UMI		14 27.5	+75.7	4.3	*	Umi	star
ST502	Proxima	Proxima CEN		14 29.9	-62.7	10.7	*	Cen	variable star
ST503	Rho	Rho BOO		14 31.8	+30.4	3.6	*	Boo	star
ST504	h4690			14 37.3	-46 08	5.4	19"	Lup	double star magnitude contrast
ST505	Alpha	Rigil Kentaurus		14 39.6	-60 50	0	20"	Cen	double star
ST506	Pi	Pi BOO		14 40.7	+16.4	5	5.6"	Boo	double star
ST507	pi	1864		14 40.7	+16 25	4.9	6"	Boo	double star
ST508	Zeta			14 41.1	+13 44	3.8	1"	Boo	double star challenge
ST509	Alpha	Alpha LUP		14 41.9	-47.4	2.3	*	Lup	star
ST510	q	q CEN		14 42.0	-37.8	4	*	Cen	star
ST511	Alpha	Alpha CIR		14 42.5	-65	3.2	16"	Cir	double star
ST512	c1	c1 CEN		14 43.7	-35.2	4	17"	Cen	star
ST513	Epsilon	Izar		14 45.0	+27 04	2.4	3"	Boo	colored double star
ST514	Dunlop	Dunlop 169		14 45.2	-55.6	6.2	68"	Cir	double star
ST515	54	H 97		14 46.0	-25 26	5.2	8"	Hya	double star
ST516	Alpha	Alpha APS		14 47.9	-79	3.8	10°	Aps	star
ST517	1883			14 48.9	+05 57	7.6	0.7"	Vir	double star challenge
ST518	Mu			14 49.3	-14 09	5.4	2"	Lib	double star challenge
ST519	39			14 49.7	+48 43	5.7	3"	Boo	double star
ST520	58	58 HYA		14 50.3	-28	4.4	*	Hya	star
ST521	Kochab	Beta UMI		14 50.7	+74.2	2.1	*	Umi	star
ST522	Zubenelgenubi	Alpha LIB		14 50.9	-16	2.8	4'	Lib	double star
ST523	Xi	37 Boo		14 51.4	+19 06	4.6	7"	Boo	colored double star
ST524	h4715	h4715		14 56.5	-47.9	6	2.4"	Lup	double star
ST525	33	H 28		14 57.3	-21 22	5.9	23"	Lib	double star
ST526	Beta	Beta LUP		14 58.5	-43.1	2.6	*	Lup	star
ST527	Pi	Pi OCT		15 01.8	-83.2	5.7	18'	Oct	double star
ST528	44			15 03.8	+47 39	4.8	1.5"	Boo	double star challenge
ST529	Sigma	Sigma LIB		15 04.1	-25.3	3.2	*	Lib	red variable star
ST530	Dunlop178	Dunlop 178		15 11.6	-45.3	6.7	32"	Lup	double star
ST531	Kappa	Kappa LUP		15 11.9	-48.7	3.9	27"	Lup	double star
ST532	X	X TRA		15 14.3	-70.1	8.1	*	Tra	variable star
ST533	1932			15 18.3	+26 50	6.6	1.5"	CrB	double star challenge
ST534	Mu	Mu LUP		15 18.5	-47.9	5.1	1.2"	Lup	double star challenge
ST535	1931			15 18.7	+10 26	7	13"	Ser	double star
ST536	S	S CRB		15 21.4	+31.4	5.8	*	CrB	variable star
ST537	Phi1	Phi1 LUP		15 21.8	-36.3	3.6	50'	Lup	star
ST538	Eta			15 23.2	+30 17	5.6	1.0"	CrB	double star challenge
ST539	Mu			15 24.5	+37 23	4.3	2"	Boo	triple star
ST540	Edasich	Iota DRA		15 24.9	+59.0	3.3	*	Dra	star

ST541	Pi	1972	15 29.2	+80 26	6.9	31"	Umi	double star
ST542	Lal123		15 33.1	-24 29	7.5	9"	Lib	double star equal magnitude
ST543	Delta	Delta SER	15 34.8	+10.5	4	3.9"	Ser	double star
ST544	Gamma	Gamma LUP	15 35.1	-41.2	2.8	*	Lup	star
ST545	h4788	h4788	15 35.9	-45	4.7	2.2"	Lup	double star
ST546	Upsilon	Upsilon LIB	15 37.0	-28.1	3.6	3"	Lib	colored double star
ST547	Omega	Omega LUP	15 38.1	-42.6	4.3	*	Lup	red variable star
ST548	1962		15 38.7	-08 47	5.8	12"	Lib	double star equal magnitude
ST549	Tau	Tau LIB	15 38.7	-29.8	3.7	2°	Lib	star
ST550	Zeta	Zeta CRB	15 39.4	+36.6	5	6.3"	Crb	double star
ST551	Gamma	Gamma CRB	15 42.7	+26.3	4.2	0.3"	Crb	double star challenge
ST552	Alpha	Alpha SER	15 44.3	+06.4	2.7	*	Ser	star
ST553	R		15 48.6	+28 09	5.7	Stellar	CrB	variable star
ST554	Kappa	Kappa SER	15 48.7	+18.1	4.1	*	Ser	red variable star
ST555	R	R SER	15 50.7	+15.1	5.2	*	Ser	variable star
ST556	Xi		15 56.9	-33 58	5.2	10"	Lup	double star
ST557	Rho	Rho SCO	15 56.9	-29.2	3.9	*	SCO	star
ST558	Epsilon	Epsilon CRB	15 57.6	+26.9	4.2	*	Crb	star
ST559	Pi	Pi SCO	15 58.9	-26.1	2.9	*	SCO	star
ST560	T		15 59.5	+25 55	2	Stellar	CrB	variable star
ST561	Eta	Rmk 21	16 00.1	-38 24	3.6	15"	Lup	double star magnitude contrast
ST562	Delta	Delta SCO	16 00.3	-22.6	2.3	*	SCO	star
ST563	Xi		16 04.4	-11 22	4.2	1"	SCO	triple star challenge
ST564	Graffias	Beta SCO	16 05.4	-19.8	2.5	*	SCO	star
ST565	Omega1	Omega1 SCO	16 06.8	-20.7	4	14'	SCO	star
ST566	Kappa		16 08.1	+17 03	5	28"	Her	colored double star
ST567	Nu		16 12.0	-19 28	4	1"	SCO	quadruple star
ST568	Delta	Delta OPH	16 14.3	-3.7	2.7	*	Oph	star
ST569	Sigma	2032, 17 CrB	16 14.7	+33 52	5.2	7"	CrB	double star
ST570	Delta	Delta APS	16 20.3	-78.7	4.7	*	Aps	double star
ST571	Sigma	H 121	16 21.2	-25 35	2.9	20"	SCO	double star magnitude contrast
ST572	Rho	Rho OPH	16 25.6	-23.5	5.3	3.1"	Oph	double star
ST573	V	V OPH	16 26.7	-12.4	7.3	*	Oph	variable star
ST574	Epsilon	Epsilon NOR	16 27.2	-47.6	4.8	23"	Nor	double star
ST575	Iota	Iota TRA	16 28.0	-64.1	5.3	20"	Tra	double star
ST576	2052	Struve 2052	16 28.9	+18.4	7.7	1.7"	Her	double star
ST577	Antares	Alpha SCO	16 29.4	-26.4	1	3"	SCO	double star challenge
ST578	Lambda	Lambda OPH	16 30.9	+02.0	4.2	1.4"	Oph	double star challenge
ST579	R	R DRA	16 32.7	+66.8	6.7	*	Dra	variable star
ST580	16		16 36.2	+52 55	5.1	3"	Dra	triple star
ST581	H	H SCO	16 36.4	-35.3	4.2	*	SCO	star
ST582	Zeta	Zeta OPH	16 37.2	-10.6	2.6	*	Oph	star
ST583	SU	SU SCO	16 40.6	-32.4	8	*	SCO	variable star
ST584	Zeta	Zeta HER	16 41.3	+31.6	3	1.4"	Her	colored double star
ST585	Alpha	Alpha TRA	16 48.7	-69	1.9	*	Tra	star
ST586	Eta	Eta ARA	16 49.8	-59	3.8	*	Ara	star
ST587	Epsilon	Epsilon SCO	16 50.2	-34.3	2.3	*	SCO	star
ST588	Mu	Mu SCO	16 52.3	-38	3	*	SCO	star
ST589	20	20 DRA	16 56.4	+65.0	7.1	1.4"	Dra	double star challenge
ST590	RR	RR SCO	16 56.6	-30.6	5.1	*	SCO	variable star
ST591	Kappa	Kappa OPH	16 57.7	+09.4	3.2	75'	Oph	star
ST592	Zeta	Zeta ARA	16 58.6	-56	3.1	*	Ara	star
ST593	Epsilon1	Epsilon1 ARA	16 59.6	-53.2	4.1	40'	Ara	star
ST594	Mu		17 05.3	+54 28	4.9	2"	Dra	double star equal magnitude
ST595	Eta	Eta OPH	17 10.4	-15.7	2.4	0.6"	Oph	double star challenge
ST596	Rasalgethi	Alpha HER	17 14.6	+14.4	3	4.6"	Her	double star equal magnitude
ST597	Delta		17 15.0	+24 50	3.2	10"	Her	double star magnitude contrast
ST598	Pi	Pi HER	17 15.0	+36.8	3.2	7°	Her	star
ST599	36		17 15.3	-26 36	4.3	5"	Oph	double star equal magnitude
ST600	39		17 18.0	-24 17	5.2	10"	Oph	colored double star
ST601	Theta	Theta OPH	17 22.0	-25	3.3	*	Oph	star
ST602	Rho	2161, 75 Her	17 23.7	+37 09	4.2	4"	Her	double star
ST603	Beta	Beta ARA	17 25.3	-55.5	2.9	*	Ara	star
ST604	Gamma	Gamma ARA	17 25.4	-56.4	3.3	*	Ara	star
ST605	Sigma	Sigma OPH	17 26.5	+04.1	4.3	4°	Oph	star
ST606	h4949	h4949	17 26.9	-45.9	6	2.2"	Ara	double star
ST607	2173		17 30.4	-01 04	6	1.1"	Oph	double star challenge
ST608	Lambda	Lambda HER	17 30.7	+26.1	4.4	*	Her	star
ST609	Upsilon	Upsilon SCO	17 30.8	-37.3	2.7	*	SCO	star
ST610	Alpha	Alpha ARA	17 31.8	-49.9	3	*	Ara	star
ST611	Nu		17 32.2	+55 11	4.9	62"	Dra	double star equal magnitude
ST612	Shaula	Lambda SCO	17 33.6	-37.1	1.6	35'	SCO	star
ST613	Rasalhague	Alpha Oph	17 34.9	+12 34	2.1	*	Oph	star
ST614	Iota	Iota HER	17 39.5	+46.0	3.8	*	Her	star

ST615	Psi	2241	17 41.9	+72 09	4.9	30"	Dra	double star
ST616	Kappa	Kappa SCO	17 42.5	-39	2.4	2.5°	SCO	star
ST617	V	V PAV	17 43.3	-57.7	5.7	*	Pav	variable star
ST618	Beta	Beta OPH	17 43.5	+04.6	2.8	*	Oph	star
ST619	61	2202	17 44.6	+02 34	6.2	21"	Oph	double star equal magnitude
ST620	SZ	SZ SGR	17 45.0	-18.6	9	*	Sgr	variable star
ST621	SX	SX SCO	17 47.5	-35.7	8.5	*	SCO	variable star
ST622	G	G SCO	17 49.9	-37	3.2	2°	SCO	star
ST623	Y	Y OPH	17 52.6	-6.2	6	*	Oph	variable star
ST624	Xi	Xi DRA	17 53.5	+56.9	3.8	*	Dra	star
ST625	Gamma	Gamma DRA	17 56.6	+51.5	2.2	*	Dra	star
ST626	Barnards Star		17 57.8	+04 34	9.5	Stellar	Oph	star
ST627	h5003		17 59.1	-30 15	5	6"	Sgr	colored double star
ST628	2038	Struve 2038	18 00.0	+80.0	5.7	20"	Dra	double star equal magnitude
ST629	95		18 01.5	+21 36	4.3	6"	Her	double star equal magnitude
ST630	Tau	Tau OPH	18 03.1	-8.2	5.2	1.8"	Oph	double star challenge
ST631	70	2276	18 05.5	+02 30	4	1.5"	Oph	double star challenge
ST632	Theta	Theta ARA	18 06.6	-50.1	3.7	*	Ara	star
ST633	100	2280	18 07.8	+26 06	5.9	14"	Her	double star equal magnitude
ST634	W	W LYR	18 14.9	+36.7	7.3	*	Lyr	variable star
ST635	Eta	Eta SGR	18 17.6	-36.8	3.1	*	Sgr	star
ST636	Kappa	Kappa LYR	18 19.9	+36.1	4.3	*	Lyr	star
ST637	Delta	Delta SGR	18 21.0	-29.8	2.7	*	Sgr	star
ST638	2306		18 22.2	-15 05	7.9	10"	Sct	double star
ST639	Xi	Xi PAV	18 23.2	-61.5	4.4	*	Pav	star
ST640	39	2323	18 24.0	+58 48	4.9	4"	Dra	triple star
ST641	21	21 SGR	18 25.3	-20.5	4.9	1.8"	Sgr	double star challenge
ST642	Alpha	Alpha TEL	18 27.0	-46	3.5	6'	Tel	star
ST643	59		18 27.2	+00 12	5.2	4"	Ser	colored double star
ST644	Lambda	Lambda SGR	18 28.0	-25.4	2.8	*	Sgr	star
ST645	SS	SS SGR	18 30.4	-16.9	9	*	Sgr	variable star
ST646	Delta	Delta TEL	18 31.8	-45.9	5	11'	Tel	double star
ST647	T	T LYR	18 32.3	+37.0	7.8	*	Lyr	red variable star
ST648	Kappa	222	18 33.4	-38 44	5.9	21"	CrA	double star equal magnitude
ST649	2348		18 33.9	+52 18	6	26"	Dra	double star
ST650	Alpha	Alpha SCT	18 35.2	-8.2	3.9	*	Sct	star
ST651	O 359		18 35.5	+23 36	6.3	0.7"	Her	double star challenge
ST652	O 358	ADS 11483	18 35.9	+17.0	6.8	1.6"	Her	double star challenge
ST653	Vega	Alpha Lyr	18 36.9	+38 47	0	Stellar	Lyr	star
ST654	X	X OPH	18 38.3	+08.8	5.9	*	Oph	variable star
ST655	HK	HK LYR	18 42.8	+37.0	9.5	*	Lyr	variable star
ST656	2398	Struve 2398	18 43.0	+59.6	8	13"	Dra	double star
ST657	Epsilon	Double-Double,	18 44.3	+39 40	4.7	2"	Lyr	quadruple star
ST658	Zeta		18 44.8	+37 36	4.4	44"	Lyr	double star
ST659	2375		18 45.5	+05 30	6.2	2"	Ser	double star equal magnitude
ST660	5	2379	18 46.5	-00 58	5.8	13"	Aql	triple star
ST661	R		18 47.5	-05 42	4.5	Stellar	Sct	variable star
ST662	Beta		18 50.0	+33 24	3.5	47"	Lyr	double star magnitude contrast
ST663	S	S SCT	18 50.3	-7.9	6.8	14.3"	Sct	double star
ST664	2404		18 50.8	+10 59	6.9	4"	Aql	double star
ST665	Omicron	2420	18 51.2	+59 22	4.9	35"	Dra	double star
ST666	Delta2	Delta2 LYR	18 54.5	+36.9	4.5	*	Cyg	star
ST667	O 525		18 54.9	+33 58	6	45"	Lyr	colored double star
ST668	Sigma	Sigma SGR	18 55.3	-26.3	2	*	Sgr	star
ST669	13	13 LYR	18 55.3	+43.9	3.9	4..	Lyr	star
ST670	Theta	2417, 63 Ser	18 56.3	+04 11	4.1	22"	Ser	double star
ST671	ADS11871	ADS 11871	18 57.0	+32.9	5.4	1"	Lyr	double star challenge
ST672	2422	Struve 2422	18 57.1	+26.1	8	0.7"	Lyr	double star challenge
ST673	UV	UV AQL	18 58.6	+14.4	8.6	*	Aql	variable star
ST674	2426		19 00.0	+12 53	7.1	17"	Aql	colored double star
ST675	BrsO14		19 01.1	-37 03	6.6	13"	Cra	double star equal magnitude
ST676	h5082		19 03.1	-19 14	6	7"	Sgr	triple star
ST677	V		19 04.4	-05 41	6.6	Stellar	Aql	red variable star
ST678	15		19 05.0	-04 02	5.4	38"	Aql	colored double star
ST679	Gamma		19 06.4	-37 00	5	3"	Aql	double star equal magnitude
ST680	R		19 06.4	+08 14	5.5	Stellar	Aql	red variable star
ST681	2449		19 06.4	+07 09	7.2	8"	Aql	double star
ST682	2474		19 09.1	+34 35	6.5	16"	Lyr	double star
ST683	2486		19 12.1	+49 51	6.6	8"	Cyg	double star equal magnitude
ST684	O 178	O.Struve 178	19 15.3	+15.1	5.7	90"	Aql	double star
ST685	Tau	Tau DRA	19 15.5	+73.4	4.5	*	Dra	star
ST686	RY	RY SGR	19 16.5	-33.5	6	*	Sgr	variable star
ST687	U		19 18.8	+19 37	6.6	Stellar	Sge	variable star
ST688	V1942	V1942 SGR	19 19.2	-15.9	6.4	*	Sgr	variable star
ST689	UX		19 21.6	+76 34	5.9	Stellar	Dra	red variable star

ST690 RR		19 25.5	+42 47	7.1	Stellar	Lyr	variable star
ST691 2525	Struve 2525	19 26.6	+27.3	8.1	2"	Vul	double star
ST692 h5114	h5114	19 27.8	-54.3	5.7	70"	Tel	double star
ST693 Alpha	Alpha VUL	19 28.7	+24.7	4.4	*	Vul	star
ST694 Albireo	Beta CYG	19 30.7	+28.0	3	35"	Cyg	colored double star
ST695 Mu	Mu AQL	19 34.1	+07.4	4.5	*	Aql	star
ST696 AQ	AQ SGR	19 34.3	-16.4	9.1	*	Sgr	variable star
ST697 R	R CYG	19 36.8	+50.2	6.1	*	Cyg	variable star
ST698 HN84		19 39.4	+16 34	6.4	28"	Sge	colored double star
ST699 54	54 SGR	19 40.7	-16.3	5.4	38"	Sgr	double star
ST700 TT	TT CYG	19 40.9	+32.6	7.8	*	Cyg	variable star
ST701 16		19 41.8	+50 32	6	39"	Cyg	double star equal magnitude
ST702 Delta	2579, 18 Cyg	19 45.0	+45 08	2.9	2"		Cyg double star magnitude contrast
ST703 O 191	H V 137	19 45.9	+35 01	6	39"	Cyg	colored double star
ST704 Gamma	Gamma AQL	19 46.3	+10.6	2.7	*	Aql	star
ST705 17	2580	19 46.4	+33 44	5	26"	Cyg	double star magnitude contrast
ST706 Delta	Delta SGE	19 47.4	+18.5	3.8	*	Sge	star
ST707 Epsilon		19 48.2	+70 16	3.8	3"	Dra	double star magnitude contrast
ST708 Pi	Pi AQL	19 48.7	+11.8	6.1	1.4"	Aql	double star challenge
ST709 Zeta		19 49.0	+19 09	5	9"	Sge	double star
ST710 Chi		19 50.6	+32 55	3.3	Stellar	Cyg	variable star
ST711 Altair	Alpha Aql	19 50.8	+08 52	0.8	*	Aql	star
ST712 Eta	Eta AQL	19 52.5	+01.0	3.4	*	Aql	variable star
ST713 57		19 54.6	-08 14	5.7	36"	Aql	double star
ST714 Beta	Beta AQL	19 55.3	+06.4	3.7	13"	Aql	double star
ST715 Psi		19 55.6	+52 26	4.9	3"	Cyg	double star magnitude contrast
ST716 RR	RR SGR	19 55.9	-29.2	5.4	*	Sgr	variable star
ST717 RU	RU SGR	19 58.7	-41.9	6	*	Sgr	variable star
ST718 Gamma	Gamma SGE	19 58.8	+19.5	3.5	*	Sge	star
ST719 BF	BF SGE	20 02.4	+21.1	8.5	*	Sge	variable star
ST720 h1470		20 03.6	+38 19	7.6	29"	Cyg	colored double star
ST721 X	X SGE	20 05.1	+20.7	7	*	Sge	variable star
ST722 WZ	WZ SGE	20 07.6	+17.7	7	*	Sge	variable star
ST723 Kappa	2675	20 08.9	+77 43	4.4	7"	Cep	double star magnitude contrast
ST724 Theta	2637	20 09.9	+20 55	6.4	12"	Sge	triple star
ST725 RY	RY CYG	20 10.4	+36.0	8.5	*	Cyg	variable star
ST726 FG	FG SGE	20 11.9	+20.3	9.5	*	Sge	planetary nebula irregular
ST727 2644		20 12.6	+00 52	6.8	3"	Aql	double star equal magnitude
ST728 RS	RS CYG	20 13.4	+38.7	6.5	*	Cyg	variable star
ST729 2658		20 13.6	+53 07	7.1	5"	Cyg	double star
ST730 Omicron1	Omicron1 CYG	20 13.6	+46.7	3.8	*		Cyg star
ST731 RT	RT CAP	20 17.1	-21.3	8.9	*	Cap	variable star
ST732 Alpha	Alpha CAP	20 17.6	-12.5	4.2	44"	Cap	star
ST733 RT	RT SGR	20 17.7	-39.1	6	*	Sgr	variable star
ST734 P		20 17.8	+38 02	3	Stellar	Cyg	variable star
ST735 Alpha		20 18.0	-12 32	3.8	7"	Cap	quadruple star
ST736 2671		20 18.4	+55 23	6	4"	Cyg	double star
ST737 U	U CYG	20 19.6	+47.9	5.9	*	Cyg	variable star
ST738 Beta	Beta CAP	20 21.0	-14.8	3.4	3'	Cap	double star
ST739 39	39 CYG	20 23.9	+32.2	4.4	*	Cyg	star
ST740 Peacock	Alpha PAV	20 25.6	-56.7	1.9	*	Pav	star
ST741 pi		20 27.3	-18 13	5.3	3"	Cap	double star magnitude contrast
ST742 Omicron	SHJ 324	20 29.9	-18 35	6.1	19"	Cap	double star
ST743 49	2716	20 41.0	+32 18	5.5	3"	Cyg	double star magnitude contrast
ST744 V	V CYG	20 41.3	+48.2	7.7	*	Cyg	variable star
ST745 Deneb	Alpha Cyg	20 41.4	+45 17	1.3	*	Cyg	star
ST746 52	52 CYG	20 45.7	+30.7	4.2	6"	Cyg	double star
ST747 Gamma		20 46.7	+16 07	4.3	10"	Del	double star
ST748 Lambda	Lambda CYG	20 47.4	+36.5	4.9	0.9"	Cyg	double star challenge
ST749 3	3 AQR	20 47.7	-5	4.4	*	Aqr	red variable star
ST750 S763		20 48.4	-18 11	6.7	16"	Cap	double star
ST751 4	4 AQR	20 51.4	-5.6	6.4	0.8"	Aqr	double star challenge
ST752 Omega	Omega CAP	20 51.8	-26.9	4.1	*	Cap	star
ST753 Epsilon	1 Equ	20 59.1	+04 18	5.2	1"	Equ	triple star challenge
ST754 2751	Struve 2751	21 02.1	+56.7	6.1	1.5"	Cep	double star challenge
ST755 2	2742	21 02.2	+07 11	7.4	3"	Equ	double star equal magnitude
ST756 Dunlop236	Dunlop 236	21 02.2	-43	6	57"	Mic	double star
ST757 Lambda	Lambda EQU	21 02.2	+07.2	7.4	3"	Equ	double star
ST758 12		21 04.1	-05 49	5.9	3"	Aqr	double star challenge
ST759 Xi	Xi CYG	21 04.9	+43.9	3.7	*	Cyg	star
ST760 61	2758	21 06.9	+38 39	5.2	29"	Cyg	double star
ST761 24	24 CAP	21 07.1	-25	4.5	*	Cap	stellar planetary nebula
ST762 T	T CEP	21 09.5	+68.5	5.2	*	Cep	variable star
ST763 Gamma	Gamma EQU	21 10.3	+10.1	4.7	6'	Equ	double star

ST764	2780	Struve 2780	21 11.8	+60.0	5.6	1.0"	Cep	double star challenge
ST765	Delta		21 14.5	+10 00	4.6	48"	Equ	double star magnitude contrast
ST766	Theta	Theta IND	21 19.9	-53.5	4.5	6"	Ind	double star
ST767	RY	RY AQR	21 20.3	-10.8	8	*	Aqr	variable star
ST768	Y	Y PAV	21 24.3	-69.7	8.6	*	Pav	variable star
ST769	Beta		21 28.7	+70 33	3.3	13"	Cep	double star magnitude contrast
ST770	S		21 35.2	+78 37	7.4	Stellar	Cep	red variable star
ST771	2816		21 39.0	+57 29	5.6	12"	Cep	triple star
ST772	V460	V460 CYG	21 42.0	+35.5	5.6	*	Cyg	variable star
ST773	SS		21 42.7	+43 35	8.2	Stellar	Cyg	variable star
ST774	RV	RV CYG	21 43.3	+38.0	7.1	*	Cyg	variable star
ST775	Mu	Herschel's Garnet Star	21 43.5	+58 47	3.4	Stellar	Cep	red variable star
ST776	Epsilon		21 44.2	+09 52	2.5	83"	Peg	double star magnitude contrast
ST777	Lambda	Lambda OCT	21 50.9	-82.7	5.4	3"	Oct	double star
ST778	AG	AG PEG	21 51.0	+12.6	6	*	Peg	variable star
ST779	2840		21 52.0	+55 47	5.5	18"	Cep	double star
ST780	2841	Struve 2841	21 54.3	+19.7	6.4	22"	Peg	double star
ST781	RX	RX PEG	21 56.4	+22.9	8	*	Peg	variable star
ST782	2873		21 58.4	+82 51	7.1	14"	Cep	double star equal magnitude
ST783	Eta	β 276	22 00.8	-28 27	5.8	1.9"	Psa	double star
ST784	29	S 802	22 02.5	-16 58	7.2	4"	Aqr	double star equal magnitude
ST785	Xi							
17 Cep,	2863	22 03.8	+64 38	4.3	8"	Cep	double star	
ST786	O 461	O.Struve 461	22 03.9	+59.8	6.7	11.1"	Cep	double star
ST787	Lambda	Lambda GRU	22 06.1	-39.5	4.5	*	Gru	star
ST788	Al Nair	Alpha Gru	22 08.2	-46 58	1.7	Stellar	Gru	star
ST789	2883		22 10.7	+70 07	5.7	15"	Cep	double star
ST790	Zeta	Zeta CEP	22 10.9	+58.2	3.4	*	Cep	star
ST791	h1746	h1746	22 13.9	+39.7	4.5	28"	Lac	double star
ST792	41		22 14.3	-21 04	5.3	5"	Aqr	colored double star
ST793	1	1 LAC	22 16.0	+37.7	4.1	*	Lac	star
ST794	Alpha	Alpha TUC	22 18.5	-60.3	2.9	5'	Tuc	star
ST795	2894		22 18.9	+37 46	6.1	16"	Lac	colored double star
ST796	Pi	Pi GRU	22 23.1	-45.9	5.8	2.7"	Gru	double star
ST797	S	S GRU	22 26.1	-48.4	6	*	Gru	variable star
ST798	53		22 26.6	-16 45	6.4	3"	Aqr	double star equal magnitude
ST799	Delta	Delta TUC	22 27.3	-65	4.5	7"	Tuc	double star
ST800	Kruger60	Kruger 60	22 28.1	+57.7	9.8	3"	Cep	double star
ST801	Zeta		22 28.8	-00 01	4.3	2"	Aqr	double star challenge
ST802	Delta		22 29.2	+58 25	3.8	20"	Cep	colored double star
ST803	5	5 LAC	22 29.5	+47.7	4.4	5'	Lac	star
ST804	Delta2	Delta2 GRU	22 29.8	-43.7	4.1	15'	Gru	red variable star
ST805	37	37 PEG	22 30.0	+04.4	5.8	1"	Peg	double star challenge
ST806	Roe47		22 32.5	+39 46	5.8	43"	Lac	quadruple star
ST807	8		22 35.9	+39 38	6.5	22"	Lac	triple star
ST808	11	11 LAC	22 40.5	+44.3	4.5	*	Lac	star
ST809	Beta	Beta GRU	22 42.7	-46.9	2.1	*	Gru	star
ST810	Tau1	Tau1 AQR	22 47.7	-14.1	5.7	23"	Aqr	double star
ST811	2947	Struve 2947	22 49.0	+68.6	7	4.3"	Cep	double star
ST812	Tau2	Tau2 AQR	22 49.6	-13.6	4	40'	Aqr	star
ST813	2950	Struve 2950	22 51.4	+61.7	6.1	1.7"	Cep	double star
ST814	h1823		22 51.8	+41 19	7.1	82"	Lac	quadruple star
ST815	Lambda	Lambda AQR	22 52.6	-7.6	3.7	*	Aqr	star
ST816	Fomalhaut	Alpha PsA	22 57.6	-29 37	1.2	*	PsA	star
ST817	52	52 PEG	22 59.2	+11.7	6.1	0.7"	Peg	double star challenge
ST818	Scheat	Beta PEG	23 03.8	+28.1	2.4	*	Peg	star
ST819	Dunlop246	Dunlop 246	23 07.2	-50.7	6.1	9"	Gru	double star
ST820	2978		23 07.5	+32 49	6.3	8"	Peg	double star
ST821	Pi	Pi CEP	23 07.9	+75.4	4.6	1.2"	Cep	double star challenge
ST822	Phi	Phi AQR	23 14.3	-6	4.2	*	Aqr	red variable star
ST823	Psi3	Psi3 AQR	23 19.0	-9.6	5	1.5"	Aqr	double star
ST824	94		23 19.1	-13 28	5.1	13"	Aqr	colored double star
ST825	Dunlop249	Dunlop 249	23 23.9	-53.8	6.5	27"	Gru	double star
ST826	99	99 AQR	23 26.0	-20.6	4.4	*	Aqr	star
ST827	Z		23 33.7	+48 49	8	Stellar	And	variable star
ST828	Gamma	Gamma CEP	23 39.3	+77.6	3.2	*	Cep	star
ST829	Theta	Theta PHE	23 39.5	-46.6	6.6	4"	Phe	double star
ST830	R		23 43.8	-15 17	5.8	Stellar	Aqr	variable star
ST831	107		23 46.0	-18 41	5.3	7"	Aqr	double star equal magnitude
ST832	TX	19 Psc	23 46.4	+03 29	6.9	Stellar	Psc	red variable star
ST833	3042		23 51.8	+37 53	7.8	5"	And	double star equal magnitude
ST834	Lal192		23 54.4	-27 03	6.9	7"	Sci	double star
ST835	R		23 58.4	+51 24	4.7	Stellar	Cas	variable star
ST836	Sigma		23 59.0	+55 45	4.9	3"	Cas	colored double star
ST837	3050		23 59.5	+33 43	6.6	1.5"	And	double star challenge

# WARRANTY / REPAIR

## TELESCOPE LIFETIME LIMITED WARRANTY

Your Bushnell® telescope is warranted to be free of defects in materials and workmanship for the lifetime of the original owner. The Lifetime Limited Warranty is an expression of our confidence in the materials and mechanical workmanship of our products and is your assurance of a lifetime of dependable service.

If your telescope contains electrical components the electronic components are warranted to be free of defects in materials and workmanship for one year after the date of purchase.

In the event of a defect under this warranty, we will, at our option, repair or replace the product, provided that you return the product postage prepaid. This warranty does not cover damages caused by misuse or improper handling, installation or maintenance of the product.

Any return made under this warranty  
must be accompanied by the items listed below:

- 1) A check in the amount of \$15.00 to cover the cost of handling
- 2) Name and address for product return
- 3) An explanation of the defect
- 4) Product should be well packed in a sturdy outside shipping carton to prevent damage in transit and return postage prepaid to the address listed below:

**IN U.S.A. Send To:**

Bushnell Performance Optics  
8500 Marshall Drive  
Lenexa, Kansas 66214

**IN CANADA Send To:**

Bushnell Performance Optics  
25A East Pearce Street, Unit 1  
Richmond Hill, Ontario L4B 2M9

For products purchased outside the United States and Canada please contact your local dealer for applicable warranty information. This warranty gives you specific legal rights. You may have other rights which vary from country to country.

©2001 Bushnell Performance Optics



# NOTES

**For further questions or additional information please contact:**

**Bushnell Performance Optics  
8500 Marshall Drive  
Lenexa, Kansas 66214  
(800) 423-3537 • [www.bushnell.com](http://www.bushnell.com)**

## Free Manuals Download Website

<http://myh66.com>

<http://usermanuals.us>

<http://www.somanuals.com>

<http://www.4manuals.cc>

<http://www.manual-lib.com>

<http://www.404manual.com>

<http://www.luxmanual.com>

<http://aubethermostatmanual.com>

Golf course search by state

<http://golfingnear.com>

Email search by domain

<http://emailbydomain.com>

Auto manuals search

<http://auto.somanuals.com>

TV manuals search

<http://tv.somanuals.com>