

Introduction

With your PT-90, you can create labels for any application. Select from the many frames, character sizes and styles to design beautiful custom labels. In addition, the variety of tape cartridges available allows you to print labels with different widths and exciting colors. Read this manual carefully before starting and keep the manual in a handy place for future reference. The contents of this guide and the specifications of this product are subject to change without notice.

FCC NOTICE
This device complies with Part 15 of the FCC Rules. Operation is subject to the following two conditions: (1) this device may not cause harmful interference, and (2) this device must accept any interference received, including interference that may cause undesired operation.

This equipment has been tested and found to comply with the limits for a Class B digital device, pursuant to Part 15 of the FCC Rules. These limits are designed to provide reasonable protection against harmful interference in a residential installation. This equipment generates, uses, and can radiate radio frequency energy and, if not installed and used in accordance with the instructions, may cause harmful interference to radio communications. However, there is no guarantee that interference will not occur in a particular installation. If this equipment does cause harmful interference to radio or television reception, which can be determined by turning the equipment off and on, the user is encouraged to try to correct the interference by one or more of the following measures:

- Reorient or relocate the receiving antenna.
- Increase the separation between the equipment and receiver.
- Consult the dealer or an experienced radio/TV technician for help.

Important
• Changes or modifications not expressly approved by Brother Industries, Ltd. could void the user's authority to operate the equipment.

Printed in China
LW4039001

Power Supply and Tape Cassette

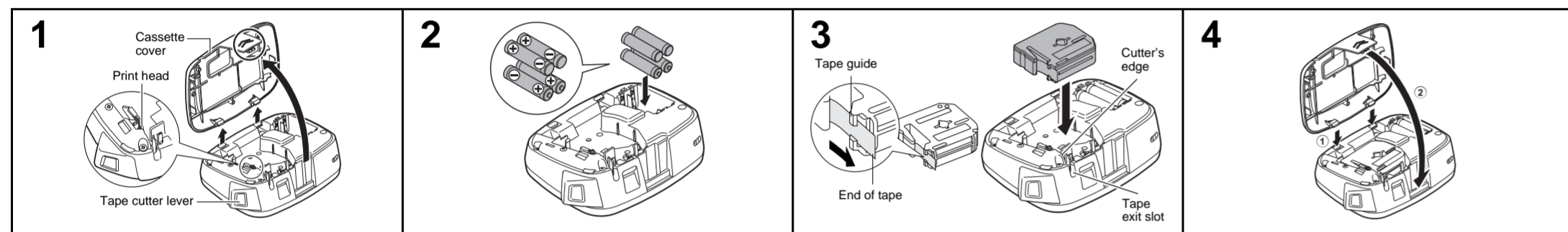

1 Remove the cassette cover by pressing the above indicated area.
If a tape cassette is already installed, remove it by pulling it straight up. Also, if batteries are already installed, remove them.
• Make sure that the power is turned off when replacing batteries or tape cassettes.

2 Insert four new AAA alkaline batteries (LR03), making sure that their poles point in the correct directions.
• Always replace all four batteries at the same time using brand new ones.

3 Insert a tape cassette, making sure that its snaps into place.
• Make sure that the end of the tape feeds under the tape guides.
• Use only Brother M tapes with this machine.

4 Insert the two hooks at the bottom of the cassette cover into the slots on the machine (1), and then close the cover securely until it snaps into place (2).
After you have installed the tape, feed the tape (see "Feeding") once and then push in the tape cutter lever to cut the tape.

Changeable Faceplates

The PT-90 comes with a variety of different faceplates - enabling users to customize the machine. To change the faceplates, follow the steps below.

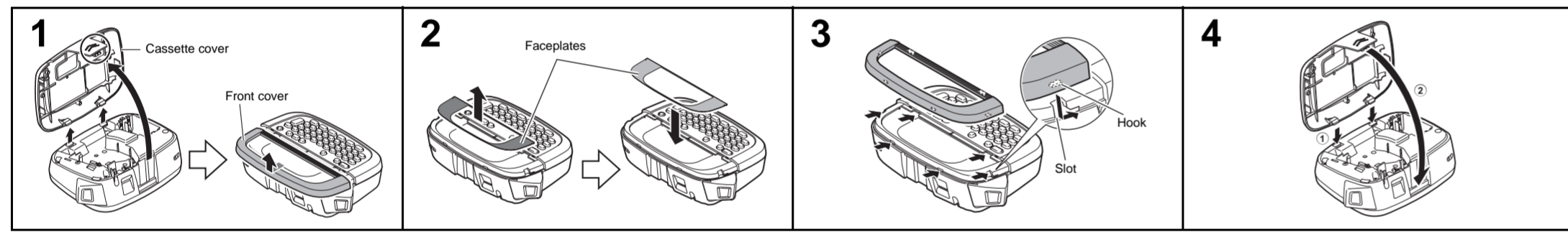

1 Remove the cassette cover by pressing the above indicated area. Slide the front cover back and lift up from machine.
• Make sure that the power is turned off when replacing the faceplate.

2 Remove the inserted faceplate, and then replace it with another one.
• Be sure to remove the protective film from the front side of the faceplate before replacing.
• Do not insert more than one faceplate at a time. If the front cover is forcedly closed with more than one faceplate inserted, the faceplates may get wrinkled or the front cover will not be able to be closed firmly.

3 Insert the hooks on the front cover into the slots on the machine, and slide back the cover into place.

4 Insert the two hooks at the bottom of the cassette cover into the slots on the machine (1), and then close the cover securely until it snaps into place (2).

LCD Display & Keyboard

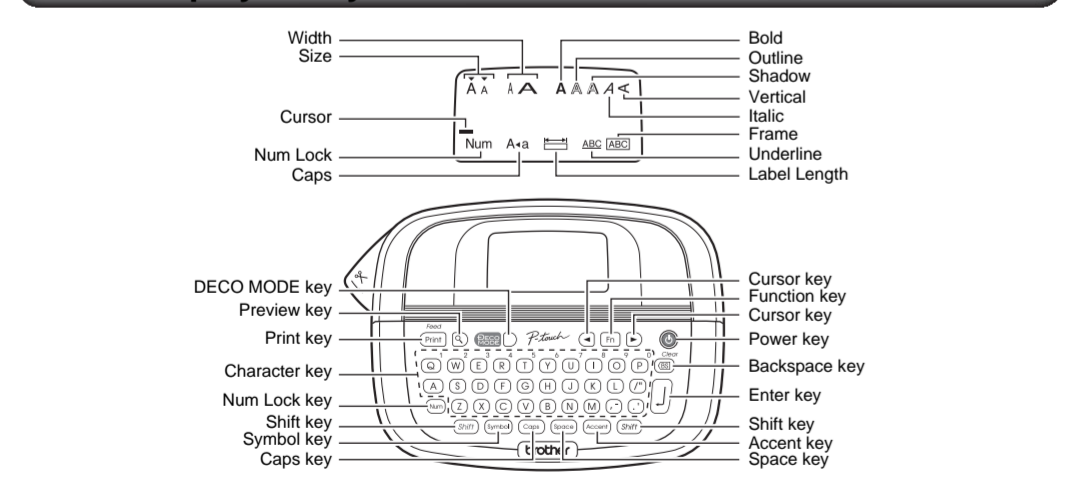

NOTE
The LCD shows one row of 12 characters; however, you can enter up to 80 characters in length.

Troubleshooting

Message	Cause/Remedy
Low Battery!	The batteries are weak. Replace them with new ones. The maximum number of characters (80 characters for regular text, or 50 characters for DECO MODE) have already been entered.
Full!	• You tried to print a text file when there is no data stored in the memory. • [Print] is pressed when no text is entered. • [Print] is pressed when no text is entered in the text entry screen of DECO MODE.
No Text!	• You tried to enter a 3rd line by pressing [Enter].
Line Limit!	• You tried to enter a 3rd line by pressing [Enter].

Safety Precautions

Warning
Follow these guidelines to avoid the risk of fire, burn, injury, electric shock, damage, overheating, abnormal odors or smoking.

- Do not use the machine in places of high humidity such as bathrooms.
- Do not swallow the cutter stopper.
- Do not get the machine wet, such as by handling it with wet hands or spilling beverages on to it.
- Do not disassemble or modify the P-touch labeler/batteries.
- Do not use metallic objects, such as tweezers or a metallic pen, when changing the batteries.
- Do not throw the batteries into fire or expose to heat.
- Remove batteries immediately and stop using the machine if you notice abnormal odor, heat, discoloration, deformation or anything unusual while using or storing it.

Caution
Follow these guidelines to avoid personal injury, liquid leakage, burn and heat.

- Do not touch the edge of the cutter near the print head.
- Remove the batteries if you do not intend to use P-touch labeler for an extended period of time.
- When power is disconnected for more than three minutes, all text, format settings and any text files stored in the memory will be cleared.
- Do not use old and new batteries together or mix alkaline batteries with other type batteries, or set the positive and negative end in the wrong position.
- Do not drop or hit the P-touch labeler.
- Do not press hard on the LCD display.
- Do not put your finger between the covers when you close the back cover.

General Precautions

- Depending on the location, material, and environmental conditions, the label may unpeel or become irremovable, the color of the label may change or be transferred to other objects. Before applying the label, check the environmental condition and the material.
- Do not use the P-touch labeler in any way or for any purpose not described in this guide. Doing so may result in accidents or damage the machine.
- Use only Brother M tapes with this machine. Do not use tapes that do not have the mark.
- Only use a soft, dry cloth to clean the labeler; never use alcohol or other organic solvents.
- Use a soft wipe to clean the print head; never touch the print head.
- Do not put any foreign objects into the tape exit slot, etc.
- Do not place the P-touch labeler/battery in direct sunlight or rain, near heaters or other hot appliances, in any location exposed to extremely high or low temperatures (e.g. on the dashboard or in the back of your car), high humidity, or dusty locations.
- Do not apply excessive pressure to the cutter lever.
- Do not try to print if the cassette is empty; it will damage the print head.
- Do not pull the tape while printing or feeding; it will damage the tape and machine.
- Any data stored in memory will be lost due to failure or repair of the P-touch labeler, or if the battery expires.

Entering Text and Symbols

Switching Upper Case/Lower Case

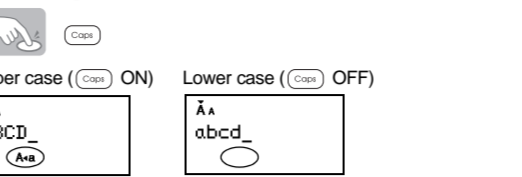

Entering Numbers

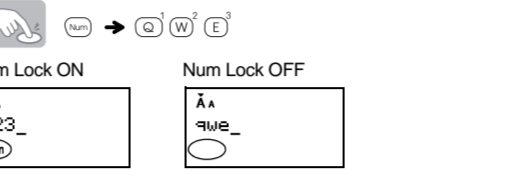

Making a Two Line Label

1. Enter the text for the first line and press [Enter].
 2. Enter the text for the second line and press [Enter].
- Do not press [Enter] after the second line; otherwise "Line Limit" error message will appear.
 - Use either 3/8" (9mm) or 1/2" (12mm) wide tape for two line text.

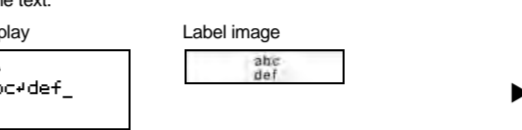

Entering Symbols



• Pictographs are displayed on the LCD display with the corresponding alphabet and number of the Pictograph table. For the Pictograph table and Pictograph List, refer to "Symbols".

Entering Accented Characters

Accented Characters	Accented Characters
A A A A A E A A A A A	a a a a a e a a a a a
C C C C	c c c c
D D D	d d d d
E E E E E E E E	e e e e e e e e
G G G	g g g
I I I I I I I I	i i i i i i i i
K K	k k
L L L L L	l l l l l
N N N N N	n n n n n
O O O O O O O O	o o o o o o o o
R R R R	r r r r
S S S S S	s s s s s
T T T T	t t t t
U U U U U U U U	u u u u u u u u
Y Y Y	y y y
Z Z Z Z	z z z z

• To cancel operations, press [Cancel].
• The order of accented characters differs by the selected LCD language.

To Clear

- By pressing [Clear], the letters will be deleted one by one.
- To delete all text and settings: [Shift] + [Clear] → [Text&Format]
- To delete text only: [Shift] + [Clear] → [Text Only]

Printing Labels

Text Preview

You can preview the text before printing.

- The LCD shows the whole text and the label length (inch/mm), then returns to the original text.
- Only the text can be previewed, not the style, size, underline/frame or any additional features.

Feeding (Tape Feed)

The machine will feed 1.0" of tape, which may be needed when installing a new tape cassette.

Printing

- To prevent damage to the tape, do not touch the cutter lever while the message "Printing..." or "Feeding..." is displayed.
- To cut off the label, push in the tape cutter lever on the upper-left corner of the machine.
- Peel the printed label from backing and apply the label.

Making Copies

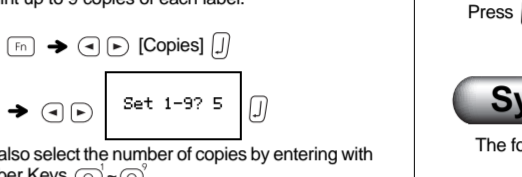

• You can also select the number of copies by entering with the Number Keys [1-9?5].

Removing the Label Backing

1. Insert the label, with the printed surface facing down, as far as possible into the built-in peeler.
2. Fold back the label to the right and quickly pull out the label. The end of the backing is separated from the label.

Resetting the P-touch

You can reset the P-touch labeler when you want to initialize the settings, or in the event that the P-touch is not working properly.

1. Press [Power] to turn off the power.
2. While holding down [Shift] and [Clear], press [Power] to turn on the power.
3. Release [Power], and then release [Shift] and [Clear]. The internal memory is reset, and all text, settings and stored files are cleared.

DECO MODE

This function allows you to create unique labels by using some built-in templates. You can choose from 8 types of templates.

Design	Label Image	Cooling
1	ABC ABC ABC ABC	
2	ABC ABC ABC ABC	
3	ABC ABC ABC ABC	
4	ABC ABC ABC ABC	
5	ABC ABC ABC ABC	
6	ABC ABC ABC ABC	✓
7	ABC ABC ABC ABC	✓
8	ABC ABC ABC ABC	✓

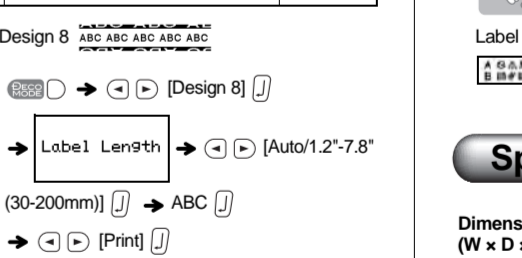

NOTE
Some Deco Mode formats may require cooling (indicated on the above table). If the print head becomes too hot, your machine will stop printing and automatically start to cool down. The cool down time will be displayed. Once the print head is cool, printing will automatically continue. Do not touch the P-touch labeler while cooling.

- Only one line of text can be entered in DECO MODE.
- Depending on the selected format, the entire text entered may not be printed.
- The formats of the DECO MODE templates cannot be changed.
- Symbols surrounded by a box in the Basic table are available in DECO MODE. For the Basic table, refer to "Symbols".
- To clear all the entered text, press [Shift] and [Clear]. "Clear?" is displayed. Press [Print] to clear the text, or [Cancel] to cancel this operation.
- When you access DECO MODE, your most recently printed DECO MODE text and label length will be recalled.
- Press [Print] to return to the previous step.
- To exit DECO MODE, press [Print] until the display returns to the text entry screen. You can also exit this mode by pressing [Quit] when [Print] is displayed, and selecting [Quit].
- 1/2" (12mm) wide tape cassettes are recommended when using the DECO MODE feature.
- The maximum label length is 7.8" (200mm) for DECO MODE.
- When [Auto] is selected for [Label Length], the label will automatically adjust to the correct length for printing the text one time.
- Press [Print] to return to [Auto] for [Label Length] mode.

Saving Label Files

Memory
You can save your original labels on to your machine. Up to three labels can be saved and recalled for printing at a later time. You can also edit and overwrite the stored label.

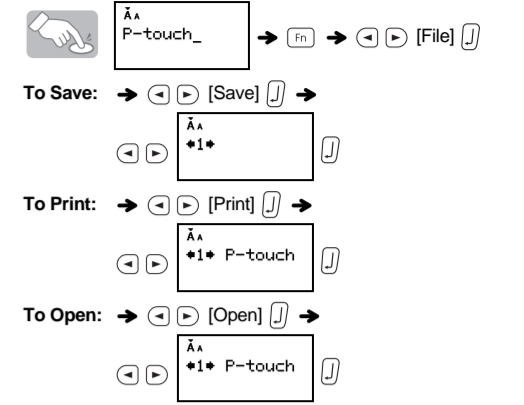

NOTE
If you try to store a label when there is already a label stored to that number, a message "Overwrite?" will appear. Press [Print] to save your new label. Press [Cancel] to cancel.

Symbols

The following symbols are available.

Basic	
01	.
02	@ - & ~ - \ /
03	# % ? !] [> \$
04	+ - x + ± = ✓
05	() [] < > \$
06	→ ← ↑ ↓ ↻ Ⓜ
07	\$ % € £ ¥ ¢
08	α β γ δ μ Ω
09	0 1 2 3 4 5 6
10	7 8 9 0 1 2 3
11	4 5 6 7 8 9
12	• ○ □ ☆ ★
13	☺ ♥ ♡ ♠ ♣

Pictograph						
A	☺	☹	☹	☹	☹	☹
B	☹	☹	☹	☹	☹	☹
C	☹	☹	☹	☹	☹	☹
D	☹	☹	☹	☹	☹	☹
E	☹	☹	☹	☹	☹	☹
F	☹	☹	☹	☹	☹	☹
G	☹	☹	☹	☹	☹	☹
H	☹	☹	☹	☹	☹	☹
I	☹	☹	☹	☹	☹	☹
J	☹	☹	☹	☹	☹	☹
K	☹	☹	☹	☹	☹	☹
L	☹	☹	☹	☹	☹	☹

- To display the next group, press [Next].
- To cancel operations, press [Cancel].
- Symbols surrounded by a box in the Basic table are available in DECO MODE.
- The rows of symbols (A to L) in the Pictograph table can be selected by pressing the corresponding character.

Printing the Pictograph List

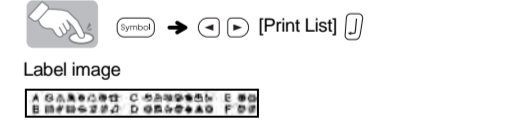

Specifications

Dimensions: (W x D x H) Approx. 6.14" x 4.37" x 2.22" (Approx. 156 x 111 x 56.5mm)
Weight: Approx. 0.6 lb. (Approx. 250 g) (without batteries and tape cassette)
Power supply: Four AAA alkaline batteries (LR03)
Tape cassette: Brother M tape (width): 3/8" (9mm), 1/2" (12mm)

See the attached "Supplies and Accessories Guide" for detailed info of tape variation.

Should you encounter any problems with your product, please do not return your product to the store! After referring to the User's guide, if you still need assistance, call Brother Customer Service at:
Voice: 1-877-BROTHER
Web: www.brother-usa.com
Fax: 1-901-379-1210
If you need to locate a service center, please call 1-877-BROTHER or visit us at www.brother-usa.com

Free Manuals Download Website

<http://myh66.com>

<http://usermanuals.us>

<http://www.somanuals.com>

<http://www.4manuals.cc>

<http://www.manual-lib.com>

<http://www.404manual.com>

<http://www.luxmanual.com>

<http://aubethermostatmanual.com>

Golf course search by state

<http://golfingnear.com>

Email search by domain

<http://emailbydomain.com>

Auto manuals search

<http://auto.somanuals.com>

TV manuals search

<http://tv.somanuals.com>