

brother®

# OWNER'S MANUAL

# IntelliFAX

# 600

# 680

## CONTENTS

- Chapter 1. SETUP & PREPARATION BEFORE USE
- Chapter 2. THE CONTROL PANEL KEYS
- Chapter 3. HOW TO USE ON-SCREEN PROGRAMMING (OSP)
- Chapter 4. TELEPHONE FUNCTION SETTINGS
- Chapter 5. USING THE UNIT AS A TELEPHONE
- Chapter 6. SENDING FAXES
- Chapter 7. RECEIVING FAXES AND OTHER CALLS
- Chapter 8. HOW TO USE COPY FUNCTIONS
- Chapter 9. POLLING
- Chapter 10. PRINTING OUT REPORTS AND LISTS
- Chapter 11. REGULAR MAINTENANCE AND TROUBLESHOOTING
- Chapter 12. IMPORTANT INFORMATION
- Chapter 13. INDEX
- Chapter 14. SPECIFICATIONS

# IMPORTANT NOTICE



This is to remind you that your new Fax unit includes a starter roll of our new Therma PLUS Fax paper.

- \* feels like plain paper
- \* reduces print fading (under normal filing conditions)
- \* easy to write on
- \* you can even use a highlighter

Remember, it is your choice to either use Therma PLUS paper (Brother reorder #6890 or #6840) or to use standard Fax paper (Brother reorder #6865).

## **How to Use This Owner's Manual**

---

Thank you for purchasing a Brother fax machine. This fax machine has been designed to be simple to use, but you can utilize it to its fullest potential by taking some time to read this owner's manual. You will be ready to use the fax machine as soon as you read the first four chapters. Then you can refer to topics in the remaining chapters, as needed.

### **Structure of the Manual**

■ **Chapters 1-4**

How to set up the fax machine and what you need to know before you use it.

■ **Chapters 5-7**

Basic operations, how to send and receive faxes.

■ **Chapters 8-10**

Advanced operations.

### **Finding Information in the Owner's Manual**

- Use the **table of contents**. This side of the manual is coded so you can find topics easily.
- If there is a **key on the fax machine** you are not familiar with, refer to **chapter 2**.
- To find out information about a function, refer to the "**Function Selection Chart**" in **chapter 3**.
- If you have **trouble**, refer to **chapter 11** on how to troubleshoot.
- Use the **chapter 13 index**.

### **Test Sheet Procedure**

---

Please fill out the TEST SHEET and fax it to 1-908-469-4547 as your first transmission. This will verify that your fax machine is properly installed.

When this document is received at Brother Diagnostic Center, a confirmation sheet will be sent back to your machine from Brother Automatic Fax Back Response System. Be sure to set up your "Station ID". (See page 4-3.)

FAX NO. : 1-908-469-4547 (Fax Transmission Only)

TEL NO. : 1-800-284-4FAX (Voice Phone Only)

# CONTENTS

## **Chapter 1.**

### **❖ SETUP & PREPARATION BEFORE USE ,1-1**

- Choosing a Suitable Place to Put Your Fax Machine ,1-1
  - The Good Places... ,1-1
  - And the Bad Places... ,1-1
- Packing List ,1-2
- F.Y.I. Setting up Your Fax Machine ,1-2
- F.Y.I. Jacks ,1-4
- F.Y.I. Multi Line Connections (PBXs) ,1-4
- Connecting to a Private Branch Exchange ,1-4

## **Chapter 2.**

### **❖ THE CONTROL PANEL KEYS ,2-1**

- TELEPHONE AREA ,2-2
- ONE-TOUCH AREA ,2-3
- FUNCTION AREA ,2-4
- USER SETTING AREA ,2-5

## **Chapter 3.**

### **❖ HOW TO USE ON-SCREEN PROGRAMMING (OSP) ,3-1**

- What Is On-Screen Programming ,3-1
- Function Selection Chart ,3-1
- Using the Function Mode to Access OSP ,3-4
- Alternating Displays for OSP ,3-5
- How to Enter Text in the Function Mode ,3-5
- How to Enter Special Characters, Symbols and Punctuation Marks in the Function Mode ,3-6

## **Chapter 4.**

### **❖ TELEPHONE FUNCTION SETTINGS ,4-1**

- Setting the Dialing Mode (Tone/Pulse) ,4-1
- Setting the Beeper Sound Level ,4-1
- Setting the Date and Time ,4-2
- Setting the Station ID ,4-3
- Storing One-Touch Dial Numbers ,4-4
- F.Y.I. Types of Numbers ,4-5
- F.Y.I. Chain Dialing ,4-5
- Storing Speed-Dial Numbers ,4-6
- F.Y.I. When You Wish to Change to the Store One-Touch and Speed Dial Numbers (During Step 4 on Page 4-4, 6) ,4-7
- F.Y.I. Memory Storage ,4-7

## **Chapter 5.**

### **❖ USING THE UNIT AS A TELEPHONE ,5-1**

- Manual Dialing ,5-1
- One-Touch Dialing ,5-1
- Speed Dialing ,5-1
- F.Y.I. Using Keys with the Telephone ,5-1
- F.Y.I. On Hook Dialing ,5-1

Telephone Index (Only for FAX-680) ,5-2

## **Chapter 6.**

### **❖ SENDING FAXES ,6-1**

#### **A) BASIC FAX TRANSMISSIONS ,6-1**

The Size of Your Documents ,6-1

How to Set the Document ,6-1

The Auto Document Feeder (ADF) ,6-2

Getting Ready to Send Faxes ,6-2

Resolution ,6-2

Contrast ,6-3

Sending a Fax Automatically ,6-3

Sending a Fax Manually ,6-4

F.Y.I. Dialing a Number ,6-4

F.Y.I. Talking to the Other Party When Sending a Fax ,6-4

Automatic and Manual Re-dialing ,6-5

Setting the Auto Re-dial ,6-5

F.Y.I. Possible Settings When You Send a Fax Manually ,6-5

F.Y.I. Printing Page Headers ,6-5

Delayed Transmission ,6-6

Setting the Daily Timer (for Delayed Transmissions) ,6-6

Interrupting the Timer and Polled Job ,6-7

Canceling the Job ,6-8

#### **B) FAX TRANSMISSION OPTIONS ,6-9**

Setting the Overseas Mode ,6-9

Setting Your Fax Machine for Multiple Resolution Transmission ,6-10

Gray Scale (Only for FAX-680) ,6-11

F.Y.I. About Resolutions... ,6-11

Sending a Fax with a Cover Page ,6-12

F.Y.I. The Comments Section on the Cover Page ,6-12

Setting Coverpage ON/OFF ,6-13

Sending an Automatic Cover Page ,6-14

Customizing Your Cover Page Comment (Only for FAX-680) ,6-14

Sending a Fax with Call Reservation ,6-15

F.Y.I. Using the Call Reservation Function ,6-15

## **Chapter 7.**

### **❖ RECEIVING FAXES AND OTHER CALLS ,7-1**

Selecting an Answer Mode ,7-1

Manual Reception (MANUAL mode) ,7-2

Automatic Fax Reception (AUTO mode) ,7-2

Setting the Ring Delay ,7-2

The F/T Switch (F/T Mode) ,7-3

Setting the F/T Ring Time ,7-3

Remote Activation ,7-4

Connecting an External or Extension Telephone to the Unit ,7-4

Using Remote Codes ,7-5

F.Y.I. Limitation of Using External (or Extension) Phones ,7-5

Registering Remote Codes ,7-5

# CONTENTS

	The TAD Mode ,7-6
	Connecting an External TAD to the Unit ,7-6
	Smoothing ,7-8
	Speaker Volume ,7-8
	Ring Volume ,7-9
<b>Chapter 8.</b>	<b>❖ HOW TO USE COPY FUNCTIONS ,8-1</b>
	Making a Copy ,8-1
<b>Chapter 9.</b>	<b>❖ POLLING ,9-1</b>
	F.Y.I. What Is Polling? ,9-1
	F.Y.I. How Does It Work? ,9-1
	F.Y.I. When to Use Polling? ,9-1
	Polling Another Fax Machine ,9-2
	Setting up for Polled Waiting ,9-2
	Secure Polling ,9-3
	Polling Another Fax Machine with Secure Code ,9-3
	Setting up for Polled Waiting with Secure Polling ,9-4
	Delayed Polling (Only for FAX-680) ,9-4
<b>Chapter10.</b>	<b>❖ PRINTING OUT REPORTS AND LISTS ,10-1</b>
	Printing the All Dial List ,10-2
	Activity Report Interval ,10-3
	Transmission Verification (Xmit) Report ,10-4
<b>Chapter11.</b>	<b>❖ REGULAR MAINTENANCE AND TROUBLESHOOTING ,11-1</b>
	Regular Maintenance ,11-1
	Paper Jams ,11-2
	Fixing a Document Jam ,11-2
	Fixing a Cutter Jam or Printer Jam ,11-2
	Troubleshooting ,11-3
	Error Messages ,11-3
	Other Problems ,11-4
<b>Chapter12.</b>	<b>❖ IMPORTANT INFORMATION,12-1</b>
	Standard Telephone And FCC Notices (Only applies to 120V model) ,12-1
	Important Safety Instructions ,12 3
<b>Chapter13.</b>	<b>❖ INDEX,13-1</b>
<b>Chapter14.</b>	<b>❖ SPECIFICATIONS ,14-1</b>

F.Y.I. ....For Your Information

## 1. SETUP & PREPARATION BEFORE USE

### Choosing a Suitable Place to Put Your Fax Machine

Use the following list as a guide to find a suitable place for your fax machine.

#### The Good Places...

Place your fax machine on a flat, stable surface, such as a desk.

Select a place that is free of vibration and shocks.

Locate it near a telephone jack and a standard, grounded power outlet.

#### And the Bad Places...

Avoid setting it up in a high-traffic area.

Avoid setting up the machine near heaters, air conditioners, water, chemicals, or refrigerators.

Do not select a place that exposes your fax machine to direct sunlight, excessive heat, moisture, or dust.

Do not connect your fax machine to electrical outlets controlled by wall switches or automatic timers. Disruption of power can wipe out information in the unit's memory.

Do not connect your fax machine to electrical outlets on the same circuit as large appliances or other equipment that might disturb the power supply.

Avoid interference sources, such as speakers or the base units of cordless phones.

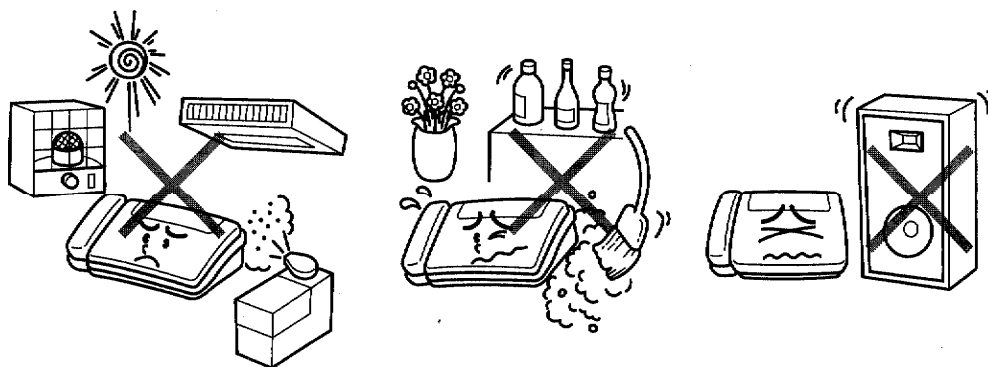

# SETUP & PREPARATION BEFORE USE

## Packing List

Please check to see that you have the following items:

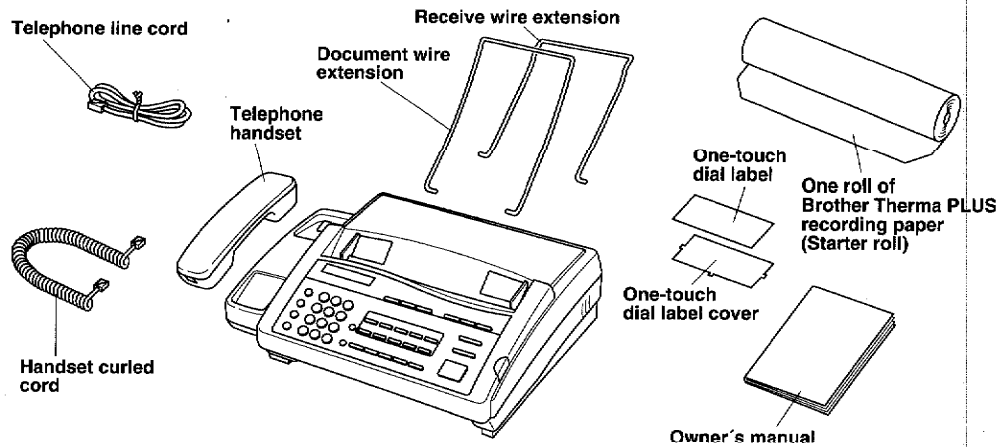

## Setting up Your Fax Machine

Follow these steps to set up your fax machine:

### 1. Load the recording paper.

- 1) Push the release button to open the top cover.
- 2) Take the roll of recording paper out of the wrapper. If you are replacing a roll, you need to remove any remaining paper still in the machine.
- 3) Insert the recording paper into the paper bin, **with the paper coming off the top of the roll**.
- 4) Insert the edge of the paper into the slot which reads "PASS THE RECORDING PAPER UNDER THIS GUIDE." and pull the paper out about 10cm (4 inches) from the back side. Adjust the recording paper so that it is between the marks.
- 5) Close the top cover and press firmly until you can hear the latches "click."

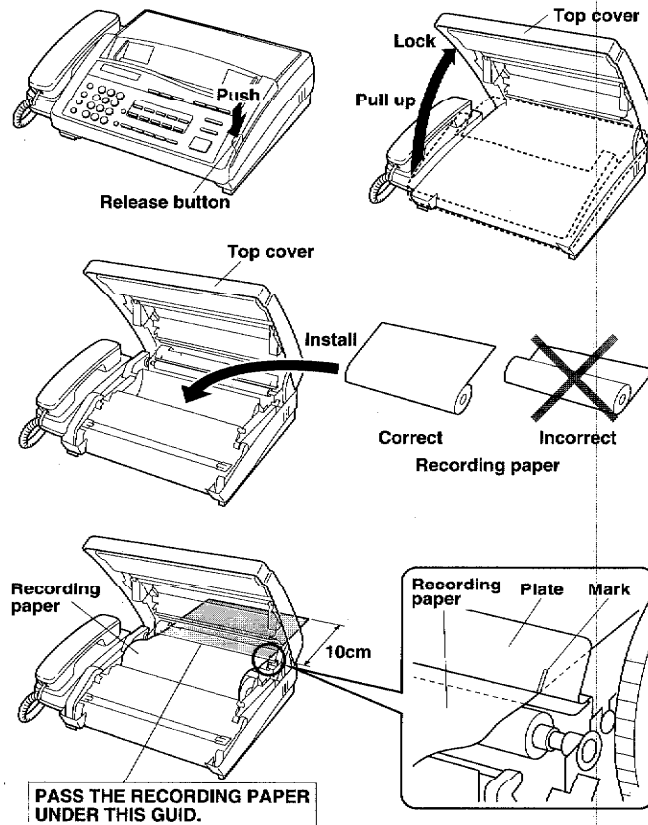



**2. Connect the handset.**

**3. Connect the power cord.**

When you connect the power, your fax machine will automatically cut the fax paper, and the display will read: "01/01/1994 00:00".

**NOTICE**

1. This fax machine must be grounded using a 3-prong plug.
2. Since the machine is grounded through the power outlet, you can protect yourself from potentially hazardous electrical conditions on the telephone network by keeping the power to your fax machine on before you connect it to a telephone line.

Similarly, you can protect yourself when you want to move your machine, by disconnecting the telephone line first, and then the power cord.

**4. Connect the telephone line.**

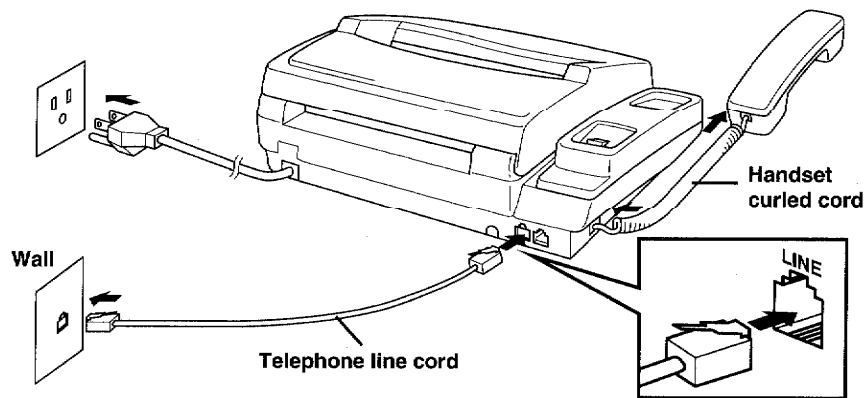

**5. Attach the wire extensions and One-touch dial label.**

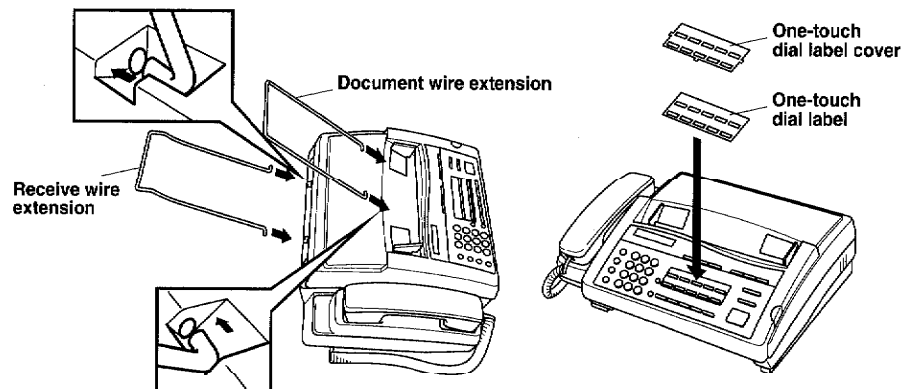

## FOR YOUR INFORMATION

### **Jacks**

If you have the older 4-prong telephone wall jack, you must use a modular 4-prong adapter (USOC RJ41X). Plug the adapter into the wall jack and then plug the telephone line cord into the adapter, as shown in the illustration below.

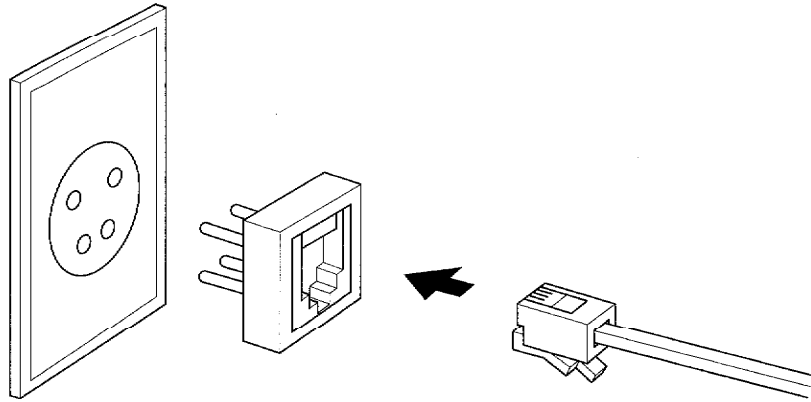

### **Multi Line Connections (PBXs)**

Most offices use a central telephone system. While it is often relatively simple to connect the machine to a key system or a PBX (private branch exchange), we suggest that you contact the company which installed your telephone system and ask them to connect the fax machine for you.

It is advisable to have a separate line for the fax machine. You can then leave the machine in AUTO Answer Mode to receive faxes at any time of the day or night.

If the fax machine is to be connected to a multi-line system, ask your installer to connect the unit to the last line on the system. This will prevent the unit from being activated each time a telephone call is received. But proper connection can not be made.

- As with all fax units this machine must be connected to a two wire system. If your line has more than two wires proper connection of the fax machine can not be made.

### **Connecting to a Private Branch Exchange**

The following points should be kept in mind if you are installing the machine to work with a private branch exchange (PBX).

- 1) It is not guaranteed that the unit will operate correctly under all circumstances with PBXs. Any cases of difficulty should be reported first to the company that handles your PBX.
- 2) If all incoming calls will be answered by a switchboard operator, it is recommended that the Answer Mode be set to be MANUAL. (See page 7-2.) All incoming calls should initially be regarded as telephone calls.
- 3) The unit may be used with either the pulse or tone dialing telephone types.

2. THE CONTROL PANEL KEYS

FAX-600

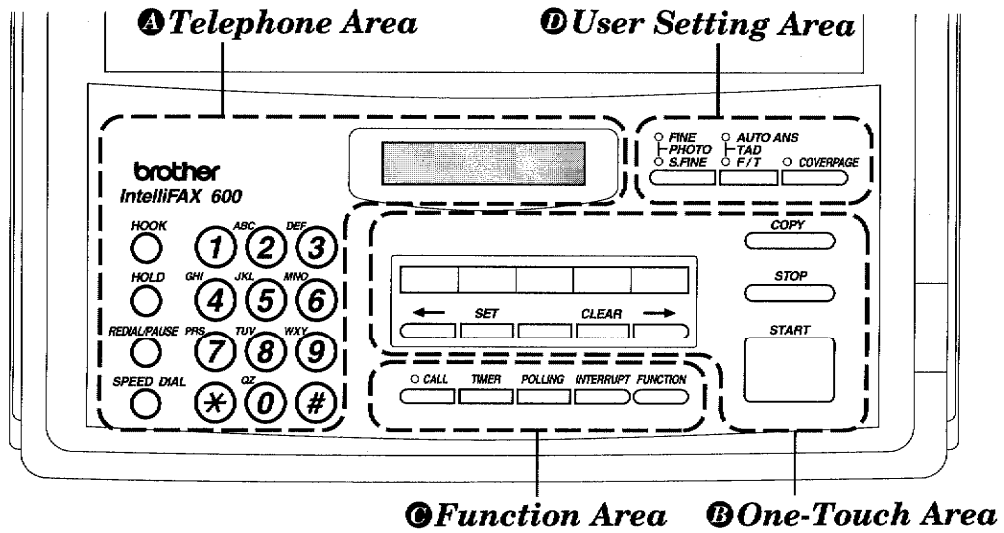

Ch. 2

FAX-680

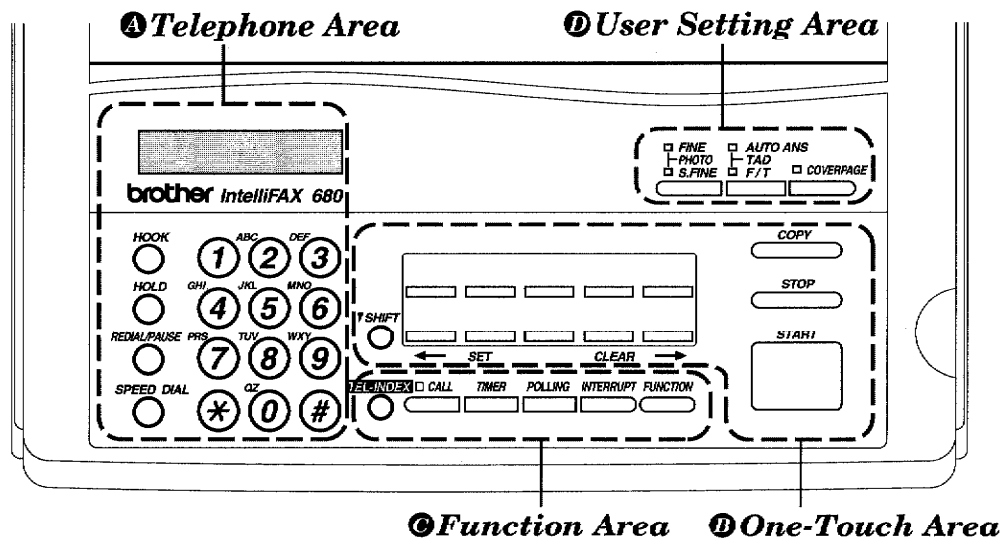

## Ⓐ TELEPHONE AREA

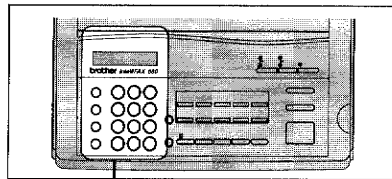

Intelli FAX-680

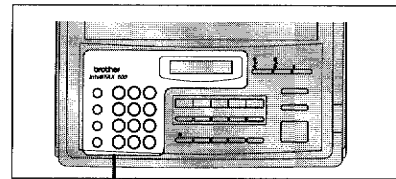

Intelli FAX-600

### 1. Liquid Crystal Display

The LCD displays messages that will help you set up and operate your fax machine (On-Screen Programming). (See page 3-1.)

### 2. HOOK

This key lets you dial telephone and fax numbers without lifting the handset. (See page 5-1.)

### 3. HOLD

You can use this key to put a call on hold. (See page 5-1.)

### 4. REDIAL/PAUSE

This key re-dials the last number called. (See page 6-5.) This key is also used to insert a pause in autodial numbers. (See page 4-5, 5-1.)

### 5. SPEED DIAL

This key lets you access previously stored speed dial phone numbers with a two digit number. (See page 4-6, 5-1.)

### 6. Number Keys

These twelve keys are used to dial phone and fax numbers (see page 5-1), and can also be used as an alphanumeric keyboard for entering information into the fax machine (see page 3-5).

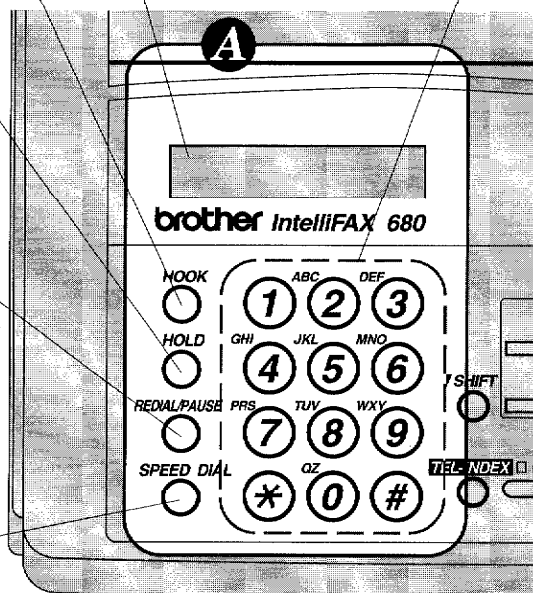

**B ONE-TOUCH AREA**

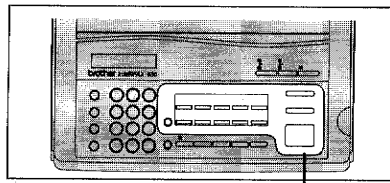

Intelli FAX-680

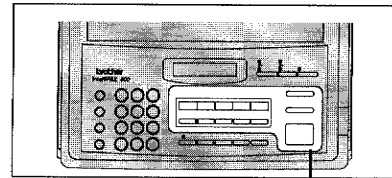

Intelli FAX-600

**7. One-Touch Dial Keys**

These keys give you instant access to previously stored phone numbers. (See page 4-4, 5-1.)

**8. ← (Left Arrow)\***

This key moves the LCD cursor to the left. It also allows you to back up one step when you are in function mode (see page 3-4) or Telephone Index.

**9. SHIFT**  
(Only for FAX-680)

This key is used to access the extra ten One-Touch keys. (See page 4-4.)

**10. SET\***

This key is used for storing a function setting into the fax machine. (See page 3-4.)

**11. CLEAR\***

This key deletes entered data or backs up one step in a function mode procedure. (See page 3-4.)

**13. COPY**

Use this key to indicate your fax machine to make a copy. (See page 8-1.)

**14. STOP**

This key stops a fax, cancels an operation, or exits from function mode. (See page 3-4.)

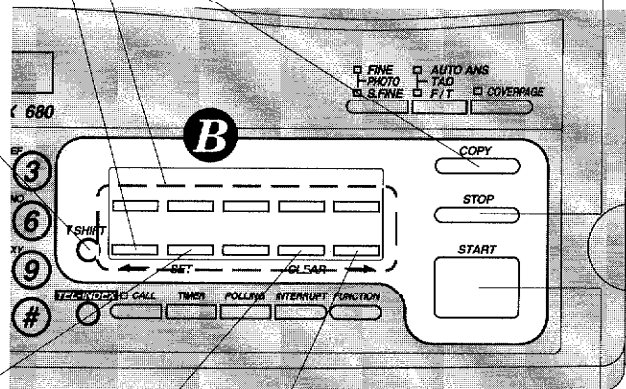

**15. START**

Use this key to start an operation, such as sending a fax. (See page 6-3.)

**12. → (Right Arrow)\***

This key moves the LCD cursor to the right, and it also lets you advance one step when you are in a function mode (see page 3-4) or Telephone Index.

\* The Left and Right Arrow keys, SET and CLEAR keys are also shared with one-touch keys.

# THE CONTROL PANEL KEYS

## © FUNCTION AREA

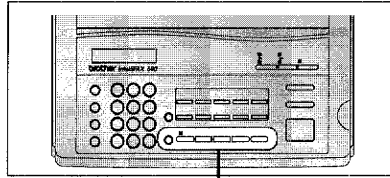

Intelli FAX-680

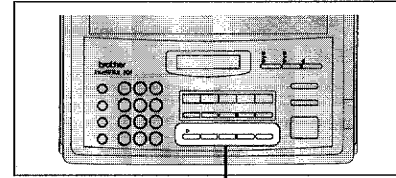

Intelli FAX-600

### 16. TEL-INDEX

(Only for FAX-680)

This key allows you to alphabetically look up numbers stored in the dialing memory. (See page 5-2.)

### 17. CALL

This key is used to activate a call reservation and call back message. (See page 6-15.)

### 20. TIMER

This key is used to set a delayed transmission time. (See page 6-6.)

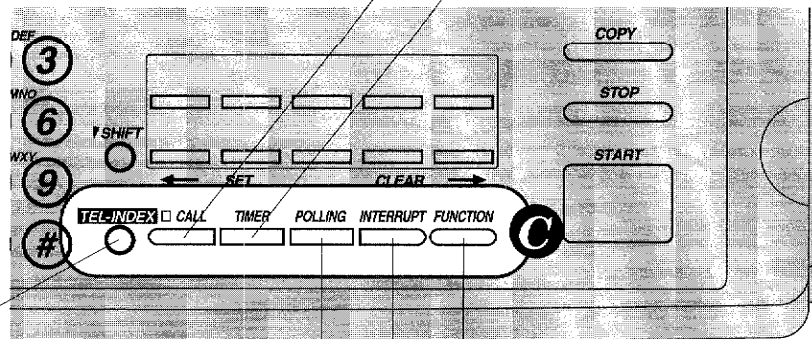

### 18. POLLING

This key accesses the polling feature. (See page 9-1.)

### 19. INTERRUPT

It is used to temporarily interrupt the timer job. (See page 6-7.)

### 21. FUNCTION

This key accesses the function and programming mode (OSP), where you can alter various settings. (See page 3-1.)

**D USER SETTING AREA**

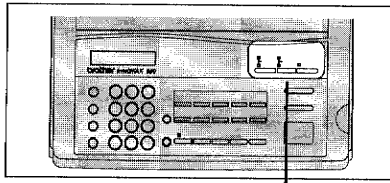

Intelli FAX-680

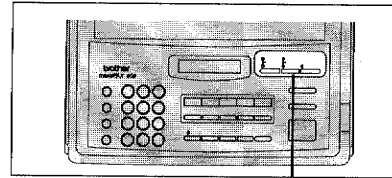

Intelli FAX-600

Ch. 2

**22. Resolution**

This key is used to set the resolution requirements when sending a fax. (See page 6-2.)

**23. Answer Mode**

This key is used to specify how the fax machine should handle incoming calls. (See page 7-1.)

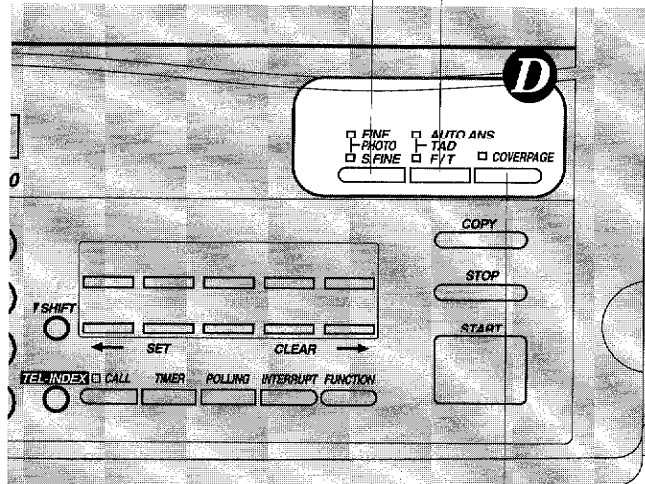

**24. COVERPAGE**

This key is used to send an automatic Cover Page as the first page of a fax transmission. (See page 6-12.)

## 3. HOW TO USE ON-SCREEN PROGRAMMING (OSP)

### *What Is On-Screen Programming*

Since your fax programming is done on our LCD display, we created step by step On-Screen prompt messages to help you program your fax. All you need to do is follow the prompt instructions as it guides you through the function menu selections and programming options and settings.

If you have a basic understanding of the options and settings that are found in the programming function, you could perform most of the programming settings without the owner's manual. To help you understand what function selections, options, and settings are found in your fax program, we have the following Function Selection Chart.

Read through this Chart to gain a basic understanding of what your new fax model can do, and then the next section will begin instructing you How to Use On-Screen Programming.

### *Function Selection Chart*

Level one function	Level two function	Explanation of Options	Factory setting	Page
1. TEMP. SETTINGS	1. CONTRAST	There are three types of contrast settings. Usually the AUTO setting is acceptable. But if you want to send an especially light or dark document, please change the setting. AUTO: Default setting is AUTO. Contrast setting always reverts to AUTO after one transmission. S. LIGHT: To send very light documents. S. DARK: To send very dark documents.	AUTO	6-3
	2. RESOLUTION	If you need to send a set of originals at various resolutions, this function will allow you to send your required resolution by page. (If all documents are the same resolution, use the Resolution key. See page 2-5 #22.) STANDARD/FINE/S. FINE/PHOTO	STANDARD	6-10
	3. OVERSEAS MODE	If you have trouble when sending overseas, you may want to use set OVERSEAS MODE to ON. ON/OFF	OFF	6-9
2. CANCEL JOB	/	If you wish to cancel a job that has been set with the timer, a polled job etc., use this function.	/	6-8
3. PRINT REPORTS	/	You can print several different lists and reports, which are available under function item 3. PRINT REPORTS.	/	10-1
4. SET AUTO DIAL	1. ONE-TOUCH DIAL	If you register names and numbers to one-touch dial keys, you can dial a number automatically just by pressing a one-touch key. (20 locations for FAX-680, 5 locations for FAX-600)	—	4-4



# HOW TO USE ON-SCREEN PROGRAMMING (OSP)

**Ch. 3**

Level one function	Level two function	Explanation of Options	Factory setting	Page
<b>4. SET AUTO DIAL</b>	2. SPEED-DIAL	If you register names and numbers as Speed-Dial numbers, you can dial a number automatically just by pressing SPEED DIAL and a two-digit number. (40 locations for FAX-680, 10 locations for FAX-600)	—	4-6
	1. SMOOTHING	Smoothing enhances the appearance of incoming faxes. If you set SMOOTHING to ON, you can receive messages with smoothing. ON/OFF	ON	7-8
<b>5. USER OPTIONS</b>	2. BEEPER	You can adjust the volume of the beeper with this function. OFF/LOW/HIGH	LOW	4-1
	3. COVERPAGE	If you set COVERPAGE to ON, you can send your documents with a Cover Page generated by your machine. When the COVERPAGE setting is ON, you can select a Cover Page comment. ON/OFF	OFF	6-13
	4. GRAY SCALE (Only for FAX-680)	You can select a GRAY SCALE level. 16/32 level	32	6-11
	1. TONE/PULSE	There are two different dial types and you must select the type of signal suitable for your telephone. TONE/PULSE	TONE	4-1
<b>6. TEL OPTIONS</b>	2. RING DELAY	The number of rings that will occur before F/T or AUTO Answer Mode selections are activated. 0/1/2/3/4 rings	2	7-2
	3. AUTO REDIAL	If you set AUTO REDIAL to ON, your machine will automatically re-dial the last number called in the event the number was busy or the call failed for some other reason. ON/OFF	ON	6-5
	4. SPEAKER VOLUME	You can set the speaker volume. OFF/LOW/HIGH	LOW	7-8
	5. F/T RING TIME	F/T RING TIME sets the time for simulated ringing in F/T mode. 10/20/30/60 seconds	20	7-3
	6. RING VOLUME	The settings are OFF/LOW/HIGH.	HIGH	7-9
	<b>7. SETUP SYSTEM</b>	1. DATE/TIME	If you enter the date and time in 24-hour format, the LCD will display the date and time and will also be printed on outgoing faxes.	01/01/1994 00:00

# HOW TO USE ON-SCREEN PROGRAMMING (OSP)

Level one function	Level two function	Explanation of Options	Factory setting	Page
7. SETUP SYSTEM	2. DAILY TIMER	If you frequently have delayed jobs, all for execution at a certain time, you can program that time. Once you register it, you do not need to enter that time, just press TIMER.	00:00	6-6
	3. INTERVAL	You can select the interval at which the activity report is printed out. 6/12/24 hours, 2/4/7 days, OFF	OFF	10-3
	4. STATION ID	You can enter your name or company name, fax number and telephone number in STATION ID. It is printed at the top of each page of every outgoing fax. It is also printed on the automatic Cover Page.	_____	4-3
	5. REMOTE CODE	If you enter REMOTE CODE, you can activate or deactivate the fax machine from a remote telephone. ON/OFF	ON *51 (ACT.) #51 (DEACT.)	7-5
	6. SET COVERPAGE (Only for FAX-680)	You can register your own two programmable comments on the Cover Page.		6-14

## Using the Function Mode to Access OSP

You can access the function mode by pressing **FUNCTION** found in the Function Area of your fax Control Panel. (See page 2-4.)

When you enter the function mode, your fax machine will display a list of Level One Functions to choose from (see pages 3-1 through 3-3 for these Level One Functions), as seen below.

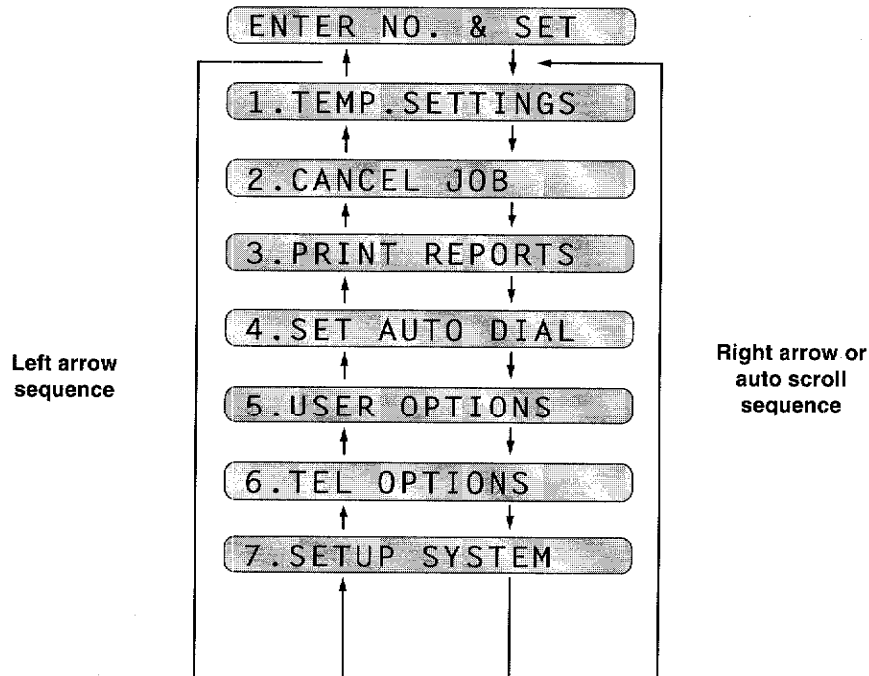

These function options will appear one after the other on the display. You can then choose one of these options by pressing **SET** when your desired option appears on the LCD.

You can also move through the function menu options at a faster rate by pressing **→** (right arrow). (See page 2-3 to locate this key on your Control Panel.) When you find the option you want, press **SET**.

You can simply press the Level One Function number associated with each option (again refer to page 3-1 through 3-3).

### **Helpful Hints**

If you want to exit the function mode, simply press **STOP**. Also, if you select the wrong menu, and to return to the previous step, press **CLEAR**.

# HOW TO USE ON-SCREEN PROGRAMMING (OSP)

## *Alternating Displays for OSP*



When you see alternating displays, the LCD will usually alternate between the currently selected option, and a help message giving brief instructions on how to proceed. The example shows the current speaker volume is high and prompts you to use ← (left arrow) and → (right arrow) to alter the setting, and then to press **SET** to store it.

## *How to Enter Text in the Function Mode*

Each number key has two or three letters printed by the side of it. The "1" key and the "#" key and the "\*" key have no printed letters because they have special characters.

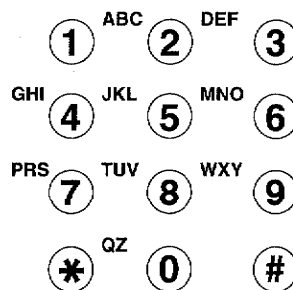

**By pressing the appropriate number key the correct number of times, you can get the character you want.** When you are making certain settings, such as the Station ID settings, you need to enter text into your fax machine.

Key	once	twice	three times	four times
2	A	B	C	2
3	D	E	F	3
4	G	H	I	4
5	J	K	L	5
6	M	N	O	6
7	P	R	S	7
8	T	U	V	8
9	W	X	Y	9
0	Q	Z	0	Q

Let's say that you want to enter the initials "BR." Follow the example of next page.

## KEYS TO BE PRESSED

1. Press **2** twice to enter the letter **B**.
2. Press **7** twice to enter the letter **R**.
3. Press **SET**.

## STATUS OF LCD DISPLAY

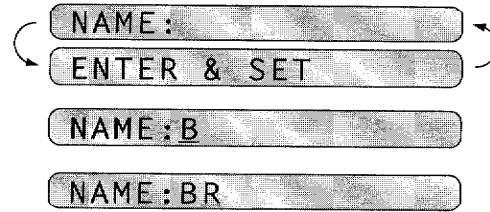

## FOR YOUR INFORMATION

1. If you want to enter a blank space, press → (right arrow) twice.
2. If you entered a letter incorrectly and want to change it, you can use ← (left arrow) to move the cursor back to where it is. When you reach the letter, you can enter a new one in its place. You can only overwrite letters, not insert them, so you may have to go back and overwrite a lot of letters if you forget to enter a letter.
3. If you enter a character which is assigned in the same number, press → (right arrow) to move the cursor to the right.

## *How to Enter Special Characters, Symbols and Punctuation Marks in the Function Mode*

1 key ----- ÄËÖÜÀÇÈÉÌ  
 \* key ----- (space) !"#\$%&'()\*+,-./  
 # key ----- ;<=>?@[]^\_

The "1" key contains all the accented characters. The "\*" and the "#" key are used for punctuation marks and symbols. Let's say that you want to enter the Symbol "&". Follow the example below.

## KEYS TO BE PRESSED

1. Press \* to show a list of characters.
2. Press \*, \*, \*, \*, \*, \* (6 times).
3. Press → (right arrow).

## STATUS OF LCD DISPLAY

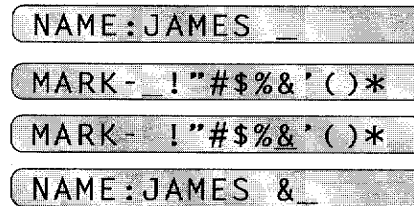

## 4. TELEPHONE FUNCTION SETTINGS

There are some settings, such as the date and time, you should make to your fax machine before you begin using it. Once entered, these settings will remain in the machine until you change them. You can begin customizing the settings by pressing **FUNCTION** on the control panel. This activates the function mode and On - Screen Programming prompts. You can complete a variety of settings in this mode.

### Setting the Dialing Mode (Tone/Pulse)

Your fax machine supports both tone (or multi-frequency) and pulse (or rotary) dialing. It is initially set to TONE, so you do not need to change the setting if you use that kind of line. If you are using a pulse dial line, you can change the setting to PULSE by following the steps below:

KEYS TO BE PRESSED	STATUS OF LCD DISPLAY
<p>1. Press <b>FUNCTION</b>.</p> <p style="padding-left: 20px;">You will see scrolling options on the display. You can choose one.</p>	<p style="text-align: center;">01/01/1994 00:00</p> <p style="text-align: center;">1.TEMP.SETTINGS</p>
<p>2. Press <b>6</b>.</p>	<p style="text-align: center;">6.TEL.OPTIONS</p>
<p>3. Press <b>1</b>.</p> <p style="padding-left: 20px;">After two seconds you will be automatically prompted to select pulse or tone.</p>	<p style="text-align: center;">1.TONE/PULSE</p> <p style="text-align: center;">DIALING:TONE</p> <p style="text-align: center;">SELECT &lt; &gt; &amp; SET</p>
<p>4. Press ← (left arrow) or → (right arrow) to find the dialing mode that matches your telephone line. Example:PULSE</p>	<p style="text-align: center;">DIALING:PULSE</p>
<p>5. Press <b>SET</b>.</p>	<p style="text-align: center;">1.TONE/PULSE</p>
<p>6. Press <b>STOP</b> to return to date and time.</p>	

### Setting the Beeper Sound Level

If the beeper setting is LOW or HIGH, it will "beep" every time you press a key, make an error, or at the end of sending or receiving a fax.

The initial setting on your fax machine for the beeper is LOW. If you do not want the beeper on, select OFF, and if you want it loud, select HIGH.

## KEYS TO BE PRESSED

1. Press **FUNCTION**.
2. Press **5**.
3. Press **2**.
4. Press ← (left arrow) or → (right arrow) until you get the setting you want.  
Example: OFF.
5. Press **SET**.
6. Press **STOP** to return to date and time.

## STATUS OF LCD DISPLAY

01/01/1994 00:00

1. TEMP. SETTINGS

5. USER OPTIONS

2. BEEPER

BEEPER: LOW

SELECT < > & SET

BEEPER: OFF

2. BEEPER

### *Setting the Date and Time*

Your fax machine shows the date and time on the display and prints the date and time on every fax pages you send. You can set the date and time in function mode.

## KEYS TO BE PRESSED

1. Press **FUNCTION**.
2. Press **7**.
3. Press **1**.
4. Enter the last two digits of the year.  
Example: **93**.
5. Enter two digits for the month.  
(JAN = 01, OCT = 10, etc.)  
Example: **09**.
6. Enter two digits for the day.  
Example: **12**.
7. Enter the time in 24-hour format.  
Example: **15:25**. (3:25 P.M.)
8. Wait for two seconds.
9. Press **STOP** to exit and view the new date and time.

## STATUS OF LCD DISPLAY

01/01/1994 00:00

1. TEMP. SETTINGS

7. SETUP SYSTEM

1. DATE/TIME

ENTER YEAR: XX

ENTER YEAR: 93

ENTER MONTH: XX

ENTER MONTH: 09

ENTER DAY: XX

ENTER DAY: 12

ENTER TIME: XX:XX

ENTER TIME: 15:25

1. DATE/TIME

09/12/1993 15:25

# TELEPHONE FUNCTION SETTINGS

## Setting the Station ID

The Station ID is for identification purposes. Here you can store your name, fax number, and telephone number. Your machine then prints this information on the electronic Cover Page and every fax page you send.

### KEYS TO BE PRESSED

1. Press **FUNCTION**.
2. Press **7**.
3. Press **4**.  
You will then be prompted to enter your fax number.
4. Enter your fax number (up to 20 digits).  
Example: **4155554444**.
5. Press **SET**.  
You will now be prompted to enter your telephone number.
6. Enter your telephone number (up to 20 digits).  
If your telephone number and fax number share the same line, enter the same number again.  
Example: **4155554445**.
7. Press **SET**.  
You will be prompted to enter name or company's name.
8. Enter the name by using the number keys (up to 20 characters).  
Example: **BROTHER**.  
Refer to the section "How to Enter Text in the Function Mode" on the page 3-5, 6.
9. Press **SET** to confirm the entry.
10. Press **STOP** to return to date and time.

### STATUS OF LCD DISPLAY

09/12/1993 15:25

1. TEMP. SETTINGS

7. SETUP SYSTEM

4. STATION ID

FAX: \_\_\_\_\_

ENTER & SET

FAX: 4155554444\_

TEL: \_\_\_\_\_

ENTER & SET

TEL: 4155554445\_

NAME: \_\_\_\_\_

ENTER & SET

NAME: BROTHER

4. STATION ID

- Helpful Hints**
1. The telephone number which you stored above is only used for the Call Back Message and the Cover Page features.
  2. If you do not enter a fax number, no additional information can be entered.
  3. When you enter a space, use → (right arrow). Then it will be registered as a blank space, "\_".



NOTICE

The Telephone Consumer Protection Act. of 1991 makes it unlawful for any person to use a computer or electronic device to send any message via a telephone fax machine unless such message clearly contains in a margin at the top or bottom of each transmitted page or on the first page of the transmission, the date and time it is sent and an identification of the business or other entity, or other individual sending the message and the telephone number of the sending machines or such business, other entity, or individual.

In order program this information into your fax machine, you should complete the steps of the previous page.

**Storing One-Touch Dial Numbers**

You can dial numbers automatically by storing telephone or fax numbers as One-Touch dial numbers. You can also store names with the numbers so that when you call, you can verify the destination on the display. You can store a maximum of 20 phone numbers for FAX-680 (01-20) and 5 phone numbers for FAX-600 (1-5). To use 11 to 20 One - Touch number locations (only for FAX-680) , you need to press **SHIFT**. For example, One - Touch location "11" is accessed by pressing **SHIFT** + One-Touch "01" simultaneously. Here is how to store a telephone number as a One-Touch dial number:

**KEYS TO BE PRESSED**

1. Press **FUNCTION**.
2. Press **4**.
3. Press **1**.
4. Press one of the **One-Touch** keys, you want to use to store a number.  
Example: **One - Touch 05**.
5. Enter a number (up to 20 digits).  
Example: **4155551212**.
6. Press **SET**.  
You then will be prompt to enter the name or company associated with this number.
7. Enter the name by using the number keys (up to 17 characters).  
Example: **NJ OFFICE**.  
(See pages 3-5 and 3-6 for how to enter text.)

**STATUS OF LCD DISPLAY**

09/12/1993 15:25

1. TEMP. SETTINGS

4. SET AUTO DIAL

1. ONE-TOUCH DIAL

SELECT ONE-TOUCH

\*05: \_\_\_\_\_

ENTER & SET

\*05:4155551212\_

NAME: \_\_\_\_\_

ENTER & SET

NAME:NJ OFFICE

## TELEPHONE FUNCTION SETTINGS

8. Press **SET**.

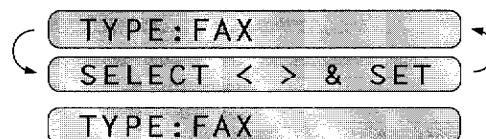

9. Select the type of number (FAX, TEL, F/T, CHAIN) by using the ← (left arrow) or → (right arrow) to display the type you want.  
(See For Your Information of below.)  
Example: FAX

10. Press **SET**.

SELECT ONE-TOUCH

11. Return to step 4 to enter another number, or press **STOP** to return to date and time.

### Helpful Hints

If you have to wait for a dial tone when you get access to the outside line, you should use **REDIAL/PAUSE**. When you press **REDIAL/PAUSE**, a dash “-” will appear on the display. By storing the numbers with a pause, you can create a delay of 3.5 seconds.

## FOR YOUR INFORMATION

### *Types of Numbers*

When you store a number as a One-Touch or as a Speed-Dial number, you have a choice of choosing what type of number it is. There are 4 options:

1. FAX (A fax number).
2. TEL (A telephone number).
3. F/T (Both a fax number and a telephone number)
4. CHAIN (A number, usually an access code, for chain dialing).

### *Chain Dialing*

Sometimes you may want to choose from among several long-distance carriers when you make a call. This is because rates may vary depending on the time and destination. To take advantage of low rates, you can register the access code of a long-distance carrier as a One-Touch or a Speed-Dial number for chain dialing. To do this, you store the access code as you would a regular number and register it as a “chain” number. (See the step 9 of this page.) Then, when you want to make a call, you use this number in combination with the regular number, which also may be a One-Touch or a Speed-Dial number.

You can start a chain dialing call by pressing a One-Touch key or SPEED DIAL and the two digits that has an access code. Next you press another One-Touch key or SPEED DIAL and the two digits which has the regular phone number or press the number manually, and then press **START** to begin calling.

## Storing Speed-Dial Numbers

When you store a phone or fax number as a Speed-Dial number, you need to enter a **two-digit number**, from 01 to 40 for FAX-680 and from 01 to 10 for FAX-600 using the number keys. For example, you cannot enter "5". You need to enter "0", "5". You can store as many as 40 numbers (FAX-680) or 10 numbers (FAX-600) as Speed-Dial numbers.

### KEYS TO BE PRESSED

1. Press **FUNCTION**.
2. Press **4**.
3. Press **2**.
4. Use the number keys to enter two digits number.  
Example: **05**.
5. Enter the number (up to 20 digits).  
Example: **5555151**.
6. Press **SET**.  
You then will be prompted to enter the name or company associated with this number.
7. Use the number keys to enter a name (up to 15 characters).  
Example: **MANCHESTER**.  
(See pages 3-5 and 3-6 for how to enter text.)
8. Press **SET**.
9. Select the type of number (FAX, TEL, F/T, CHAIN) by using ← (left arrow) or → (right arrow) to display the type you want.  
Example: **TEL**.
10. Press **SET**.
11. You are ready to enter another Speed-Dial number, or press **STOP** to return to date and time.

### STATUS OF LCD DISPLAY

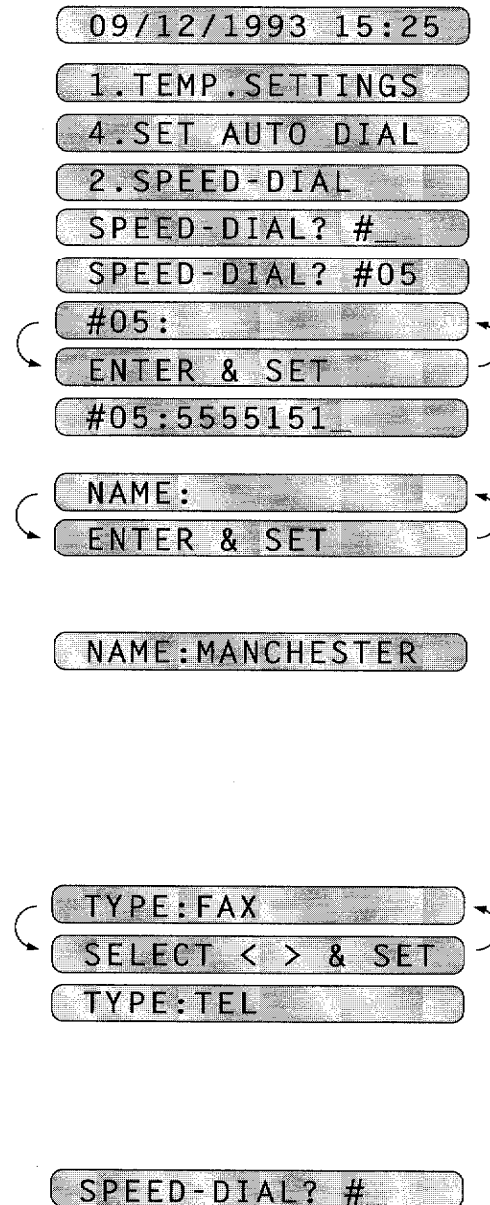

# TELEPHONE FUNCTION SETTINGS

- Helpful Hints**
1. Print out the All Dial List to make sure you have stored the correct numbers. (See page 10-2.) This list will contain the type of number: FAX or TEL.
  2. Even if there should be a loss of electrical power to your fax machine, the telephone and fax numbers you have stored will not be lost.

## FOR YOUR INFORMATION

### ***When You Wish to Change to the Store One-Touch and Speed Dial Numbers (During Step 4 on Page 4-4, 6)***

When you press the One-Touch key or Speed-Dial number, if it is already in use, you will be asked if you wish to change it or exit and select a different One-Touch or Speed-Dial number. This display does not appear if the One-Touch key or Speed-Dial you chose is not assigned.

1. Press **1** to assign a new number to the One-Touch key or Speed-Dial, or press **2** to choose a different One-Touch key or Speed-Dial.



2. If you are replacing an existing number with a new one, the old number and name will appear in the display. Press **CLEAR** to erase the old number and name. Then, enter the new number and name and press **SET** to store the entry.

### ***Memory Storage***

Your fax machine is equipped with an internal battery that will keep it working for up to two hours after power has been cut off. After that time, the date and time will be lost and you will have to re-enter the information. All other settings in the **USERS OPTIONS** and **SETUP SYSTEM** functions are stored permanently and will be retained even in the event of a power failure.

- Helpful Hints**
1. If your fax machine is connected to a PBX, you may need to insert an additional number before each fax or telephone number to get access to the outside line.

## 5. USING THE UNIT AS A TELEPHONE

Your fax machine can be used to make regular telephone calls. You can dial numbers manually, by pressing the number keys, or by using One-Touch or Speed-Dialing.

### *Manual Dialing*

1. Pick up the handset, or press **HOOK**.
2. When you hear the dial tone, you can begin dialing by pressing the number keys.
3. If you used **HOOK**, pick up the handset when the call is answered.

### *One-Touch Dialing*

1. Pick up the handset, or press **HOOK**.
2. When you hear the dial tone, press the desired **One-Touch** key.
3. If you used **HOOK**, pick up the handset when the call is answered.

If you try to use a One-Touch number that has not been registered, you will hear a warning sound and the display will carry a message reading, "NOT REGISTERED". The display will return to normal after 2 seconds.

### *Speed Dialing*

1. Pick up the handset or press **HOOK**.
2. When you hear the dial tone, press **SPEED DIAL** and then the 2-digit Speed-Dial number.
3. If you used **HOOK**, pick up the handset when the call is answered.

#### FOR YOUR INFORMATION

##### *Using Keys with the Telephone*

- Use **REDIAL / PAUSE** for putting a pause between numbers.
- Use **HOLD** to put a call on hold. You can put down the handset without disconnecting the call
- Use **#** to switch the dialing type to "tone" from "pulse." This key is also used for push-button services, such as those offered by banks, credit card companies, or paging services.

##### *On Hook Dialing*

When you make a call using **HOOK**, you can listen to the other end of the line, but they can't hear you unless you pick up the handset. Also, if you press **HOOK** a second time, the call will be disconnected.

## USING THE UNIT AS A TELEPHONE

### ***Telephone Index*** (Only for FAX-680)

---

Once you have registered a name and number as a One-Touch number or as a Speed Dial number, you can alphabetically find where things are with the Telephone Index. You can also dial a number directly from the Telephone Index.

#### **KEYS TO BE PRESSED**

1. Press **TEL-INDEX**.
2. Press ← (left arrow) or → (right arrow) or use the number keys to input the first character of the stored name, to find the name.
3. Pick up the handset, or press **HOOK**.
4. Press **START** to begin dialing. Return the handset to its cradle or press **HOOK** to cancel the call.

#### **STATUS OF LCD DISPLAY**

09/12/1993 15:25

TEL. INDEX

NJ OFFICE

## 6. SENDING FAXES

### A) BASIC FAX TRANSMISSIONS

#### *The Size of Your Documents*

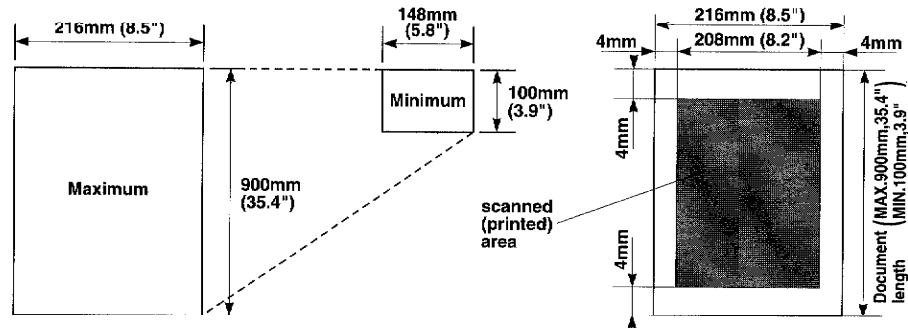

The size of the documents you want to send by fax should not be larger (or smaller) than what your fax machine can accommodate. The documents should each be between 148 and 216 mm (5.8 and 8.5 inches) wide and between 100 and 900 mm (3.9 and 35.4 inches) long.

The maximum width of the scanned area is 208 mm (8.2 inch).

#### *How to Set the Document*

To send a fax, first insert the document you wish to send, face down, in the document feeder. The top edge of the document should go in first, or the fax will be received up side-down.

To prevent the document from skewing at it is fed, adjust the paper guides to fit the width of the document.

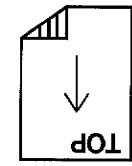

#### NOTICE

##### *About the Documents You Send...*

Do not use documents that are curled, wrinkled, folded, ripped, or that contain staples, paper clips, paste, or tape. Also, do not use cardboard, newspaper, or fabric.

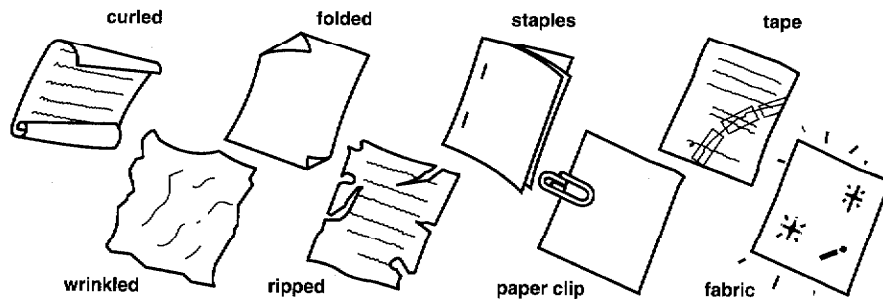

## ***The Auto Document Feeder (ADF)***

The Auto Document Feeder (ADF) automatically feeds documents (**up to 15 pages for FAX-680 and 10 pages for FAX-600**) into the fax machine, one at a time. The thickness and weight of the documents should fall into the following categories:

**Thickness:** For one sheet: 0.07 to 0.12 mm ( $2.8 \times 10^{-3}$  to  $4.7 \times 10^{-3}$  inches).  
For multiple sheets: 0.07 to 0.10 mm ( $2.8 \times 10^{-3}$  to  $3.9 \times 10^{-3}$  inches).

**Weight:** For one sheet: 52 to 85 g/m<sup>2</sup> ( $0.07 \times 10^{-3}$  to  $0.121 \times 10^{-3}$  lbs/inch<sup>2</sup>).  
For multiple sheets: 52 to 80 g/m<sup>2</sup> ( $0.07 \times 10^{-3}$  to  $0.114 \times 10^{-3}$  lbs/inch<sup>2</sup>).

As a reference, please note that the paper on which this is printed has the following thickness and weight:

Thickness: 0.10mm

Weight: 80g/m<sup>2</sup>

Before inserting documents into the document feeder, make sure the documents are not stuck to each other, and fan the sheets of paper before you put them in. Make sure you always put the documents in *face down*.

## ***Getting Ready to Send Faxes***

### **Resolution**

You can choose a setting (STANDARD, FINE, SUPERFINE, or PHOTO) for the resolution any time before you press **START** or **COPY**. You can choose a setting by pressing the Resolution key. (  means light off.  means light on.)

#### **STANDARD**



The STANDARD resolution can be used for most typewritten text. When the STANDARD setting is on, both lights are off. Transmission speed is normal.

#### **FINE**

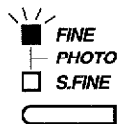

The FINE resolution is an ideal setting to use if you want to send documents that have small print. When the FINE setting is on, the FINE light will be lit. Transmission speed is slower than STANDARD.

#### **SUPERFINE**

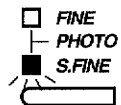

The SUPERFINE resolution is a good setting to use for documents with very small print or artwork. When the SUPERFINE setting is on, the S. FINE light will be lit. Transmission speed is slower than FINE.

#### **PHOTO**

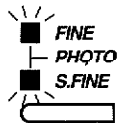

The PHOTO resolution is ideal for sending documents that have varying shades of gray, such as photographs. The PHOTO setting is on when both lights are lit. Transmission speed is slower than FINE.

To set resolution per page, refer to Multiple Resolution Transmission on page 6-10.



**Contrast**

The fax machine has automatic contrast control, but if you need to send a document that is very light or very dark, you may want to set the contrast yourself.

Use **SUPER LIGHT** to send a very light document.

Use **SUPER DARK** to send a very dark document.

**KEYS TO BE PRESSED**

1. Place the documents face down in the feeder.
2. Press **FUNCTION**.
3. Press **1**.
4. Press **1**.  
The display will alternate messages.
5. Use ← (left arrow) or → (right arrow) to select one of the settings, **AUTO**, **S.LIGHT**, or **S. DARK**.  
Example: **S.LIGHT**
6. Press **SET**.
7. Press **STOP** to exit.

**STATUS OF LCD DISPLAY**

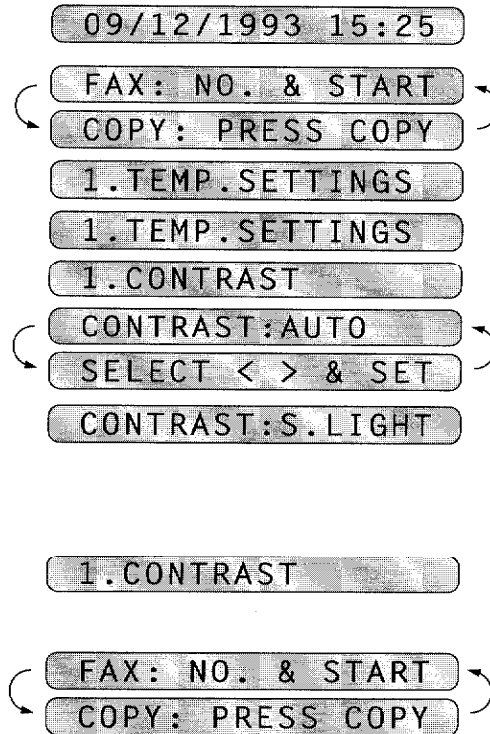

Then start fax sending operation (page 6-3) or copy (page 8-1).

***Sending a Fax Automatically***

**KEYS TO BE PRESSED**

1. Insert the documents face down in the feeder.
2. Enter a fax number.  
Example: One-Touch dialing
3. Press **START**.

**STATUS OF LCD DISPLAY**

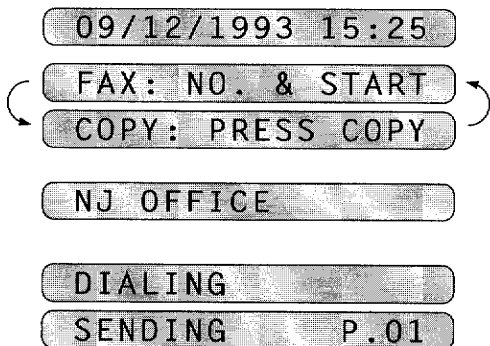

**Ch. 6**

*Sending a Fax Manually***KEYS TO BE PRESSED**

1. Insert the documents face down in the feeder.
2. Lift the handset or press **HOOK** and listen for the dial tone.
3. Dial the fax number  
You can use manual dialing, One-Touch dialing, or Speed Dialing, or Tel-Index (only for FAX-680).
4. When you hear a fax tone, press **START**.  
Your fax machine will begin sending the documents.
5. Return the handset to its cradle, if you did not use **HOOK**.

**STATUS OF LCD DISPLAY**

09/12/1993 15:25

FAX: NO. &amp; START

COPY: PRESS COPY

ENTER FAX NO.

PRESS START KEY

NJ OFFICE

SENDING

**FOR YOUR INFORMATION***Dialing a Number*

There are several ways to dial a number. When you dial, you can check the display to see who you are calling. Choose one of the following dialing methods:

- 1) Manual Dialing  
Dial the fax number by pressing the number keys, then press **START**.
- 2) One-Touch Dialing  
Press one of the One-Touch keys. (The numbers must be stored beforehand. See page 4-4.) Then press **START**.
- 3) Speed-Dialing  
Press **SPEED DIAL**, then use the number keys to enter a two-digit code. For example, press "0", "5" for 05. (The numbers must be stored beforehand. See page 4-6.) Then press **START**.
- 4) Telephone Index (Only for FAX-680)  
You can use the Tel-Index to make telephone or fax calls. (See page 5-2.)

*Talking to the Other Party When Sending a Fax*

When you are sending a fax manually and you hear recipient's voice instead of fax tones, you can use the handset to have a conversation. When or if you want to then send a fax, ask the person on the other line to press **START** on his/her fax machine and when you hear fax tones you can press **START** to begin sending your fax.

## Automatic and Manual Re-dialing

If a number you have dialed is busy or your call did not go through for some other reason, you can re-dial that number. There are two ways for re-dialing, "automatic" and "manual." Automatic redialing can only be used for faxes that were sent using automatic transmission — not for telephone calls. The factory setting is "auto re-dial on", but you can change it to "auto re-dial off", if needed. If the re-dial function is set on "auto re-dial on", it will automatically re-dial the number 3 times at 5 minute intervals before giving up. Whether the setting is on or off, the fax machine will re-dial the last dialed number when you press **REDIAL/PAUSE** (manual re-dialing).

## Setting the Auto Re-dial

KEYS TO BE PRESSED	STATUS OF LCD DISPLAY
<ol style="list-style-type: none"> <li>1. Press <b>FUNCTION</b>.</li> <li>2. Press <b>6</b>.</li> <li>3. Press <b>3</b>.</li> <li>4. Use ← (left arrow) or → (right arrow) to turn the auto re-dial function ON or OFF. Example:OFF</li> <li>5. Press <b>SET</b>.</li> <li>6. Press <b>STOP</b> to exit.</li> </ol>	<div style="border: 1px solid gray; border-radius: 10px; padding: 2px; margin-bottom: 2px;">09/12/1993 15:25</div> <div style="border: 1px solid gray; border-radius: 10px; padding: 2px; margin-bottom: 2px;">1.TEMP.SETTINGS</div> <div style="border: 1px solid gray; border-radius: 10px; padding: 2px; margin-bottom: 2px;">6.TEL OPTIONS</div> <div style="border: 1px solid gray; border-radius: 10px; padding: 2px; margin-bottom: 2px;">3.AUTO REDIAL</div> <div style="border: 1px solid gray; border-radius: 10px; padding: 2px; margin-bottom: 2px;">AUTO REDIAL:ON</div> <div style="border: 1px solid gray; border-radius: 10px; padding: 2px; margin-bottom: 2px;">SELECT &lt; &gt; &amp; SET</div> <div style="border: 1px solid gray; border-radius: 10px; padding: 2px; margin-bottom: 2px;">AUTO REDIAL OFF</div> <div style="border: 1px solid gray; border-radius: 10px; padding: 2px; margin-bottom: 2px;">3.AUTO REDIAL</div>

Ch. 6

FOR YOUR INFORMATION

**Possible Settings When You Send a Fax Manually**

- Resolution (See page 6-2, 6-10.)
- Contrast (See page 6-3.)
- Cover Page (See page 6-12.)
- Overseas Mode (See page 6-19.)
- Call Reservation (See page 6-15.)

**Printing Page Headers**

Your fax machine can print a page header on top of every document you send. It is printed on the receiving party's fax paper. It contains the date and time of transmission, your fax number and name (Station ID), and page number. Of course you need to register your Station ID beforehand for that information to be available.

Transmission Date and Time	Station ID	Page Number
09/12/1993 15:25	4155554444 BROTHER	PAGE 01

***Delayed Transmission***

You can set the timer to send documents at a later time (up to 24 hours later). Your fax machine will also produce a report the "Delayed Sending Report", after the fax is sent.

**KEYS TO BE PRESSED**

1. Insert the documents into the feeder.
2. Press **TIMER**.
3. Enter the time in 24-hour format using the number keys.  
Example: 19:45 (7:45 P.M.)
4. Enter the fax number.
5. Press **START**.  
The fax machine waits until the specified time to call.

**STATUS OF LCD DISPLAY**

09/12/1993 15:25  
 FAX: NO. & START  
 COPY: PRESS COPY  
 SET TIME=00:00  
 SET TIME=19:45  
 ENTER FAX NO.  
 PRESS START KEY  
 NJ OFFICE  
 TIMER WAITING

***Setting the Daily Timer (for Delayed Transmissions)***

The Daily Timer function lets you send a fax at a set time every day. This is handy for sending delayed jobs that must go out at the same time daily. Once you make this setting, you don't have to enter the time everyday. You just press **TIMER**, the number and **SET** if you want to send.

**KEYS TO BE PRESSED**

1. Press **FUNCTION**.
2. Press **7**.
3. Press **2**.
4. Enter the time in 24-hour format using the number keys.  
Example: 19:45 (7:45 P.M.)
5. Wait for two seconds.
6. Press **STOP** to exit.

**STATUS OF LCD DISPLAY**

09/12/1993 15:25  
 1.TEMP.SETTINGS  
 7.SETUP SYSTEM  
 2.DAILY TIMER  
 ENTER TIME:00:00  
 ENTER TIME 19:45  
 2.DAILY TIMER

### *Interrupting the Timer and Polled Job*

You can send a fax without canceling the timer (see page 6-6) or polled waiting (see page 9-2) with document in the feeder by “interrupting” it. When you interrupt the timer to send a “new” set of documents, the fax machine does not automatically re-dial the number if it is busy. Also, you cannot use the function mode when you are interrupting the timer.

Example: TIMER WAITING with Document in the feeder.

#### KEYS TO BE PRESSED

1. Press **INTERRUPT**.
2. Remove documents from the fax machine.
3. Place “new” documents into the feeder.
4. Enter the new number to send the documents then press **START**.
5. After the transmission is finished, place the “old” documents back into the feeder.
6. Press **INTERRUPT** to restore the timer.

#### STATUS OF LCD DISPLAY

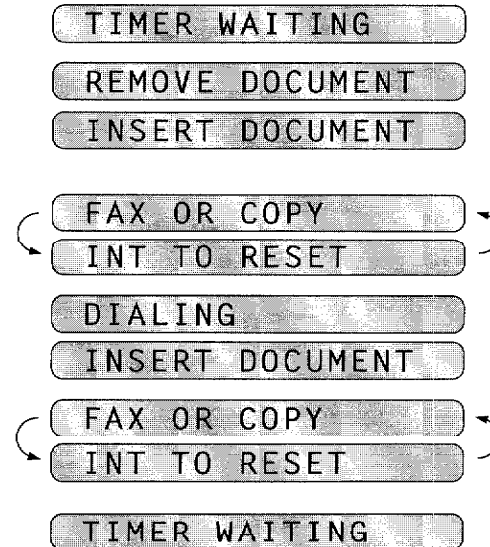

## *Canceling the Job*

Use the cancel job function to permanently remove scheduled tasks such as polling or polled job (see page 9-1) and timer job (see page 6-6) from your fax machine.

Example: TIMER WAITING with document in the feeder.

### KEYS TO BE PRESSED

1. Press **FUNCTION**.
2. Press **2**.  
Any waiting jobs that have been setup will appear in the display.
3. Use ← (left arrow) or → (right arrow) to select the job you wish to cancel.
4. Press **SET**.
5. Press **1** to cancel the selected job, or **2** to exit without canceling.  
If **1** is selected, the job will be canceled and the next job in the queue will appear in the display.
6. To cancel the next job, press **1** again.  
To exit, simply press **2**.  
In the event that no jobs are waiting to be processed, a "NO JOB WAITING" message will appear in the display.

### STATUS OF LCD DISPLAY

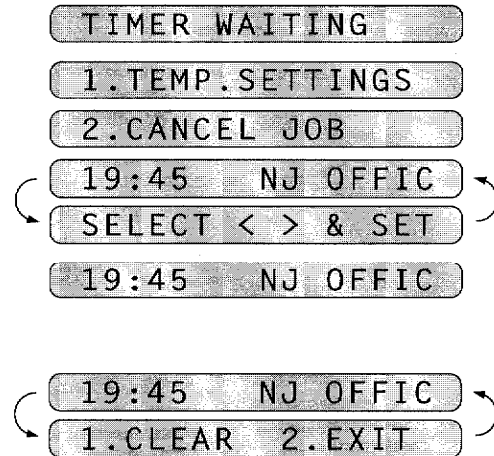

## B) FAX TRANSMISSION OPTIONS

### *Setting the Overseas Mode*

Using the Overseas mode is an efficient way to send faxes overseas. If you experience difficulty with sending faxes overseas, you may want to use the overseas mode.

#### KEYS TO BE PRESSED

1. Insert the documents into the feeder.
2. Press **FUNCTION**.
3. Press **1**.
4. Press **3**.
5. Press ← (left arrow) or → (right arrow) to switch to ON.
6. Press **SET**.
7. Press **STOP** to exit.
8. Then start the fax sending operation. (See page 6-3.)

After sending your fax, the machine will revert to OFF.

#### STATUS OF LCD DISPLAY

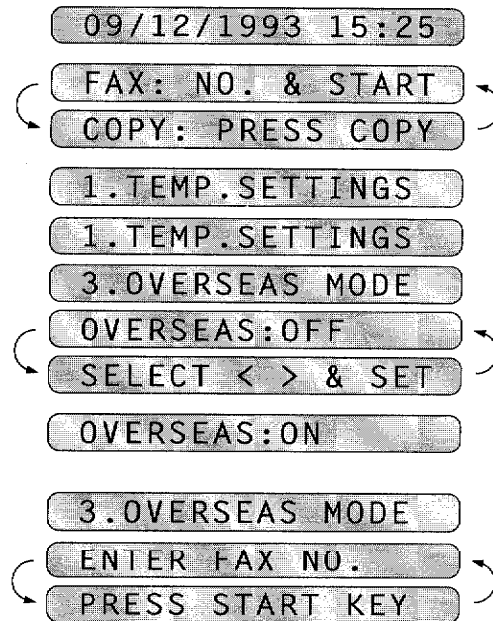

***Setting Your Fax Machine for Multiple Resolution Transmission***

You can set the resolution of the documents you send by pressing the Resolution key. Once you set the resolution, all the pages will be sent with the same resolution. However, there may be times when you want to send some pages with one type of resolution, such as "standard", and other pages in another resolution, such as "photo." If you send all pages in photo resolution, for instance, it would take a great deal of time. It would be nice if you could specify what pages are to be sent with what resolution to minimize transmission time. You are in luck because you can make such a setting using the 1.TEMP. SETTINGS function.

**KEYS TO BE PRESSED**

1. Place the documents into the feeder.
2. Press **FUNCTION**.
3. Press **1**.
4. Press **2**.
5. Press ← (left arrow) or → (right arrow) to find the resolution you want for the page in your documents.  
Example: FINE.
6. Press **SET**.  
Return to step 5 for setting the resolution for page 2 and the following pages.
7. When you finished setting the resolution for all your pages, press **STOP**.
8. Enter the fax number.
9. Press **START**.  
The resolution will revert to STANDARD after the documents have been sent.

**STATUS OF LCD DISPLAY**

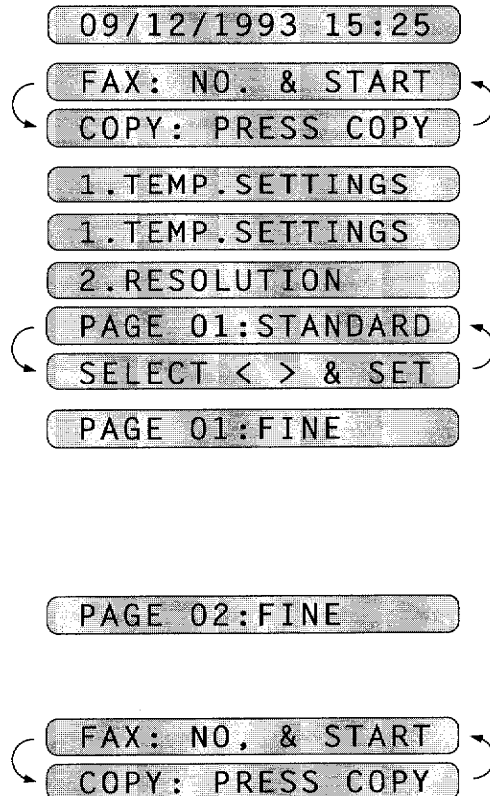



**Gray Scale** (Only for FAX-680)

You can set initial gray scale level either 16 or 32. The initial setting is 32. This is the initial level of photo mode which is effective to sending photographs. Even if you want to send a document with 32 level photo mode, if the receiving machine does not have super fine mode, the machine will fall back to 16 level automatically.

**KEYS TO BE PRESSED**

1. Press **FUNCTION**.
2. Press **5**.
3. Press **4**.
4. Press ← (left arrow) or → (right arrow) to choose either 16 or 32.  
Example: 16.
5. Press **SET**.
6. Press **STOP** to exit.

**STATUS OF LCD DISPLAY**

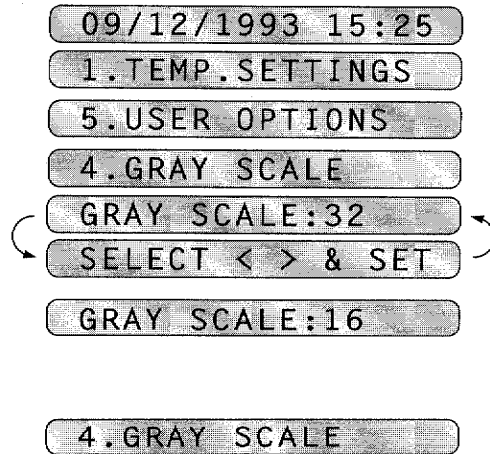

**FOR YOUR INFORMATION**

**About Resolutions...**

Your fax machine can see only in black and white, so when you send a color photograph, even with photo resolution, different colors may appear as the same shade of gray on the receiving fax.

***Sending a Fax with a Cover Page***

An automatic Cover Page will allow you to send details of who the fax is going to, who it is from and when it was sent. This what the Cover Page looks like:

09/12/1993 15:25	
==== COVER PAGE ====	
TO: NJ OFFICE	(1)
FAX: 4155551212	
FROM: BROTHER	(2)
FAX: 4155554444	
TEL: 4155554445	
00 PAGE[S] TO FOLLOW	(3)
COMMENT: PLEASE CALL	(4)

- (1) The "TO" information comes from the One-Touch or the Speed-Dial memory. If you are dialing manually, the name of the destination will be left blank.
- (2) The "FROM" information comes from the Station ID.
- (3) The number of pages you are sending.
- (4) Your comments. You may customize comments (Only for FAX-680).

**FOR YOUR INFORMATION**

***The Comments Section on the Cover Page***

You can choose from among 6 options for FAX-680 and 4 options for FAX-600. The first option is to send no comment at all. The next 3 are built-in comments, and the last two (Only for FAX-680) are ones you can set yourself. (For more information see page 6-14.)

- 1. COMMENT OFF
- 2. PLEASE CALL
- 3. URGENT
- 4. CONFIDENTIAL
- \*5. (Your own customized comment).
- \*6. (Your own customized comment). \*Only for FAX-680

**KEYS TO BE PRESSED**

1. Insert the documents into the feeder.
2. Press **COVERPAGE**.
3. Use ← (left arrow) or → (right arrow) to select the comment you want.  
Example: 2.PLEASE CALL.
4. Press **SET**.
5. Enter the number of pages you are sending. (Enter "0", "0" to leave the number of pages blank.)  
The Cover Page light should come on.
6. Enter the fax number and press **START**.

**STATUS OF LCD DISPLAY**

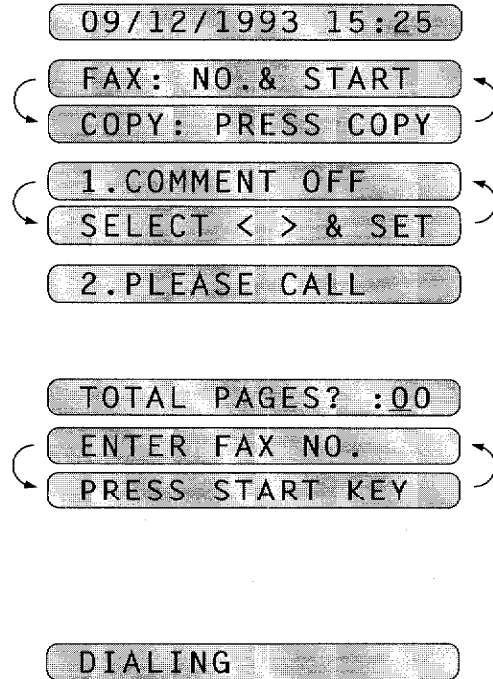

**Setting Cover Page ON/OFF**

If you often send an automatic Cover Page, you can set it to ON to avoid having to set up the details of the Cover Page each time. Here is how you can switch the setting for the automatic Cover Page to ON or OFF:

**KEYS TO BE PRESSED**

1. Press **FUNCTION**.
2. Press **5**.
3. Press **3**.
4. Press ← (left arrow) or → (right arrow) to choose ON or OFF.  
Example: ON.
5. Press **SET**.

**STATUS OF LCD DISPLAY**

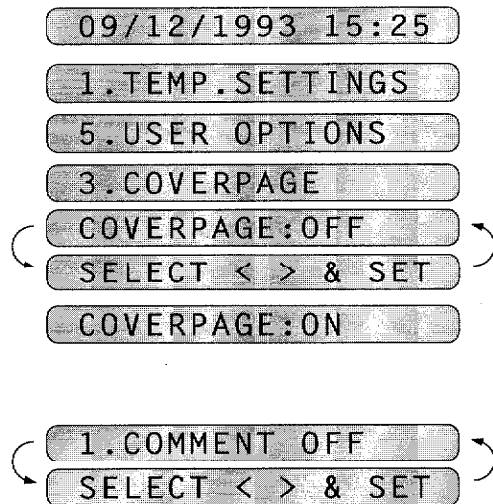

Ch. 6

6. If you selected ON, you need to select a comment, by pressing ← (left arrow) or → (right arrow).  
Example: 2.PLEASE CALL

2.PLEASE CALL

7. Press **SET**.

The Cover Page light should come on.

3.COVERPAGE

8. Press **STOP** to exit.

FOR YOUR INFORMATION

***Sending an Automatic Cover Page***

If you have the Cover Page ON/OFF setting to ON, the total number of pages will not be printed on the Cover Page. Also, the comment you selected when you set it to ON will be printed on all the Cover Pages you send.

**Helpful Hints** Even if the Cover Page ON/OFF setting is ON, you can avoid sending an electrical Cover Page by pressing COVERPAGE once.  
You can turn off the Cover Page light by pressing COVERPAGE.

***Customizing Your Cover Page Comment (Only for FAX-680)***

**KEYS TO BE PRESSED**

1. Press **FUNCTION**.
2. Press **7**.
3. Press **6**.
4. Press ← (left arrow) or → (right arrow) to select 5 or 6 where you wish to store a comment.  
Example: 5.
5. Press **SET**.
6. Enter your customized comment by using the number keys (up to 27 characters).  
(See page 3-5 for more details.)  
Example: TOP SECRET.
7. Press **SET**.
8. Press **STOP** to exit.

**STATUS OF LCD DISPLAY**

09/12/1993 15:25

1.TEMP.SETTINGS

7.SETUP SYSTEM

6.SET COVERPAGE

5.

SELECT < > & SET

5.

5.

5.TOP SECRET

6.SET COVERPAGE

***Sending a Fax with Call Reservation***

You can send a fax and then talk to the recipient using the Call Reservation feature. When your fax has been printed on the receiving end, the receiving fax machine will ring as if it were receiving a telephone call. If the recipient picks up the handset, your fax machine will ring. Then you can pick up your handset and start a conversation. If the recipient does not pick up the handset when the Call Reservation function is ON, your fax machine will leave a fax message to have them call you back if you have the CALL BACK MESSAGE set to ON.

**KEYS TO BE PRESSED**

1. Insert the documents into the feeder, then press **CALL**.
2. Use ← (left arrow) or → (right arrow) to select Call Back Message ON or OFF.  
Example: Call Back Message ON.
3. Press **SET**.  
The call light should come on.
4. Enter the fax number, then press **START**.
5. Pick up your handset if it rings.

**STATUS OF LCD DISPLAY**

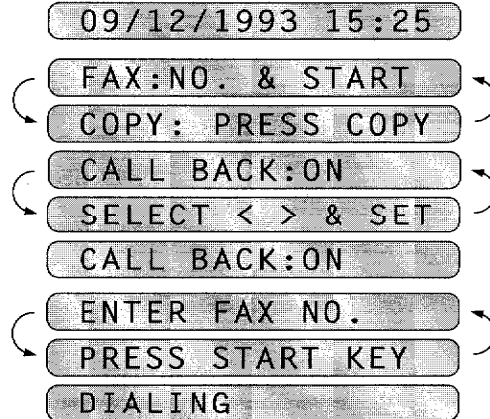

```

09/12/1993 15:25
=== CALL BACK MESSAGE ===

TO:      NJ OFFICE
FAX:    4155551212

FROM:    BROTHER

PLEASE CALL AT [TEL] 4155554445
              [FAX] 4155554444
    
```

**FOR YOUR INFORMATION**

***Using the Call Reservation Function***

1. There are some fax machines that will not respond to this function.
2. When it is auto re-dialing, you cannot use the Call Reservation function, but if Call Back Message is ON, your fax machine will leave a Call Back Message to have the other party call you back.
3. You cannot use Call Reservation with the timer or with the polling function.

## 7. RECEIVING FAXES AND OTHER CALLS

### Selecting an Answer Mode

There are 4 answer modes for your fax machine. You can choose one by pressing the Answer Mode key repeatedly until you find the mode you want. Choose one that suits your needs. If you need more information about a particular mode, refer to the page number given.

(  means light off.  means light on.)

Answer Mode		For	See Page
1. MANUAL	<input type="checkbox"/> AUTO ANS <input type="checkbox"/> TAD <input type="checkbox"/> F/T	Answers each call manually. Mainly use for telephone.	7-2



If you want to answer each incoming call, choose MANUAL mode.

2. AUTO	 AUTO ANS <input type="checkbox"/> TAD <input type="checkbox"/> F/T	Dedicated fax use. Telephone line and fax line are separate.	7-2
---------	--	--	-----

If you use your telephone line exclusively for sending and receiving faxes, you may want to use AUTO mode. In this mode, you can receive all your incoming faxes automatically.

3. F/T	<input type="checkbox"/> AUTO ANS <input type="checkbox"/> TAD  F/T	Both fax and telephone use. When you share one line for your telephone and fax machine.	7-3
--------	--	---	-----

If you want to use your telephone line for both fax and telephone, you may want to choose F/T mode. In F/T mode, your fax machine will answer incoming faxes automatically.

4. TAD	 AUTO ANS <input type="checkbox"/> TAD  F/T	Use with external TAD (Telephone Answering Device). When you are not at home.	7-6
--------	---	---	-----

When you want to use your fax machine together with your telephone answering machine, choose TAD mode.

## ***Manual Reception (MANUAL mode)***

When you set the Answer Mode to manual, you can answer each incoming call yourself. Here is what you should do when using MANUAL Mode:

<b>If You Get a...</b>	<b>Then You Should...</b>
1. Regular phone call	Talk as you normally would.
2. Phone call and request to send a fax	Press <b>START</b> after finishing talking, and replace the handset. Note : Sender must also press <b>START</b> .
3. Fax tone...	Press <b>START</b> , and replace the handset.

## ***Automatic Fax Reception (AUTO mode)***

You can automatically receive all your faxes in Automatic Fax Reception mode (AUTO mode). Select this mode by pressing the Answer Mode key.

## ***Setting the Ring Delay***

You can set up the number of rings before the fax machine will receive automatically in AUTO mode and F/T mode.

### **KEYS TO BE PRESSED**

1. Press **FUNCTION**.
2. Press **6**.
3. Press **2**.
4. Press **←** (left arrow) or **→** (right arrow) repeatedly until you find the number of rings you want.  
Example: 00.  
  
When you set 00, you can receive your incoming faxes without any ring delays.
5. Press **SET**.
6. Press **STOP** to exit.

### **STATUS OF LCD DISPLAY**

09/12/1993 15:25

1. TEMP. SETTINGS

6. TEL OPTIONS

2. RING DELAY

RING DELAY:02

SELECT < > & SET

RING DELAY:00

2. RING DELAY

# RECEIVING FAXES AND OTHER CALLS

## The F/T Switch (F/T Mode)

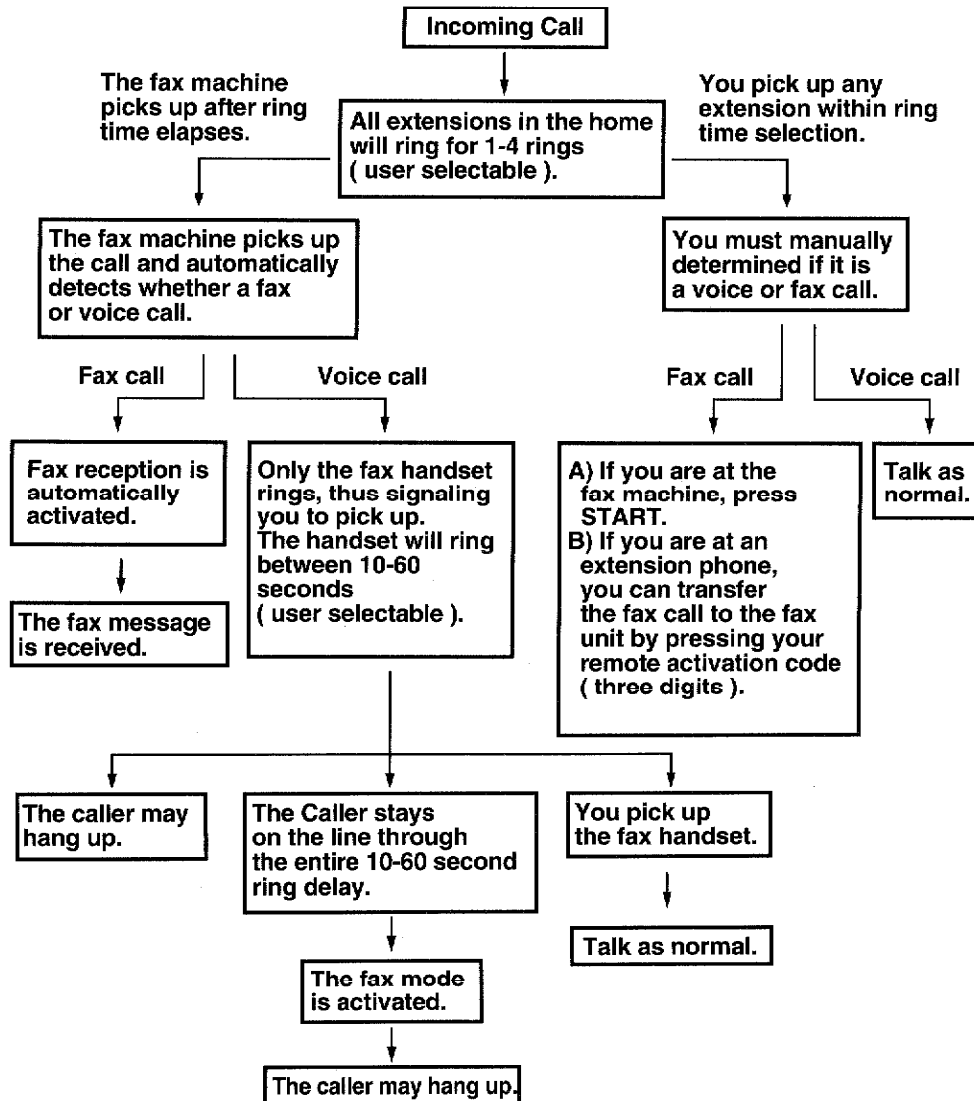

## Setting the F/T Ring Time

You can specify the maximum time you want the fax machine to ring in case of telephone. There are four predefined settings; 10, 20, 30 or 60 seconds.

### KEYS TO BE PRESSED

1. Press **FUNCTION**.
2. Press **6**.

### STATUS OF LCD DISPLAY

09/12/1993 15:25

1.TEMP.SETTINGS

6.TEL.OPTIONS



3. Press **5**.

5.F/T RING TIME

RING TIME:20 SEC

SELECT < > & SET

RING TIME:10 SEC

4. Press ← (left arrow) or → (right arrow) repeatedly until you find the setting you want.

Example: 10sec.

5. Press **SET**.

5.F/T RING TIME

6. Press **STOP** to exit.

## Remote Activation

If you are using a tone dialing line, you can remotely activate or deactivate your fax machine from an external phone (a phone connected to your fax machine) or from an extension phone (a phone connected to the same line as your fax machine).

## Connecting an External or Extension Telephone to the Unit

You may connect an external or extension telephone to your fax machine, as shown below. Use the "EXT." jack on your fax machine.

Alternatively, you may wish to use this "EXT." jack to connect a telephone answering device (TAD).

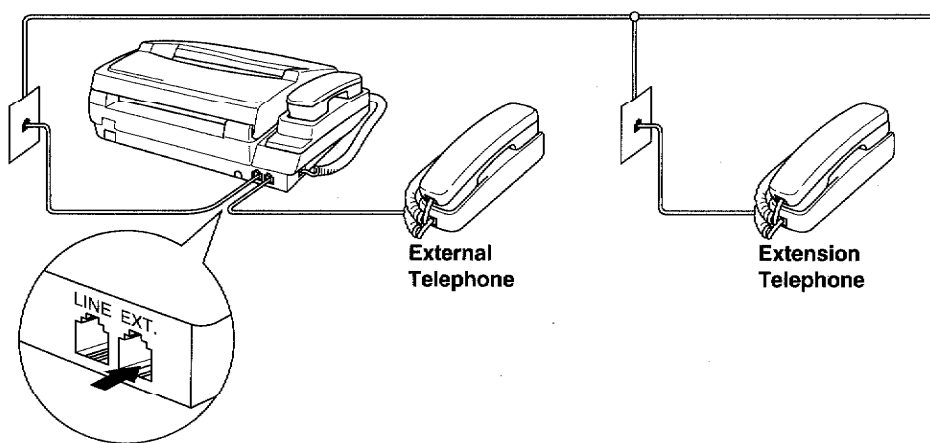

When the external telephone is in use, if the handset on the fax machine is picked up, an alarm will sound and the warning message "EXT. TEL IN USE" will be displayed. You can disconnect the external phone and switch to fax machine by pressing **HOOK**.

# RECEIVING FAXES AND OTHER CALLS

## Using Remote Codes

If you are on an external phone (or extension phone), and you get an incoming fax call, you can transfer the call back to your fax machine by entering a remote activation code. In the same situation, if you get a telephone call from someone who requests that you switch on your fax, you can transfer the call back to your fax machine with this code. Also, you can deactivate the fax machine with another remote code during the F/T ringing from extension phone. In essence you have one remote code to activate your fax machine and one remote code to deactivate it. **The remote code to activate is “\*51”, and the remote code to deactivate is “#51”.** If you want to set your own code, see the following section, “Registering Remote Codes”.

### FOR YOUR INFORMATION

#### *Limitation of Using External (or Extension) Phones*

1. If you accidentally pick up an extension phone when a fax is coming in, you may disrupt the transmission or render some portions unreadable.
2. The remote activation and deactivation code may not work with some telephone systems or telephone sets.

## Registering Remote Codes

### KEYS TO BE PRESSED

1. Press **FUNCTION**.
2. Press **7**.
3. Press **5**.
4. Press **←** (left arrow) or **→** (right arrow) to choose ON or OFF.  
Example: ON.
5. Press **SET**.
6. Enter new remote code to activate.  
(Factory setting is “\*51”.)
7. Enter new remote code to deactivate.  
(Factory setting is “#51”.)
8. Press **STOP** to exit.

### STATUS OF LCD DISPLAY

09/12/1993 15:25

1.TEMP.SETTINGS

7.SETUP SYSTEM

5.REMOTE CODE

REMOTE ACT.:ON

SELECT < > & SET

REMOTE ACT.:ON

ACT.CODE:\*51

DEACT.CODE:#51

5:REMOTE CODE

### ***The TAD Mode***

When you leave your fax machine set in TAD mode, phone calls will be forwarded to the externally connected telephone answering device, and your fax calls will be received automatically.

### ***Connecting an External TAD to the Unit***

You may connect an external TAD to your fax machine, as shown below. Use the "EXT." jack on your fax machine.

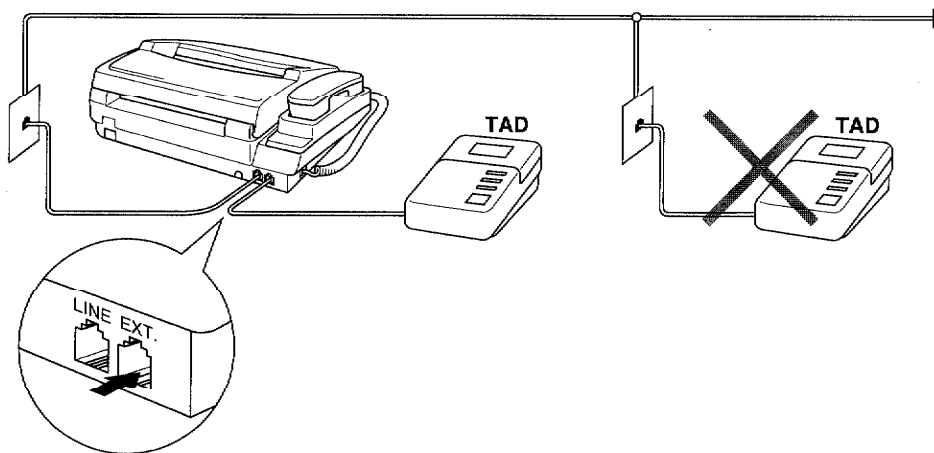

#### **Helpful Hints When You Use TAD Mode**

1. You can inform callers beforehand that if they call manually and get your telephone answering device when they want to send a fax, all they have to do is press your remote code to activate (\*51 unless you have changed it) your fax machine.
2. Another alternative is to record a TAD message that says, for example, "This answering machine is connected to a fax unit. If you may leave a voice message, please speak after beep. If you may send a fax message, please press (your remote activation code) after beep. Thank you."
3. You need to erase the incoming messages on your external telephone answering device when it's full, or TAD mode will not answer any calls, faxes or otherwise.

# RECEIVING FAXES AND OTHER CALLS

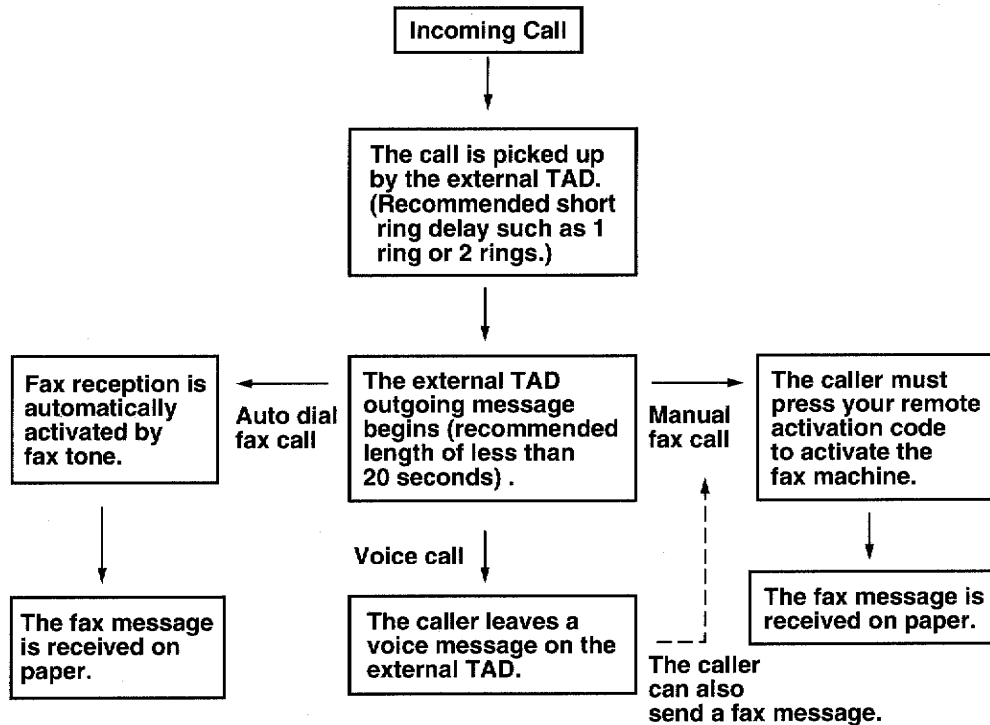

## Telephone Answering Device

1. Set the telephone answering device so that it is ready to record incoming telephone calls.
2. Set the number of rings to **one or two** on your telephone answering device.
3. Try to record the shortest possible message on your telephone answering device (**up to 20 seconds**).

Please note that some faxes that are sent manually cannot be received automatically because some fax machines do not send a fax tone in manual mode.  
So you must indicate a remote activation code for the caller to enter. (See page 7-5.)

## Smoothing

The smoothing feature enhances the appearance of incoming faxes by making the lines smooth and takes no additional time. This function does not apply to outgoing faxes, or to lists or reports you print. The initial setting is ON.

KEYS TO BE PRESSED	STATUS OF LCD DISPLAY
1. Press <b>FUNCTION</b> .	09/12/1993 15:25
2. Press <b>5</b> .	1. TEMP. SETTINGS
3. Press <b>1</b> .	5. USER OPTIONS
	1. SMOOTHING
	SMOOTHING: ON
4. Press ← (left arrow) or → (right arrow) to choose ON or OFF. Example: OFF	SELECT < > & SET
	SMOOTHING: OFF
5. Press <b>SET</b> .	
6. Press <b>STOP</b> to exit.	1. SMOOTHING

## Speaker Volume

There are three settings available for the speaker volume, OFF, LOW or HIGH. This setting controls the loudness of the fax machine's speaker, which is connected to the phone line. The initial setting is LOW.

KEYS TO BE PRESSED	STATUS OF LCD DISPLAY
1. Press <b>FUNCTION</b> .	09/12/1993 15:25
2. Press <b>6</b> .	1. TEMP. SETTINGS
3. Press <b>4</b> .	6. TEL OPTIONS
	4. SPEAKER VOLUME
	SPEAKER: LOW
4. Press ← (left arrow) or → (right arrow) to choose a setting either OFF, LOW or HIGH. Example: HIGH.	SELECT < > & SET
	SPEAKER: HIGH
5. Press <b>SET</b> .	
6. Press <b>STOP</b> to exit.	4. SPEAKER VOLUME

## *Ring Volume*

You can set the ring volume to either OFF, LOW or HIGH. The initial setting is HIGH.

KEYS TO BE PRESSED	STATUS OF LCD DISPLAY
1. Press <b>FUNCTION</b> .	09/12/1993 15:25
2. Press <b>6</b> .	1. TEMP. SETTINGS
3. Press <b>6</b> .	6. TEL OPTIONS
4. Press ← (left arrow) or → (right arrow) to choose either OFF, LOW or HIGH. Example:LOW	6. RING VOLUME
5. Press <b>SET</b> .	RING VOLUME:HIGH
6. Press <b>STOP</b> to exit.	SELECT < > & SET
	RING VOLUME:LOW
	6. RING VOLUME

**Helpful Hints** Even if you select OFF, the ring volume during F/T ringing and Call Reservation ringing is LOW.

## 8. HOW TO USE COPY FUNCTIONS

### *Making a Copy*

These are the steps for making one copy each of your original documents:

KEYS TO BE PRESSED	STATUS OF LCD DISPLAY
1. Place the documents face down into the feeder.	09/12/1993 15:25
2. Press <b>COPY</b> .	FAX: NO. & START COPY: PRESS COPY
	COPYING
	COPYING P.01
	COPYING P.02

- Helpful Hints**
1. When you want to make a copy, make sure the text or image on the original document is not too close to the edge. Your fax machine cannot read anything closer than 4 mm (1/8 inch) from the edge.
  2. Change the resolution to one you like. If you do not set the resolution, the fax machine automatically makes a copy in the SUPERFINE setting. For example, if your original is a photo, you may select the PHOTO resolution. (To get the PHOTO resolution, press the Resolution key repeatedly until both lights are lit.) You can also set the resolution page by page using the 1.TEMP.SETTINGS function. (See page 6-10.)
  3. Do not pull on the paper while copying is in progress. This may ruin the copied image.

9. POLLING

FOR YOUR INFORMATION

**What Is Polling?**

Polling is the process of **retrieving** faxes from another fax machine. You may use your machine to “poll” other machines, or you may ask someone to poll your machine. The party who polls pays for the cost of the call.

**How Does It Work?**

First two parties set up their fax machines so that they can accommodate polling. Then one party leaves documents in the fax machine so that the other party can call up and have the documents sent.

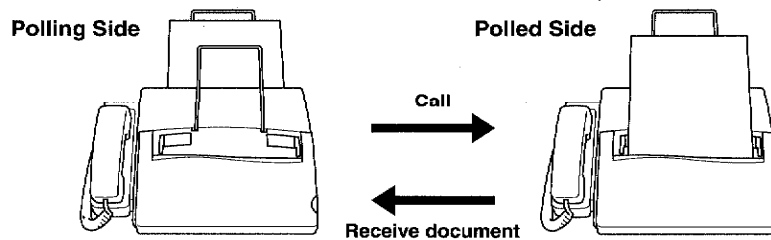

**When to Use Polling?**

Use polling to control the cost of sending a fax.

1. If **you** want to pay for the cost of the call: Send out faxes to other parties as you normally would, and if another party has documents to send you, ask them if you can poll for it.
2. If you want **others** to pay for the cost of the call: Ask them to poll your fax machine for documents they want, and if they want to send you documents, tell them you do not wish to poll their machine for it, (if they ask).

\* There are some fax machine that will not respond to this function.

**Helpful Hints Using Polling Effectively (Examples)**

**Problem No. 1:** You want another party to send you a long fax, but they do not want to pay for the call.

**Solution:** Ask them to leave the document in their fax machine so you can poll for it.

**Problem No. 2:** Sales representatives have difficulty sending in faxes to the head office’s fax machine because it is busy so much of the time.

**Solution:** Head office can poll the sales representatives’ fax machine.

**Problem No. 3:** Because of the time or location, it is cheaper for someone else to call you than it is for you to make the call.

**Solution:** Ask the other party to poll for the documents and offer to pay for the call at their lower rate.



### ***Polling Another Fax Machine***

Once you have set up polling, as described below, and the other party has set their fax machine to "POLLED WAITING", you can automatically receive their documents.

#### **KEYS TO BE PRESSED**

Make sure no documents in the feeder.

1. Press **POLLING**.
2. Press **SET**.
3. Enter the fax number.
4. Press **START**.

#### **STATUS OF LCD DISPLAY**

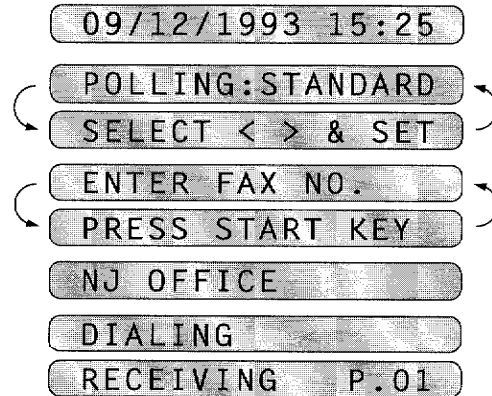

### ***Setting up for Polled Waiting***

When a call comes in to retrieve documents you have placed in the fax machine for polled waiting, and your machine starts to send the documents. Your fax machine prints out a polled report when the transmission is completed.

#### **KEYS TO BE PRESSED**

1. Place the documents into the feeder.
2. Press **POLLING**.
3. Press **SET**.
4. Press **START** and wait for the polling call to come in.

#### **STATUS OF LCD DISPLAY**

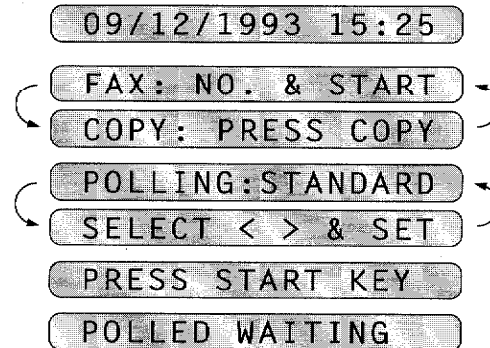

## *Secure Polling*

---

Secure Polling is a way to keep your documents and others' from falling into the wrong hands while the fax machines are set up for polling. You can use Secure Polling only with another Brother fax machine. With the other party, you should use the same four-digit ID number.

## *Polling Another Fax Machine with Secure Code*

---

You can poll another fax machine that has Secure Polling by following the steps below: You need to make sure you are using the same ID number as the other party.

### KEYS TO BE PRESSED

Make sure no documents in the feeder.

1. Press **POLLING**.
2. Press ← (left arrow) or → (right arrow) to find the **POLLING SECURE** setting.
3. Press **SET**.
4. Enter a four-digit code.  
Example: **1234**.
5. Enter the fax number.
6. Press **START**.

### STATUS OF LCD DISPLAY

09/12/1993 15:25

POLLING:STANDARD

SELECT < > & SET

POLLING:SECURE

POLLING ID:XXXX

POLLING ID:1234

ENTER FAX NO.

PRESS START KEY

NJ OFFICE

DIALING

RECEIVING P.01

## Setting up for Polled Waiting with Secure Polling

When someone polls for your documents, you can secure them by using the Secure Polling feature.

KEYS TO BE PRESSED	STATUS OF LCD DISPLAY
1. Place the documents into the feeder.	09/12/1993 15:25
2. Press <b>POLLING</b> .	FAX: NO. & START COPY: PRESS COPY
3. Press ← (left arrow) or → (right arrow) to find the <b>POLLING SECURE</b> setting.	POLLING: STANDARD SELECT < > & SET
4. Press <b>SET</b> .	POLLING: SECURE
5. Enter a four-digit code. Example: <b>1234</b> .	POLLING ID: XXXX
6. Press <b>START</b> and wait for the polling call to come in.	POLLING ID: 1234 PRESS START KEY POLLED WAITING

### ***Delayed Polling*** (Only for FAX-680)

After you select **STANDARD** or **SECURE**, press **SET**, then press **TIMER** and use the number keys to enter the time at which you want polling to take place.

## 10. PRINTING OUT REPORTS AND LISTS

You can print out the following lists and reports under function item 3. PRINT REPORTS.

Level one function	Level two function	Content	Page
3. PRINT REPORTS	1. ACT. REPORT	The Activity Report lets you know whether transmissions and incoming faxes were received.	10-3
	2. ALL DIAL	This is a list of the names and numbers which are stored in One-Touch and Speed-Dial memory. Printed in One-Touch and Speed-Dial number order.	10-2
	3. TEL. INDEX (only for FAX-680)	The same as the All Dial list but printed in alphabetical order.	_____
	4. COVERPAGE (3. for FAX-600)	This allows you to check the Cover Page format.	6-12
	5. CALL BACK MSG (4. for FAX 600)	Used to check the Call Back message format.	6-15
	6. USER OPTIONS (5. for FAX-600)	The settings for FUNCTION 3-7 (3-6 for FAX-600) and 5 to 7 (Cover Page, Tone/Pulse, Ring Delay, etc.) are printed here.	_____
	7. XMIT REPORT (6. for FAX-600)	You can set up whether the transmission verification report will be printed after all sending fax, or not. ON/OFF	10-4

### Other Reports

The following reports are printed out automatically, for your information.

Power Failure Report  
 Polled Report  
 Delayed Sending Report  
 Anti-Curl System (ACS) Check Sheet

- Helpful Hints**
- If you do not need ACS check sheet, press ← (left arrow) and → (right arrow) simultaneously.
  - If you press ← (left arrow) and → (right arrow) simultaneously again, ACS check sheet will be printed out automatically.

All of reports and lists can printout as below.

## KEYS TO BE PRESSED

1. Press **FUNCTION**.
2. Press **3**.
3. Press the number of the level two function you wish to print.  
Example: 1.ACT.REPORT.
4. Press **START**.

## STATUS OF LCD DISPLAY

09/12/1993 15:25

1.TEMP.SETTINGS

3.PRINT REPORTS

1.ACT.REPORT

PRESS START KEY

PRINTING

Ch.10

### *Printing the All Dial List*

You can print out a list of all One-Touch numbers and Speed-Dial numbers.

ALL DIAL LIST			
		TIME : 09/12/1993 15:25	
		NAME : BROTHER	
		FAX : 4155554444	
		TEL : 4155554445	
<b>ONE-TOUCH DIAL</b>			
NUMBER	FAX/TEL NUMBER		DESTINATION
*1	61-2018285881	FAX	AUSTRALIA OFFICE
*2	234-5678	TEL	ABC COMPANY
*3	334-5566	FAX	HEAD OFFICE
*4			
*5	4155551212	FAX	NJ OFFICE
<b>SPEED-DIAL</b>			
NUMBER	FAX/TEL NUMBER		DESTINATION
#01	5892786	F/T	PTWMJG M.
#02@	1234567		W. COMPANY
#03	03-256-1121	FAX	OSAKA OFFICE
#04			
#05	5555151	FAX	MANCHESTER
#06			
#07			
#08			
#09			
#10			
@:CHAIN			

## Activity Report Interval

An activity report can be printed at certain intervals that you specify. You have a choice of setting the journal interval period to "OFF", "6 hours", "12 hours", "24 hours", "2 days", "4 days", or "7 days". The activity report will provide a list of all outgoing and incoming faxes (up to 30) during the period. The initial setting is "OFF".

If you wish to print out the activity report manually, please take the same way as others. (See page 10-2.)

### KEYS TO BE PRESSED

1. Press **FUNCTION**.
2. Press **7**.
3. Press **3**.
4. Press **←** (left arrow) or **→** (right arrow) to choose the setting.  
Example: 12HOURS.  
If you select seven days, you should choose the base day of the week.
5. Press **SET**.
6. Enter the time to print out in 24-hour format using the number keys.  
Example: 19:45 (7:45p.m.)
7. Wait for two seconds.
8. Press **STOP** to exit.

### STATUS OF LCD DISPLAY

09/12/1993 15:25

1. TEMP. SETTINGS

7. SETUP SYSTEM

3. INTERVAL

ACT. RPT. : OFF

SELECT < > & SET

EVERY 12 HOURS

START AT: 00:00

START AT: 19:45

3. INTERVAL

### ACTIVITY REPORT

TIME : 09/12/1993 19:45  
NAME : BROTHER  
FAX : 415554444  
TEL : 415554445

DATE	TIME	FAX NO./NAME	DURATION	PAGE(S)	RESULT	COMMENT
09/12	10:00	BROTHER BOSTON	04:23	20 CV CA	OK	TX
09/12	10:10	NJ OFFICE	00	00	BUSY	TX
09/12	14:53	BROTHER BOSTON	48	01 CV CA	OK	TX

CV : COVERPAGE  
CA : CALL BACK MSG  
POL : POLLING

## ***Transmission Verification (Xmit) Report***

Set the Transmission Verification Report to ON or OFF. The initial setting is OFF.

OFF: Report will be printed if the transmission errors occur.

ON: Report will be printed every time a fax message sent completely or an error occurs.

### KEYS TO BE PRESSED

1. Press **FUNCTION**.
2. Press **3**.
3. Press **7** for FAX-680.  
(Press **6** for FAX-600.)
4. Press **←** (left arrow) or **→** (right arrow) to choose the setting.  
Example:ON
5. Press **SET**.
6. Press **STOP** to exit.

### STATUS OF LCD DISPLAY

09/12/1993 15:25

1.TEMP.SETTINGS

3.PRINT REPORTS

7.XMIT REPORT

XMIT REPORT:OFF

SELECT < > & SET

XMIT REPORT:ON

7.XMIT REPORT

### TRANSMISSION VERIFICATION REPORT

TIME : 09/12/1993 15:25  
 NAME : BROTHER  
 FAX : 4155554444  
 TEL : 4155554445

DATE, TIME	09/12 15:24
FAX NO./NAME	NJ OFFICE
DURATION	00:00:45
PAGE(S)	01
	COVERPAGE
RESULT	OK
MODE	STANDARD

## 11. REGULAR MAINTENANCE AND TROUBLESHOOTING

### *Regular Maintenance*

You can keep your fax machine in optimum condition by cleaning it on a regular basis. Avoid using thinners or other organic solvents to clean the machine and do not use any water.

Follow the five steps below:

1. Unplug the telephone line and then the power cord.  
When you reconnect these lines later, make sure to connect the power cord first, then the telephone line.
2. Remove the paper roll.
3. Wipe any dirt off the machine using a slightly damp cloth.
4. Clean the scanner.  
Moisten a small piece of soft, lint-free cloth with isopropyl alcohol and carefully remove any dirt from the glass cover and from the white tape of the scanner.

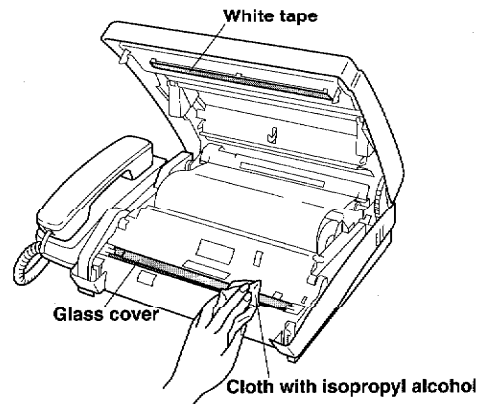

5. Clean the printer.  
Moisten a small piece of soft, lint-free cloth with isopropyl alcohol and keep wiping the edge of the print head until all dirt is removed.

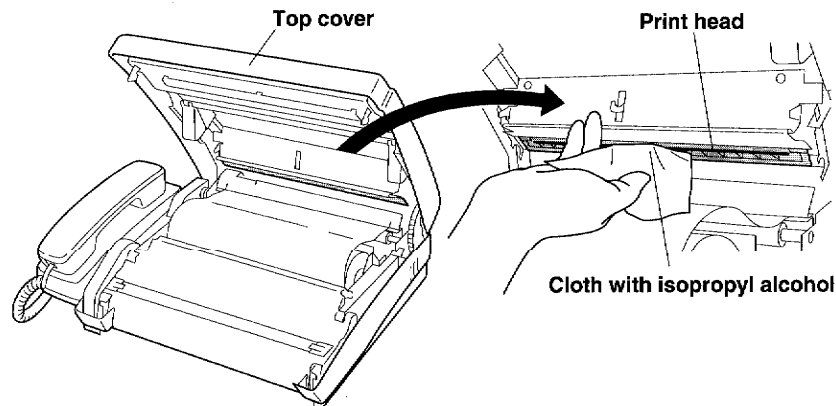

**Helpful Hints** It is a good idea to follow these five simple steps everytime you change the paper.



## ***Paper Jams***

---

Your fax machine will sound an alarm if the documents jam while going through the feeder or if the fax paper becomes stuck. The display will show "DOCUMENT JAM", "CUTTER JAM", or "PRINTER JAM".

### ***Fixing a Document Jam***

---

1. Open the top cover and remove the documents.
2. Close the top cover, and check to make sure the fax paper is in place.

### ***Fixing a Cutter Jam or Printer Jam***

---

1. Unplug the fax machine and open the top cover.
2. Use a pair of scissors to cut the paper where the wrinkles start.

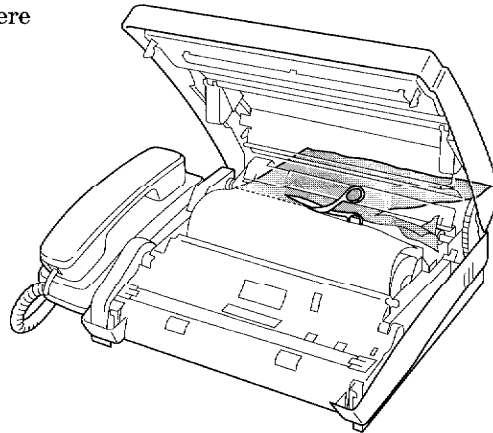

3. Pull the wrinkled paper out from front and rear sides.
4. Plug in the fax machine.

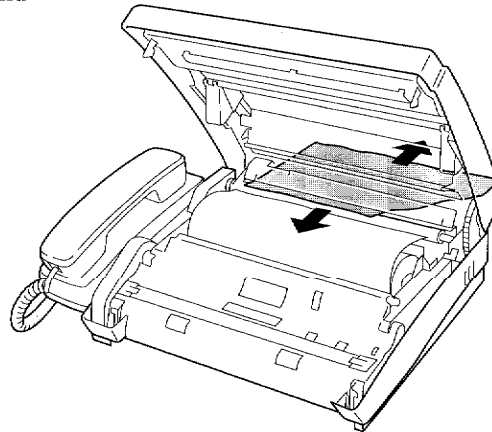

5. Re-insert the fax paper and close the top cover.

## ***Troubleshooting***

---

You may occasionally encounter a problem with your fax machine or telephone line. If this happens, your fax machine often identifies the problem and displays an error message. Refer to the following list when you see an error message on the display. If additional help is needed, please contact our 1-800-284-4FAX for service.

### ***Error Messages***

---

#### **COMM.ERROR XX YY and PRESS STOP KEY**

You encountered a communications error that resulted from a poor quality phone line. Try the call again.

#### **CONNECTION FAIL and PRESS STOP KEY**

You may request Polling function to other party even if remote station does not have polling function.

#### **COVER OPEN**

The top cover is not completely closed. Push it down until you hear a "click."

#### **CUTTER JAM**

The fax paper is jammed in the cutter. Remove the jammed paper. (See page 11-2.) Then re-insert the fax paper. (See page 1-2.)

#### **DISCONNECTED and PRESS STOP KEY**

The telephone line was disconnected by other party during the communication. Try calling the other party to see what happened.

#### **DOCUMENT JAM**

The documents were not inserted properly. Open the top cover and remove the documents. Close the cover and re-insert the documents and adjust the guides on either side of the document, and try sending the fax again.

#### **ID MISMATCH and PRESS STOP KEY**

You may have the wrong ID for secure polling function. Try calling the other party to meet the ID.

#### **MACHINE ERROR XX and PRESS STOP KEY**

Contact 1-800-284-4FAX for service center.

#### **NO RESPONSE/BUSY and PRESS STOP KEY**

The number you called does not answer or is busy. You may also have reached a number that is not connected to a fax. Check the number and try again.

#### **NOT REGISTERED**

The One-Touch key or Speed-Dial number has no number assigned to it. You need to register a phone number. (See page 4-4, 6.)

**PAPER ROLL EMPTY**

The paper roll is empty. You need to replace it. (See page 1-2.)

**PAPER SET ERROR**

The paper roll is not sitting correctly. Try re-inserting it.

**PRINTER FAULT**

The recording head has overheated. Then unplug the power cord and wait for 30 minutes.

**PRINTER JAM**

The fax paper is jammed in the printer. Remove the jammed paper. (See page 11-2.) Then re-insert the fax paper. (See page 1-2.)

**SCANNER ERROR**

The scanner is dirty. (See page 11-1.)

***Other Problems***

---

**When Dialing Doesn't Work...**

You may have the wrong dialing mode. Change the TONE/PULSE setting. (See page 4-1.) You may also want to check all the telephone line connections, such as to the handset and to the wall jack. Check also that the power cord is connected. Check by pressing **HOOK** to see if dial tone is heard. (See page 1-3.)

**Poor Copy Quality**

Someone may complain that faxes as they have received from you are faded. Your resolution setting may be inappropriate. Try the FINE or SUPERFINE settings and try to call again. Also, it is possible that your scanner is dirty. So, you should clean it. (See page 11-1.)

**Vertical Streaks**

You may get faxes with vertical streaks. The recording head on your machine may be dirty, or the sender's scanner may be dirty. Try cleaning the recording head. (See page 11-1.)

**Horizontal Streaks**

You may get a fax with horizontal streaks or with missing lines. This normally results from a poor telephone connection. Ask the other party to send the fax again.

## 12. IMPORTANT INFORMATION

### Standard Telephone and FCC Notices (Only applies to 120V model)

These notices are in effect on models sold and used in U.S.A.

**This equipment is hearing-aid compatible.**

**When programming emergency numbers and/or making test calls to emergency numbers:**

- Remain on the line and briefly explain to the dispatcher the reason for the call before hanging up.
- Perform such activities in the off-peak hours, such as early morning or late evening.

This equipment complies with Part 68 of FCC Rules. On the rear panel of this equipment is a label that contains, among other information, the FCC Registration Number and Ringer equivalence Number (REN) for this equipment. You must, upon request, provide this information to your telephone company.

You may safely connect this equipment to the telephone network by means of standard modular jack, USOC RJ11C.

The REN is useful to determine the quantity of devices you may connect to your telephone line and still have those devices ring when your telephone number is called. In most, but not all areas, the sum of the RENs of all devices connected to one line should not exceed five(5). To be certain of the number of devices you may connect to your line, as determined by the REN, you should contact your local telephone company to determine the maximum REN for your calling area.

If your IntelliFAX600/680 causes harm to the telephone network, the telephone company may discontinue your service temporarily. If possible, they will notify you in advance. But in advanced notice is not practical, you will be notified as soon as possible. You will be informed of your right to file a complaint with the FCC.

Your telephone company may make changes in its facilities, equipment, operations or procedures that could affect the proper functioning of your equipment. If they do, you will be notified in advance to give you an opportunity to maintain uninterrupted telephone service.

If you experience trouble with this IntelliFAX600/680, please contact the manufacture's authorized service agency for information on obtaining service or repair. The telephone company may ask that you disconnect this equipment from the network until the problem has been corrected or until you are sure that the equipment is not malfunctioning.

If you are not able to solve a problem with your fax machine, contact Brother service personnel at 1-800-284-4FAX(U.S.A. Only).

### **Warning**

For protection against the risk of electrical shock, always disconnect all cables from the wall outlet before servicing, modifying or installing the equipment.

This equipment may not be used on coin service provided by the telephone company nor connected to party lines.

This equipment has been tested and found to comply with the limits for a Class B digital device, pursuant to Part 15 of the FCC Rules. These limits are designed to provide reasonable protection against harmful interference in a residential installation. This equipment generates, uses, and can radiate radio frequency energy and, if not installed and used in accordance with the instructions, may cause harmful interference to radio communications. However, there is no guarantee that interference will not occur in a particular installation. If this equipment does cause harmful interference to radio or television reception, which can be determined by turning the equipment off and on, the user is encouraged to try to correct the interference by one or more of the following measures:

- Re-orient or relocate the receiving antenna.
- Increase the separation between the equipment and receiver.
- Connect the equipment into an outlet on a circuit different from that to which the receiver is connected.
- Consult the dealer or an experienced radio/TV technician for help.

**Brother cannot accept any financial or other responsibilities that may be the result of your use of this information, including direct, special or consequential damages. There are no warranties extended or granted by this document.**

This serial number may be found on the label affixed to the back of the unit. For your convenience, note the number below and retain this owner's manual to serve as a permanent record of your purchase, in the event of a theft or fire, or for future reference.

MODEL NO. IntelliFAX600/680 SERIAL NO. \_\_\_\_\_  
 NAME OF DEALER \_\_\_\_\_  
 DATE OF PURCHASE \_\_\_\_\_

## ***Important Safety Instructions***

---

1. Read all of these instructions
2. Save them for later reference.
3. Follow all warnings and instructions marked on the product.
4. Unplug this product from the wall outlet before cleaning. Do not use liquid or aerosol cleaners. Use a damp cloth for cleaning.
5. Do not use this product near water.
6. Do not place this product on an unsuitable cart, stand, or table. The product may fall, causing serious damage to the product.
7. Slots and openings in the cabinet and the back or bottom are provided of ventilation; to ensure reliable operation of the product and to protect it from overheating, these openings must not be blocked or covered. The openings should never be blocked by placing the product on a bed, sofa, rug, or other similar surface. This product should never be placed near or over a radiator or heat register. This product should not be placed in a built-in installation unless proper ventilation is provided.
8. This products should be operated from the type of power source indicated on the marking label. If you are not sure of the type of power available, consult your dealer or local power company.
9. This product is equipped with a 3-wire grounding type plug, a plug having a third (grounding) pin. This plug will only fit into a grounding-type power outlet. This is a safety feature. If you are unable to insert the plug into the outlet, contact your electrician to replace your obsolete outlet. Do not defeat the purpose of the grounding-type plug.
10. Do not allow anything to rest on the power cord. Do not locate this product where persons will walk on the cord.
11. If an extension cord is use with this product, make sure that the total of the ampere ratings on the products plugged into the extension cord do not exceed the extension cord ampere rating. Also, make sure that the total of all products plugged into the wall outlet does not exceed 15 amperes (U.S.A. only).
12. Never push objects of any kind into this product through cabinet slots as they may touch dangerous voltage points or short out parts that could result in a risk of fire or electric shock. Never spill liquid of any kind on the product.
13. Do not attempt to service this product yourself, as opening or removing covers may expose you to dangerous voltage points or other risks. Refers all servicing to service personal at 1-800-284-4FAX.
14. Unplug this product from the wall outlet and refer servicing to qualified service personnel under the following conditions:
  - A. When the power cord or plug is damaged or frayed.
  - B. If liquid has been spilled into the product.
  - C. If the product has been exposed to rain or water.
  - D. If the product does not operate normally when the operating instructions are followed. Adjust only those controls that are covered by the operating instructions since improper adjustment of other controls may result in damage and will often require extensive work by a qualified technician to restore the product to normal operation.
  - E. If the product has been dropped or the cabinet has been damaged.
  - F. If the product exhibits a distinct change in performance, indicating a need for service.

## 13. INDEX

## A

Activity Report .....	10-1, 10-3
ADF .....	6-2
All Dial List .....	10-1, 10-2
Answer Mode .....	2-5, 7-1
Auto Mode .....	7-1, 7-2

## B

Beeper .....	4-1
--------------	-----

## C

Call Back Message .....	6-15, 10-1
Call Reservation .....	2-4, 6-15
Canceling .....	6-8
Chain Dialling .....	4-5
Cleaning .....	11-1
Connecting .....	1-3, 7-4, 7-6
Contrast .....	6-3
Control Panel Keys .....	2-1~2-5
Copy .....	2-3, 8-1
Cover Page .....	2-5, 6-12, 6-13, 6-14, 10-1

## D

Daily Timer .....	6-6
Date and Time .....	4-2
Delayed Transmission .....	6-6
Document .....	6-1, 6-2

## E

Error Message .....	11-3
External Telephone .....	7-4, 7-6
Extention Telephone .....	7-4

## F

Fine .....	6-2
F/T Mode .....	7-1, 7-3
F/T Ring Time .....	7-3
Function .....	2-4, 3-1~3-6, 10-1~10-4

**G**

Gray Scale .....6-11

**H**

Hook .....2-2, 5-1

Hold .....2-2, 5-1

**I**

Interrupting .....2-4, 6-7

**J**

Jacks .....1-4, 7-4, 7-6

Jam .....11-2

**L**

Loading Paper .....1-2

**M**

Manual Mode .....7-1, 7-2

Manual Dial .....5-1, 6-4

Memory .....4-7

Multiple Resolution Transmission .....6-10

**O**

One-touch Dial .....2-3, 4-4, 4-5, 4-7, 5-1, 6-4

On Hook Dial .....5-1

Overseas Mode .....6-9

**P**

Packing List .....1-2

Pause .....2-2, 5-1

PBXs .....1-4, 4-7

Photo .....6-2, 6-11

Polling .....2-4, 9-1~9-4

Power .....1-3, 14-1



## R

Redial .....	2-2, 6-5
Remote Activation .....	7-4, 7-5, 7-6
Remote Code .....	7-4, 7-5, 7-6
Remote Deactivation .....	7-4, 7-5
Reports .....	10-1~10-4
Resolution .....	2-5, 6-2, 6-10, 6-11
Ring Delay .....	7-2
Ring Volume .....	7-9

## S

Secure Polling .....	9-3, 9-4
Setting Up .....	1-2
SHIFT .....	2-4, 4-4
Smoothing .....	7-8
Speaker Volume .....	7-8
Speed Dial .....	2-2, 4-6, 4-7, 5-1, 6-4
Station ID .....	4-3, 6-5, 6-12, 6-15
Standard Mode .....	6-2
Super Dark .....	6-3
Superfine Mode .....	6-2
Super Light .....	6-3

## T

TAD Mode .....	7-1, 7-6, 7-7
Telephone Index .....	2-4, 5-2, 6-4, 10-1
TIMER .....	2-4, 6-6, 9-4
Transmission Verification Report .....	10-1, 10-4
Tone/Pulse .....	4-1

**14. SPECIFICATIONS**

<b>Type</b>	Desktop facsimile transceiver
<b>Compatibility</b>	CCITT Group 3
<b>Codings system</b>	Modified Huffman (MH)
<b>Modem speed</b>	9600/7200/4800/2400; Automatic Fallback
<b>Document input width</b>	148mm to 216mm (5.8 inches to 8.5 inches)
<b>Scanning/Printing width</b>	208mm (8.2 inches)
<b>Paper roll size</b>	216mm (8.5 inches) 50m (164 feet) for FAX-680 30m (98 feet) for FAX-600 (30m (98 feet) with therma plus)
<b>Printer type</b>	Line thermal
<b>Gray scale</b>	32/16 level for FAX-680, 16 level for FAX-600
<b>Paper cutter</b>	Automatic
<b>Display</b>	LCD, 16 characters
<b>Polling types</b>	Standard, Secure, Delay for FAX-680, Standard, Secure for FAX-600
<b>Contrast control</b>	Automatic/Super Light/Super Dark (manual setting)
<b>Resolution</b>	<ul style="list-style-type: none"> <li>• Horizontal 8 pels/mm (203 pels/inch)</li> <li>• Vertical Standard 3.85 lines/mm (98 lines/inch)</li> <li>• Fine/Photo (16 level) 7.7 lines/mm (196 lines/inch)</li> <li>• Superfine/Photo (32 level) (only for FAX-680) 15.4 lines/mm (392 lines/inch)</li> </ul>
<b>One-touch dial</b>	20 stations for FAX-680, 5 stations for FAX-600
<b>Speed-dial</b>	40 stations for FAX-680, 10 stations for FAX-600
<b>Automatic redial</b>	3 times at 5 minute intervals
<b>Speaker type</b>	Monitor
<b>Auto answer</b>	0, 1, 2, 3 or 4 rings
<b>Communication source</b>	Public switched telephone network
<b>Operating environment</b>	41 - 95°F
<b>Power source</b>	120V AC 50/60Hz (U.S.A., Canadian Version Only)
<b>Power consumption</b>	Standby: under 15 watts Peak: under 150 watts
<b>Dimensions</b>	378 x 303 x 125 (mm)/14.9 x 11.9 x 4.9 (inches) for FAX-680 378 x 303 x 113 (mm)/14.9 x 11.9 x 4.4 (inches) for FAX-600
<b>Weight</b>	5.0 kg/11.0 lbs

Specifications are subject to change for improvement without prior notice.



**brother**<sup>®</sup>

UF3404001①  
Printed in Japan

## Free Manuals Download Website

<http://myh66.com>

<http://usermanuals.us>

<http://www.somanuals.com>

<http://www.4manuals.cc>

<http://www.manual-lib.com>

<http://www.404manual.com>

<http://www.luxmanual.com>

<http://aubethermostatmanual.com>

Golf course search by state

<http://golfingnear.com>

Email search by domain

<http://emailbydomain.com>

Auto manuals search

<http://auto.somanuals.com>

TV manuals search

<http://tv.somanuals.com>