

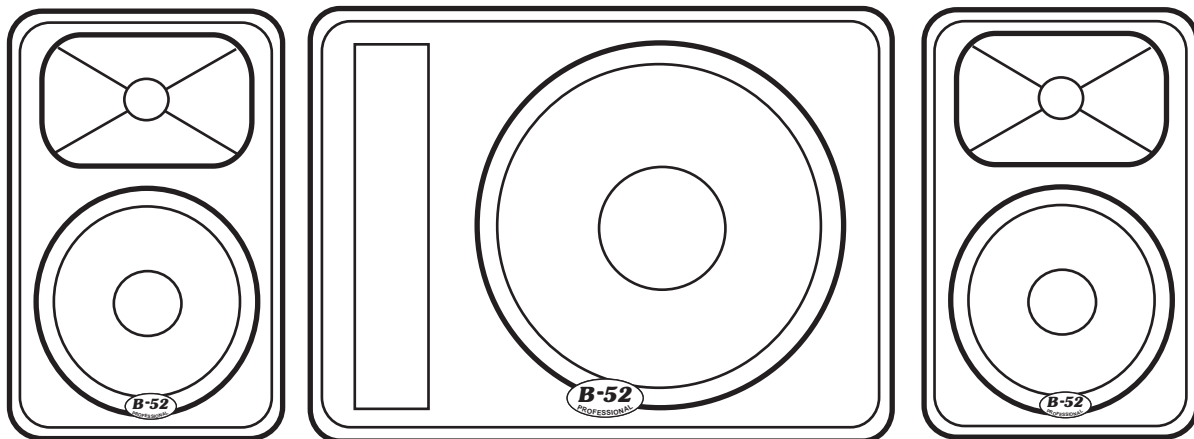

MATRIX 1000

700-watt Active Speaker System



MATRIX 1000 SUGGESTED APPLICATIONS:

- Mobile DJ ■ Karaoke ■ Nightclub, Restaurant, Bar Install
- Corporate Audio / Video ■ Home Entertainment System
- Live Sound System ■ Stage Monitoring System
- Booth Monitoring System ■ Drum Monitoring

INSIDE THIS INSTRUCTION MANUAL

Important Safety Instructions / Specifications	2
Important Information.....	3
Amplifier Descriptions.....	4
Set-up & Warranty Information.....	5-7
Contact Information.....	8

IMPORTANT SAFETY INFORMATION

- 1) Read these instructions.
- 2) Follow all instructions
- 3) Keep these instructions
- 4) Heed all warnings
- 5) Do not use the MATRIX 1000 near water. Be extra cautious when moving the system during rain or while transporting the system over wet surfaces as water might splash onto the amplifier.
- 6) Clean only with dry cloth.
- 7) Do not block any ventilation openings. Install in accordance with manufacturer's instructions.
- 8) Do not install near heat sources such as radiators, stoves or other devices that may produce heat.
- 9) Do not defeat the safety purpose of the polarization or grounding-type plug. A polarized plug has two blades with one wider than the other. A grounding-type plug has two blades and a third grounding prong. The wide blade or the third prong is provided for your safety. If the provided plug does not fit your outlet, consult an electrician for replacement of the obsolete outlet.
- 10) Protect the power cord from being walked on or pinched, particularly at the plug and the point where it exits the MATRIX 1000 amplifier.
- 11) Only use attachments / accessories specified by B-52 Pro-Audio.
- 12) Use caution when transporting the system to avoid injury from tip-over.
- 13) Unplug the MATRIX 1000 during lightning storms and when not in use.
- 14) Refer all servicing to qualified to personnel. Servicing is required when the MATRIX 1000 has been damaged in any way such as when power-cord or plug is damaged, liquid has been spilled into the cabinets, the unit has been exposed to moisture or rain, does not operate normally, or has been dropped.
- 15) To reduce the risk of fire or electric shock, do not expose the MATRIX 1000 to rain or moisture.
- 16) The MATRIX 1000 is not intended for outdoor fixed installations or in high moisture areas. Moisture can damage the speakers and can use cause corrosion of electrical contacts. Keep speakers out of extended or intense direct sunlight. The subwoofer spider and surround will prematurely dry out and finished surfaces may fade and be damaged by long-term exposure to intense ultra-violet light.

HEED ALL WARNINGS



WARNING: To reduce the risk of fire or electrical shock do not expose this equipment to rain or moisture.

AMPLIFIER SPECIFICATIONS:

Subwoofer Power Output:	400 W / 8 Ohms @ 1% THD
10" Two-way Power Output:	150 W / 4 Ohms @ 1% THD
Line in:	XLR Female
Parallel out:	XLR Male
Input Impedance:	48 k Ohms
Speaker Out:	Speakon NL4 Style Connector

ACTIVE CROSSOVER:

Crossover Frequency:	120 Hz; 24 dB/ Octave
----------------------	-----------------------

SUBWOOFER:

Speaker:	1 x 15" Custom Built B-52 Subwoofer
Nominal Impedance:	8 Ohms
Subwoofer Freq. Response:	40 Hz – 120 Hz +/- 3dB
Sound Pressure Level (1w/1m):	102 dB (half space)
Max. SPL:	127 dB @10% THD
Weight:	115 lbs
Dimensions (Transport):	28" (H) x 19" (W) x 23" (D)

10" TWO-WAY SPEAKERS:

Speaker Input:	Speakon style connector (pin 1+ = +, pin 1- = -)
LF/MF Woofer:	1 x 10" Custom Built B-52 Transducer
HF Driver:	1 x 3/4" Titanium Diaphragm on CD Horn
HF Dispersion:	90° x 40°
Nominal Impedance:	4 Ohms
Active Freq. Response:	120 – 19K Hz +/- 3dB
Crossover Frequency (passive):	2.5 kHz; 12 dB / Octave
Sound Pressure Level (1w/1m):	101 dB (half space)
Max. SPL:	124 dB @10% THD
Weight:	25 lbs
Dimensions (Upright):	19" (H) x 12" (W) x 11" (D)

COMPLETE SYSTEM:

Weight:	165 lbs
Dimensions (Transport):	39" (H) x 19" (W) x 23" (D)

Note: Specifications are subject to change without notice

The Matrix 1000 Active Speaker System

Congratulations on your purchase of this B-52 Professional Matrix 1000.

The MATRIX 1000 system is a complete sound reinforcement solution consisting of two 10" two-way speakers and an active 15" subwoofer. The subwoofer enclosure is equipped with a three channel amplifier and all the electronics required to run the system. The electronic circuitry was fine tuned to match the two-way speakers for the best possible sound. This system was designed for easy operation since you do not need to worry about tweaking frequencies and finessing levels. All you have to do is set up the system components, connect the XLR right and left signal cables, speaker cables and power cords and you're ready to go.

SUBWOOFER:

The 15" subwoofer enclosure is divided into two separate compartments. The front chamber serves as the cabinet for the 15" subwoofer. The rear chamber houses all of the system's electronic circuitry, which includes the amplification for all three components, power supply and preamps. The 15" subwoofer has a power handling capability of 400 watts and a nominal impedance of 8 ohms.

10" TWO-WAY SPEAKERS:

The two 10" two-way speakers are loaded with B-52's custom 10" speakers and a 3/4" titanium diaphragm compression driver, mounted to a 90° x 40° constant directivity horn. The speakers are designed to be pole mounted, can sit as stage monitors and have built-in (3/8" – 16 TPI) flying hardware for permanent installations. The front panel of both two-way speakers is concaved so as to fit perfectly onto the subwoofers front grille for easy transport. Each two-way speaker has the power handling capability of 150 watts and a nominal impedance of 4 ohms.

10" TWO-WAY SPEAKER INPUT:

To establish a connection, plug the connector and then rotate it until it engages. Before you unplug it, you will first need to disengage the safety catch. To accomplish this, pull the bayonet catch towards the cable. (Pin 1+ = +, Pin 1- = -).

Caution: The system's components are matched for the best possible sound quality and may only be operated in the specified configuration provided in this manual. Use of other two-way speakers may hinder the sound quality and can damage the power amplifier.

TRANSPORTING THE SYSTEM:

To transport the system, simply set the subwoofer on its casters and place the two 10" two-way speakers onto the subwoofer's front panel facing down. Secure them with the included locking strap by fastening it to the bar handles on the side on the subwoofer cabinet. Place the included cover over the entire system and you are ready to move the system with ease.

Hearing damage, prolonged exposure to excessive SPL

B-52 Pro-Audio speakers, including the MATRIX 1000, are capable of producing sound pressure levels (SPL) sufficient to cause permanent hearing damage to performers, production crews or people in the audience. Hearing protection devices such ear-plugs are recommended. Caution should be taken to avoid extended SPL is excess of 90 dBA.

Amplifier Module Precautions

Do not attempt to service the MATRIX 1000 by yourself. Refer all servicing to a B-52 Pro-Audio Authorized dealer. Service is required when the MATRIX 1000 has had liquid spilled on or inside the subwoofer or speakers, has been damaged in any way, the speaker has been exposed to rain or moisture, does not operate normally or has been dropped.

WARNING – Shock Hazard:

To reduce the risk of fire or electrical shock, do not expose this unit to rain or moisture. Do not operate your MATRIX 1000 near a pool or other standing water. Make sure all blades on the polarized power plug are fully inserted into the power source. Ensure the power cord is not stretched, pinched or otherwise abused. Ensure the power cord is routed to avoid foot traffic. Your MATRIX 1000 amplifier should be cleaned only with a dry cloth.

Caution:

- 1) Do not hang the speakers by yourself. You must have a professional and licensed contractor hang the speakers. Speakers not properly flown/hung can fall causing injury or extreme cases, death.
- 2) B-52 Pro-Audio speakers, especially the MATRIX 1000, can produce high-levels of energy. When placed on slippery surfaces such as polished wood or smooth tiles, the subwoofer may move because of its intense bass output. Precautions should be taken to ensure the subwoofer does not fall off a stage or raised surface.
- 3) Turn the gain knobs all the way down when turning the system on or off.
- 4) Make sure the active subwoofer is connected to the two-way speakers before powering the system up.
- 5) Make sure your mixer and all other signal sources are turned on before connecting the MATRIX 1000.
- 6) The MATRIX 1000 should always be switched on last, after you switch on all connected devices.

DESCRIPTIONS

1. **AMPLIFIER:** The Matrix 1000 subwoofer amplifier panel.
2. **LEFT SPEAKER OUTPUT:** Speakon connector output for left monitor.
3. **COOLING FANS:** Rear cooling fans for built-in subwoofer amplifier. Ensure these cooling fans are clear of external obstructions for efficient operation.
4. **WARNING INFORMATION.** Please read and adhere to these instructions to ensure safe operation.
5. **POWER CORD CONNECTOR:** For attachment of the included power cord.
6. **FUSE HOLDER:** Contains primary 6A fuse.
7. **POWER ON/OFF SWITCH:** Turns the Matrix 1000 on and off.
8. **RIGHT SPEAKER OUTPUT:** Speakon connector output for right monitor.
9. **PHASE SWITCH:** Sets the polarity of the Matrix 1000.
10. **SUBWOOFER GAIN CONTROL:** Controls the levels of Gain to the subwoofer.
11. **GROUND/LIFT SWITCH:** Remove ground from circuit to eliminate excessive 60-cycle hum.
12. **RIGHT MONITOR GAIN CONTROL:** Controls the levels of Gain to the right side full range speaker.
13. **XLR BALANCED RIGHT FULL-RANGE OUTPUT:** Sends parallel full range signal out to other systems or components.
14. **XLR BALANCED RIGHT FULL-RANGE INPUT:** Connects the right side full range speaker to your mixing console.
15. **LEFT MONITOR GAIN CONTROL:** Controls the levels of Gain to the left side full range speaker.
16. **XLR BALANCED LEFT FULL-RANGE OUTPUT:** Sends parallel full range signal out to other systems or components.
17. **XLR BALANCED LEFT FULL-RANGE INPUT:** Connects the left side full range speaker to your mixing console.
18. **LEFT CHANNEL CONTROLS**
19. **RIGHT CHANNEL CONTROLS**

1

17

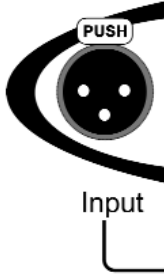

2

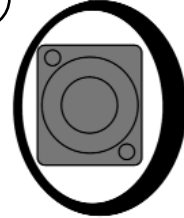

LEFT MONITOR

NOTE: Use Pin #:
1+ and 1-

150 W 4Ω

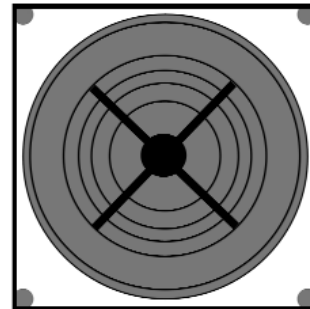

3



WARNING: To reduce the risk of fire or electrical shock, do not expose this equipment to rain or moisture. Please read instruction manual prior to operation - heed all warnings.

CE

GETTING TO KNOW YOUR MATRIX 1000 SUBWOOFER AMPLIFIER

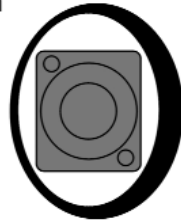
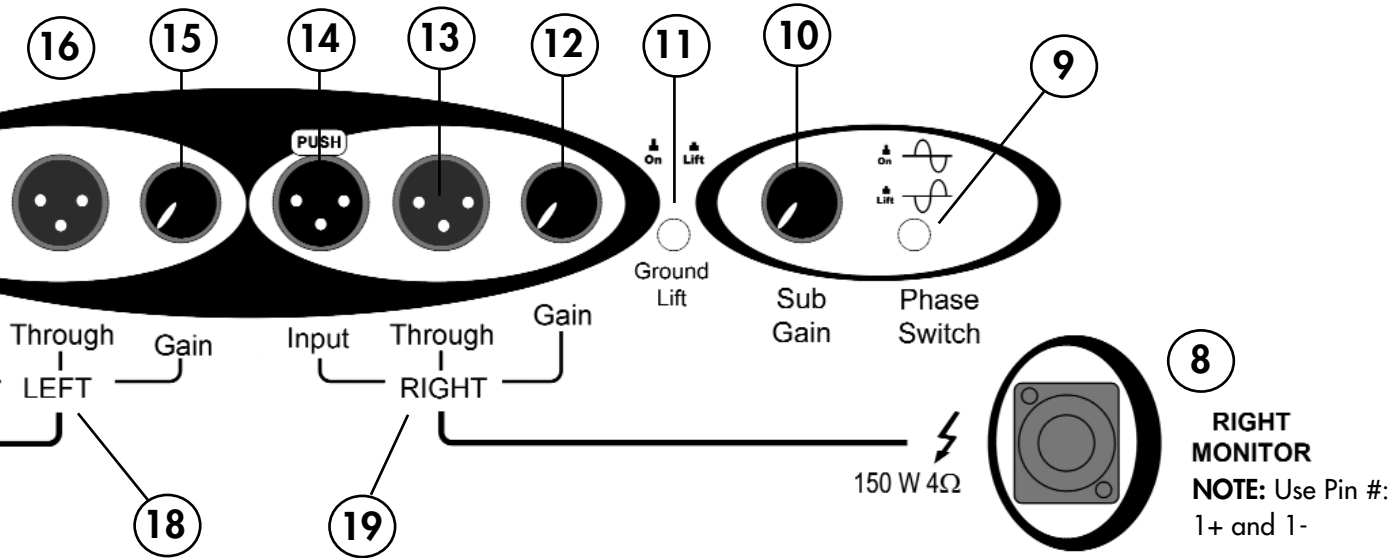

RIGHT MONITOR
NOTE: Use Pin #: 1+ and 1-

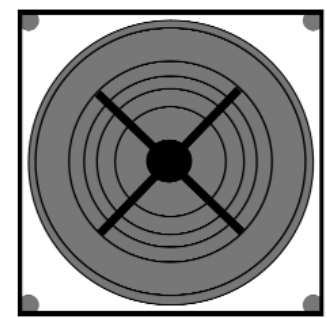

MATRIX 1000

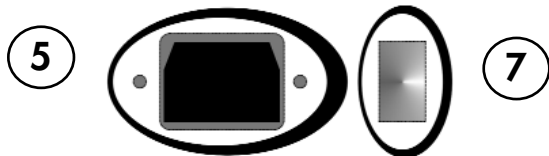

120 V AC 60 Hz

POWER

Fuse: F6A



B-52 PROFESSIONAL
700-WATT THREE-PIECE
ACTIVE SPEAKER SYSTEM

Setting Up Your Matrix 1000 Speaker System

The MATRIX 1000 consists of one subwoofer and two 10" two-way speakers. Connect the right and left signals from your mixer (master left/right, line out) to the balanced input sockets of the MATRIX 1000 using standard XLR cables.

MONO SET-UP

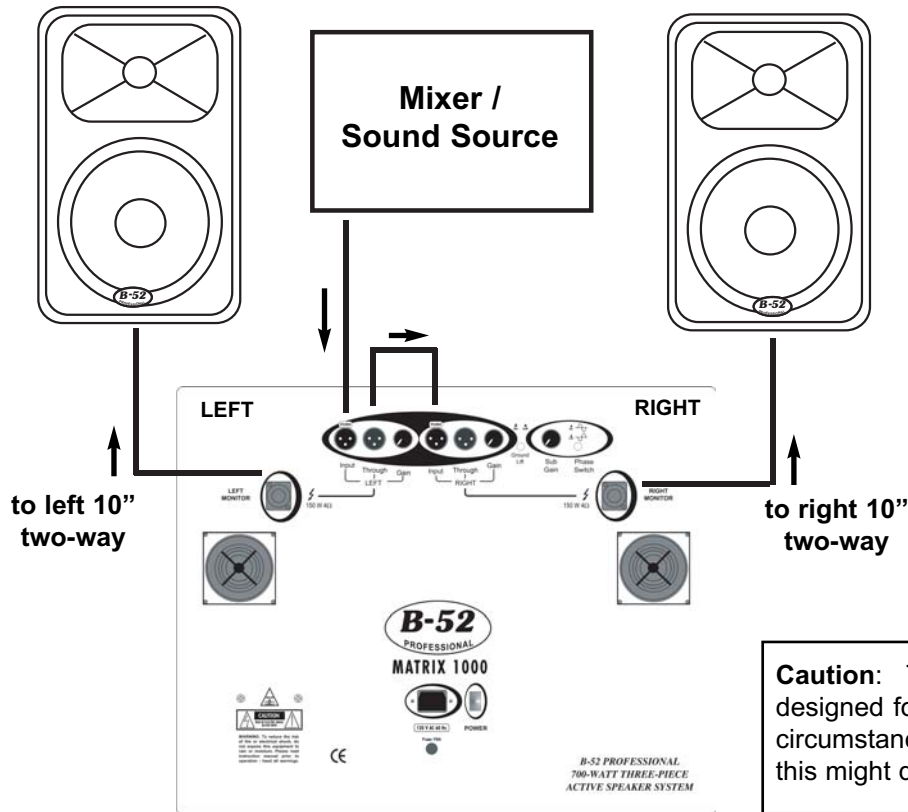

SETTINGS

Left & Right Gain Controls: After turning on your MATRIX 1000 using the on/off switch located on the rear amplifier plate of the active subwoofer, set the LEFT and RIGHT Gain controls to the center position (or facing straight up). This is the ideal position to operate the MATRIX 1000 if you have connected a mixer to the system. Alternatively, if you have connected a CD Player or other sound source, it is recommended that the Gain controls are turned all the way clockwise to achieve peak volume.

During performance, if your MATRIX 1000 shows signs of distortion, check the sound source and, if applicable, reduce the sound levels. If it is not possible to reduce the sound levels at the source, simply turn down the gain levels on the rear amplifier panel of the MATRIX 1000.

Caution: The Left and Right 10" two-way outputs are designed for a nominal impedance of 4 ohms. Under no circumstance may the impedance dip below the value as this might damage the MATRIX 1000 amplifier.

SETTINGS

Subwoofer Level Control: It is recommended to set the Subwoofer Gain control to halfway. At this position – and with the 10" Two-way speakers set in a similar position – the MATRIX 1000 should be perfectly balanced. If you wish to add bass, simply turn up the Subwoofer Gain control.

Ground Lift Switch: At times you may experience a low-frequency hum. At this time, engage the ground lift switch to eliminate this hum. If this does not eliminate the hum, please check cabling and sound sources.

STEREO SET-UP

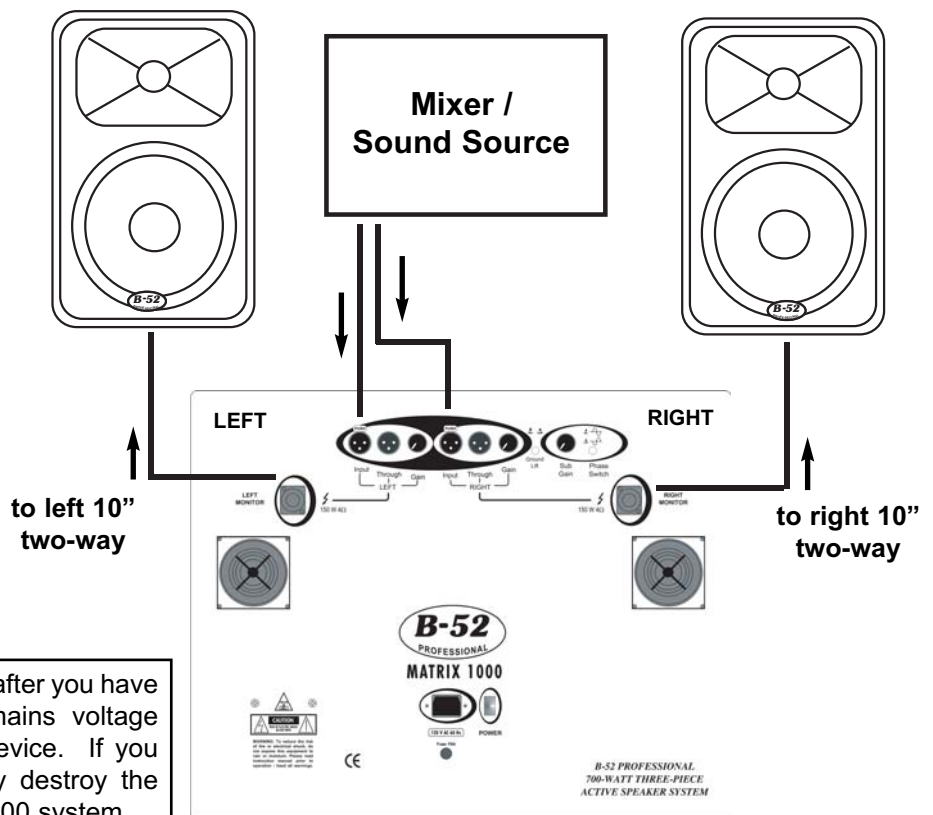

Caution: Connect the power cable only after you have absolutely made sure that the local mains voltage matches the voltage specified on the device. If you connect to the wrong voltage, you may destroy the electronic components of the MATRIX 1000 system.

DUAL SET-UP

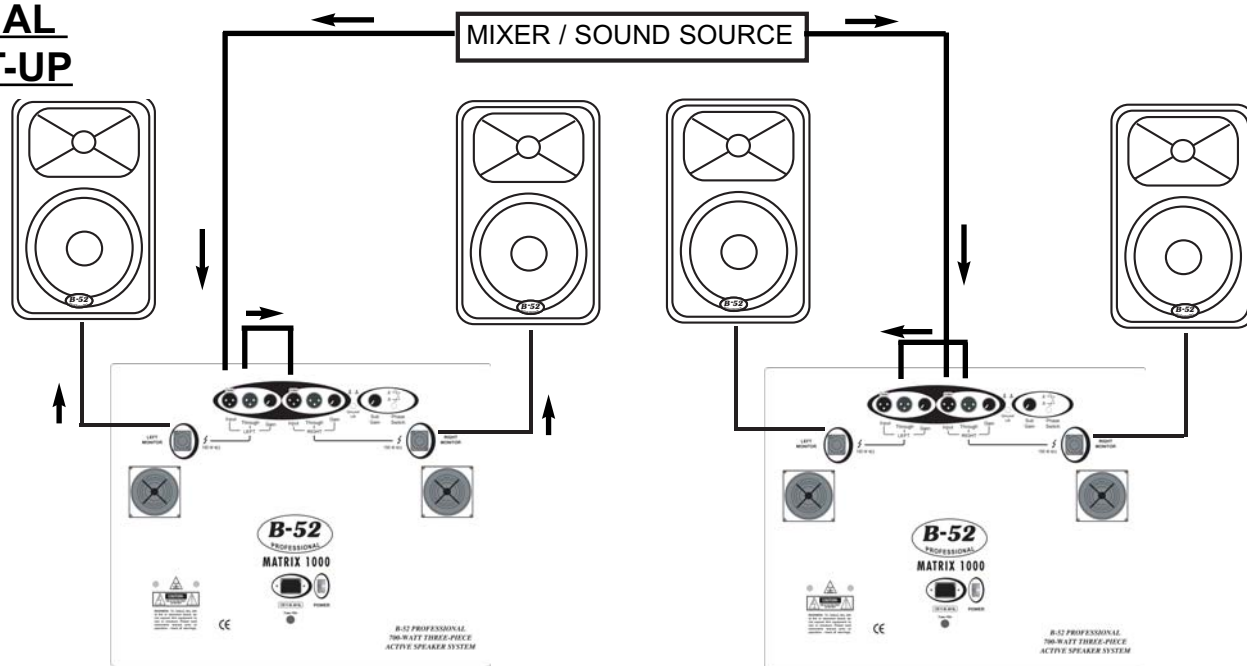

Using a dual MATRIX 1000 system will cover a wider area and can be used for a larger audience.

Connect the LEFT output from your mixer to the system's INPUT LEFT. Take a short XLR cable and connect one end of it from the THROUGH LEFT output to the INPUT

RIGHT. This will feed both satellites the same LEFT signal.

Connect the RIGHT output from your mixer to the system's INPUT RIGHT. Take a short XLR cable and connect one end of it from the THROUGH RIGHT output to the INPUT LEFT. This will feed both satellites the same RIGHT signal.

B-52

Limited Warranty

Thank you for choosing a B-52 sound product. B-52 manufactures some of the world's best sound-g and most reliable professional speaker systems, amplifiers and components. E.T.I. Sound Systems, Inc., makers of B-52, takes great pride in thoroughly testing each B-52 product prior to shipment.

-52 CABINETS: E.T.I. Sound Systems, Inc. offers a **LIFETIME** warranty (effective January 1, 2002) to the original purchaser that a B-52's cabinet construction will be free from defects in material and workmanship. A dated sales receipt will establish coverage under this warranty. This warranty does not cover service or parts to repair damage caused by neglect, abuse, normal wear and tear and cosmetic appearance of the cabinetry not directly attributed to defects in material or workmanship, or service, repair, modifications of the cabinet, which has not been authorized or approved by E.T.I. If this product is defective in materials or workmanship as warranted above, our sole remedy shall be repair or replacement as provided above.

LOUDSPEAKER AND MID-RANGE COMPONENTS: E.T.I. Sound Systems, Inc. warrants the original purchaser that B-52 loudspeakers and/or midrange components will be free from defects in material and workmanship for a period of (5) FIVE YEARS from the original purchase date (effective January 1, 2002). A dated sales receipt will establish coverage under this warranty. This warranty will automatically terminate (5) years after the original retail sales date. This (5) five-year warranty does not cover service or parts to repair damage caused by accident, disaster, misuse, abuse, burnt voice-coils, over-powering, negligence, inadequate packing or shipping procedures and service, repair or modifications of the component which has not been authorized or approved by E.T.I. This warranty is in lieu of all other expressed warranties. If this product is defective in materials or workmanship as warranted above, your sole remedy shall be repair or replacement as provided above.

HIGH-FREQUENCY DEVICES: E.T.I. Sound Systems, Inc. offers a **LIFETIME** warranty (effective January 1, 2002) to the original purchaser that B-52 high frequency (tweeters) devices will be free from defects in material and workmanship. A dated sales receipt will establish coverage under this warranty. This warranty does not warrant neglect or abuse. **NO WARRANTY IS OFFERED ON HIGH-FREQUENCY DEVICES IN B-52 SYSTEMS WITH A BI-AMP SWITCH OPTION.** The lifetime warranty on high-frequency devices does not cover service or parts to repair damage caused by accident, disaster, misuse, abuse, negligence, inadequate packing or shipping procedures or service, repair or modifications of the product which has not been authorized or approved by E.T.I. This warranty is in lieu of all other expressed warranties. If this product is defective in materials or workmanship as warranted above, your sole remedy shall be repair or replacement as provided above.

AMPLIFIERS: E.T.I. Sound Systems, Inc. warrants the original purchaser that B-52 amplifiers will be free from defects in material and workmanship for a period of (2) TWO YEARS from the original purchase date (effective January 1, 2002). A dated sales receipt will establish coverage under this warranty. This warranty will automatically terminate (2) years after the original retail sales date. This (2) two-year warranty does not cover service or parts to repair damage caused by accident, disaster, misuse, abuse, over-powering, negligence, inadequate packing or shipping procedures and service, repair or modifications of the amplifier which has not been authorized or

This **Limited Warranty** is effective as of **January 1, 2002**. Any warranty claim on B-52 products purchased before this date may be subject to monetary charges. Warranty valid **ONLY** to original purchaser with **PROOF OF PURCHASE**.

approved by E.T.I.. This warranty is in lieu of all other expressed warranties. If this product is defective in materials or workmanship as warranted above, your sole remedy shall be repair or replacement as provided above.

RETURN PROCEDURES: In the unlikely event that a defect should occur, follow the procedure outlined below. Defective products must be shipped, together with **proof of purchase**, freight pre-paid and insured to the Authorized B-52 Dealer from whom you purchased the product or directly to E.T.I. Sound Systems. If a product must be returned to E.T.I. Sound Systems for warranty replacement/repair, a **Return Authorization Number** must be obtained from our Customer Service Department prior to shipping the product.

NEVER RETURN THE ENTIRE CABINET—JUST THE DEFECTIVE COMPONENT. Identify and remove the defective component. If you are uncertain which component is defective, or need directions for removing a component, please contact our Customer Service Department for assistance. Components which are a part of an original B-52 speaker box must be sent directly to E.T.I. Products must be shipped in the original packaging or its equivalent; in any case, the risk of loss or damage in transit is to be borne by the purchaser. The Return Authorization Number must appear in large print directly below the shipping address. Always include a brief description of the defect, along with your correct return address and telephone number. When calling to inquire about a returned product, always refer to the Return Authorization Number. If E.T.I. determines that the unit was defective in materials or workmanship at any time during the warranty period, E.T.I. has the option of repairing or replacing the product at no additional charge, except as set forth below. All replaced parts become a property of E.T.I. Products replaced or repaired under this warranty will be returned via ground-shipping-within the United States-freight prepaid. **E.T.I. is not responsible for costs associated with expedited shipping, either to E.T.I. or the return of the product to the customer.**

INCIDENTAL OR CONSEQUENTIAL DAMAGE: In no event will E.T.I. be liable for any incidental or consequential damages arising out of the use or inability to use of any B-52 product, even if E.T.I. or a B-52 dealer has been advised of the possibility of such damages, or any other claim by any other party. Some states do not allow the exclusion or limitation of consequential damages, so the above limitation and exclusion may not apply to you. This warranty gives you specific legal rights and you may also have other rights which may vary from state to state.

FOR YOUR PROTECTION: Please complete and mail the **Purchase Information Card** within (10) ten days of the date of purchase so that we may contact you directly in the event a safety notification issued in accordance with the 1972 Consumer Product Safety Act. In addition, we ask that you complete the brief questionnaire so we may analyze your answers and in this way, help us evaluate our customer needs.

CUSTOMER SERVICE: Our dedicated staff is ready to help you with any B-52 warrant or product questions you may have. Please call 323-277-4100 (9:00AM to 4:00PM Pacific Standard Time).

B-52

E.T.I. Sound Systems, INC.
3383 Gage Ave., Huntington Park, CA, 90255

7



E.T.I. SOUND SYSTEMS, INC.

3383 Gage Avenue, Huntington Park, CA, 90255

Phone: 323-277-4100 Fax: 323-277-4108

National: 1-800-344-4ETI

Internet: www.B-52PRO.com

E-mail: info@B-52PRO.com

Free Manuals Download Website

<http://myh66.com>

<http://usermanuals.us>

<http://www.somanuals.com>

<http://www.4manuals.cc>

<http://www.manual-lib.com>

<http://www.404manual.com>

<http://www.luxmanual.com>

<http://aubethermostatmanual.com>

Golf course search by state

<http://golfingnear.com>

Email search by domain

<http://emailbydomain.com>

Auto manuals search

<http://auto.somanuals.com>

TV manuals search

<http://tv.somanuals.com>