

LTC 8786/50, LTC 8786/60 RS-232 to Biphase Converter Installation Instructions

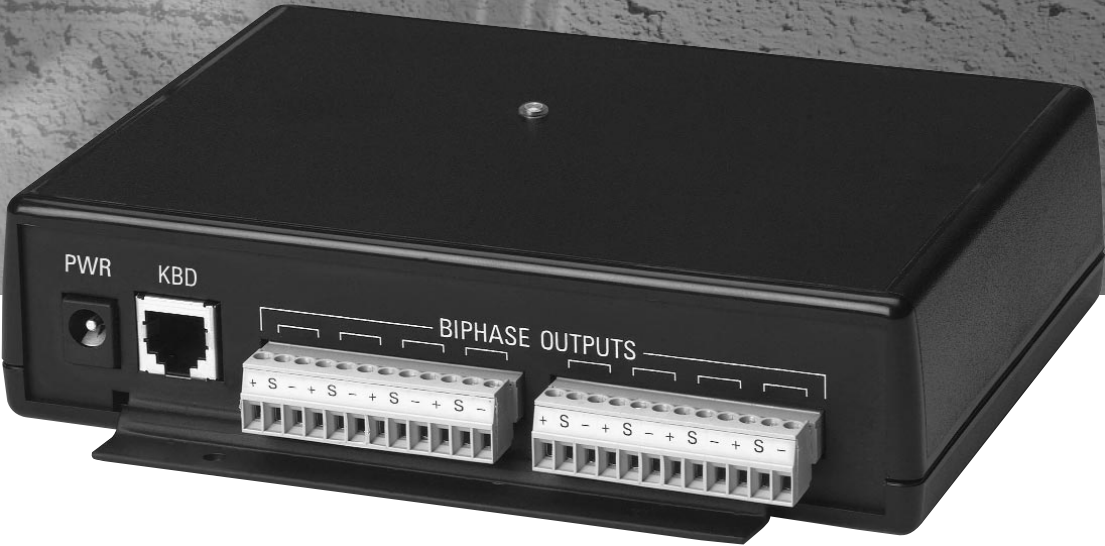

Security Systems

EN



Important Safeguards

1. Read and Retain Instructions - All safety and operating instructions should be read before the unit is operated. Follow all operating and use instructions.
2. Heed Warnings - Adhere to all warnings on the unit and in the operating instructions.
3. Cleaning - Unplug the unit from the outlet before cleaning. Do not use liquid cleaners or aerosol cleaners. Use a damp cloth for cleaning.
4. Attachments - Attachments not recommended by the product manufacturer should not be used, as they may cause hazards.
5. Accessories - Do not place this unit on an unstable stand, tripod, bracket, or mount. The unit may fall, causing serious injury to a person and serious damage to the unit. Use only with a stand, tripod, bracket, or mount recommended by the manufacturer or sold with the product. Any mounting of the unit should follow the manufacturer's instructions and should use a mounting accessory recommended by the manufacturer.
An appliance and cart combination should be moved with care. Quick stops, excessive force, and uneven surfaces may cause the appliance and cart combination to overturn.
6. Power Sources - This unit should be operated only from the type of power source indicated on the label. If unsure of the type of power supply to use, consult your dealer or local power company. For units intended to operate from battery power or other sources, refer to the operating instructions.
7. Power Lines - An outdoor system should not be located in the vicinity of overhead power lines or other electric light or power circuits or where it can fall into such power lines or circuits. When installing an outdoor system, extreme care should be taken to keep from touching such power lines or circuits as contact with them might be fatal.
U.S.A. models only - refer to the National Electrical Code Article 820 regarding installation of CATV systems.
8. Servicing - Do not attempt to service this unit yourself as opening or removing covers may expose you to dangerous voltage or other hazards. Refer all servicing to qualified service personnel.
9. Replacement Parts - When replacement parts are required, be sure the service technician has used replacement parts specified by the manufacturer or have the same characteristics as the original part. Unauthorized substitutions may result in fire, electric shock, or other hazards.
10. Safety Check - Upon completion of any service or repairs to this unit, ask the service technician to perform safety checks to determine that the unit is in proper operating condition.

11. Coax Grounding - If an outside cable system is connected to the unit, be sure the cable system is grounded. U.S.A. models only--Section 810 of the National Electrical Code, ANSI/NFPA No.70-1981, provides information with respect to proper grounding of the mount and supporting structure, grounding of the coax to a discharge unit, size of grounding conductors, location of discharge unit, connection to grounding electrodes, and requirements for the grounding electrode.



FCC & ICES Information (U.S.A. and Canadian Models Only)

WARNING - This equipment has been tested and found to comply with the requirements for a Class A digital device, pursuant to Part 15 of the FCC Rules and ICES-003 of Industry Canada. These limits are designed to provide reasonable protection against harmful interference when the equipment is operated in a residential installation. This equipment generates, uses, and radiates radio frequency energy and, if not installed and used in accordance with the instructions, may cause harmful interference to radio communications. Operation of this equipment in a residential area is likely to cause harmful interference, in which case the user will be required to correct the interference at his own expense. Intentional or unintentional changes or modifications not expressly approved by the party responsible for compliance shall not be made. Any such changes or modifications could void the user's authority to operate the equipment.

If necessary, the user should consult the dealer or an experienced radio/television technician for corrective action. The following booklet prepared by the Federal Communications Commission may be helpful: ***How to Identify and Resolve Radio-TV Interference Problems***. This booklet is available from the U.S. Government Printing Office, Washington, DC 20402, Stock No.004-000-00345-4.

WARNING: THIS IS A CLASS A PRODUCT. IN A DOMESTIC ENVIRONMENT, THIS PRODUCT MAY CAUSE RADIO INTERFERENCE, IN WHICH CASE THE USER MAY BE REQUIRED TO TAKE ADEQUATE MEASURES.

Safety Precautions

	CAUTION RISK OF ELECTRIC SHOCK. DO NOT OPEN!	
CAUTION: TO REDUCE THE RISK OF ELECTRICAL SHOCK, DO NOT OPEN COVERS. NO USER SERVICEABLE PARTS INSIDE. REFER SERVICING TO QUALIFIED SERVICE PERSONNEL.		



The lightning flash with an arrowhead symbol within an equilateral triangle is intended to alert the user to the presence of uninsulated "dangerous voltage" within the product's enclosure that may be of sufficient magnitude to constitute a risk of electric shock to persons.



The exclamation point within an equilateral triangle is intended to alert the user to presence of important operating and maintenance (servicing) instructions in the literature accompanying the appliance.

WARNING: TO PREVENT FIRE OR SHOCK HAZARD, DO NOT EXPOSE UNITS NOT SPECIFICALLY DESIGNED FOR OUTDOOR USE TO RAIN OR MOISTURE.



Attention: Installation should be performed by qualified service personnel only in accordance with the National Electrical Code or applicable local codes.

Cover Removal

	WARNING: REMOVAL OF THE COVER SHOULD ONLY BE PERFORMED BY QUALIFIED SERVICE PERSONNEL - NOT USER SERVICEABLE. THE UNIT SHOULD ALWAYS BE UNPLUGGED BEFORE REMOVING THE COVER AND REMAIN UNPLUGGED WHILE THE IS REMOVED.
---	--

220-240 V, 50 Hz Power Cords

220-240 V, 50 Hz power cords, input and output, must comply with the latest versions of IEC Publication 227 or IEC Publication 245.

Securite

	ATTENTION RISQUE D'ÉLECTROCUTION. NE PAS OUVRIR!	
DANGER: POUR ÉVITER TOUT RISQUE D'ÉLECTROCUTION, NE PAS OUVRIR LE BOÎTIER. IL N'Y A PAS DE PIÈCES REMPLAÇABLES À L'INTÉRIEUR. POUR TOUTE RÉVISION, S'ADRESSER À UN TECHNICIEN SPÉCIALISÉ.		



L'éclair fléché dans un triangle équilatéral, avertit l'utilisateur de la présence d'une "tension dangereuse" non isolée à l'intérieur de l'appareil et d'une valeur suffisante pour constituer un risque d'électrocution.



Le point d'exclamation contenu dans un triangle équilatéral, avertit l'utilisateur de la présence, dans la documentation qui accompagne l'appareil, de signes d'utilisation et de maintenance importantes.

ATTENTION: POUR ÉVITER LE RISQUE D'ÉLECTROCUTION OU D'INCENDIE, NE PAS EXPOSER À LA PLUIE OU À L'HUMIDITÉ UN APPAREIL NON CONÇU POUR UNE UTILISATION EXTÉRIEURE.



Attention: L'installation doit être effectuée uniquement par du personnel de service qualifié conformément à la réglementation du Code Electrique National ou à la réglementation locale.

Sources d'alimentation extérieures

	UTILISER UNIQUEMENT LES SOURCES D'ALIMENTATION RECOMMANDÉES. LES SOURCES D'ALIMENTATION DOIVENT ÊTRE CONFORMES AUX RÉGLEMENTATIONS DE LA DERNIÈRE VERSION IEC 65/VDE 0860. TOUTE MODIFICATION PEUT ENDOMMAGER L'APPAREIL OU PROVOQUER UN INCENDIE OU UN CHOC ÉLECTRIQUE.
---	--

Les cordons secteur 220-240 V, 50 Hz

Les cordons secteur 220-240 V, 50 Hz, entrée et sortie, doivent être conformes aux versions les plus récentes de la publication 227 de la C.I.E. ou à la publication 245 de la C.I.E.

Sicherheitsvorkehrungen



VORSICHT

ELEKTRISCHE SPANNUNG.
NICHT ÖFFNEN!



VORSICHT: UM EINEN ELEKTRISCHEN SCHLAG ZU VERMEIDEN, ABDECKUNG NICHT ENTFERNEN. WARTUNGEN ALLER ART QUALIFIZIERTEM PERSONAL ÜBERLASSEN.



Das Blitzsymbol im gleichseitigen Dreieck soll den Benutzer auf nicht isolierte "Hochspannung" im Gehäuse aufmerksam machen, die eventuell stark genug ist, um einen elektrischen Schlag zu verursachen.



Das Ausrufezeichen im gleichseitigen Dreieck soll den Benutzer auf wichtige Bedienungs- und Wartungsanleitungen in der dem Gerät beigelegten Literatur aufmerksam machen.

WARNUNG: UM FEUER ODER ELEKTRISCHE SCHLÄGE ZU VERMEIDEN, SETZEN SIE DAS GERÄT NIEMALS REGEN ODER FEUCHTIGKEIT AUS.



Achtung! Die Installation sollte nur von qualifiziertem Kundendienstpersonal gemäß jeweilig zutreffender Elektrovorschriften ausgeführt werden.

Externe Netzgeräte



NUR VOM HERSTELLER EMPFOHLENE NETZGERÄTE VERWENDEN! DIE NETZGERÄTE MÜSSEN DER JEWEILS GÜLTIGEN VERSION DER IEC 65/VDE 0860 BESTIMMUNGEN ENTSPRECHEN. ANDERE ERSATZNETZGERÄTE KÖNNEN DAS VORLIEGENDE GERÄT BESCHÄDIGEN UND FEUER ODER ELEKTROSCHLAG BEWIRKEN.

220-240 V, 50 Hz Netzkabel, Eingang und Ausgang

220-240 V, 50 Hz Netzkabel, Eingang und Ausgang, muß die neueste Version der IEC Vorschriften, Veröffentlichung 227 oder 245, erfüllen.

Sicurezza



ATTENZIONE

PERICOLO DI SCOSSA ELETTRICA.
NON APRIRE.



ATTENZIONE: PER RIDURRE IL PERICOLO DI SCOSSA ELETTRICA, NON APRIRE LE COPERTURE. L'INTERNO NON CONTIENE COMPONENTI CHE L'UTENTE PUÒ RIPARARE PERSONALMENTE. RIVOLGERSI AL PERSONALE DI ASSISTENZA QUALIFICATO PER QUALSIASI INTERVENTO DI RIPARAZIONE.



Il simbolo triangolare di un fulmine con la punta a freccia intende mettere in allerta l'utente riguardo alla presenza di tensioni pericolose non isolate all'interno del guscio dell'unità, che potrebbero essere di intensità sufficiente per costituire pericolo di elettrocuzione.



Il punto esclamativo racchiuso in un triangolo equilatero intende avvisare l'utente in merito alla presenza di importanti istruzioni operative e di manutenzione nella documentazione di accompagnamento all'unità.

AVVERTENZA: PER IMPEDIRE INCENDI O SCOSSA ELETTRICA, NON ESPORRE L'UNITÀ ALLA PIOGGIA O ALL'UMIDITÀ.



Precauzione: affidare l'installazione al solo personale qualificato e nel rispetto del Codice elettrico nazionale (USA) o dei codici locali pertinenti.

Rimozione Della Copertura



AVVERTENZA: AFFIDARE LA RIMOZIONE DELLA COPERTURA SOLTANTO AL PERSONALE DI SERVIZIO QUALIFICATO. L'UTENTE DEVE ASTENERSI DALL'EFFETTUARE UN INTERVENTO DI RIPARAZIONE DI PERSONA. DISINSERIRE SEMPRE IL CAVO DI ALIMENTAZIONE DALL'UNITÀ PRIMA DI RIMUOVERE LA COPERTURA E NON REINSERIRLO SE LA COPERTURA NON È STATA RICHIUSA.

Cavi di alimentazione a 220-440 V, 50 Hz

I cavi di alimentazione a 220-440 V, 50 Hz devono essere conformi (ingresso e uscita) alle versioni più recenti della pubblicazione IEC 227 o IEC 245.

Veiligheidsmaatregelen

	VOORZICHTIG GEVAARVOOR ELEKTRISCHE SCHOK. NIET OPENEN!	
<p>VOORZICHTIG: MAAK HET APPARAAT NIET OPEN OM DE KANS OP ELEKTRISCHE SCHOKKEN TE VERMIJDEN. BEVAT GEEN ONDERDELEN DIE DOOR DE GEBRUIKER MOETEN WORDEN ONDERHOUDEN. LAAT ONDERHOUD EN REPARATIES UITVOEREN DOOR BEVOEGDE TECHNICI.</p>		



Het symbool 'Bliksemflits met pijlkop' in een gelijkzijdige driehoek wijst de gebruiker op de aanwezigheid in de kast van het apparaat van niet-geïsoleerde spanningen die voldoende sterk zijn om het gevaar van elektrische schokken op te leveren.



Het uitroepteken in een gelijkzijdige driehoek maakt de gebruiker attent op de aanwezigheid in de bij het apparaat behorende documentatie van belangrijke aanwijzingen voor bediening en onderhoud.

WAARSCHUWING: TER VOORKOMING VAN BRANDGEVAAR EN ELEKTRISCHE SCHOKKEN MAG DIT ARMATUUR NIET AAN REGEN EN VOCHT WORDEN BLOOTGESTELD.



Let op: Het apparaat mag uitsluitend door bevoegde technici geïnstalleerd worden en wel in overeenstemming met de National Electrical Code of de daarvoor plaatselijk geldende richtlijnen.

Verwijderen van de Dekplaat

	<p>WAARSCHUWING: HET VERWIJDEREN VAN DE DEKPLAAT MAG UITSLUITEND DOOR EEN VAKKUNDIG TECHNICUS WORDEN UITGEVOERD - REPARATIE DOOR GEBRUIKER IS NIET GEOORLOOFD. DE NETVOEDING VAN HET APPARAAT MOET ALTIJD WORDEN LOSGEKOPPELD VOORDAT MEN DE DEKPLAAT VERWIJDERD EN LOSGEKOPPELD BLIJVEN ZOLANG DE DEKPLAAT VERWIJDERD IS.</p>
---	--

Netvoedingskabels 220-440 V, 50 Hz

Netvoedingskabels 220-440 V, 50 Hz, voor ingang en uitgang, moeten voldoen aan de voorschriften in de meest recente uitgave van IEC publicatie 227 of IEC publicatie 245.

Precauciones de Seguridad

	PRECAUCIÓN RIESGO DE DESCARGA ELÉCTRICA ¡NO ABRIR!	
<p>PRECAUCION: PARA REDUCIR EL RIESGO DE CHOQUE ELÉCTRICO, FAVOR NO ABRIR LA CUBIERTA. ESTE EQUIPO NO CONSTA DE PIEZAS O PARTES QUE REQUIEREN SERVICIO O MANTENIMIENTO. PARA REPARACIONES FAVOR REFERIRSE A UN TÉCNICO CALIFICADO.</p>		



El símbolo representado por un relámpago con punta de flecha dentro de un triángulo equilátero, se muestra con el objetivo de alertar al usuario que existen "voltajes peligrosos" sin aislamiento, dentro de la cubierta de la unidad. Dichos voltajes pueden ser de tal magnitud que constituyen un riesgo de choque eléctrico a personas.



El símbolo de exclamación dentro de un triángulo equilátero, se muestra con el objetivo de alertar al usuario de que instrucciones de operación y mantenimiento importantes acompañan al equipo.

PELIGRO: PARA EVITAR EL PELIGRO DE INCENDIO Ó CHOQUE ELÉCTRICO, NO EXPONGA A LA LLUVIA Ó HUMEDAD, EQUIPOS QUE NO HAN SIDO DISEÑADOS PARA USO EXTERIOR.



Atención: La instalación de este equipo debe ser realizada por personal capacitado, solo en acuerdo, y en cumplimiento de normas del "National Electric Code" (Código Eléctrico Nacional) ó las normas del Gobierno Nacional Local.

Fuentes de Alimentación Externas

	<p>USAR SOLO LAS FUENTES DE ALIMENTACIÓN RECOMENDADAS. LAS FUENTES DE ALIMENTACIÓN DEBEN CUMPLIR CON LOS REQUISITOS DE LA VERSIÓN MÁS RECIENTE DE LA IEC 65/VDE 0860. EL USO DE SUBSTITUTOS PUEDE DAÑAR LA UNIDAD, Ó CREAR PELIGRO DE INCENDIO O CHOQUE ELÉCTRICO.</p>
---	--

220-240 V, los cables eléctricos de 50 Hz: 220-240 V, los cables eléctricos de 50 Hz, de entrada y de salida, deben cumplir con las versiones más recientes de la publicación IEC 227 ó la Publicación IEC 245.

Medidas de Segurança

	CUIDADO RISCO DE CHOQUE ELÉCTRICO. NÃO ABRIR!	
<p>PRECAUCION: PARA REDUCIR EL RIESGO DE CHOQUE ELÉCTRICO, FAVOR NO ABRIR LA CUBIERTA. ESTE EQUIPO NO CONSTA DE PIEZAS O PARTES QUE REQUIEREN SERVICIO O MANTENIMIENTO. PARA REPARACIONES FAVOR REFERIRSE A UN TÉCNICO CALIFICADO.</p>		



O símbolo do raio com a cabeça de uma seta dentro de um triângulo equilátero serve para alertar o utilizar para a presença de "corrente eléctrica perigosa" não isolada no interior da caixa do produto que pode ser suficiente para dar origem a choques eléctricos.



O ponto de exclamação dentro de um triângulo equilátero serve para alertar o utilizador para a presença de instruções de funcionamento e manutenção importantes na documentação fornecida com o aparelho.

AVISO: PARA EVITAR INCÊNDIOS OU CHOQUES ELÉCTRICOS, NÃO EXPONHA À CHUVA OU HUMIDADE UNIDADES NÃO ESPECIFICAMENTE CRIADAS PARA UTILIZAÇÃO NO EXTERIOR.



Atenção: A instalação deve ser efectuada por pessoal de assistência técnica qualificado, de acordo com o National Electrical Code (Normas de Electricidade Nacionais) ou a legislação local aplicável.



Remoção da Tampa

	<p>ATENÇÃO: A TAMPA DEVE SER REMOVIDA APENAS PELO PESSOAL DA ASSISTÊNCIA TÉCNICA QUALIFICADA. ESTA UNIDADE NÃO CONTÉM PEÇAS REQUEREM MANUTENÇÃO PELO USUÁRIO. ANTES DE REMOVER A TAMPA, CERTIFIQUE-SE DE QUE O EQUIPAMENTO FOL DESCONECTADO DA ALIMENTAÇÃO. ESTE DEVE PERMANECER DESCONECTADO ENQUANTO A TAMPA ESTIVER FORA DO SEU LUGAR.</p>
---	---

Cabos de alimentação 220-240 V, 50Hz

Os cabos de alimentação 220-240 V, 50 Hz, entrada ou saída, devem estar de acordo com as últimas versões do IEC Publicação 227 ou do IEC Publicação 245.

Zasady Bezpieczeństwa

	UWAGA NIEBEZPIECZEŃSTWO PORAŻENIA PRĄDEM ELEKTRYCZNYM. NIE OTWIERAĆ!	
<p>UWAGA: ZE WZGLĘDU NA NIEBEZPIECZEŃSTWO PORAŻENIA PRĄDEM NIE WOLNO OTWIERAĆ POKRYWY. W ŚRODKU NIE MA ŻADNYCH ELEMENTÓW, KTÓRE MOGĄ BYĆ NAPRAWIANE PRZEZ UŻYTKOWNIKA. NAPRAWĘ NALEŻY POWIERZYĆ AUTORYZOWANEMU PUNKTOWI SERWISOWEMU.</p>		



Błyskawica ze strzałką wewnątrz trójkąta równobocznego ma za zadanie zwrócić uwagę użytkownika na obecność niez izolowanego "niebezpiecznego napięcia" wewnątrz obudowy urządzenia, o wielkości stwarzającej niebezpieczeństwo porażenia prądem.



Wykrzyknik wewnątrz trójkąta równobocznego ma za zadanie zwrócić uwagę użytkownika na ważne czynności, związane z obsługą i konserwacją urządzenia, zamieszczone w Instrukcji obsługi.

OSTRZEŻENIE: ABY UNIKNĄĆ POŻARU LUB PORAŻENIA PRĄDEM NIE WOLNO WYSTAWIAĆ NA DZIAŁANIE DESZCZU LUB WILGOCI URZĄDZEŃ, KTÓRE NIE ZOSTAŁY SPECJALNIE ZAPROJEKTOWANE DO UŻYWANIA NA OTWARTYM POWIETRZU.



Uwaga: Instalację urządzenia powinien wykonać tylko wykwalifikowany personel, zgodnie z przepisami NEC lub odpowiednimi przepisami miejscowymi.

Otwieranie Obudowy

	<p>UWAGA: OBUDOWA URZĄDZENIA MOŻE BYĆ OTWIERANA TYLKO PRZEZ WYKWALIFIKOWANY PERSONEL. PRZED OTWARCIEM OBUDOWY WYJĄĆ WTYCZKĘ Z GNIAZDA SIECIOWEGO.</p>
---	---

Kable zasilające 220–240 V, 50Hz

Kable zasilające 220–240 V, 50Hz, wejścia i wyjścia muszą być zgodne z ostatnią wersją publikacji nr 227 lub 245 IEC.

Table of Contents

1	DESCRIPTION	7
2	UNPACKING	7
3	SERVICE	7
4	POWER	7
5	INSTALLATION	8
5.1	Mounting	8
5.2	Power Supply Connections	8
5.3	Data Input Connections	8
5.4	PC RS-232 Interface Using a 9-Pin Connector ...	8
5.5	RS-232 Interface Using RJ-11 Connector	8
5.6	Remote RS-232 Device Interface	8
5.7	Data Output Connection	9
5.8	AutoDome Camera or Receiver/ Driver Site Configuration	9
6	OPERATION	9
7	TYPICAL CONFIGURATIONS	10
8	PIN OUTS	11
9	DIMENSIONS	11

1 DESCRIPTION

The LTC 8786 Series of data converters are designed to convert Bosch "Receiver/driver and AutoDome RS-232 Control Code Protocol" into Allegiant biphasic control code.

These units are specifically designed to transform the single data output from a DESA DVR (or a similar device) into multiple control code outputs for operating AutoDome cameras.

The Bosch "Receiver/driver and AutoDome RS-232 Control Code Protocol" is a simplex RS-232 data format designed to communicate with the Bosch line of receiver/drivers, AutoDome cameras, LTC 8786 converters, and other compatible accessory devices. Complete information on the protocol can be obtained by downloading the manual from the AutoDome section of www.boschsecurity.com.

The input RS-232 baud rate of the LTC 8786 Series is fixed at 9600 baud, 1 stop bit, 8 data bits, no parity, and no handshake.

The LTC 8786 Series units can be connected directly to the RS-232 serial port of a PC using an industry standard null modem cable. If another connection type is required, an interface cable can easily be constructed using the supplied 9-Pin D connector.

The supplied power supply provides power to the LTC 8786 Series unit.

2 UNPACKING

This electromechanical equipment should be unpacked and handled carefully:

- LTC 8786/50 or LTC 8786/60 Data Converter unit.
- Power supply adapter.
- 1.8m (5.75) power supply cable with bayonette plug.
- Subminiature 9-Pin D connector.
- Four (4) adhesive backed rubber feet.

If an item appears to have been damaged in shipment, replace properly into the carton and notify the shipper. If any items are missing, notify your Bosch Security Systems Sales Representative or Customer Service Representative. The shipping carton is the safest container in which the unit may be transported. Save it for possible future use.

3 SERVICE

If the unit ever needs repair service, the customer should contact the nearest Bosch Security Systems Service Center for authorization to return and shipping instructions.

Service Centers

U.S.A.: Phone: 800-366-2283 or 408-956-3895

fax: 800-366-1329 or 408-956-3896

e-mail: NationalServiceCenter@ca.slr.com

Canada: 514-738-2434

Europe, Middle East & Asia Pacific Region:
32-1-440-0711

**For additional information,
see www.boschsecuritysystems.com.**

4 Power

Model	Rated Voltage	Voltage Range	Power*
LTC 8786/60	120 VAC, 50/60 Hz	105 to 132 VAC	3 W
LTC 8786/50	220-240 VAC, 50/60 Hz	195.5 to 253 VAC	3 W

* At rated voltage.

5 INSTALLATION

5.1 Mounting

The LTC 8786 Series Data Converters are rated for indoor use only. If desired, four (4) holes are provided for mounting the unit to a flat surface. See MOUNTING DIMENSIONS at the end of this document.

If using on a desktop, attach the supplied rubber feet to the bottom of the unit.

A cable suitable for use with RS-232 signals (not supplied) must be used between the RS-232 device and the LTC 8786 unit. If the distance between the RS-232 device and the LTC 8786 unit is over 20-30 meters (60-90 ft), the use of 'short haul modems' (not supplied) or other RS-232 line extender devices may be required. An RS-232 simplex transmission rate of 9600 baud will need to be supported by the link.

5.2 Power Supply Connections

Install the LTC 8786 unit within 1.8m (5.75) of the mains power source. Connect the 'bayonet' style connector of the power supply cable into the jack located on the side of the converter unit. Plug the power supply adapter into a suitable AC power source.

If the power supply must be located beyond 1.8m, the provided power supply cable can be extended, or replaced with an appropriate user-supplied cable. The LTC 8786 is not polarity-sensitive, so it does not matter which direction the cable is attached to the power supply adapter.

If desired, a user-provided power supply may be used with the data converter. A power supply having either a 15-20 VDC \pm 10%, 400 mA or 12-18 VAC \pm 10%, 400 mA output is required.

If necessary, replacement power supply adapters can be ordered as noted below:

120 VAC input: KBD-120PS Power supply and power cable.
230 VAC input: KBD-220PS Power supply and power cable.

5.3 Data Input Connections

Two (2) data input connections to the converter unit are available. Only one can be used at a time, and the choice varies depending upon the specific application. Although various connection options are possible, typical applications are described in the sections that follow. Use whichever application is most suitable to your configuration. Typical configuration diagrams are included in this manual for reference.

5.4 PC RS-232 Interface Using a 9-Pin Connector

In this application, the LTC 8786 is connected directly to the serial port of a PC. The user-supplied software installed on the PC must be designed to output "Receiver/driver and AutoDome RS-232 Control Code Protocol" data. This RS-232 data is converted into Allegiant biphasic protocol using the LTC 8786 unit. The biphasic data is then connected to the AutoDome cameras or Allegiant receiver/driver units as described herein.

Attach an RS-232 standard null modem cable (part No. S1385) to the serial port of the PC. Connect the other end of the data cable to the 9-pin connector on the LTC 8786 converter unit.

Skip to the section on AUTODOME CAMERA OR RECEIVER/DRIVER SITE CONFIGURATION to complete the installation.

5.5 RS-232 Interface Using RJ-11 Connector

Connect one end of a suitable data cable to the RJ-11 jack on the LTC 8786 converter unit. The other end of the cable must now be interfaced to the RS-232 communication link. Only the RX and SIGNAL GROUND connections are required. The remaining pinouts should remain 'un-connected'.

If the distance between the RS-232 communication link and the LTC 8786 converter unit is greater than 3 m (10), install an appropriate length of cable suitable for use with RS-232 signals (user-supplied). Since the data format is an RS-232 simplex transmission, only 2 signal wires (DATA and GROUND) will be required.

If the distance between the LTC 8786 unit and the camera site is over 20-30 m (60-90 ft), the use of short haul modems (user-supplied) or other RS-232 line extender devices may be required. They must be able to support an RS-232 simplex transmission rate of 9600 baud.

The wiring pinouts of the LTC 8786 series is shown in the PINOUTS section.

5.6 Remote RS-232 Device Interface

In this application, Allegiant biphasic control code is being converted into RS-232 which is then transmitted over an RS-232 communication link (fiber optics, microwave, dial-up phone modems, etc.). At the camera side end of the RS-232 transmission link, the RS-232 data is converted back into Allegiant biphasic protocol via the LTC 8786 unit. The biphasic data is then connected to AutoDome cameras or Allegiant receiver/driver units.

The RS-232 communication link must be able to support an RS-232 simplex transmission rate of 9600 baud.

5.7 Data Output Connection

The LTC 8786 Series provides sixteen biphasic control code outputs. Connect a shielded twisted-pair cable (BELDEN 8760 or equivalent) from a biphasic control code output of the converter unit to the camera site. Typically, a single camera site receiver/driver or AutoDome is connected, but the biphasic output of the converter unit is rated to handle up to 8 devices when connected in a daisy chain configuration to a maximum of 1.5 km (5000 ft). For a daisy chain connection, the cable is looped through each AutoDome camera or receiver/driver along the way. Only the last unit in the daisy chain connection should be terminated. All other receiver/drivers should have their terminating resistor removed when the looping cable is connected.

The removable terminal blocks for the biphasic code outputs have three connections: (+), (S) (Shield), and (-) for each of the sixteen biphasic code outputs as shown in FIGURE 1.

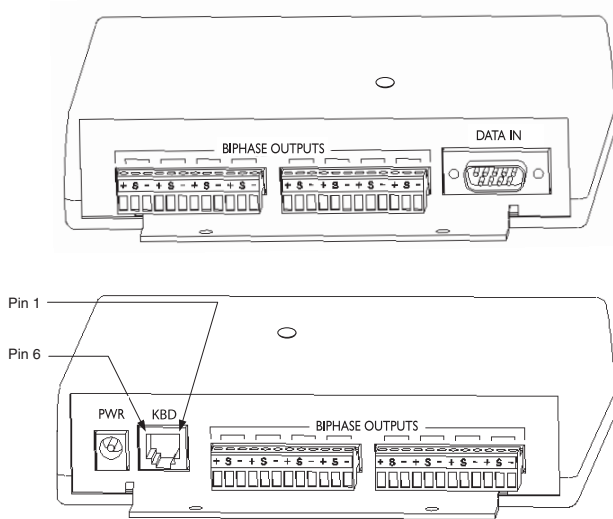

Figure 1 LTC 8786 Data Converter Connections

Select and maintain a wire color convention to avoid confusion at the camera site(s).

Example: White to (+), (Shield) to (S), and Black to (-).

NOTE The shield terminal of the interface unit is connected to the shield wire of the cable.

5.8 AutoDome Camera or Receiver/Driver Site Configuration

Follow the standard installation instructions provided with the AutoDome Camera or Allegiant Series Receiver/Driver unit for setting device address and connecting the data cable to the unit.

Video signals from the camera site are NOT associated with this product. The video signal(s) from the camera site(s) should be connected to an appropriate viewing monitor or other video processing equipment (switcher, PC video capture card, etc.).

6 OPERATION

Operation of the LTC 8786 Series is automatic. An LED, visible on the top cover of the unit, will flash to indicate that the unit has converted RS-232 data into biphasic control code. No programming or other user adjustments are required.

7 TYPICAL CONFIGURATIONS

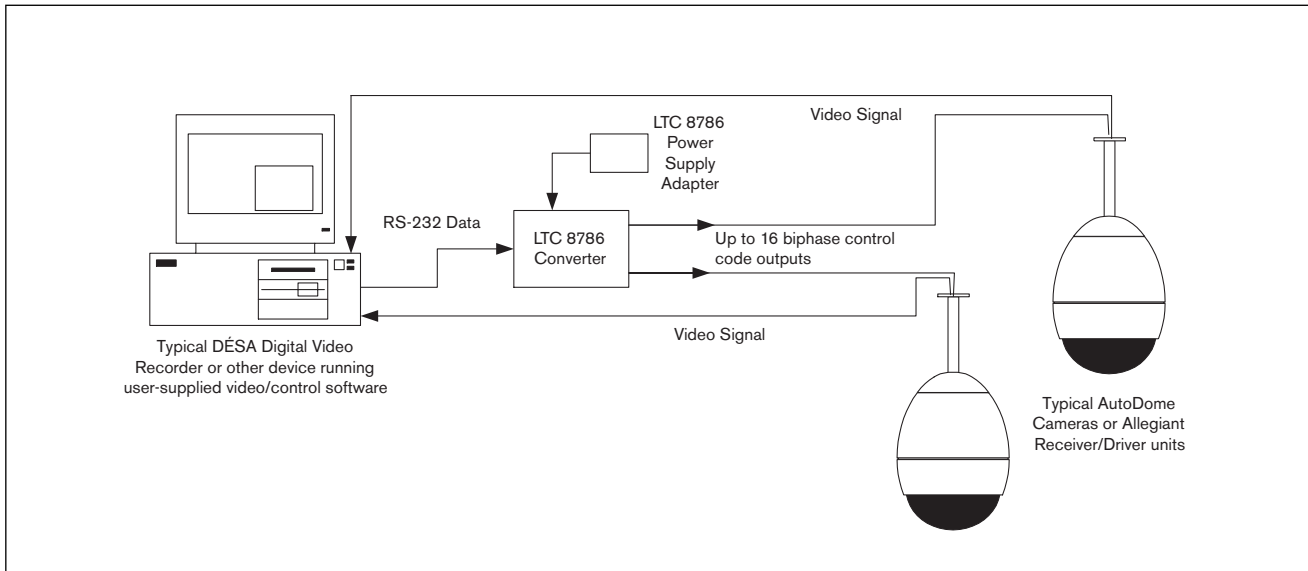

Figure 2 Using PC Or D&E S A Digital Video Recorder As Source Of RS-232 Data

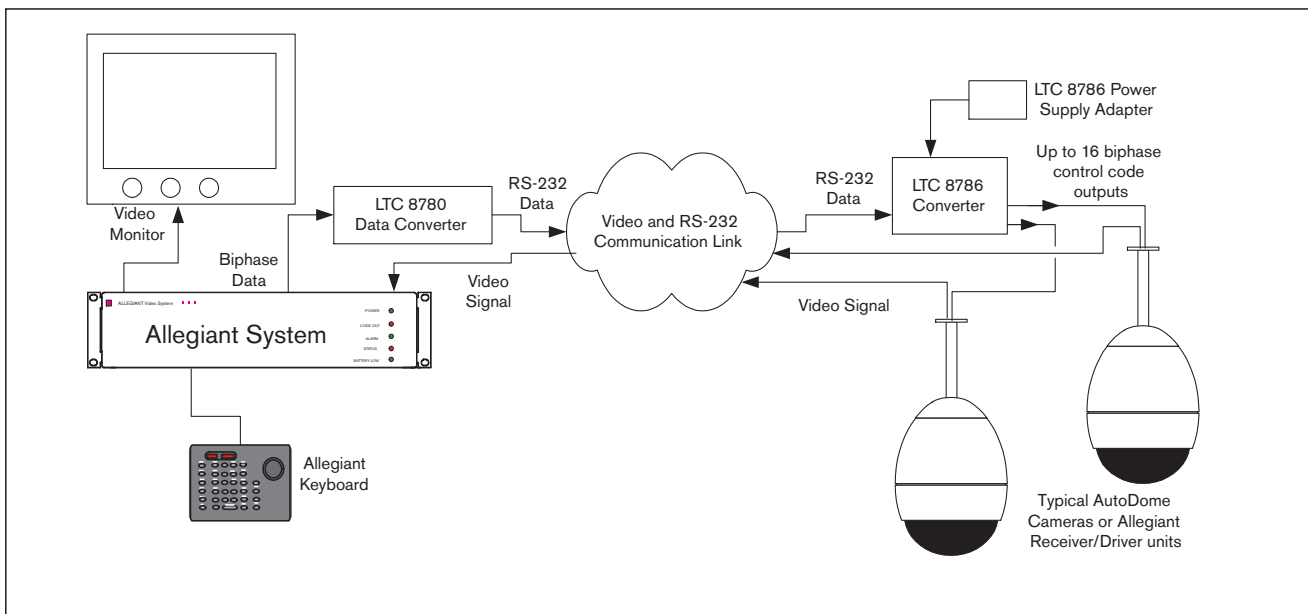

Figure 3 When Used as Remote RS-232 To Biphas e Data Converter

8 PINOUTS

Data In - 9-Pin Connector (Male)

Pin	Connection
1	No Connection
2	Rx
3	No Connection
4	No Connection
5	Ground
6	No Connection
7	No Connection
8	No Connection
9	No Connection

RJ-11 Designations (If Used)

Pin	Connection
1	Output Voltage ¹
2	Signal Ground
3	Rx
4	Ground
5	No Connection
6	Output Voltage ¹

1. These connections should be left unconnected in this configuration.

Industry Standard PC Null Modem Interface Cable¹ (Purchased separately- Part No. S1385)

LTC 8786 Side (9-Pin Female)	PC or DVR Side (9-Pin Female)
---	--

Pin	Pin
1	4
2	3
3	2
4	1, 6
5	5
6	--
7	8
8	7
9	--

1. The LTC 8786 only requires connections to pin 2 and 5 of its 9-Pin connector.

9 MOUNTING DIMENSIONS

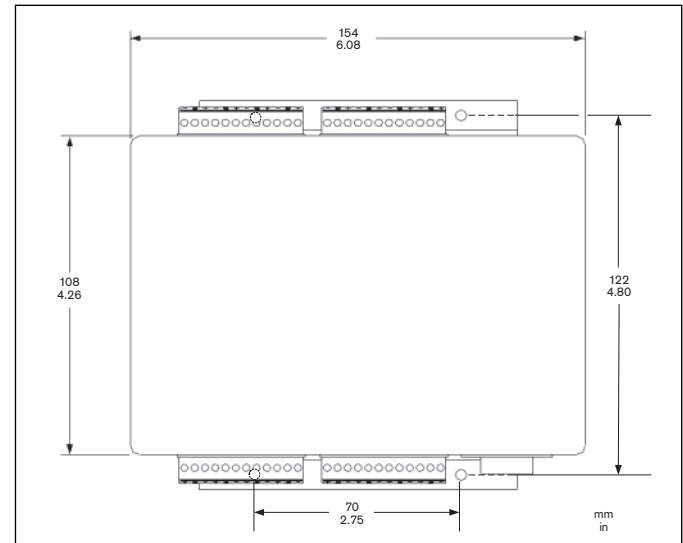

Figure 4 Top Dimensions

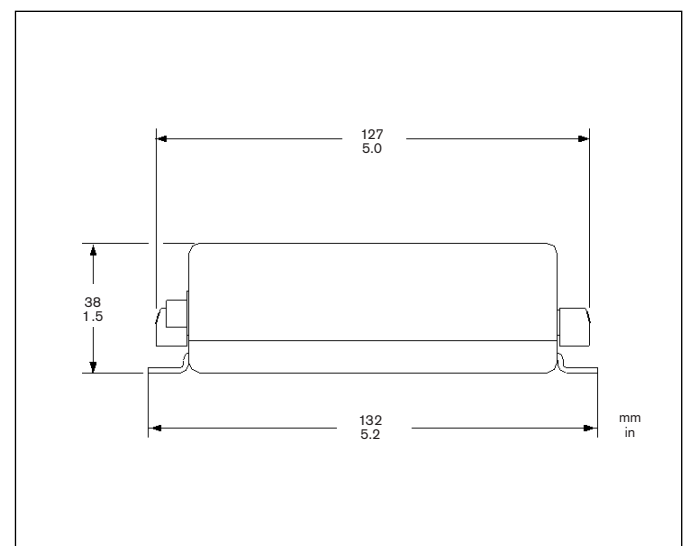

Figure 5 Side Dimensions

Bosch Security Systems, Inc.
850 Greenfield Road
Lancaster, PA 17601 U.S.A.
Tel: 800-326-3270
Fax: 1-717-735-6560

Bosch Security Systems B.V.
P.O. Box 80002, 5600 JB
Eindhoven
The Netherlands
Tel: 31 40 278 1222
Fax: 31 40 278 6668

Bosch Singapore Pte. Ltd.
620A, Lorong 1 Toa Payoh
Singapore 319762
Republic of Singapore
Tel: 65 350 1859
Fax: 65 356 9202

Printed in USA
3935 890 45511 03-08
April 28, 2003



BOSCH

Security you can rely on

Free Manuals Download Website

<http://myh66.com>

<http://usermanuals.us>

<http://www.somanuals.com>

<http://www.4manuals.cc>

<http://www.manual-lib.com>

<http://www.404manual.com>

<http://www.luxmanual.com>

<http://aubethermostatmanual.com>

Golf course search by state

<http://golfingnear.com>

Email search by domain

<http://emailbydomain.com>

Auto manuals search

<http://auto.somanuals.com>

TV manuals search

<http://tv.somanuals.com>