



# **BOXLIGHT CD-725c**

---

## **User's Guide**

## Copyright

---

Copyright © 2002 by BOXLIGHT Corporation. All rights reserved. No part of this publication may be reproduced, transmitted, transcribed, stored in a retrieval system or translated into any language or computer language, in any form or by any means, electronic, mechanical, magnetic, optical, chemical, manual or otherwise, without the prior written permission of BOXLIGHT Corporation.

## Disclaimer

---

BOXLIGHT Corporation makes no representations or warranties, either expressed or implied, with respect to the contents hereof and specifically disclaims any warranties, merchantability or fitness for any particular purpose. Furthermore, BOXLIGHT Corporation reserves the right to revise this publication and to make changes from time to time in the contents hereof without obligation of BOXLIGHT Corporation to notify any person of such revision or changes.

<b>Fill this in!!</b>	
In case service is needed in the future, record the information described below. The serial number is on the back of the product.	
<b>Projector Information</b>	
Product Name:	BOXLIGHT CD-725c Multimedia Digital Projector
Serial Number:	
Date of Purchase:	
<b>Dealer Information</b>	
Dealer:	
Telephone Number:	
Address:	

# Table of Contents

<b>Introduction</b> .....	<b>1</b>
Safety Instructions .....	1
Warranty .....	2
Limited Warranty .....	2
FCC Statement .....	3
Shipping Contents .....	4
Optional Accessories .....	4
Projector Description .....	5
Projector .....	5
External Control Panel .....	6
Adjuster .....	7
Projector Features .....	7
Remote Control Description .....	8
Installing or Replacing Batteries .....	9
<b>Installation</b> .....	<b>10</b>
Screen Size .....	10
Connecting to Various Equipment .....	10
<b>Operation</b> .....	<b>12</b>
Start Up .....	12
Digital Keystone Correction .....	13
Auto Adjustment .....	13
Source Selection .....	14
Menu System .....	14
1. Display Menu .....	15
2. Image Menu .....	16
3. Source Menu .....	17
4. Control Menu .....	18
5. PIP Menu .....	19
Shutdown .....	20
<b>Maintenance</b> .....	<b>21</b>
Lamp Information .....	21
Use and Replacement of the Lamp .....	21
Lamp LED Indicators .....	21
Lamp Replacement .....	22
Resetting Lamp Hours .....	23
Temp Information .....	23
Service Information .....	24
Accessories (included in the Standard Package) .....	24
Optional Accessories (not included in the Standard Package) .....	24
Ordering Parts or Getting Information .....	24
<b>Troubleshooting</b> .....	<b>25</b>

Status Messages .....	26
<b>Specifications .....</b>	<b>27</b>
Projector Specifications .....	27
Timing Chart .....	28
<b>Dimensions .....</b>	<b>29</b>

---

# INTRODUCTION

---

## Caution

**TO PREVENT SHOCK, DO NOT OPEN THE CABINET. NO USER –SERVICEABLE PARTS INSIDE. REFER SERVICING TO QUALIFIED SERVICE PERSONNEL. PLEASE READ THIS USER'S GUIDE BEFORE YOU OPERATE YOUR PROJECTOR. SAVE THIS USER'S GUIDE FOR FUTURE REFERENCE .**

---

## Safety Instructions

1. Read this user's guide before you operate your projector and save it for future reference.
2. The lamp becomes extremely hot during operation. Allow the projector to cool for approximately 45 minutes prior to removing the lamp assembly for replacement. Do not operate lamps beyond the rated lamp life. Excessive operation of lamps beyond the rated life could cause them to explode on rare occasions.
3. Never replace the lamp assembly or any electronic components unless the projector is unplugged.
4. To reduce the risk of electric shock, do not disassemble this appliance. Take it to a qualified technician when service or repair is required. Incorrect reassembly can cause electric shock when the appliance is subsequently used.
5. Do not place this product on an unstable cart, stand, or table. The product may fall, sustaining serious damage.
6. This product is capable of displaying inverted images for ceiling mount installation. Please use suitable equipment for mounting the unit and ensure it is securely installed.

---

## Caution

- **Always open the lens shutter or remove the lens cap when the projector lamp is on.**
  - **Do not look straight at the projector lens during operation. The intense light beam may damage your eyes.**
  - **In some countries, the line voltage is NOT stable. This projector is designed to operate safely within a bandwidth of 110 to 240 volts, but could fail if power cuts or surges of more than 10 volts occur. In these high-risk areas, it is recommended that a power stabilizer unit be used in conjunction with this projector.**
- 

**Save this user's guide:** The information contained in this manual will assist you in operating and maintaining your personal projector.

## Warranty

### LIMITED WARRANTY

Boxlight ("Boxlight") warrants that each CD-725c ("the Product") sold hereunder will conform to and function in accordance with the written specifications of Boxlight. Said limited warranty shall apply only to the first person or entity that purchases the Product for personal or business use and not for the purpose of distribution or resale. Said warranty shall continue for a period of two (2) years from the date of such purchase. The standard limited warranty excludes the lamps in projectors after 120 days and the accessories after one year. Boxlight does not warrant that the Product will meet the specific requirements of the first person or entity that purchases the Product for personal or business use. Boxlight's liability for the breach of the foregoing limited warranty is limited to the repair or replacement of the Product or refund of the purchase price of the Product, at Boxlight's sole option. Replacement Product may be re-furbished in "like-new" condition, at Boxlight's sole discretion. To exercise the Purchaser's rights under the foregoing warranty, the Product must be returned at the Purchaser's sole cost and expense, to Boxlight or to any authorized Boxlight service center provided, and the Product must be accompanied by a written letter explaining the problem and which includes (i) proof of date of purchase; (ii) the dealer's name; and (iii) the model and serial number of the Product. When sending your unit in for repair, please ship your unit in its original packing material or a Boxlight approved ATA Shipping Case, or have a professional packaging company pack the unit. Please insure your shipment for its full value. A return authorization number, issued by the Boxlight customer service department, must also be clearly displayed on the outside of the shipping carton containing the Product.

### WARRANTY LIMITATION AND EXCLUSION

Boxlight shall have no further obligation under the foregoing limited warranty if the Product has been damaged due to abuse, misuse, neglect, accident, unusual physical or electrical stress (unusual physical and electrical stress includes unusually long operation, exposure to smoke and other airborne contaminants), unauthorized modifications, tampering, alterations, or service other than by Boxlight or its authorized agents, causes other than from ordinary use or failure to properly use the Product in the application for which said Product is intended.

### DISCLAIMER OF UNSTATED WARRANTIES

THE WARRANTY PRINTED ABOVE IS THE ONLY WARRANTY APPLICABLE TO THIS PURCHASE. ALL OTHER WARRANTIES, EXPRESS OR IMPLIED, INCLUDING, BUT NOT LIMITED TO, THE IMPLIED WARRANTIES OF MERCHANTABILITY AND FITNESS FOR A PARTICULAR PURPOSE ARE DISCLAIMED. THERE ARE NO WARRANTIES THAT EXTEND BEYOND THE FACE HEREOF AND THE FOREGOING WARRANTY SHALL NOT BE EXTENDED, ALTERED OR VARIED EXCEPT BY WRITTEN INSTRUMENT SIGNED BY BOXLIGHT. SOME STATES DO NOT ALLOW LIMITATIONS ON HOW LONG AN IMPLIED WARRANTY MAY LAST, SO SUCH LIMITATIONS MAY NOT APPLY TO YOU.

## LIMITATION OF LIABILITY

IT IS UNDERSTOOD AND AGREED THAT BOXLIGHT'S LIABILITY WHETHER IN CONTRACT, IN TORT, UNDER ANY WARRANTY, IN NEGLIGENCE OR OTHERWISE SHALL NOT EXCEED THE RETURN OF THE AMOUNT OF THE PURCHASE PRICE PAID BY PURCHASER AND UNDER NO CIRCUMSTANCES SHALL BOXLIGHT BE LIABLE FOR SPECIAL, INDIRECT, INCIDENTAL OR CONSEQUENTIAL DAMAGES OR LOST PROFITS, LOST REVENUES OR LOST SAVINGS. THE PRICE STATED FOR THE PRODUCT IS A CONSIDERATION IN LIMITING BOXLIGHT'S LIABILITY. NO ACTION, REGARDLESS OF FORM, ARISING OUT OF THE AGREEMENT TO PURCHASE THE PRODUCT MAY BE BROUGHT BY PURCHASER MORE THAN ONE YEAR AFTER THE CAUSE OF ACTION HAS ACCRUED. SOME STATES DO NOT ALLOW THE EXCLUSION OR LIMITATION OF INCIDENTAL OR CONSEQUENTIAL DAMAGES SO THE ABOVE LIMITATION OR EXCLUSION MAY NOT APPLY TO YOU. THIS LIMITED WARRANTY GIVES YOU SPECIFIC LEGAL RIGHTS, AND YOU MAY ALSO HAVE OTHER RIGHTS THAT VARY FROM STATE TO STATE.

## FCC Statement

**FCC STATEMENT - CLASS A:** This equipment generates, uses and can radiate radio frequency energy, and if not installed and used in accordance with the instruction manual, may cause interference to radio communications. It has been tested and found to comply with the limits for a Class "A" computing device pursuant to Subpart B of Part 15 of the FCC Rules, which are designed to provide reasonable protection against such interference when operated in a commercial environment. Operation of this equipment in a residential area is likely to cause interference, in which case the user at his/her own expense will be required to take whatever measures may be required to correct the interference.

**FCC STATEMENT - CLASS B:** This equipment generates, uses and can radiate radio frequency energy and, if not installed and used in accordance with the instructions, may cause harmful interference to radio communications. However, there is no guarantee that interference will not occur in a particular installation. If this equipment does cause harmful interference to radio or television reception, which can be determined by turning the equipment off and on, the user is encouraged to try to correct the interference by one or more of the following measures:

- Reorient or relocate the receiving antenna.
- Increase the distance between the equipment and receiver.
- Connect the equipment into an outlet on a circuit different from that to which the receiver is connected.
- Consult the dealer or an experienced radio/TV technician for help.

**EEC STATEMENT:** This machine was tested against the 89/336/EEC (European Economic Community) for EMC (Electro Magnetic Compatibility) and fulfills these requirements.

## Shipping Contents

The Projector is shipped with the cables required for connection to standard PC or laptop computers. Carefully unpack and verify that you have all the items shown below. If any of these items are missing, please contact personnel at the place of purchase.

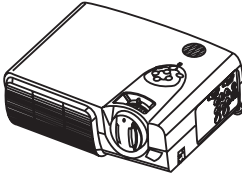

Projector



User's Guide



Quick Start Guide



Remote Control



3-2 Converter



Battery

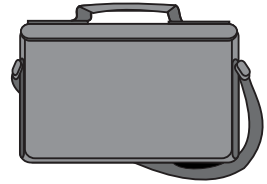

Deluxe Soft Carry Case

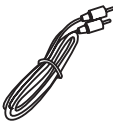

Audio Cable

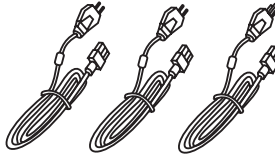

220V  
240V  
110V  
Power Cord

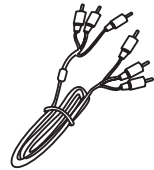

HDTV Component Cable



VGA Cable



USB Cable

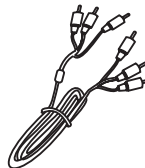

AV Cable



S-Video Cable

### Optional Accessories

1. Macintosh adapter
2. Spare lamp module



## Projector Description

### Projector

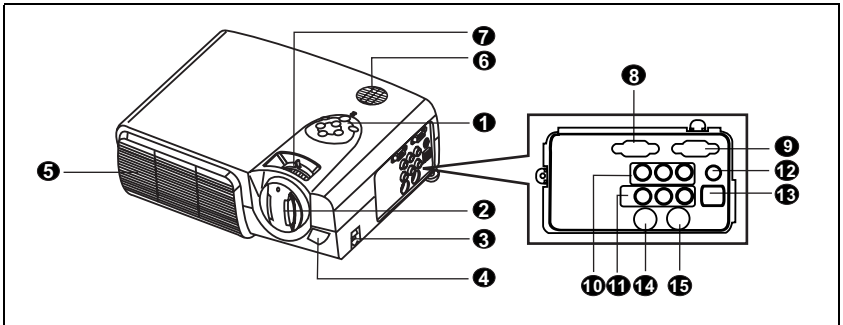

- |   |                          |
|---|--------------------------|
| ① External control panel<br>(see next page) | ⑪ Audio/ Video connector |
| ② Projection lens                           | ⑫ Audio jack             |
| ③ Front adjuster                            | ⑬ USB mouse connector    |
| ④ IR remote sensor                          | ⑭ S-Video jack           |
| ⑤ Ventilation grill                         | ⑮ RS 232 control port    |
| ⑥ Speaker                                   | ⑯ Rear adjuster feet     |
| ⑦ Projection lens adjuster                  | ⑰ Kensington lock        |
| ⑧ RGB signal input                          | ⑱ AC power cord inlet    |
| ⑨ RGB signal output                         | ⑲ Main power switch      |
| ⑩ YPBPR connector                           | ⑳ Lamp door              |

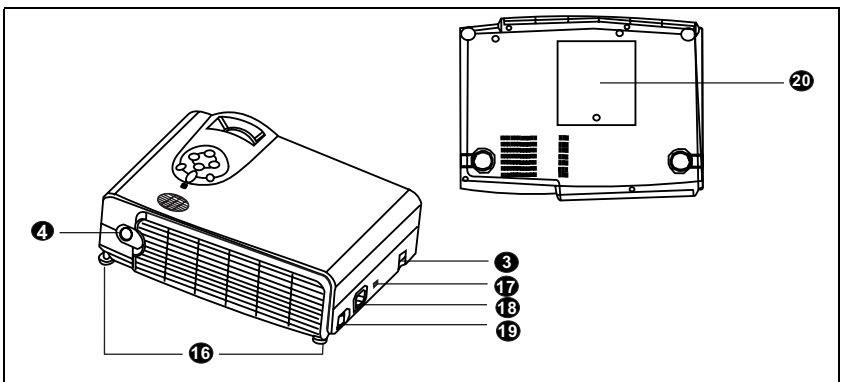

## External Control Panel

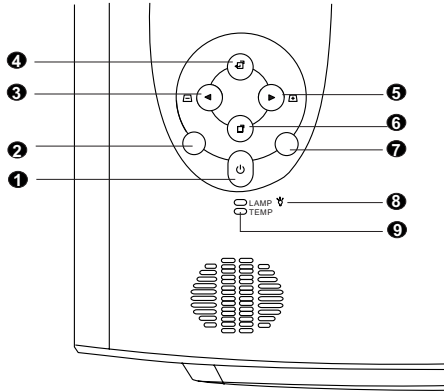

### 1 Power

Presses the **Power** key to turn the projector on or off.

### 2 Auto

Automatically determines the best picture settings for current received signals.

### 3 Left/ Keystone -

### 4 Exit

### 5 Right/ Keystone +

### 6 Menu

**Menu** will display the menu system on screen. Press **Menu** again to access the sub-menus. **Left** and **Right** help you navigate among choices and settings in the menus and sub-menus. However, when the on-screen menu is not activated, the **Left** and **Right** buttons will function as **Keystone +/-** hot keys.

Press the **Exit** button to go back to the main menu. Press **Exit** again to leave the menu system.

### 7 Source

Selects signal sources from among PC, Video, S-Video and YPBPR.

### 8 Lamp Indicator

The Lamp Indicator will light up when the lamp needs service, cooling or replacement. See "Lamp Information" on page 21 for more detailed information.

### 9 Temp indicator

The Temp indicator will flash when the system temperature is too high, which may occur if the projector is operated improperly. See "Temp Information" on page 23 for more detailed information.

## Adjuster

The projector is equipped with 2 quick-release adjuster feet. Push the buttons to adjust its tilt angle.

1. Lift the projector up and press the adjuster button to release the adjuster.
2. The adjuster will drop into position and be locked.

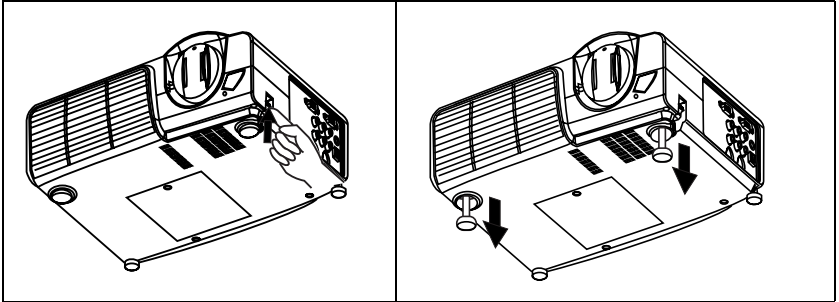

## Projector Features

The projector integrates high-performance optical engine projection and a user-friendly design to deliver high reliability and ease of use.

The projector offers the following features:

- Small and light for portability
- Full-function remote control with laser pointer/ remote mouse function
- High quality manual zoom lens
- One-key auto-adjustment to display the best picture quality
- Easy digital keystone correction through hot keys to correct distorted images
- Adjustable color balance control for data/video display
- Ultra-high brightness projection lamp
- Ability to display 16.7 million colors
- On-screen menus in 8 languages: English, French, German, Italian, Spanish, Korean, Simplified Chinese, and Traditional Chinese.
- Switchable Normal/ Video mode for data/ video display
- Powerful AV function to provide high quality AV picture
- HDTV compatibility (YPbPr)

**Note: The brightness of the projected image will vary depending on the ambient lighting conditions and contrast/brightness settings.**

## Remote Control Description

The remote control sensors are located in the front/ back of the projector. The distance between the sensor and the remote control should not exceed 6 meters (20 feet).

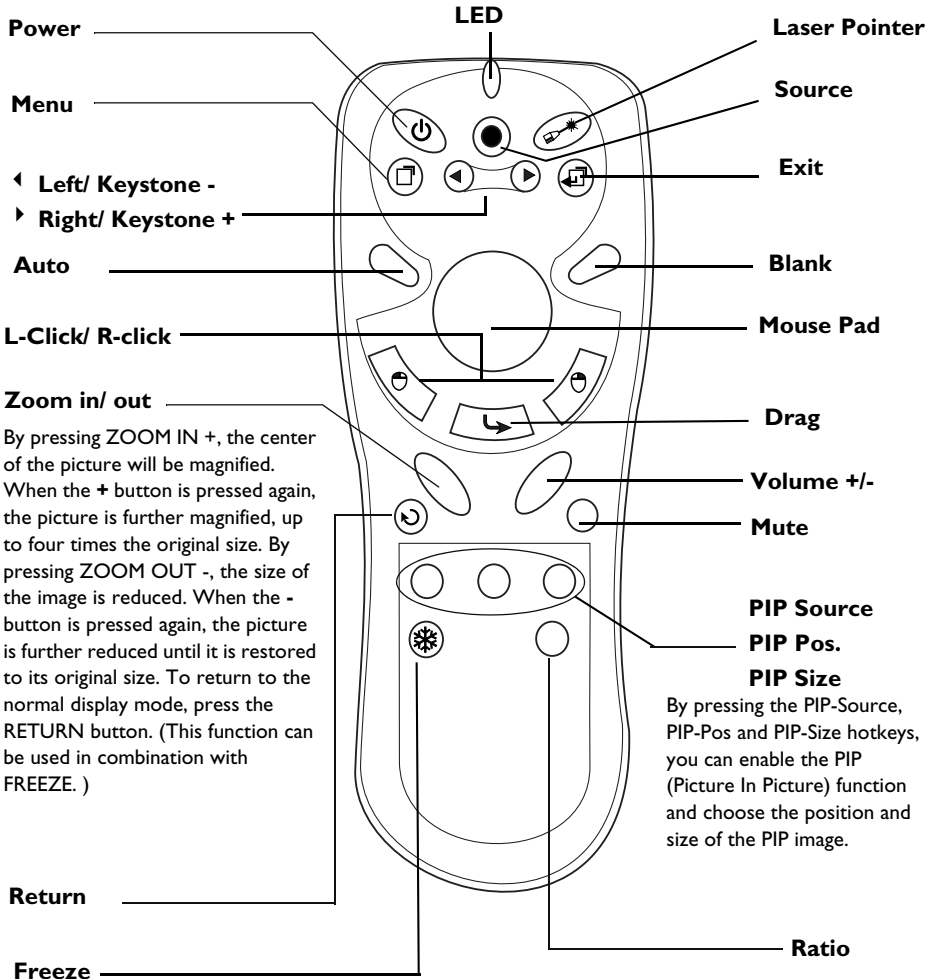

By pressing ZOOM IN +, the center of the picture will be magnified. When the + button is pressed again, the picture is further magnified, up to four times the original size. By pressing ZOOM OUT -, the size of the image is reduced. When the - button is pressed again, the picture is further reduced until it is restored to its original size. To return to the normal display mode, press the RETURN button. (This function can be used in combination with FREEZE.)

By pressing the PIP-Source, PIP-Pos and PIP-Size hotkeys, you can enable the PIP (Picture In Picture) function and choose the position and size of the PIP image.

By pressing the Ratio hotkey, you can select the screen aspect ratio you prefer: 4:3, 16:9

---

## Installing or Replacing Batteries

**1** Push and slide the battery compartment lid in the direction shown.

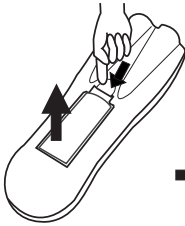

**2** Install batteries as indicated by the diagram inside the compartment.

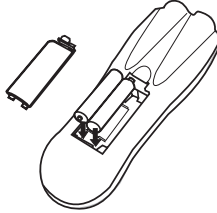

**3** Position the lid over the compartment and snap it back into place.

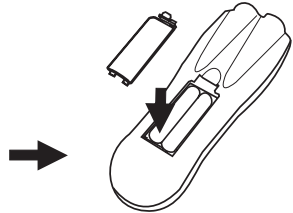

---

### **Caution**

**Avoid excessive heat and humidity. There may be danger of an explosion if batteries are incorrectly replaced. Replace only with the same or equivalent type recommended by the manufacturer. Dispose of used batteries according to the manufacturer's instructions.**

---

# INSTALLATION

## Screen Size

Place the projector at the required distance from the screen according to the desired picture size (see the table below).

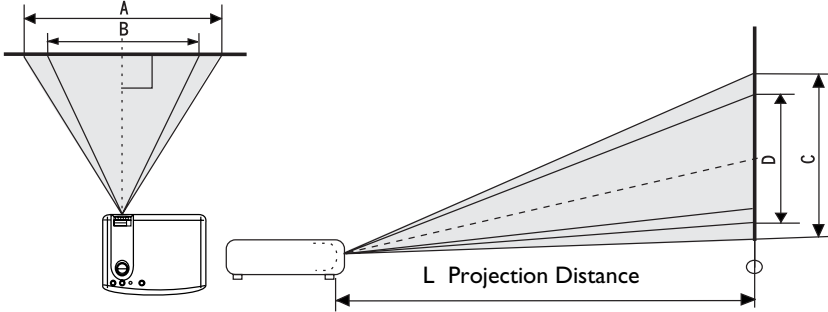

Screen Size (Max.) cm/in			L. Projection distance (cm/in)	Screen Size (Min.) cm/in	
Diagonal	A. Width	C. Height		B. Width	D. Height
30.4/12	61.8/24	46.3/18	100/39	50.7/20	38.0/15
60.8/24	123.65/49	92.7/36	200/79	101.3/40	76.0/30
91.2/36	185.3/73	138.9/55	300/118	151.9/60	113.9/45
121.5/48	247.0/97	185.2/73	400/157	202.5/80	151.9/60
151.9/60	308.7/122	231.6/91	500/197	253.2/100	189.9/75
182.3/72	370.5/146	277.9/109	600/236	303.8/120	227.9/90
213.1/84	432.2/170	324.18/128	700/276	354.4/140	266.2/105
243.1/96	494.0/194	370.5/146	800/315	405.1/160	303.8/120
273.5/108	555.7/219	416.7/164	900/354	455.7/180	341.8/135
303.9/120	617.5/243	463.1/182	1000/394	506.3/200	379.8/150

## Connecting to Various Equipment

### HDTV description

The projector is capable of displaying various High Definition TV display modes. Some of these sources are:

- Digital-VHS (D-VHS) player
- DVD player
- Satellite Dish HDTV receiver
- DTV tuners

Most of these sources will provide an analog component video output, a standard VGA output, or a YPBPR (default) format.

The projector is capable of accepting HDTV data through a YPBPR connector. Use the HDTV cable that came with your projector to display HDTV images.

The following standards are supported in the HDTV function:

- 480i
- 480p
- 720p
- 1080i

Please refer to "Menu System" on page 14 for information on the HDTV OSD selections.

## Connecting to Various Equipment

It only takes a few seconds to connect your projector to your desktop or notebook computer, VCR, or other systems. However, a Mac adapter (an optional accessory) is needed for connection to Macintosh computers.

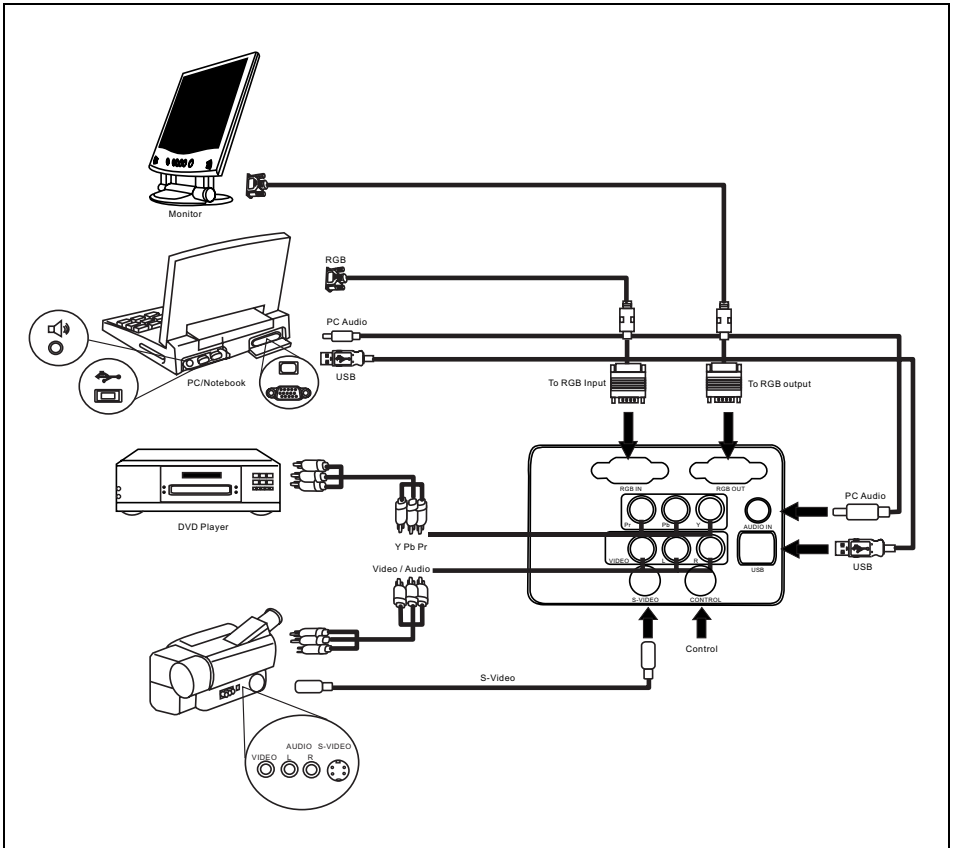

# OPERATION

## Start Up

1. Plug the power cord into a wall socket.

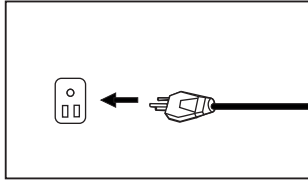

2. Turn on the main power switch.

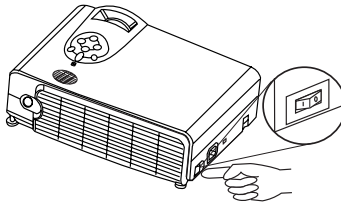

3. Press POWER to start the unit. The back-lit POWER key flashes green and stays green when the power is turned on.

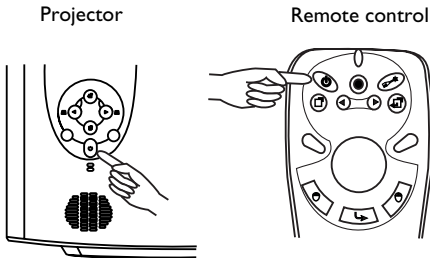

(When the power is turned off, there is a 60-second cooling period before the projector can be re-started.)

4. Switch on all connected equipment.



## Digital Keystone Correction

Keystoning refers to the situation where the projected image is noticeably wider at either the top or bottom. To correct this, press **KEYSTONE +/-** (hot key) on the control panel of the projector or on the remote control, and then adjust the sliding bar labeled **Keystone**, as needed. Press **+** to correct keystone at the top of the image. Press **-** to correct keystone at the bottom of the image.

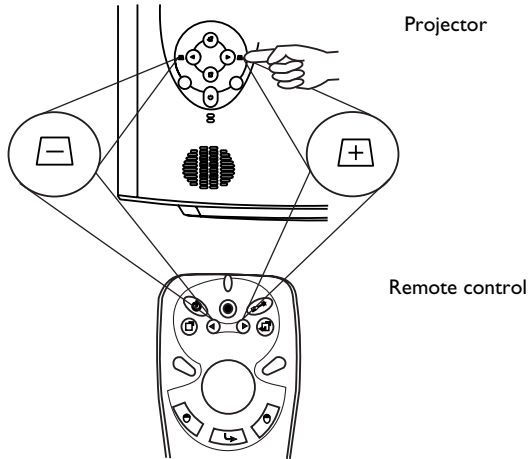

## Auto Adjustment

In some cases, you may need to optimize the picture quality. To do this, press the **AUTO** key on the control panel of the projector or on the remote control. Within 3 seconds, the built-in Intelligent Auto Adjustment function will re-adjust settings to provide the best picture quality.

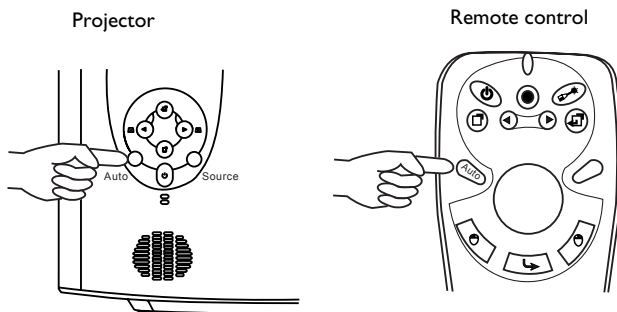

## Source Selection

When several input sources are available, press the SOURCE key to make a selection from the control panel of the projector or the remote control.

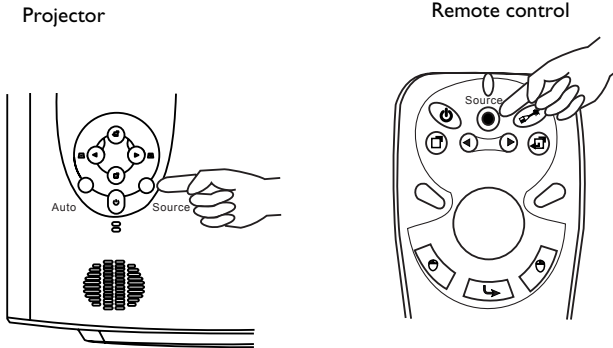



## Menu System

Press **Menu** for the main menu, and then press ◀ or ▶ to select a sub-menu. Press **Menu** again to select items in the sub-menu.

Menu Bar					
Sub-menu	Display	Image	Source	Control	PIP
<b>PC</b>	Keystone Brightness Contrast Phase H.Size	Ratio H-position V-position Color Temp Information	Mirror Source Volume Treble Bass Mute	Language OSD Setup Default Video Mode Lamp hour	Main page: PIP Source PIP Size PIP Pos. H. Position V.Position More Options  Sub Page: Brightness Contrast Color Tint Sharpness System
<b>Y/Pb/Pr</b>		Ratio H-position V-position Color Tint Color Temp			
<b>Video</b>		Ratio System Sharpness Color Temp Information			

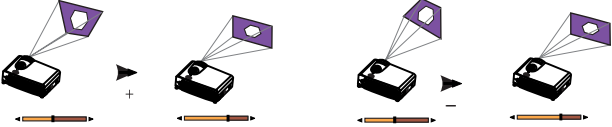
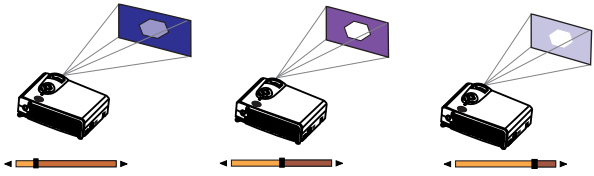
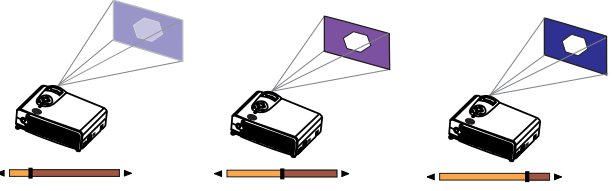



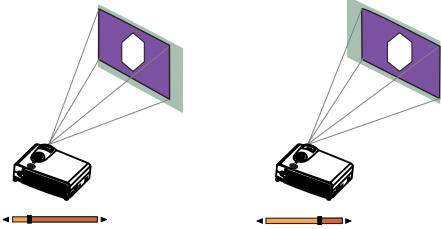
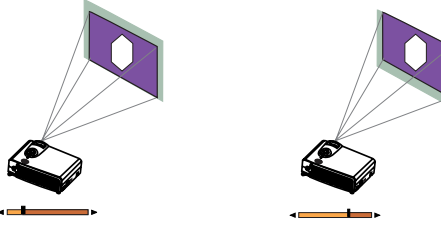

## I. Display Menu

FUNCTION	DESCRIPTION
<b>Keystone</b>	Corrects any keystone of the image. 
<b>Brightness</b>	Adjusts the brightness of the image. 
<b>Contrast</b>	Adjusts the degree of difference between dark and light in the image. 
<b>Phase</b>	Adjusts to avoid the occurrence of flicker.  <i>*This function is not available when the input mode is Video or S-Video.</i>
<b>H.Size</b>	Adjusts to fit in the desired image size. <i>*This function is not available when the input mode is Video or S-Video.</i>
<b>Color</b>	Increases or decreases the color range (R, G, B) of the image. <i>*This function is not available when the input mode is PC.</i>
<b>Tint</b>	Adjusts the image to make it appear more red or blue. <i>*This function is not available when the input mode is PC.</i>

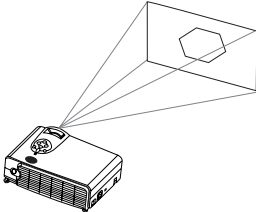
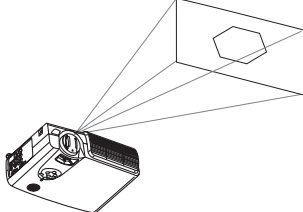
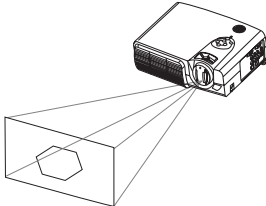
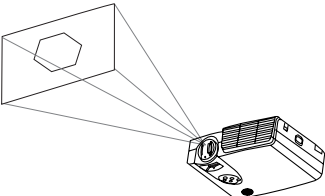
## 2. Image Menu

FUNCTION	DESCRIPTION
<b>Ratio</b>	Users have 3 options for the image ratio. 1. 1:1 2. 4:3 3. 16:9
<b>H-position</b>	Adjusts the horizontal position of the projected image. 
<b>V-position</b>	Adjusts the vertical position of the projected image. 
<b>Color Temp.</b>	Adjusts the color temperature to fit your preference.
<b>Information</b>	Shows the current resolution.
<b>System</b>	System information will be shown: 1. Auto 2.NTSC 3. PAL 4.SECAM <b>*The default setting for System is Auto.</b>
<b>Sharpness</b>	Adjusts the image to make it look sharper or softer. <b>*This function is not available when the input mode is PC or YPBPR.</b>
<b>Color</b>	Increases or decreases the color range (R, G, B) of the image. <b>*This function is not available when the input mode is PC.</b>
<b>Tint</b>	Adjusts the image to make it appear more red or blue. <b>*This function is not available when the input mode is PC.</b>

### 3. Source Menu

FUNCTION	DESCRIPTION	
<p><b>Mirror</b></p>	<p>1. Default</p>	<p>2. Ceiling mounted projection</p>
		
	<p>3. Rear screen projection</p>	<p>4. Ceiling mounted and rear-screen projection</p>
		
<p><b>Source</b></p>	<p>Selects the input source from among PC, Video, S-Video, and YPBPR.</p>	
<p><b>Volume</b></p>	<p>Adjusts the volume level.</p> 	
<p><b>Treble</b></p>	<p>Adjusts the treble level.</p> 	
<p><b>Bass</b></p>	<p>Adjusts the bass level.</p> 	
<p><b>Mute</b></p>	<p><b>Off</b></p> 	<p><b>On</b></p> 

### 4. Control Menu

FUNCTION	DESCRIPTION
<b>Language</b>	Language sets the language for the OSD control menus. Use the ◀ / ▶ key to select the desired language from among English, French, German, Italian, Spanish, Korean, Simplified Chinese and Traditional Chinese.
<b>OSD</b>	<b>OSD Pos.</b> Selects a desired OSD position.
	<b>OSD Time</b> Sets the length of time the OSD will remain active after the last time you pressed the button. The range is from 5 to 60 seconds in 5-second increments.
<b>Setup</b>	<b>Source scan</b> When selected, activates the Source scan function.
	<b>Keystone hold</b> When selected, preserves the last keystone correction value even when the projector is restarted.
	<b>Mirror hold</b> When selected, preserves the last mirror correction value even when the projector is restarted.
	<b>Blank time</b> Determines the length of time before the projector is shut off when Blank is activated.
	<b>Auto off</b> Sets the length of time before the system is shut off when no input is detected.
	<b>User logo</b> Enables the user to define the logo screen that will display during start-up. Three modes are available: Default (BOXLIGHT logo), black screen and blue screen.
<b>Default</b>	Returns all settings to their factory preset values.
<b>Video Mode</b>	Selects video mode.
<b>Lamp hour</b>	Shows lamp usage time.

## 5. PIP Menu

These functions are available only when the input mode is PC and the PIP source is Video or S-Video.

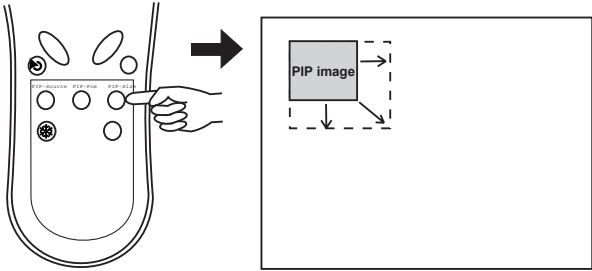
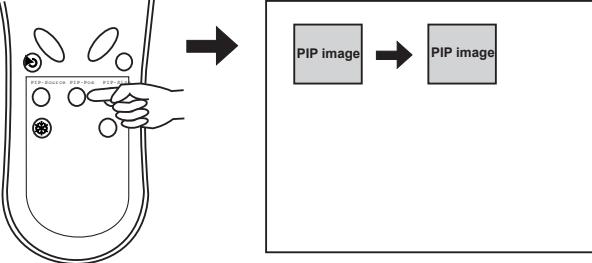
FUNCTION	DESCRIPTION
<b>PIP Source</b>	Selects the source for the PIP.
<b>PIP Size</b>	<p>Enables use of the ◀ / ▶ key to scroll through the four alternatives: Off, Small, Medium, Large.</p> 
<b>PIP Position</b>	<p>Selects a desired position for the PIP.</p> 
<b>H. Position</b>	Adjusts the horizontal position of the PIP image.
<b>V. Position</b>	Adjusts the vertical position of the PIP image.
<b>More Options</b>	Enables use of the ◀ / ▶ key to select more PIP functions including Brightness, Contrast, Color, Tint, Sharpness and System.
<b>Brightness</b>	Adjusts the brightness of the PIP image.
<b>Contrast</b>	Adjusts the degree of difference between dark and light for the PIP image.
<b>Color</b>	Increases or decreases the color range (R, G, B) of the image.
<b>Tint</b>	Adjusts the image to make it appear more red or blue.
<b>Sharpness</b>	Adjusts the image to make it appear sharper or softer
<b>System</b>	Selects PIP image systems: Auto, NTSC, PAL, SECAM

## Shutdown

1. Press **POWER** and a warning message will appear. To turn off the projector, press **POWER** again.

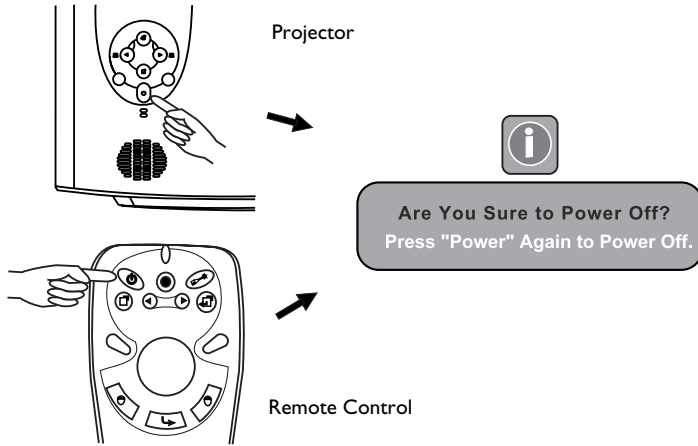

2. The fan will continue to run for approximately two minutes.
3. Turn off the main power switch.

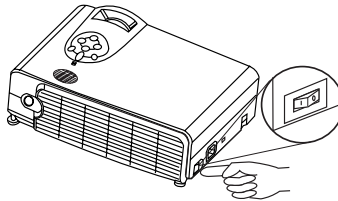

4. Disconnect the power cord from the wall socket.

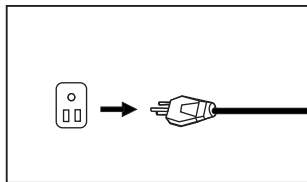

### **Caution**

**Please do not unplug the power cord before **POWER** is shut down or during the two-minute cooling process.**

**If the projector is not properly shut down, to protect the lamp, the system will detect this and cool the lamp for two minutes automatically before turning on again.**



# MAINTENANCE

## Lamp Information

### Use and Replacement of the Lamp

When the Lamp Indicator lights up red or a message appears suggesting the time of lamp replacement, please install a new lamp or consult your dealer. An old lamp could cause a malfunction in the projector and in rare instances may even explode.

### Lamp LED Indicators

<b>Lamp Life Indicators</b>	When the LED lights up red, it is warning you that lamp usage has exceeded 1500 hours. Replace the projection lamp with a new one immediately.
<b>The Lamp is not properly attached</b>	LED lights up red.
<b>The temperature is too high</b>	When the projector's internal temperature is too high for the projector to operate safely, the LED blinks orange and the lamp turns off automatically. The LED keeps blinking while the unit is off. If the LED light is off, the operation and temperature of the projector's lamp are normal.

### Caution

**The LAMP indicator will light up if the lamp becomes too hot. Turn off the power and let the projector cool for 45 minutes. If the LAMP indicator is still red when turning the power on, please contact BOXLIGHT Technical Support at 1-800-762-5757 or +1-360-779-7901.**

## Lamp Replacement

### **Caution**

To reduce the risk of electrical shock, always turn off the projector and disconnect the power cord before changing the lamp.

1. Press the **POWER** button to switch off the projector. Disconnect the power cord from the outlet and the projector.
2. Loosen the screw and remove the lamp cover. If the lamp is hot, avoid burns by waiting 45 minutes until the lamp has cooled.
3. Loosen the 3 screws. (It is strongly recommended that you use a magnetic-head screwdriver.) Pull the handle to remove the lamp housing. If the screws are not loosened completely, they could injure your fingers. Do not insert your hand into the box after the lamp is removed. If you touch the optical components inside, this could cause color unevenness in projected images.
4. Replace the lamp with a new one. Insert it into the projector, and tighten the screws firmly. Loose screws may cause a bad connection, which may result in malfunction.
5. Re-install the lamp cover and tighten the screw. **Do not turn on the power with the lamp cover removed.** Whenever the lamp is replaced, reset the total lamp operation time. **Do not reset if the lamp is not replaced as this could cause damage.**

#### Step 1

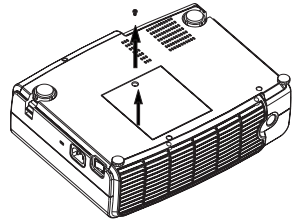

#### Step 2

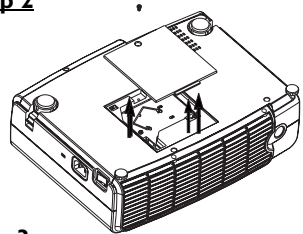

#### Step 3

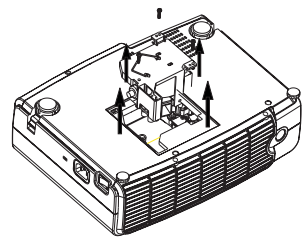

#### Step 4

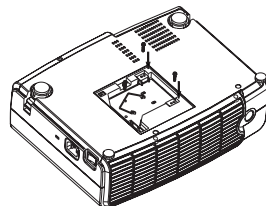

## Caution

To reduce the risk of severe burns, allow the projector to cool for at least 45 minutes before replacing the lamp.



To reduce the risk of injuries to fingers and damage to internal components, use caution when removing lamp glass that has shattered into sharp pieces.

To reduce the risk of injuries to fingers and/or compromising image quality by touching the lens, do not touch the empty lamp compartment when the lamp is removed.

This lamp contains mercury. Consult your local hazardous waste regulations to dispose of this lamp in a proper manner.

## Resetting Lamp Hours

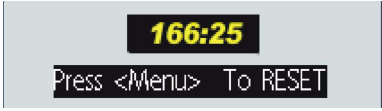
If you replace the lamp after 1500 hours of operation, please follow the instructions below within 10 minutes of powering on.

OSD	FUNCTION
	Press the Exit button on the projector for 3 seconds to display the total used lamp time.
	<ul style="list-style-type: none"> <li>• Press the MENU button on the projector during the lamp hour message. An adjustment message will appear.</li> <li>• Press ◀ or ▶ to reset lamp hours or press EXIT to leave.</li> </ul>

## Temp Information

When the LED lights up, it is warning you of the following possible problems:

1. The internal temperature is too high.
2. The fans are not working.

Turn off the projector and contact qualified service personnel for further help.

## Service Information

### Accessories (included in the Standard Package)

Power cord (EU)

Power cord (US)

Power cord (UK)

Signal cable

Video cable

S-Video cable

PC - PC audio cable

Soft carrying case

HDTV cable

USB mouse cable

Remote control

3-2 converter

### Optional Accessories (not included in the Standard Package)

#### Description of parts

Mac adapter (switchable)

210W lamp module

### Ordering Parts or Getting Information

For product information, product assistance, service information, or to order accessories, please contact BOXLIGHT corporation at 1-800-762-5757 or +1-360-779-7901 or visit the web site at [www.boxlight.com](http://www.boxlight.com).

# TROUBLESHOOTING

## Common Problems & Solutions

PROBLEMS	TRY THESE SOLUTIONS
<b>NO POWER</b>	<ul style="list-style-type: none"> <li>• Make sure the power cord is inserted snugged into the AC adapter socket.</li> <li>• Make sure the power cord is inserted snugged into the power outlet.</li> <li>• Toggle the power switch to the position "I".</li> <li>• Wait two minutes after the projector is turned off before turning the projector back on.</li> </ul>
<b>NO PICTURE</b>	<ul style="list-style-type: none"> <li>• Check for the proper input source.</li> <li>• Ensure all cables are connected properly.</li> <li>• Adjust the brightness and contrast.</li> <li>• Remove the lens cap.</li> </ul>
<b>TRAPEZOID IMAGE ON THE SCREEN</b>	<ul style="list-style-type: none"> <li>• Reposition the unit to improve its angle on the screen.</li> <li>• Use the <b>Keystone</b> correction key on the control panel of the projector or the remote control unit.</li> </ul>
<b>POOR COLOR</b>	<ul style="list-style-type: none"> <li>• Select the correct video system.</li> <li>• Adjust brightness, contrast, or saturation.</li> </ul>
<b>BLURRED IMAGE</b>	<ul style="list-style-type: none"> <li>• Press <b>Auto</b> on the control panel of the projector or the remote control unit to get better picture quality.</li> <li>• Adjust the focus.</li> <li>• Reposition the unit to improve its projection angle.</li> <li>• Ensure the distance between the unit and screen is within the adjustment range of the lens.</li> </ul>
<b>REMOTE CONTROL DOES NOT WORK</b>	<ul style="list-style-type: none"> <li>• Replace the batteries with new ones.</li> <li>• Make sure there is no obstacle between the remote control and the projector.</li> <li>• Stand within 4 meters (13 feet) of the projector.</li> <li>• Make sure nothing is blocking the front and rear receivers.</li> </ul>

## Status Messages

On-Screen Messages	Description
<b>SEARCHING</b>	Projector is searching for input.
<b>ACQUIRING SIGNAL</b>	Projector has identified the input signal and is running the auto image adjustment function.
<b>OUT OF RANGE</b>	Input signal frequency exceeds the projector's range.
<b>LAMP WARNING - CHANGE LAMP AND RESET LAMP TIMER!</b>	The lamp has been in operation for 1400 hours. Install a new lamp for optimal performance.
<b>OUT OF LAMP USAGE TIME. CHANGE THE LAMP!</b>	The lamp has been in operation for 1480 hours, and the power will turn off after 20 hours.
<b>OUT OF LAMP USAGE TIME. YOU HAVE TO CHANGE THE LAMP!</b>	The lamp has been in operation for over 1500 hours. The warning message will display for 30 seconds every 5 minutes after you turn on the projector and the power will turn off automatically after 10 minutes.

# SPECIFICATIONS

## Projector Specifications

### Technical Specifications

**Note: All specifications are subject to change without notice.**

#### General

Product name	Personal Projector	
Model name	DX660/650	1024X768 XGA
	DS660/650	800X600 SVGA

#### Optical

Display system	1-CHIP DMD
Lens F/Number	F/2.6
Lamp	210W NSH lamp

#### Electrical

Power supply	AC100 ~ 240V, 3.5A, 50/60 Hz (Automatic)
Power consumption	330 W (Max)

#### Mechanical

Dimensions	308 mm (W) x 95 mm (H) x 238 mm (D)
Operating temperature range	10°C ~ 40°C
Weight	6.9 lbs (3.1 Kg)

#### Input terminal

Computer input	
RGB input	D-sub 15-pin (female)
Video signal input	
S-VIDEO	Mini DIN 4-pin port x1
VIDEO	RCA jack x1
HDTV signal input	YPbPr RCA jack x3
Audio signal input	
Audio 1	Mini jack stereo port
Audio 2	RCA jack L, R x2

#### Output

USB mouse connector	A/B series x1
Speaker	2 watt x 1

#### Control

RS-232C	9-pin x1
---------	----------

## Timing Chart

Resolution	H Sync (kHz)	V Sync (Hz)	Remark
640x350	31.5	70.1	
640x400	37.9	85.1	VESA
720x400	31.5	70.0	
720x400	37.9	85.1	VESA
640x480	31.5	60.0	VESA
640x480	37.9	72.8	VESA
640x480	35	66.7	Macintosh
640x480	43.3	85.0	VESA
800x600	35.2	56.3	VESA
800x600	37.9	60.3	VESA
800x600	46.9	75.0	VESA
800x600	48.1	72.2	VESA
800x600	53.7	85.1	VESA
832x624	49.7	74.5	Macintosh
1024x768	48.4	60.0	VESA
1024x768	56.5	70.1	VESA
1024x768	60.0	75.0	VESA
1024x768	68.7	85.0	VESA
1280x1024	64.0	60.0	VESA



# DIMENSIONS

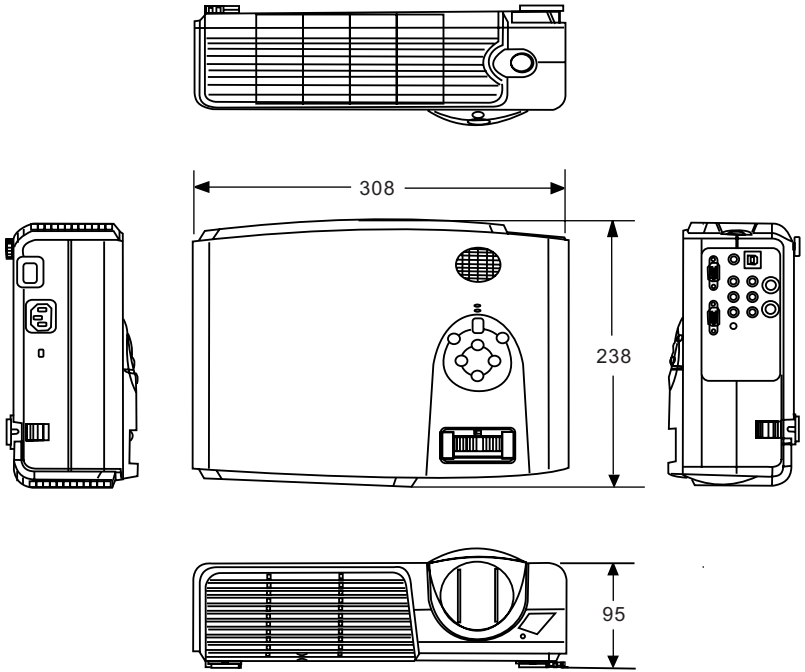

Unit: mm

## Free Manuals Download Website

<http://myh66.com>

<http://usermanuals.us>

<http://www.somanuals.com>

<http://www.4manuals.cc>

<http://www.manual-lib.com>

<http://www.404manual.com>

<http://www.luxmanual.com>

<http://aubethermostatmanual.com>

Golf course search by state

<http://golfingnear.com>

Email search by domain

<http://emailbydomain.com>

Auto manuals search

<http://auto.somanuals.com>

TV manuals search

<http://tv.somanuals.com>