

USER'S GUIDE



BOXLIGHT CD-40m



19332 Powder Hill Place
Poulsbo, WA 98370-7407 USA

www.boxlight.com

Direct Phone:

USA: (360) 779-7901

Europe: +44 (0) 1732-840-404

Free phone within these areas:

United Kingdom: 0800-762-575

Germany: 0800-180-8381

France: 0800-9132-88

USA and Canada: 800-762-5757

FCC Warning

This equipment has been tested and found to comply with the limits for a Class A digital device, pursuant to part 15 of the FCC Rules. These limits are designed to provide reasonable protection against harmful interference when the equipment is operated in a commercial environment. This equipment generates, uses, and can radiate radio frequency energy and, if not installed and used in accordance with the instruction manual, may cause harmful interference to radio communications. Operation of this equipment in a residential area is likely to cause harmful interference in which case the user will be required to correct the interference at his own expense.

DOC (Canada)

This Class A digital apparatus meets all requirements of the Canadian Interference-Causing Equipment Regulations.

Cet appareil numérique de la classe A respecte toutes les exigences du Règlement sur le matériel brouilleur du Canada.

Safety Certifications

UL, CUL, TÜV, NOM

EN 55022 Warning

This product is intended for use in a commercial, industrial, or educational environment. It is not intended for residential use.

This is a Class A product. In a domestic environment it may cause radio interference, in which case the user may be required to take adequate measures. The typical use is in a conference room, meeting room or auditorium.

Wenn das Produkt CD-40m in Deutschland verkauft wird, muss es Umwelt geschuetzt sein. (Klasse B) Dieses Product muss mit dem Bundesamt fuer Post und Telekommunikation registriert sein. (BAPT)

Declaration of Conformity

Boxlight

19332 Powder Hill Place, Poulsbo, Washington, 98370-7407, USA

We declare under our sole responsibility that the CD-40m Projector conforms to the following directives and norms:

Directive 89/336/EEC, Amended by 93/68/EEC

EMI: EN 55022 (1992) Class A

EMC: EN 50082-1 (1992)

IEC 801-2, IEC 801-3, IEC 801-4

Directive 73/23/EEC, Amended by 93/68/EEC

Safety: EN 60950: 1992 + A1 + A2 + A3: 1995

February, 1999

Trademarks

Apple, Macintosh, and PowerBook are trademarks or registered trademarks of Apple Computer, Inc. IBM and PS/2 are trademarks or registered trademarks of International Business Machines, Inc. MicroSaver and Kensington are trademarks or registered trademarks of Kensington Microware Limited. Microsoft, PowerPoint, and Windows are trademarks or registered trademarks of Microsoft Corporation. Digital Light Processing is a trademark or registered trademark of Texas Instruments. CablePro is a trademark or registered trademark of Boxlight.

TABLE OF CONTENTS

Safety Instructions	iii
Introduction	1
Image Resolution	1
Compatibility	1
Unpacking the Projector	1
Usage Guidelines	3
If You Need Assistance	4
Warranty	4
Setting up the Projector	5
Connecting an IBM-Compatible Computer	7
Connecting a Macintosh Computer	8
Connecting a Video Player	9
Powering up the Projector and Adjusting the Image	11
Turning Off the Projector	12
Using the Projector	13
Basic Image Adjustment	13
Adjusting the Projector	13
Using the Keypad Buttons	15
Using the On-Screen Menus	17
Display Menu	18
Audio Menu	20
Image Menu	21
Controls Menu	23
Language Menu	25
Status Menu	26
Maintenance & Troubleshooting	29
Cleaning the Lens	29
Replacing the Projection Lamp	29
Using the Kensington Lock	32
Troubleshooting	33

Appendix	37
Specifications	37
Accessories	39
Portable and Laptop Activation Chart	41
Using Video Mirroring with a PowerBook Computer	46
Projected Image Size	47
Index	49

SAFETY INSTRUCTIONS

Please read and follow all safety instructions provided BEFORE using your new projector. Failure to comply with safety instructions may result in fire, electrical shock, or personal injury and may damage or impair protection provided by equipment. Please save all safety instructions.

Safety Definitions:

- **Warning:** Statements identify conditions or practices that could result in permanent personal injury.
- **Caution:** Statements identify conditions or practices that could result in damage to your equipment.

Safety Symbols:



Attention: For information about usage of a feature, please refer to the User's Guide.



Warning: Hot surface. Do not touch.



An arrow pointing to the lamp door on the projector.

Safety Terms:

- **Warning:** Don't look directly into the lens when the projector is turned on.
- **Warning:** Don't block ventilation openings.
 - **Warning:** To replace the lamp, turn the power off and unplug the power cord. To avoid burns, wait 30 minutes before opening the lamp door. Follow all instructions provided in this User's Guide.
 - **Warning:** Please use the power cord provided. Connect the power cord to a receptacle with a protective safety (earth) ground terminal.
- **Warning:** Refer all service to qualified service personnel. Servicing your own projector will void the warranty. See the following page for the customer service contact information.

- **Caution:** Don't set liquids on the projector. Spilled liquids may damage your projector.
- **Caution:** Don't place the projector on a hot surface or in direct sunlight.
- **Caution:** Do not drop the projector. Transport the projector in a Boxlight-approved case; see page 40 for a list of cases.
- **Caution:** For ceiling mount installations, please use the ceiling mount recommended in this User's Guide on page 40 and follow all instructions provided with it.

Customer Service

If you need assistance, call Boxlight at 1-800-762-5757 or 360-779-7901.

INTRODUCTION

The Boxlight CD-40m™ is specifically designed for the mobile presenter. It packs SVGA graphics with 16.7 million colors into a small, 6.8 pound package. It generates crisp, clear images using Digital Light Processing™ (DLP) technology. The projector is easy to connect, easy to use, and easy to maintain.

Image Resolution

The SVGA resolution of the CD-40m's projected image is 800x600. Screen resolutions between 800x600 and 1024x768 are compressed to 800x600. The projector cannot compress screen resolutions above 1024x768. If your computer's screen resolution is higher than 1024x768, reset it to a lower resolution before you connect the projector.

Compatibility

The projector is compatible with a wide variety of computers and video devices, including:

- IBM-compatible computers, including laptops, up to 1024x768 resolution.
- Apple Macintosh and PowerBook computers up to 1024x768 resolution.
- Most standard VCRs, DVD players, camcorders and laser disc players.

Unpacking the Projector

The projector comes with the items shown in Figure 1. Check to make sure all are included. **Contact Boxlight immediately if anything is missing.**

If you are experienced in setting up presentation systems, use the *Quick Start* card that was included in the shipping box. For complete details on connecting and operating the projector, refer to this User's Guide.



***NOTE:** The projector automatically expands 640x480 images to 800x600. You can display these images at 640x480 by turning off the Auto Resize feature. See "Auto Resize" on page 21 for more information.*



***NOTE:** The projector ships standard with computer and audio cables. If you want to control your computer's mouse from the projector, you must order the optional CablePro and remote.*



NOTE: The contents of your shipping box may vary depending on the projector configuration you've ordered.

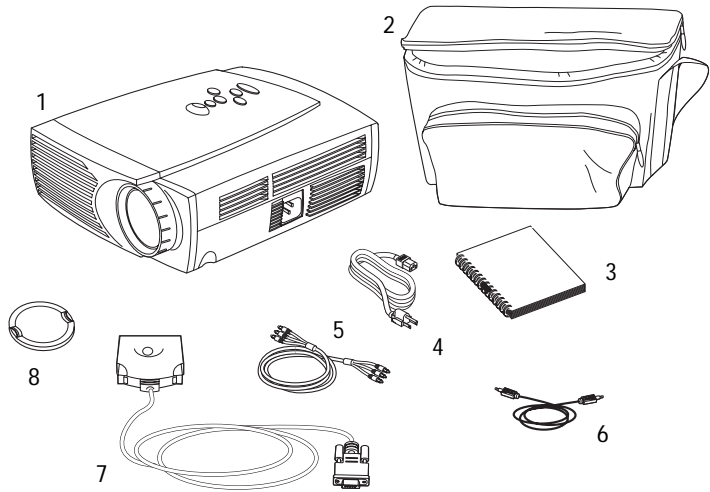

FIGURE 1

Shipping box contents

- | | |
|------------------------|--------------------------------|
| 1. CD-40m projector | 5. RCA audio/video (A/V) cable |
| 2. Soft carry case | 6. Audio cable |
| 3. CD-40m User's Guide | 7. CablePro Lite cable |
| 4. Power cord | 8. Lens cap |

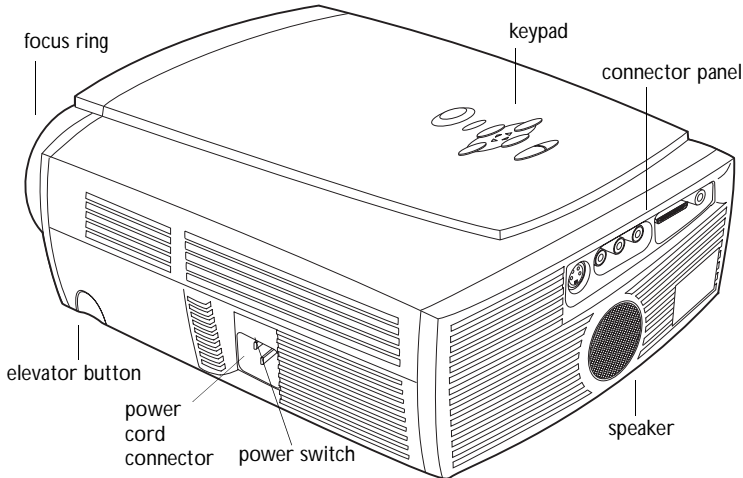

FIGURE 2

Side view of projector

Usage Guidelines

- Do not look directly into the projection lens when the projector is turned on. The bright light may harm your eyes.
- Do not block the grills on the projector. Restricting the air flow can cause it to overheat and turn off. If this happens, you must wait a minute before attempting to turn it back on.
- Handle the projector as you would any product with glass components. Be especially careful not to drop it.
- Avoid leaving the projector in direct sunlight or extreme cold for extended periods of time. If this happens, allow it to reach room temperature before use.
- This projector is not intended for use in mainframe computer rooms as defined in the Standard for the Protection of Electronic Computer/Data Processing Equipment, ANSI/NFPA 75.
- Transport the projector in a vendor-approved hard or soft case. Call Boxlight to order.

If You Need Assistance

The first place to look for help is in this manual. Be sure to check the guidelines in “Troubleshooting” on page 33.

If those sources don’t answer your question, call Boxlight at 1-800-762-5757.

Warranty

This product is backed by a limited two-year warranty. The details of the warranty are printed at the back of this manual.

SETTING UP THE PROJECTOR

- 1 Place the projector on a flat surface.
 - The projector must be within 10 feet (3 m) of your power source and within 6 feet (1.8 m) of your computer.
 - If you want to project from behind a translucent screen, set up the projector behind your screen. See “Rear Projection” on page 24 to reverse the image.
- 2 Position the projector the desired distance from the screen.
 - The distance from the lens of the projector to the screen determines the size of the projected image. Figure 3 shows three projected image sizes. For more information about image size, see “Projected Image Size” on page 47.
- 3 Make sure the projector and your computer are turned off.

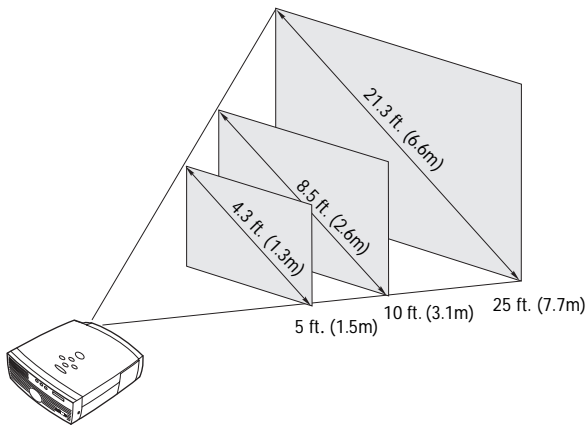

FIGURE 3

Projected image size



NOTE: Before you continue, make sure the projector and your equipment are turned off. If you're connecting a computer, make sure the distance between it and the projector is 6 feet or less.

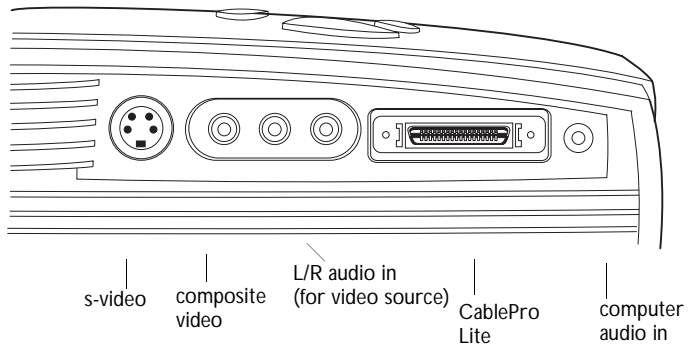





FIGURE 4

Connector panel

Connecting an IBM-Compatible Computer

- 1 Plug the  end of the CablePro Lite computer cable into the video connector on your computer.
- 2 Plug the  end of the CablePro Lite computer cable into the  connector on the projector.

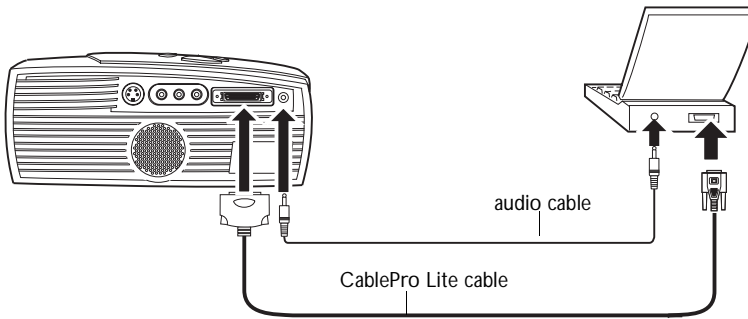



FIGURE 5

Connecting the computer cable to an IBM-compatible computer

Do you want to play your computer's audio on the projector?

- 1 Plug either end of the audio cable into the audio connector on your computer.
- 2 Plug the other end of the audio cable into the  connector on the projector.



NOTE: Many laptop computers do not automatically turn on their external video port when a secondary display device such as a projector is connected. Refer to your computer manual for the command that activates the external video port. Activation commands for some laptop computers are listed in the Appendix of this manual on page 41.



NOTE: If you are connecting a desktop computer and want to view your presentation on your monitor, purchase the optional CablePro.



NOTE: If you want to control your computer's mouse from the projector, purchase the optional CablePro and remote.



NOTE: Some PowerBooks require the Apple-supplied video-out cable or monitor adapter for external video. Connect it between the PowerBook and the CablePro Lite computer cable/Mac adaptor as shown in Figure 6.





NOTE: If you are connecting a desktop computer and want to view your presentation on your monitor, purchase the optional CablePro.



NOTE: If you want to control your computer's mouse from the projector, purchase the optional CablePro and remote.

Connecting a Macintosh Computer

- 1 Plug the  end of the CablePro Lite computer cable into the video connector on your computer (you may need a Mac adaptor, ordered separately).
- 2 Plug the CablePro Lite/Mac adaptor into the video connector on your computer (or the Apple video-out cable or monitor adapter, if needed).
- 3 Plug the  end of the CablePro Lite computer cable into the  connector on the projector.
- 4 If you want the projector display to be the same as the PowerBook's screen display, turn on video mirroring (called SimulScan in newer PowerBooks). See "Using Video Mirroring with a PowerBook Computer" on page 46 for additional information.

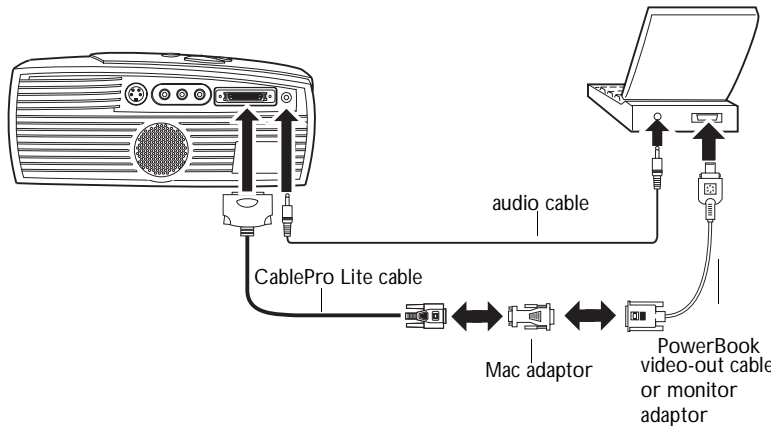



FIGURE 6

Connecting the CablePro Lite computer cable to a Macintosh

Do you want to play your computer's audio on the projector?

- 1 Plug either end of the audio cable into the audio connector on your computer.
- 2 Plug the other end of the audio cable into the  connector on the projector.

Connecting a Video Player

- 1 If your video player uses a round, one-prong composite video connector, you'll need only the A/V cable that shipped with the projector.
 - If your video player uses a round, four-prong S-video connector, you'll need an S-video cable in addition to the A/V cable. The S-video cable is sold separately. (See "Optional Accessories" on page 40.)
- 2 Plug the A/V cable's yellow connector into the "video-out" port on your video player (Figure 7). This port may be labeled "To Monitor."
- If you're using an S-video cable, connect it to the "s-video out" connector on the video player (Figure 8).
- 3 Plug the other yellow connector into the composite connector on the back of the projector.
 - If you're using S-video, plug the other end of the cable into the "s-video" connector on the projector (Figure 8).

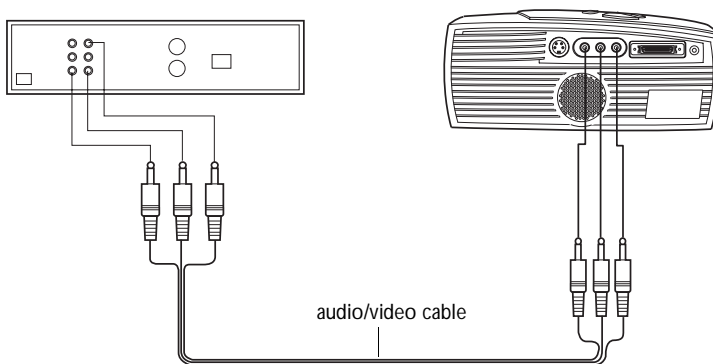

FIGURE 7

Connecting the projector to a video player using the standard A/V cable (with composite video connector)

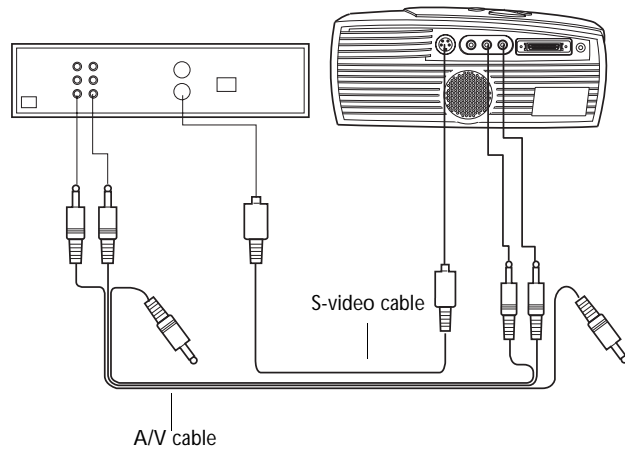

FIGURE 8

Connecting the projector to a video player using an S-video cable and the audio connectors on the standard A/V cable

4 Plug the A/V cable's white connector into the left "audio out" port on your video player. Plug the cable's red connector into the right "audio out" port on the video player (Figure 7 and Figure 8).

- If you're using an S-video cable, the yellow connectors on the A/V cable remain unused (Figure 8).

5 Plug the A/V cable's other white and red connectors to the left and right "audio in" ports on the projector.

The projector is compatible with these major broadcast video standards: NTSC, NTSC 4.43, PAL, PAL-M, PAL-N, and SECAM. It automatically adjusts to optimize its performance for the incoming video. The input signals for SECAM, PAL-M, and PAL-N video are similar to other video signals and cannot be automatically detected, therefore they must be chosen manually. See "Video Standard" on page 23 for details.



CAUTION: Your video player may also have a "Video Out" port for a coaxial cable connection. **DO NOT** use this to connect to the projector.

Powering up the Projector and Adjusting the Image

- 1 Remove the lens cap.
- 2 Plug the power cord into the side of the projector, then plug it into your electrical outlet. A surge-protected power strip is recommended.
- 3 Turn on the projector by pressing the “I” side of the power switch (see Figure 2 on page 3).
 - The startup screen displays and the Power LED on top of the projector lights up (Figure 11 on page 15).
- 4 If you connected a video player, turn it on.
 - The video image should display on the projection screen. If a computer source is active, press the source button on the keypad (page 15) to display your video image. You can select a default source to determine which source the projector examines first during power-up for active video; see “Default Source” on page 24.
 - Use the volume buttons to adjust the volume.
- 5 Turn on your computer.
 - The computer image should display on the projection screen. (If a video source is active, press the source button to display your computer’s image.)
 - If necessary, make adjustments to the image from the projector’s on-screen menus. To open the menus, press the menu button on the keypad, then select the Display or Image sub-menu. For more information about the menus, see page 17.



NOTE: Always use the power cord that shipped with the projector.



NOTE: With some computers, the order in which you power up the equipment is very important. Most computers should be turned on last, after all other peripherals have been turned on. Refer to your computer’s documentation to determine the correct order.

Turning Off the Projector

If you want to turn off the projector for a short period of time, press the standby button on the keypad. This blanks the screen for fifteen minutes, but keeps the projector running. (You can change the amount of time the projector stays in standby mode; see “Standby Time” on page 23 for details.) After 15 minutes, the lamp goes out (the projector keeps running). To exit standby mode, press the standby button again. (It may take several seconds for the projection lamp to reach full power and project the image again.)

To completely power off the projector, press the “O” side of the power switch on the side of the projector. If you want to turn the projector back on immediately, you must allow about a minute for the lamp to cool. The lamp won’t light if it’s too hot.



CAUTION: *When you disconnect the projector after you have switched it off, always remove the power cord from the electrical outlet first, then remove it from the projector.*

USING THE PROJECTOR

This section describes how to use and make adjustments to the projector. It also provides a reference to the keypad buttons and the options available from the on-screen menus.

Basic Image Adjustment

- 1 Make sure you have powered up your equipment in the right order (page 11).
- 2 If the image doesn't display completely, adjust the height of the projector (page 14) or center the image by adjusting its horizontal or vertical position (page 22). Be sure the projector is at a 90 degree angle to the screen.
- 3 If the image is out of focus, rotate the focus ring (Figure 9).
- 4 If the image appears to shimmer or if it has blurry vertical bars after you have adjusted the focus, turn Auto Image (page 21) off and then back on to reset the automatic sync and tracking. If that doesn't clear up the image, turn Auto Image off and adjust the sync (page 21) and/or the tracking (page 22) manually.
- 5 If the colors don't look right, adjust the brightness (page 18).

Adjusting the Projector

To focus the image, rotate the focus ring (Figure 9) until the image is clear.

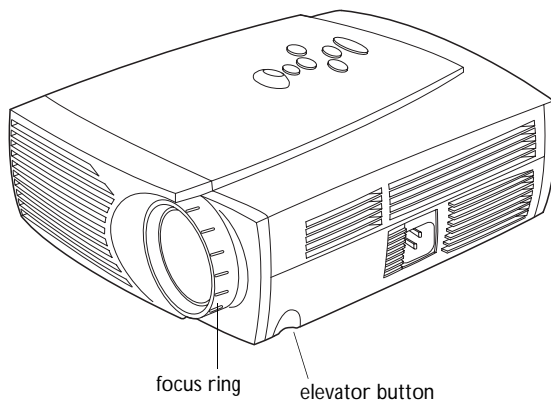

FIGURE 9

Focus ring and elevator button

The projector is equipped with a self-locking, quick-release elevator foot and button (Figure 10).

To raise the projector:

- 1 Press and hold the elevator button (Figure 9).
- 2 Raise the projector to the height you want, then release the button to lock the elevator foot into position.

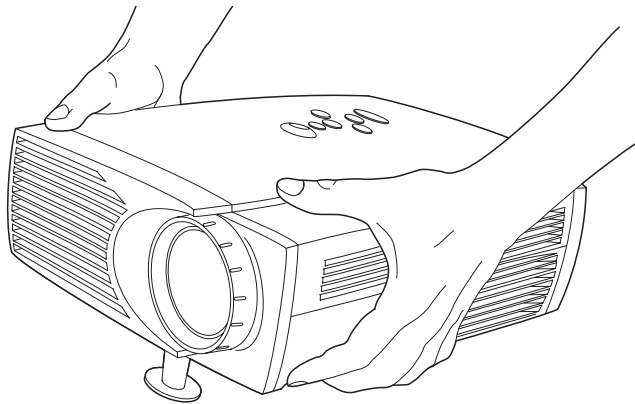

FIGURE 10

Adjusting the height of the projector

To lower the projector:

- 1 Press the elevator button.
- 2 Lower the projector.

Using the Keypad Buttons

The keypad is lit orange when the projector is on and lit green while the menus are displayed. While the menus are displayed, the volume, source, and standby buttons act as navigation buttons. See “Using the On-Screen Menus” on page 17 for details.

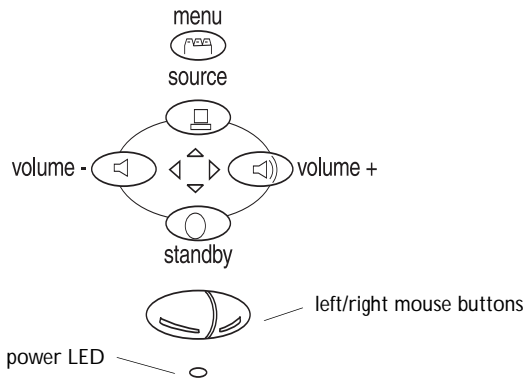

FIGURE 11

Keypad

Menu

Press menu to open the on-screen menus (the keypad lights green). Press menu again to close the menus. When you close the menus, the projector saves any changes you made. For more information about the on-screen menus, see page 17.

Mouse buttons

Use the left and right mouse buttons to make selections and adjustments in the menus. See “Using the On-Screen Menus” on page 17 for details.

Source



When you have more than one source (computer and video) connected to the projector, select between them by pressing the source button.

Standby

When you press **standby**, the display and audio turn off and a blank screen is displayed for 15 minutes. You can change the amount of time the projector stays in standby mode; see “Standby Time” on page 23 for details.

- If you press **standby** again within 15 minutes, the projector returns to normal operations immediately.
- If you press **standby** again after 15 minutes, there is about a 30 second delay before the lamp turns back on.
- If you don't press **standby** again, the lamp turns off after 15 minutes.

Volume

- To increase the volume, press 
- To decrease the volume, press 

Volume adjustments are saved for each source you have connected.

Using the On-Screen Menus

The projector has six drop-down menus that allow you to make image adjustments and change a variety of settings. Most of these adjustments aren't available directly from the keypad.

To open the on-screen menus, press the menu button on the keypad. This changes the volume, source, and standby buttons on the keypad to menu navigation buttons (and illuminates the keypad green). Press the corresponding buttons to move the cursor up, down, left, or right. To select a menu, move the cursor left and right to highlight the menu you want. The drop-down menu appears.

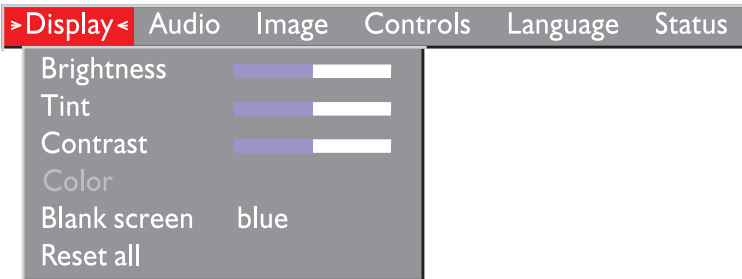

FIGURE 12

Drop-down menu

To change a menu setting, use the up and down arrow keys on the keypad to move the cursor up and down to the item you want to change (the selected item is highlighted red), then use the left and right mouse buttons (not the left and right arrow buttons) to adjust a setting. Some submenus, such as Brightness, consist of a slider bar you use to increase or decrease a value; some submenus, such as Standby Time, consist of options you scroll through to select the desired one. All changes are saved when you close the menu.

To access another menu, use the left and right arrow buttons to move left or right to another menu.



NOTE: Some menu items may be grayed out at certain times. This indicates the item is not applicable to your setup (for example, video standards do not apply to computer sources) or the item is not enabled until another selection is made (for example, Manual Tracking is not available until Auto Image is turned off).

Display Menu

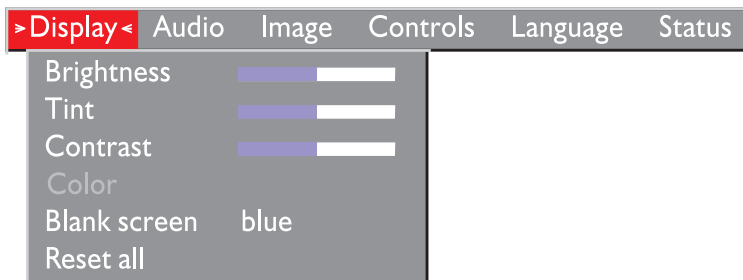

FIGURE 13

Display menu

Brightness

Adjusting the brightness changes the intensity of the image.

- Press the left mouse button to darken the image.
- Press the right mouse button to lighten the image.

Tint

The tint adjusts the red-green color balance in the projected image. Changing the Tint setting has no effect on PAL or SECAM video sources.

- Press the left mouse button to increase the amount of green in the image.
- Press the right mouse button to increase the amount of red in the image.

Contrast

The contrast controls the degree of difference between the lightest and darkest parts of the picture. Adjusting the contrast changes the amount of black and white in the image.

- Press the left mouse button to decrease the contrast.
- Press the right mouse button to increase the contrast, making the blacks appear blacker and the whites appear whiter.

Color

The color setting adjusts a video image from black and white to fully saturated color.

- Press the left mouse button to decrease the amount of color in the image.
- Press the right mouse button to increase the amount of color in the image.

Blank Screen

Blank Screen determines what color is displayed when there is no active source and when the projector is in standby. Click either mouse button to toggle between the blue and black options.

Reset All

Click either mouse button to reset all the options (except Language, Video Standard, Ceiling and Rear Projection, and Standby Time) in all the menus to their original settings. This also returns Freeze and Mute to their default (off) settings.

Audio Menu

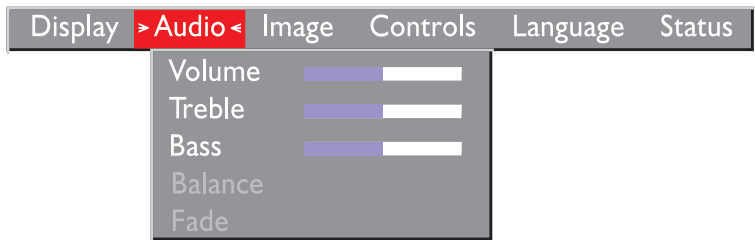

FIGURE 14

Audio menu



NOTE: Changing the volume from the menu is the same as changing it using the keypad.

Volume

- Press the left mouse button to decrease the volume.
- Press the right mouse button to increase the volume.

Volume adjustments you make are saved for each source.

Treble

The treble setting controls the high frequencies of your audio source.

- Press the left mouse button to decrease the treble.
- Press the right mouse button to increase the treble.

Treble adjustments are saved for each source you have connected.

Bass

The bass setting controls the low frequencies of your audio source.

- Press the left mouse button to decrease the bass.
- Press the right mouse button to increase the bass.

Bass adjustments are saved for each source you have connected.

Balance

This feature is not available on this product.

Fade

This feature is not available on this product.

Image Menu

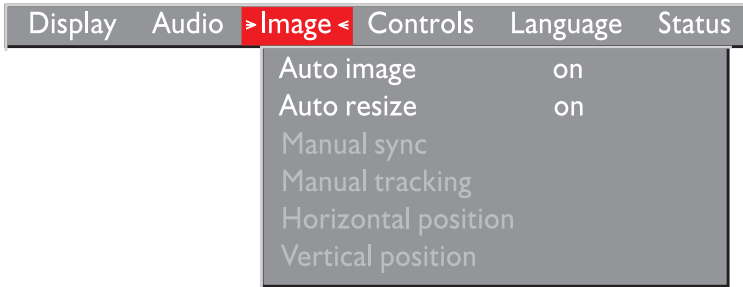

FIGURE 15

Image menu

Auto Image

The projector automatically adjusts tracking, signal synchronization and vertical and horizontal position for most computers (Auto Image does not apply to video sources). If you want to adjust these features manually, you must turn off **Auto Image** first by highlighting Auto Image in the Image menu and clicking either mouse button to select “off”.

Auto Resize

Auto Resize automatically resizes the image by scaling it up or down. It only affects computer images that are not in the projector’s native resolution of 800x600.

When **Auto Resize** is on, the projector makes the best fit of the image to the screen. If you turn **Auto Resize** off (by highlighting it in the Image menu and clicking either mouse button to select “off”), the image may be either cropped or too small for the screen.

Manual Sync

The projector adjusts signal synchronization automatically for most computers. But if the projected computer image looks noisy or streaked, try turning **Auto Image** off then back on again. If the image still looks bad, try adjusting the signal synchronization manually:

- 1 Turn Auto Image off.
- 2 Highlight Manual sync, then press either mouse button repeatedly until the image is sharp and free of streaks.



NOTE: Some screen savers interfere with the operation of Auto Image. If you’re experiencing problems, try turning your screen saver off, then turning Auto Image off and back on.



NOTE: *The Manual Sync, Manual Tracking, Horiz. Position and Vert. Position options are available only for computer sources. The projector sets these options automatically for a video source.*

Manual Tracking

The projector adjusts tracking automatically to match the video signal from your computer. However, if the display shows evenly spaced, fuzzy, vertical lines or if the projected image is too wide or too narrow for the screen, try turning **Auto Image** off then back on again. If the image is still bad, try adjusting the tracking manually:

- 1 Turn Auto Image off.
- 2 Highlight Manual tracking, then press either mouse button repeatedly until the fuzzy vertical bars are gone.

Positioning adjustments are saved when you power off the projector.

Horizontal position

Follow these steps to manually adjust the horizontal position:

- 1 Turn Auto Image off.
- 2 Highlight Horizontal position, then press the left mouse button to move the image right or press the right mouse button to move the image left.

Positioning adjustments are saved when you power off the projector.

Vertical position

Follow these steps to manually adjust the vertical position.

- 1 Turn Auto Image off.
- 2 Highlight Vertical position, then press the left mouse button to move the image down or press the right mouse button to move the image up.

Positioning adjustments are saved when you power off the projector.

Controls Menu

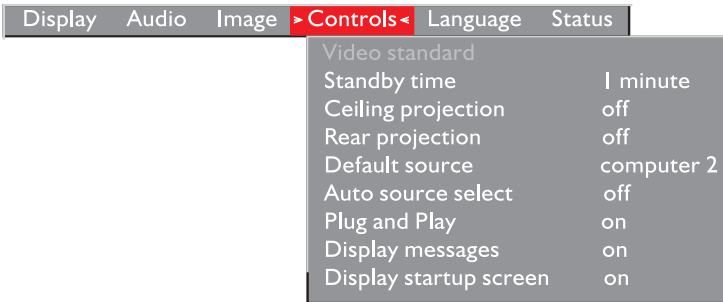

FIGURE 16

Controls menu

Video Standard

When Video standard is set to Auto, the projector attempts to pick the video standard (NTSC, NTSC 4.43, PAL, PAL-M, PAL-N, or SECAM) automatically based on the input signal it receives. (The video standard options may vary depending on your region of the world.) The input signals for SECAM, PAL-M, and PAL-N video cannot be automatically detected, therefore they must be chosen manually. If the projector is unable to detect the correct standard, the colors might not look right or the image might appear “torn.” If this happens, manually select a standard by clicking either mouse button and cycling through the standards.

Standby Time

This option lets you select how long the lamp stays on and the blank screen is displayed when the projector enters standby mode before the projector turns off. Select among 1, 5, 10, and 15 minutes and 1 and 2 hours by clicking either mouse button and cycling through the options.

Ceiling Projection

When you turn Ceiling Projection on, the projector turns the image upside down for ceiling-mounted projection. Highlight Ceiling Projection, then click either mouse button to turn this feature on and off.



NOTE: If you already know the video standard used in your geographical area, it's often best to manually select it.



NOTE: To order the Ceiling Mount, refer to “Optional Accessories” on page 40.

Rear Projection

When you turn **Rear Projection** on, the projector reverses the image so you can project from behind a translucent screen. Highlight **Rear Projection**, then click either mouse button to turn this feature on and off.

Default Source

Default Source toggles between **Computer** and **Video**. This determines which source the projector checks first for active video during power-up. Highlight **Default Source** and click either mouse button to toggle between the options.

Auto Source Select

This setting toggles between **On** and **Off**. When this feature is **Off**, the projector defaults to the source selected in **Default Source**. To display another source, you must manually select one by pressing the source button on the keypad. When this feature is **On**, the projector automatically finds the active source, checking the default source first. Highlight **Auto Source Select** and click either mouse button to turn this feature on and off.

Plug and Play

This setting toggles between **On** and **Off**. When it is **On**, most new computers will automatically recognize the projector, then set the monitor resolution and refresh rate accordingly. You need to set the **Plug and Play** setting to **Off** for the projector to display properly on some older computers. The **Plug and Play** setting does not affect video images.

If the projector's display constantly changes between the computer image and the message, "Perfecting the image", you may need to set **Plug and Play** to **Off**.

Display Messages

This setting toggles between **On** and **Off**. When this feature is **On**, status messages such as "No signal detected" or "Standby Active" appear in the lower-right corner of the screen. Click either mouse button to turn this feature off and not see status messages.

Display Startup Screen

This setting toggles between On and Off. When this feature is On, the startup screen appears when the projector starts up and remains until an active source is detected. Click either mouse button to turn this feature off and display a plain black or blue screen instead of the startup screen.

Language Menu



FIGURE 17

Language menu

You can display the on-screen menus in English, French, German, and Spanish.

- Move the cursor to the language you want, then click either mouse button. The menus redraw immediately.

Status Menu

This is a read-only window for informational purposes. To display the status window, select Show status from the menu, then click either mouse button. To remove the window, click either mouse button.

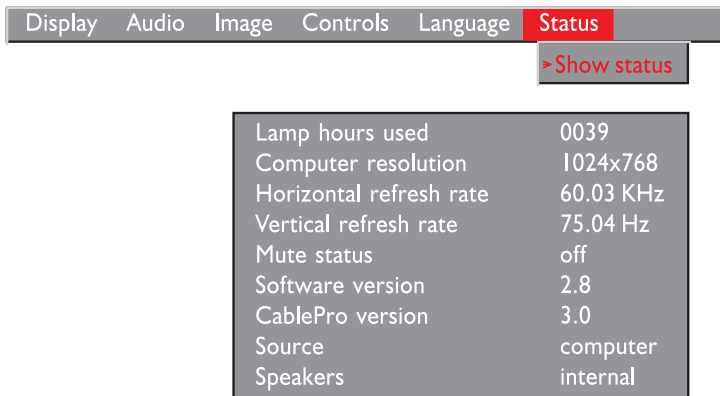

FIGURE 18

Status menu

Lamp hours used

Indicates how many hours the current lamp has been in use. The counter starts at zero hours and counts each hour the lamp is in use. Change the bulb when the brightness is no longer acceptable. See “Replacing the Projection Lamp” on page 29 for details.

Computer resolution

Shows your computer’s resolution setting. To change this, go to your computer’s Control Panel and adjust the resolution in the Display tab. See your computer’s user’s guide for details.

Horizontal refresh rate

The time period that one horizontal line is displayed.

Vertical refresh rate

The time period that one video frame is displayed.

Mute status

Indicates if the audio is muted.

Software version

Indicates the projector's software version. This information is useful when contacting Technical Support.

CablePro version

Indicates the CablePro's software version. This information is useful when contacting Technical Support. No version is listed for the CablePro Lite cable.

Source

Indicates the active source, Computer or Video.

Speakers

Indicates if external speakers are connected.

MAINTENANCE & TROUBLESHOOTING

This section describes how to:

- clean the lens
- replace the projection lamp
- use the Kensington lock feature
- troubleshoot the projector

Cleaning the Lens

Follow these steps to clean the projection lens:

- 1 Apply a non-abrasive camera lens cleaner to a soft, dry cloth.
 - Avoid using an excessive amount of cleaner.
 - Abrasive cleaners, solvents or other harsh chemicals might scratch the lens.
- 2 Lightly wipe the cleaning cloth over the lens.
- 3 If you don't intend to use the projector immediately, replace the lens cap.

Replacing the Projection Lamp

The lamp hour counter in the Status menu counts the number of hours the lamp has been in use. The projector uses a metal halide bulb. These types of bulbs deteriorate over time. Replace the lamp when the brightness is no longer acceptable. You can order new lamp modules from Boxlight. See "Accessories" on page 39 for information.

Follow these steps to replace the projection lamp:

- 1 Turn off the projector and unplug the power cord.
- 2 Wait 30 minutes to allow it to cool thoroughly.
- 3 Place the projector on its side, then insert a small screwdriver or other flat object into the tabs on the lamp module door (Figure 19).



.....
WARNING: To avoid burns, allow the projector to cool for at least 30 minutes before you open the lamp module door. Never extract the lamp module while the lamp is operating.

4 Pull the lamp door up and remove it.

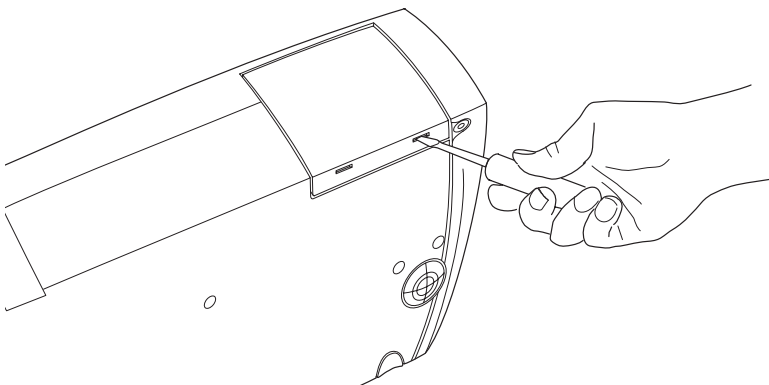

FIGURE 19

Removing the lamp door



CAUTION: Never operate the projector with the lamp door open or removed. This disrupts the air flow and causes the projector to overheat.

5 Loosen the two non-removable screws on the outside of the module.

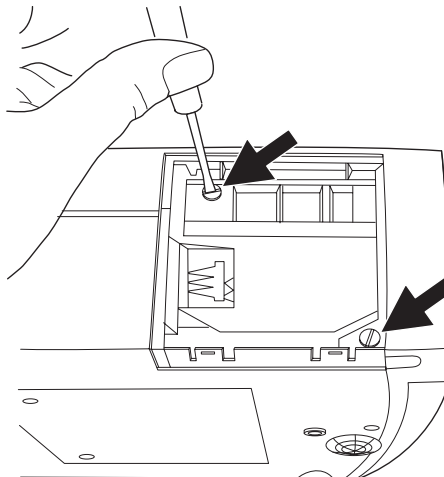

FIGURE 20

Loosening the screws on the lamp module

6 Slide the lamp connector to the right to disconnect it from the projector (Figure 21).

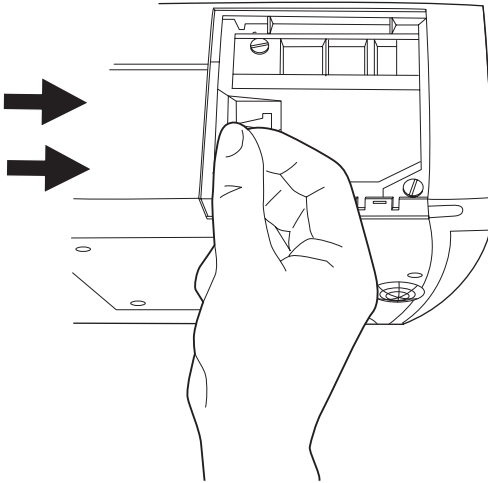

FIGURE 21

Sliding the lamp connector

7 Remove the module (Figure 22).

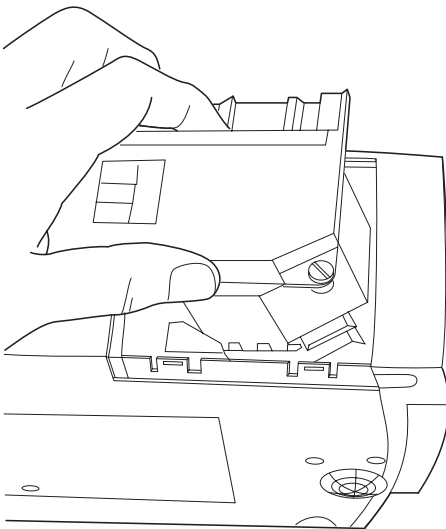

FIGURE 22

Removing the lamp module



WARNING: Do not drop the lamp module or touch the glass bulb! The glass may shatter and cause injury.

- 8 Align the new lamp module in the correct direction.
- 9 Gently push the module in as far as it goes.
- 10 Tighten the screws on the outside of the module.
- 11 Slide the lamp connector to the left to re-attach it.
- 12 Insert the tabs at the top of the lamp door into the projector and press the lamp door into place.
- 13 Plug in the power cord and turn the projector back on.
- 14 To reset the lamp hour counter in the Status window, press and hold the left mouse button, then press the menu button (while still holding down the mouse button) for 5 seconds. Verify that the counter was reset by pressing the menu button and viewing the counter in the Status window.

Using the Kensington Lock

The projector has a Kensington Security Standard connector for use with a Kensington MicroSaver Security System (Figure 23). Refer to the information that came with the Kensington System for instructions on how to use it to secure the projector.

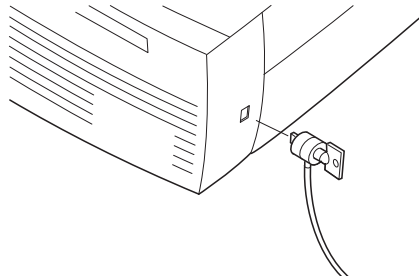

FIGURE 23

Installing the Kensington lock

Troubleshooting

Problem: Nothing on projection screen

- Make sure that the power cord is properly connected to a functional AC electrical outlet. Make sure that the power cord is also properly connected to the projector.
- If the projector is plugged into a power strip, make sure the power strip is turned on.
- Make sure you have removed the lens cap on the projection lens at the front of the projector.
- Make sure the projector is switched on.
- Check the projector's lamp to ensure that it is securely connected in the lamp module. See "Replacing the Projection Lamp" on page 29.
- Make sure that the cables do not have any bent pins.

Problem: Color or text not being projected

- You might need to adjust the brightness up or down until the text is visible. Refer to "Brightness" on page 18 for more information.

Problem: The screen resolution is not right

- Make sure the computer's video card is set for a resolution of no greater than 1024x768. A resolution of 800x600 yields the highest quality image.

Problem: Image isn't centered on the screen

- Reposition the image. Refer to "Horizontal position" on page 22 and "Vertical position" on page 22.
- Be sure the projector is at a 90 degree angle to the screen.

Problem: Only the start-up screen displays

- Verify that the cables are connected correctly. See page 7 through page 9 for connection procedures.
- Verify that the proper input source is connected. See "Source" on page 15.

- You might need to turn everything off and power up the equipment again in the proper order. Refer to your computer's documentation to determine the correct order.
- Make sure your laptop's external video port is turned on. See the "Portable and Laptop Activation Chart" on page 41 or your computer's manual for details.
- Make sure your computer's video board is installed and configured correctly.

If you're using Windows 3.x:

- 1 In the Windows Program Manager, double-click the Windows Setup icon in the Main program group.
- 2 Verify that the Display setting is 1024x768 or less.

If you're using Windows 95:

- 1 Open "My Computer" icon, the Control Panel folder and then the Display icon.
- 2 Click the Settings tab.
- 3 Verify that the Desktop area is set to 1024x768 or less.

Also check the following:

- Does your computer have a compatible video board? The projector isn't CGA or EGA compatible.
- Is your computer's video port activated? This is especially true for laptop computers. See "Portable and Laptop Activation Chart" on page 41.

Problem: Image is too wide or narrow for screen

- You might need to manually adjust the tracking to reduce or enlarge the projected image. Refer to "Manual Tracking" on page 22.
- Adjust the resolution of your video card if it's greater than 1024x768 pixels.

Problem: Image is out of focus

- Turn the projection lens to focus the image.
- Make sure the projection screen is at least 5 feet (1.5 m) from the projector.
- Check the projection lens to see if it needs cleaning.

Problem: Image and menus are reversed left to right

- Rear projection mode is probably turned on. Turn Rear Projection off in the Controls menu. The image should immediately return to forward projection. See “Rear Projection” on page 24.

Problem: the projector displays vertical lines, “bleeding” or spots

- Adjust the brightness. See “Brightness” on page 18.
- Check the projection lens to see if it needs cleaning.

Problem: no sound

- Adjust volume.
- Verify audio/input connections.
- Adjust audio source.

Problem: Image is “noisy” or streaked

Try these steps in this order.

- 1 Deactivate the screen saver on your computer.
 - 2 Turn Auto Image off and then back on again. See “Auto Image” on page 21.
 - 3 Adjust the synchronization and tracking manually to find an optimal setting. See “Manual Sync” on page 21 and “Manual Tracking” on page 22.
- The problem could be with your computer’s video card. If possible, connect a different computer.

Problem: Projected colors don't match the computer or video player's colors

- Just as there are differences in the displays of different monitors, there are often differences between the computer image and the projected image. Adjust the brightness, tint and/or contrast from the Display menu. See "Brightness" on page 18, "Tint" on page 18 and "Contrast" on page 18.

Problem: Lamp seems to be getting dimmer

- The lamp begins to lose brightness when it has been in use for a long time. Replace the lamp as described in "Replacing the Projection Lamp" on page 29.

Problem: Lamp shuts off

- A minor power surge may cause the lamp to shut off. Turn the projector off, wait at least a minute, then turn it back on.

Before calling Boxlight for assistance, please have the following information available:

- the projector's serial number (located on the bottom label)
- the resolution of your computer.

Call Boxlight at 1-800-762-5757 or 360-779-7901.

APPENDIX

Specifications

The projector must be operated and stored within the temperature and humidity ranges specified.

Temperature

Operating 50 to 104° F (10 to 40° C)

Non-operating -4 to 158° F (-20 to 70° C)

Humidity

Operating and non-oper. 5% to 95% relative humidity, non-condensing

Dimensions

4.0 x 9.3 x 11.8 inches (10.3 x 23.8 x 30.3 cm)

Weight

6.8 lbs. (3.1 kg) unpacked

Altitude

Operating 0 to 10,000 feet (3,048 meters)

Non-operating 0 to 40,000 feet (12,192 meters)

Optics

Focus Range 5.0 - 16 feet (1.5-5 m)

Lamp

Type 270-watt metal halide

Input Power Requirements

100-120VAC 6A; 50/60Hz

200-240VAC 3A; 50Hz

Video Audio Input

Input Impedance	5K ohm DC coupled
Maximum Input Voltage	$(L_{IN} + R_{IN})_{PEAK} < 4.5 \text{ V}$ for THD $\leq 0.3\%$ L_{IN} or $R_{IN} < 2.0 \text{ Vrms}$ for THD $\leq 0.3\%$
Sensitivity	100 mV at 1 KHz for 88 dB SPL at 1 meter
Connector Type	RCA jack

Computer Audio Input

Input Impedance	10K ohm nominal, AC coupled
Maximum Input Voltage	$(L_{IN} + R_{IN})_{PEAK} < 4.5 \text{ V}$ for THD $\leq 0.3\%$ L_{IN} or $R_{IN} < 2.0 \text{ Vrms}$ for THD $\leq 0.3\%$
Sensitivity	100 mV at 1 KHz for 88 dB SPL at 1 meter
Connector Type	3.5 mm (1/8 inch) stereo phone jack

Accessories

Standard Accessories (ship with the projector)

Quick Start card
User's Guide
Soft Case
Shipping Box
CablePro Lite computer cable 6.5 ft (2 m)
Audio Cable 6 ft (1.8 m)
Projection Lamp Module
Lens Cap
Audio/Video Cable



.....
NOTE: Use only Boxlight-
approved accessories. Other prod-
ucts have not been tested with the
projector.

Power Cords (one ships with projector, type depends on country)



North American Power Cord
Australian Power Cord
UK Power Cord
European Power Cord
Danish Power Cord
Swiss Power Cord

Optional Accessories

Deluxe Soft Case
ATA Travel Case
Executive Leather Case
Deluxe Travel Case
Macintosh adaptor
CablePro 3
CablePro 2
 CablePro Extension Cable, non-plenum
 rated, 60.7 ft (18.5 m)
 CablePro Extension Cable, plenum-rated,
 60.7 ft (18.5m)
 CablePro 2 Installation Extension Cable, 70.5
 ft (21.5 m) (CablePro 2 only)
Executive Remote Plus
Full-Feature Laser Pro Remote Control
 Remote Cable, 50 ft (15 m)
RF Remote
2-Button Executive Remote
 Remote Receiver
Ceiling Mount-LiteMount
 LiteMount False Ceiling Plate
 LiteMount Pipe Tubing Extension
 CablePro Wall Plate
Kensington MicroSaver Security System
Tripod Mount
Portable Projector Stand
Portable Projection Screen
S-Video Cable
1 Year Uptime Assurance
1 Year 20-Point Maintenance Plan

Portable and Laptop Activation Chart

Many laptop computers do not automatically turn on their external video port when a secondary display device such as a projector is connected. Activation commands for some laptop computers are listed in the following table. (If your computer is not listed or the given command does not work, refer to the computer's documentation for the appropriate command.) On some laptops, the activation function key is labeled with an icon, for

example /  or the text CRT/LCD.

Computer	Key command to activate port	Key command to de-activate port
Acer	Ctrl-Alt-Esc (for setup)	Ctrl-Alt-Esc (for setup)
AST* **	FN-D or Ctrl-D Ctrl-FN-D FN-F5 type from A:/VGA/CRT FN-F12	FN-D or Ctrl-D Ctrl-FN-D FN-F5 type from A:/VGA/CRT FN-F12
AMS	FN-F2	FN-F2
AMT	setup screen	setup screen
AT&T	FN-F3 FN-F6	FN-F3 FN-F6
Advanced Logic Research	Ctrl-Alt-V	Ctrl-Alt-V
Altima	Shift-Ctrl-Alt-C setup VGA/ Conf.Simulscan	Shift-Ctrl-Alt-L setup VGA/ Conf.Simulscan
Ambra**	FN-F12 FN-F5 F2/Choose Option/F5	FN-F12 FN-F5 F2/Choose Option/F5
Amrel* **	setup menu Shift-Ctrl-D	setup menu Shift-Ctrl-D
Apple	see Mac Portable and Mac PowerBook	
Aspen	automatic	automatic



NOTE: Often, pressing the key commands once activates the external video port, pressing it again activates both the external and internal ports, and pressing it a third time activates the internal port. Refer to your computer's documentation for details on your specific model.

Computer	Key command to activate port	Key command to de-activate port
Austin	Ctrl-Alt-comma	Ctrl-Alt-comma
Award	FN-F6	FN-F6
BCC*	automatic	reboot computer
Bondwell	LCD or CRT options after bootup	reboot for LCD or CRT options to appear
Chaplet**	setup screen	setup screen
	FN-F6	FN-F6
	FN-F4	FN-F4
Chembook	FN-F6	FN-F6
Commax	Ctrl-Alt-#6	Ctrl-Alt-#5
Compaq* **	Ctrl-Alt-<	Ctrl-Alt->
	FN-F4	FN-F4
	automatic	automatic
	mode/? (for setup option)	mode/? (for setup option)
Compuadd* **	automatic	automatic
	Alt-F for screen setup option	Alt-F for screen setup option
Data General	Ctrl-Alt-Command	Ctrl-Alt-Command
Data General Walkabout	2 CRT/X at DOS prompt	reboot
Datavue	Ctrl-Shift-M	Ctrl-Shift-M
DEC**	FN-F5	FN-F5
	FN-F4	FN-F4
Dell**	Ctrl-Alt-<	Ctrl-Alt->
	Ctrl-Alt-F10	Ctrl-Alt-F10
	FN-F8 (CRT/LCD)	FN-F8
	FN-D	FN-D
	FN-F12	FN-F12
Digital*	automatic	reboot
	FN-F2	FN-F2
Dolch	dip switch to CRT	dip switch to LCD
Epson	dip switch to CRT	dip switch to LCD

Computer	Key command to activate port	Key command to de-activate port
Everex*	setup screen option	setup screen option
For-A	Ctrl-Alt-Shift-C	Ctrl-Shift-Alt-L
Fujitsu	FN-F10	
Gateway	FN-F3 FN-F1/FN-F1 again simultaneous	FN-F3 FN-F1
Grid* **	FN-F2, choose auto or simultaneous Ctrl-Alt-Tab	FN-F2 Ctrl-Alt-Tab
Hitachi	FN-F7	FN-F7
Honeywell	FN-F10	FN-F10
Hyundai	setup screen option	setup screen option
IBM 970*	automatic	warm reboot
IBM ThinkPad**	reboot, enter setup menu FN-F7, select choice from setup menu FN-F1, select choice FN-F5, select choice PS/2 SC select choice (CRT, LCD, etc.)	FN-F2
Infotel	FN-F12	FN-F12
Kaypro	boot up, monitor plugged in	unplug monitor
Kris Tech	FN-F8	FN-F8
Leading Edge	FN-T	FN-T
Mac Portable 100	no video port: not compatible	
Mac PowerBook		
140, 145, 150, 170	no video port: requires a 3rd-party interface	
160, 165, 180, 520, 540, 5300	Control Panel folder, PowerBook Display folder; Activate Video Mirroring	warm reboot
210, 230, 250, 270, 280, 2300	requires Apple Docking Station or Mini Dock	

Computer	Key command to activate port	Key command to de-activate port
Magitronic	FN-F4	FN-F4
Mastersport	FN-F2	FN-F1
Micro Express*	automatic	warm reboot
Micron	FN-F2	FN-F2
Microslate*	automatic	warm reboot
Mitsubishi	SW2 On-Off-Off-Off	SW2 Off-On-On-On
NCR	setup screen option	setup screen option
NEC* **	setup screen option	setup screen option
	CRT at the DOS prompt	LCD at the DOS prompt
	FN-F3	FN-F3
Olivetti*	automatic	automatic
	FN-O/*	FN-O/*
Packard Bell* **	FN-F0	FN-F0
	Ctrl-Alt-<	Ctrl-Alt->
Panasonic	FN-F2	FN-F2
Prostar	Ctrl-Alt-S at bootup	Ctrl-Alt-S at bootup
Samsung*	setup screen option	setup screen option
Sanyo	setup screen option	setup screen option
Sharp	dip switch to CRT	dip switch to LCD
Sun SPARC-Dataview	Ctrl-Shift-M	Ctrl-Shift-M
Tandy**	Ctrl-Alt-Insert	Ctrl-Alt-Insert
	setup screen option	setup screen option
Tangent	FN-F5	FN-F5
Texas Instruments*	setup screen option	setup screen option
Top-Link* **	setup screen option	setup screen option
	FN-F6	FN-F6
Toshiba* **	Ctrl-Alt-End	Ctrl-Alt-Home
	FN-End	FN-Home
	FN-F5	FN-F5
	setup screen option	setup screen option

Computer	Key command to activate port	Key command to de-activate port
Twinhead*	FN-F7	FN-F7
	FN-F5	FN-F5
	Automatic	Automatic
WinBook	Ctrl-Alt-F10	Ctrl-Alt-F10
Wyse	software driven	software driven
Zenith**	FN-F10	FN-F10
	FN-F2	FN-F2
	FN-F1	FN-F1
Zeos**	Ctrl-Shift-D	Ctrl-Shift-D
	FN-F1	FN-F1

* These manufacturers have models that automatically send video to the external CRT port when some type of display device is attached.

** These manufacturers offer more than one key command depending on the computer model.

Using Video Mirroring with a PowerBook Computer

When you turn video mirroring (called SimulScan in newer PowerBooks-see below) on, the projector displays the same information that appears on your PowerBook's built-in screen. When video mirroring is off, the projector acts like a separate display.

To turn on video mirroring for the first time:

- 1 Open the Monitors control panel; click on Monitor 2.
- 2 Set the number of colors you want.
- 3 Open the Control Strip; click on the monitor icon.
- 4 Select "Turn Video Mirroring On."

Now you can turn video mirroring on and off from the Control Strip without having to open the Monitors control panel again.

When using video mirroring and high color graphics such as slide shows, the projected image occasionally might turn black and white. If this happens, perform the following steps:

- 1 Turn off video mirroring.
- 2 Open the Monitors control panel.
- 3 Move the white menu bar to Monitor 2 to set the projector as the primary monitor.
- 4 Restart the PowerBook.

Using SimulScan

Some newer PowerBooks display images on an external monitor or projector differently than previous ones. When using SimulScan, the projector displays the same information that appears on your PowerBook

To select SimulScan:

- 1 Open the Control Panel, then double-click Monitors and Sound.
- 2 In the Resolution list, choose the SimulScan mode, then click OK.
- 3 If this changes your display settings, a dialog box appears. Click OK to confirm the change.

Projected Image Size

Use the chart and table to help you determine projected image sizes.

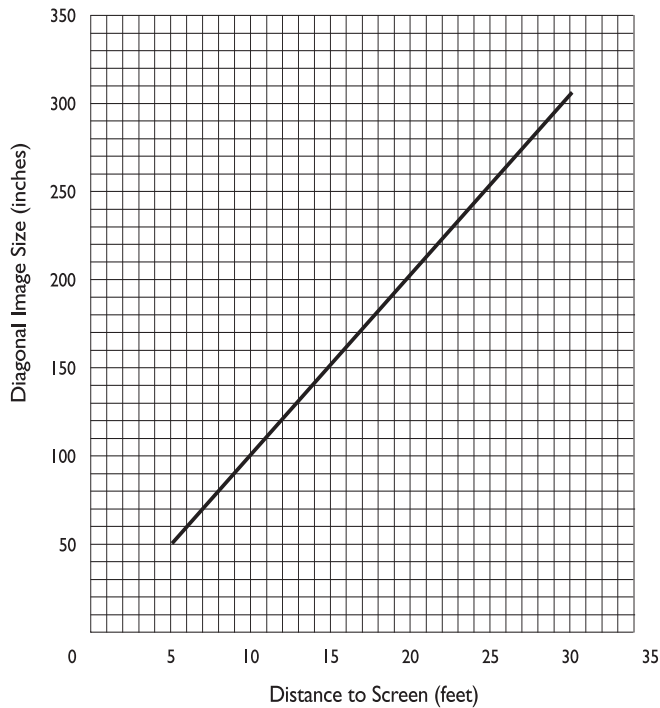

FIGURE 24

Projected image size

Table 1:
Image Size, Width and Height

Distance to Screen (feet)	Diagonal (inches)	Width (inches)	Height (inches)
5	51	41	31
10	102	82	61
15	153	122	92
20	204	163	122
25	255	204	153
30	306	245	184

Table 2:
Image Size, Width and Height-metric

Distance to Screen (m)	Diagonal (m)	Width (m)	Height (m)
1.5	1.3	1.0	.79
3.1	2.6	2.1	1.6
4.6	3.9	3.1	2.4
6.2	5.2	4.2	3.1
7.7	6.6	5.2	3.9
9.2	7.8	6.3	4.7

INDEX

A

- accessories, ordering 39, 40
- activation commands for laptop computers 41
- adjusting
 - bass 20
 - brightness 18
 - color 19
 - contrast 18
 - tint 18
 - treble 20
 - volume 16, 20
- adjusting the height of the projector 14
- altitude limits 37
- assistance. See Technical Support
- Audio menu 20
- Audio menu options
 - Bass 20
 - Treble 20
 - Volume 20
- Auto Source Select 24

B

- bass, adjusting 20
- Blank Screen 19
- brightness, adjusting 18
- buttons on keypad
 - Menu 15
 - Source 15
 - Standby 16
 - Volume 16

C

- CablePro Lite 2, 7, 8
- cables
 - A/V 9, 39
 - audio 7
 - CablePro extension 40
 - CablePro Lite 2, 7, 8
 - composite video 9
 - extension 40
 - ordering 39
 - power 39
 - S-video 9, 40
- cases, ordering 39
- CD-40m
 - cases 39, 40
 - ceiling mounted 23
 - project from behind the screen
 - 23, 24
 - setting up 5
 - specifications 37
 - turning off 12
 - turning on 11
- ceiling-mounted projection 23
- cleaning the projection lens 29
- color, adjusting 19
- colors
 - don't match monitor colors 36
 - not displayed 33
- compatibility
 - IBM-compatible 1
 - Macintosh 1
- composite video cable
 - connecting 9
 - ordering (A/V cable) 39
- computers, compatible 1
- connecting
 - IBM-compatible computer 7
 - Macintosh computers 8
 - power cord 11
 - video player 9–10
- contrast, adjusting 18

- Controls menu 23
- Controls menu options
 - Auto Source Select 24
 - Ceiling 23
 - Default Source 24
 - Display Messages 24
 - Display Startup Screen 25
 - Plug and Play 24
 - Rear Projection 24
 - Standby Time 23
 - Video Standard 23

D

- Default Source 24
- Display menu 18
- Display menu options
 - Blank Screen 19
 - Brightness 18
 - Color 19
 - Contrast 18
 - Reset All 19
 - Tint 18
- Display Messages 24
- Display Startup Screen 25
- displaying
 - startup screen 25
 - status messages 24
- displaying on-screen menus 15

E

- extension cable 40

F

- fuzzy lines 22

I

- IBM-compatible computers
 - compatibility 1
 - connecting 7
- image
 - adjusting 11, 13
 - centering 22
 - colors don't match computer's 36
 - focusing 13
 - fuzzy lines 22
 - has lines or spots 35
 - not centered 33
 - not displayed 33
 - out of focus 35
 - quality 33–36
 - resolution 1
 - reversed 23, 24, 35
 - size 5, 47
 - streaked 35
 - too wide or too narrow 34
- Image menu 21
- Image menu options
 - Auto Image 21
 - Auto Resize 21
 - Horiz. Position 22
 - Manual Sync 21
 - Manual Tracking 22
 - Vert. Position 22

K

- Kensington lock 32, 40

L

- lamp
 - ordering 39
 - replacing 29
 - turns off unexpectedly 36
- lamp hour counter 26
- Language menu 25
- language, selecting for menus 25
- laptop computers
 - activation sequence to allow secondary display 41
 - compatibility 7
 - connecting IBM-compatible 7
 - connecting PowerBook 8
- lens
 - cap 39
 - cleaning 29

M

- Macintosh computers
 - adaptor 8
 - compatibility 1
 - connecting 8
- Menu button 17
- menus. See on-screen menus
- monitor, projected colors don't match 36

N

- NTSC video 23

O

- on-screen menus
 - Audio menu 20
 - changing language of 25
 - Controls menu 23
 - Display menu 18
 - displaying 17
 - Image menu 21
 - Language menu 25
 - making changes to menu functions 17
 - Status menu 26

P

- PAL video 18, 23
- Plug and Play 24
- power cord
 - connecting 11
 - ordering 39
- power switch 11, 12
- power up sequence 11, 34
- PowerBook, connecting 8
- project from behind the screen 23, 24

R

- rear projection 24
- replacing projection lamp module 29
- re-positioning the image on the screen 22
- resetting adjustments 19
- resolution 1

S

- safety guidelines iii
- SECAM video 18, 23
- security feature 32
- SimulScan, using with PowerBooks 46
- Source button 15
- specifications 37
- Standby button 16
- Standby Time 23
- startup screen 25
- Status menu 26
- S-video
 - connecting 9
 - ordering cable 40

T

- Technical Support
 - information to have on hand before you call 36
- temperature limits 37
- test pattern 33
- text not visible 33
- tint, adjusting 18
- treble, adjusting 20
- troubleshooting 33
- turning off the projector 12
- turning on the projector 11

V

- vertical lines displayed 22, 35
- video 18
- video mirroring on a PowerBook 8, 46
- video standards 23
- Volume buttons 16
- volume, adjusting 16, 20

W

- warranty 40

LIMITED WARRANTY

Boxlight warrants that each CD-40m ("the Product") sold hereunder will conform to and function in accordance with the written specifications of Boxlight. Said limited warranty shall apply only to the first person or entity that purchases the Product for personal or business use and not for the purpose of distribution or resale. The product may contain recycled components that are in new condition. Said warranty shall continue for a period of two (2) years from the date of such purchase. The standard limited warranty excludes the lamps in projectors after 90 days and the accessories after one year. Boxlight does not warrant that the Product will meet the specific requirements of the first person or entity that purchases the Product for personal or business use. Boxlight's liability for the breach of the foregoing limited warranty is limited to the repair or replacement of the Product or refund of the purchase price of the Product, at Boxlight's sole option. To exercise the Purchaser's rights under the foregoing warranty, the Product must be returned at the Purchaser's sole cost and expense, to Boxlight or to any authorized Boxlight service center provided, however, that the Product must be accompanied by a written letter explaining the problem and which includes (i) proof of date of purchase; (ii) the dealer's name; and (iii) the model and serial number of the Product. When sending your unit in for repair, please ship your unit in its original packing material or an Boxlight approved ATA Shipping Case, or have a professional packaging company pack the unit. Please insure your shipment for its full value. A return authorization number, issued by the Boxlight customer service department, must also be clearly displayed on the outside of the shipping carton containing the Product.

WARRANTY LIMITATION AND EXCLUSION

Boxlight shall have no further obligation under the foregoing limited warranty if the Product has been damaged due to abuse, misuse, neglect, accident, unusual physical or electrical stress, unauthorized modifications, tampering, alterations, or service other than by Boxlight or its authorized agents, causes other than from ordinary use or failure to properly use the Product in the application for which said Product is intended.

DISCLAIMER OF UNSTATED WARRANTIES

THE WARRANTY PRINTED ABOVE IS THE ONLY WARRANTY APPLICABLE TO THIS PURCHASE. ALL OTHER WARRANTIES, EXPRESS OR IMPLIED, INCLUDING, BUT NOT LIMITED TO, THE IMPLIED WARRANTIES OF MERCHANTABILITY AND FITNESS FOR A PARTICULAR PURPOSE ARE DISCLAIMED. THERE ARE NO WARRANTIES THAT EXTEND BEYOND THE FACE HEREOF AND THE FOREGOING WARRANTY SHALL NOT BE EXTENDED, ALTERED OR VARIED EXCEPT BY WRITTEN INSTRUMENT SIGNED BY BOXLIGHT.

LIMITATION OF LIABILITY

IT IS UNDERSTOOD AND AGREED THAT BOXLIGHT'S LIABILITY WHETHER IN CONTRACT, IN TORT, UNDER ANY WARRANTY, IN NEGLIGENCE OR OTHERWISE SHALL NOT EXCEED THE RETURN OF THE AMOUNT OF THE PURCHASE PRICE PAID BY PURCHASER AND UNDER NO CIRCUMSTANCES SHALL BOXLIGHT BE LIABLE FOR SPECIAL, INDIRECT OR CONSEQUENTIAL DAMAGES OR LOST PROFITS, LOST REVENUES OR LOST SAVINGS. THE PRICE STATED FOR THE PRODUCT IS A CONSIDERATION IN LIMITING BOXLIGHT'S LIABILITY. NO ACTION, REGARDLESS OF FORM, ARISING OUT OF THE AGREEMENT TO PURCHASE THE PRODUCT MAY BE BROUGHT BY PURCHASER MORE THAN ONE YEAR AFTER THE CAUSE OF ACTION HAS ACCRUED.

Part Number 010-0202-00

Free Manuals Download Website

<http://myh66.com>

<http://usermanuals.us>

<http://www.somanuals.com>

<http://www.4manuals.cc>

<http://www.manual-lib.com>

<http://www.404manual.com>

<http://www.luxmanual.com>

<http://aubethermostatmanual.com>

Golf course search by state

<http://golfingnear.com>

Email search by domain

<http://emailbydomain.com>

Auto manuals search

<http://auto.somanuals.com>

TV manuals search

<http://tv.somanuals.com>