



NE 151 Highway 300, Suite A  
PO Box 2609  
Belfair, WA 98528  
360.464.2119  
www.boxlight.com

# Pro6500DP



USER MANUAL

## **Copyright**

This publication, including all photographs, illustrations and software, is protected under international copyright laws, with all rights reserved. Neither this manual, nor any of the material contained herein, may be reproduced without written consent of the author.

© Copyright 2009

## **Disclaimer**

The information in this document is subject to change without notice. The manufacturer makes no representations or warranties with respect to the contents hereof and specifically disclaims any implied warranties of merchantability or fitness for any particular purpose. The manufacturer reserves the right to revise this publication and to make changes from time to time in the content hereof without obligation of the manufacturer to notify any person of such revision or changes.

## **Trademark Recognition**

Kensington is a U.S. registered trademark of ACCO Brand Corporation with issued registrations and pending applications in other countries throughout the world.

All other product names used in this manual are the properties of their respective owners and are acknowledged.

## Important Safety Information

Congratulations on purchasing the BOXLIGHT DLP projector!

**Important:**

*It is strongly recommended that you read this section carefully before using the projector. These safety and usage instructions will ensure that you enjoy many years of safe use of the projector. Keep this manual for future reference.*

## Symbols Used

Warning symbols are used on the unit and in this manual to alert you of hazardous situations.

The following styles are used in this manual to alert you to important information.

**Note:**

*Provides additional information on the topic at hand.*

**Important:**

*Provides additional information that should not be overlooked.*

**Caution:**

*Alerts you to situations that may damage the unit.*

**Warning:**

*Alerts you to situations that may damage the unit, create a hazardous environment, or cause personal injury.*

Throughout this manual, component parts and items in the OSD menus are denoted in bold font as in this example:

“Push the **Menu** button on the remote control to open the **Main** menu.”

## Remote Control

Some remote controls have a laser for pointing out items on a screen.

**DANGER: Do not point the laser in the eyes. Doing so can damage the eyes permanently.**

## General Safety Information

- Do not open the unit case. Aside from the projection lamp, there are no user-serviceable parts in the unit. For servicing, contact qualified service personnel.
- Follow all warnings and cautions in this manual and on the unit case.
- The projection lamp is extremely bright by design. To avoid damage to eyes, do not look into the lens when the lamp is on.
- Do not place the unit on an unstable surface, cart, or stand.
- Avoid using the system near water, in direct sunlight, or near a heating device.
- Do not place heavy objects such as books or bags on the unit.

### Power Safety

- Only use the supplied power cord.
- Do not place anything on the power cord. Place the power cord where it will not be in the way of foot traffic.
- Remove the batteries from the remote control when storing or not in use for a prolonged period.

### Replacing the Lamp

Replacing the lamp can be hazardous if done incorrectly. See Replacing the Lamps on page 83 for clear and safe instructions for this procedure. Before replacing the lamp:

- Unplug the power cord.
- Allow the lamp to cool for about one hour.

### Important Recycle Instructions:

 Lamp(s) inside this product contain mercury. This product may contain other electronic waste that can be hazardous if not disposed of properly. Recycle or dispose in accordance with local, state, or federal Laws. For more information, contact the Electronic Industries Alliance at [WWW.EIAE.ORG](http://WWW.EIAE.ORG). For lamp specific disposal information check [WWW.LAMPRECYCLE.ORG](http://WWW.LAMPRECYCLE.ORG).

### Cleaning the Projector

- Unplug the power cord before cleaning. See Cleaning the projector on page 81.
- Allow the lamp to cool for about one hour.

### Regulatory Warnings

Before installing and using the projector, read the regulatory notices in the Regulatory Compliance section on page 107.

### Symbol Explanations



DISPOSAL: Do not use household or municipal waste collection services for disposal of electrical and electronic equipment. EU countries require the use of separate recycling collection services.

## **Main Features**

- Lightweight unit, easy to pack away and transport.
- Compatible with all major video standards including NTSC, PAL, and SECAM.
- A high brightness rating allows for presentations in daylight or in lit rooms.
- Supports resolutions up to UXGA at 16.7 million colors to deliver crisp, clear images.
- Flexible setup allows for front, rear projections.
- Line-of-vision projections remain square, with advanced keystone correction for angled projections.
- Input source automatically detected.

## **About this manual**

This manual is intended for end users and describes how to install and operate the DLP projector. Wherever possible, relevant information—such as an illustration and its description—has been kept on one page. This printer-friendly format is both for your convenience and to help save paper, thereby protecting the environment. It is suggested that you only print sections that are relevant to your needs.

---

## Table of Contents

<b>INTRODUCTION.....</b>	<b>1</b>
PACKING CHECKLIST .....	1
VIEWS OF PROJECTOR PARTS.....	2
<i>Front-right View</i> .....	2
<i>Top view</i> .....	3
<i>Bottom view</i> .....	4
TOP FEATURES.....	5
<i>Lens Controls</i> .....	5
<i>OSD Controls and Status LEDs</i> .....	6
TERMINAL PANEL FEATURES.....	8
REMOTE CONTROL PARTS .....	10
REMOTE CONTROL OPERATING RANGE.....	12
PROJECTOR AND REMOTE CONTROL BUTTONS.....	12
<i>Remote Control</i> .....	12
<b>SETUP AND OPERATION.....</b>	<b>13</b>
INSERTING THE REMOTE CONTROL BATTERIES .....	13
INSTALLING OR REMOVING THE OPTIONAL LENS .....	14
<i>Removing the Existing Lens From the Projector</i> .....	14
<i>Installing the New Lens</i> .....	15
THROW DISTANCE AND SCREEN SIZE .....	16
INSTALLING THE OPTIONAL COLOR WHEEL .....	18
MAKING CONNECTIONS.....	21
<i>Connecting Your PC or Macintosh Computer</i> .....	21
<i>Connecting an External Monitor</i> .....	22
<i>Connecting Your DVD Player with Component Output</i> .....	23
<i>Connecting Your VCR or Laser Disc Player</i> .....	24
<b>PROJECTING AN IMAGE (BASIC OPERATION).....</b>	<b>25</b>
TURNING ON THE PROJECTOR .....	25
<i>Note on Startup Screen (Menu Language Select screen)</i> .....	26
SELECTING AN INPUT SOURCE .....	27
ADJUSTING THE PICTURE POSITION AND PICTURE SIZE .....	28
<i>Adjusting Picture Position Manually</i> .....	28
<i>Lens Shift Adjustable Range</i> .....	29
<i>From the Remote Control Unit</i> .....	30
<i>Adjusting the Projector Level</i> .....	32
OPTIMIZING AN RGB IMAGE AUTOMATICALLY.....	33
<i>Adjusting the Image Using AUTO</i> .....	33
ADJUSTING VOLUME UP AND DOWN .....	34
TURNING OFF THE PROJECTOR.....	35
<i>About Direct Power Off</i> .....	36
<i>After Use</i> .....	36
<b>CONVENIENT FEATURES .....</b>	<b>37</b>
TURNING OFF THE IMAGE AND SOUND .....	37
FREEZING A PICTURE .....	37
ADJUSTING THE FOCUS/ZOOM MANUALLY .....	38
<i>Adjusting by Using the OSD Control Panel</i> .....	38
CHANGING LAMP MODE.....	39
<i>Changing Lamp Mode by Using the Projector's OSD Control Panel</i> .....	39
GETTING INFORMATION.....	40
ADJUSTING POSITION/TOTAL DOTS/FINE SYNC.....	41
<i>Adjusting Position/Total Dots/Fine Sync by using the OSD Control Panel</i> .....	41
<i>Correcting Keystone by Using the Remote Control</i> .....	42
PREVENTING THE UNAUTHORIZED USE OF THE PROJECTOR .....	44
<i>Locking the Projector</i> .....	44
<i>Unlocking the Projector</i> .....	45

USING THE PHYSICAL LOCK .....	46
<i>Using the Kensington Lock</i> .....	46
<b>USING ON-SCREEN DISPLAY .....</b>	<b>47</b>
USING THE MENUS .....	47
<i>Navigating the OSD</i> .....	47
MENU TREE .....	49
MENU ELEMENTS .....	51
INPUT MENU DESCRIPTIONS AND FUNCTIONS .....	52
ADJUST MENU DESCRIPTIONS AND FUNCTIONS .....	53
<i>Image menu</i> .....	53
<i>Image options menu</i> .....	54
<i>Video menu</i> .....	56
DETAIL SETTING MENU DESCRIPTIONS AND FUNCTIONS .....	59
<i>Basic</i> .....	59
<i>White balance</i> .....	61
<i>Color correction</i> .....	62
SETTING MENU DESCRIPTIONS AND FUNCTIONS .....	63
<i>Basic</i> .....	63
<i>Installation</i> .....	66
<i>Network setting</i> .....	71
<i>Option</i> .....	72
INFORMATION MENU DESCRIPTIONS AND FUNCTIONS .....	76
<i>Usage time</i> .....	76
<i>Input</i> .....	77
<i>Network</i> .....	78
<i>Version</i> .....	79
RESET MENU DESCRIPTIONS AND FUNCTIONS .....	80
<b>MAINTENANCE .....</b>	<b>81</b>
CLEANING THE PROJECTOR .....	81
<i>Cleaning the Cabinet</i> .....	81
<i>Cleaning the Lens</i> .....	81
<i>Cleaning the Filters</i> .....	82
<i>Replacing the Lamps</i> .....	83
<i>Resetting the Lamp Time Counter</i> .....	86
<b>APPENDIX .....</b>	<b>87</b>
TROUBLESHOOTING .....	87
<i>Indicator Messages</i> .....	87
<i>Common Problems and Solutions</i> .....	88
<i>Tips for Troubleshooting</i> .....	88
IMAGE PROBLEMS .....	89
<i>Lamp Problems</i> .....	89
<i>Remote Control Problems</i> .....	90
<i>Audio Problems</i> .....	90
HAVING THE PROJECTOR SERVICED .....	90
<b>SPECIFICATIONS .....</b>	<b>91</b>
PROJECTOR SPECIFICATIONS .....	91
<i>Optical Specifications</i> .....	91
<i>Electrical Specifications</i> .....	92
<i>Mechanical Specifications</i> .....	93
<i>Environmental Considerations</i> .....	93
<i>Optional Parts</i> .....	93
CABINET DIMENSIONS .....	94
PIN ASSIGNMENTS OF MINI D-SUB 15 PIN INPUT CONNECTOR .....	95
COMPATIBLE INPUT SIGNAL LIST .....	96
PC CONTROL CODES AND CABLE CONNECTIONS .....	98
<i>PC Control Connector (DIN-9P)</i> .....	98

---

<i>Control Command Diagram</i> .....	99
<i>Control Sequence</i> .....	99
<i>Operation Commands</i> .....	99
<i>Remote Commands</i> .....	99
<i>Set Value Command</i> .....	100
<i>Data Range</i> .....	100
<i>Query Command</i> .....	100
<i>Response message</i> .....	100
SCREEN TRIGGER .....	101
OPERATION USING HTTP BROWSER .....	102
<i>Overview</i> .....	102
<i>Preparation Before Use</i> .....	102
<i>Handling of the Address for Operation by Using a Browser</i> .....	102
<i>Configuring Network Settings</i> .....	103
<i>Structure of the HTTP Server</i> .....	105
<b>REGULATORY COMPLIANCE</b> .....	<b>107</b>
FCC WARNING .....	107
CANADA .....	107
SAFETY CERTIFICATIONS .....	107
EN 55022 WARNING .....	107



## **INTRODUCTION**

### **Packing Checklist**

Carefully unpack the projector and check that the following items are included:

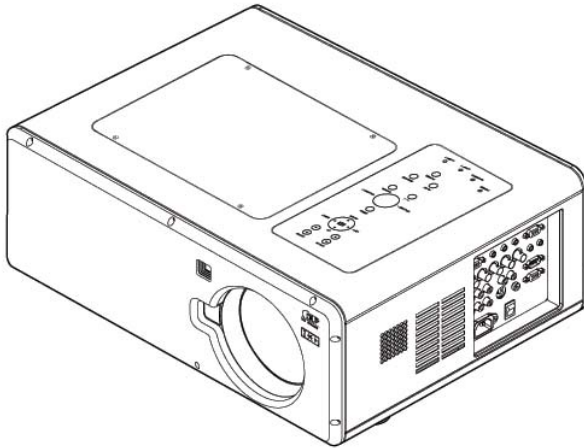

*DLP PROJECTOR*



*REMOTE CONTROL  
(WITH TWO AAA BATTERIES)*



*POWER CORD  
(FOR US MODEL)*



*POWER CORD  
(FOR CHINA MODEL)*

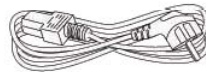

*POWER CORD  
(FOR EU MODEL)*

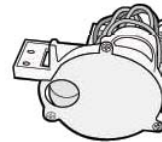

*6 SEGMENT  
COLOR WHEEL*



*VGA CABLE*



*CD-ROM  
(THIS USER'S MANUAL)*

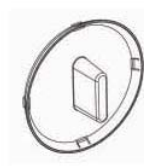

*LENS HOLE CAP  
(INSTALLED)*

Contact your dealer immediately if any items are missing, appear damaged, or if the unit does not work.

**Caution:**

*Avoid using the projector in dusty environments.*

## Views of Projector Parts

### Front-right View

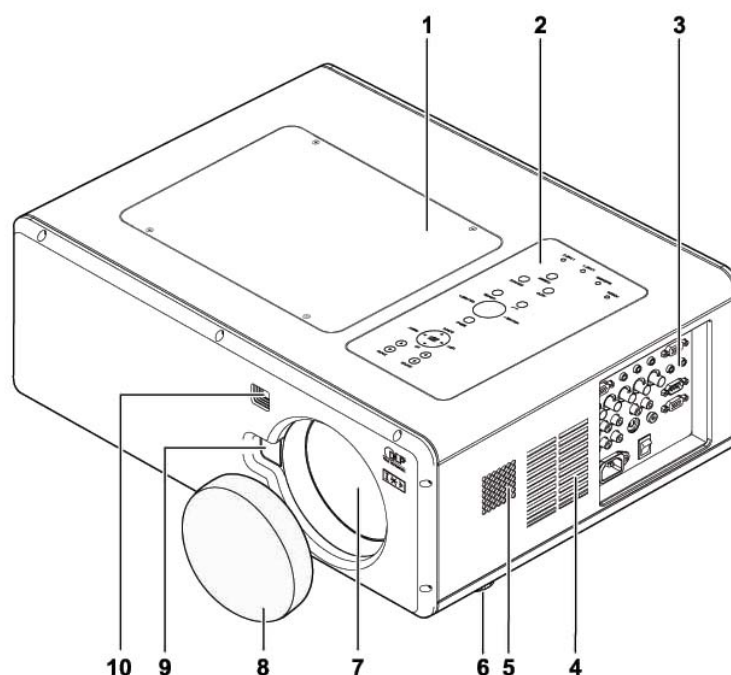

ITEM	LABEL	DESCRIPTION	SEE PAGE:
1.	Lamp cover	Remove cover to replace lamp or color wheel	83
2.	OSD control panel	See OSD Controls and Status LEDs	6
3.	I/O connector panel	Connect various input devices	8
4.	Intake vent	Lamp cooling vent – do not obstruct	
5.	Speakers	Built-in stereo speakers	
6.	Height adjuster	Adjusts level of projector	32
7.	Lens	Remove lens cap before use	
8.	Lens cap	Covers lens to protect when not in use	
9.	Lens release button	Press the release button before removing the lens	
10.	IR receiver	Receiver for IR signal from remote control	10

**Important:**

*Grill openings on the projector allow for good air circulation, which keeps the projector lamp cool. Do not obstruct any of the grill openings.*

Top view

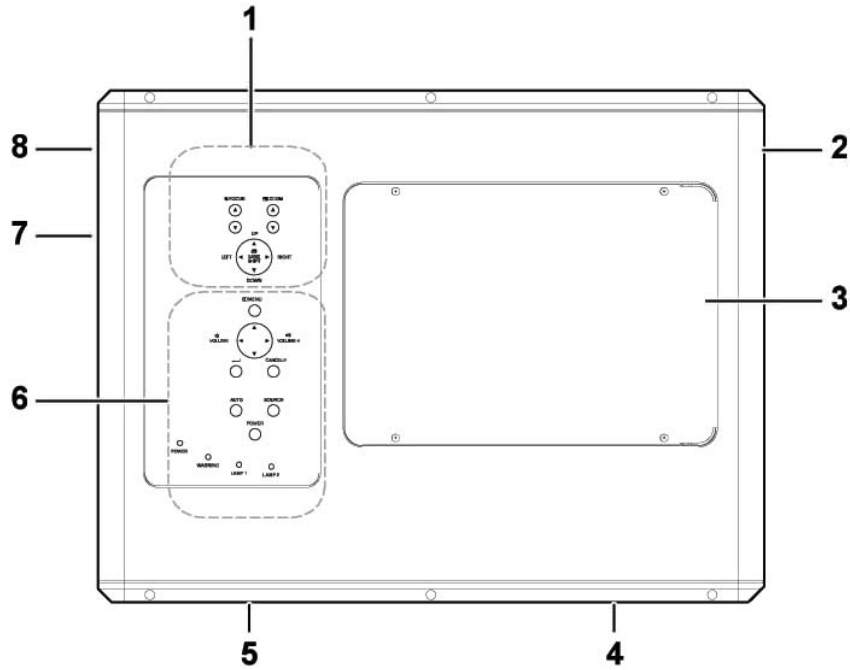

ITEM	LABEL	DESCRIPTION	SEE PAGE:
1.	Lens control panel	See Lens Controls	5
2.	Right-hand speaker	Right-hand speaker	
3.	Lamp cover	Remove cover to replace lamp or color wheel	83
4.	Exhaust vent	Exhaust vent – do not obstruct	
5.	Rear intake vent	Rear cooling intake – do not obstruct	
6.	OSD control panel	See OSD Controls and Status LEDs	6
7.	Left intake vent	Left-hand cooling intake – do not obstruct	
8.	Left-hand speaker	Left-hand speaker	

*Bottom view*

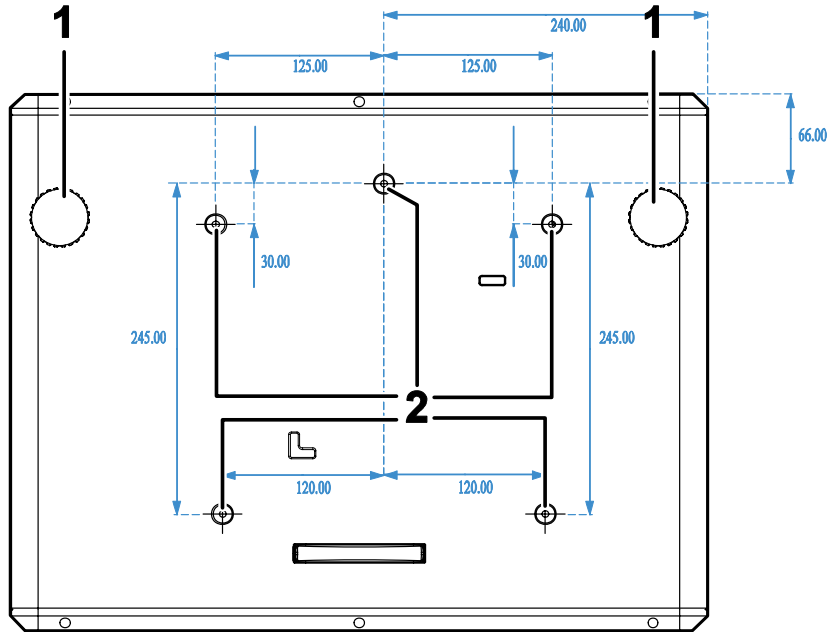

ITEM	LABEL	DESCRIPTION	SEE PAGE:
1.	Height adjusters	Adjust projection height	32
2.	Ceiling support holes	Contact your dealer for information on mounting the projector on a ceiling	

**Note:**  
When installing, ensure that you use only UL Listed ceiling mounts.

**Caution:**  
With ceiling installation, use approved mounting hardware & M4 screws; maximum depth of screw: 12 mm; distance from ceiling/ wall: 20 cm (0.7 feet) for proper ventilation; distance from fluorescent lamps: at least 1 m (3 feet) front and back of the projector. For permanent installations, follow local codes.

Top Features

*Lens Controls*

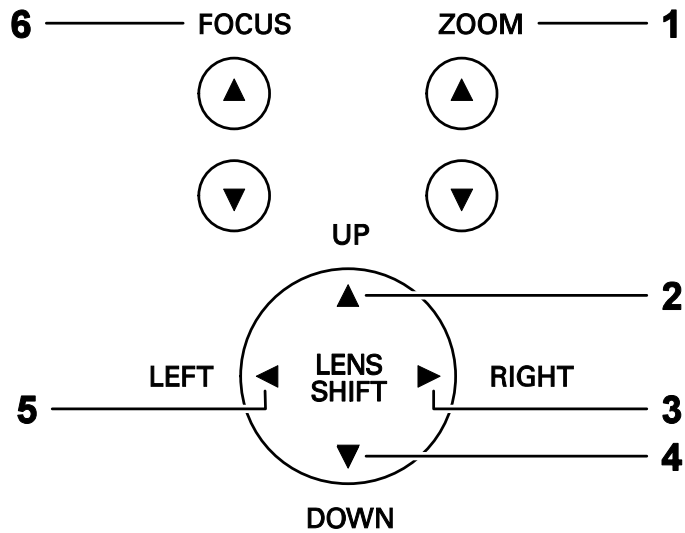

ITEM	LABEL	DESCRIPTION	SEE PAGE:
1.	ZOOM	Increase/decrease projected image size	38
2.	UP CURSOR	Move image left, right, up, or down	
3.	RIGHT CURSOR		
4.	DOWN CURSOR		
5.	LEFT CURSOR		
6.	FOCUS	Focus the projected image	38

OSD Controls and Status LEDs

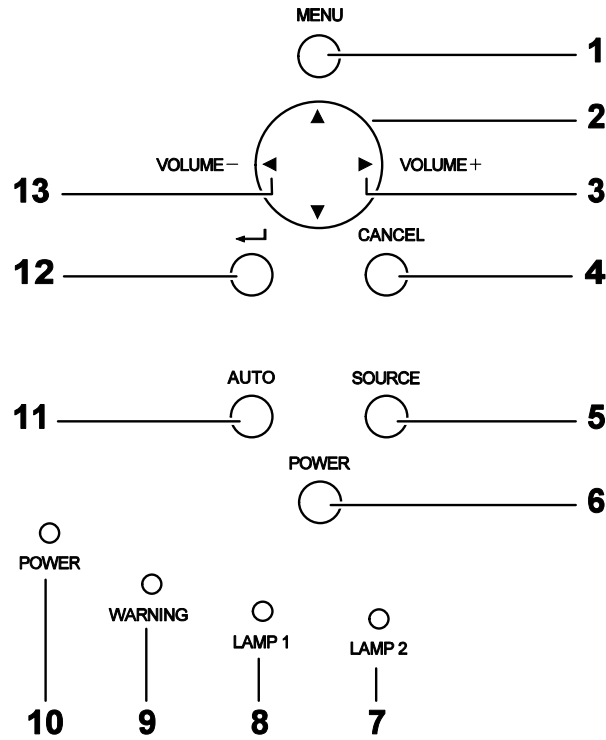

ITEM	LABEL	DESCRIPTION	SEE PAGE:	
1.	MENU	Open / Close the OSD	47	
2.	UP/ DOWN/ LEFT/ RIGHT BUTTONS	Navigate and change settings in the OSD	47	
3.	RIGHT CURSOR/ VOLUME INCREASE	Increase volume	34	
4.	CANCEL	Exit the On-Screen Display (OSD)	47	
5.	SOURCE	Detects the input device	27	
6.	POWER	Turn the projector on or off (main power switch must be turned on first). Press to place the projector in standby mode.	25	
7.	LAMP 2 (LED)	Green	See Indicator Messages	87
		Flashing		
8.	LAMP 1 (LED)	Green	See Indicator Messages	87
		Flashing		
9.	WARNING (LED)	Green	See Indicator Messages	87
		Red		
		Orange		
		Flashing		

ITEM	LABEL	DESCRIPTION		SEE PAGE:
10.	POWER (LED)	Green	See Indicator Messages	87
		Orange		
		Flashing		
11.	AUTO	Optimize image size, position, and resolution		33
12.	←	Select or change settings in the OSD		47
13.	LEFT CURSOR/VOLUME DECREASE	Decrease volume		34

**Terminal Panel Features**

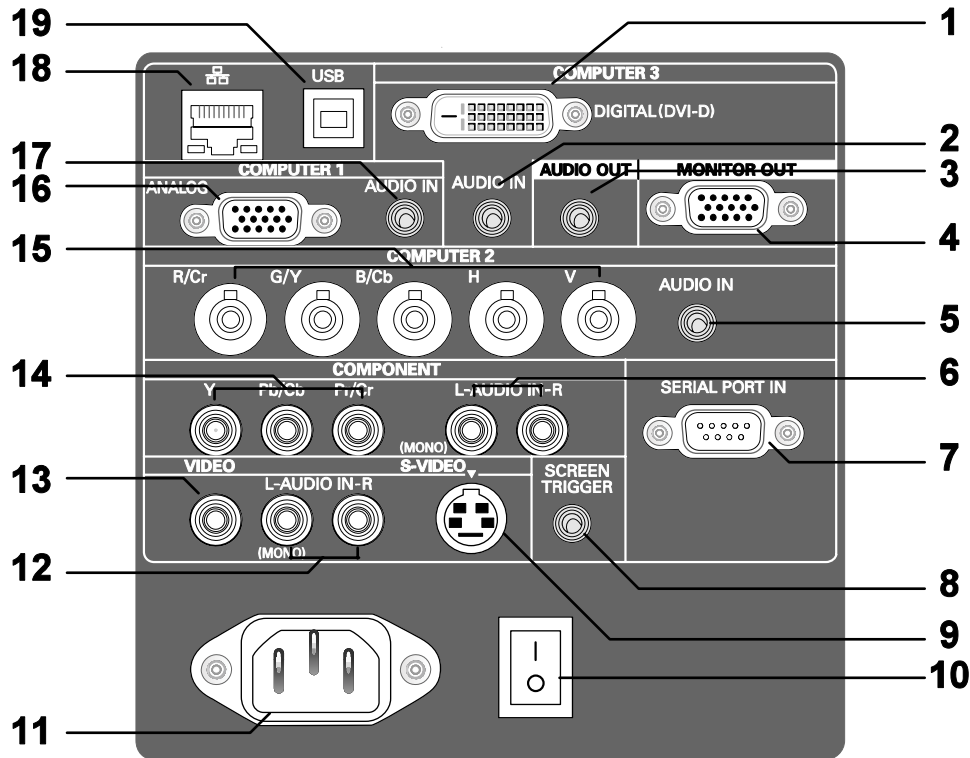

ITEM	LABEL	DESCRIPTION	SEE PAGE:
1.	COMPUTER 3 IN	Connect the DVI-D cable (not supplied) from a computer	21
2.	AUDIO IN (COMPUTER 3)	Connect the audio cable (not supplied) from the input device	
3.	AUDIO OUT	Audio loop-thru	
4.	MONITOR OUT	Connect to a monitor	
5.	AUDIO IN (COMPUTER 2)	Connect the audio cable (not supplied) from the input device	
6.	AUDIO IN [L (MONO)/R] (COMPONENT)	Connect an RCA audio cables (not supplied) from the input device right and left channels	
7.	SERIAL PORT IN	Installation control	98
8.	SCREEN TRIGGER	When connected to the screen through a commercially available cable, the screen deploys automatically on start up of the projector. The screen retracts when the projector is powered off (see notes below)	101
9.	S-VIDEO	Connect a commercially available S-video cable from a video device	24



ITEM	LABEL	DESCRIPTION	SEE PAGE:
10.	POWER SWITCH	Turn on/off the projector	35
11.	AC IN	Connect the supplied power cable	25
12.	AUDIO IN [L (MONO)/R] (VIDEO)	Connect RCA audio cables (not supplied) from the input device right and left channels. This audio jack is shared with S-Video input.	24
13.	VIDEO IN	Connect a composite video cable (not supplied) from a video device to the yellow RCA jack	23
14.	COMPONENT IN (Y, Pb/Cb, Pr/Cr)	Connect a component video enabled device	23
15.	COMPUTER 2 IN (R/Cr, G/Y, B/Cb, H, V)	Connect RGBHV or Component signal from computer or component video enabled device	24
16.	COMPUTER 1 IN	Connect a VGA cable (supplied) from a computer	21
17.	AUDIO IN (COMPUTER 1)	Connect the audio cable (not supplied) from the input device	
18.	LAN	Connect a LAN cable (not supplied) from a computer	
19.	SERVICE	Connect the USB cable (not supplied) from a computer. For service personnel only.	

**Note:**

- To use this feature, you must turn on the Screen Trigger function on the OSD.
- Screen controllers are supplied and supported by screen manufacturers.
- Do not use this jack for anything other than intended use.

**Remote Control Parts**

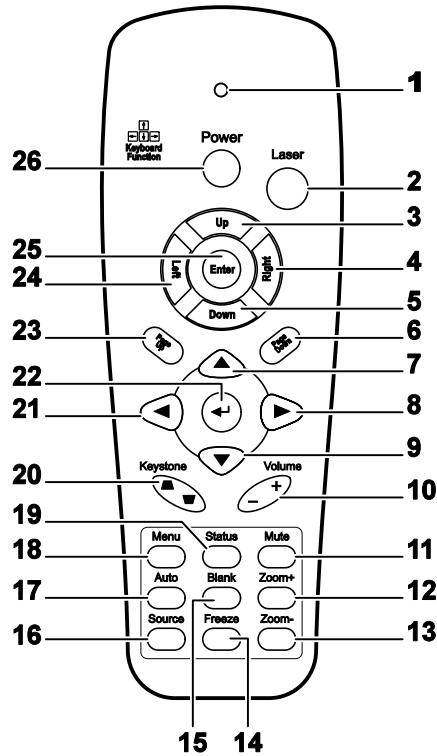

**Important:**

1. Avoid using the projector with bright fluorescent lighting turned on. Certain high-frequency fluorescent lights can disrupt remote control operation.
2. Be sure nothing obstructs the path between the remote control and the projector. If the path between the remote control and the projector is obstructed, you can bounce the signal off certain reflective surfaces such as projector screens.
3. The buttons and keys on the projector have the same functions as the corresponding buttons on the remote control. This user's manual describes the functions based on the remote control.

ITEM	LABEL	DESCRIPTION	SEE PAGE:
1.	Status LED	Lights when the remote control is used	
2.	Laser	Use as on screen pointer. DO NOT POINT IN EYES.	
3.	Up	Up arrow when connected through USB to a PC	
4.	Right	Right arrow when connected through USB to a PC	
5.	Down	Down arrow when connected through USB to a PC	
6.	Page Down	Page down when connected through USB to a PC	

ITEM	LABEL	DESCRIPTION	SEE PAGE:
7.	Up cursor	Navigates and changes settings in the OSD	47
8.	Right cursor	Navigates and changes settings in the OSD	47
9.	Down cursor		
10.	Volume +/-	Adjusts volume	34
11.	Mute	Mutes the built-in speaker	
12.	Zoom+	Zoom in	
13.	Zoom-	Zoom out	
14.	Freeze	Freeze/unfreezes the on-screen picture	
15.	Blank	Makes the screen blank	
16.	Source	Detects the input device	
17.	Auto	Auto adjustment for phase, tracking, size, position	
18.	Menu	Opens the OSD	47
19.	Status	Opens the OSD Status menu (the menu only opens when an input device is detected)	
20.	Keystone top/bottom	Corrects image-trapezoid (wider top/bottom) effect	42
21.	Left cursor	Navigates and changes settings in the OSD	47
22.	Enter	Changes settings in the OSD	47
23.	Page Up	Page up when connected through USB to a PC	
24.	Left	Left arrow when connected through USB to a PC	
25.	Enter	Enter key when connected through USB to a PC	
26.	Power	Turns the projector on or off	25

**Note:**

*The remote control can only interface with a computer when connected to the computer through a USB cable connection. The computer cable connects a computer to the projector for display purposes only.*

## Remote Control Operating Range

The remote control uses infrared transmission to control the projector. It is not necessary to point the remote directly at the projector. Provided you are not holding the remote perpendicular to the sides or the rear of the projector, the remote will function well within a radius of about 7 meters (23 feet) and 15 degrees above or below the projector level. If the projector does not respond to the remote control, move a little closer.

## Projector and Remote Control Buttons

The projector can be operated using the remote control or the buttons on the top of the projector. All operations can be carried out with the remote control; however, the buttons on the projector are limited in use. The following illustration shows the corresponding buttons on the remote control and on the projector.

### Remote Control

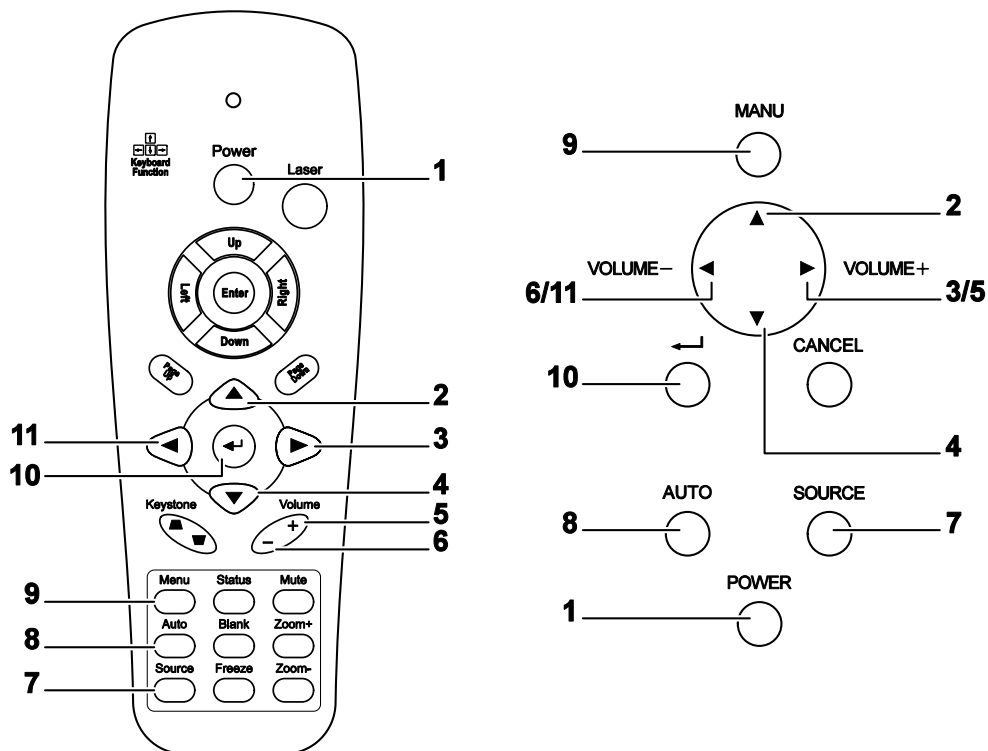

Some buttons on the projector have two functions. For example, item 6/11 on the projector functions as both the volume down button and as the left cursor key in OSD menus.

### Inserting the Remote Control Batteries

1. Remove the battery compartment cover by sliding the cover in the direction of the arrow.

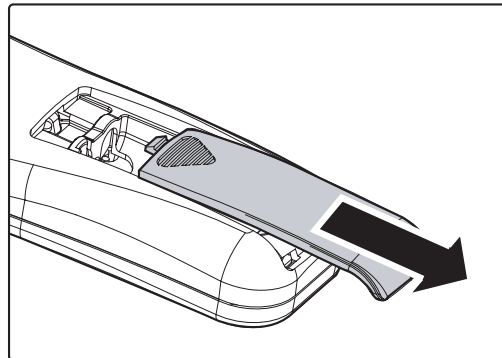

2. Insert the supplied batteries taking note of the polarity (+/-) as shown here.

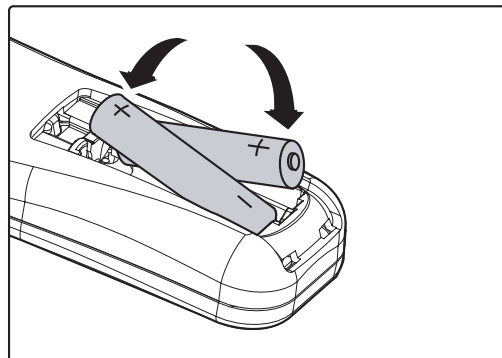

3. Replace the cover.

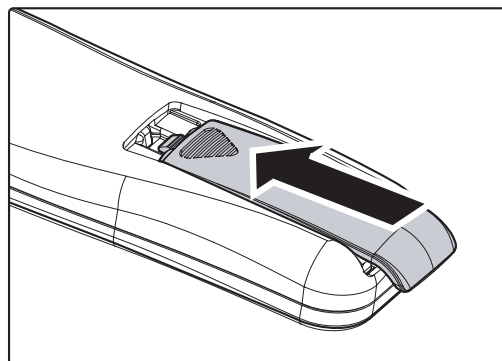

**Caution:**

1. Only use AAA batteries. (Alkaline is better).
2. Dispose of used batteries according to local ordinance regulations.
3. Remove the battery when not using the projector for prolonged periods.

## Installing or Removing the Optional Lens

**Caution:**

- Do not shake or place excessive pressure on the projector or the lens components as the projector and lens components contain precision parts.
- When shipping the projector with the optional lens, remove the optional lens before shipping the projector. The lens and the lens shift mechanism may encounter damage caused by improper handling during transportation.
- Before removing or installing the lens, be sure to turn off the projector, wait until the cooling fans stop, and turn off the main power switch.
- Do not touch the lens surface when removing or installing the lens.
- Keep fingerprints, dust or oil off the lens surface. Do not scratch the lens surface.
- Work on a level surface with a soft cloth under it to avoid scratching.
- If you remove and store the lens, attach the lens cap to the projector to keep off dust and dirt.

### Removing the Existing Lens From the Projector

1. Pull out the lens cap.

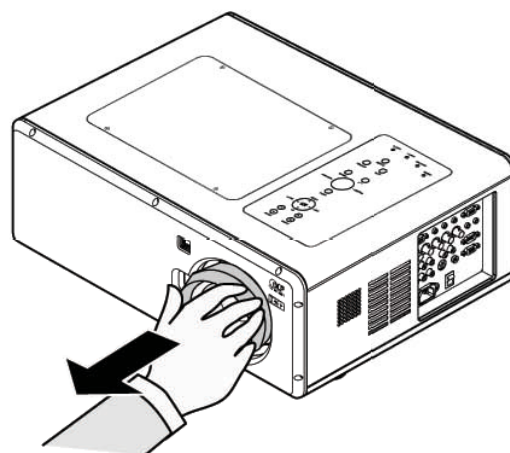

2. Push the LENS RELEASE button all the way in and rotate the lens counterclockwise.  
The existing lens will be disengaged.

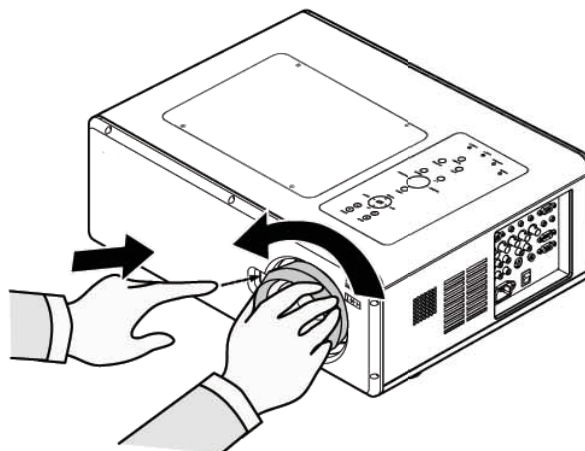

3. Pull out the existing lens slowly.

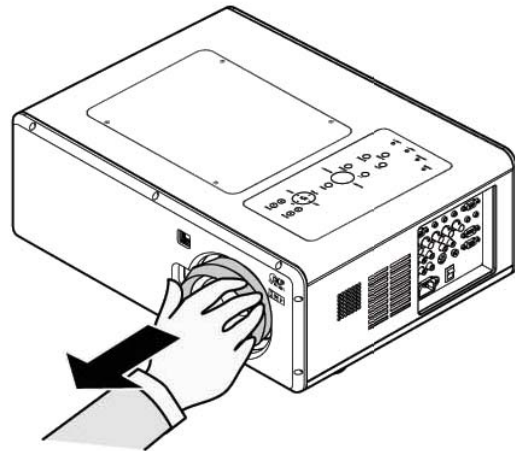

**Caution:**

When installing the lens into the projector, be sure to remove the lens cap from the back of the optional lens before installing the optional lens into the projector. Failure to do so will cause damage to the projector.

*Installing the New Lens*

1. Pull out the existing lens slowly.

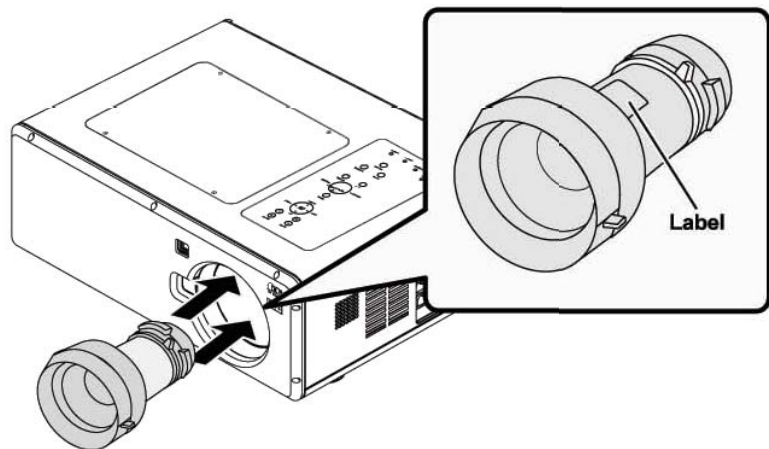

2. Rotate the lens clockwise until it clicks into place.

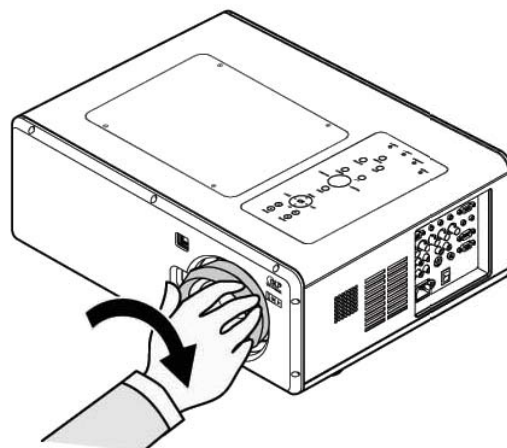



**Throw Distance and Screen Size**

Example of GB940G:

The further your projector is from the screen or wall, the larger the image. The minimum size the image can be is approximately 40 inches (1 m) measured diagonally when the projector is roughly 65 inches (1.7 m) from the wall or screen. The largest the image can be is 500 inches (12.7 m) when the projector is about 843 inches (21.4 m) from the wall or screen.

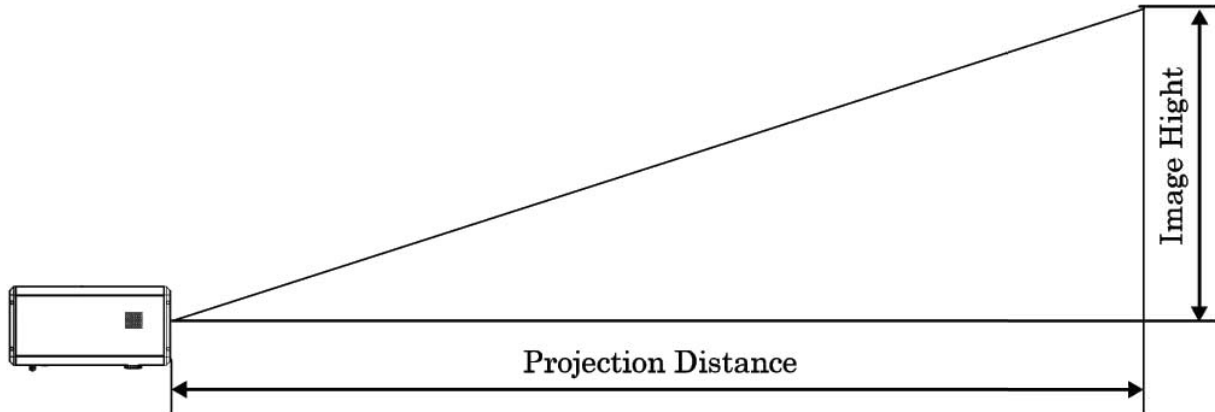

Screen Size						910 lens		911 lens		Standard	
Diagonal		Width		Height		0.77		1.33 - 1.79		1.78 - 2.35	
[inches]	[m]	[inches]	[m]	[inches]	[m]	Distance					
[inches]	[m]	[inches]	[m]	[inches]	[m]	[inches]	[m]	[inches]	[m]	[inches]	[m]
40	1.02	32	0.81	24	0.61			41.7 - 56.8	1.06 - 1.44	55.8 - 74.4	1.42 - 1.89
50	1.27	40	1.02	30	0.76	30.7	0.78	52.6 - 71.5	1.34 - 1.82	70.4 - 93.7	1.79 - 2.38
60	1.52	48	1.22	36	0.91	37.1	0.94	63.5 - 86.1	1.61 - 2.19	85.0 - 112.9	2.16 - 2.87
67	1.70	54	1.36	40	1.02	41.6	1.06	71.1 - 96.4	1.81 - 2.45	95.2 - 126.4	2.42 - 3.21
72	1.83	58	1.46	43	1.10	44.9	1.14	76.6 - 103.7	1.94 - 2.63	102.5 - 136.0	2.60 - 3.45
80	2.03	64	1.63	48	1.22	50.0	1.27	85.3 - 115.4	2.17 - 2.93	114.1 - 151.3	2.90 - 3.84
84	2.13	67	1.71	50	1.28	52.6	1.34	89.6 - 121.3	2.28 - 3.08	120.0 - 159.0	3.05 - 4.04
90	2.29	72	1.83	54	1.37	56.5	1.44	96.2 - 130.1	2.44 - 3.30	128.7 - 170.6	3.27 - 4.33
100	2.54	80	2.03	60	1.52	63.0	1.60	107.0 - 144.7	2.72 - 3.68	143.3 - 189.8	3.64 - 4.82
120	3.05	96	2.44	72	1.83	75.9	1.93	128.8 - 174.0	3.27 - 4.42	172.5 - 228.2	4.38 - 5.80
150	3.81	120	3.05	90	2.29	95.3	2.42	161.5 - 218.0	4.10 - 5.54	216.2 - 285.9	5.49 - 7.26
180	4.57	144	3.66	108	2.74	114.6	2.91	194.1 - 261.9	4.93 - 6.65	260.0 - 343.6	6.60 - 8.73
200	5.08	160	4.06	120	3.05	127.6	3.24	215.9 - 291.2	5.48 - 7.40	289.1 - 382.0	7.34 - 9.70
210	5.33	168	4.27	126	3.20			226.8 - 305.9	5.76 - 7.77	303.7 - 401.3	7.71 - 10.19
240	6.10	192	4.88	144	3.66			259.5 - 349.8	6.59 - 8.89	347.5 - 458.9	8.83 - 11.66
261	6.63	209	5.30	157	3.98			282.3 - 380.6	7.17 - 9.67	378.1 - 499.3	9.60 - 12.68
270	6.86	216	5.49	162	4.11			292.1 - 393.8	7.42 - 10.00	391.2 - 516.6	9.94 - 13.12
300	7.62	240	6.10	180	4.57			324.8 - 437.7	8.25 - 11.12	435.0 - 574.3	11.05 - 14.59
350	8.89	280	7.11	210	5.33			379.2 - 511.0	9.63 - 12.98	507.9 - 670.4	12.90 - 17.03
400	10.16	320	8.13	240	6.10			433.7 - 584.3	11.02 - 14.84	580.8 - 766.5	14.75 - 19.47
450	11.43	360	9.14	270	6.86			488.1 - 657.5	12.40 - 16.70	653.7 - 862.6	16.60 - 21.91
500	12.70	400	10.16	300	7.62			542.6 - 730.8	13.78 - 18.56	726.6 - 958.7	18.46 - 24.35



Screen Size						912 Lens		913 Lens	
Diagonal		Width		Height		2.22 - 4.43		4.43 - 8.3	
Distance									
[inches]	[m]	[inches]	[m]	[inches]	[m]	[inches]	[m]	[inches]	[m]
40	1.02	32	0.81	24	0.61	69.4 - 142.3	1.76 - 3.61	139.2 - 266.9	3.54 - 6.78
50	1.27	40	1.02	30	0.76	87.8 - 178.9	2.23 - 4.54	175.3 - 335.0	4.45 - 8.51
60	1.52	48	1.22	36	0.91	106.2 - 215.5	2.70 - 5.47	211.5 - 403.1	5.37 - 10.24
67	1.70	54	1.36	40	1.02	119.0 - 241.2	3.02 - 6.13	236.8 - 450.8	6.01 - 11.45
72	1.83	58	1.46	43	1.10	128.2 - 259.5	3.26 - 6.59	254.8 - 484.9	6.47 - 12.32
80	2.03	64	1.63	48	1.22	142.9 - 288.8	3.63 - 7.34	283.7 - 539.4	7.21 - 13.70
84	2.13	67	1.71	50	1.28	150.3 - 303.5	3.82 - 7.71	298.2 - 566.6	7.57 - 14.39
90	2.29	72	1.83	54	1.37	161.3 - 325.4	4.10 - 8.27	319.9 - 607.5	8.12 - 15.43
100	2.54	80	2.03	60	1.52	179.7 - 362.1	4.56 - 9.20	356.0 - 675.6	9.04 - 17.16
120	3.05	96	2.44	72	1.83	216.4 - 435.3	5.50 - 11.06	428.3 - 811.8	10.88 - 20.62
150	3.81	120	3.05	90	2.29	271.6 - 545.2	6.90 - 13.85	536.6 - 1016.1	13.63 - 25.81
180	4.57	144	3.66	108	2.74	326.7 - 655.1	8.30 - 16.64	645.0 - 1220.5	16.38 - 31.00
200	5.08	160	4.06	120	3.05	363.5 - 728.3	9.23 - 18.50	717.3 - 1356.7	18.22 - 34.46
210	5.33	168	4.27	126	3.20	381.9 - 765.0	9.70 - 19.43	753.4 - 1424.8	19.14 - 36.19
240	6.10	192	4.88	144	3.66	437.0 - 874.9	11.10 - 22.22	861.8 - 1629.1	21.89 - 41.38
261	6.63	209	5.30	157	3.98	475.6 - 951.8	12.08 - 24.18	937.7 - 1772.2	23.82 - 45.01
270	6.86	216	5.49	162	4.11	492.2 - 984.7	12.50 - 25.01	970.2 - 1833.5	24.64 - 46.57
300	7.62	240	6.10	180	4.57	547.3 - 1094.6	13.90 - 27.80	1078.6 - 2037.8	27.40 - 51.76
350	8.89	280	7.11	210	5.33	639.2 - 1277.8	16.24 - 32.46	1259.2 - 2378.3	31.98 - 60.41
400	10.16	320	8.13	240	6.10	731.1 - 1460.9	18.57 - 37.11	1439.9 - 2718.9	36.57 - 69.06
450	11.43	360	9.14	270	6.86	823.0 - 1644.0	20.90 - 41.76	1620.5 - 3059.4	41.16 - 77.71
500	12.70	400	10.16	300	7.62	914.9 - 1827.2	23.24 - 46.41	1801.2 - 3400.0	45.75 - 86.36

**Caution:**

*Ceiling installation must be done by a qualified professional. Contact your dealer for more information.*

*It is not recommended you install the projector yourself.*

*Only use the projector on a solid, level surface. Serious injury and damage can occur if the projector is dropped.*

*Do not use the projector in an environment where extreme temperature occurs. The projector must be used at temperatures between 41 degrees Fahrenheit (5 degrees Celsius) and 104 degrees Fahrenheit (40 degrees Celsius).*

*Screen damage will occur if the projector is exposed to moisture, dust or smoke.*

*Do not cover the vents on the projector. Proper ventilation is required to dissipate heat. Damage to the projector will occur if the vents are covered.*

## Installing the Optional Color Wheel

The projector comes with a four-segment color wheel installed. An additional six-segment color wheel is optional. To replace the color wheel (located under the lamp cover adjacent to lamp 1) refer to the following guide.

**Note:**

*Wait until the lamp house and the color wheel cool off.*

1. Remove the four screws (A) on the lamp cover.
2. Lift the lamp cover in the direction of the arrow (B).

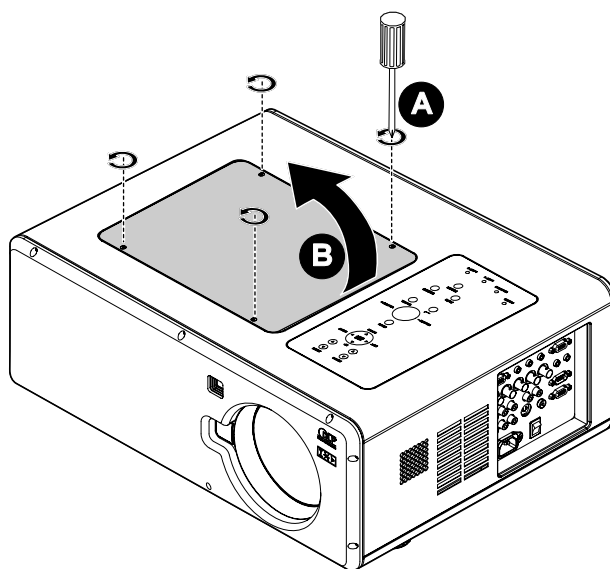

3. Unscrew the retaining screws (x 4) on the four-segment color wheel.

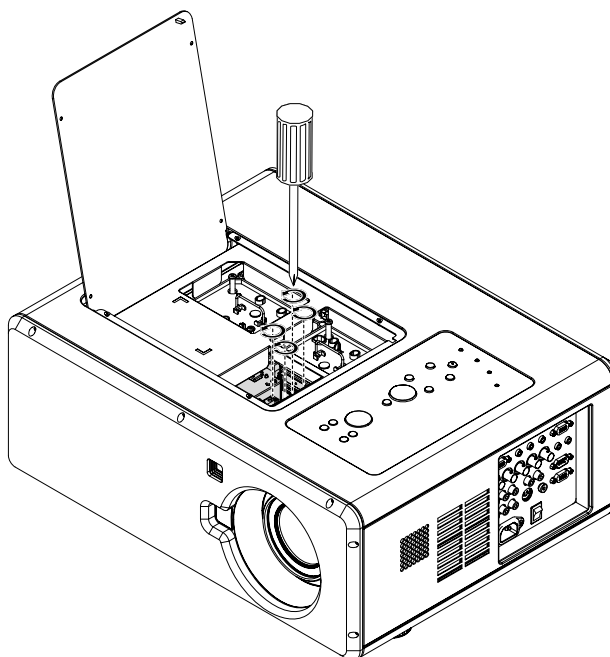

- 4.** Lift the color wheel in the direction shown.

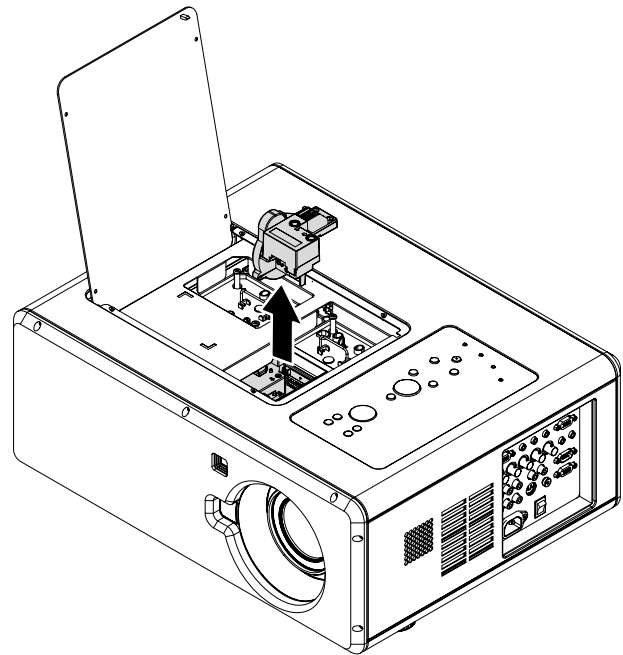

- 5.** Insert the six-segment color wheel

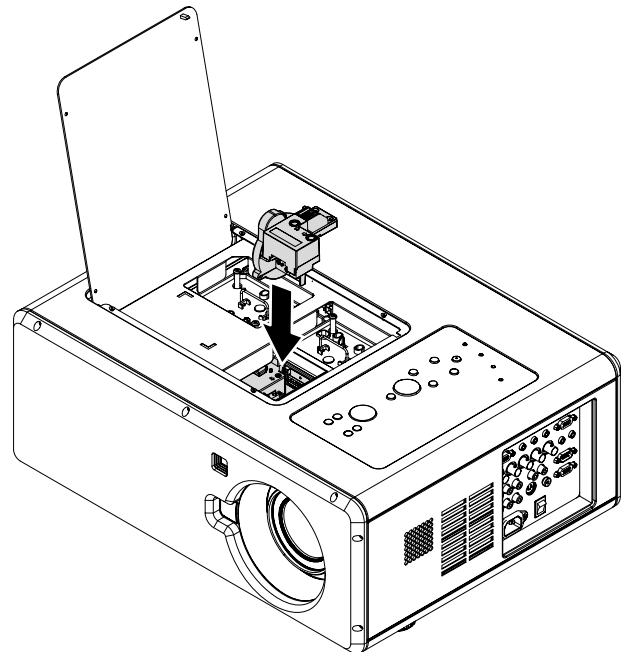

- 6.** Close the lamp cover and secure the retaining screws as shown.

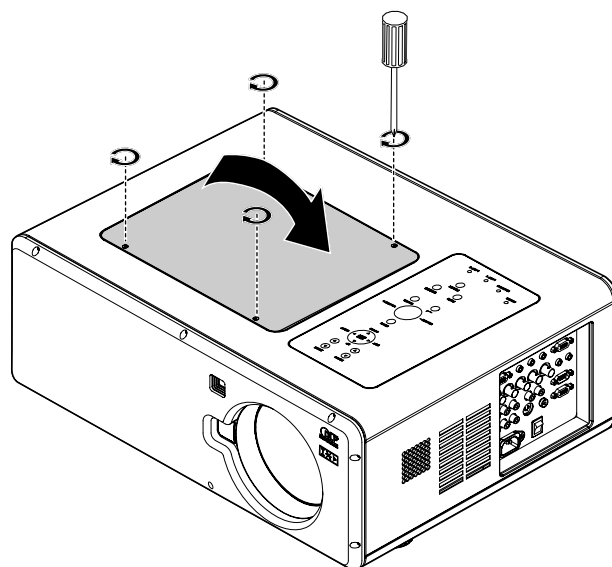

**Storing Unused Color Wheel:**

Keep the unused color wheel in the zipper bag in which the 6-segment color wheel (not supplied) was packaged.

This bag prevents dust from falling or collecting on the color wheel.

## Making Connections

### Connecting Your PC or Macintosh Computer

Enabling the computer's external display:

Displaying an image on the notebook PC's screen does not necessarily mean it outputs a signal to the projector. When using a PC compatible laptop, a combination of function keys will enable/disable the external display. Usually, the combination of the **Fn-key** along with one of the 12 function keys activates the external display.

To connect a PC or Macintosh computer to the projector, refer to the following guide.

1. Connect a computer to the projector through one of the three available input data connections before turning on the PC or the projector. The best signal order (from best to least suitable) is as follows:

- Computer 3 in (see Terminal Panel Features on page 8) is a digital signal and offers the best connection to your computer.

**Note:**

The DVI (DIGITAL) connector (COMPUTER 3) accepts VGA (640 x 480), 1152 x 864, XGA (1024 x 768), SXGA (1280 x 1024@up to 60Hz) and UXGA(1600 x 1200 @ 60Hz).

- Computer 2 in (see Terminal Panel Features on page 8) is an analog signal; use a DSUB-15 cable-to-5BNC connection.
- Computer 1 in as shown below (see Terminal Panel Features on page 8) is an analog signal that uses a standard RGB computer cable.

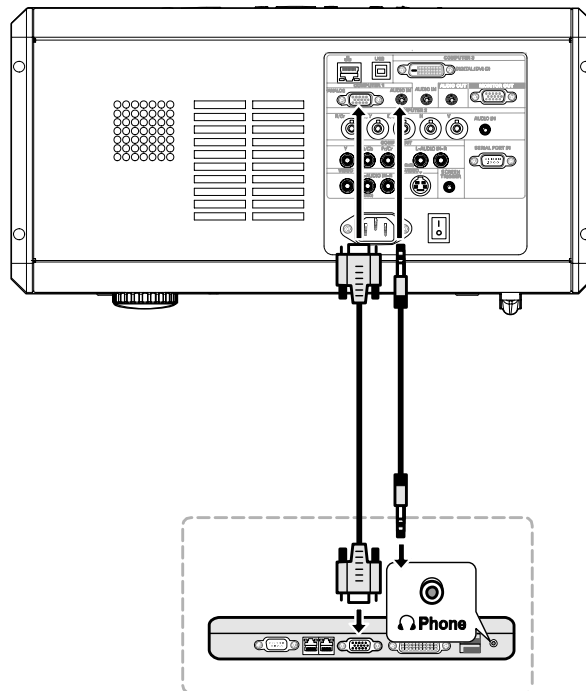

2. Turn on the projector and select the chosen method of connection from the source menu before turning on the PC (see Selecting an Input Source on page 27).
3. Turn on the PC.

**Note:**

Failure to follow the above steps may not activate the digital output of the graphics card resulting in no picture being displayed. Should this happen, restart your PC.

*Connecting an External Monitor*

Connect an external monitor to the projector through RGB out connections as shown below (see Terminal Panel Features on page 8).

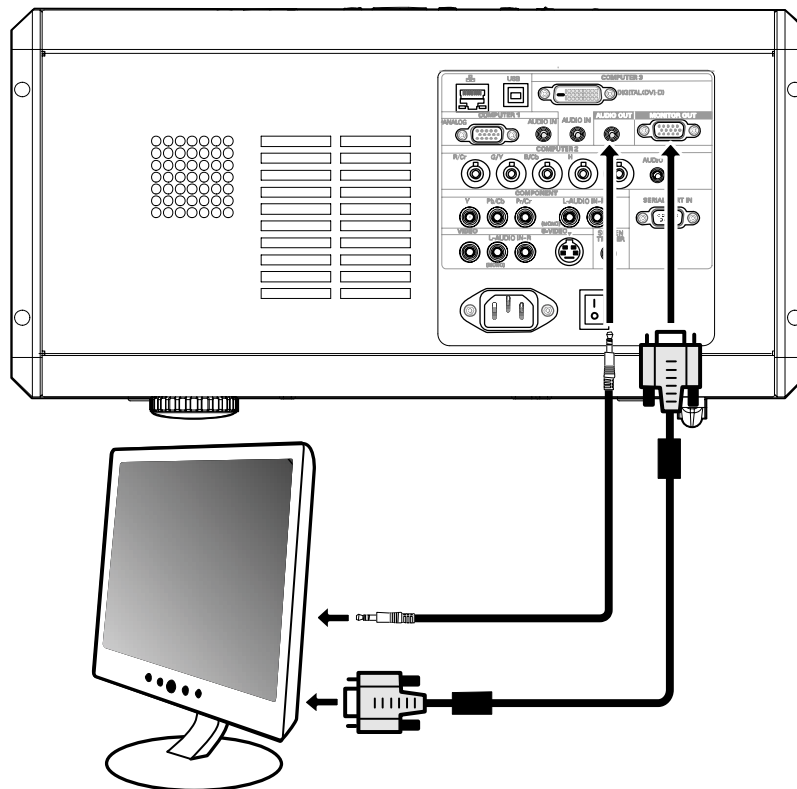

Connecting Your DVD Player with Component Output

To connect a DVD Player to the projector, refer to the following guide.

1. Connect the DVD Player to the projector as shown below before turning on the Player or the projector.

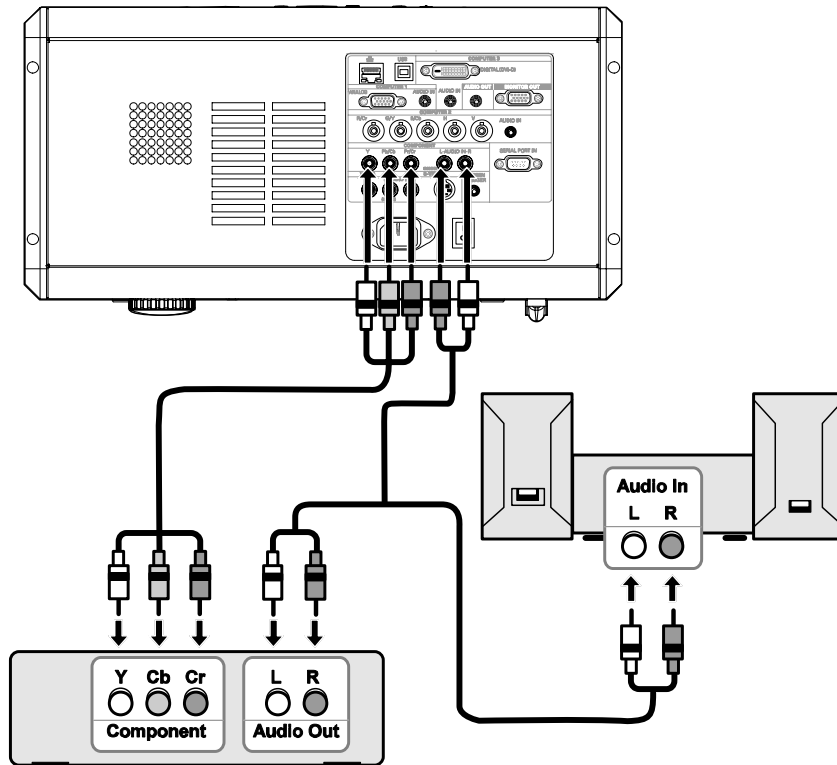

2. Turn on the projector and select **Component** from the source menu before turning on the DVD Player (see [Selecting an Input Source on page 27](#)).
3. Turn on the DVD Player.

**Note:**

*Refer to your DVD player's user's manual for more information about your DVD player's video output requirements.*

***Connecting Your VCR or Laser Disc Player***

To connect your VCR or Laser Disc Player, refer to the following diagram.

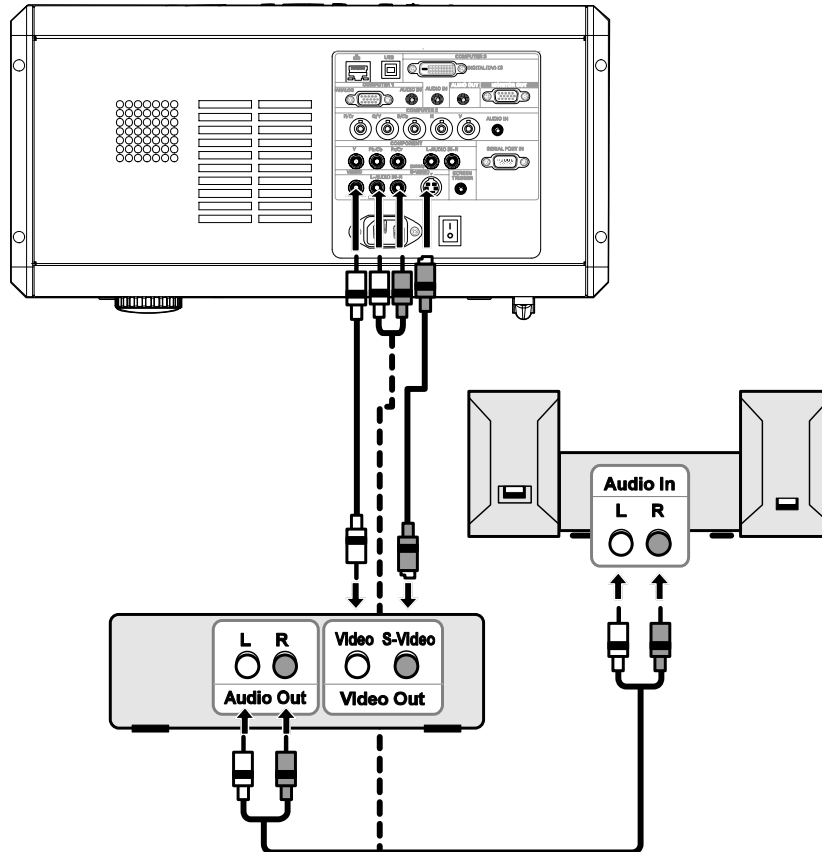

**Note:**

Refer to your VCR or laser disc player user's manual for more information about your device's requirements. Images may not be displayed correctly when using an S-Video or Video connection to fast-forward or fast-rewind scanning.

The AUDIO IN RCA jack is shared between VIDEO IN and S-VIDEO IN.



## PROJECTING AN IMAGE (BASIC OPERATION)

### Turning on the Projector

Once the projector is correctly located and the power cable and other connections are in place, it is important that the projector is powered on correctly in order to avoid damage to components and unnecessary wear and tear. Refer to the following guide to power on the projector.

1. Connect the power cable (A). Press the main power switch to the on ( I ) position as shown (B). All four LEDs light orange, then the Lamp1 and 2 LEDs turn off and the Warning LED lights green.
2. Press the **POWER** button once (see OSD Controls and Status LEDs on page 6). The Power LED flashes green and the internal cooling fan starts.
3. After approximately 10 seconds, the Lamp1 and Lamp2 LEDs light green and the Power LED flashes more rapidly.
4. Once the power LED is lit a solid green, the projector is ready for use.

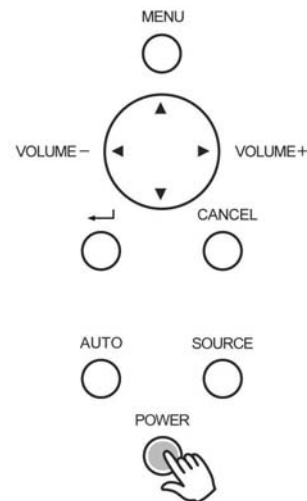
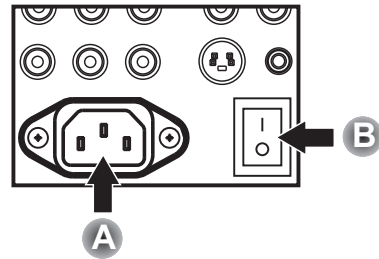

**Note:**

*If any of the LEDs remain flashing or blink there may be a problem with the startup. Please refer to the Troubleshooting section on page 87.*

*Note on Startup Screen (Menu Language Select screen)*

In the first instance of powering on the projector, the language menu is displayed to select the default language.

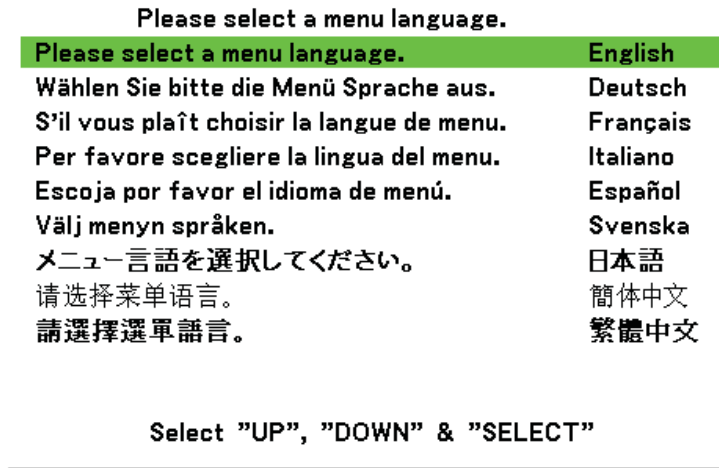

Select the required default language using the ▲ or ▼ buttons on the OSD menu panel or the remote control unit and press ←.

**Note:**

*The language select screen only appears on the first instance of power on. All subsequent operations assume the selected default language. To change the default see page 65.*

## Selecting an Input Source

The Input Source can be selected from the projector's control panel or from the remote control unit. Refer to the following guide to select the Input Source.

1. Press **Menu** on the OSD control panel or on the remote control unit to display the **Main Menu**. Scroll to the **Input** menu using ▲ or ▼ and press ↵.

**Note:**

Return to the projected image by pressing **Cancel** twice.

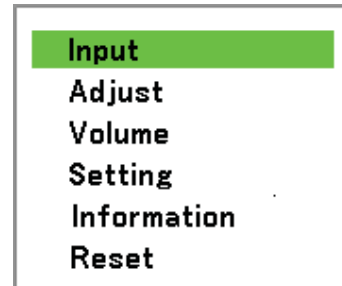

2. Select the required source using ▲ or ▼ and press ↵.

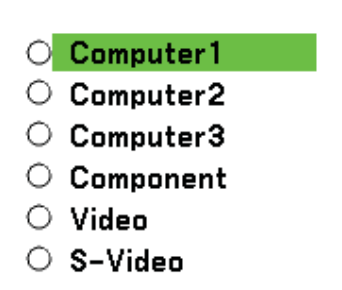

## Adjusting the Picture Position and Picture Size

The Picture Position and Picture Size can be adjusted manually from the lens control panel or from the remote control unit. Refer to the following guides to adjust Picture Position manually.

### Adjusting Picture Position Manually

1. Press the **Lens Shift** keypad on the projector in any direction to bring up the Lens Shift window.

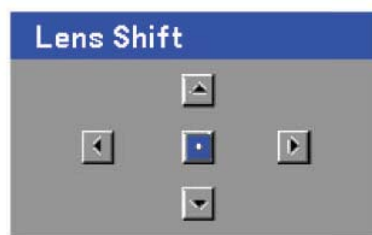

2. Press the directional key as required to shift the image. Releasing the directional arrow will re-center the cursor.

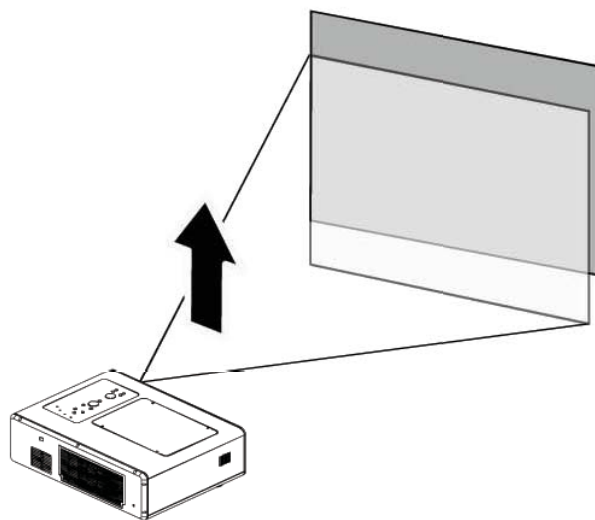

3. To alter the picture size, press **Menu** and select the **Adjust** menu using **▲** or **▼**. Press **↵** to open the **Adjust** menu. Press **◀** or **▶** to select **Image Options** followed by **▲** or **▼** to select **Screen**. Press **↵**.

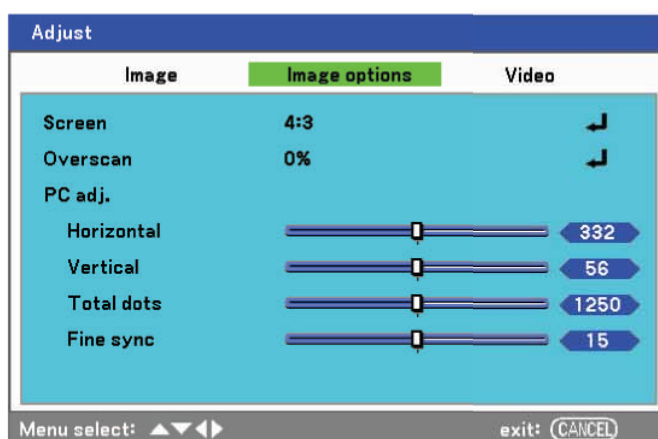

- The **Screen** window is displayed. Select the desired picture size using **▲** or **▼** and press **←**.

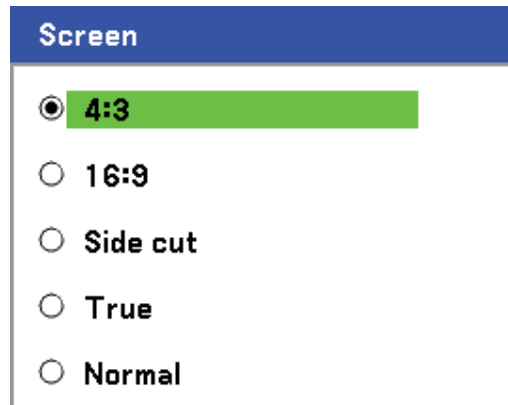

- When finished, press **Cancel** to return to the projected image.

Lens Shift Adjustable Range

The adjustable range for lens shift is tabulated below and subject to the conditions listed.

**Note:**  
The drawings below apply to the standard lens only.

**Desktop front projection**

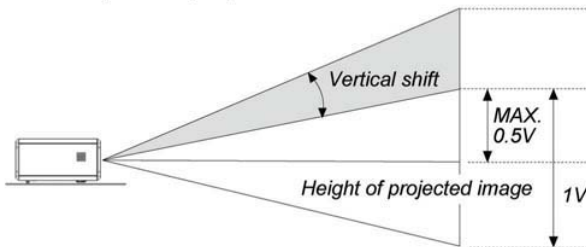

**Ceiling front projection**

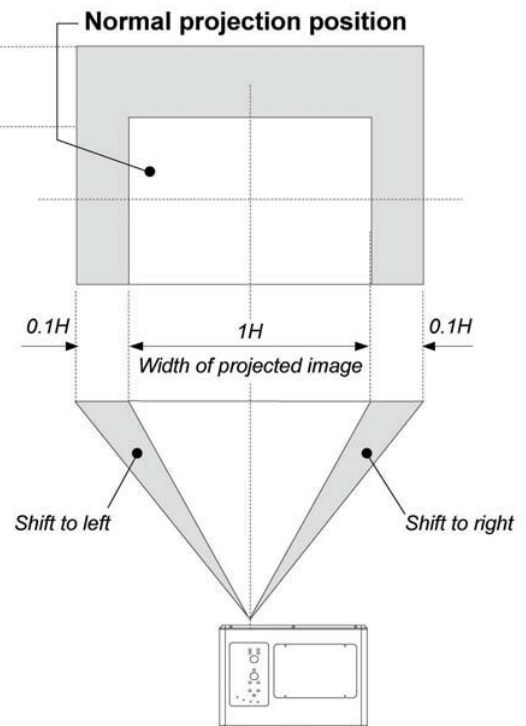
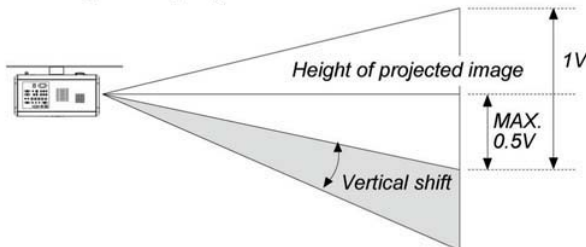

*From the Remote Control Unit*

1. Press **Menu** and select the **Setting** menu using ▲ or ▼. Press ⏏ to open the **Setting** menu. Press ◀ or ▶ to select **Basic** followed by ▲ or ▼ to select **Lens Shift**. Press ⏏.



2. The **Lens Shift** window displays.

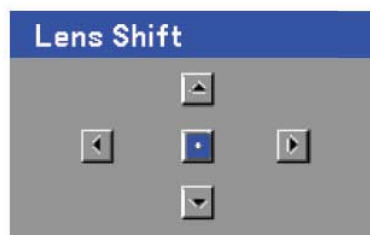

3. Press the directional buttons as required to shift the image. Releasing the directional arrow will re-center the cursor.

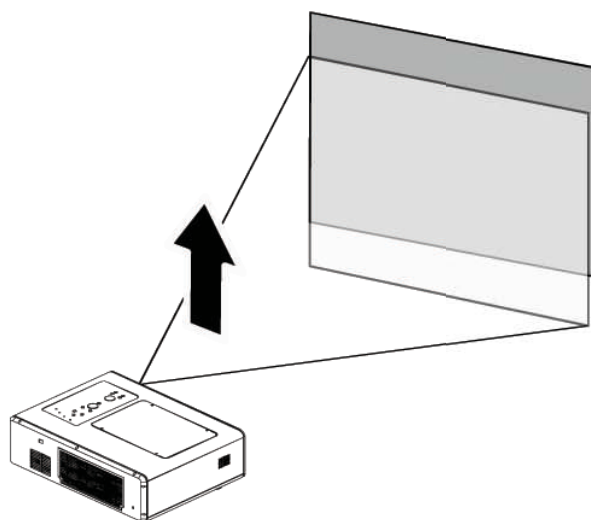

4. To alter the picture size, press **Menu** and select the **Adjust** menu using **▲** or **▼**. Press **←** to open the **Adjust** menu. Press **←** or **→** to select **Image Options** followed by **▲** or **▼** to select **Screen**. Press **←**.

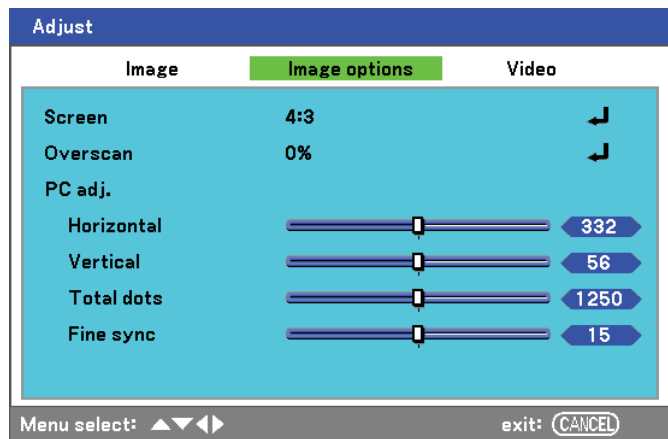

5. Select the desired picture size using **▲** or **▼** and press **←**.

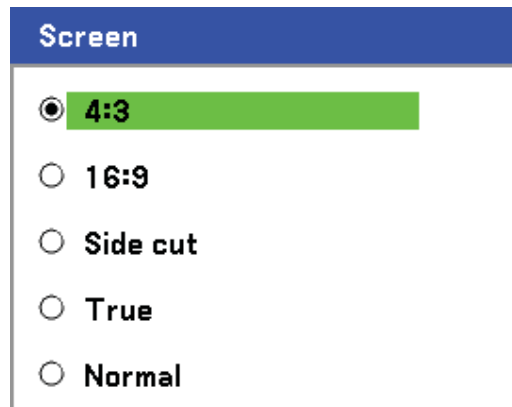

6. When finished, press **Menu** to return to the projected image.

***Adjusting the Projector Level***

- 1.** To raise the level of the projector, twist the adjusters clockwise.

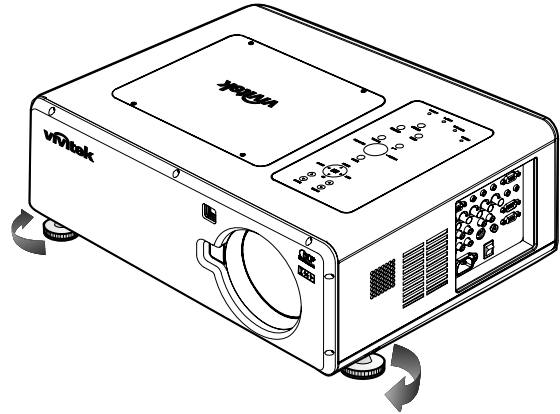

- 2.** To lower the level of the projector, lift the projector and twist the adjusters counter clockwise.

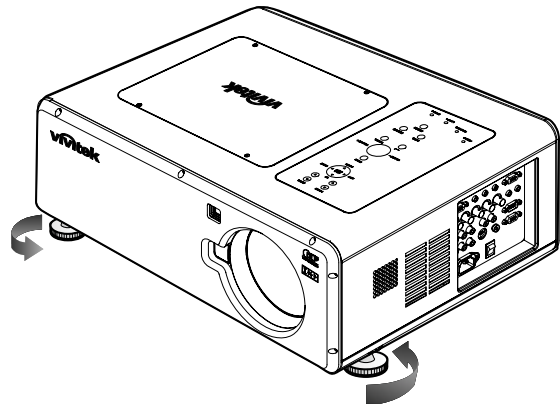



## Optimizing an RGB Image Automatically

### *Adjusting the Image Using AUTO*

To optimize an RGB image automatically refer to the following guide.

Press the Auto button on the remote control (see Remote Control Parts on page 10) or the AUTO button on the OSD control panel to optimize an RGB image automatically.

This adjustment may be necessary when you connect your computer for the first time.

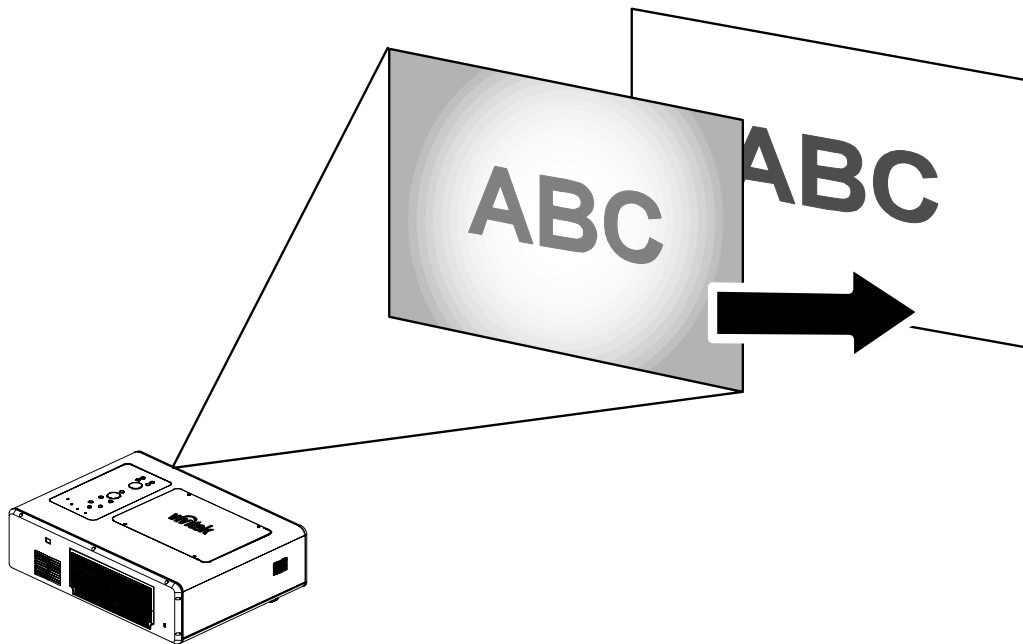

## Adjusting Volume Up and Down

The volume can be adjusted from the OSD Control Panel or with the Remote Control unit. Refer to the following as a guide.

1. Press the **Volume +/-** buttons on the remote control or the ◀ ▶ buttons on the OSD control panel. The volume level is displayed on screen.
2. Use the **Volume +/-** buttons or the ◀ ▶ buttons on the OSD control panel to adjust the level.

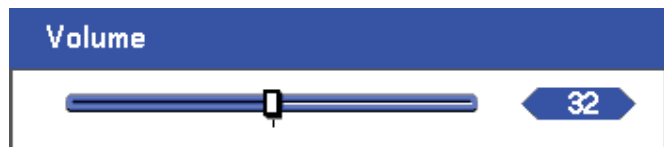
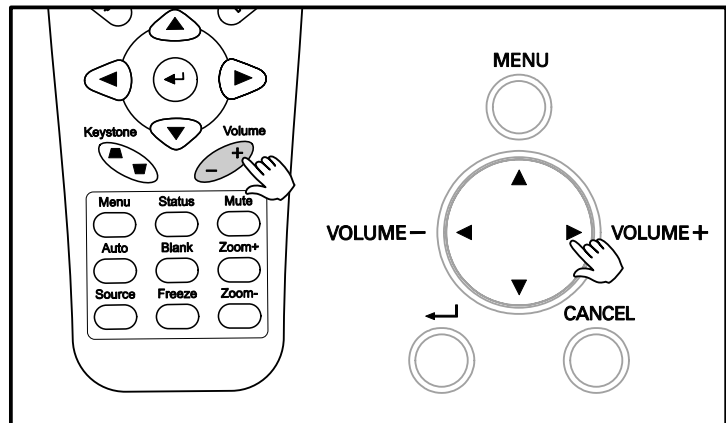

## Turning off the Projector

Once the projector is no longer required, it is important to shut it down correctly to avoid damage or unnecessary wear and tear to the projector.

**Note:**

- Do not unplug the power cable from the wall outlet or projector when the projector is powered on. Doing so can cause damage to the AC IN connector of the projector and (or) the prong plug of the power cable. To turn off the AC power supply when the projector is powered on, use a power strip equipped with a switch and a breaker.
- Do not turn off the AC power supply within 10 seconds of making adjustment or setting changes and closing the menu. Doing so can cause loss of adjustments and settings and return to default.

Refer to the following guide to shut down the projector.

1. Press the **POWER** button once. The Power Off window displays.



2. Press the **POWER** button or again on the OSD control panel or remote control to verify power off. The cooling fans continue to operate (cooling-off time) and the power LED flashes orange. The cooling fans stop operating when the projector turns off.

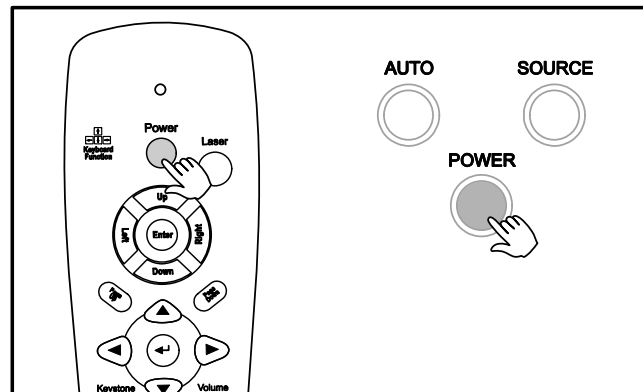

3. The projector enters Standby mode when the power LED lights orange and the warning LED lights green.

Please wait a moment.

4. Press the Main Power switch to the off position (O) to turn off the projector.

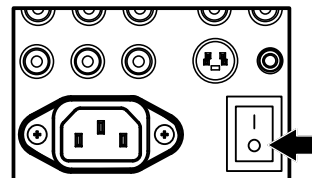

### *About Direct Power Off*

The projector has a feature called "Direct Power Off". This feature allows the projector to be turned off (even when projecting an image) using a power strip equipped with a switch and a breaker.

**Note:**

*Before using Direct Power Off, be sure to allow at least 20 minutes immediately after turning on the projector and starting to display an image.*

### *After Use*

Preparation: Make sure that the projector is turned off.

1. Unplug the power cable.
2. Disconnect any other cables.
3. Return the height adjusters to their original, minimum position.
4. Cover the lens with the lens cap.

### Turning Off the Image and Sound

The projected image and sound can be turned off for short periods of time with the remote control. This feature is useful for breaking up presentations or for other brief interruptions in projections. To turn off the picture and image, refer to the following guide.

1. Press the **Blank** button on the remote control once (see Remote Control Parts on page 10).
2. The image does not display.
3. To resume projection, press the **Blank** button once more.

**Note:**

*For extended periods of time it is recommended that the projector be powered off.*

### Freezing a Picture

The projected image can be frozen for short periods of time by using the remote control. This feature is useful for capturing still images from movies or freezing an animation at a particular point. To freeze the projected image, refer to the following guide.

1. Press the **Freeze** button on the remote control once (see Remote Control Parts on page 10).
2. The screen freezes.
3. To resume, press the **Freeze** button once more.

**Note:**

*For extended periods of time it is recommended that the projector be powered off.*

## Adjusting the Focus/Zoom Manually

The focus and zoom can be adjusted manually from the projector focus/zoom panel. Refer to the following guides to adjust the focus and zoom manually.

### *Adjusting by Using the OSD Control Panel*

1. Press the **Focus** or **Zoom** button on the projector panel to display the appropriate window.

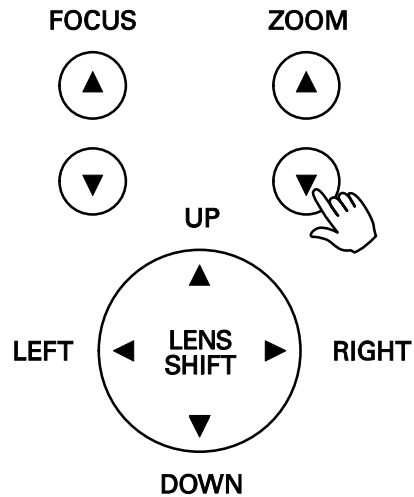

2. Adjust the Focus/Zoom using the increase and decrease buttons as required.



3. Press **Cancel** to return to the projected image.

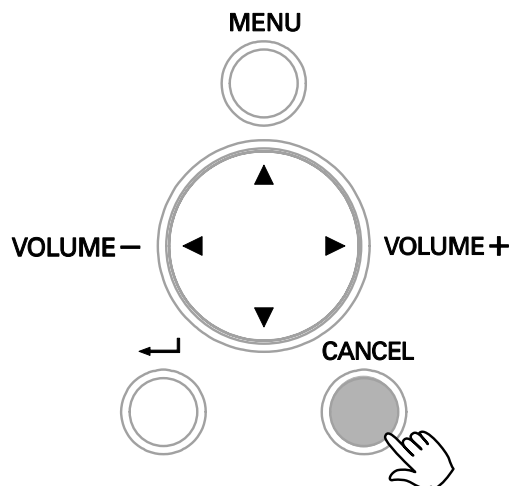

## Changing Lamp Mode

The projector has two lamp modes available, **Normal** and **Eco**. The **Normal** mode is used for every-day standard projection, whereas the **Eco** mode is used for saving power and lamp life. To change the Lamp Mode, refer to the following guides.

### *Changing Lamp Mode by Using the Projector's OSD Control Panel*

1. Press **Menu** on the projector's OSD control panel to display the **Main** menu. Scroll to the **Setting** menu using **▲** or **▼** and press **◀**.

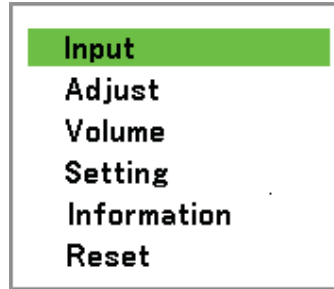

2. Select the **Basic** tab using **◀** or **▶** and select **Lamp control** using **▲** or **▼**. Press **◀**.

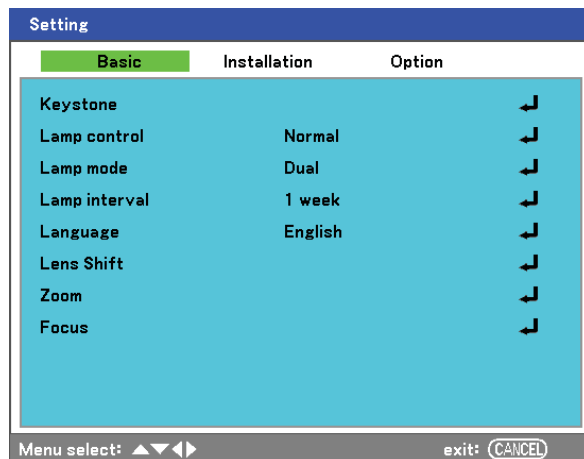

3. From the **Lamp control** window, select **Normal** or **Eco** using **▲** or **▼**. Select **OK** and press **◀**.

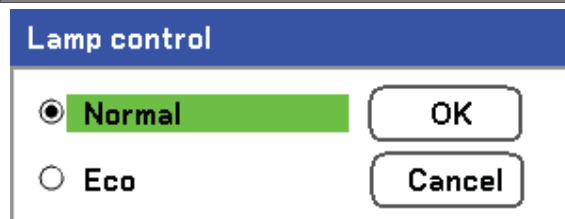

**Note:**

When the projector is in Eco mode, brightness may be affected.

Normal Mode: 100% Brightness

Eco Mode: approx. 85% Brightness

## Getting Information

The Information screen provides details on the life of consumable items within the projector as well as other information such as software version. To access the Information screen, refer to the following guide.

1. Press **Menu** on the projector's OSD control panel or remote control to display the **Main Menu**. Scroll to the **Information** menu using **▲** or **▼** and press **←**.

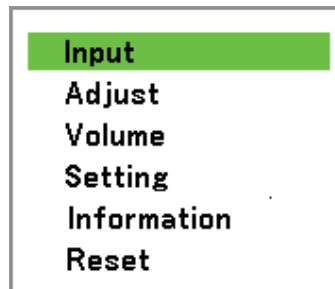

2. The **Usage time** menu is displayed as the default view. The menu items in this screen are for display and cannot be modified.

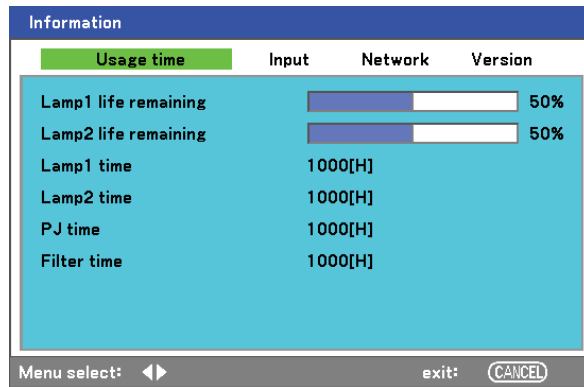

3. Press **Cancel** or **Menu** to return to the projected image.



## Adjusting Position/Total Dots/Fine Sync

The Position/Total dots/Fine sync and Keystone Correction can be adjusted manually from the projector's control panel or from the remote control unit. Refer to the following guides to adjust the Keystone Distortion manually.

### *Adjusting Position/Total Dots/Fine Sync by using the OSD Control Panel*

1. Press the **Menu** button to display the Main menu. Select the **Adjust** menu using ▲ or ▼ and press ◀ to display the **Adjust** menu.

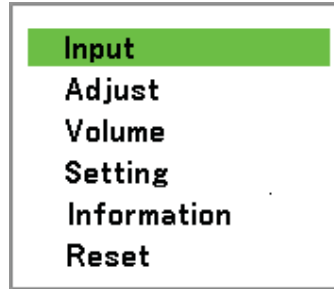

2. From the **Adjust** menu, press ◀ or ▶ to select Image Options and scroll using ▲ or ▼ to **Horizontal, Vertical, Total dots, or Fine sync**.

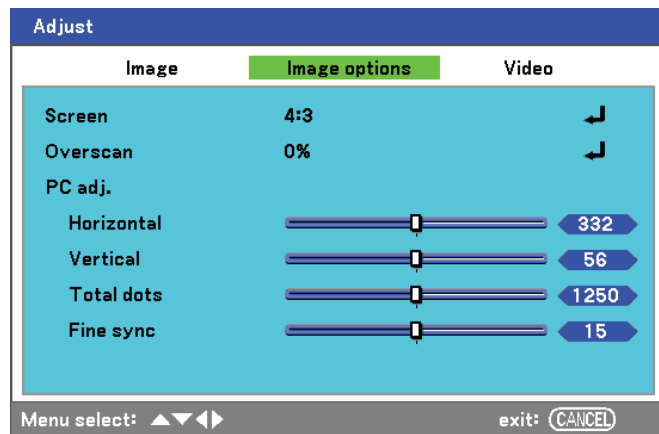

3. Adjust the **Horizontal, Vertical, Total dots, or Fine sync** sliding bars using the select ▲ ▼ ◀ ▶ buttons.
4. Press **Cancel** or **Menu** to return to the projected image.

Correcting Keystone by Using the Remote Control

**Important:**

When adjusting the keystone, place the projector in the following position.

- Horizontal: set to the lens center
- Vertical: set to the maximum top

1. Press the **Keystone** button to display the Keystone window.

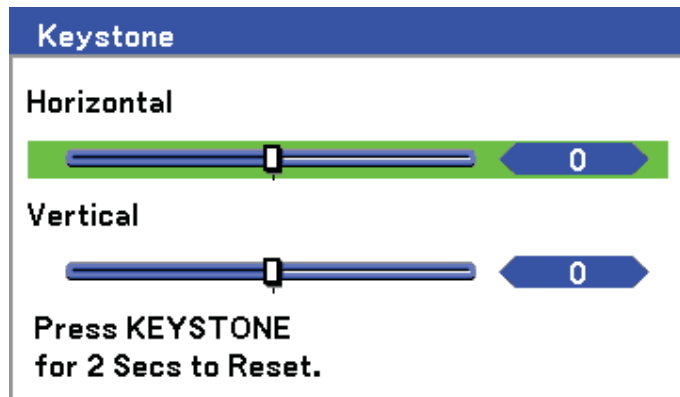

2. Adjust the **Horizontal** and **Vertical** sliding bars using the select **▲▼◀▶** buttons.

3. Adjust the slide bars until the screen trapezoid is a regular shape (see diagram).

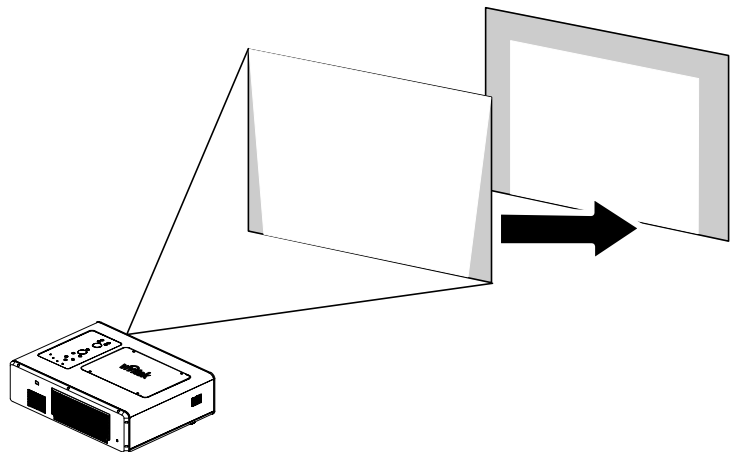

4. Press **Cancel** or **Menu** to return to the projected image.

**Note:**

Holding down the Keystone button for 2 seconds resets the default keystone values.

ADJUSTMENT	HORIZONTAL	VERTICAL
Keystone	Max. +/- 35° approx.	Max. +/- 40° approx.

The following are conditions under which the maximum angle is achieved:

- When the standard lens is used
- When the lens shift is set to H for center and V for 0.5 shift.
- When the lens shift is used and yet you do not get the above-mentioned condition (H for center and V for 0.5 shift), you cannot adjust the lens shift correctly.
- Image is projected in Wide mode
- Resolution is XGA

*Note:*  
**Higher resolution than XGA narrows the adjustable range.**

Menu items should be set as follows:

- Aspect Ratio ..... 4:3

Horizontal and Vertical are adjusted separately.

A combination of both adjustments narrows the adjustable range.

## Preventing the Unauthorized Use of the Projector

The projector has a built-in security feature to lock the OSD control panels and deny remote control operation. The security feature has no default keyword; in the first instance of enabling the security feature, the user must define a keyword.

### *Locking the Projector*

To setup the security keyword, refer to the following guide.

1. Press **Menu** on the OSD control panel on the projector or remote control to display the **Main** menu. Scroll to the **Setting** menu using **▲** or **▼** and press **◀**.

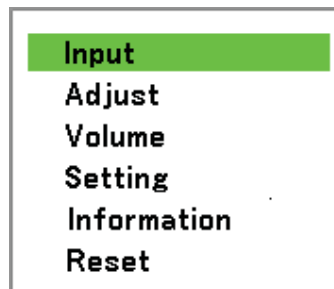

2. The **Setting** menu is displayed. Select the **Installation** tab using **◀** or **▶**.

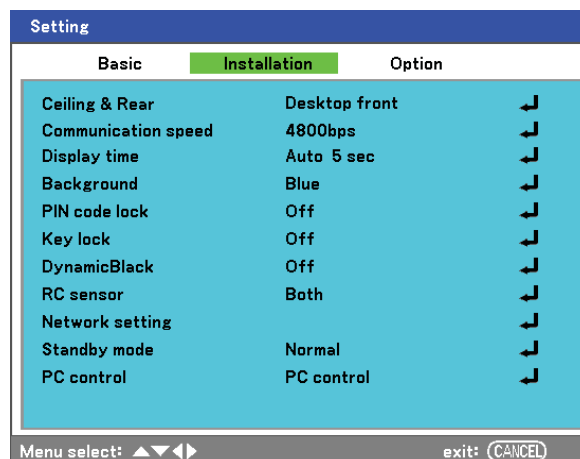

3. Select **PIN code lock** using **▲** or **▼**. Press **◀**. You are prompted to enable the PIN code lock function. Select **On** using **▲** or **▼**. Select **OK** and press **◀**.

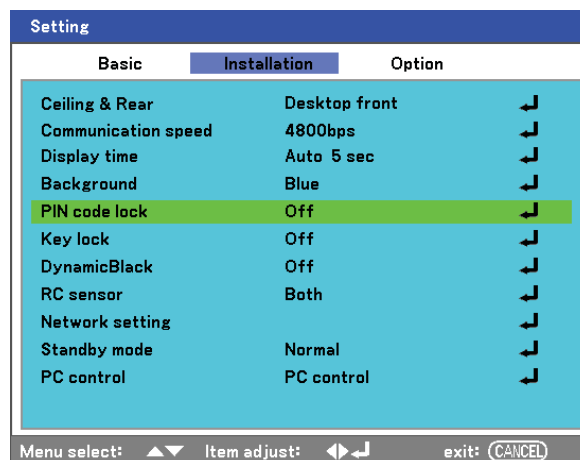

4. The PIN code window is displayed. Enter a PIN code between 4 and 10 characters using ▲▼◀▶. The PIN code characters change to “\*”. Press ⏪.



5. Once a successful PIN code is entered, a confirmation screen is displayed. Enter the same password as the previous step and write it down for later reference. Press ⏪. A security activation message is displayed. Select **Cancel** or **Menu** to return to the **Setting** menu or select **OK** to enable security.

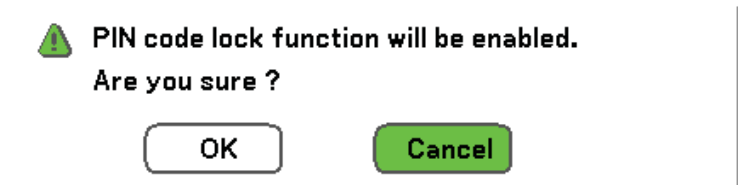

**Caution:**  
 When you have set or changed the PIN code, take a memo and keep it securely. If you forget your PIN code, the projector can no longer be started. Contact your dealer or the service center.

### Unlocking the Projector

To unlock the projector, refer to the following guide.

1. When the projector is locked, either by request during operation or at start up, the locked message is displayed.



2. To unlock the projector, press **Menu** on the control panel or remote control. The PIN code window is displayed. Enter the previously defined PIN code to activate the projector.

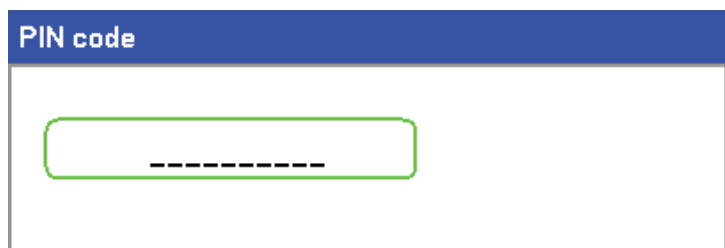

## Using the Physical Lock

### *Using the Kensington Lock*

If you are concerned about security, attach the projector to a permanent object with the Kensington slot and a security cable.

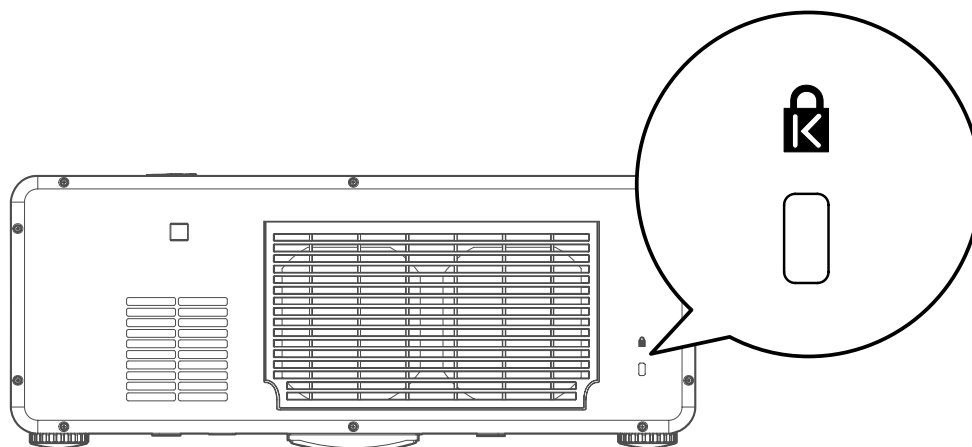

## USING ON-SCREEN DISPLAY

### Using the Menu

The projector has an On-Screen Display (OSD) that lets you make image adjustments and change various settings.

#### Navigating the OSD

You can use the remote control or the buttons on the top of the projector to navigate and make changes to the OSD. The following illustration shows the corresponding buttons on the remote control and on the projector.

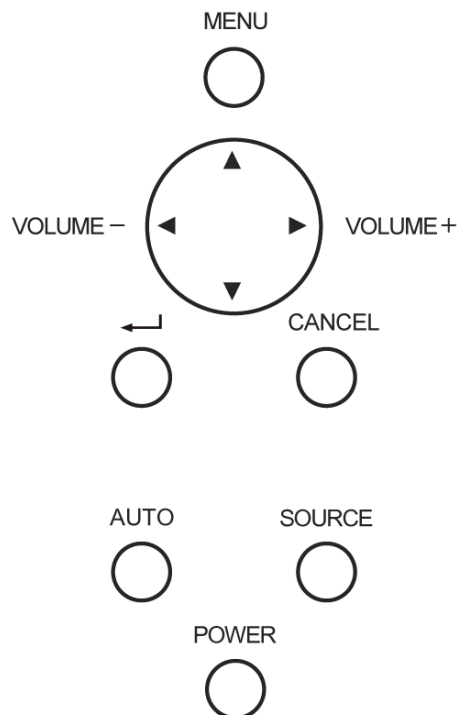

1. To open the OSD, press the **Menu** button on the OSD control panel or remote control. There are six initial menus. Press the cursor **▲** or **▼** buttons to move through the initial menus and **◀** to enter the desired menu.

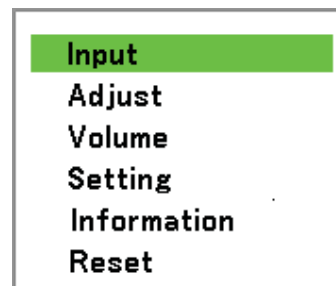

2. Press the cursor ◀ or ▶ button to move through secondary menus.

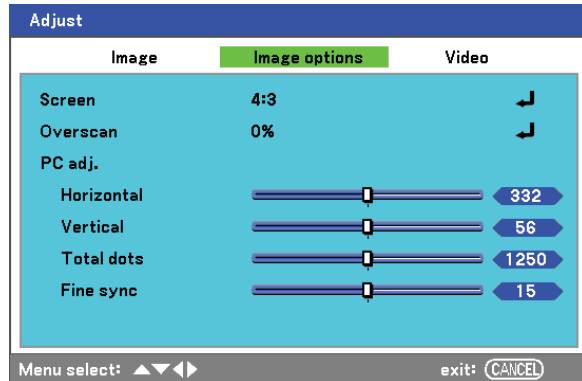

3. Press ▲ or ▼ to select menu items and ◀ or ▶ to change values for settings. Press ◀▶ to confirm the new setting.

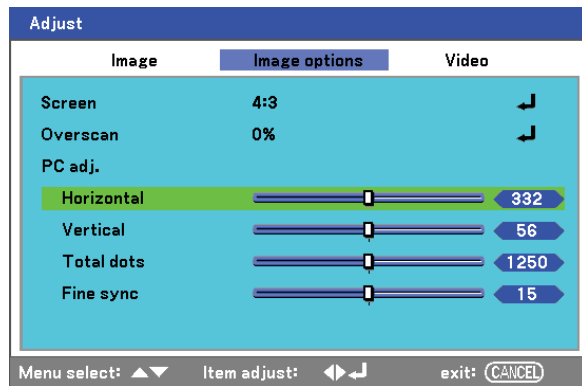

4. Press **Cancel** or **Menu** to close the OSD or leave a submenu.



## Menu Tree

Use the following illustrations to quickly find a setting or determine the range for a setting.

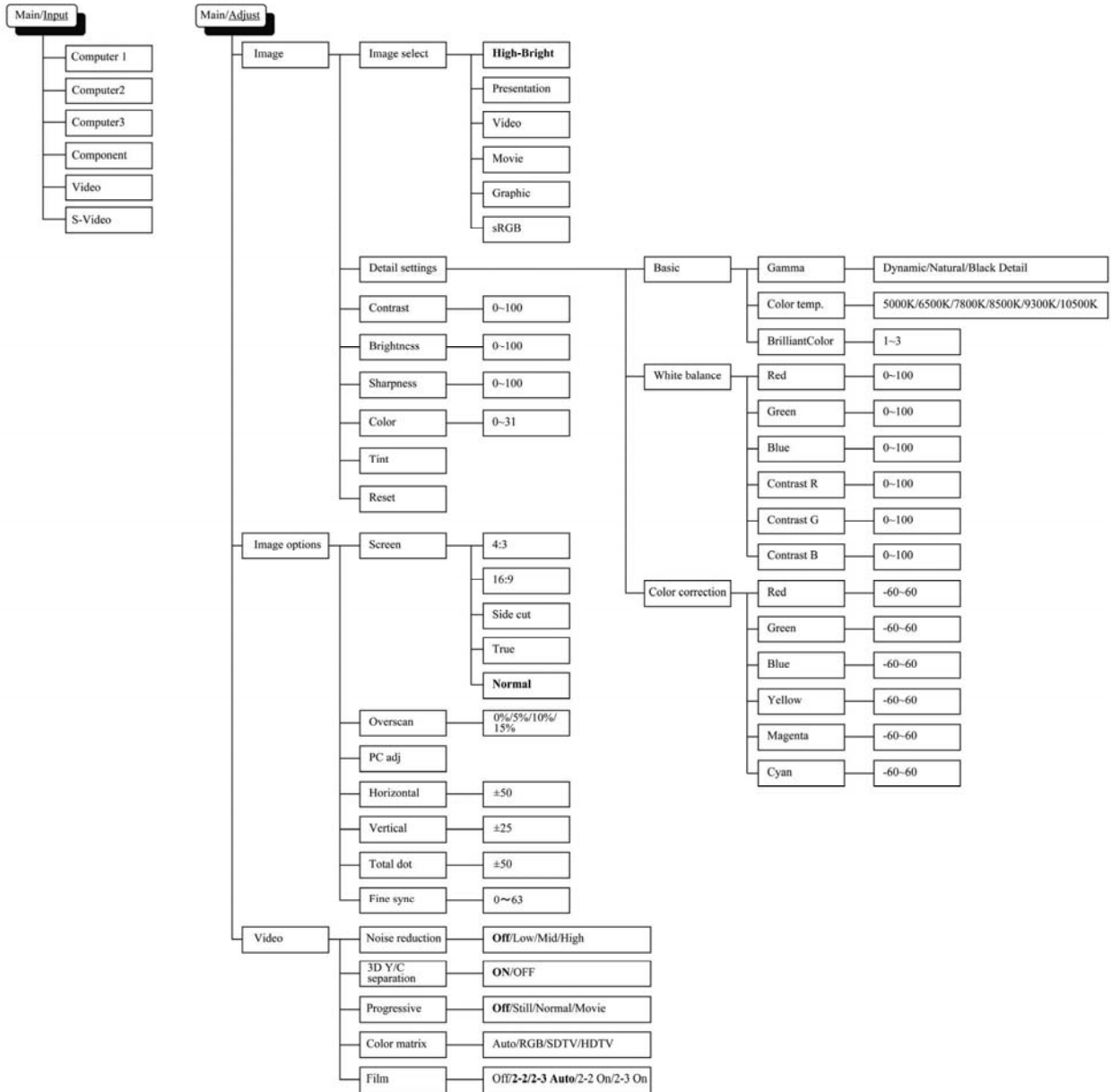

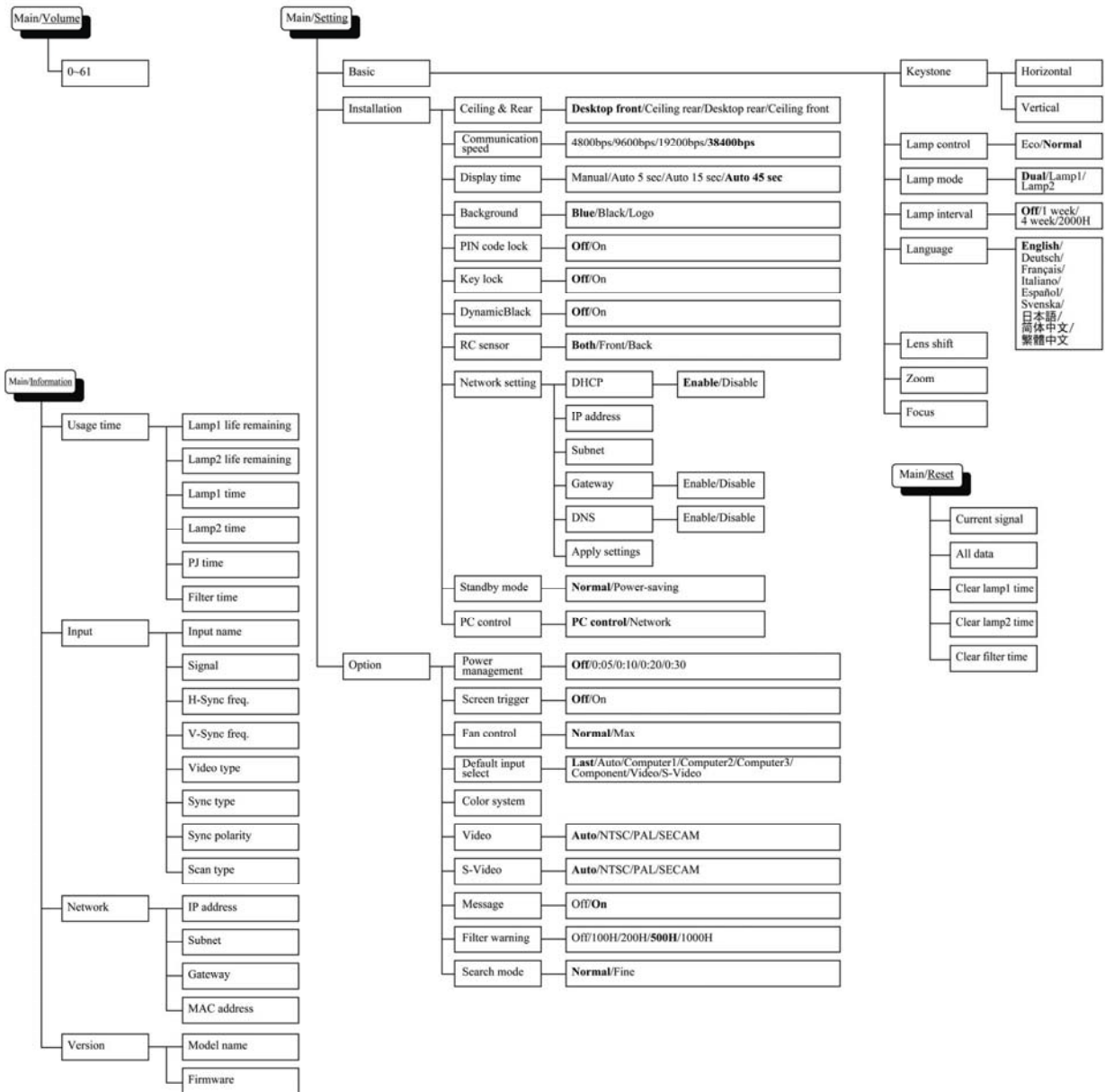

## Menu Elements

Some menus and windows contain large amounts of information in a small area. Refer to the following guide to navigate through options more easily.

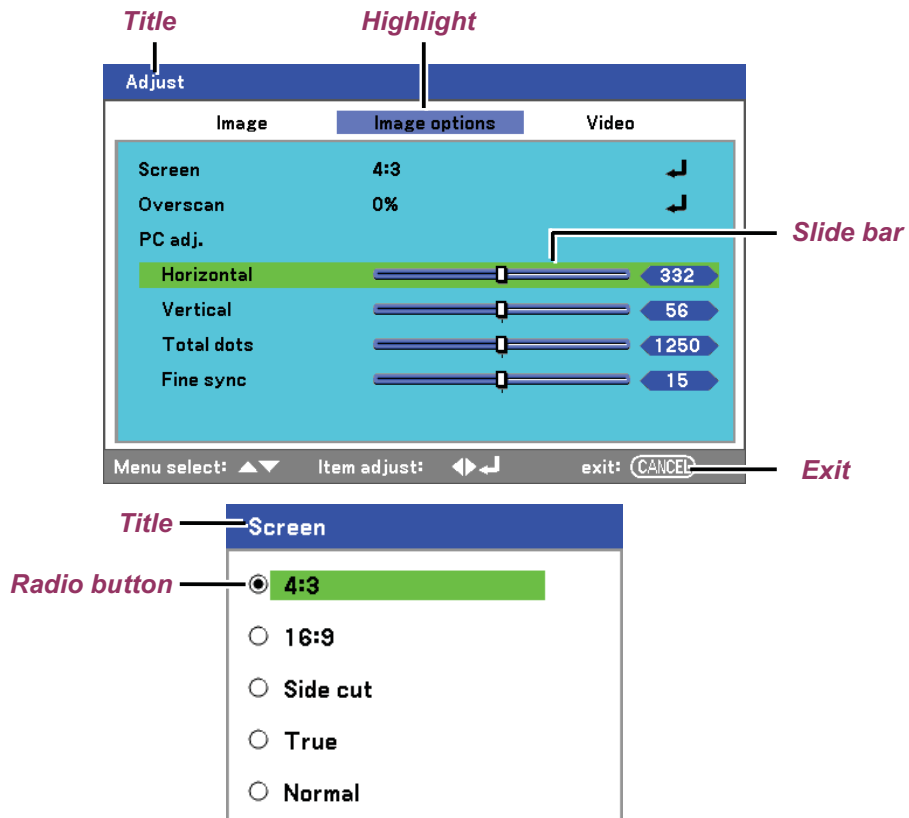

Menu windows or dialog windows typically contain the following elements:

ITEM	LABEL	DESCRIPTION
1.	Title	Indicates the menu title.
2.	Highlight	Indicates the selected menu or item.
3.	Radio button	Click this round button to select an option in a dialog box.
4.	Slide bar	Indicates a representation of adjustable values.
5.	Exit	Return to the previous menu.

## Input Menu Descriptions and Functions

The **Input** menu displays all supported image sources.

- Computer1**
- Computer2**
- Computer3**
- Component**
- Video**
- S-Video**

Select the required source from the menu using ▲ or ▼ and press ← to confirm.

LABEL	DESCRIPTION
Computer 1	Select the source connected to the Computer 1 input (see Connecting Your PC or Macintosh Computer on page 21).
Computer 2	Select the source connected to the Computer 2 input (see Connecting Your PC or Macintosh Computer on page 21).
Computer 3	Select the source connected to the Computer 3 input (see Connecting Your PC or Macintosh Computer on page 21).
Component	Select the source connected to the Component input (see Connecting Your DVD Player with Component Output on page 23).
Video	Select the source connected to the Video input (see Connecting Your VCR or Laser Disc Player on page 24).
S-Video	Select the source connected to the S-Video input (see Connecting Your VCR or Laser Disc Player on page 24).

## Adjust Menu Descriptions and Functions

The **Adjust** menu contains overall projector settings for image output such as sharpness, overscan and color matrix.

Three tabs are accessible through the **Adjust** menu, **Image**, **Image Options** and **Video**.

### Image menu

The **Image** tab is used to alter picture settings and can be accessed from the **Adjust** menu.

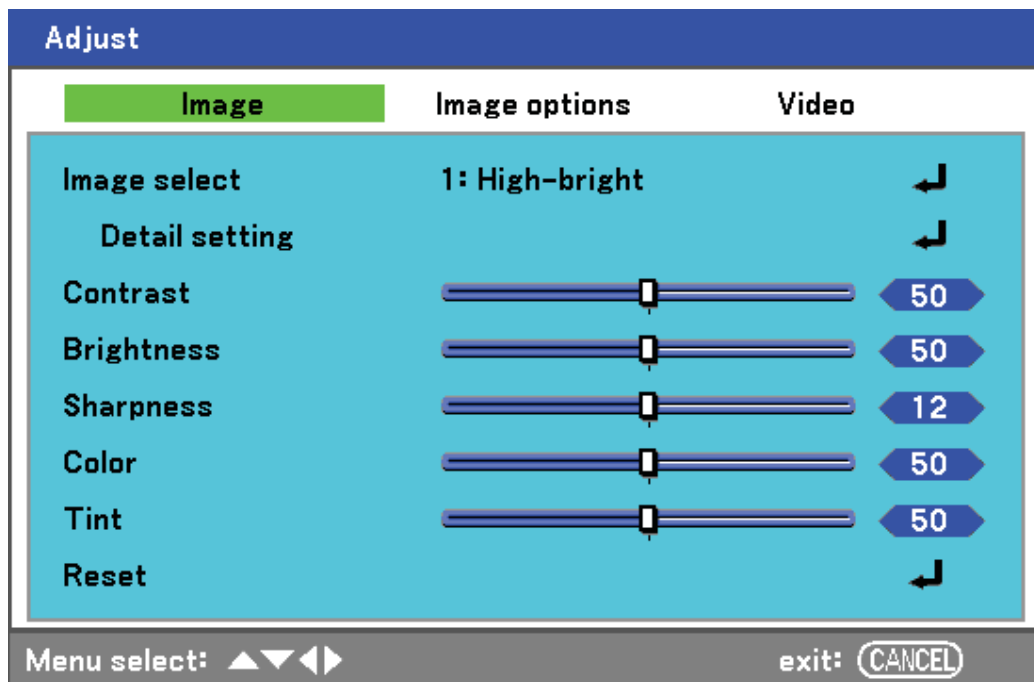

The following table lists all functions with a description and the default setting.

LABEL	DESCRIPTION
Image select	Select a set of preset values using ◀ or ▶ from the list. Notice that the below values will change depending on the preset selection.
Detail setting	See Detail Setting Menu Descriptions and Functions on page 59.
Contrast	Adjust the Contrast value using ◀or▶ to highlight the differences between light and dark areas of the picture.
Brightness	Adjust the Brightness value using ◀or▶ to lighten or darken the picture.
Sharpness	Adjust the Sharpness value using ◀or▶ to sharpen or blur the borders between colors and objects.
Color	Adjust the Color value using ◀or▶ to increase or decrease color input to the picture.
Tint	Adjust the Tint value using ◀or▶ to increase or decrease the color hue of the picture.
Reset	The settings and adjustments are set to initial factory settings.

*Image options menu*

The **Image Options** tab is used to configure image options such as screen positioning and aspect ratio. Access the **Image Options tab** in the **Adjust** menu.

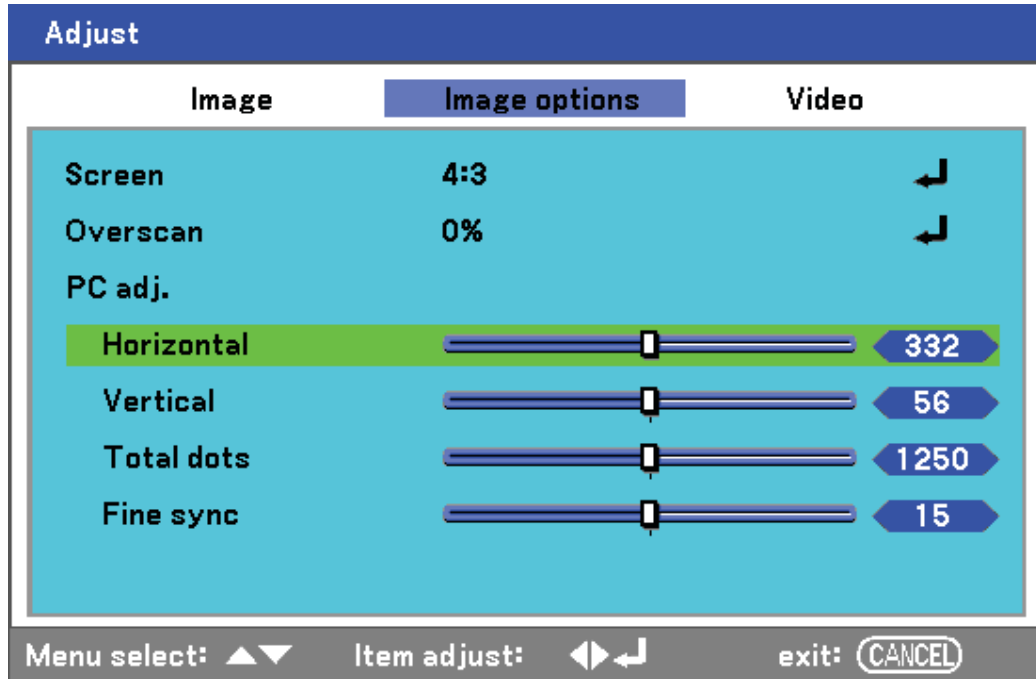

The following table lists all functions with a description and the default setting.

LABEL	DESCRIPTION
Screen	Select Screen using ◀or▶ from the list (see page 55).
Overscan	Set the Overscan value using ◀or▶ (see page 55).
PC adj.	<p>Adjust the position values using the slides.</p> <p>Horizontal: Adjusts the image location horizontally using ◀or▶.</p> <p>Vertical: Adjusts the image location vertically using ◀or▶.</p> <p>Total dots: Fine tune a computer image or remove any vertical banding that might appear.</p> <p>Fine sync: Adjust the clock phase or reduce video noise, dot or cross talk.</p> <div style="border: 1px solid black; padding: 5px; margin-top: 10px;"> <p><b>Note:</b> Only use <b>Fine sync</b> after the total dots settings have been modified.</p> </div>

*Screen*

The Screen option allows for the adjustment of the aspect ratio to alter the appearance or ratio of the projected image.

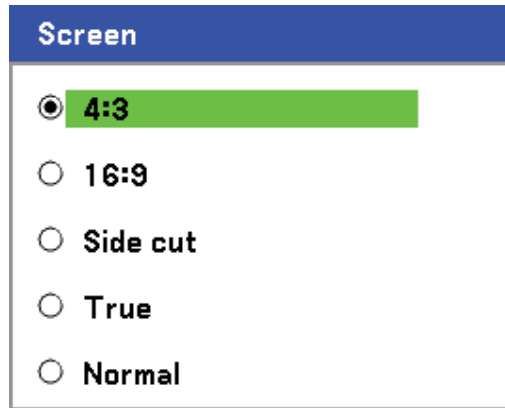

**4:3** – Standard TV screen (4:3), proportionally four units wide for every three units high, no matter the size of the screen.

**16:9** – A wide-screen aspect ratio for video.

**Side cut** – Crops the image.

**True** – Displays the current image in its true resolution.

**Normal** – Displays the current image in its aspect ratio.

*Overscan*

Video images normally exceed the size of the display screen. The edge of the picture may or may not be displayed correctly. The border area that is cropped can be adjusted by using the Overscan option.

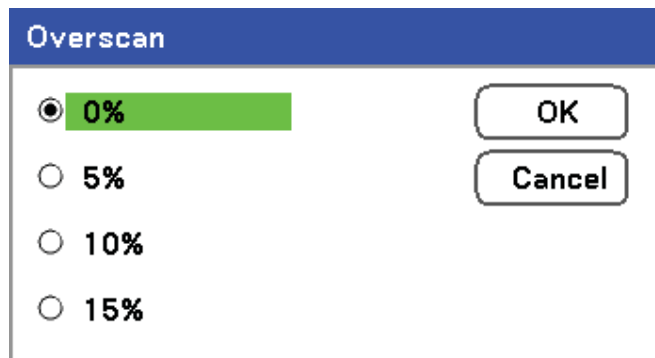

Set the overscan percentage between 0 – 15% to compensate for different screen sizes.

*Video menu*

The **Video** tab is used to configure image options such as film. Access the **Video** tab in the **Adjust** menu.

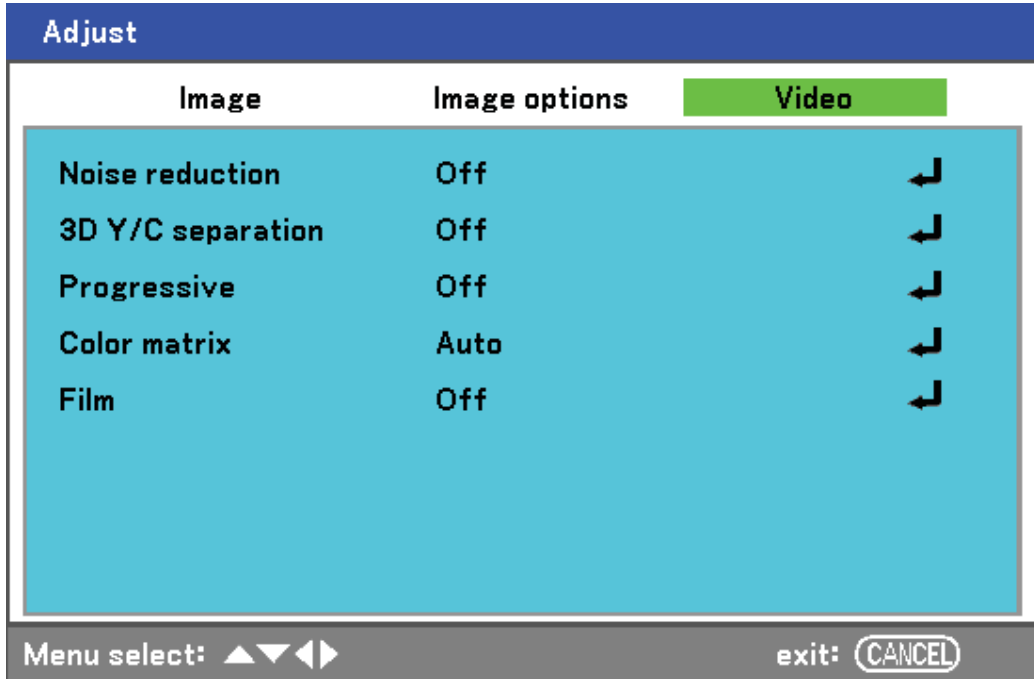

The following table lists all functions with a description and the default setting. A detailed description follows the table.

LABEL	DESCRIPTION
Noise reduction	Select Noise reduction mode (see page 57).
3D Y/C separation	Select 3D Y/C separation mode (see page 57).
Progressive	Select Progressive mode (see page 57).
Color matrix	Select Color matrix mode (see page 58).
Film	Select Film mode (see on page 58).



*Noise reduction*

Select the level of noise reduction required.

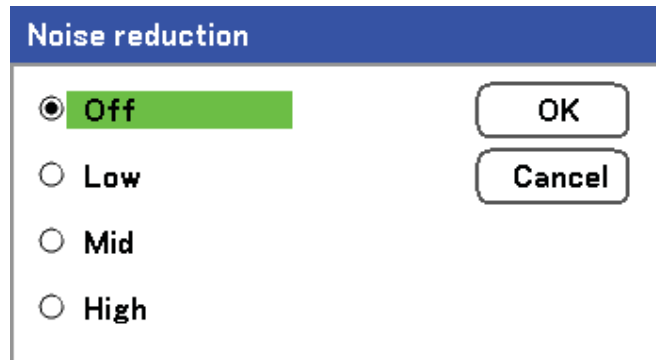

The image shows a menu titled "Noise reduction" with a blue header. It contains four radio button options: "Off", "Low", "Mid", and "High". The "Off" option is selected and highlighted with a green bar. To the right of the options are two buttons: "OK" and "Cancel".

Range: Off, Low, Mid, High.

*3D Y/C separation*

3D Y/C Separation separates composite signal to Y (brightness) signal and C (color) signal, and can help to produce clearer and sharper images without overlapping colors (rainbow effect).

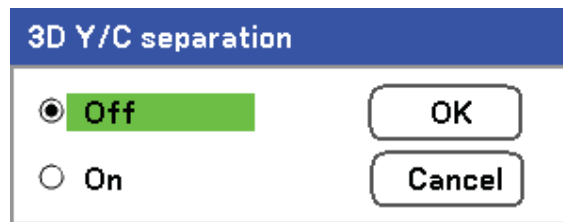

The image shows a menu titled "3D Y/C separation" with a blue header. It contains two radio button options: "Off" and "On". The "Off" option is selected and highlighted with a green bar. To the right of the options are two buttons: "OK" and "Cancel".

Set 3D Y/C Separation On or Off.

*Progressive*

Progressive converts an interlaced image to a progressive scan image.

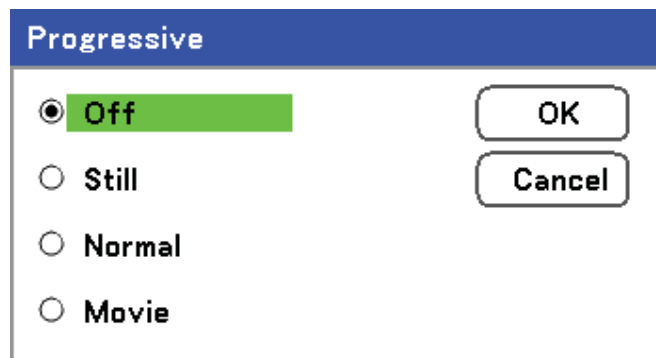

The image shows a menu titled "Progressive" with a blue header. It contains four radio button options: "Off", "Still", "Normal", and "Movie". The "Off" option is selected and highlighted with a green bar. To the right of the options are two buttons: "OK" and "Cancel".

Select the form of Deinterlacing required from:

**Still** – Select for stills such as slide projections or screen shots.

**Normal** – Select Normal for non-specialized projection.

**Movie** – Select for movie projection.

*Color matrix*

Color Matrices define the amount of the three-color components R (red), G (green), and B (blue) in a single point in color space.

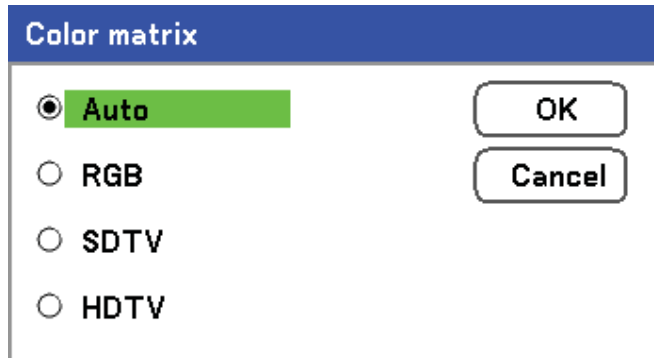

Select from the following:

**Auto** – Auto selects the color matrix.

**RGB** – Sets the color matrix to RGB, use for PC monitor or camera imaging.

**SDTV** – Sets the color matrix to SDTV, use for Standard Definition imaging.

**HDTV** – Sets the color matrix to HDTV, use for High Definition imaging.

*Film*

Film aids in converting motion picture film images into video. The process adds additional frames to the picture in order to increase the frame rate.

**Note:**

*This feature is only available when Progressive is turned on and SDTV signal is selected.*

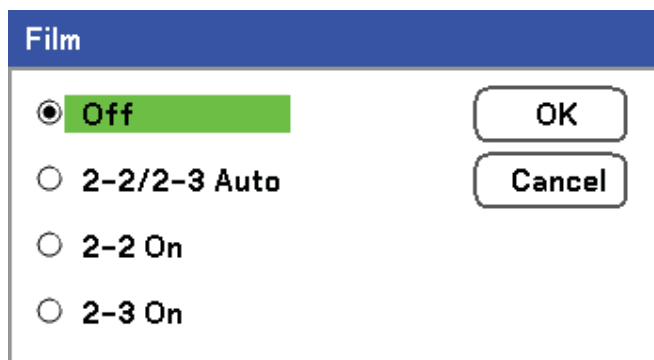

Select from the following:

**Off** – Film mode is turned off.

**2-2/2-3 Auto** – Detects pull-down correction method.

**2-2 On** – Uses 2-2 pull-down correction method.

**2-3 On** - Uses 2-3 pull-down correction method.

## Detail Setting Menu Descriptions and Functions

The **Detail setting** menu contains basic and advanced color adjustment options such as gamma correction, color contrast and color correction.

### Basic

The **Basic** tab contains general setting such as gamma correction and color temperature. Access to the **Basic** tab is through the **Detail setting** menu.

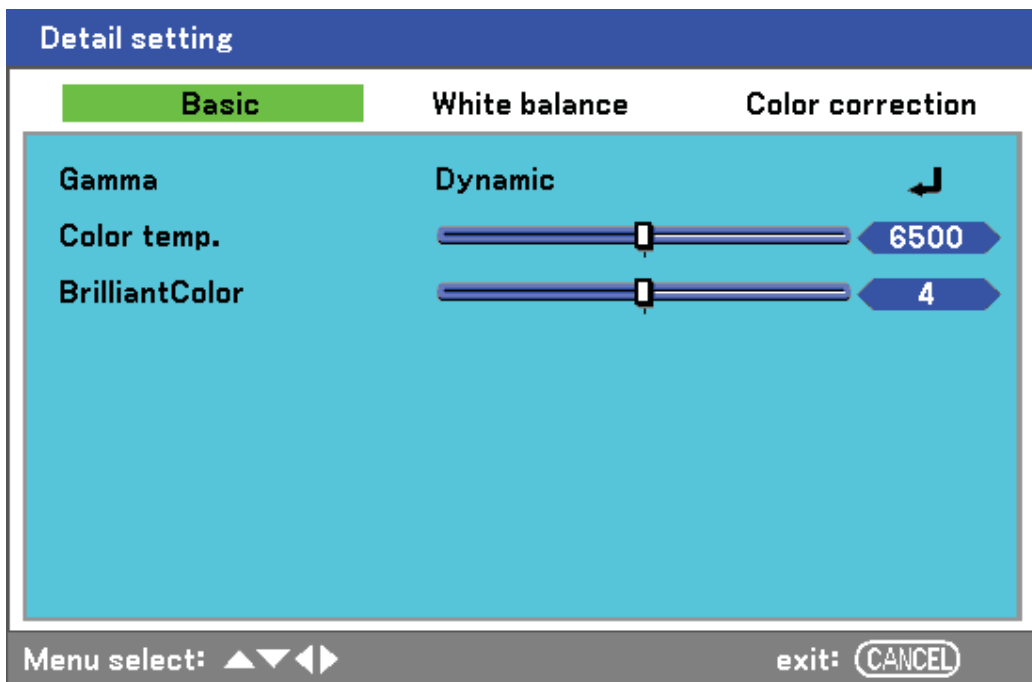

The following table lists all functions with a brief description.

LABEL	DESCRIPTION
Gamma	Select Gamma Correction mode (see page 60).
Color temp.	Move the slider bar left or right to set the color temperature value in Kelvin (K). Compensate for the amount of light available. Daylight is approximately 5500K.
BrilliantColor	Move the slider bar left or right to set the BrilliantColor™ value. BrilliantColor extends the exposure range and sharpens detail for grain free images.

**Gamma**

Gamma enables adjustment to the light intensity (brightness) of an image in order to match the source more closely.

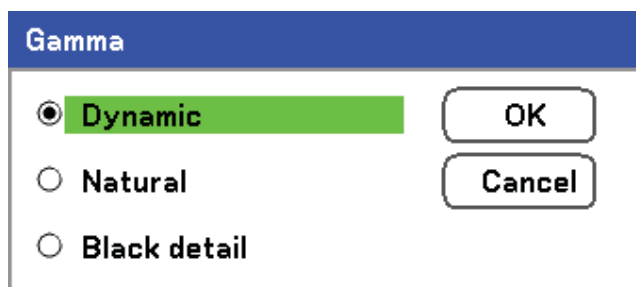

Select from the following:

**Dynamic** – Allows the projector to alter the gamma correction automatically.

**Natural** – Attempts to emulate the original source as closely as possible.

**Black detail** – Black detail highlights boundaries between light and dark areas of the image more clearly.

White balance

**White Balance** allows the projector to compensate for different colors of light being emitted by different light sources.

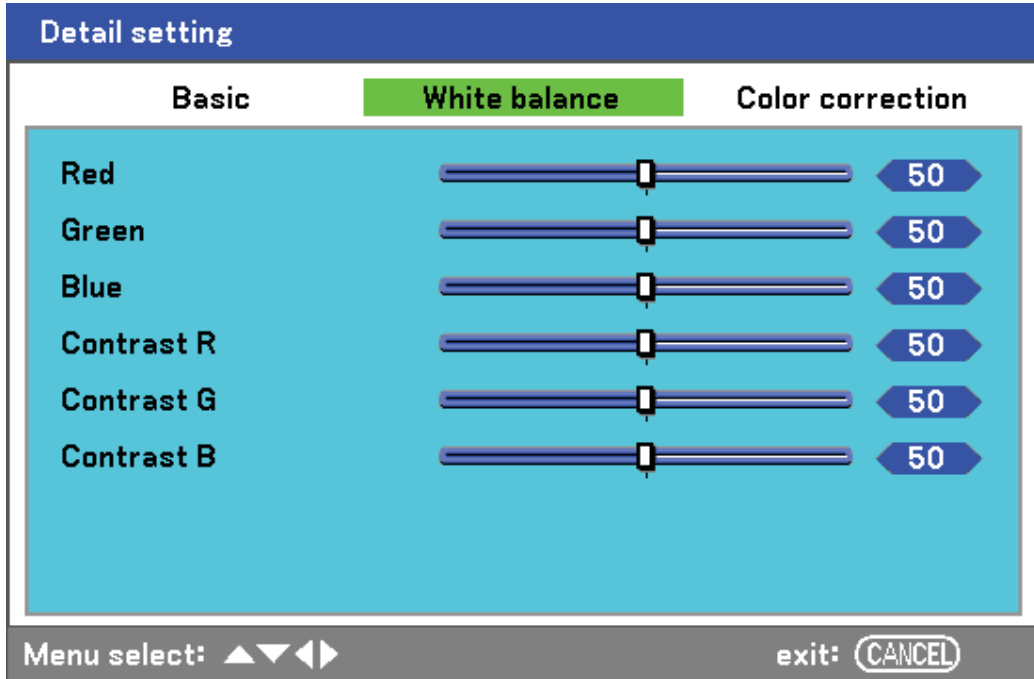

The following table lists all functions with a brief description.

LABEL	DESCRIPTION
Red	Set the value to compensate for red light sources.
Green	Set the value to compensate for green light sources.
Blue	Set the value to compensate for blue light sources.
Contrast R	Set the Contrast R value to compensate for red light sources.
Contrast G	Set the Contrast G value to compensate for green light sources.
Contrast B	Set the Contrast B value to compensate for blue light sources.

Color correction

The **Color correction** tab enables the adjustment of color values in an image to remove unwanted effects, improve color, characteristics or add more of a particular color.

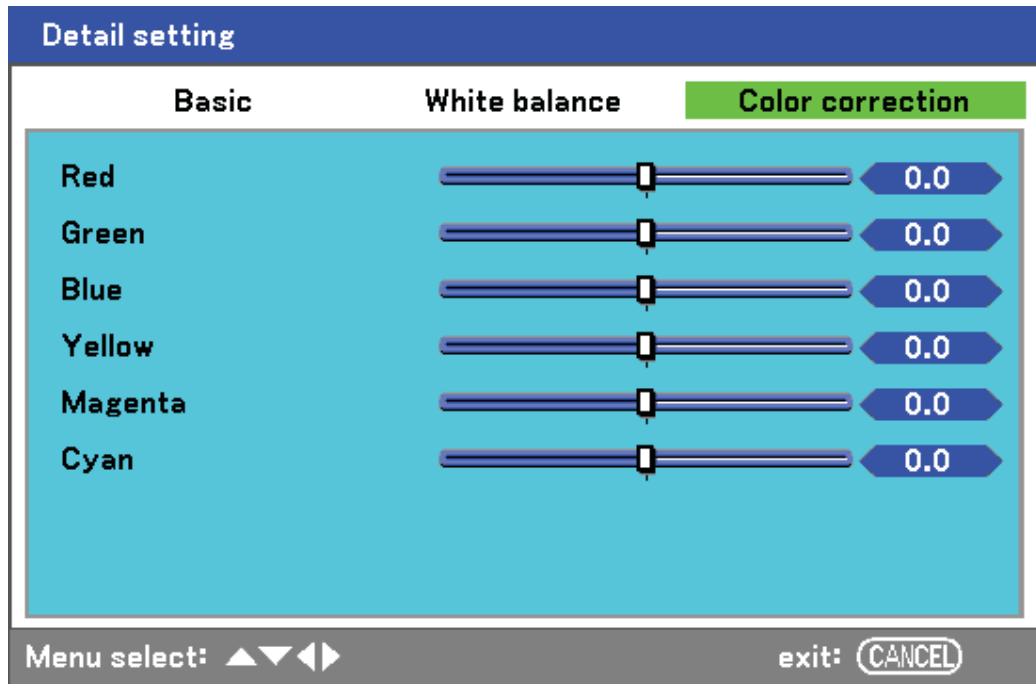

The following table lists all functions with a brief description.

LABEL	DESCRIPTION
Red	Increase or decrease the amount of red in the projected output using ◀ and ▶.
Green	Increase or decrease the amount of green in the projected output using ◀ and ▶.
Blue	Increase or decrease the amount of blue in the projected output using ◀ and ▶.
Yellow	Increase or decrease the amount of yellow in the projected output using ◀ and ▶.
Magenta	Increase or decrease the amount of magenta in the projected output using ◀ and ▶.
Cyan	Increase or decrease the amount of cyan in the projected output using ◀ and ▶.

## Setting Menu Descriptions and Functions

The **Setting** menu contains the most often used settings during installation and options to customize the general output of the projector. Three tabs are accessible through the **Setting** menu, **Basic**, **Installation** and **Option**.

### *Basic*

The **Basic** tab contains general setup options such as lamp mode and OSD language settings and can be accessed with the projector control panel or with the remote control unit.



The following table lists all functions with a brief description.

LABEL	DESCRIPTION
Keystone	Adjust the Keystone trapezoid (see Keystone page 64).
Lamp control	Select Lamp control. Range: Normal or Eco.
Lamp mode	Select Lamp configuration. Range: Dual, Lamp1 or Lamp2.
Lamp interval	Select Lamp interval. Range: Off, 1 week, 4 weeks or 2000 hours.
Language	Select the OSD language (see Language on page 65).
Lens Shift	Displays the Lens Shift window (see Adjusting Picture Position Manually on page 28).
Zoom	Displays the Zoom window (see Adjusting the Focus/Zoom Manually on page 38).
Focus	Displays the Focus window (see Adjusting the Focus/Zoom Manually on page 38).

*Keystone*

The keystone trapezoid can be adjusted by selecting this option.

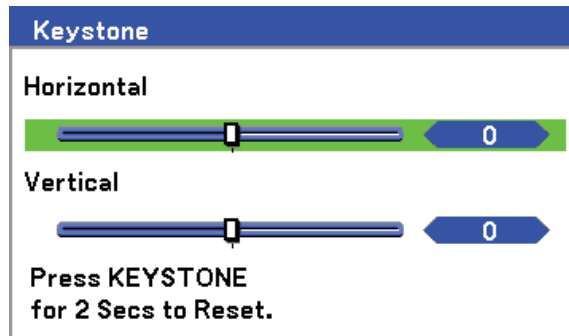

Select Horizontal or Vertical using ▲ or ▼ then, use ◀ or ▶ to adjust the projected image appearance as required.

**Note:**

When adjusting the keystone, place the projector in the following position.

- Horizontal: set to the lens center
- Vertical: set to the maximum top

*Lamp control*

Select Normal or Eco from the lamp mode window. The lamp life can be extended by using the Eco mode and the fan noise can be reduced.

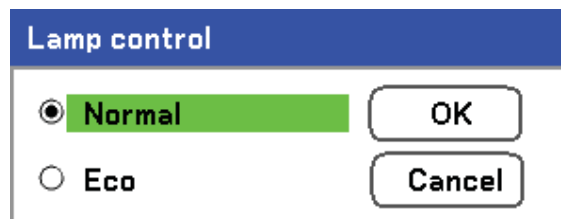

*Lamp mode*

Select the lamps to be used for projection.

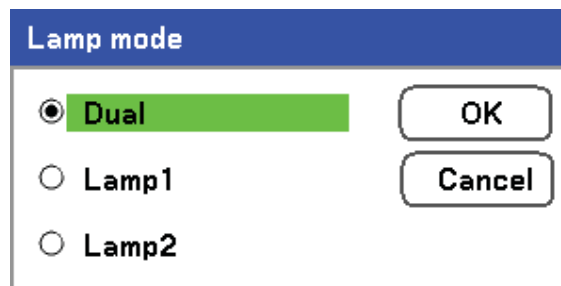

Select from the following:

**Dual** – Uses both lamps simultaneously.

**Lamp1** – Uses Lamp1 only.

**Lamp2** – Uses Lamp2 only.



*Lamp interval*

The period of time for regulating lamp usage when not in dual lamp mode.

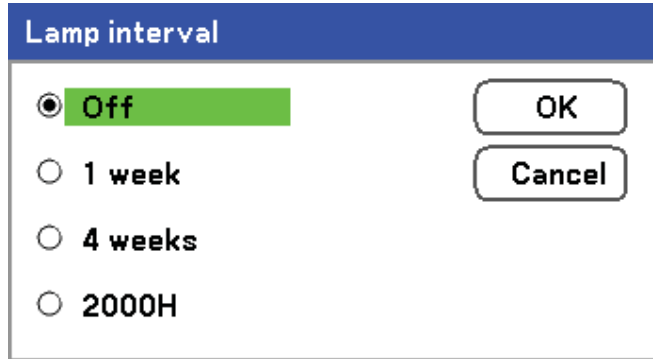

Select from the following:

**Off, 1 week, 4 weeks and 2000H**

*Language*

Select the OSD language to be used.

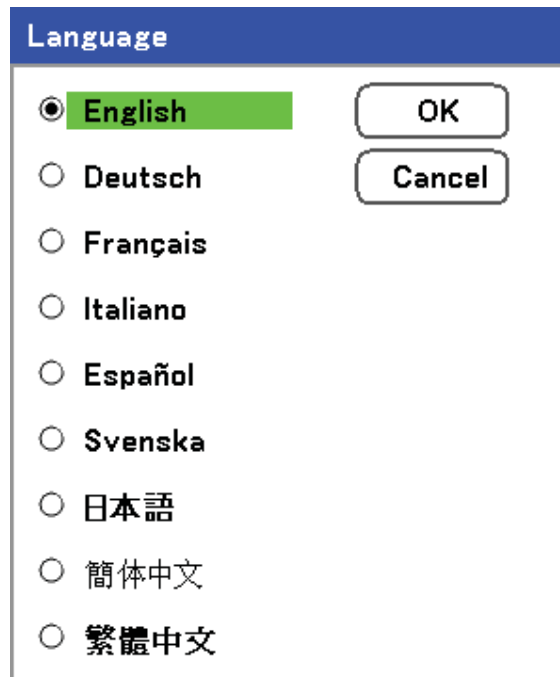

Select from the following:

- **English**
- **German**
- **French**
- **Italian**
- **Spanish**
- **Swedish**
- **Japanese**
- **Simplified Chinese**
- **Traditional Chinese**

Installation

The **Installation** tab contains menu options for various setup conditions such as orientation and remote sensor mode and is accessed through the **Setting** menu.

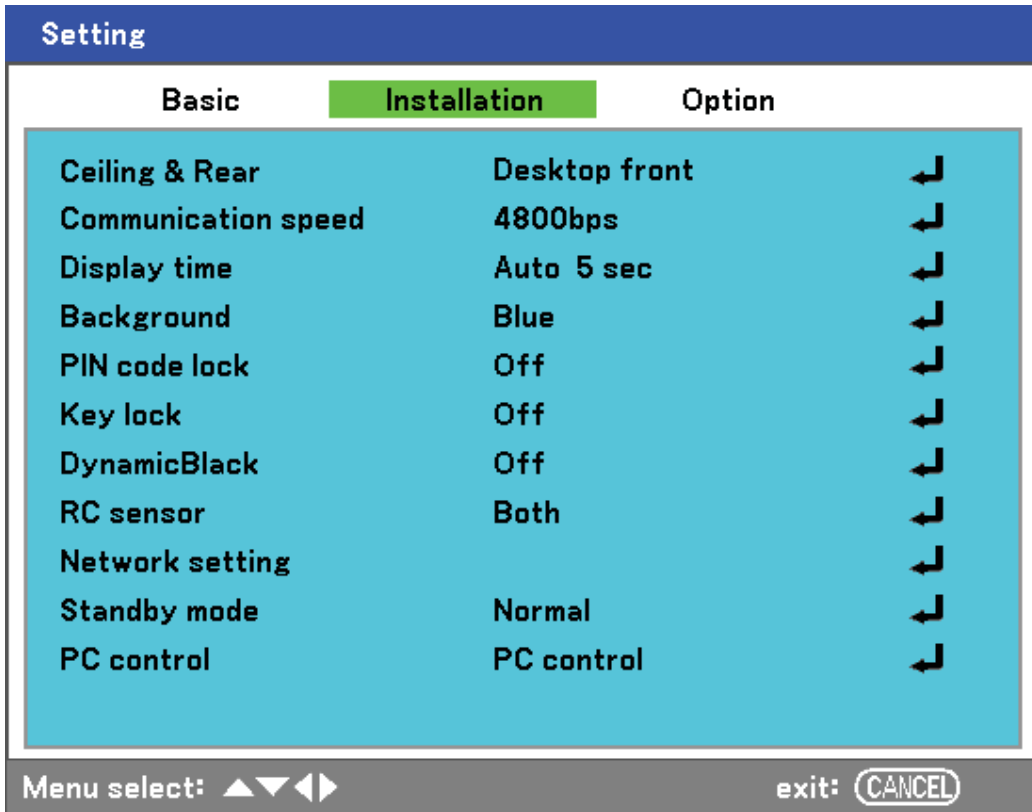

The following table lists all functions with a brief description.

LABEL	DESCRIPTION
Ceiling & Rear	Select from four projection methods depending on projection site (see Ceiling & Rear page 67).
Communication speed	Select Communication speed. Range: 4800bps, 9600bps, 19200bps, 38400bps
Display time	Select Display time. Range: Manual, Auto 5s, Auto 15s, Auto 45s
Background	Select Background appearance when there is no signal. Range: blue, black or logo
PIN code lock	Set PIN code lock On/Off (see PIN Code Lock on page 68).
Key lock	Set Control panel lock On/Off.  <b>Note:</b> <ul style="list-style-type: none"> <li>• This Control Panel Lock does not affect the remote control functions.</li> <li>• When the control panel is locked, pressing and holding the Cancel button on the projector cabinet for about 10 seconds. The setting will change to Off.</li> </ul>

LABEL	DESCRIPTION
DynamicBlack	DynamicBlack™ improves the black level of the projector. Black level is the darkest part of a picture and varies between viewing devices and environments. Set DynamicBlack on/off.
RC sensor	Set RC sensor fields. Range: Both, Front, Back
Network setting	Opens Network preferences tab (see Network setting on page 69).
Standby mode	Select Standby mode. Range: Normal and Power-saving
PC control	Enables the path selection for PC control. Range: PC control or Network.

*Ceiling & Rear*

Ceiling & Rear enables you to set how the projected image is displayed.

Select from the following:

**Desktop Front** – Standard forward facing projection (Default setting).

**Desktop Rear** – Standard rear projection. Enables the projector to produce the image from behind the screen by reversing the image.

**Ceiling Front** – Forward facing ceiling mounted projection. Enables ceiling mounted projection by inverting the image.

**Ceiling Rear** – Rear ceiling mounted projection. Enables ceiling mounted projection from behind the screen by inverting and reversing the image.

*Communication speed*

Select communication speed to set the baud rate of the connection.

**Note:**  
Longer cable connections may require lower settings.

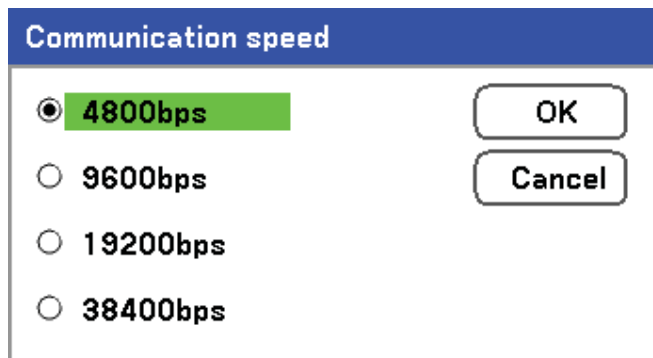

Select from the following options:

- 4800bps
- 9600bps
- 19200bps
- 38400bps

**Note:**  
In the Network mode, Communication Speed function is not available.

*Display time*

Sets the amount of time a menu is displayed.

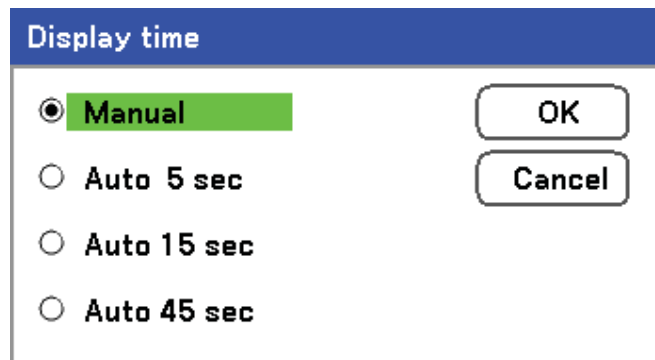

Select from the following:

**Manual** – Menus stay on screen until the **Menu** button is pressed again.

**Auto 5 secs**—Menu is displayed for 5 seconds.

**Auto 15 secs** – Menu is displayed for 15 seconds.

**Auto 45 secs** – Menu is displayed for 45 seconds.

*Background*

Background enables you to display a blue/black screen when there is no signal. The default background is blue.

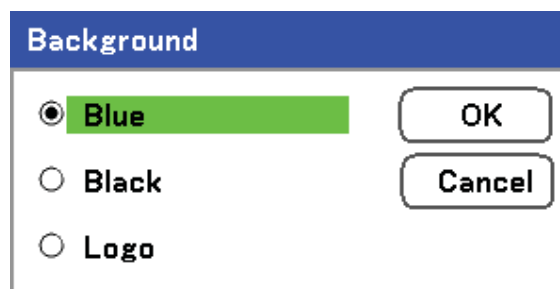

Select from the following:

- Blue
- Black
- Logo

*PIN Code Lock*

See Preventing the Unauthorized Use of the Projector on page 44.

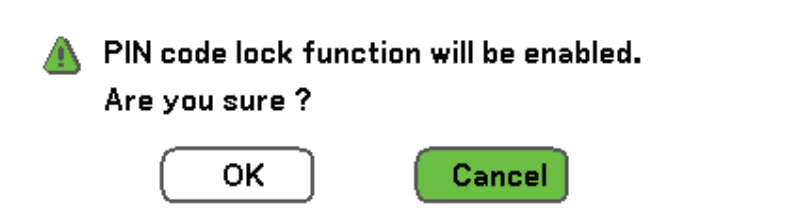

*Key lock*

Turn On/Off the Key Lock function for cabinet buttons.

**Note:**

- This Control Panel Lock does not affect the remote control functions.
- When the control panel is locked, press and holding the Cancel button on the projector cabinet for about 10 seconds. The setting will change to Off.



*DynamicBlack*

DynamicBlack™ enables you to improve the black level of the projector.

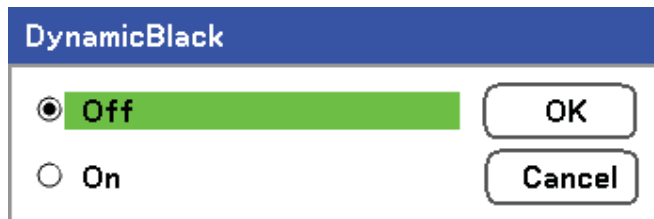

*RC sensor*

Set the operating range for the wireless remote control.

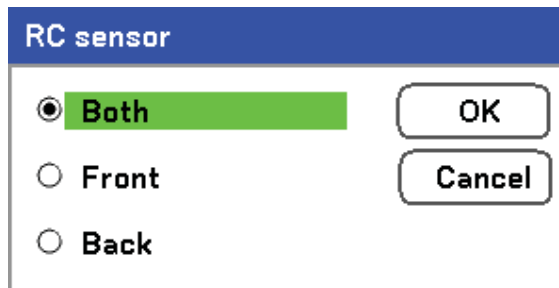

Select from the following:

- Both
- Front
- Back

*Network Setting*

See Network setting on page 71.

### Standby mode

There are two standby modes available: Normal and Power-saving. Power-saving mode allows you to put the projector in the standby condition to consume less power than Normal.

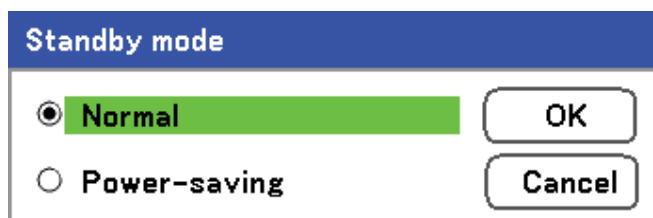

**Note:**

Be sure to connect the projector and computer while the projector is in standby mode and before turning on the computer.

Select from the following:

- Normal
- Power-saving

**Note:**

The HTTP server functions are not available during Power-saving mode.

The MONITOR OUT function is not available during Power-saving mode.

Control through the PC Control connector and Network mode is not available during Power-saving mode. For PC control and Network mode of the projector it is recommended to leave the projector in the Normal mode.

Normal mode:	POWER indicator: Orange light WARNING indicator: Green light
Power-saving mode:	POWER indicator: Orange light WARNING indicator: Off

### PC control

This function enables you to select the path for PC control (see PC Control Codes and Cable Connections on page 98).

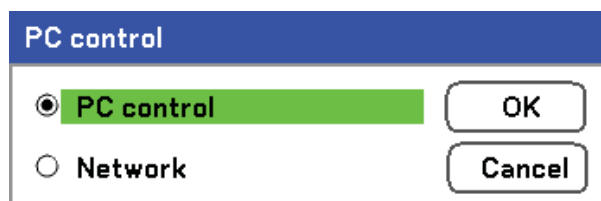

**Note:**

In the Network mode, Communication Speed function is not available.

Select from the following:

- PC control
- Network

Network setting

The **Network setting** menu is accessed by using the **Setup/Installation** menu and contains the general LAN settings.

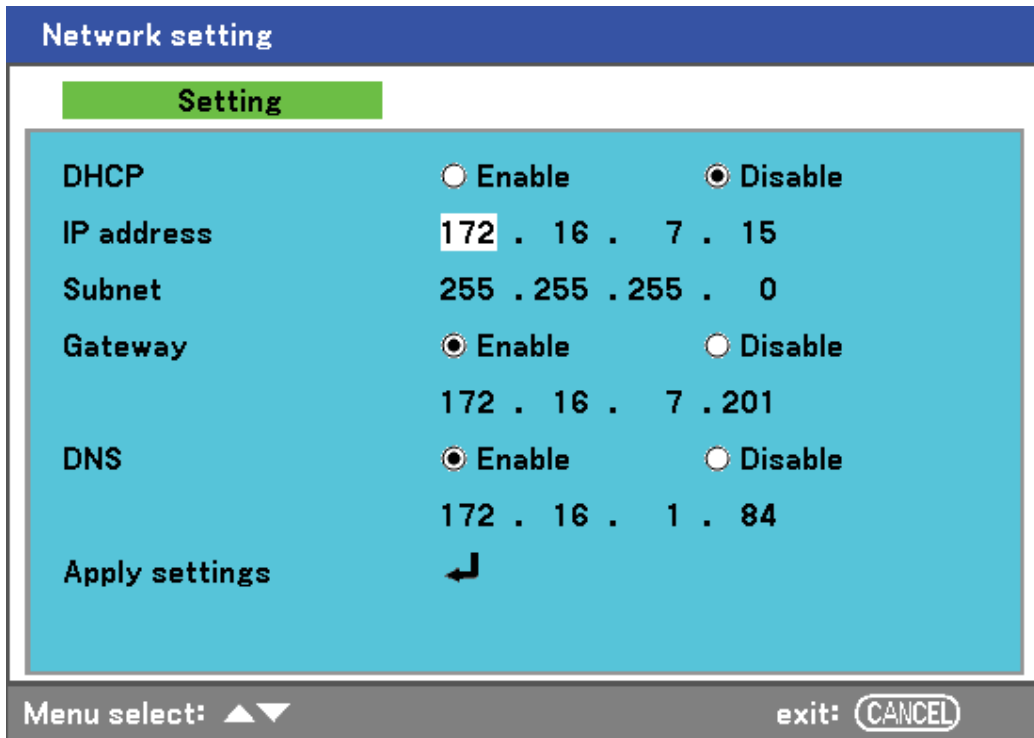

The following table lists all functions with a description and the default setting.

LABEL	DESCRIPTION
DHCP	Select either a static IP (Disable) or DHCP IP (Enable) setting by selecting the appropriate radio button.
IP address	Displays the IP address.
Subnet	Displays the subnet mask.
Gateway	Enable or disable the network gateway setting. Click on the radio button to change the setting.
DNS	Enable or disable the DNS server settings. Click on the radio button to change the setting.
Apply settings	Apply and save settings.

Option

The **Option** tab contains miscellaneous setup menu settings such as Power management and Default input select and can be accessed by using the **Setting** menu.

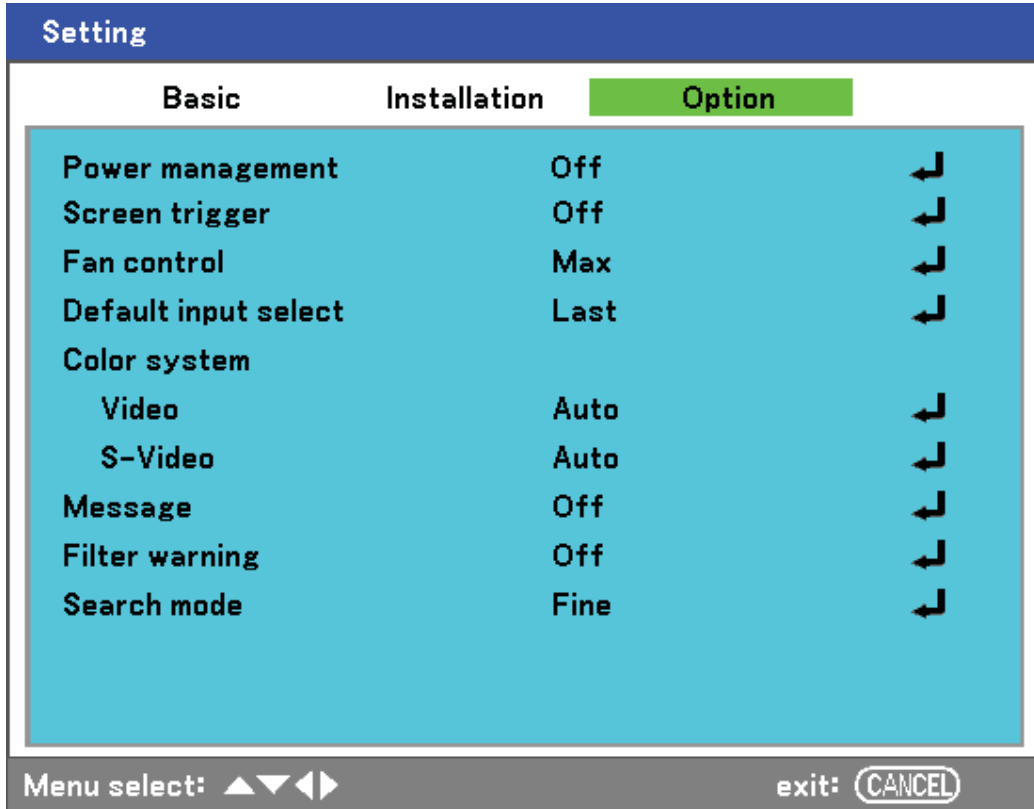

The following table lists all functions with a description and the default setting.

LABEL	DESCRIPTION
Power management	Select the amount of time the projector remains idle before powering down. Range: Off, 0:05, 0:10, 0:20, 0:30
Screen trigger	Set this item to On to enable the projector to automatically lower the projection screen when powering on. Range: On or Off
Fan control	Select Fan control. Range: Normal or Max (see Fan control page 73)
Default input select	Select the default input for projection. Range: Last, Auto, Computer1, Computer2, Computer3, Component, Video, S-Video
Color System	Video—select the Video Color System from Auto, NTSC, PAL, and SECAM. S-Video— select the S-Video Color System from Auto, NTSC, PAL, and SECAM.
Message	This option turns on or off messages. Range: Off or On
Filter warning	Set this item to on to have the projector display a message when the air filter needs servicing. Range: Off, 100[H], 200[H], 500[H], 1000[H]
Search mode	This feature sets the Auto Adjust mode. Range: Normal, Fine



*Power management*

Power management enables the projector to automatically turn off if there is no signal received by any input.

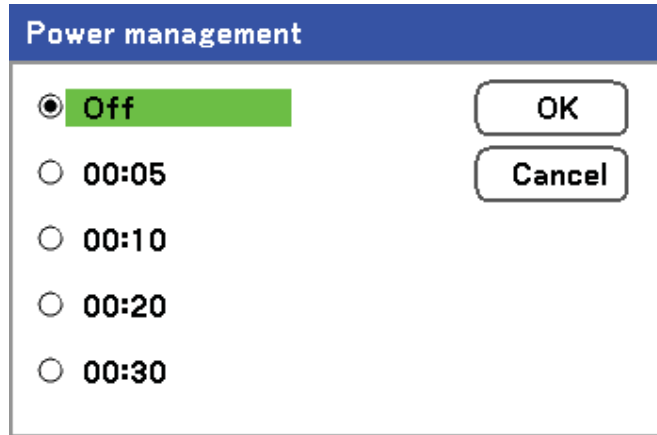

Select from the following:

- Off
- 5 minutes
- 10 minutes
- 20 minutes
- 30 minutes

*Screen trigger*

Set Screen trigger to On to enable the projector to automatically lower the projection screen when powering on. When powering off, Screen trigger stops sending a low voltage trigger to the screen controller and the screen goes up.

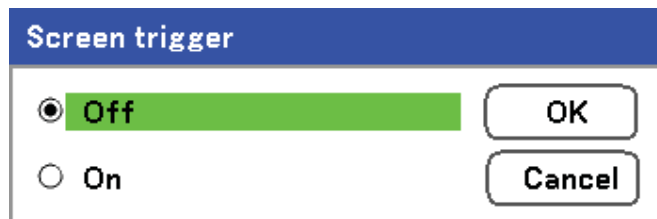

*Fan control*

Fan control is used to set the speed of the internal cooling fan. Set Fan Speed to Max in altitudes over 1500 meters (5000 feet).



The Fan control option default is **Normal**, which enables the projector to automatically detect fan requirements. For higher temperature locations or prolonged use, the **Max** option is available to provide greater cooling capacity.

*Default input select*

The Default input is the image source that the projector will search for automatically on startup.

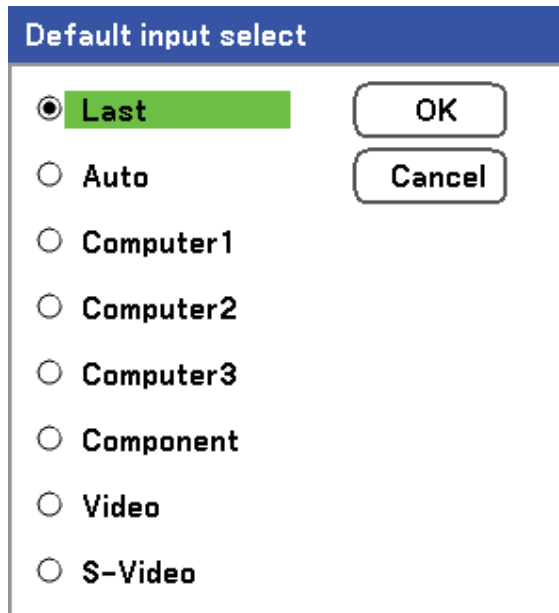

**Last** – Uses the most recently used image source.

**Auto** – Auto detects the default image source.

**Computer1/2/3** – Uses Computer1, 2 or 3 as the default image source.

**Component** – Uses last component as the default image source.

**Video** – Uses last video input as default image source.

**S-Video** – Uses last S-video input as default image source.

*Message*

This option turns on or off messages. Even though selecting [Off], the following message will appear. "Projector is locked" when the projector security is unlocked, the message will disappear.



*Filter warning*

Set Filter warning to have the projector display a message when the air filter needs servicing.

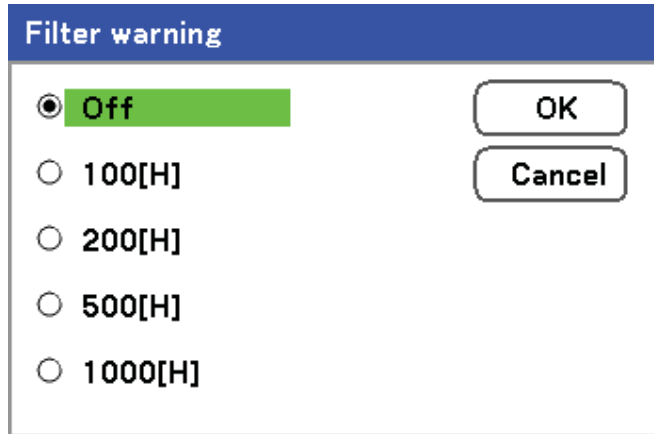

The message below shows when this function is activated.

**Please clean filter.**

*Search mode*

This feature sets the Auto Adjust mode so that the RGB image can be automatically or manually adjusted for noise and stability. You can automatically make adjustments in two ways: [Normal] and [Fine].



Normal: The RGB image will be automatically adjusted. Normally select this option (Default).

Fine: Select this option if fine adjustment is needed. It takes more time to switch to the source than the Normal settings.

## Information Menu Descriptions and Functions

The **Information** menu provides only screens for the quick access of menus. The Information menu contains four distinct tabs.

### Usage time

The **Usage time** tab displays information about lamp usage and remaining lamp life.

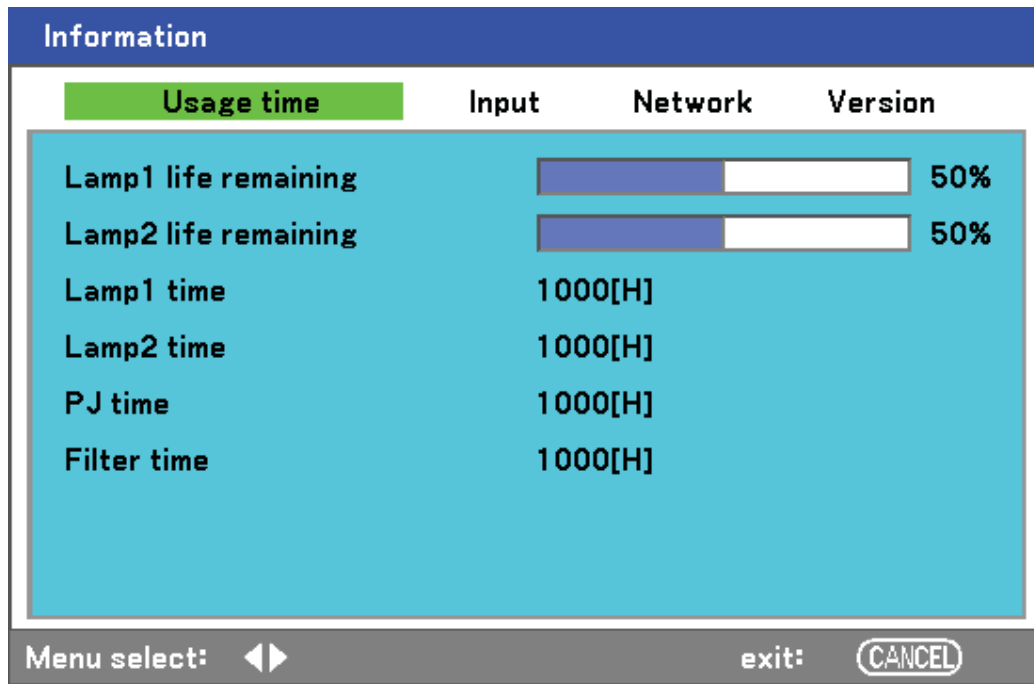

The following table lists all items with a description.

LABEL	DESCRIPTION
Lamp1 life remaining	Displays the Lamp1 life remaining as a percentage.
Lamp2 life remaining	Displays the Lamp2 life remaining as a percentage.
Lamp1 time	Displays the Lamp1 total usage in hours.
Lamp2 time	Displays the Lamp2 total usage in hours.
PJ time	Displays the projector total usage in hours.
Filter time	Displays how many hours the filter has been used.

Input

The **Input** tab displays various source and frequency values at a glance.

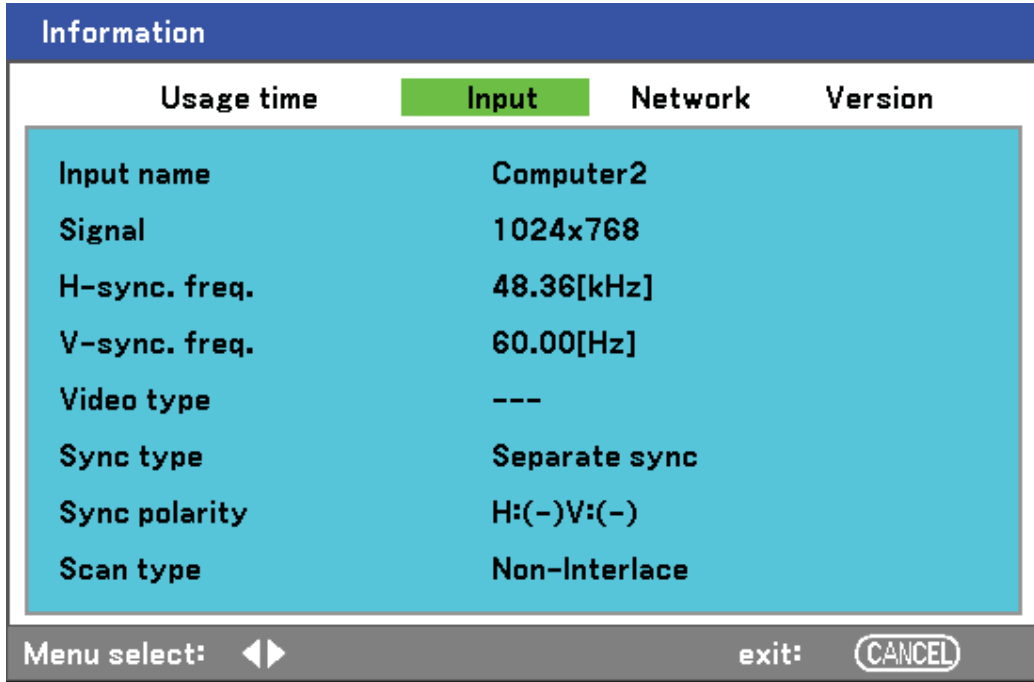

The following table lists all items with a description.

LABEL	DESCRIPTION
Input name	Displays the Input Terminal that is presently being used (see Default input select on page 74).
Signal	Displays the Source name of the signal presently being used.
H-sync. freq.	Displays Horizontal frequency in KHz.
V-sync. freq.	Displays Vertical frequency in Hz.
Video type	Displays Video type.
Sync type	Displays Sync type.
Sync polarity	Displays Sync polarity.
Scan type	Displays Scan type.

Network

The **Network** tab displays LAN settings as previously defined (see Network setting on page 71).

Information			
Usage time	Input	Network	Version
IP address	192.168.10.10		
Subnet	255.255.255.0		
Gateway	0.0.0.0		
MAC address	00:30:13:04:9E:01		

Menu select: ◀▶ exit: CANCEL

Version

The **Version** tab displays all the version and product details of the projector and associated software (for display only).

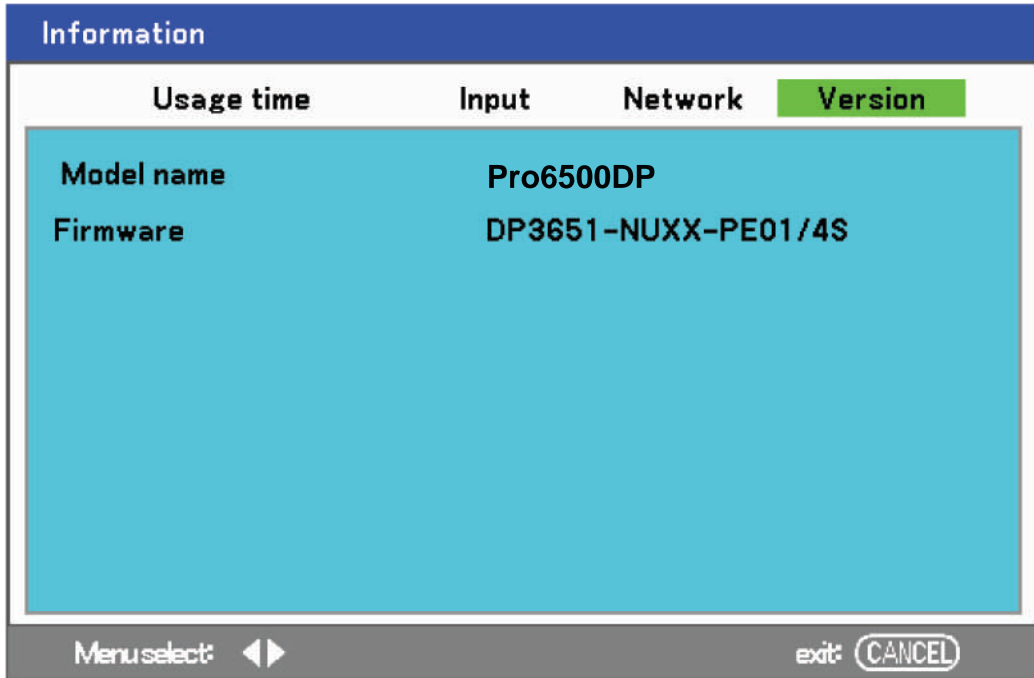

The following table lists all items with a description.

LABEL	DESCRIPTION
Model name	Displays Product ID.
Firmware	Displays Firmware version and Color Wheel currently installed (4-seg or 6-seg).

## Reset Menu Descriptions and Functions

Occasionally, circumstances may require that factory defaults be reset, for demonstration purposes for example, or when components are replaced.

The **Reset** menu contains options for returning settings to the factory default and is accessed by using the **Main** menu.

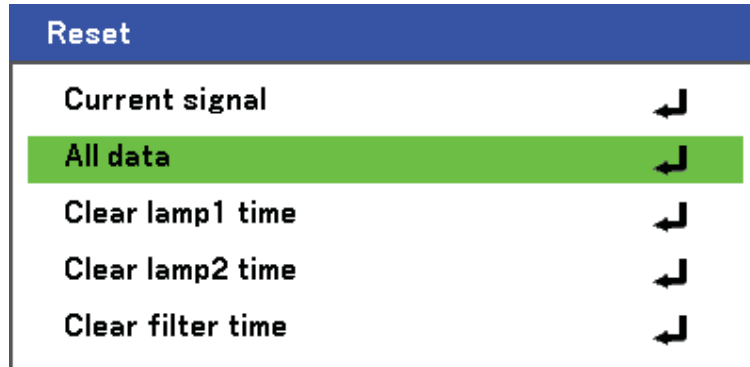

The following table lists all items with a description.

LABEL	DESCRIPTION	
Current signal	Reset the adjustments for current signal to factory-preset levels. All items in <b>Adjust</b> can be reset.	
All data	Resets all options to factory default regardless of when they were changed. Reset all the adjustments and settings for all the signals to the factory preset except <b>Language, Background, Key lock, Security, Network Mode, Communication Speed, Lamp life remaining, Lamp time, and Filter time.</b>	
Clear lamp1 time	Reset lamp1 time	These options should only be used when components are cleaned or replaced (see Maintenance on page 81)
Clear lamp2 time	Reset lamp2 time	
Clear filter time	Reset filter hours	



## Cleaning the projector

### Cleaning the Cabinet

Refer to the following guide to clean the projector cabinet.

1. Wipe off dust with a clean dampened cloth.
2. Moisten the cloth with warm water and mild detergent and wipe the cabinet.
3. Rinse all detergent from the cloth and wipe the projector again.

**Caution:**

To prevent discoloration or fading of the case, do not use abrasive alcohol-based cleaners.

### Cleaning the Lens

Refer to the following guide to clean the projector lens.

1. Apply a little optic lens cleaner to a clean, lint free cloth (do not apply the cleaner directly to the lens).
2. Lightly wipe the lens in a circular motion.

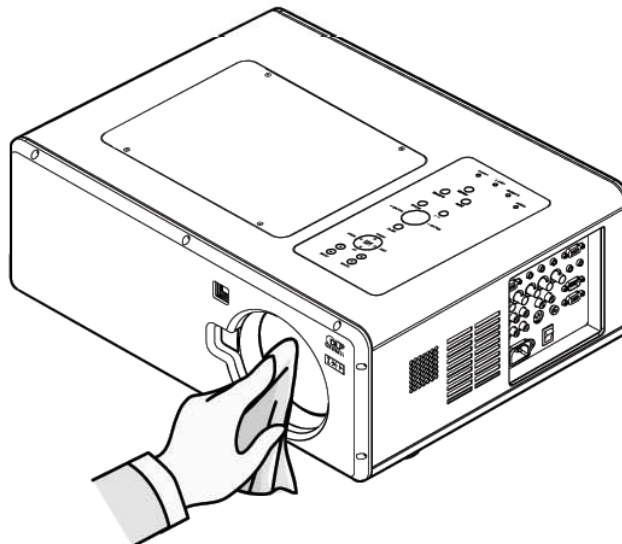

**Caution:**

Do not use abrasive cleaners or solvents.

To prevent discoloration or fading, avoid getting cleaner on the projector case.

### Cleaning the Filters

The projector uses three filters to keep the fans free of dust and other particles, and should be cleaned every 500 hours of operation. In dusty environments, it is recommended to clean the filters more frequently. If the filter is dirty or clogged, your projector may overheat. When the message below is displayed, the filters must be cleaned.

**Please clean filter.**

*Note:*

**When the Please clean filter message is displayed, please clean all three filters at the same time to synchronize the Filter time display.**

**The Filter Message item should be enabled in the Options menu. Refer to Option on page 72.**

Refer to the following guide to clean the filters.

1. The left-side and rear filters can be cleaned as demonstrated in the following images.

**Note:** Only clean the outside of the exhaust vents with a vacuum cleaner.

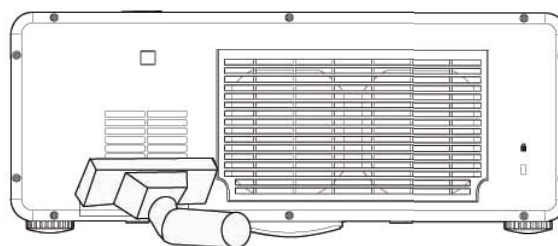
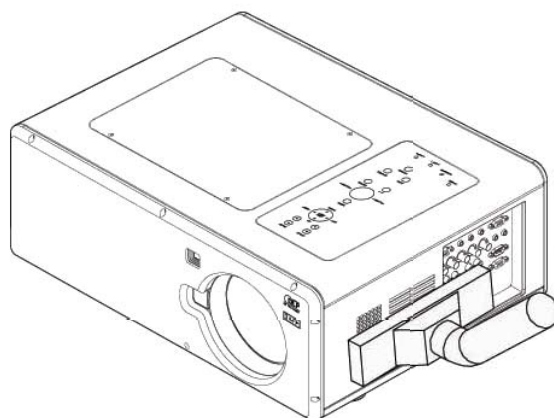

2. The rear exhaust vent can be accessed as shown.

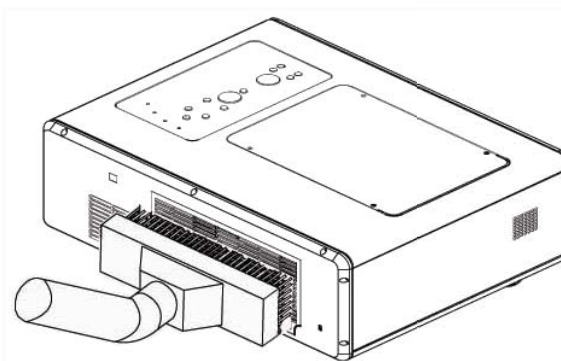

Once the filters are cleaned, please reset the filter hours by using the **Clear filter time** option in the Reset Menu Descriptions and Functions on page 80.

### Replacing the Lamps

When a lamp reaches the end of its usable life, the following message is displayed. Replace the lamp.

**The lamp has reached the end of its usable life.  
Please replace the lamp.**

The projection lamps should be replaced when they burn out. They should only be replaced with a certified replacement part, contact your local dealer if unsure.

**Note:**

1. Lamps are positioned differently. Take care not to force the lamps when replacing.
2. Installation of both lamp modules (Lamp 1 and Lamp 2) is required to operate the projector in dual or single lamp mode. If only a single lamp module is installed, the projector's lamp will not turn on and will appear as a lamp failure.
3. Lamps last approximately 2000-2100 hours (2500-2600 hours in Eco mode) and the End of lamp life message is displayed during the lamps' final 100 hours of operational life. Please replace during 2000-2100 hour.

**Important:**

1. The lamp contains a certain amount of mercury and should be disposed of according to local ordinance regulations.
2. Avoid touching the glass surface of the new lamp: doing so may shorten its operation life.

**Caution:**  
Lamp Handling Precautions

- This projector uses a high-pressure lamp which must be handled carefully and properly. Improper handling may result in accidents, injury, or create a fire hazard.
- Lamp life may differ from lamp to lamp and according to the environment of use. There is no guarantee of the same life for each lamp. Some lamps may fail or terminate their life in a shorter period of time than other similar lamps.
- If the projector indicates that the lamp should be replaced, i.e., if LAMP 1 and/or LAMP 2 light up, replace the lamp with a new one IMMEDIATELY after the projector has cooled down. (Follow carefully the instructions in the Lamp Replacement section of this manual.) Continuous use of the lamp with LAMP 1 and/or LAMP 2 lighted may increase the risk of lamp explosion.
- A Lamp may explode as a result of vibration, shock or degradation as a result of hours of use as its lifetime draws to an end. Risk of explosion may differ according to the environment or conditions in which the projector and lamp are being used.

**If a lamp explodes, the following safety precautions should be taken:**  
Disconnect the projector’s AC plug from the AC outlet immediately. Contact an authorized service station for a checkup of the unit and replacement of the lamp. Additionally, check carefully to ensure that there are no broken shards or pieces of glass around the projector or coming out from the cooling air circulation holes. Any broken shards found should be cleaned up carefully. No one should check the inside of the projector except those who are authorized trained technicians and who are familiar with projector service. Inappropriate attempts to service the unit by anyone, especially those who are not appropriately trained to do so, may result in an accident or injury caused by pieces of broken glass.

The projection lamp should be replaced when it burns out. It should only be replaced with a certified replacement part, which you can order from your local dealer.

**Important:**

**a.** The lamp contains a certain amount of mercury and should be disposed of according to local ordinance regulations.

**b.** Avoid touching the glass surface of the new lamp: Doing so may shorten its operation life.

**Warning:**

Be sure to turn off and unplug the projector at least 30 minutes before replacing the lamp. Failure to do so could result in a severe burn.

**Note:**

Safety glasses should be worn when replacing the lamp while the projector is ceiling mounted.

1. Remove the four screws on the lamp cover (A), and lift the lamp cover as shown (B).

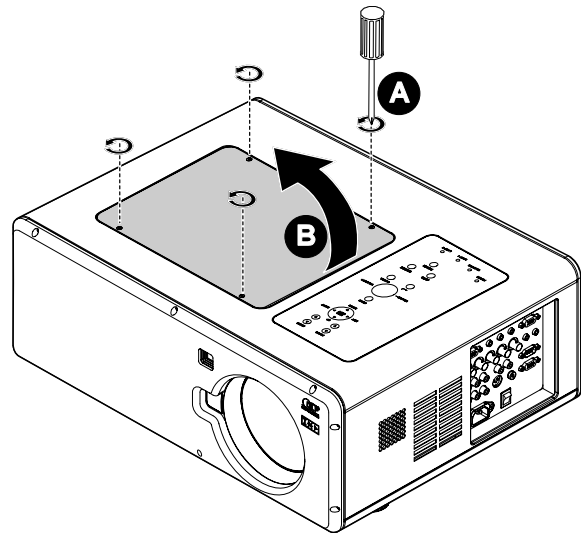

2. Loosen the two captive screws on the lamp module (A). Lift the module handle up as shown (B).

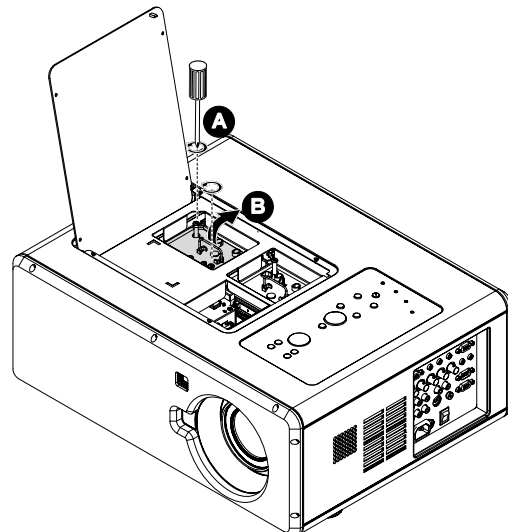

- 3.** Pull firmly on the module handle in the direction shown to remove the lamp.

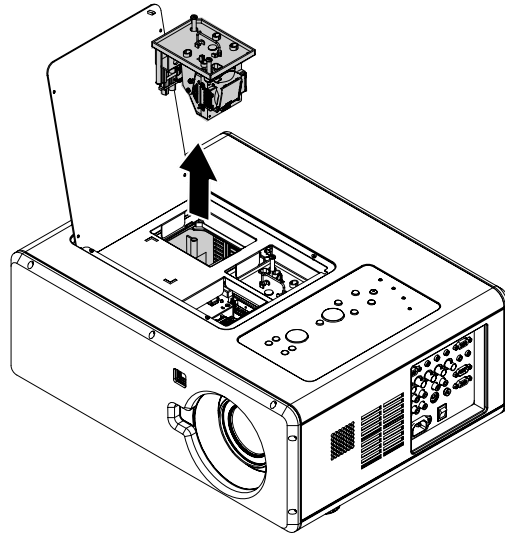

- 4.** Reverse steps 1 to 3 to install the new lamp module(s) and replace the lamp cover.

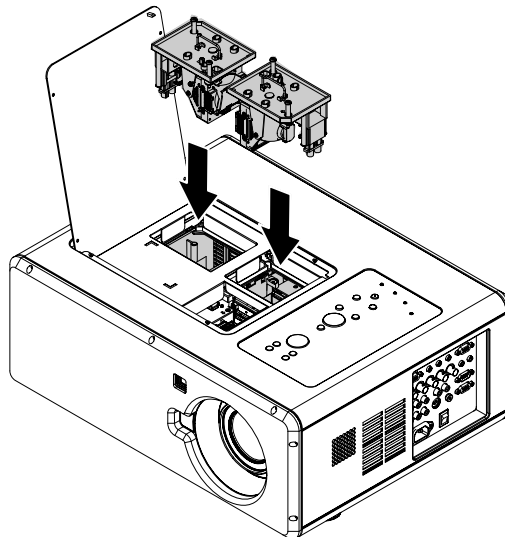

Resetting the Lamp Time Counter

After replacing the lamp(s), the lamp hour counter(s) should be reset to zero. Refer to the following guide:

1. Press the **Menu** button on the OSD control panel or Remote Control to open the **Main** menu.

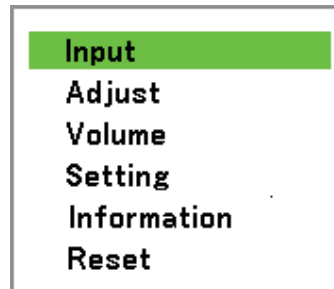

2. Press the **▲** or **▼** button to move to the **Reset** menu and press **↵**.

3. The **Reset** menu is displayed. Select **Clear lamp1 time** or **Clear lamp2 time** as required using **▲** or **▼** and press **↵**.

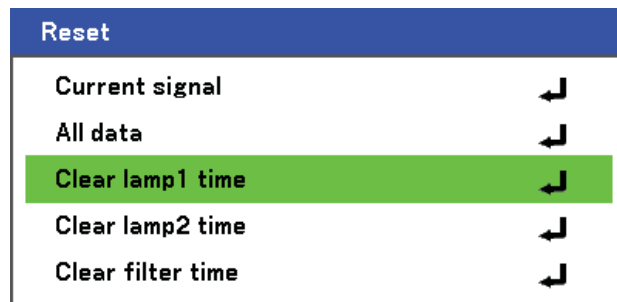

4. A confirmation box is displayed. Select **OK** using **◀** or **▶** and press **↵** to reset the selected Lamp hours to zero.



## Troubleshooting

### *Indicator Messages*

Several indicator messages are used by the projector to alert users of problems with setup or internal parts. The LEDs on the top surface of the projector show the status of the WARNING and lamp 1/2 as well as the general working order of the projector through the WARNING LED (see OSD Controls and Status LEDs on page 6 for location). The following tables describe the various states of the 4 LEDs.

#### *The POWER LED*

PROJECTOR STATUS	LED CONDITION	LED SEQUENCE	PROJECTOR CONDITION
AC off	Off	Off	Off
Cooling	Orange blink	0.5 secs on 0.5 secs off	After power off
Power up sequence	Green blink	0.5 secs on 0.5 secs off	Start up
Standby	Orange on	On	Standby
Power on	Green on	On	On

#### *The WARNING LED*

PROJECTOR STATUS	LED CONDITION	LED SEQUENCE	PROJECTOR CONDITION
Normal condition	Off	Off	Power on
Cover ERROR	Red 1 time blink (repeatedly)	0.5 secs on 2.5 secs off	ERROR
Temperature ERROR	Red 2 times blink (repeatedly)	(0.5 secs ON > 0.5 secs OFF) * 2 > 2.0 secs OFF	ERROR
Power ERROR	Red 3 times blink	(0.5 secs ON > 0.5 secs OFF) * 3 > 2.0 secs OFF	ERROR
Fan ERROR	Red 4 times blink (repeatedly)	(0.5 secs ON > 0.5 secs OFF) * 4 > 2.0 secs OFF	ERROR
Keylocked (when push key)	Orange light up	On	Keylocked function enabled
Standby (Power-saving)	Off	Off	Standby (Power-saving)
Standby (Normal)	Green light	On	Standby (Normal)

*The LAMP LEDs*

PROJECTOR STATUS	LED CONDITION	LED SEQUENCE	PROJECTOR CONDITION
Lamp off	Off	Off	Lamp off
End of the lamp life	Red blink	0.5 secs on 0.5 secs off	Replace lamp
No lamp	Red 1 time blink (repeatedly)	0.5 secs on 2.5 secs off	ERROR
Lamp ERROR	Red 6 times blink (repeatedly)	(0.5 secs ON > 0.5 secs OFF) * 6 > 2.0 secs OFF	ERROR
Cooling lamp	Orange blink	0.5 secs ON > 0.5 secs OFF	Switching lamp1 and 2
Re-light up sequence	Green blink	0.5 secs ON > 0.5 secs OFF	Start up
Lamp life over	Red on	On	Replace lamp
Eco mode	Orange on	On	Power on
Normal mode	Green on	On	Power on

*Common Problems and Solutions*

These guidelines provide tips to deal with problems you may encounter while using the projector. If the problem remains unsolved, contact your dealer for assistance.

Often the problem is something as simple as a loose connection. Check the following before proceeding to the problem-specific solutions.

- Use some other electrical device to confirm that the electrical outlet is working.
- Ensure the projector is turned on.
- Ensure all connections are securely attached.
- Ensure the attached device is turned on.
- Ensure a connected PC is not in suspend mode.
- Ensure a connected notebook computer is configured for an external display. (This is usually done by pressing an Fn-key combination on the notebook.)

*Tips for Troubleshooting*

In each problem-specific section, try the steps in the order suggested. This may help you to solve the problem more quickly.

Try to pinpoint the problem to avoid replacing non-defective parts.

For example, if you replace batteries and the problem remains, put the original batteries back and go to the next step.

Keep a record of the steps you take when troubleshooting: The information may be useful when calling for technical support or for passing on to service personnel.



## **Image Problems**

### ***Problem: No image appears on the screen***

1. Verify the settings on your notebook or desktop PC.
2. Turn off all equipment and power up again in the correct order.

### ***Problem: The image is blurred***

1. Adjust the **Focus** on the projector.
3. Press the **AUTO** button on the remote control or projector.
4. Ensure the projector-to-screen distance is within the specified range.
5. Check that the projector lens is clean.
6. Remove the lens cover.

### ***Problem: The image is wider at the top or bottom (trapezoid effect)***

1. Position the projector so it is as perpendicular to the screen as possible.
2. Use the Keystone button on the remote control to correct the problem.

### ***Problem: The image is reversed or upside down***

- Check the **Ceiling & Rear** setting on the **Setting** menu of the OSD.

### ***Problem: The image is streaked***

1. Set the Total dots and Fine sync. settings on the Adjust menu of the OSD to the default settings.
2. To ensure the problem is not caused by a connected PC’s video card, connect to another computer.

### ***Problem: The image is flat with no contrast***

1. Adjust the **Contrast** setting on the **Adjust** menu of the OSD.
2. Adjust the **Brightness** setting on the **Adjust** menu of the OSD.

### ***Problem: The color of the projected image does not match the source image.***

- Adjust the **Color temp.** and **Gamma** settings on the **Detail setting** menu of the OSD.

## *Lamp Problems*

### ***Problem: There is no light from the projector***

1. Check that the power cable is securely connected.
2. Ensure the power source is good by testing with another electrical device.
3. Restart the projector in the correct order and check that the Power LED is green.
4. If you have replaced the lamp recently, try resetting the lamp connections.
5. Replace the lamp module.
6. Remove the lens cap.
7. Put the old lamp back in the projector and have the projector serviced.

### ***Problem: The lamp goes off***

8. Power surges can cause the lamp to turn off. Press the power button twice to turn off the projector. When the Power LED is orange, press the power button.
9. Replace the lamp module.
10. Put the old lamp back in the projector and have the projector serviced.

### *Remote Control Problems*

***Problem: The projector does not respond to the remote control***

1. Direct the remote control towards remote sensor on the projector.
2. Ensure the path between remote and sensor is not obstructed.
3. Turn off any fluorescent lights in the room.
4. Check the battery polarity.
5. Replace the batteries.
6. Turn off other Infrared-enabled devices in the vicinity.
7. Have the remote control serviced.
8. Ensure that the remote control code conforms to the projector's code.
9. Ensure that the reset switch in the compartment lid on back of the remote control is set to use position.

### *Audio Problems*

***Problem: There is no sound***

1. Adjust the volume on the remote control.
2. Adjust the volume of the audio source.
3. Check the audio cable connection.
4. Test the source audio output with other speakers.
5. Have the projector serviced.

***Problem: The sound is distorted***

1. Check the audio cable connection.
2. Test the source audio output with other speakers.
3. Have the projector serviced.

## **Having the Projector Serviced**

If you are unable to solve the problem, you should have the projector serviced. Pack the projector in the original carton. Include a description of the problem and a checklist of the steps you took when trying to fix the problem. The information may be useful to the service personnel. Return the projector to the place you purchased it.

## Projector Specifications

This section provides technical information about the projector's performance.

### Optical Specifications

ITEM	DESCRIPTION
Projection system	Single DLP® chip, 4 segment color wheel
Resolution	1024 x 768 pixels* (up to UXGA @ 60 Hz)
Lamp	280 W AC (230 W in Eco mode), Dual lamp system
Image size (diagonal)	50" - 200" / 1.27m - 5.08m (GC805G) 40" - 500" / 1.02m – 12.7m (GB942G, GB940G, GB949G, GB957G)
Lens options	GC805G: Power focus, throw ratio 0.77:1, F2.0, f=11.4 mm GB942G: Power zoom and focus, throw ratio 1.33-1.79:1, F1.8-2.3, f=19.3-25.8 mm GB940G: Power zoom and focus, throw ratio 1.78-2.35:1, F1.7-1.9, f=26-34 mm GB949G: Power zoom and focus, throw ratio 2.22-4.43:1, F2.1-2.9, f=32-63 mm GB957G: Power zoom and focus, throw ratio 4.43-8.3:1, F2.2-3.1, f=63.5-117.4 mm
Lens shift	Vertical + 0.5V, Horizontal +/- 0.1H (GB942G, GB940G, GB949G, GB957G)

\*Effective pixels are more than 99.99%

*Electrical Specifications*

ITEM	DESCRIPTION
Inputs	1 Analog RGB (Mini D-Sub 15P), 1 Analog RGB R/Cr, G/Y, B/Cb, H, V (BNC x 5), 1 Digital RGB (DVI-D 24P), 1 Component Y, Cb/Pb, Cr/Pr (RCA x 3), 1 Component (Mini D-Sub 15P) shared with COMPUTER 1 IN, 1 S-Video (Mini DIN 4P), 1 Video, 3 Stereo Mini Audio, 2 (L/R) RCA Audio
Outputs	1 RGB (Mini D-Sub 15P), 1 Stereo Mini Audio, 1 Screen Trigger
Control	1 PC Control Port (D-Sub 9P)
USB Port	1 B Type (for Service)
LAN Port	RJ-45
Video Compatibility	NTSC, NTSC4.43, PAL, PAL-60/N/M/B/G/H/I), SECAM, HDTV: 1080p,1080i, 720p, SDTV: 576p, 576i, 480p, 480i
Scan Rate	Horizontal: 15 kHz, 31 to 90 kHz (RGB: 31 kHz or over) Vertical: 50 Hz to 85 Hz
Video Bandwidth	RGB: 100 MHz (-3dB)
Color Reproduction	16.7 million colors simultaneously, Full color
Horizontal Resolution	NTSC / NTSC4.43 / PAL / PAL-M / PAL-N / PAL60: 540 TV lines SECAM: 300 TV lines RGB: 1024 dots (H) x 768 dots (V)
External Control	RS232, IR, LAN
Sync Compatibility	Separate Sync / Composite Sync / Sync on G
Built-in Speakers	5W x 2
Power Requirement	100 - 240V AC, 50/60Hz
Input Current	7.4A
Power Consumption	730W in Dual Lamp Normal mode / 580W in Dual Lamp Eco mode 380W in Single Lamp Normal mode / 315W in Single Lamp Eco mode < 30W in Standby mode Normal < 5W in Standby mode Power saving

Mechanical Specifications

ITEM	DESCRIPTION
Dimensions	19.9" (W) x 7.6" (H) x 15.2" (D) 505 mm (W) x 192 mm (H) x 385 mm (D) (not including protrusions)
Weight	45.1 lb/20.5 kg

Environmental Considerations

ITEM	DESCRIPTION
Operational Temperatures	41° to 104°F / 5° to 40°C, 10% to 90% humidity (non-condensing)
Storage Temperatures	14° to 140°F (-10° to 60°C), 5% to 90% humidity (non-condensing)

Optional Parts

The parts listed below are optionally available. When ordering those parts, specify the item name and Model No. to the sales dealer.

- Standard Zoom Lens : Standard
- Long Zoom Lens : 912 lens
- Ultra Long Zoom Lens : 913 lens
- Short Zoom Lens : 911 lens
- Fixed Short Zoom Lens : 910 lens

### Cabinet Dimensions

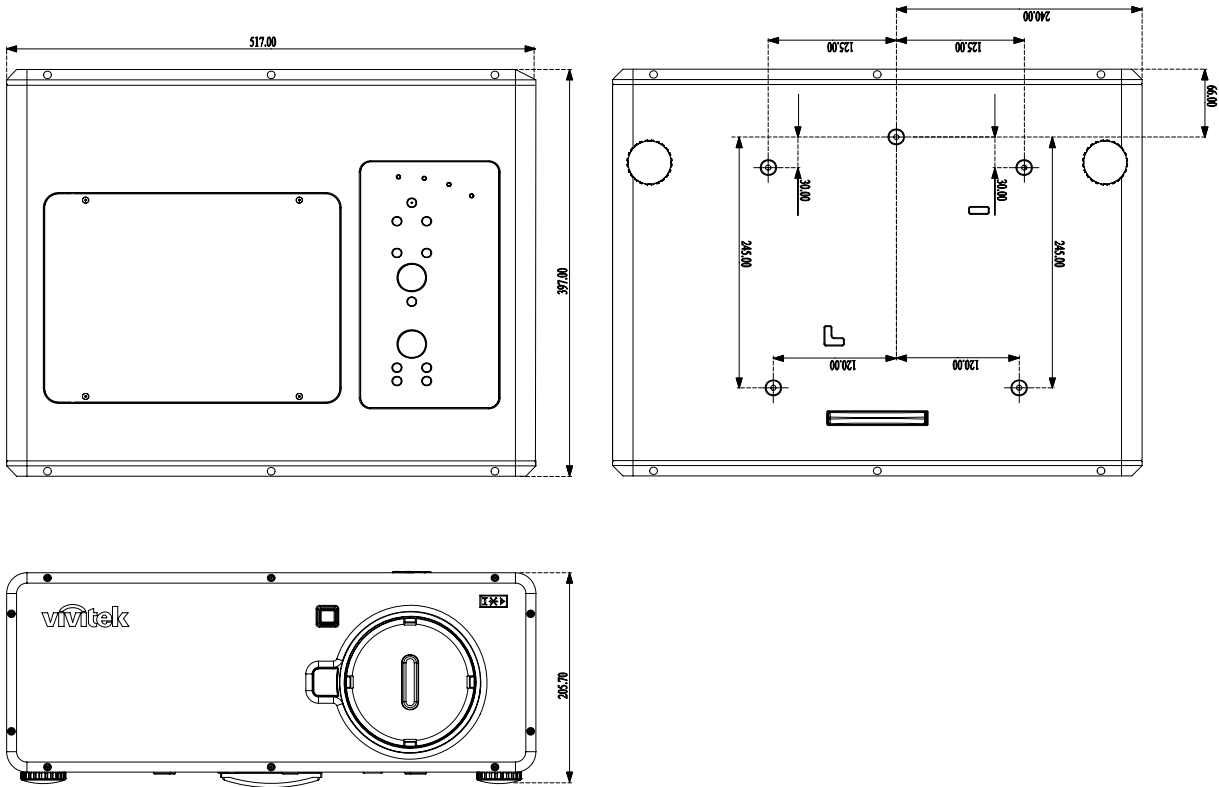

**Pin Assignments of Mini D-Sub 15 Pin Input Connector**

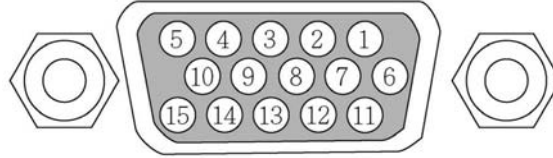

Signal Levels  
 Video signal: 0.7Vp-p (Analog)  
 Sync signal: TTL level

PIN NUMBER	RGB SIGNAL (ANALOG)	YCbCr SIGNAL
1	Red	Cr
2	Green or Sync on Green	Y
3	Blue	Cb
4	Ground	
5	Ground	
6	Red Ground	Cr Ground
7	Green Ground	Y Ground
8	Blue Ground	Cb Ground
9	No Connection	
10	Sync Signal Ground	
11	No Connection	
12	Bi-directional DATA (SDA)	
13	Horizontal Sync or Composite Sync	
14	Vertical Sync	
15	Data Clock	

## Compatible Input Signal List

The following table shows compatible signal types, their resolution and frequency refresh rates.

Horizontal: 15kHz, 31kHz to 90 kHz

Vertical: 50 Hz to 85 Hz

SIGNAL	RESOLUTION	H-SYNC (KHz)	V-SYNC (Hz)	RGB	DVI
VGA	640X350	31.5	70.1	○	○
VESA(DMT)	640X350	37.9	85.1	○	○
	720X350	31.5	70.0	○	○
CGA84	640X400	31.5	70.1	○	○
VESA(DMT)	640X400	37.9	85.1	○	○
	720X400	31.5	70.0	○	○
VESA(DMT)	720X400	37.9	85.0	○	○
SMT	720X400	31.5	60.0	○	○
SMT	640X480	31.5	60.0	○	○
VESA	640X480	37.9	72.8	○	○
VESA(DMT)	640X480	37.5	75.0	○	○
VESA(DMT)	640X480	43.3	85.0	○	○
VESA	800X600	35.2	56.3	○	○
VESA	800X600	37.9	60.3	○	○
VESA	800X600	46.9	75.0	○	○
VESA(DMT)	800X600	48.1	72.2	○	○
VESA(DMT)	800X600	53.7	85.1	○	○
	1024X768(*1)	35.5	43.0	○	○
VESA	1024X768	48.4	60.0	○	○
VESA	1024X768	56.5	70.1	○	○
VESA(DMT)	1024X768	60.0	75.0	○	○
VESA(DMT)	1024X768	68.7	85.0	○	○
VESA(DMT)	1152X864	67.5	75.0	○	○
	1280X720	37.5	50.0	○	○
	1280X720	45	60.0	○	○
DMT	1280X768	47.4	60.0	○	○
DMT	1280X768	47.8	60.0	○	○
DMT	1280X768	60.3	75.0	○	○
DMT	1280X768	68.6	85.0	○	○
	1280X800	41.2	50.0	○	○
DMT	1280X800	49.7	60.0	○	○
	1280X800	49.6	60.05	○	○
DMT	1280X800	62.8	75.0	○	○
DMT	1280X800	71.6	85.0	○	○
VESA(DMT)	1280X960	60.0	60.0	○	○
VESA(DMT)	1280X960	85.9	85.0	○	○
VESA(DMT)	1280X1024	64.0	60.0	○	○
VESA(DMT)	1280X1024	80.0	75.0	○	○
VESA(DMT)	1280X1024	91.1	85.0	○	○
	1360X768	47.7	60.0	○	○
	1360X768	48.36	60.0	○	○
	1360X768	48.36	60.0	○	○
DMT	1400X1050	64.7	60.0	○	○
DMT	1400X1050	65.3	60.0	○	○



DMT	1400X1050	82.3	75.0	○	○
CVT	1440X900	55.9	60.0	○	○
CVT	1440X900	70.6	75.0	○	○
CVT	1440X900	80.4	85.0	○	○
VESA(DMT)	1600X1200	75.0	60.0	○	○
CVT	1680X1050	65.3	60.0	○	○
1035i	1920X1035i	33.75	60.0	○	○
1080i/50	1920X1080	28.125	50.0	○	○
1080i/60	1920X1080	33.75	60.0	○	○
D-1080p/30	1920X1080	33.75	30.0	○	○
D-1080p/25	1920X1080	28.125	25.0	○	○
D-1080p/24	1920X1080	27.0	24.0	○	○
1080p/50	1920X1080	56.25	50.0	--	○
1080p/60	1920X1080	67.5	60.0	○	○
Apple Macintosh	640X480	35.0	66.7	○	○
	832X624	49.7	74.5	○	○
	1024X768	60.2	74.9	○	○
	1152X870	68.7	75.1	○	○
NTSC/NTSC4.43	Chroma Sub-carrier Frequency, 3.58 MHz & 4.43 MHz				
PAL	CCIR, Chroma Sub-carrier Frequency, 4.43 MHz				
SECAM	CCIR Sub-carrier frequency, 4.25/4.4 MHz				
SDTV	480i	15.8	60.0	--	--
	576i	15.6	50.0	--	--
EDTV	480p	31.5	60.0	--	--
	576p	31.3	50.0	--	--
HDTV	720p	45.0	60.0	--	--
	720p	37.5	50.0	--	--
	1080i	33.8	60.0	○	○
	1080i	28.1	50.0	○	○
	1080p	33.8	60.0	○	○
	1080p	56.25	50.0	○	○

**Note:**

*An image with higher or lower resolution than the projector’s native resolution (1024 x 768) will be compressed.*

*Some Composite and Sync on Green signals may not be displayed correctly.*

*Signals other than those specified in the table above may not be displayed correctly. If this should happen, change the refresh rate or resolution on your PC. Refer to Display Properties help section of your PC for procedures.*

**(\*1)** *Not support de-interlance for interlance input source.*

## PC Control Codes and Cable Connections

This projector provides a function to control and monitor the projector's operations by using the RS-232C serial port.

1. Connect a RS-232C serial cross cable to SERIAL PORT IN on the projector and serial port on the PC.
2. Launch a communication software provided with PC and setup the communication condition as follows:

Baud rate	: 38400 bps
Parity check	: none
Stop bit	: 1
Flow control	: none
Data bit	: 8

Minimum delay for next command: **1ms**

3. Type the command for controlling the projector and then enter the "Enter" key.

**Example:**

When you want to change the input to Computer 2, Type "C" "0" "6" "Enter."

The below table shows the typical command lists for controlling the projector. Please consult your local dealer for further information of another commands.

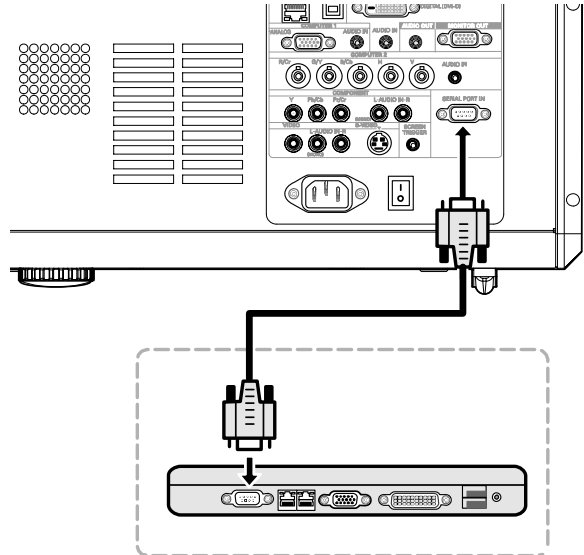

### PC Control Connector (DIN-9P)

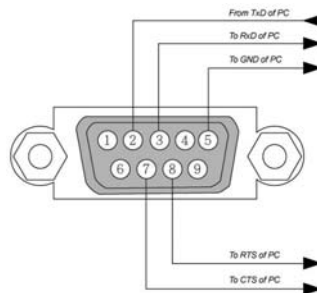

**Note:**

1. Pin 1, 4, 6 and 9 are not used.
2. Jumper "Request to Send" and "Clear to Send" together on both ends of the cable to simplify the cable connection.
3. For long cables, it is recommended to set communication speed within projector menus to 9600 bps.

### Control Command Diagram

The command is structured by the Header code, command code, data code and end code. Most of the commands are structured except some for the compatibility issue with other projectors.

	Header code	Command code	Data code	End code
HEX	7Eh	Command	Data	0Dh
ASCII	'~'	Command	Data	CR

### Control Sequence

The projector may send a return code after it received a command. If the command isn't received correctly, the projector will not send the return code

### Operation Commands

The operation commands execute the basic operation setting of this projector.

Operation	ASCII	HEX
Power On	~ P N CR ※	7Eh 50h 4Eh 0Dh
Power Off	~ P F CR	7Eh 50h 46h 0Dh
Auto Image	~ A I CR	7Eh 41h 49h 0Dh
Input Select 1 (COMPUTER1)	~ S 1 CR	7Eh 53h 31h 0Dh
Input Select 2 (COMPUTER2)	~ S 2 CR	7Eh 53h 32h 0Dh
Input Select 3 (COMPUTER3)	~ S 3 CR	7Eh 53h 33h 0Dh
Input Select 4 (COMPONENT)	~ S 4 CR	7Eh 53h 34h 0Dh
Input Select 5 (Video)	~ S 5 CR	7Eh 53h 35h 0Dh
Input Select 6 (S-Video)	~ S 6 CR	7Eh 53h 36h 0Dh

- ※ Power On command will not work for 1 minute after the power off command triggered.
- ※ CR: Carriage Return.

### Remote Commands

The remote commands simulate the code send from IR remote handset.

Button's name	ASCII	HEX
UP arrow	~ r U CR	7Eh 72h 55h 0Dh
DOWN arrow	~ r D CR	7Eh 72h 44h 0Dh
LEFT arrow	~ r L CR	7Eh 72h 4Ch 0Dh
RIGHT arrow	~ r R CR	7Eh 72h 52h 0Dh
POWER	~ r P CR	7Eh 72h 50h 0Dh
EXIT	~ r E CR	7Eh 72h 45h 0Dh
INPUT	~ r I CR	7Eh 72h 49h 0Dh
AUTO	~ r A CR	7Eh 72h 41h 0Dh
KEystone+	~ r K CR	7Eh 72h 4Bh 0Dh
KEystone-	~ r J CR	7Eh 72h 4Ah 0Dh
MENU	~ r M CR	7Eh 72h 4Dh 0Dh
STATUS	~ r S CR	7Eh 72h 53h 0Dh
MUTE	~ r T CR	7Eh 72h 54h 0Dh
ZOOM+ (Digital)	~ r Z CR	7Eh 72h 5Ah 0Dh
ZOOM- (Digital)	~ r Y CR	7Eh 72h 59h 0Dh
BLANK	~ r B CR	7Eh 72h 42h 0Dh
FREEZE	~ r F CR	7Eh 72h 46h 0Dh
VOLUME+	~ r V CR	7Eh 72h 56h 0Dh
VOLUME-	~ r W CR	7Eh 72h 57h 0Dh
ENTER (SELECT)	~ r N CR	7Eh 72h 4Eh 0Dh
FOCUS+	~ r 0 0 CR	7Eh 72h 30h 30h 0Dh
FOCUS-	~ r 0 1 CR	7Eh 72h 30h 31h 0Dh
ZOOM+	~ r 0 2 CR	7Eh 72h 30h 32h 0Dh
ZOOM-	~ r 0 3 CR	7Eh 72h 30h 33h 0Dh
KEystone	~ r C CR	7Eh 72h 43h 0Dh
LENS SHIFT	~ r G CR	7Eh 72h 47h 0Dh
ASPECT RATIO	~ r Q CR	7Eh 72h 51h 0Dh

*Set Value Command*

ITEM	ASCII	HEX
Brightness	~sB?CR※	7Eh 73h 42h ?h 0Dh
Contrast	~sC?CR	7Eh 73h 43h ?h 0Dh
Color(Saturation)	~sR?CR	7Eh 73h 52h ?h 0Dh
Tint	~sN?CR	7Eh 73h 4Eh ?h 0Dh
Scaling	~sA?CR	7Eh 73h 41h ?h 0Dh
Color Temperature	~sT?CR	7Eh 73h 54h ?h 0Dh
Projection Mode	~sJ?CR	7Eh 73h 4Ah ?h 0Dh

※?: ASCII Data

*Data Range*

ITEM	Set Data Range	Source
Brightness	0 ~ 100(default 50)	All Source
Contrast	0 ~ 100(default 50)	All Source
Saturation	0 ~ 100(default 50) ※	All Source
Tint	0 ~ 100 (default 50) ※	All Source
Scaling	0: 4:3 1: 16:9 2: 15:9 3: Crop 4: Letterbox 5: Native 6: Normal	All Source
Color Temperature	0: 5000K 1: 6500K 2: 7800K 3: 8500K 4: 9300K 5: 10500K 6: High-Bright	All Source
Projection Mode	0: Front 1: Rear+Ceiling 2: Rear 3: Ceiling	All Source

※ Saturation and Tint is not available when Video Type(color space) change to "RGB"

Example 1. Adjust Brightness value to 100

Send Command : ~sB100CR

Example 2. Adjust Color Temperature to Warm

Send Command : ~sT2CR

*Query Command*

ITEM	ASCII	HEX
Software Version	~qVCR	7Eh 71h 56h 0Dh
Power State	~qPCR	7Eh 71h 50h 0Dh
Input Select	~qSCR	7Eh 71h 53h 0Dh
Lamp Hours	~qL CR	7Eh 71h 4Ch 0Dh
Lamp1 Hours	~qL1 CR	7Eh 71h 4Ch 31h 0Dh
Lamp2 Hours	~qL2 CR	7Eh 71h 4Ch 32h 0Dh
Brightness	~qB CR	7Eh 71h 42h 0Dh
Contrast	~qC CR	7Eh 71h 43h 0Dh
Saturation	~qR CR	7Eh 71h 52h 0Dh
Tint	~qN CR	7Eh 71h 4Eh 0Dh
Aspect Ratio	~qA CR	7Eh 71h 41h 0Dh
Color Temperature	~qT CR	7Eh 71h 54h 0Dh
Projection Mode	~qJ CR	7Eh 71h 4Ah 0Dh

*Response message*

ITEM	Response Message examples
Software Version	DP3650-XXXX-DPXXX
Power State	On Off
Input Select	Computer1 Computer2 Computer3 Component Video S-Video
Lamp Hours	2000,2000
Lamp1 Hours	2000
Lamp2 Hours	2000
Brightness	0 ~ 100
Contrast	0 ~ 100
Saturation	0 ~ 100
Tint (Video)	0 ~ 100
Aspect Ratio	4:3 16:9 15:9 Crop Letterbox Native Normal
Color Temperature	5000K 6500K 7800K 8500K 9300K 10500K High-Bright
Projection Mode	Front Rear+Ceiling Rear Ceiling

Example 1. Get Brightness value

Send Command : ~qB CR

Response : 100

Example 2. Get Color Temperature

Send Command : ~qT CR

Response : Warm

## Screen Trigger

When the projector is powered ON the screen trigger output sends a low voltage trigger to the screen controller and the screen will go down. When the projector is powered OFF the screen trigger stops sending a low voltage trigger to the screen controller and the screen will go up.

**Note:**

To use this feature, you must turn on the Screen Trigger function. See Screen Trigger on page 73 for more information.

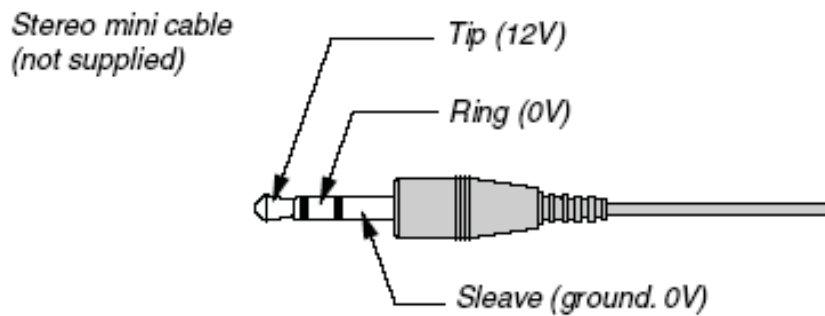

**Note:**

Screen controllers are supplied and supported by screen manufacturers.

**Note:**

Do not use this jack for anything other than intended use.

## Operation Using HTTP Browser

### Overview

The use of HTTP server functions will allow control of the projector from a web browser without the installation of special software. Please be sure to use “Microsoft Internet Explorer 4.x” or a higher version for the web browser. (This device uses “JavaScript” and “Cookies” and the browser should be set to accept these functions. The setting method will vary depending on the version of browser. Please refer to the help files and the other information provided in your software).

Access is gained to the HTTP server functions by specifying the following address in the entry column of the URL:

**http://the projector's IP address/index.html**

**http://the projector's IP address/manconf.html**

**Note:**

*The display or button responses can be slowed down or operation may not be accepted depending the settings of your network. Should this happen, consult your network administrator. The projector may not respond if its buttons are repeatedly pressed in rapid intervals. Should this happen, wait a moment and repeat. If you still can't get any response, turn off and back on the projector.*

### Preparation Before Use

Make network connections, set up the projector and confirm that it is complete before engaging in browser operations (see Network setting on page 69 for more information).

Operation with a browser that uses a proxy server may not be possible depending on the type of proxy server and the setting method. Although the type of proxy server will be a factor, it is possible that items that have actually been set will not be displayed depending on the effectiveness of the cache, and the contents set from the browser may not be reflected in operation. It is recommended that a proxy server not be used unless it is unavoidable.

### Handling of the Address for Operation by Using a Browser

Regarding the actual address that is entered for the address or entered to the URL column when operation of the projector is via a browser, the host name can be used as it is when the host name corresponding to the IP address of the projector has been registered to the domain name server by a network administrator, or the host name corresponding to the IP address of the projector has been set in the “HOSTS” file of the computer being used.

**Example 1:**

When the IP address of the projector is **192.168.73.1**, access is gained to the HTTP server functions by specifying **http://192.168.73.1/index.html** for the address or the entry column of the URL.

## Configuring Network Settings

The Network Settings screen is displayed as follows:

<http://the projector's IP address/manconf.html>

### **DOMAIN**

**Host Name:** Type in a hostname. Up to 60 alphanumeric characters can be used.

**Domain Name:** Type in domain name of the network connected to the projector. Up to 60 alphanumeric characters can be used.

**Apply** Click to reflect the entries.

### **MAIL**

**Alert Mail:** Click “Enable” to enable Alert Mail feature. This option notifies your computer of an error message via e-mail when using wired LAN. The error message will be notified when the projector lamp has reached the end of its usable life or an error occurs in the projector.

**Sender’s Address:** Specify the sender’s address. Up to 60 alphanumeric and symbols, characters can be used.

**SMTP Server Name:** Type in the SMTP server name to be connected to the projector. Up to 60 alphanumeric characters can be used.

**Recipient’s Address 1 to 3:** Type in your recipient’s address. Up to 60 alphanumeric and symbols characters can be used.

**Apply** Click to apply the settings.

**TEST MAIL**

Send a test mail to check if your settings are correct. Click to "Execute" to enable this feature.

**Test Mail Status Button:** Click to display the test result.

Sample of a message sent from the projector:

Projector Name: X X X X

Lamp 1 or 2 Hours Used: xxxx [H]

The lamp is at the end of its usable life. Please replace the lamp.

**Note:**

*If you entered an incorrect address in a test, you may not receive an Alert mail. Should this happen, check if the Recipient's Address is correctly set.*

*Unless any one of the [Sender's Address], [SMTP Server's Name] or [Recipient's Address 1-3] is selected, [Test Mail] is not available.*

**PJLINK**

This option allows you to set a password when you use the PJLink feature.

**OnOff:** Enable or disable the password.

**Password:** Enter a password (up to 32 characters)

**Note:**

*PJLink is a standardization of protocol used for controlling projectors of different manufacturers. This standard protocol is established by Japan Business Machine and Information System Industries Association (JBMIA) in 2005.*

*The projector supports all the commands of PJLink Class 1.*

PROJECTOR INPUT	PJLINK INPUT	PARAMETER
Computer 1	RGB 1	11
Computer 2	RGB 2	12
Video	VIDEO 1	21
S-Video	VIDEO 2	22
Component	VIDEO 3	23
Computer 3	DIGITAL 1	31





Structure of the HTTP Server

Once the projector is connected to a network and configured correctly, the following screen is displayed through the web browser.

<http://the projector's IP address/index.html>

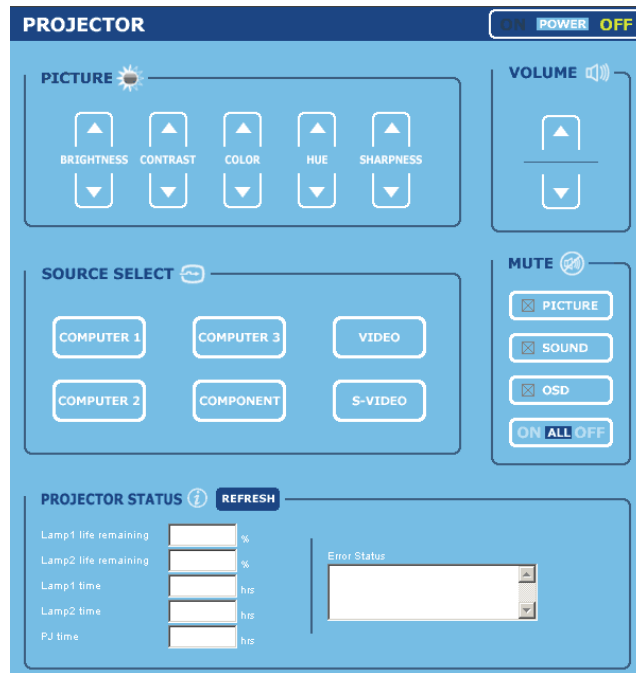

FUNCTION	SETTING	DESCRIPTION
POWER Panel	ON OFF	This controls the power to the projector
VOLUME Panel	▲ – Increases the volume adjustment value ▼ – Decreases the volume adjustment value	This controls the volume of the projector
MUTE Panel	PICTURE ON – Mutes the video PICTURE OFF – Cancels the video muting SOUND ON – Mutes the audio SOUND OFF – Cancels the audio muting OSD ON – Mutes the on-screen display OSD OFF – Cancels the muting of the on-screen display ALL ON – Mutes each of the video, audio, and on-screen display functions ALL OFF – Cancels the muting of each of the video, audio, and on-screen display functions	This controls the mute functions of the projector
PICTURE Panel	BRIGHTNESS ▲▼ – Increases or decreases the brightness adjustment value CONTRAST ▲▼ – Increases or decreases the contrast adjustment value COLOR ▲▼ – Increases or decreases the color adjustment value TINT ▲▼ – Increases or decreases the hue adjustment value SHARPNESS ▲▼ – Increases or decreases the sharpness adjustment value	Controls the video adjustments of the projector
SOURCE SELECT Panel	COMPUTER1 – Switches to the COMPUTER 1 IN connector COMPUTER2 – Switches to the COMPUTER 2 IN connector COMPUTER3 – Switches to the COMPUTER 3 IN connector COMPONENT – Switches to the COMPONENT IN connectors VIDEO – Switches to the VIDEO IN connector S-VIDEO – Switches to the S-VIDEO IN connector	This switches the input connector of the projector

FUNCTION	SETTING	DESCRIPTION
PROJECTOR STATUS Panel	Refresh – Updates the panel with the latest information available Lamp1 life remaining – Displays the remaining life of Lamp 1 as a percentage Lamp2 life remaining – Displays the remaining life of Lamp 2 as a percentage Lamp1 time – Displays the number of hours Lamp 1 has been used Lamp2 time – Displays the number of hours Lamp 2 has been used PJ time – Displays the number of hours the project has been used Error Status – Displays the status of errors occurring within the projector	This displays the status of selected projector functions

**Note:**

*The functions that can be controlled will vary depending on the signal being input to the projector (see [Selecting an Input Source](#) on page 27 for more information).*

### **FCC Warning**

This equipment has been tested and found to comply with the limits for a Class B digital device pursuant to Part 15 of the FCC Rules. These limits are designed to provide reasonable protection against harmful interference when the equipment is operated in a commercial environment.

This equipment generates, uses, and can radiate radio frequency energy and, if not installed and used in accordance with the instruction manual, may cause harmful interference to radio communications.

Operation of this equipment in a residential area is likely to cause harmful interference in which case the user will be required to correct the interference at his/her own expense.

Changes or modifications not expressly approved by the parties responsible for compliance could void the user's authority to operate the equipment.

### **Canada**

This class B digital apparatus complies with Canadian IECS-003.

### **Safety Certifications**

UL (file no: E134786) (UL60950-1/CSA60950-1), EMC, CE, CCC, and EK.

### **EN 55022 Warning**

This is a Class B product. In a domestic environment, it may cause radio interference, in which case the user may be required to take adequate measures. The typical use is in a conference room, meeting room, or auditorium.

## Free Manuals Download Website

<http://myh66.com>

<http://usermanuals.us>

<http://www.somanuals.com>

<http://www.4manuals.cc>

<http://www.manual-lib.com>

<http://www.404manual.com>

<http://www.luxmanual.com>

<http://aubethermostatmanual.com>

Golf course search by state

<http://golfingnear.com>

Email search by domain

<http://emailbydomain.com>

Auto manuals search

<http://auto.somanuals.com>

TV manuals search

<http://tv.somanuals.com>