

Endless Summer[®]



Cleaning Instructions, Pilot Replacement and Valve Change

Model No.:
233010
Natural Gas



Tools required:

- 8mm open-end wrench
- 9mm open-end wrench
- 10mm open-end wrench
- 12mm open-end wrench
- 13mm open-end wrench
- Phillips screw driver
- 5/8" open end wrench
- 3/4" open end wrench
- Needle nose pliers
- Soap and water solution (to check for leaks)

DANGERS and *Cautions*

- 1. Installation and repair should be done by a qualified service person.**
- 2. Use only Blue Rhino Global Sourcing, LLC. factory authorized parts. The use of any part that is not factory authorized can be dangerous. This will also void your warranty. Contact 1.800.762.1142.**
- 3. Do not use flammable solutions or material to clean heater or heater parts. Use only warm soapy water to clean outside of heater.**
- 4. Do not submerge control valve in water.**



Steps 1-4

1. Turn gas supply off and disconnect from gas supply. **Important: make sure your gas supply is off.**
2. Remove dome.
3. Remove engine from post.



Step 5



Remove the three bolts which secure the emitter to the emitter bottom using a 9mm wrench.



Step 6

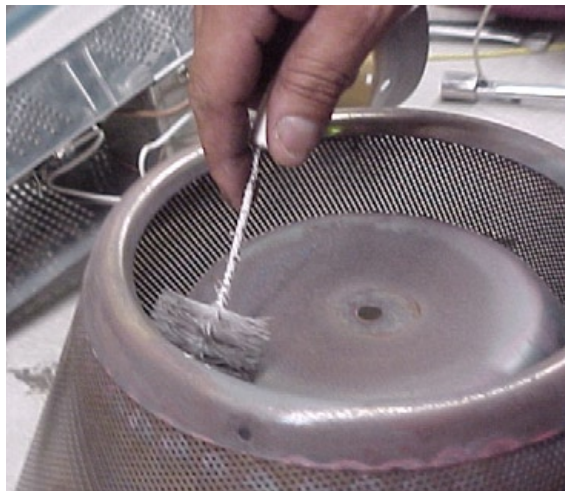

1. Clean the carbon build-up off the inside of the emitter bottom with a non-abrasive scouring pad or bottle brush. Clean the outside of the emitter bottom with the scouring pad.
2. Use the air compressor to blow away any excess soot.

DANGER: Never use any flammable solutions or material to clean heater or heater parts. Use only a mild soap and water solution.

Do not to soak the valve.



Step 7

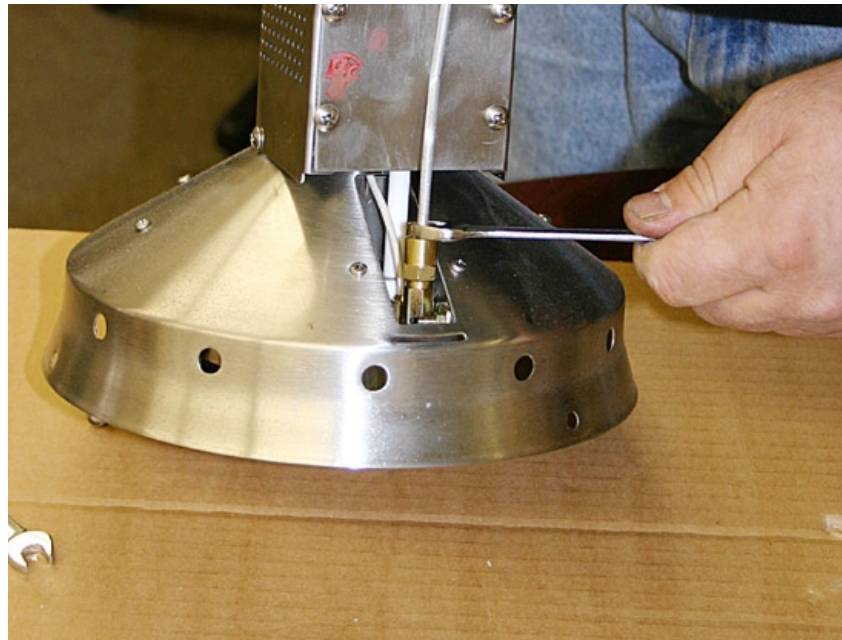

Disconnect the pilot supply tube using #10 open-ended wrench.



Step 8



Disconnect the burner supply tube from the control valve using 5/8" open-ended wrench.



Step 9

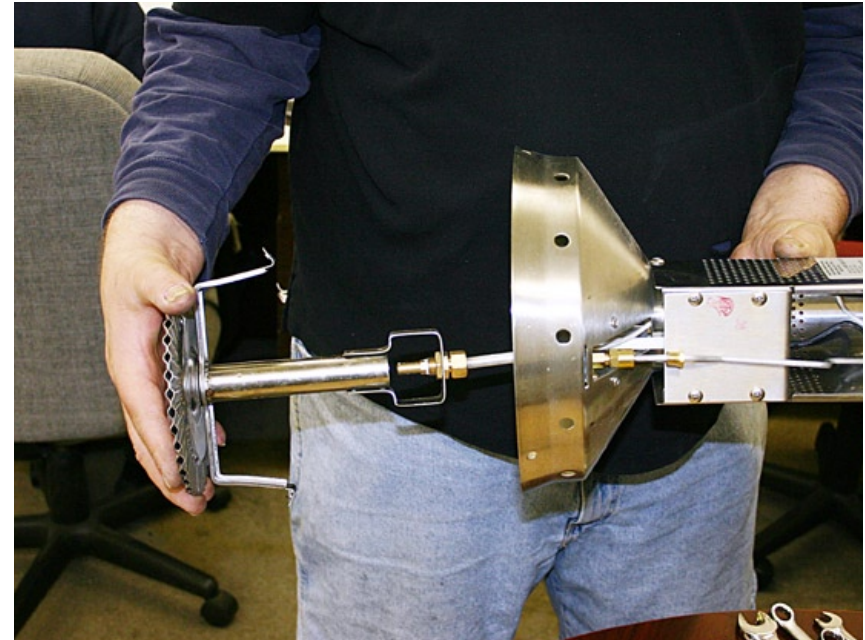
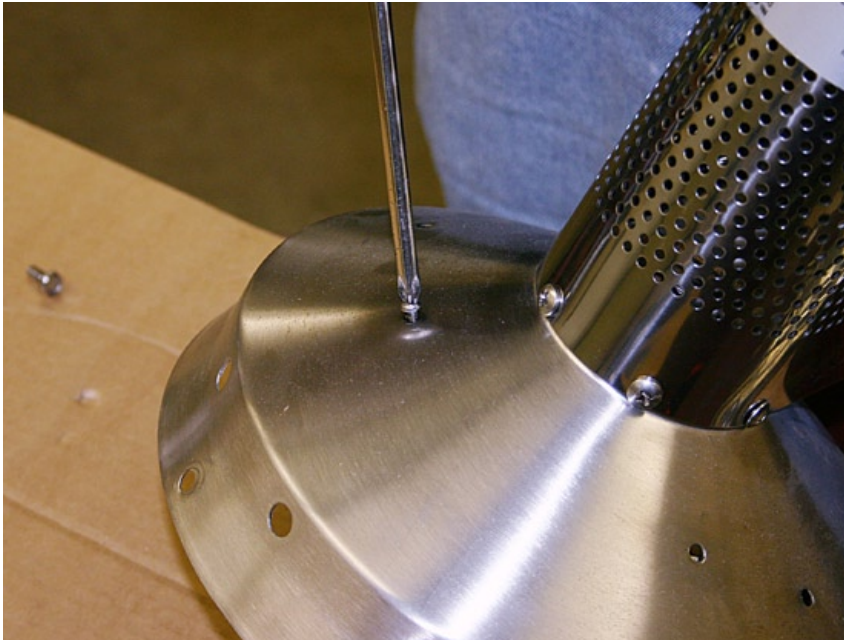

1. Disconnect the burner from the emitter bottom by removing the 2 phillips screws on the bottom of the emitter bottom.
2. Carefully remove the burner.



Step 10

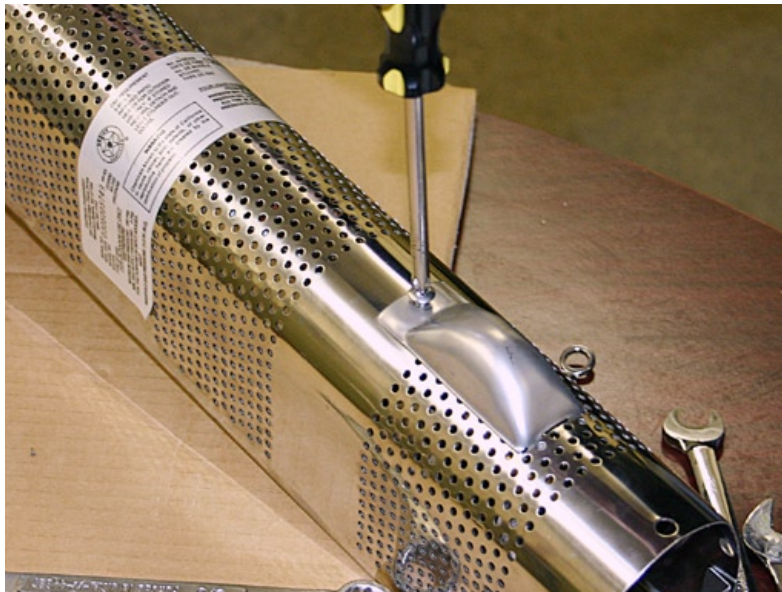

Disconnect the thermal couple wire from the control valve:

1. Remove the screw that holds the access panel to the housing.
2. Remove the nut from the back of the control valve using 8 mm open-ended wrench.

Note: Be very careful not to damage any wires.



Step 11

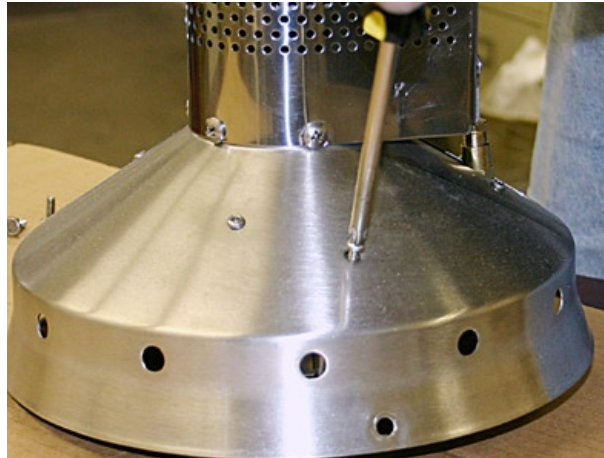
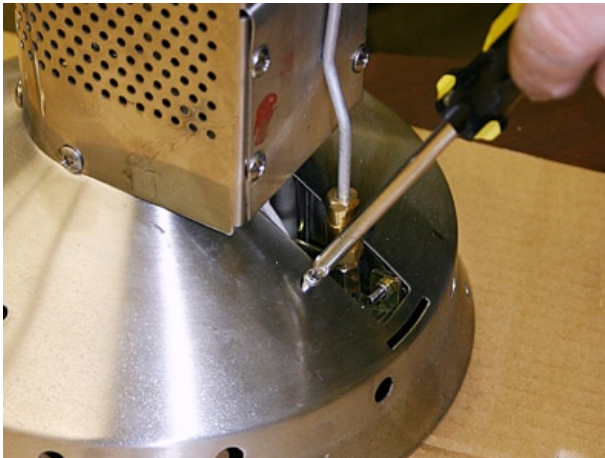

Remove the heat and pilot shield from the emitter bottom.

1. Remove the 4 screws in emitter bottom.

Note: 2 screws are near pilot opening, and 2 screws are on the back side of the emitter bottom.

2. Lift the heat shield assembly out.

Note: Be very careful not to damage any wires.



Step 12

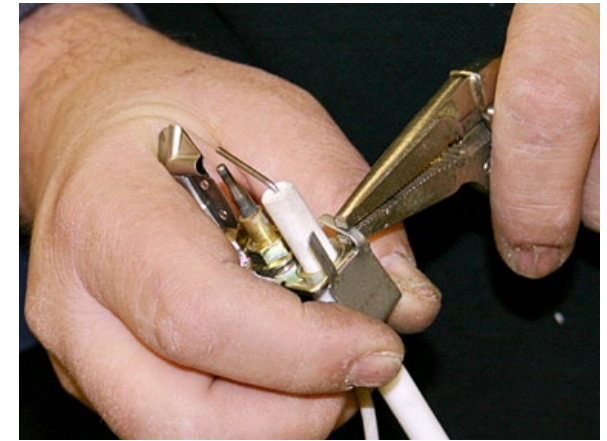
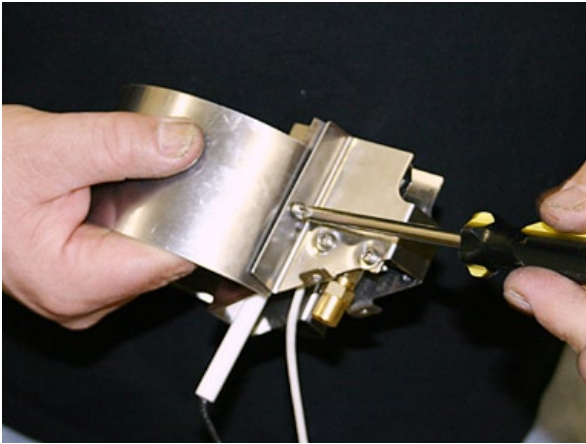

1. Remove the pilot assembly by removing the 2 screws that hold the pilot assembly in place

Note: you may need to use a pair of needle nose pliers to hold the nuts in place.

2. If replacing the pilot:

A. Remove the igniter wire, by carefully bending the fork on the retaining bracket up using need nose pliers

B. Pull down on the ceramic tube

C. Disconnect the igniter wire from the pilot.

D. Replace the old pilot with the new pilot, re-attach the igniter wire, slide the ceramic tube back up, and bend the fork to the proper place.

3. Reattach the pilot assembly.



Step 13

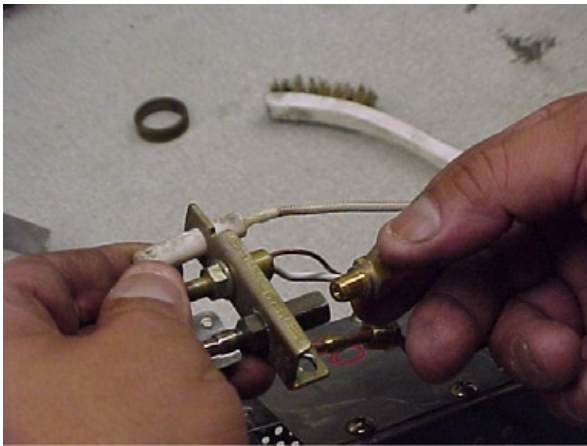

1. Remove the orifice by placing the 12 mm open-ended on the pilot orifice and the 10 mm open-ended on the hex tube just below the pilot hood.
2. Use a pipe cleaner to clean both the inside and outside of the pilot orifice.
3. With a brush, lightly clean the top of the pilot orifice. Use care not to enlarge the orifice hole.



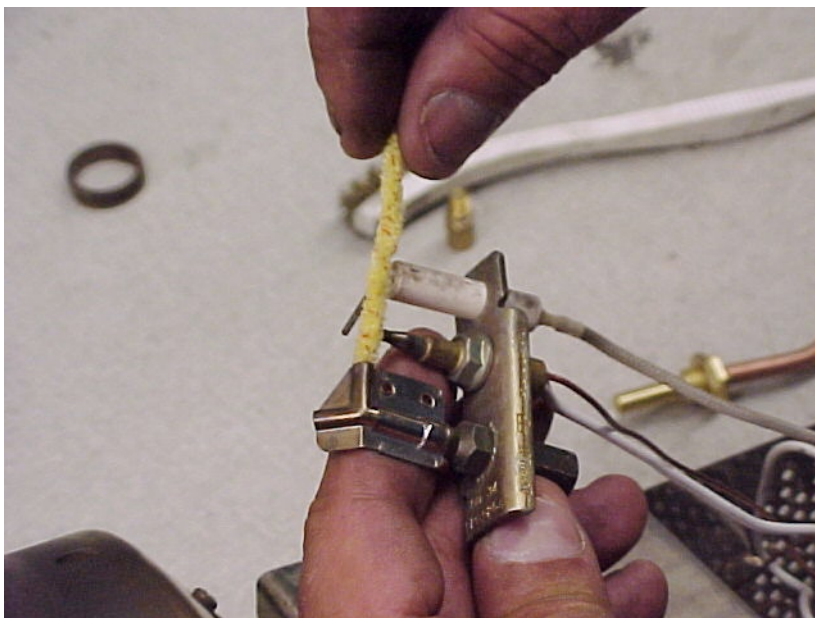

1. Use a heavy-duty pipe cleaner to clean the bottom of the black hex tube on the pilot assembly. Make sure to extend the pipe cleaner past the silver hood.
2. Clean the port at the side of the pilot hood with a heavy-duty pipe cleaner.
3. Blow out any excess soot or debris with an air hose or a can of compressed air.



Step 14



Insert bottle brush into venturi tube and give a couple of twists. This will clear any debris or spider webs from the venturi tube.



Step 15



1. Insert a heavy-duty pipe cleaner into each burner port to clean them. Use a non-abrasive scouring pad to clean the outside of the burner.
2. Using an air hose or can of compressed air to blow any excess soot from the burner ports and the venturi tube.
3. Use a brush or compressed air to clean the burner orifice.

Note: Be careful not to enlarge any holes.



Step 16

If this is all you need to do then follow instructions in reverse to reassemble heater.

If not, please continue.



Step 17

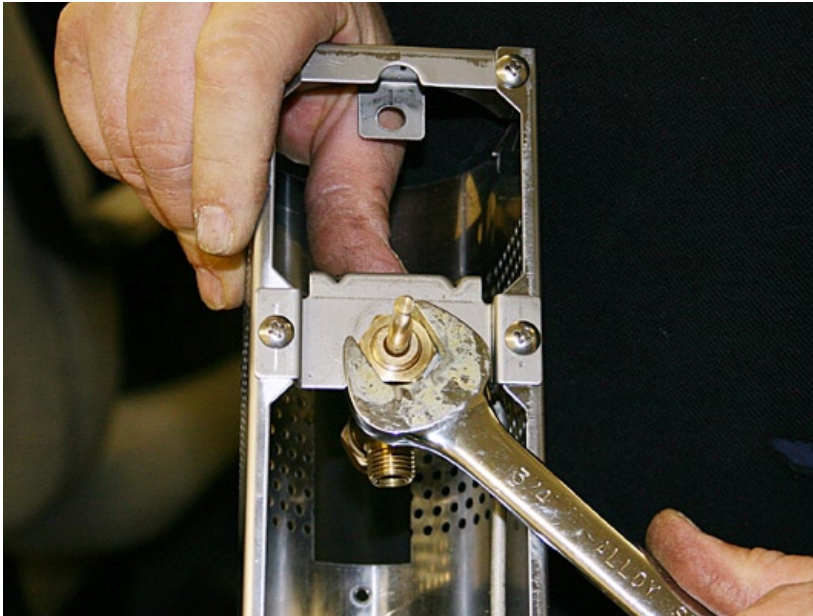

Replacing the control valve:

1. Remove the control valve by removing the 3/4" brass nut on the front side of the valve housing.
2. Push the control valve back and pull it out from the front of the valve housing.

Note: Be careful not to damage the pilot supply tube.

3. Remove the pilot supply tube from the old control valve using 13 mm open-ended wrench or 1/2" open-ended wrench.



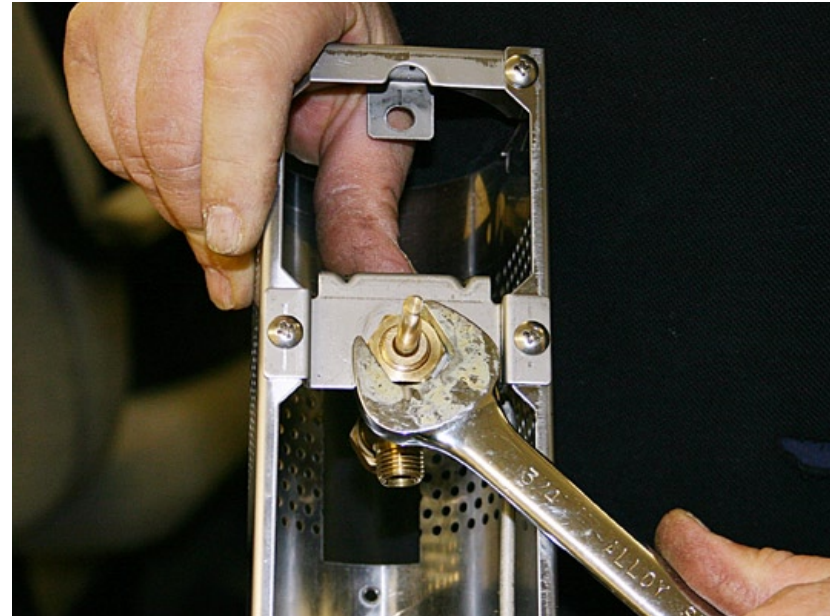
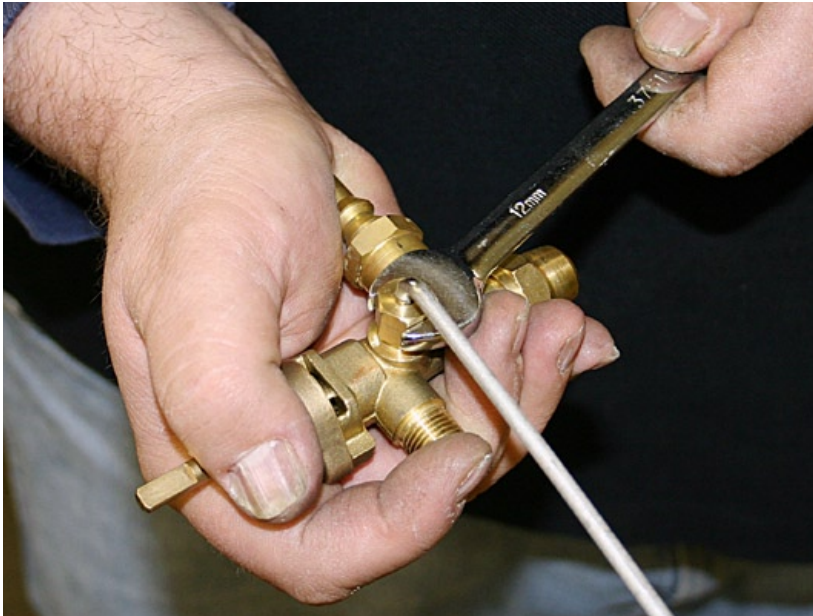

4. Attach the pilot supply tube to the new control valve
5. Install the new control valve.
- Note:* Make sure the valve is secure.
6. Reattach the 3/4" brass nut.



Step 18

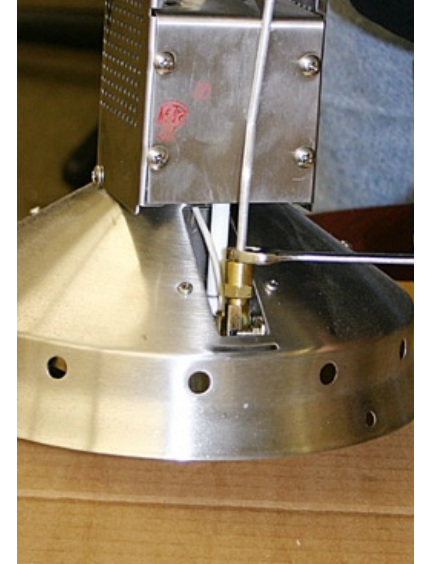

1. Place pilot assembly with heat shield into the emitter bottom
2. Attach the pilot supply tube to the pilot.
3. Tighten the screws that hold the guard in place.



Step 19

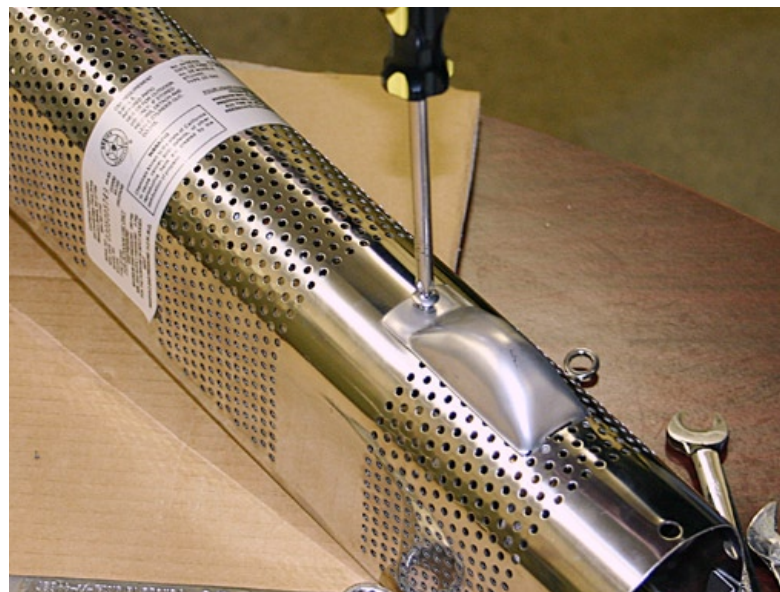

1. Reinstall the thermal couple by attaching the nut on the back of the control valve, using the 8 mm open-end wrench.

Note: Finger tighten the nut, plus a $\frac{1}{4}$ turn

2. Reinstall the access panel.



Step 20

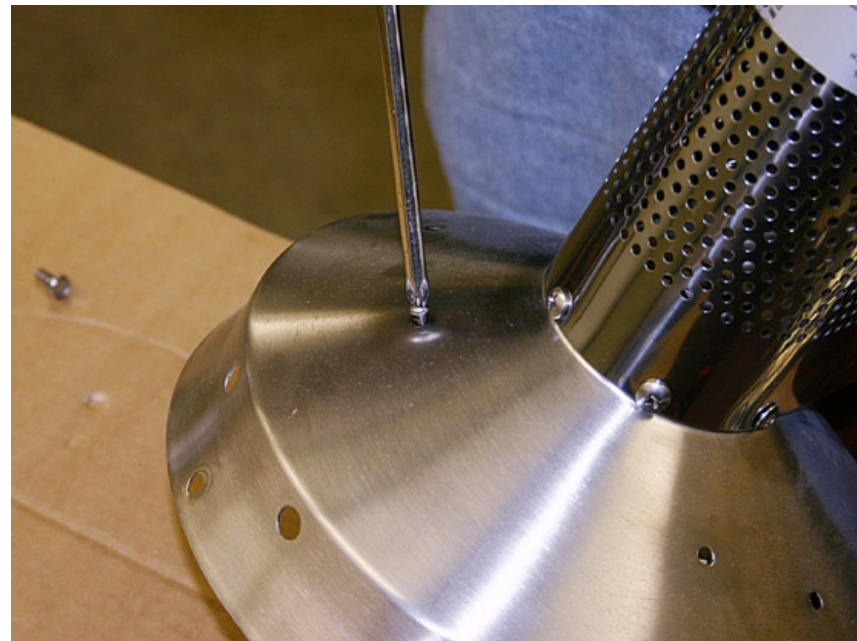
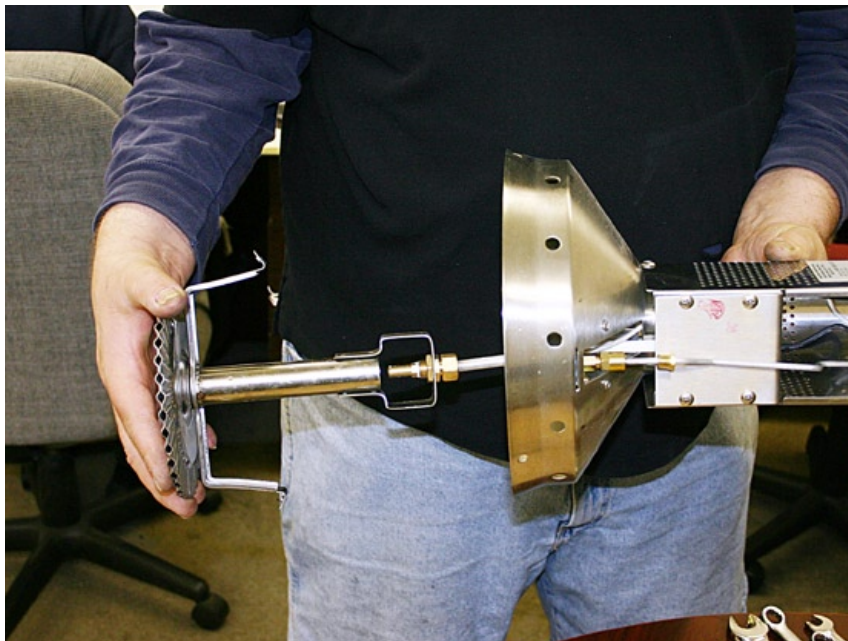

Insert the burner and burner supply tube, secure into place with screws.



Step 21



Attach the burner supply tube nut on the control valve.



Step 22



Attach the three bolts which secure the emitter to the emitter bottom using a 9mm wrench.



Steps 23-26

23. Attach the engine to the post

24. Burner Connections

1. Make sure the regulator valve and hose connections are securely fastened to the burner and the tank.
2. If your unit was assembled for you, visually check the connection between the burner pipe and orifice. Make sure the burner pipe fits over the orifice.

WARNING: Failure to inspect this connection or follow these instructions could cause a fire or an explosion which can cause death, serious bodily injury, or damage to property.

3. Please refer to diagram for proper installation.
4. If the burner pipe does not rest flush to the orifice, please contact 1.800.762.1142 for assistance.

25. Attach the dome

26. Attach the Natural Gas Source

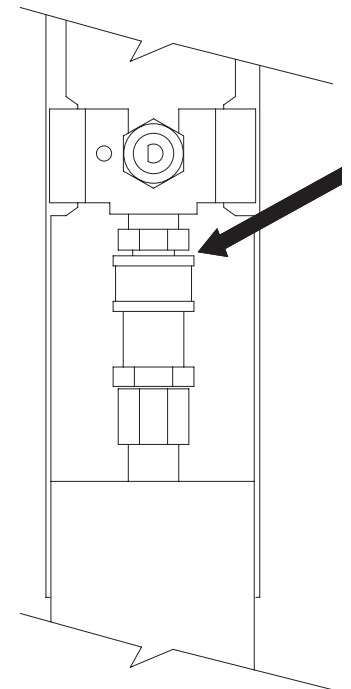

Step 27 - IMPORTANT

Perform leak check.



WARNING FOR YOUR SAFETY

If you smell gas -

1. Shut off gas to appliance.
2. Extinguish any open flame.
3. If odor continues, immediately call your gas supplier or your fire department.

1. Do not operate if gas leak is present. Gas leaks may cause a fire or explosion.
2. You must follow all leak-checking procedures before operating. To prevent fire or explosion hazard when testing for a leak:
 - a. Always perform leak test before lighting the heater and each time the tank is connected for use.
 - b. No smoking. Do not use or permit sources of ignition in the area while conducting a leak test.
 - c. Conduct the leak test outdoors in a well-ventilated area.
 - d. Do not use matches, lighters, or a flame to check for leaks.
 - e. Do not use heater until any and all leaks are corrected.If you are unable to stop a leak, disconnect the gas supply. Call a gas appliance serviceman or your local gas supplier.



Gas Line Connection

1. Make 2-3 oz. of leak solution by mixing one part liquid dishwashing soap with three parts water.
2. Make sure control knobs are off.
3. Turn gas source ON at valve.
4. Spoon leak check solution onto gas line and control valve connections.
5. If any bubbles appear turn gas source OFF, reconnect and re-test. If you continue to see bubbles after several attempts, disconnect gas source and contact 1.800.762.1142 for assistance.
6. If no bubbles appear after one minute turn gas source OFF, wipe away solution and proceed.

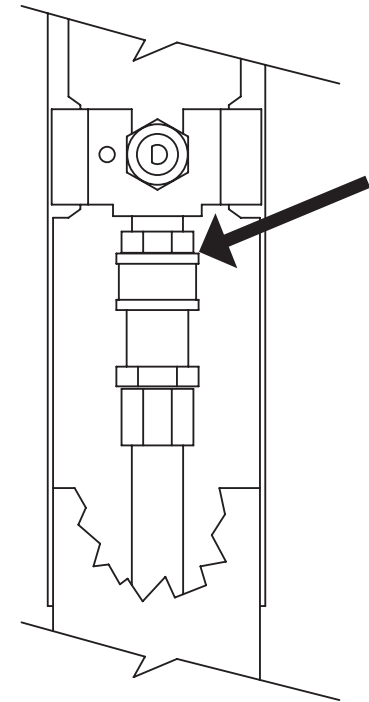

Blue Rhino Global Sourcing, LLC
104 Cambridge Plaza Drive, Winston-Salem, NC 27104 USA
1.800.762.1142, www.bluerhino.com

© 2004 Blue Rhino Global Sourcing, LLC All Rights Reserved.
Endless Summer® is a registered trademark of Blue Rhino Global Sourcing, LLC All Rights Reserved.
Blue Rhino® is a registered trademark of Ferrellgas, L.P. All Rights Reserved.

Free Manuals Download Website

<http://myh66.com>

<http://usermanuals.us>

<http://www.somanuals.com>

<http://www.4manuals.cc>

<http://www.manual-lib.com>

<http://www.404manual.com>

<http://www.luxmanual.com>

<http://aubethermostatmanual.com>

Golf course search by state

<http://golfingnear.com>

Email search by domain

<http://emailbydomain.com>

Auto manuals search

<http://auto.somanuals.com>

TV manuals search

<http://tv.somanuals.com>