



# Cisco Model DPC3208 and EPC3208 8x4 DOCSIS 3.0 Cable Modem User Guide



# Please Read

## Important

Please read this entire guide. If this guide provides installation or operation instructions, give particular attention to all safety statements included in this guide.

# Notices

## Trademark Acknowledgments

Cisco and the Cisco logo are trademarks or registered trademarks of Cisco and/or its affiliates in the U.S. and other countries. A listing of Cisco's trademarks can be found at [www.cisco.com/go/trademarks](http://www.cisco.com/go/trademarks). DOCSIS is a registered trademark of Cable Television Laboratories, Inc. EuroDOCSIS, EuroPacketCable, and PacketCable are trademarks of Cable Television Laboratories, Inc. The Wi-Fi Protected Setup mark is a mark of the Wi-Fi Alliance. Wi-Fi Protected Setup is a trademark of the Wi-Fi Alliance.

Other third party trademarks mentioned are the property of their respective owners.

The use of the word partner does not imply a partnership relationship between Cisco and any other company. (1009R)

## Publication Disclaimer

Cisco Systems, Inc. assumes no responsibility for errors or omissions that may appear in this publication. We reserve the right to change this publication at any time without notice. This document is not to be construed as conferring by implication, estoppel, or otherwise any license or right under any copyright or patent, whether or not the use of any information in this document employs an invention claimed in any existing or later issued patent.

### Disclaimer

The maximum performance for wireless is derived from IEEE Standard 802.11 specifications. Actual performance can vary, including lower wireless network capacity, data throughput rate, range and coverage. Performance depends on many factors, conditions and variables, including distance from the access point, volume of network traffic, building materials and construction, operating system used, mix of wireless products used, interference and other adverse conditions.

## Software and Firmware Use

The software described in this document is protected by copyright law and furnished to you under a license agreement. You may only use or copy this software in accordance with the terms of your license agreement.

The firmware in this equipment is protected by copyright law. You may only use the firmware in the equipment in which it is provided. Any reproduction or distribution of this firmware, or any portion of it, without our express written consent is prohibited.



## Copyright

© 2011 Cisco and/or its affiliates. All rights reserved. Printed in the United States of America.

Information in this publication is subject to change without notice. No part of this publication may be reproduced or transmitted in any form, by photocopy, microfilm, xerography, or any other means, or incorporated into any information retrieval system, electronic or mechanical, for any purpose, without the express permission of Cisco Systems, Inc.

# Notice to Installers

The servicing instructions in this notice are for use by qualified service personnel only. To reduce the risk of electric shock, do not perform any servicing other than that contained in the operating instructions, unless you are qualified to do so.

<p><b>Note to System Installer</b></p> <p>For this apparatus, the coaxial cable shield/ screen shall be grounded as close as practical to the point of entry of the cable into the building. For products sold in the US and Canada, this reminder is provided to call the system installer's attention to Article 820-93 and Article 820-100 of the NEC (or Canadian Electrical Code Part 1), which provides guidelines for proper grounding of the coaxial cable shield.</p>	
 <p>This symbol is intended to alert you that uninsulated voltage within this product may have sufficient magnitude to cause electric shock. Therefore, it is dangerous to make any kind of contact with any inside part of this product.</p>	<p>CAUTION: To reduce the risk of electric shock, do not remove cover (or back). No user-serviceable parts inside. Refer servicing to qualified service personnel.</p> <p><b>WARNING</b> TO PREVENT FIRE OR ELECTRIC SHOCK, DO NOT EXPOSE THIS UNIT TO RAIN OR MOISTURE.</p>  <p>This symbol is intended to alert you of the presence of important operating and maintenance (servicing) instructions in the literature accompanying this product.</p>



# Notice à l'attention des installateurs de réseaux câblés

Les instructions relatives aux interventions d'entretien, fournies dans la présente notice, s'adressent exclusivement au personnel technique qualifié. Pour réduire les risques de chocs électriques, n'effectuer aucune intervention autre que celles décrites dans le mode d'emploi et les instructions relatives au fonctionnement, à moins que vous ne soyez qualifié pour ce faire.

<p><b>Remarque à l'attention de l'installateur du système</b></p> <p>Avec cet appareil, le blindage/écran du câble coaxial doit être mis à la terre aussi près que possible du point d'entrée du câble dans le bâtiment. En ce qui concerne les produits vendus aux États-Unis et au Canada, ce rappel est fourni pour attirer l'attention de l'installateur sur les articles 820-93 et 820-100 du Code national de l'électricité (ou Code de l'électricité canadien, Partie 1) qui fournissent des lignes directrices concernant la mise à la terre correcte du blindage (écran) du câble coaxial.</p>	
 <p>Ce symbole a pour but de vous prévenir que des tensions électriques non isolées existent à l'intérieur de ce produit, pouvant être d'une intensité suffisante pour causer des chocs électriques. Il est donc dangereux d'établir un contact quelconque avec l'une des pièces comprises à l'intérieur de ce produit.</p>	<p>ATTENTION : Pour réduire les risques de chocs électriques, ne pas enlever le couvercle (ou le panneau arrière). Ne contient aucune pièce réparable par l'utilisateur. Confier les interventions aux techniciens d'entretien qualifiés.</p> <p><b>AVERTISSEMENT</b> POUR ÉVITER LES INCENDIES OU LES CHOC ÉLECTRIQUES, NE PAS EXPOSER L'APPAREIL À LA PLUIE OU À L'HUMIDITÉ.</p>  <p>Ce symbole a pour but de vous prévenir de la présence d'instructions importantes relatives au fonctionnement ou à l'entretien (et aux réparations) dans la documentation accompagnant ce produit.</p>

## Mitteilung für CATV-Techniker

Die in dieser Mitteilung aufgeführten Wartungsanweisungen sind ausschließlich für qualifiziertes Fachpersonal bestimmt. Um die Gefahr eines elektrischen Schlags zu reduzieren, sollten Sie keine Wartungsarbeiten durchführen, die nicht ausdrücklich in der Bedienungsanleitung aufgeführt sind, außer Sie sind zur Durchführung solcher Arbeiten qualifiziert.

<p><b>Mitteilung an den Systemtechniker</b></p> <p>Für dieses Gerät muss der Koaxialkabelschutz/ Schirm so nahe wie möglich am Eintrittspunkt des Kabels in das Gebäude geerdet werden. Dieser Erinnerungshinweis liegt den in den USA oder Kanada verkauften Produkten bei. Er soll den Systemtechniker auf Paragraph 820-93 und Paragraph 820-100 der US-Elektrovorschrift NEC (oder der kanadischen Elektrovorschrift Canadian Electrical Code Teil 1) aufmerksam machen, in denen die Richtlinien für die ordnungsgemäße Erdung des Koaxialkabelschirms festgehalten sind.</p>	 <p><b>CAUTION</b> RISK OF ELECTRIC SHOCK DO NOT OPEN</p> <p><b>ACHTUNG</b> STROMSCHLAGGEFAHR, NICHT ÖFFNEN</p>
 <p>Dieses Symbol weist den Benutzer auf das Vorhandensein von nicht isolierten gefährlichen Spannungen im Gerät hin, die Stromschläge verursachen können. Ein Kontakt mit den internen Teilen dieses Produktes ist mit Gefahren verbunden.</p>	<p>ACHTUNG: Zur Vermeidung eines Stromschlags darf die Abdeckung (bzw. die Geräterückwand) nicht entfernt werden. Das Gerät enthält keine vom Benutzer wartbaren Teile. Wartungsarbeiten dürfen nur von qualifiziertem Fachpersonal durchgeführt werden.</p> <p><b>WARNUNG</b> DAS GERÄT NICHT REGEN ODER FEUCHTIGKEIT AUSSETZEN, UM STROMSCHLAG ODER DURCH EINEN KURZSCHLUSS VERURSACHTEN BRAND ZU VERMEIDEN.</p>  <p>Dieses Symbol weist den Benutzer darauf hin, dass die mit diesem Produkt gelieferte Dokumentation wichtige Betriebs- und Wartungsanweisungen für das Gerät enthält.</p>

## Aviso a los instaladores de sistemas CATV

Las instrucciones de reparación contenidas en el presente aviso son para uso exclusivo por parte de personal de mantenimiento cualificado. Con el fin de reducir el riesgo de descarga eléctrica, no realice ninguna otra operación de reparación distinta a las contenidas en las instrucciones de funcionamiento, a menos que posea la cualificación necesaria para hacerlo.

<p><b>Nota para el instalador del sistema</b></p> <p>En lo que se refiere a este aparato, el blindaje del cable coaxial debe conectarse a tierra lo más cerca posible al punto por el cual el cable entra en el edificio. En el caso de los productos vendidos en los EE. UU. y Canadá, el presente aviso se suministra para llamar la atención del instalador del sistema sobre los Artículos 820-93 y 820-100 del NEC (o Código Eléctrico de Canadá, Parte 1), que proporcionan directrices para una correcta conexión a tierra del blindaje del cable coaxial.</p>	 <p><b>CAUTION</b> RISK OF ELECTRIC SHOCK DO NOT OPEN</p> <p><b>ATENCIÓN</b> RIESGO DE DESCARGA ELÉCTRICA NO ABRIR</p>
 <p>Este símbolo tiene como fin advertirle de que una tensión sin aislamiento en el interior de este producto podría ser de una magnitud suficiente como para provocar una descarga eléctrica. Por consiguiente, resulta peligroso realizar cualquier tipo de contacto con alguno de los componentes internos de este producto.</p>	<p>ATENCIÓN: con el fin de reducir el riesgo de descarga eléctrica, no retire la tapa (ni la parte posterior). No existen en el interior componentes que puedan ser reparados por el usuario. Encargue su revisión a personal de mantenimiento cualificado.</p> <p><b>ADVERTENCIA</b> PARA EVITAR EL RIESGO DE INCENDIO O DESCARGA ELÉCTRICA, NO EXPONGA LA UNIDAD A LA LLUVIA O A LA HUMEDAD.</p>  <p>Este símbolo tiene como fin alertarle de la presencia de importantes instrucciones de operación y mantenimiento (revisión) contenidas en la literatura que acompaña al producto.</p>

20080814\_Installer820\_Intl





# Contents

<b>IMPORTANT SAFETY INSTRUCTIONS</b>	<b>v</b>
<b>United States FCC Compliance</b>	<b>x</b>
<b>CE Compliance</b>	<b>xiv</b>
<b>About This Guide</b>	<b>xviii</b>
<b>Chapter 1 Introducing the DOCSIS Cable Modem</b>	<b>1</b>
Introduction.....	2
What's In the Carton?.....	4
Front Panel Description.....	5
Back Panel Description.....	7
<b>Chapter 2 Installing the DOCSIS Cable Modem</b>	<b>9</b>
Installation Preparations.....	10
Install the Cable Modem.....	18
<b>Chapter 3 Operation of Front Panel Indicators</b>	<b>21</b>
Initial Power Up, Calibration, and Registration (AC Power applied).....	22
Normal Operations (AC Power Applied).....	24
Special Conditions.....	25
<b>Chapter 4 Maintaining the Battery</b>	<b>27</b>
Location of the Battery.....	28
Battery Maintenance.....	29
<b>Chapter 5 Troubleshooting the DOCSIS Cable Modem</b>	<b>31</b>
Frequently Asked Questions.....	32
Common Troubleshooting Issues.....	37
Tips for Improved Performance.....	39

## Contents

<b>Chapter 6 Customer Information</b>	<b>41</b>
Customer Support.....	42
<b>Index</b>	<b>45</b>

## IMPORTANT SAFETY INSTRUCTIONS

- 1) Read these instructions.
- 2) Keep these instructions.
- 3) Heed all warnings.
- 4) Follow all instructions.
- 5) Do not use this apparatus near water.
- 6) Clean only with dry cloth.
- 7) Do not block any ventilation openings. Install in accordance with the manufacturer's instructions.
- 8) Do not install near any heat sources such as radiators, heat registers, stoves, or other apparatus (including amplifiers) that produce heat.
- 9) Do not defeat the safety purpose of the polarized or grounding-type plug. A polarized plug has two blades with one wider than the other. A grounding-type plug has two blades and a third grounding prong. The wide blade or the third prong are provided for your safety. If the provided plug does not fit into your outlet, consult an electrician for replacement of the obsolete outlet.
- 10) Protect the power cord from being walked on or pinched particularly at plugs, convenience receptacles, and the point where they exit from the apparatus.
- 11) Only use attachments/accessories specified by the manufacturer.
- 12)  Use only with the cart, stand, tripod, bracket, or table specified by the manufacturer, or sold with the apparatus. When a cart is used, use caution when moving the cart/apparatus combination to avoid injury from tip-over.
- 13) Unplug this apparatus during lightning storms or when unused for long periods of time.
- 14) Refer all servicing to qualified service personnel. Servicing is required when the apparatus has been damaged in any way, such as a power-supply cord or plug is damaged, liquid has been spilled or objects have fallen into the apparatus, the apparatus has been exposed to rain or moisture, does not operate normally, or has been dropped.

### Power Source Warning

A label on this product indicates the correct power source for this product. Operate this product only from an electrical outlet with the voltage and frequency indicated on the product label. If you are uncertain of the type of power supply to your home or business, consult your service provider or your local power company.

The AC inlet on the unit must remain accessible and operable at all times.

### Ground the Product



**WARNING: Avoid electric shock and fire hazard! If this product connects to coaxial cable wiring, be sure the cable system is grounded (earthed). Grounding provides some protection against voltage surges and built-up static charges.**

## IMPORTANT SAFETY INSTRUCTIONS

### Protect the Product from Lightning

In addition to disconnecting the AC power from the wall outlet, disconnect the signal inputs.

### Verify the Power Source from the On/Off Power Light

When the on/off power light is not illuminated, the apparatus may still be connected to the power source. The light may go out when the apparatus is turned off, regardless of whether it is still plugged into an AC power source.

### Eliminate AC Mains Overloads



**WARNING: Avoid electric shock and fire hazard! Do not overload AC mains, outlets, extension cords, or integral convenience receptacles. For products that require battery power or other power sources to operate them, refer to the operating instructions for those products.**

### Handling Disposable Batteries

This product may contain a rechargeable Lithium-Ion battery to provide stand-by operation in the event of an AC power failure.

Heed the following warning, follow the Battery Safety and Battery Disposal instructions below, and see the instructions later in this guide for handling, replacing, and disposing of the battery.



**WARNING: There is danger of explosion if the battery is mishandled or incorrectly replaced. Replace only with the same type of battery. Do not disassemble it or attempt to recharge it outside the system. Do not crush, puncture, dispose of in fire, short the external contacts, or expose to water or other liquids. Dispose of the battery in accordance with local regulations and instructions from your service provider.**

#### Battery Safety

- Insert batteries correctly. There may be a risk of explosion if the batteries are incorrectly inserted.
- Do not attempt to recharge 'disposable' or 'non-reusable' batteries.
- Please follow instructions provided for charging 'rechargeable' batteries.
- Replace batteries with the same or equivalent type that we recommend.
- Do not expose batteries to excessive heat (such as sunlight or fire).
- Do not expose batteries to temperatures above 100°C (212°F).

#### Battery Disposal

- The batteries may contain substances that could be harmful to the environment.
- Recycle or dispose of batteries in accordance with the battery manufacturer's instructions and local/national disposal and recycling regulations.



廢電池請回收

- The batteries may contain perchlorate, a known hazardous substance, so special handling and disposal of this product might be necessary. For more information about perchlorate and best management practices for perchlorate-containing substance, see [www.dtsc.ca.gov/hazardouswaste/perchlorate](http://www.dtsc.ca.gov/hazardouswaste/perchlorate)

### Provide Ventilation and Select a Location

- Remove all packaging material before applying power to the product.
- Do not place this apparatus on a bed, sofa, rug, or similar surface.
- Do not place this apparatus on an unstable surface.
- Do not install this apparatus in an enclosure, such as a bookcase or rack, unless the installation provides proper ventilation.
- Do not place entertainment devices (such as VCRs or DVDs), lamps, books, vases with liquids, or other objects on top of this product.
- Do not block ventilation openings.

### Protect from Exposure to Moisture and Foreign Objects



**WARNING:** Avoid electric shock and fire hazard! Do not expose this product to dripping or splashing liquids, rain, or moisture. Objects filled with liquids, such as vases, should not be placed on this apparatus.



**WARNING:** Avoid electric shock and fire hazard! Unplug this product before cleaning. Do not use a liquid cleaner or an aerosol cleaner. Do not use a magnetic/static cleaning device (dust remover) to clean this product.



**WARNING:** Avoid electric shock and fire hazard! Never push objects through the openings in this product. Foreign objects can cause electrical shorts that can result in electric shock or fire.

### Service Warnings



**WARNING:** Avoid electric shock! Do not open the cover of this product. Opening or removing the cover may expose you to dangerous voltages. If you open the cover, your warranty will be void. This product contains no user-serviceable parts.

### Check Product Safety

Upon completion of any service or repairs to this product, the service technician must perform safety checks to determine that this product is in proper operating condition.

### Protect the Product When Moving It

Always disconnect the power source when moving the apparatus or connecting or disconnecting cables.

### Telephone Equipment Notice

When using your telephone equipment, basic safety precautions should always be followed to reduce the risk of fire, electric shock and injury to persons, including the following:

## IMPORTANT SAFETY INSTRUCTIONS

1. Do not use this product near water, for example, near a bath tub, wash bowl, kitchen sink or laundry tub, in a wet basement or near a swimming pool.
2. Avoid using a telephone (other than a cordless type) during an electrical storm. There may be a remote risk of electric shock from lightning.
3. Do not use the telephone to report a gas leak in the vicinity of the leak.



**CAUTION: To reduce the risk of fire, use only No. 26 AWG or larger telecommunication line cord.**

**SAVE THESE INSTRUCTIONS**

20090915\_Modem with Battery\_Safety

## IMPORTANT SAFETY INSTRUCTIONS

## United States FCC Compliance

This device has been tested and found to comply with the limits for a Class B digital device, pursuant to part 15 of the FCC Rules. These limits are designed to provide reasonable protection against such interference in a residential installation. This equipment generates, uses, and can radiate radio frequency energy. If not installed and used in accordance with the instructions, it may cause harmful interference to radio communications. However, there is no guarantee that interference will not occur in a particular installation. If this equipment does cause harmful interference to radio or television reception, which can be determined by turning the equipment OFF and ON, the user is encouraged to try to correct the interference by one or more of the following measures:

- Reorient or relocate the receiving antenna.
- Increase the separation between the equipment and receiver.
- Connect the equipment into an outlet on a circuit different from that to which the receiver is connected.
- Consult the service provider or an experienced radio/television technician for help.

Any changes or modifications not expressly approved by Cisco Systems, Inc., could void the user's authority to operate the equipment.

The information shown in the FCC Declaration of Conformity paragraph below is a requirement of the FCC and is intended to supply you with information regarding the FCC approval of this device. *The phone numbers listed are for FCC-related questions only and not intended for questions regarding the connection or operation for this device. Please contact your service provider for any questions you may have regarding the operation or installation of this device.*

## Declaration of Conformity

This device complies with Part 15 of FCC Rules. Operation is subject to the following two conditions: 1) the device may not cause harmful interference, and 2) the device must accept any interference received, including interference that may cause undesired operation.

DOCSIS Cable Modem Model(s): DPC3208 EPC3208 Manufactured by: Cisco Systems, Inc. 5030 Sugarloaf Parkway Lawrenceville, Georgia 30044 USA Telephone: 770 236-1077
---

## Canada EMI Regulation

This Class B digital apparatus complies with Canadian ICES-003.

Cet appareil numérique de la class B est conforme à la norme NMB-003 du Canada.

## RF Exposure Statements

**Note:** This transmitter must not be co-located or operated in conjunction with any other antenna or transmitter. This equipment should be installed and operated with a minimum distance of 7.9 inches (20 cm) between the radiator and your body.



## US

This system has been evaluated for RF exposure for humans in reference to ANSI C 95.1 (American National Standards Institute) limits. The evaluation was based in accordance with FCC OET Bulletin 65C rev 01.01 in compliance with Part 2.1091 and Part 15.27. The minimum separation distance from the antenna to general bystander is 7.9 inches (20 cm) to maintain compliance.

## Canada

This system has been evaluated for RF exposure for humans in reference to Canada Health Code 6 (2009) limits. The evaluation was based on evaluation per RSS-102 Rev 4. The minimum separation distance from the antenna to general bystander is 7.9 inches (20 cm) to maintain compliance.

## EU

This system has been evaluated for RF exposure for humans in reference to the ICNIRP (International Commission on Non-Ionizing Radiation Protection) limits. The evaluation was based on the EN 50385 Product Standard to Demonstrate Compliance of Radio Base Stations and Fixed Terminals for Wireless Telecommunications Systems with basic restrictions or reference levels related to Human Exposure to Radio Frequency Electromagnetic Fields from 300 MHz to 40 GHz. The minimum separation distance from the antenna to general bystander is 20 cm (7.9 inches).

## Australia

This system has been evaluated for RF exposure for humans as referenced in the Australian Radiation Protection standard and has been evaluated to the ICNIRP (International Commission on Non-Ionizing Radiation Protection) limits. The minimum separation distance from the antenna to general bystander is 20 cm (7.9 inches).

20100527 FCC DSL\_Dom and Intl





## CE Compliance

### Declaration of Conformity with Regard to the EU Directive 1999/5/EC (R&TTE Directive)

This declaration is only valid for configurations (combinations of software, firmware and hardware) supported or provided by Cisco Systems for use within the EU. The use of software or firmware not supported or provided by Cisco Systems may result in the equipment no longer being compliant with the regulatory requirements.

Български [Bulgarian]:	Това оборудване отговаря на съществените изисквания и приложими клаузи на Директива 1999/5/EC.
Česky [Czech]:	Toto zařízení je v souladu se základními požadavky a ostatními odpovídajícími ustanoveními Směrnice 1999/5/EC.
Dansk [Danish]:	Dette udstyr er i overensstemmelse med de væsentlige krav og andre relevante bestemmelser i Direktiv 1999/5/EF.
Deutsch [German]:	Dieses Gerät entspricht den grundlegenden Anforderungen und den weiteren entsprechenden Vorgaben der Richtlinie 1999/5/EU.
Eesti [Estonian]:	See seade vastab direktiivi 1999/5/EU olulistele nõuetele ja teistele asjakohastele sätetele.
English:	This equipment is in compliance with the essential requirements and other relevant provisions of Directive 1999/5/EC.
Español [Spanish]:	Este equipo cumple con los requisitos esenciales así como con otras disposiciones de la Directiva 1999/5/CE.
Ελληνική [Greek]:	Αυτός ο εξοπλισμός είναι σε συμμόρφωση με τις ουσιαστικές απαιτήσεις και άλλες σχετικές διατάξεις της Οδηγίας 1999/5/EC.
Français [French]:	Cet appareil est conforme aux exigences essentielles et aux autres dispositions pertinentes de la Directive 1999/5/EC.
Íslenska [Icelandic]:	Þetta tæki er samkvæmt grunnkröfum og öðrum viðeigandi ákvæðum Tilskipunar 1999/5/EC.
Italiano [Italian]:	Questo apparato è conforme ai requisiti essenziali ed agli altri principi sanciti dalla Direttiva 1999/5/CE.
Latviski [Latvian]:	Šī iekārta atbilst Direktīvas 1999/5/EK būtiskajām prasībām un citiem ar to saistītajiem noteikumiem.
Lietuvių [Lithuanian]:	Šis įrenginys tenkina 1999/5/EB Direktyvos esminius reikalavimus ir kitas šios direktyvos nuostatas.
Nederlands [Dutch]:	Dit apparaat voldoet aan de essentiële eisen en andere van toepassing zijnde bepalingen van de Richtlijn 1999/5/EC.
Malta [Maltese]:	Dan l-apparat huwa konformi mal-ftigiet essenzjali u l-provedimenti l-oħra rilevanti tad-Direttiva 1999/5/EC.
Magyar [Hungarian]:	Ez a készülék teljesíti az alapvető követelményeket és más 1999/5/EK irányelvben meghatározott vonatkozó rendelkezéseket.
Norsk [Norwegian]:	Dette utstyret er i samsvar med de grunnleggende krav og andre relevante bestemmelser i EU-direktiv 1999/5/EF.
Polski [Polish]:	Urządzenie jest zgodne z ogólnymi wymaganiami oraz szczególnymi warunkami określonymi Dyrektywą UE: 1999/5/EC.
Português [Portuguese]:	Este equipamento está em conformidade com os requisitos essenciais e outras provisões relevantes da Directiva 1999/5/EC.
Română [Romanian]:	Acest echipament este în conformitate cu cerințele esențiale și cu alte prevederi relevante ale Directivei 1999/5/EC.
Slovensko [Slovenian]:	Ta naprava je skladna z bistvenimi zahtevami in ostalimi relevantnimi pogoji Direktive 1999/5/EC.
Slovensky [Slovak]:	Toto zariadenie je v zhode so základnými požiadavkami a inými príslušnými nariadeniami direktív: 1999/5/EC.
Suomi [Finnish]:	Tämä laite täyttää direktiivin 1999/5/EY olennaiset vaatimukset ja on siinä asetettujen muiden laitetta koskevien määräysten mukainen.
Svenska [Swedish]:	Denna utrustning är i överensstämmelse med de väsentliga kraven och andra relevanta bestämmelser i Direktiv 1999/5/EC.

## CE Compliance

**Note:** The full declaration of conformity for this product can be found in the Declarations of Conformity and Regulatory Information section of the appropriate product hardware installation guide, which is available on Cisco.com.

The following standards were applied during the assessment of the product against the requirements of the Directive 1999/5/EC:

- EMC: EN 55022 and EN 55024  
EN 61000-3-2 and EN 61000-3-3
- Safety: EN 60950-1

This product conforms to the following European directives:

 -1999/5/EC

20090724 CE\_Modem/EMTA





# About This Guide

## Introduction

Welcome. This guide provides instructions and recommendations for placing, installing, configuring, operating, maintaining, and troubleshooting the DPC3208 and EPC3208 DOCSIS Cable Modems.

## Purpose

This guide covers the following product models:

- DPC3208 DOCSIS Cable Modem
- EPC3208 DOCSIS Cable Modem

All features described in this guide are standard to these models of cable modems unless otherwise noted. For the purpose of this guide, whenever a feature or option applies to only a specific model, the model number is specified. If a model number is not specified, then the feature or option applies to both of the models.

## Audience

This guide is written for the home subscriber.

## Document Version

This is the first formal release of this document.



# 1

---

## Introducing the DOCSIS Cable Modem

### Introduction

This chapter provides an overview of cable modem features, indicators, and connectors to help you become familiar with the cable modem and the benefits it offers. This chapter also lists the accessories and equipment that are provided with the cable modem so you can verify that you received all of these items.

### In This Chapter

■ Introduction.....	2
■ What's In the Carton?.....	4
■ Front Panel Description .....	5
■ Back Panel Description .....	7

## Introduction

Welcome to the exciting world of high-speed Internet and high-quality digital telephone service. Your new cable modem meets industry standards for high-speed data connectivity along with reliable digital telephone service. The cable modem delivers data, voice and wired (Ethernet) gateway capabilities to connect a variety of devices in the home or small office and support high-speed data access and cost-effective voice services, all in one device. With a cable modem, your Internet enjoyment, home and business communications, and personal productivity will surely soar.

Your new cable modem offers the following outstanding benefits and features:

### High-Speed Data

- Eight (8) bonded downstream channels with data rates eight times traditional EMTAs
- Four (4) bonded upstream channels with data rates four times traditional EMTAs
- Designed to meet DOCSIS/EuroDOCSIS 3.0 specifications as well as backward compatibility with existing DOCSIS/EuroDOCSIS 2.0, 1.1 and 1.0 networks
- DOCSIS/EuroDOCSIS compliant support for IPv6/IPv4
- Expanded tuning range, up to 1002 MHz

### Digital Voice

- Two-line embedded digital voice adapter for wired telephony service
- Toll-quality, high-compression, and high-fidelity (exceeding toll quality) CODEC options

### Connections

- Color-coded connectors and cables for easy installation and setup
- 10/100/1000 Mbps Ethernet port with Auto-negotiate and Auto-MDIX
- Support for up to 64 users

### Design and Function

- Attractive compact design and versatile orientation to stand vertically, lie flat on the desktop or shelf, or mount easily on a wall

- Dual color LED status indicators on the front panel provide an informative and easy-to-understand display that indicates the cable modem operational status
- Rugged electronic components for long-term reliability
- Optional battery powered backup on loss of AC power

## Management

- Software upgradeable by network download
- Remote manageability using SNMP V1/V2 and V3

## Software and Documentation

- CD-ROM containing user guides

## What's In the Carton?

When you receive your cable modem, you should check the equipment and accessories to verify that each item is in the carton and that each item is undamaged. The carton contains the following items:



One DPC3208 or EPC3208 DOCSIS Cable Modem



One AC power adapter with power cord (Image may vary from actual product. May not be provided with all products.)



One Ethernet cable (May not be provided with all products.)



One CD-ROM containing the user guide



One Lithium Ion cartridge battery (May not be provided with all products.)

If any of these items are missing or damaged, please contact your service provider for assistance.

### Notes:

- You need an optional cable signal splitter and additional standard RF coaxial cables if you want to connect a VCR, a Digital Home Communications Terminal (DHCT) or a set-top converter, or a TV to the same cable connection as your cable modem.
- If your product supports telephone service, cables and other equipment needed for telephone service must be purchased separately. Contact your service provider to inquire about the equipment and cables you need for telephone service.

## Front Panel Description

The front panel of your cable modem provides LED status indicators that indicate how well and at what state your cable modem is operating. See *Operation of Front Panel Indicators* (on page 21), for more information on front panel LED status indicator functions.

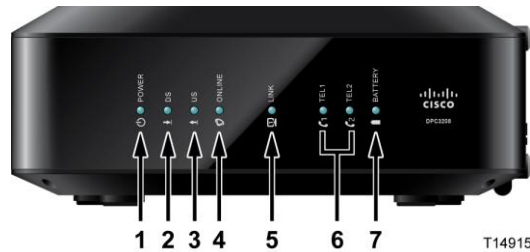

DPC3208 (shown with battery backup capability)

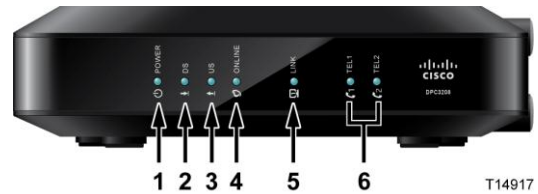

EPC3208 (shown without battery backup capability)

- 1 **POWER**—ON, power is applied to the cable modem
- 2 **DS**—ON, the cable modem is receiving data from the cable network
- 3 **US**—ON, the cable modem is sending data to the cable network
- 4 **ONLINE**—ON, the cable modem is registered on the network and fully operational
- 5 **LINK**—ON, the wireless access point is operational. Blinking indicates that data is being transferred over the wireless connection. OFF indicates that the wireless access point has been disabled by the user
- 6 **TEL1**—ON indicates telephony service is enabled. Blinks when line 1 is in use. OFF indicates that phone service for TEL 1 is not enabled  
**TEL2**—ON indicates telephony service is enabled. Blinks when line 2 is in use. OFF indicates that phone service for TEL 2 is not enabled
- 7 **BATTERY (optional model only)**—ON indicates that the battery is charged. Blinking indicates that the battery charge is low. Off indicates that the unit is operating from battery power, that the battery charge is depleted, or the battery is defective or missing

### Notes:

- After the cable modem is successfully registered on the network, the POWER, DS, US, and ONLINE LEDs illuminate continuously to indicate that the cable modem is active and fully operational.
- The high-speed data operation is disabled when operating on battery power; only the telephone service (if available on this model) is active when operating on battery power.
- LEDs may behave differently when the cable modem is running on battery

## Chapter 1 Introducing the DOCSIS Cable Modem

power (without AC power). Most LEDs are disabled if the unit is operating on battery power. In this mode, the POWER LED blinks to indicate that the unit is operating under battery power.

- The cable modem should only run on battery power when AC power has failed. If the POWER LED indicates that the unit is running on battery power, but the AC power has not failed, verify that the power cord is plugged into a working AC outlet.

## Back Panel Description

The following illustration identifies the back panel components on the DPC3208 and EPC3208 cable modems. Descriptions for each component follow the illustration.

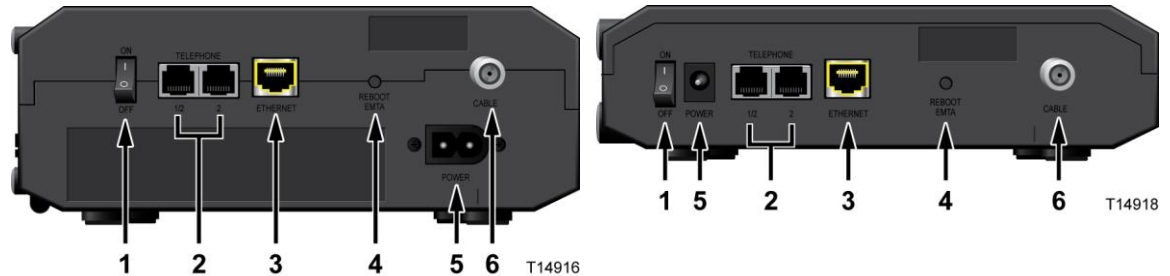

DPC3208 (shown with battery backup capability)

EPC3208 (shown without battery backup capability)

- 1 **ON/OFF SWITCH (Provided only on products that carry the CE mark)** – Allows you to turn off of the cable modem without removing the power cord. Turning the cable modem off using this switch ensures that the unit is consuming no energy.
- 2 **TELEPHONE 1 and 2** – RJ-11 telephone ports connect to home telephone wiring to conventional telephones or fax machines. (Products shipping in North America support lines 1 and 2 on port 1 when used with a two-line phone.)
- 3 **ETHERNET** – Four RJ-45 Ethernet ports connect to the Ethernet port on your PC or your home network
- 4 **RESET** – A momentary pressing (1-2 seconds) of this switch restarts (power cycles) the device. Pressing the switch for more than ten seconds first causes a reset-to-factory-default of all settings.



### CAUTION:

The RESET button is for maintenance purposes only. Do not use unless instructed to do so by your service provider. Doing so may cause you to lose any settings you have selected.

- 5 **POWER** – Connects the cable modem to the AC power adapter that is provided with your cable modem  
**Important:** Use only the power supply provided with your cable modem.
- 6 **CABLE** – F-connector connects to an active cable signal from your service provider





# 2

---

## Installing the DOCSIS Cable Modem

### Introduction

This chapter describes how to properly install the cable modem and to connect the cable modem to a computer and other devices.

### In This Chapter

- Installation Preparations..... 10
- Install the Cable Modem..... 18

## Installation Preparations

Before installing the cable modem make sure that your system meets or exceeds the requirements listed in this section. Also make sure that you have prepared your home and home devices as described in this section.

### What Are the System Requirements for Internet Service?

To ensure that your cable modem operates efficiently for high-speed Internet service, you must have an Internet-capable PC, Mac, or Internet appliance equipped with an Ethernet port. To access the user guide for this product, you must have a CD-ROM drive.

**Note:** You will also need an active cable input line and an Internet connection.

#### Minimum Hardware Requirements for a PC

- A PC with a Pentium MMX 133 or greater processor recommended
- 32 MB of RAM
- CD-ROM drive
- Ethernet port

#### Minimum Hardware Requirements for a Macintosh

- 32 MB of DRAM
- CD-ROM drive
- Ethernet port

#### Minimum Software Requirements for an Ethernet Connection

- Operating system with web browser, TCP/IP protocol

### What Are the Requirements for Telephone Service?

If you intend to use the cable modem for digital telephone service, verify that your home meets or exceeds all of the following requirements.

#### Maximum Number of Telephones

The RJ-11 telephone-style connectors on the cable modem can each provide telephone service to multiple telephones, fax machines, and analog modems.

The maximum number of telephone devices connected to each RJ-11 port is limited by the total Ringing Load of the telephone devices that are connected. Many telephone devices are marked with a Ringer Equivalent Number (REN). Each telephone port on the cable modem can support up to a 5 REN load.

The sum of the REN load on all of the telephone devices attached to each port must not exceed 5 REN.

### Telephone Device Types

You can use telephone devices that are not labeled with a REN number, but the maximum number of attached telephone devices cannot be accurately calculated. With telephone devices that are not labeled, each device should be connected and the ring signal should be tested before adding more devices. If too many telephone devices are attached and the ring signal can no longer be heard, telephone devices should be removed until the ring signal works properly.

Telephones, fax machines, and other telephone devices use the center 2 pins of the RJ-11 connectors to connect to your primary telephone service. The outer 2 pins of the connector may be provisioned to provide a second telephone line. Contact your service provider for more information.

### Dialing Requirements

All your telephones should be set to use Dual-Tone Multi-Frequency (DTMF) dialing. Pulse dialing may not be supported by your local service provider.

### Telephone Wiring Requirements

The cable modem supports connecting to the interior telephone wiring as well as connecting directly to a telephone or fax machine. The maximum distance from the unit to the most distant telephone device must not exceed 1000 feet (300 meters). Use 26-gauge twisted-pair, or larger, telephone wiring.

**Important:** Connection to an existing or a new permanently installed home telephone wiring network should be done by a qualified installer or at the direction of your telephone service provider.

## What Types of Service Accounts Do I Need?

Depending upon the features your service provider offers, you may need to establish one or both of the following accounts:

- A high-speed Internet access account, if your cable modem supports an Internet connection
- An account for telephone service, if your cable modem supports digital telephone service

## Chapter 2 Installing the DOCSIS Cable Modem

Refer to one of the following topics to learn more about the types of service accounts that you may need to establish.

### High-Speed Internet Access Account

If you do *not* have a high-speed Internet access account, your service provider will set up your account and become your Internet Service Provider (ISP). Internet access enables you to send and receive e-mail, access the World Wide Web, and receive other Internet services.

You will need to give your service provider information about the cable modem in order to use the high-speed internet feature that this product offers. Refer to *Information Your Service Provider Needs* (on page 12) to learn how to locate the information your service provider needs to establish a high-speed Internet access account for the cable modem

To establish service, you will need to know the serial number and MAC address of the cable modem in order to use the high-speed internet feature that this product offers. Refer to *Information Your Service Provider Needs* (on page 12) to learn how to locate this information.

### Information Your Service Provider Needs

You will need to give your service provider the following information, which is printed on the bar code label attached to the device:

- The Serial Number (S/N) of the cable modem. The serial number consists of a series of nine digits.
- The CM Media Access Control (CM MAC) address of the cable modem. The CM MAC address consists of a series of 12 hexadecimal characters.

The following illustration shows a typical bar coded label; the image may vary from the label on the actual product.

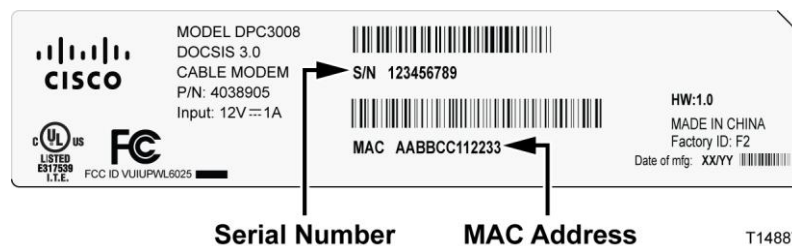

Write down these numbers in the spaces provided:

Serial Number \_\_\_\_\_

CM MAC Address \_\_\_\_\_

### Telephone Service

You will need to establish a telephone account with your local service provider to use your cable modem for telephone service.

When you contact your service provider, you may be able to transfer your existing telephone numbers. If not, then your cable telephony service provider will assign a new telephone number to enable your voice service(s). Discuss these options with your telephony service provider.

## Where Is the Best Location for My Cable Modem?

The ideal location for your cable modem is where it has access to outlets and other devices. Think about the layout of your home or office, and consult with your service provider to select the best location for your cable modem. Read this user guide thoroughly before you decide where to place your cable modem.

Consider these recommendations:

- Choose a location close to your computer if you will also use the cable modem for high-speed Internet service.
- Choose a location that is near an existing RF coaxial connection to eliminate the need for an additional RF coaxial outlet.
- Choose a location so that there is plenty of room to guide the cables away from the cable modem without straining or crimping them.
- Choose a location that allows adequate ventilation around the cable modem.
- Choose a location for the cable modem that is adjacent to your telephone equipment if you plan on connecting your phone directly to the cable modem.

**Note:** If you are using the cable modem to provide service to several telephones, a professional installer can connect the cable modem to your existing home telephone wiring.

## Install the Battery (Optional)

Your cable modem may include one rechargeable Lithium-Ion battery to provide stand-by operation in the event of an AC power failure. We recommend that you install the battery before mounting the cable modem to a wall (if you decide to do so) and before installing the cable modem in your home.

It is possible to use the cable modem without the battery. However, if you choose to operate the cable modem without a battery, you will not have telephone service during a power outage.

For information on battery maintenance, refer to *Maintaining the Battery* (on page 27).

### Installing the Battery

Installing the battery requires no tools. Follow these instructions to install the battery.



**WARNING:**

Fully charged high-capacity rechargeable batteries should be handled with care. Replace only with the battery recommended by the manufacturer. Do not disassemble it or attempt to recharge the battery outside the system. Do not crush, puncture, dispose of in a fire, short the external contacts, or expose to high temperature or immerse in water or other liquids. Dispose of the battery in accordance with local regulations and instructions from your service provider.

- 1 Turn the cable modem so that you are facing the side with the battery compartment.
- 2 Gently release the latch to open the battery cover and gain access to the battery compartment.
- 3 Insert the battery into the battery compartment. Do not force the battery into the compartment, but be sure to press the battery all the way in until it seats fully.

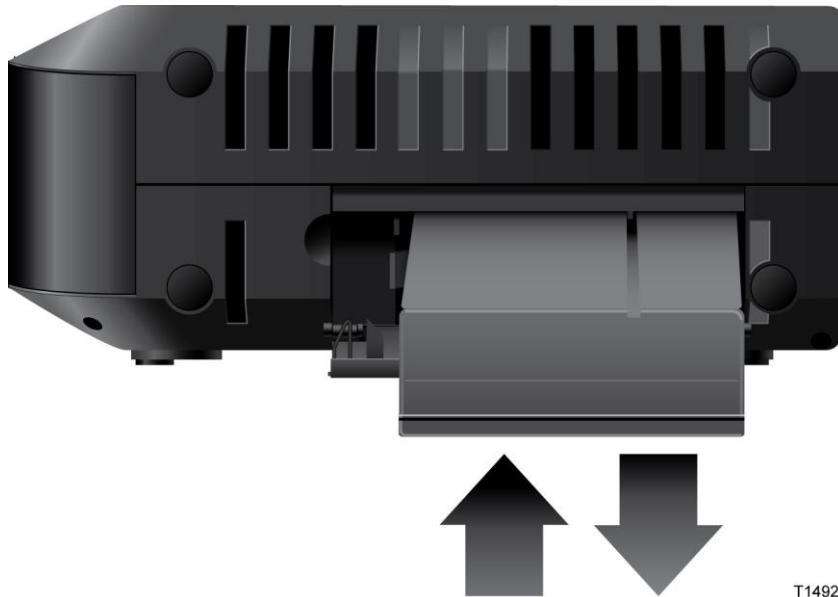

T14920

- 4 Close the battery compartment door.

**Important:** After you install the cable modem and plug it into an AC electrical outlet as described in *Install the Cable Modem* (on page 18), it can take as long as 24 hours for the battery to charge fully. However, you can begin using your high-speed Internet and telephone service immediately after installation. See *Normal Operations (AC Power Applied)* (on page 24) for information on how the LEDs on the front of the cable modem indicate the state of the battery charge.

## How Do I Mount the Cable Modem on a Wall? (Optional)

If you wish, you can mount the cable modem to a wall. This section describes how to mount the cable modem to a wall, and includes a list of equipment you will need along with suggestions for choosing an appropriate place to mount the cable modem.

**Important:** If you have not already done so, insert the battery in the cable modem before you mount the cable modem on a wall (if desired) or before you install the cable modem in your home. For assistance inserting the battery in the cable modem, go to *Install the Battery* (on page 13).

### Select an Appropriate Place to Mount the Cable Modem

You may mount the cable modem to a wall that is made of cement, wood, or drywall. When choosing an appropriate mounting place, refer to the following recommendations:

- Ensure that the mounting location is free of obstructions on all sides, and the cables should be able to easily reach the cable modem without strain.
- Leave sufficient clearance between the bottom of the cable modem and any flooring or shelving underneath to allow access to cabling.
- Allow enough slack in all cables so that the cable modem can be removed for any required maintenance without disconnecting the cables.
- Choose a location that allows adequate ventilation around the cable modem.

### Equipment Needed

Verify that you have the following items that you will need to mount the cable modem:

- Two wall anchors for #8 x 1-inch screws
- Two #8 x 1-inch pan head sheet metal screws
- Drill with a 3/16-in. wood or masonry bit, as appropriate for the wall composition
- A copy of the wall-mounting illustrations shown on the following pages

### Position the Cable Modem

Use the following illustrations to guide you in positioning the cable modem on the wall.

## Chapter 2 Installing the DOCSIS Cable Modem

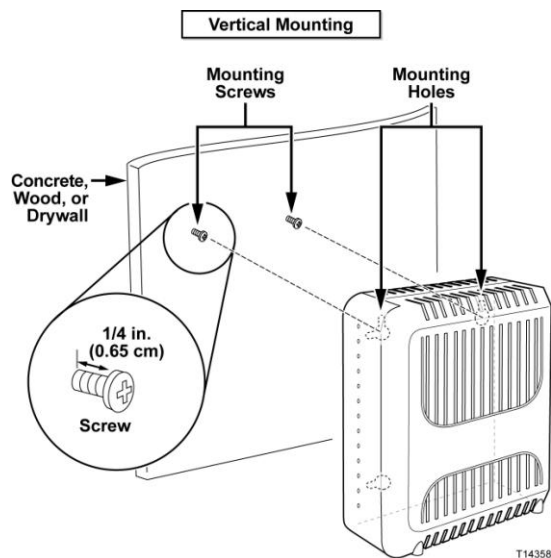
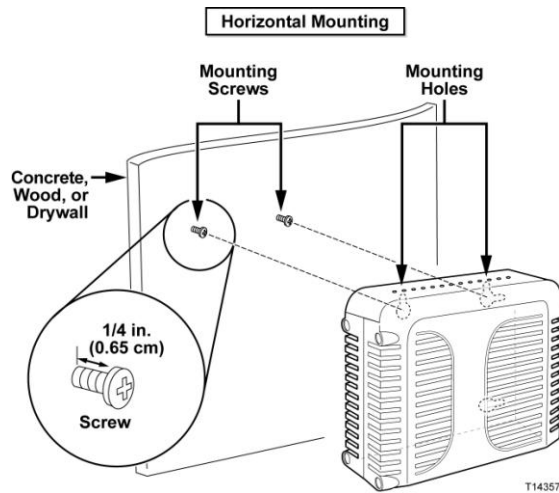

### Location and Dimensions of the Wall-Mounting Slots

The following illustration shows the location and dimensions of the wall-mounting slots on the bottom of the cable modem. Use this illustration as a guide for mounting the cable modem to the wall.



**Note:** Image not to scale.

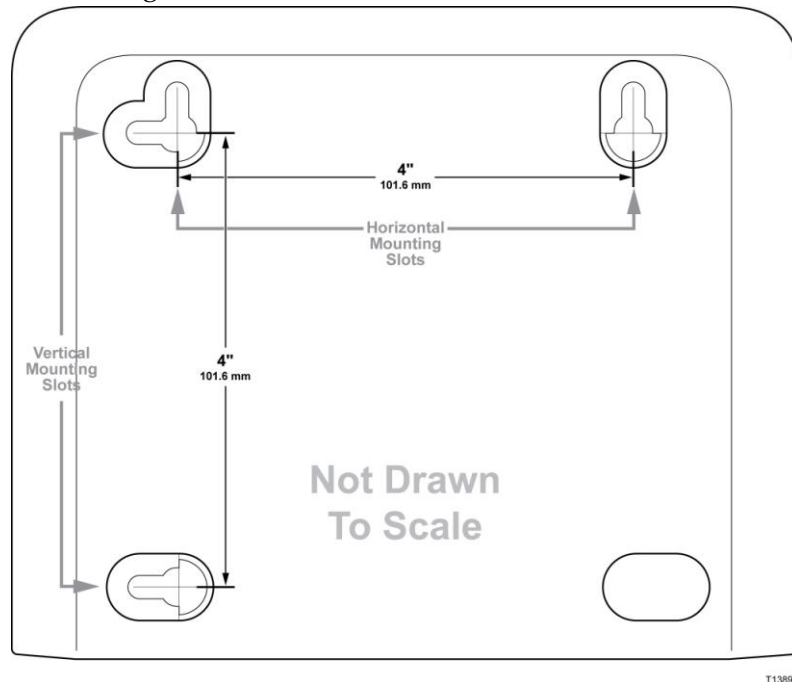

### Mounting the Cable Modem on a Wall

- 1 Using a drill with a 3/16-inch bit, drill two holes at the same height and 4 inches apart.

**Note:** The preceding graphic illustrates the location of the mounting holes on the back of the cable modem.

- 2 Are you mounting the cable modem into a drywall or concrete surface where a wooden stud is available?
  - If **yes**, go to step 3.
  - If **no**, drive the anchor bolts into the wall, and install the mounting screws into the anchor bolts; leave a gap of about 1/4-inch between the screw head and the wall. Then, go to step 4.
- 3 Install the mounting screws into the wall; leave a gap of about 1/4-inch between the screw head and the wall. Then, go to step 4.
- 4 Verify that no cables or wires are connected to the cable modem.
- 5 Lift the cable modem into position. Slip the large end of both mounting slots (located in the back of the cable modem) over the mounting screws, and then slide the cable modem down until the narrow end of the keyhole slot contacts the screw shaft.

**Important:** Verify that the mounting screws securely support the cable modem before you release the unit.

## Install the Cable Modem

This section describes how to connect your cable modem to support the services that the cable modem offers.

### Connect Devices to the Cable Modem

The following illustration shows all of the possible connections that can be made to your cable modem for various services. Although your model may not support all of the services pictured, you can determine which services your model supports by referring to the Benefits and Features list in *Introduction* (on page 2).

**Note:** Professional installation may be available. Contact your local service provider for further assistance.

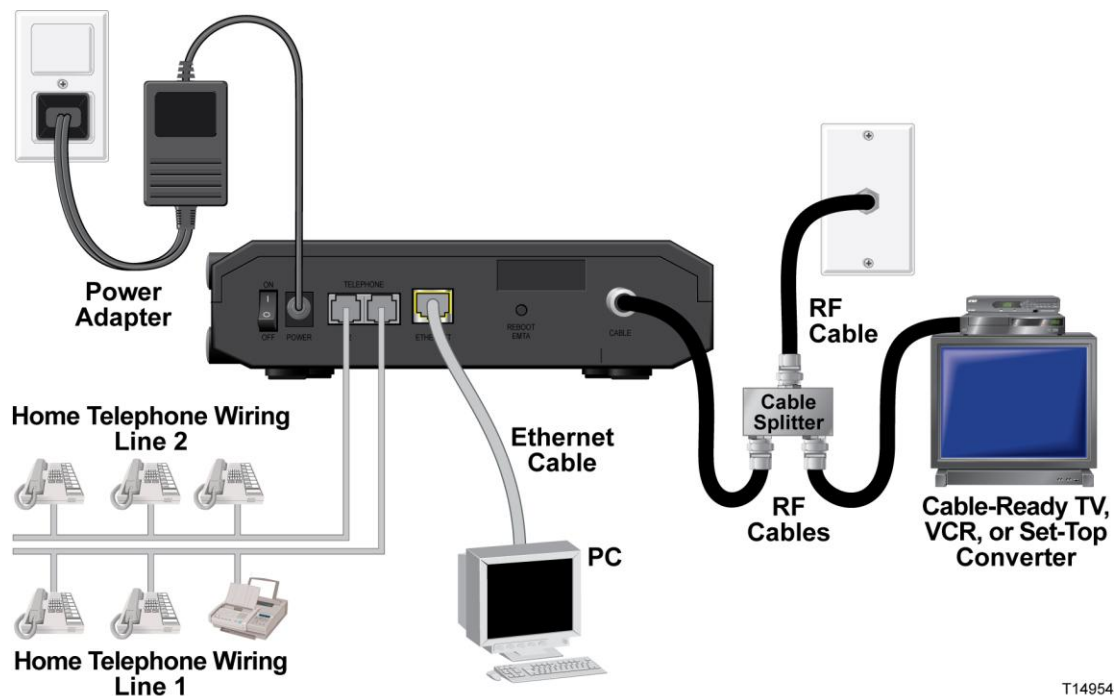

T14954

### Connect the Cable Modem

The following installation procedure ensures proper setup and configuration for the cable modem.

- 1 Choose an appropriate and safe location to install the cable modem (close to a power source, an active cable connection, your PC – if using high-speed Internet, and your telephone lines – if using VoIP). For assistance, go to *Where Is the Best Location for My Cable Modem?* (on page 13).

**WARNING:**

- To prevent possible damage to equipment, disconnect any other telephone service before connecting your cable modem to the same wires.
- Hazardous electrical voltages can exist on the telephone, Ethernet, or coax cable wiring. Be sure to disconnect AC power from all devices while installing your service.
- All wiring and connections must be properly insulated to prevent electrical shock.
- Telephone connections to an installed home telephone wiring network should be done by a qualified installer. The cable telephone service provider may offer professional installation and connection to the home telephone wiring network. A fee may be charged for this service.

2 Power off your PC and other networking device; then, unplug them from the power source.

3 Connect the active RF coaxial cable from your service provider to the coax connector labeled **CABLE** on the back of the cable modem.

**Note:** To connect a TV, DHCT, set-top, or VCR from the same cable connection, you will need to install a cable signal splitter (not included). Always check with your service provider before using a splitter as a splitter may degrade the signal.

4 Connect your PC to the cable modem by connecting one end of the yellow Ethernet cable to the Ethernet port on your PC, and the other end to the yellow **ETHERNET** port on the back of the cable modem.

**Note:** To install more than one Ethernet device on a cable modem that has only one Ethernet port, use an external multi-port Ethernet switch(s) or cable router (not provided).

5 If your cable modem supports digital telephone service (VoIP), connect one end of a telephone jumper cable (not included) to a telephone outlet in your home or to a telephone or fax machine. Then connect the other end of the jumper cable to the appropriate RJ-11 **TELEPHONE** port on the back of the cable modem. The telephone ports are light gray and are labeled 1/2 and 2 or 1 and 2 depending on the region of the world the cable modem is used.

**Notes:**

- Make sure to connect your telephone service to the correct RJ-11 port. For single line telephone service, connect to port 1/2 or 1.
- In North America, cable modems have multi-line capability on the RJ-11 telephone port labeled 1/2. Line 1 is on pins 3 and 4 of port 1/2, and Line 2 is supported on pins 2 and 5. In Europe, cable modems support only one line per port. Line 1 is on port 1 and line 2 is on port 2.
- Telephones that require electrical connectors other than RJ-11 may require an external adapter (sold separately).

## Chapter 2 Installing the DOCSIS Cable Modem

- 6 Locate the AC power adapter provided with your cable modem. Connect the barrel connector end of the power adapter into the power input on the back of the cable modem. Then, plug the AC power adapter into an AC outlet to power-up the cable modem.

**Note:** If your Cable Modem is equipped with a power switch (located on the back panel), make sure that the switch is in the ON position to power-up the Cable Modem.

The cable modem will perform an automatic search to locate and sign on to the broadband data network. This process may take up to 2-5 minutes. The cable modem will be ready for use when the **POWER**, **DS**, **US** and **ONLINE** LEDs on the front panel of the cable modem stop blinking and remain on continuously.

- 7 Plug in and power on your PC and other home network devices. The **LINK** LED on the cable modem should be on or blinking.
- 8 At this point, the installation is complete, and you can begin surfing the Internet.

**Note:** If your PC does not have Internet access, refer to *How Do I Configure TCP/IP Protocol?* (on page 32) for information on how to configure your PC for TCP/IP. For Internet devices other than PCs, refer to the DHCP or IP Address configuration section of the User Guide or Operations Manual for those devices.

# 3

---

## Operation of Front Panel Indicators

### Introduction

This section describes the behavior of the front panel indicators when the cable modem is first powered up, during normal operations, and in special conditions.

### In This Chapter

- Initial Power Up, Calibration, and Registration (AC Power applied) ..... 22
- Normal Operations (AC Power Applied) ..... 24
- Special Conditions ..... 25

## Initial Power Up, Calibration, and Registration (AC Power applied)

The following chart illustrates the sequence of steps and the corresponding appearance of the cable modem front panel LED status indicators during power up, calibration, and registration on the network when AC power is applied to the cable modem. Use this chart to troubleshoot the power up, calibration, and registration process of your cable modem.

**Note:** After the cable modem completes Step 7 (Data Network Registration Complete), the cable modem proceeds immediately to Normal Operations. See *Normal Operations (AC Power applied)* (on page 24).

Front Panel LED Status Indicators During Initial Power Up, Calibration, and Registration							
Part 1, High Speed Data Registration							
Step:	1	2	3	4	5	6	
Front Panel Indicator	Self Test	Downstream Scan	Downstream Signal Lock	Ranging	Requesting IP Address	Request High Speed Data Provisioning File	
1	POWER	On	On	On	On	On	On
2	DS	On	Blinking	On	On	On	On
3	US	On	Off	Off	Blinking	On	On
4	ONLINE	On	Off	Off	Off	Off	Blinking
5	LINK	Off	On or Blinking	On or Blinking	On or Blinking	On or Blinking	On or Blinking
6	TEL 1	On	Off	Off	Off	Off	Off
7	TEL 2	On	Off	Off	Off	Off	Off
8	BATTERY	<ul style="list-style-type: none"> <li>■ On - When battery is charged</li> <li>■ Blinks - When battery charge is low</li> <li>■ Off - When there is no battery in the unit</li> </ul>					

Front Panel LED Status Indicators During Initial Power Up, Calibration, and Registration						
Part 2, Telephone Registration						
Step:	7	8	9	10	11	
Front Panel Indicator	Data Network Registration Complete	Requesting Telephone IP Address	Request Telephone Provisioning File	Restarting Voice Service	Telephone Registration Complete	
1	POWER	On	On	On	On	On
2	DS	On	On	On	On	On
3	US	On	On	On	On	On
4	ONLINE	On	On	On	On	On

**Initial Power Up, Calibration, and Registration (AC Power applied)**

5	LINK	On or Blinking	On or Blinking	On or Blinking	On or Blinking	On or Blinking
6	TEL 1	Off	Blinking	Off	Blinking	On
7	TEL 2	Off	Off	Blinking	Blinking	On
8	BATTERY	<ul style="list-style-type: none"> <li>■ On - When battery is charged</li> <li>■ Blinks - When battery charge is low</li> <li>■ Off - When there is no battery in the unit</li> </ul>				

## Normal Operations (AC Power Applied)

The following chart illustrates the appearance of the cable modem front panel LED status indicators during normal operations when AC power is applied to the gateway.

Front Panel LED Status Indicators During Normal Conditions		
Front Panel Indicator	Normal Operations	
1	POWER	On
2	DS	On
3	US	On
4	ONLINE	On
5	LINK	<ul style="list-style-type: none"> <li>■ On - When the wireless access point is enabled and operational</li> <li>■ Blinks - When data is being transferred between the CPE and the wireless home gateway</li> <li>■ Off - When the wireless access point is disabled by the user</li> </ul>
6	TEL 1	<ul style="list-style-type: none"> <li>■ On - When telephony service is enabled</li> <li>■ Blinks - When line 1 is in use</li> </ul>
7	TEL 2	<ul style="list-style-type: none"> <li>■ On - When telephony service is enabled</li> <li>■ Blinks - When line 2 is in use</li> </ul>
8	BATTERY	<ul style="list-style-type: none"> <li>■ On - When battery is charged</li> <li>■ Blinks - When battery charge is low</li> <li>■ Off - When there is no battery in the unit</li> </ul>

**Note:** In addition to the status shown in the previous table, some service providers use color-coded LEDs to indicate detailed channel bonding and data link status. For additional information about color-coded LEDs, check with your service provider.



## Special Conditions

The following chart describes the appearance of the cable modem front panel LED status indicators during special conditions to show when you have been denied network access.

Front Panel LED Status Indicators During Special Conditions		
Front Panel Indicator		Network Access Denied
1	POWER	Slow Blinking (once per second)
2	DS	Slow Blinking (once per second)
3	US	Slow Blinking (once per second)
4	ONLINE	Slow Blinking (once per second)
5	LINK	On
6	TEL 1	Off
7	TEL 2	Off
8	BATTERY	On



# 4

---

## Maintaining the Battery

### Introduction

This chapter describes how to maintain and replace the battery that is included with the cable modem.

### In This Chapter

- Location of the Battery ..... 28
- Battery Maintenance..... 29

## Location of the Battery

The following illustration shows the location of the battery.

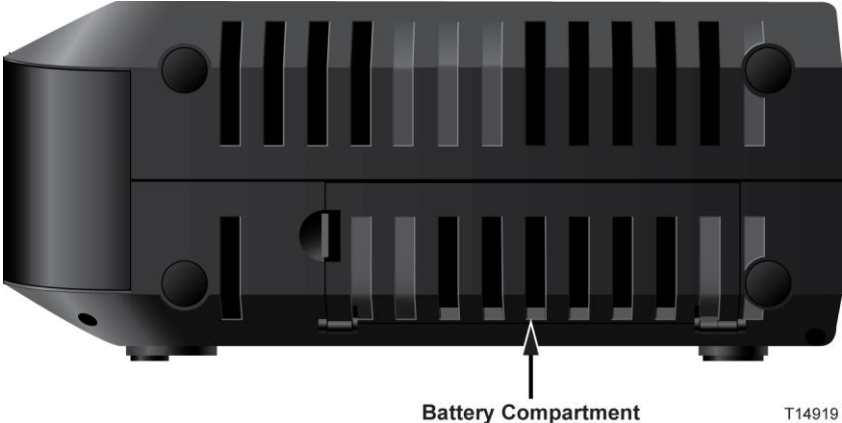

## Battery Maintenance

If your cable modem contains a battery backup feature, a Lithium-Ion battery provides stand-by operation in the event of an AC power failure. You can replace the battery without the use of any tools.

**WARNING:**

Fully charged high-capacity rechargeable batteries should be handled with care. Replace only with the battery recommended by the manufacturer. Do not disassemble it or attempt to recharge the battery outside the system. Do not crush, puncture, dispose of in a fire, short the external contacts, or expose to high temperature or immerse in water or other liquids. Dispose of the battery in accordance with local regulations and instructions from your service provider.

### Charging the Battery

The battery begins to charge automatically as soon as you attach the cable modem to the AC electrical outlet. When you first plug in the cable modem, the **POWER LED** status indicator illuminates.

**Important:** It may take as long as 24 hours for the battery to charge fully.

### Removing and Replacing the Battery

Under normal circumstances, the battery should last for several years. The **BATTERY LED** status indicator turns off to indicate that the battery should be replaced soon. Contact your service provider to obtain replacement batteries and for disposal instructions.

Follow these steps to remove and replace the battery. You can remove and replace the battery without disconnecting the AC power source.

- 1 Turn the cable modem so that you are facing the side with the battery compartment.
- 2 Gently release the latch to open the battery cover and gain access to the battery compartment.
- 3 Grasp the plastic strip on the front of the battery and gently slide the battery forward to remove it from the battery compartment.

## Chapter 4 Maintaining the Battery

- 4 Insert a new battery into the battery compartment. Do not force the battery into the compartment, but be sure to press the battery all the way in until it seats fully.

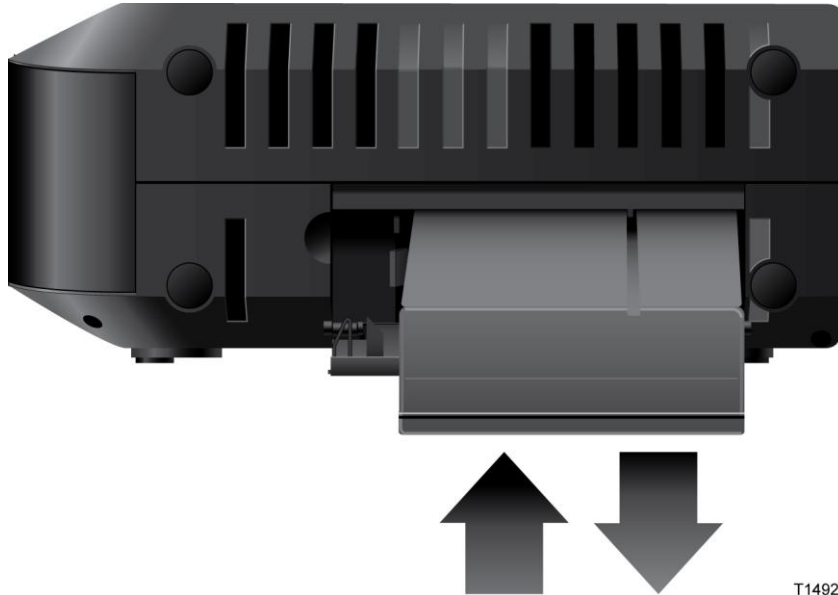

T14920

- 5 Close the battery compartment door. The battery lock will automatically re-engage.

**Important:** Dispose of the battery in accordance with local regulations and instructions from your service provider.

### Using the Cable Modem Without a Battery

If you want, you can use the cable modem without a battery. If you need to remove the battery, follow the procedures found in *Removing and Replacing the Battery* (on page 29).

**Important:** If you choose to operate your cable modem without a battery, you risk losing your telephone service during a power outage.

# 5

---

## Troubleshooting the DOCSIS Cable Modem

### Introduction

This chapter describes the most common issues that may occur after the cable modem is installed and provides possible solutions and tips for improved performance of the cable modem.

### In This Chapter

- Frequently Asked Questions ..... 32
- Common Troubleshooting Issues ..... 37
- Tips for Improved Performance ..... 39

## Frequently Asked Questions

This section provides answers to common questions about the cable modem.

### How Do I Configure TCP/IP Protocol?

To configure TCP/IP protocol, you need to have an Ethernet Network Interface Card (NIC) with TCP/IP communications protocol installed on your system. TCP/IP is a communications protocol used to access the Internet. This section contains instructions for configuring TCP/IP on your Internet devices to operate with the cable modem in Microsoft Windows or Macintosh environments.

TCP/IP protocol in a Microsoft Windows environment is different for each operating system. Follow the appropriate instructions in this section for your operating system.

#### Configuring TCP/IP on Windows 2000 Systems

- 1 Click **Start**, select **Settings**, and choose **Network and Dial-up Connections**.
- 2 Double-click the **Local Area Connection** icon in the Network and Dial-up Connections window.
- 3 Click **Properties** in the Local Area Connection Status window.
- 4 Click **Internet Protocol (TCP/IP)** in the Local Area Connection Properties window, and then click **Properties**.
- 5 Select both **Obtain an IP address automatically** and **Obtain DNS server address automatically** in the Internet Protocol (TCP/IP) Properties window, and then click **OK**.
- 6 Click **Yes** to restart your computer when the Local Network window opens. The computer restarts. The TCP/IP protocol is now configured on your PC, and your Ethernet devices are ready for use.
- 7 Try to access the Internet. If you cannot access the Internet, contact your service provider for further assistance.

#### Configuring TCP/IP on Windows XP Systems

- 1 Click **Start**, and depending on your Start menu setup, choose one of the following options:
  - If you are using the Windows XP Default Start Menu, select **Connect to**, choose **Show all connections**, and then go to step 2.
  - If you are using the Windows XP Classic Start Menu, select **Settings**, choose **Network Connections**, click **Local Area Connection**, and then go to step 3.
- 2 Double-click the **Local Area Connection** icon in the LAN or High-Speed Internet section of the Network Connections window.
- 3 Click **Properties** in the Local Area Connection Status window.



- 4 Click **Internet Protocol (TCP/IP)**, and then click **Properties** in the Local Area Connection Properties window.
- 5 Select both **Obtain an IP address automatically** and **Obtain DNS server address automatically** in the Internet Protocol (TCP/IP) Properties window, and then click **OK**.
- 6 Click **Yes** to restart your computer when the Local Network window opens. The computer restarts. The TCP/IP protocol is now configured on your PC, and your Ethernet devices are ready for use.
- 7 Try to access the Internet. If you cannot access the Internet, contact your service provider for further assistance.

#### Configuring TCP/IP on Macintosh Systems

- 1 Click the **Apple** icon in the upper-left corner of the Finder. Scroll down to **Control Panels**, and then click **TCP/IP**.
- 2 Click **Edit** on the Finder at the top of the screen. Scroll down to the bottom of the menu, and then click **User Mode**.
- 3 Click **Advanced** in the User Mode window, and then click **OK**.
- 4 Click the Up/Down selector arrows located to the right of the Connect Via section of the TCP/IP window, and then click **Using DHCP Server**.
- 5 Click **Options** in the TCP/IP window, and then click **Active** in the TCP/IP Options window.  
**Note:** Make sure that the **Load only when needed option** is *unchecked*.
- 6 Verify that the **Use 802.3** option located in the upper-right corner of the TCP/IP window is unchecked. If there is a check mark in the option, uncheck the option, and then click **Info** in the lower-left corner.
- 7 Is there a Hardware Address listed in this window?
  - If **yes**, click **OK**. To close the TCP/IP Control Panel window, click **File**, and then scroll down to click **Close**. You have completed this procedure.
  - If **no**, you must power off your Macintosh.
- 8 With the power off, simultaneously press and hold down the **Command (Apple)**, **Option, P**, and **R** keys on your keyboard. Keeping those keys pressed down, power on your Macintosh but do not release these keys until you hear the Apple chime at least three times, then release the keys and let the computer restart.
- 9 When your computer fully reboots, repeat steps 1 through 7 to verify that all TCP/IP settings are correct. If your computer still does not have a Hardware Address, contact your authorized Apple dealer or Apple technical support center for further assistance.

## How Do I Renew the IP Address on My PC?

If your PC cannot access the Internet after the cable modem is online, it is possible that your PC did not renew its IP address. Follow the appropriate instructions in this section for your operating system to renew the IP address on your PC.

### Renewing the IP Address on Windows 7 Systems

- 1 Click the Windows **Start** button.
- 2 Type **cmd** in the Search box. The cmd window opens.
- 3 Type **ipconfig/renew** and press **Enter** to renew the IP address of the computer.

### Renewing the IP Address on Windows XP Systems

- 1 Click **Start**, and then click **Run**. The Run window opens.
- 2 Type **cmd** in the Open field and click **OK**. A window with a command prompt opens.
- 3 Type **ipconfig/release** at the C:/ prompt and press **Enter**. The system releases the IP address.
- 4 Type **ipconfig/renew** at the C:/ prompt and press **Enter**. The system displays a new IP address.
- 5 Click the **X** in the upper-right corner of the window to close the Command Prompt window. You have completed this procedure.

**Note:** If you cannot access the Internet, contact your service provider for further assistance.

### Renewing the IP Address on Macintosh Systems

- 1 Close all open programs.
- 2 Open your **Preferences** folder.
- 3 Drag the **tcp/ip preferences** file to the Trash.
- 4 Close all open windows and empty the Trash.
- 5 Restart your computer.
- 6 As your computer starts, simultaneously press and hold down the **Command (Apple)**, **Option**, **P**, and **R** keys on your keyboard. Keeping those keys pressed down, power on your Macintosh but do not release these keys until you hear the Apple chime at least three times; then, release the keys and let the computer restart.
- 7 When your computer fully reboots, click the **Apple** icon in the upper-left corner of the Finder. Scroll down to **Control Panels**, and then click **TCP/IP**.
- 8 Click **Edit** on the Finder at the top of the screen. Scroll down to the bottom of the menu, and then click **User Mode**.
- 9 Click **Advanced** in the User Mode window, and then click **OK**.
- 10 Click the Up/Down selector arrows located to the right of the Connect Via section of the TCP/IP window, and then click **Using DHCP Server**.

- 11 Click **Options** in the TCP/IP window, and then click **Active** in the TCP/IP Options window.  
**Note:** In some cases, the **Load only when needed** option does not appear. If it appears, select the option. A check mark appears in the option.
- 12 Verify that the **Use 802.3** option located in the upper-right corner of the TCP/IP window is not selected. If there is a check mark in the option, select the option to clear the check mark, and then click **Info** in the lower-left corner.
- 13 Is there a Hardware Address listed in this window?
  - If **yes**, click **OK**. To close the TCP/IP Control Panel window, click **File**, and then scroll down to click **Close**.
  - If **no**, repeat these instructions from step 6.
- 14 Reboot your computer.

## What if I Don't Subscribe to Cable TV?

If cable TV is available in your area, data service may be made available with or without subscribing to cable TV service. Contact your local service provider for complete information on cable services, including high-speed Internet access.

## How Do I Arrange for Installation?

Call your service provider to inquire about professional installation. A professional installation ensures proper cable connection to the cable modem and to your PC, and it ensures the proper configuration of all hardware and software settings. Contact your service provider for more information about installation.

## How Does the Cable Modem Connect to My Computer?

The cable modem connects to the Ethernet port on your PC. For best performance, your PC should be equipped with a Gigabit Ethernet port.

## After My Cable Modem Is Connected, How Do I Access the Internet?

Your local service provider becomes your Internet Service Provider (ISP). They offer a wide range of services including e-mail, chat, news, and information services. Your service provider will provide the software you will need.

## Can I Watch TV and Surf the Internet at the Same Time?

Absolutely! If you subscribe to cable television service, you can watch TV and use your cable modem at the same time by connecting your TV and your cable modem to the cable network using an optional cable signal splitter.

## Can I Use my Existing Phone Number with the Cable Modem?

Telephone numbers are portable in some areas. Contact your telephone service provider for more information about using an existing telephone number.

## How Many Telephones Can I Connect?

The RJ-11 telephone-style connectors on the cable modem can each provide telephone service to multiple telephones, fax machines, and analog modems. The maximum number of telephone devices connected to each RJ-11 port is limited by the total Ringing Load of the telephone devices that are connected. Many telephone devices are marked with a Ringer Equivalent Number (REN). Each telephone port on the cable modem can support up to a 5 REN load. The sum of the REN load on all of the telephone devices attached to each port must not exceed 5 REN.

## Common Troubleshooting Issues

This section describes common problems and offers solutions.

### I don't understand the front panel status indicators

See *Operation of Front Panel Indicators* (on page 21), for more detailed information on front panel LED status indicator operation and function.

### The Cable Modem does not register an Ethernet connection

Try one of the following solutions:

- Verify that your computer has an Ethernet card and that the Ethernet driver software is properly installed. If you purchase and install an Ethernet card, follow the installation instructions very carefully.
- Verify the status of the front panel status indicator lights.

### The Cable Modem does not register an Ethernet connection after connecting to a hub

If you are connecting multiple PCs to the cable modem, you should first connect the cable modem to the uplink port of the hub using the correct crossover cable. The LINK LED of the hub will illuminate continuously.

### The Cable Modem does not register a cable connection

The cable modem works with a standard, 75-ohm, RF coaxial cable. If you are using a different cable, your cable modem will not function properly. Contact your service provider to determine whether you are using the correct cable.

### There is no dial tone when I lift the handset

Try the following solutions if you cannot hear a dial tone:

- Your telephone wiring may be connected to the wrong RJ-11 port on the cable modem. The cable modem has two telephone ports. Verify that you are connected to the correct telephone port.
- There may be a problem with your telephone set. Use a different telephone set and listen to hear dial tone.
- There may be a problem with your home telephone wiring. Use a telephone and connect directly to the same RJ-11 port on the back of the unit. If the dial tone is

## Chapter 5 Troubleshooting the DOCSIS Cable Modem

working here but does not work at other locations in the home, a professional may need to diagnose and repair a problem with your telephone wiring.

- Verify that the telephone company has removed the previous telephone service from your home telephone wiring.
- Your telephone service may not be enabled from your cable telephony service provider. Contact your cable telephony service provider for more information.

## Tips for Improved Performance

If your cable modem does not perform as expected, the following tips may help. If you need further assistance, contact your service provider.

- Verify that the plug to your cable modem AC power is properly inserted into an electrical outlet.
- Verify that your cable modem AC power cord is not plugged into an electrical outlet that is controlled by a wall switch. If a wall switch controls the electrical outlet, make sure the switch is in the **ON** position.
- Verify that the **ONLINE** LED status indicator on the front panel of your cable modem is illuminated.
- Verify that your cable service is active and that it supports two-way service.
- Verify that all cables are properly connected, and that you are using the correct cables.
- If you are using the Ethernet connection, verify that your TCP/IP is properly installed and configured.
- Verify that you have called your service provider and given them the serial number and MAC address of your cable modem.
- If you are using a cable signal splitter so that you can connect the cable modem to other devices, remove the splitter and reconnect the cables so that the cable modem is connected directly to the cable input. If the cable modem now functions properly, the cable signal splitter may be defective and may need to be replaced.
- If you are connected to your PC with an Ethernet connection, your PC should be equipped with a Gigabit Ethernet card for best performance.





# 6

---

## Customer Information

### Introduction

This chapter provides contact information to obtain product support.

### In This Chapter

- Customer Support ..... 42

## Customer Support

### If You Have Questions

If you have questions about this product, contact the representative who handles your account for information.

If you have technical questions, telephone your nearest technical support office at one of the following telephone numbers.

---

#### The Americas

United States	Cisco® Services Atlanta, Georgia	<b>Technical Support</b> <ul style="list-style-type: none"> <li>■ For <i>Digital Broadband Delivery System</i> products only, call:           <ul style="list-style-type: none"> <li>– Toll-free: 866 787-3866</li> <li>– Local: 770 236-2200</li> <li>– Fax: 770 236-2488</li> </ul> </li> <li>■ For all products <i>other than</i> Digital Broadband Delivery System, call:           <ul style="list-style-type: none"> <li>– Toll-free: 800 722-2009</li> <li>– Local: 678 277-1120</li> <li>– Fax: 770 236-2306</li> </ul> </li> </ul> <b>Customer Service</b> <ul style="list-style-type: none"> <li>■ Toll-free: 800 722-2009</li> <li>■ Local: 678 277-1120</li> <li>■ Fax: 770 236-5477</li> </ul>
---------------	-------------------------------------	---

---

#### The United Kingdom and Europe

Europe	European Technical Assistance Center (EuTAC), Belgium	<b>Product Information</b> <ul style="list-style-type: none"> <li>■ Telephone: 32 56 445 444</li> </ul> <b>Technical Support</b> <ul style="list-style-type: none"> <li>■ Telephone: 32 56 445 197 or 32 56 445 155</li> <li>■ Fax: 32 56 445 061</li> </ul>
--------	---	--

---

#### Asia-Pacific

China	Hong Kong	<b>Technical Support</b> <p>Telephone: 011 852 2588 4745</p> <p>Fax: 011 852 2588 3139</p>
-------	-----------	--

---

**Australia**

---

Australia	Sydney	<b>Technical Support</b>
		Telephone: 011 61 2 8446 5394
		Fax: 011 61 2 8446 8015

---

**Japan**

---

Japan	Tokyo	<b>Technical Support</b>
		Telephone: 011 81 3 5322 2067
		Fax: 011 81 3 5322 1311

---



# Index

## A

accessing the Internet • 35  
accessories • 4

## B

battery  
  charging • 29  
  disposal • vi  
  location of • 28  
  maintaining • 27, 29  
  operation without • 30  
  removal and replacement • 29  
  safe handling of • vi

## C

cable service • 35  
connections  
  description of • 7  
  how to connect • 18  
  to computer • 35

## E

Ethernet • 10, 37  
exposure to moisture • vii

## F

features, product • 4

## I

indicators  
  behavior • 22, 24, 25  
  described • 5  
  operation of • 21  
installation  
  professional • 35  
installation requirements  
  for Ethernet connection • 10  
  for telephone service • 10  
  minimum system requirements • 10  
  ventilation • vii  
Internet

  how to access • 35  
  surfing while watching TV • 35  
  unable to access • 34  
IP address, renewing • 34

## L

LEDs • 5, 22, 24, 25  
location  
  selecting • vii, 13

## O

overview  
  power switch • 7  
  product • 2

## P

performance, tips to improve • 39  
product  
  accessories • 4  
  features • 2  
  overview • 2

## S

safety instructions • v  
  battery handling • vi  
  ground product • v  
  telephone equipment • vii  
system requirements • 10

## T

TCP/IP  
  configuring for Macintosh systems • 33  
  configuring for Windows 2000 • 32  
  configuring for Windows XP • 32  
telephone  
  equipment • vii  
  requirements • 10  
  service • 36, 37  
troubleshooting • 31

## U

unpacking • 4

Index

USB • 4, 35

## **V**

ventilation requirements • vii

Voice settings

LEDs • 5, 22, 24, 25

## **W**

wall mounting

instructions • 17

slots • 16





Cisco Systems, Inc.  
5030 Sugarloaf Parkway, Box 465447  
Lawrenceville, GA 30042

678 277-1120  
800 722-2009  
[www.cisco.com](http://www.cisco.com)

This document includes various trademarks of Cisco Systems, Inc. Please see the Notices section of this document for a list of the Cisco Systems, Inc. trademarks used in this document.

Product and service availability are subject to change without notice.

© 2011 Cisco and/or its affiliates. All rights reserved.

February 2011 Printed in United States of America

Part Number 4027620 Rev A



## Free Manuals Download Website

<http://myh66.com>

<http://usermanuals.us>

<http://www.somanuals.com>

<http://www.4manuals.cc>

<http://www.manual-lib.com>

<http://www.404manual.com>

<http://www.luxmanual.com>

<http://aubethermostatmanual.com>

Golf course search by state

<http://golfingnear.com>

Email search by domain

<http://emailbydomain.com>

Auto manuals search

<http://auto.somanuals.com>

TV manuals search

<http://tv.somanuals.com>