



## **Cisco Broadband Access Center 3.8 Administrator Guide**

April 02, 2013

### **Americas Headquarters**

Cisco Systems, Inc.  
170 West Tasman Drive  
San Jose, CA 95134-1706  
USA  
<http://www.cisco.com>  
Tel: 408 526-4000  
800 553-NETS (6387)  
Fax: 408 527-0883

Text Part Number: OL-27172-01

THE SPECIFICATIONS AND INFORMATION REGARDING THE PRODUCTS IN THIS MANUAL ARE SUBJECT TO CHANGE WITHOUT NOTICE. ALL STATEMENTS, INFORMATION, AND RECOMMENDATIONS IN THIS MANUAL ARE BELIEVED TO BE ACCURATE BUT ARE PRESENTED WITHOUT WARRANTY OF ANY KIND, EXPRESS OR IMPLIED. USERS MUST TAKE FULL RESPONSIBILITY FOR THEIR APPLICATION OF ANY PRODUCTS.

THE SOFTWARE LICENSE AND LIMITED WARRANTY FOR THE ACCOMPANYING PRODUCT ARE SET FORTH IN THE INFORMATION PACKET THAT SHIPPED WITH THE PRODUCT AND ARE INCORPORATED HEREIN BY THIS REFERENCE. IF YOU ARE UNABLE TO LOCATE THE SOFTWARE LICENSE OR LIMITED WARRANTY, CONTACT YOUR CISCO REPRESENTATIVE FOR A COPY.

The Cisco implementation of TCP header compression is an adaptation of a program developed by the University of California, Berkeley (UCB) as part of UCB's public domain version of the UNIX operating system. All rights reserved. Copyright © 1981, Regents of the University of California.

NOTWITHSTANDING ANY OTHER WARRANTY HEREIN, ALL DOCUMENT FILES AND SOFTWARE OF THESE SUPPLIERS ARE PROVIDED "AS IS" WITH ALL FAULTS. CISCO AND THE ABOVE-NAMED SUPPLIERS DISCLAIM ALL WARRANTIES, EXPRESSED OR IMPLIED, INCLUDING, WITHOUT LIMITATION, THOSE OF MERCHANTABILITY, FITNESS FOR A PARTICULAR PURPOSE AND NONINFRINGEMENT OR ARISING FROM A COURSE OF DEALING, USAGE, OR TRADE PRACTICE.

IN NO EVENT SHALL CISCO OR ITS SUPPLIERS BE LIABLE FOR ANY INDIRECT, SPECIAL, CONSEQUENTIAL, OR INCIDENTAL DAMAGES, INCLUDING, WITHOUT LIMITATION, LOST PROFITS OR LOSS OR DAMAGE TO DATA ARISING OUT OF THE USE OR INABILITY TO USE THIS MANUAL, EVEN IF CISCO OR ITS SUPPLIERS HAVE BEEN ADVISED OF THE POSSIBILITY OF SUCH DAMAGES.

Cisco and the Cisco logo are trademarks or registered trademarks of Cisco and/or its affiliates in the U.S. and other countries. To view a list of Cisco trademarks, go to this URL: [www.cisco.com/go/trademarks](http://www.cisco.com/go/trademarks). Third-party trademarks mentioned are the property of their respective owners. The use of the word partner does not imply a partnership relationship between Cisco and any other company. (1110R)

Any Internet Protocol (IP) addresses and phone numbers used in this document are not intended to be actual addresses and phone numbers. Any examples, command display output, network topology diagrams, and other figures included in the document are shown for illustrative purposes only. Any use of actual IP addresses or phone numbers in illustrative content is unintentional and coincidental.

*Cisco Broadband Access Center 3.8 Administrator Guide*  
© 2013 Cisco Systems, Inc. All rights reserved.



# CONTENTS

## **Preface** xv

Audience xv

Organization xvi

Conventions xvii

Product Documentation xviii

Related Documentation xviii

Obtaining Documentation and Submitting a Service Request xviii

xviii

---

## **CHAPTER 1**

### **Broadband Access Center Overview** 1-1

Features and Benefits 1-1

Supported Technology 1-3

CWMP Technology 1-3

TR-196 1-3

---

## **CHAPTER 2**

### **Broadband Access Center Architecture** 2-1

Cisco BAC Deployment 2-1

Architecture 2-2

Regional Distribution Unit 2-4

Device Provisioning Engines 2-4

DPE Extension 2-5

DPE Licensing 2-5

Provisioning Groups 2-6

Discovery of ACS URL 2-6

Provisioning Group Scalability 2-7

Cisco BAC Process Watchdog 2-7

SNMP Agent 2-7

Logging 2-7

Access Registrar 2-8

RADIUS 2-8

Cisco Network Registrar 2-8

DHCP 2-8

LeaseQuery 2-9

**CHAPTER 3**

**Configuration Workflows and Checklists 3-1**

- Component Workflows 3-1
  - RDU Checklist 3-1
  - DPE Checklist 3-2
- Technology Workflows 3-3
  - RDU Configuration Workflow 3-3
    - Preregistering Device Data in Cisco BAC 3-4
  - DPE Configuration Workflow 3-5
    - Configuring CWMP Service on the DPE 3-6
    - Configuring HTTP File Service on the DPE 3-7
    - Configuring HTTP Auth Service on the DPE 3-8
  - Provisioning Group Configuration Workflow 3-8
    - Configuring Home Provisioning Group Redirection Service on the DPE 3-9

**CHAPTER 4**

**CPE Management Overview 4-1**

- CWMP Overview 4-1
- Cisco BAC Device Object Model 4-2
  - Property Hierarchy 4-4
  - Custom Properties 4-4
- Discovering CPE Parameters 4-4
- Multi-Instance Object Support 4-5
  - Configuration Template 4-6
  - Firmware Rules Template 4-10
  - Parameter Discovery 4-13
  - Display Live Data Operation 4-13
  - Instance Sorting 4-13
- Instruction Generation and Processing 4-14
  - Device Configuration Synchronization 4-15
- Device Deployment in Cisco BAC 4-16
  - Preregistered Devices 4-17
  - Unregistered Devices 4-17
- Initial Provisioning Flows 4-18
  - For Preregistered Devices 4-18
  - For Unregistered Devices 4-19
- Assigning Devices to Provisioning Groups 4-20
  - Explicit Assignment 4-20
  - Automatic Membership 4-20
  - Combined Approach 4-20

Device Diagnostics	4-21
Configuring SNMP Trap for CPEs	4-21

**CHAPTER 5****Configuration Templates Management 5-1**

Overview	5-1
Features of Cisco BAC Templates	5-4
Parameters	5-6
Parameter List for Single Instance Object	5-7
Parameter List for Multiple Instance Objects	5-7
Notification	5-8
Configuring Notification	5-8
Access Control	5-9
Configuring Access Control	5-9
Prerequisites	5-9
Expressions	5-11
MaintenanceWindow	5-11
Configuring Prerequisites	5-13
Authoring Configuration Templates	5-14
Custom Properties	5-15
Using Parameter Substitution	5-16
Using Includes	5-17
Using Conditionals	5-19
Using the Configuration Utility	5-22
Running the Configuration Utility	5-23
Adding a Template to Cisco BAC	5-23
Validating XML Syntax for a Local Template File	5-24
Validating XML Syntax for a Template Stored in Cisco BAC	5-24
Testing Template Processing for a Local Template File	5-25
Testing Template Processing for a Template Stored in Cisco BAC	5-26
Testing Template Processing for a Cisco BAC Template File and a Device	5-27

**CHAPTER 6****Firmware Management 6-1**

Overview	6-1
Firmware Management Mechanisms	6-2
Firmware Rule Templates	6-2
Direct Firmware Management	6-4
Managing Firmware Files	6-5
Authoring Firmware Rules Templates	6-6

- Expression and Regular Expression 6-7
- Internal Firmware File vs. External Firmware File 6-10
  - InternalFirmwareFile 6-10
  - ExternalFirmwareFile 6-11
- Sample Firmware Rules Template 6-11
- Using Template Constructs with Firmware Rule Templates 6-13
  - Using Parameter Substitution 6-14
  - Using Includes 6-14
  - Using Conditionals 6-15

**CHAPTER 7**

- Parameter Dictionaries 7-1**
  - Overview 7-1
  - Using Default Dictionaries 7-2
  - Custom Dictionaries 7-3
  - Parameter Dictionary Syntax 7-3
    - Sample Parameter Dictionary 7-4
  - Managing Parameter Dictionaries through User Interface 7-5
    - Adding Parameter Dictionaries 7-5
    - Viewing Parameter Dictionaries 7-6
    - Deleting Parameter Dictionaries 7-6
    - Replacing Parameter Dictionaries 7-6

**CHAPTER 8**

- CPE History and Troubleshooting 8-1**
  - Device History 8-1
    - Configuring Device History 8-4
      - Enabling Device History 8-4
      - Viewing Device History 8-4
      - Configuring Device History Size 8-5
    - Device History Records 8-5
  - Device Faults 8-6
    - Retrieving Device Faults 8-7
    - Managing Chatty Clients 8-9
  - Device Troubleshooting 8-9
    - Configuring Device Troubleshooting 8-10
      - Enabling Troubleshooting for a Device 8-10
      - Disabling Troubleshooting for a Device 8-11
      - Viewing List of Devices in Troubleshooting Mode 8-11
      - Viewing Device Troubleshooting Log 8-12

**CHAPTER 9****Managing Cisco Broadband Access Center 9-1**

- Cisco BAC Process Watchdog 9-1
  - Using Cisco BAC Process Watchdog from the Command Line 9-2
  - Enabling SNMP Trap for Cisco BAC Process Watchdog 9-3
- Administrator User Interface 9-4
- Command Line Interface 9-5
  - Accessing the DPE CLI from a Local Host 9-6
  - Accessing the DPE CLI from a Remote Host 9-6
- SNMP Agent 9-6
- Cisco BAC Tools 9-7

**CHAPTER 10****Database Management 10-1**

- Understanding Failure Resiliency 10-1
- Database Files 10-2
  - Database Storage File 10-2
  - Database Transaction Log Files 10-2
  - Automatic Log Management 10-3
  - Miscellaneous Database Files 10-3
- Disk Space Requirements 10-3
  - Handling Out of Disk Space Conditions 10-4
- Backup and Recovery 10-4
  - Database Backup 10-4
  - Database Recovery 10-5
  - Database Restore 10-6
- Changing Database Location 10-7

**CHAPTER 11****Monitoring Cisco Broadband Access Center 11-1**

- Syslog Alert Messages 11-1
  - Message Format 11-1
  - RDU Alerts 11-2
  - DPE Alerts 11-2
  - Watchdog Agent Alerts 11-4
  - Access Registrar Extension Point Alerts 11-5
- Monitoring Servers by Using SNMP 11-5
  - SNMP Agent 11-6
    - MIB Support 11-6
  - Using the snmpAgentCfgUtil.sh Tool 11-6
    - Adding a Host 11-7

- Deleting a Host 11-7
- Adding an SNMP Agent Community 11-8
- Deleting an SNMP Agent Community 11-9
- Starting the SNMP Agent 11-9
- Stopping the SNMP Agent 11-9
- Configuring an SNMP Agent Listening Port 11-10
- Changing the SNMP Agent Location 11-10
- Setting Up SNMP Contacts 11-10
- Displaying SNMP Agent Settings 11-11
- Specifying SNMP Notification Types 11-11
- Monitoring Server Status 11-12
  - Using the Administrator User Interface 11-12
  - Using the DPE CLI 11-12
- Monitoring Performance Statistics 11-14
  - Understanding *perfstat.log* 11-15
  - Using *runStatAnalyzer.sh* 11-15
- Monitoring STUN Statistics 11-17
  - Understanding *stunstatistics.log* 11-17
  - STUN Binding Information 11-18
  - Using *dumpStunBindingInfo.sh* 11-18
- Traffic Profiling 11-18

**CHAPTER 12**

- Configuring CWMP Service 12-1**
  - CWMP Service Configuration 12-1
    - Configuring Service Ports on the DPE 12-2
  - Connection Request Service 12-2
    - Configuring Connection Request Options 12-3
      - Configuring Authentication 12-3
      - Autogenerating Connection Request Passwords 12-4
      - Configuring Connection Request Methods 12-5
      - Configuring External URLs on DPE 12-10
      - Disabling Connection Requests 12-10
      - Configuring Reachability 12-11
    - Discovering Data from Devices 12-11
      - Configuring Data Discovery 12-12
      - Troubleshooting Data Discovery 12-13
      - Automatic IMEI Update 12-15
  - Provisioning Group Scalability and Failover 12-16
    - Redundancy in Cisco BAC 12-16



Local Redundancy	12-16
Regional Redundancy	12-16
DPE Load-Balancing	12-17
Using DNS Round Robin	12-17
Using a Hardware Load Balancer	12-17
Adding DPE to a Provisioning Group	12-18

**CHAPTER 13****Configuring CWMP Service Security 13-1**

Overview	13-1
Key and Certificate Management in Cisco BAC	13-2
Configuring SSL Service	13-3
Configuring DPE Keystore by Using the Keytool	13-3
Using the Keytool Commands	13-5
Generating Server Certificate Keystore and Private Key for a New Certificate	13-6
Displaying Self-Signed Certificate	13-7
Generating a Certificate-Signing Request	13-7
Importing Signing Authority Certificate into Cacerts Keystore	13-8
Importing the Signed Certificate into Server Certificate Keystore	13-9
Importing Certificates for Client Authentication	13-10
Configuring Security for DPE Services	13-11
Configuring SSL on a DPE	13-11
Enabling SSL for the CWMP Service	13-11
Enabling SSL for the HTTP File Service	13-12
Configuring CPE Authentication	13-13
Shared Secret Authentication	13-13
Client Certificate Authentication	13-16
External Client Certificate Authentication	13-16
Authentication Options in Cisco BAC	13-17
Configuring Security for RDU Services	13-18
RDU Authentication Mode Settings	13-19
TACACS+ Authentication and Authorization in RDU	13-19
Signed Configuration for Devices	13-20
Signature Expiration	13-20
Signature Regeneration	13-20
Configuration Interfaces	13-20
Monitoring the Signed Configuration Feature	13-21
Troubleshooting Signed Configuration Feature	13-22

**CHAPTER 14**

**CWMP Device Operations 14-1**

- Overview 14-1
- Connection Modes for Device Operations 14-2
  - Immediate Mode 14-2
  - On-Connect Mode 14-3
  - Asynchronous Mode 14-5
  - Conditional Execution 14-6
- Managing a Device's Provisioning Group 14-6
  - Redirecting CPE to Home Provisioning Group 14-7
  - Correcting a Device's Provisioning Group 14-8

**CHAPTER 15**

**Understanding the Administrator User Interface 15-1**

- Configuring the Administrator User Interface 15-1
- Accessing the Administrator User Interface 15-2
  - Logging In 15-2
  - Logging Out 15-4
- Understanding the Administrator User Interface Icons 15-4

**CHAPTER 16**

**Using the Administrator User Interface 16-1**

- User Management 16-1
  - Administrator 16-1
  - Read/Write User 16-2
  - Read-Only User 16-2
  - Adding a New User 16-2
  - Modifying Users 16-3
  - Deleting Users 16-4
- Device Management 16-4
  - Manage Devices Page 16-4
  - Searching for Devices 16-5
  - Device Management Controls 16-7
    - Viewing Device Details 16-7
  - Managing Devices 16-10
    - Adding Device Records 16-11
    - Modifying Device Records 16-11
    - Deleting Device Records 16-11
    - Viewing Device History 16-12
    - Regenerating Device Instructions 16-12
    - Relating and Unrelating Devices 16-13

Performing Operations on Devices	16-14
Group Management	16-18
Managing Group Types	16-18
Adding a Group Type	16-19
Modifying Group Types	16-20
Deleting Group Types	16-20
Managing Groups	16-20
Adding a New Group	16-20
Modifying a Group	16-21
Deleting Groups	16-21
Relating/Unrelating Groups to Groups	16-22
Viewing Group Details	16-22
Viewing Servers	16-22
Viewing Device Provisioning Engines	16-22
Viewing Network Registrar Extension Point Details	16-25
Viewing Provisioning Groups	16-26
Viewing Regional Distribution Unit Details	16-27

**CHAPTER 17**

<b>Configuring Broadband Access Center</b>	<b>17-1</b>
Configuring the Class of Service	17-1
Adding a Class of Service	17-3
Modifying a Class of Service	17-3
Deleting a Class of Service	17-4
Configuring Custom Properties	17-5
Configuring Defaults	17-6
Selecting Configuration Options	17-6
CWMP Defaults	17-7
RDU Defaults	17-10
System Defaults	17-11
TACACS+ Defaults	17-13
Managing Files	17-15
Adding Files	17-17
Viewing Files	17-18
Replacing Files	17-18
Exporting Files	17-19
Deleting Files	17-19
Managing License Keys	17-20
Adding and Modifying a License	17-21
Managing DPE Feature Pack Extensions	17-21

- Writing a New Class for DPE Feature Pack Extensions 17-22
- Managing RDU Extensions 17-23
- Writing a New Class for RDU 17-24
- Installing RDU Custom Extensions 17-25
- Viewing RDU Extensions 17-26
- Publishing Provisioning Data 17-26
  - Publishing Datastore Changes 17-26
  - Modifying Publishing Plug-In Settings 17-26
- Configuring Lease Query 17-27

**CHAPTER 18**

**Scripting Framework 18-1**

- Overview 18-1
- Script's Shared Scope 18-1
- Extension Script 18-2
- Integrating Extension Scripts in BAC 18-3
- Adding Extension Points to the Device Property 18-3
- Configuring Extensions for Unknown Devices 18-4
- Verifying Extension Scripts Availability in DPE Cache 18-5
- Verifying Status of the Extensions in DPE 18-5

**CHAPTER 19**

**RDU and DPE Connection Management 19-1**

- TCP Connection Management 19-1
  - Heart Beat 19-1
- RDU Batch Concurrency 19-2
  - Non-concurrent Commands 19-2
  - Long-Running Batch 19-3
- DPE-RDU Synchronization 19-3

**CHAPTER 20**

**Cisco BAC Support Tools and Advanced Concepts 20-1**

- Using the deviceExport.sh Tool 20-1
- Using the disk\_monitor.sh Tool 20-4
- Using the resetAdminPassword.sh Tool 20-5
- Using the runEventMonitor.sh Tool 20-5
- Using the changeARProperties.sh Tool 20-8
- Using the changeNRProperties.sh Tool 20-9

---

**CHAPTER 21****Troubleshooting Broadband Access Center 21-1**

- Troubleshooting Checklist 21-1
- Logging 21-2
  - Log Levels and Structures 21-3
  - Configuring Log Levels 21-4
  - Rotating Log Files 21-4
  - RDU Logs 21-5
    - Viewing the rdu.log File 21-5
    - Viewing the audit.log File 21-5
    - The RDU Log Level Tool 21-5
  - DPE Logs 21-8
    - Viewing the dpe.log File 21-8
  - Access Registrar Logs 21-8

---

**GLOSSARY**

---

**INDEX**





## Preface

---

The *Cisco Broadband Access Center 3.8 Administrator Guide* describes concepts and configurations related to Cisco Broadband Access Center, which is called Cisco BAC throughout this guide.

This chapter provides an outline of the other chapters in this guide, detailed information about related documents that support this Cisco BAC release, and demonstrates the styles and conventions used in the guide.



### Note

---

This document is to be used in conjunction with the documentation listed in [Product Documentation, page xviii](#).

---

This chapter contains the following information:

- [Audience, page xv](#)
- [Organization, page xvi](#)
- [Conventions, page xvii](#)
- [Product Documentation, page xviii](#)
- [Related Documentation, page xviii](#)
- [Obtaining Documentation and Submitting a Service Request, page xviii](#)

## Audience

The *Cisco Broadband Access Center 3.8 Administrator Guide* is written for system administrators involved in automating large-scale provisioning for broadband access. The network administrator should be familiar with these topics:

- Basic networking concepts and terminology.
- Network administration.

# Organization

This guide includes the following chapters:

Chapter	Title	Description
Chapter 1	<a href="#">Broadband Access Center Overview</a>	Describes Cisco BAC, its features and benefits.
Chapter 2	<a href="#">Broadband Access Center Architecture</a>	Describes the systems architecture implemented in this Cisco BAC release.
Chapter 3	<a href="#">Configuration Workflows and Checklists</a>	Provides checklists to follow when configuring Cisco BAC for use.
Chapter 4	<a href="#">CPE Management Overview</a>	Provides an overview of CPE management and describes key concepts supported within Cisco BAC.
Chapter 5	<a href="#">Configuration Templates Management</a>	Describes the configuration templates that Cisco BAC supports, and how to author custom configuration templates.
Chapter 6	<a href="#">Firmware Management</a>	Describes the firmware management feature that Cisco BAC supports.
Chapter 7	<a href="#">Parameter Dictionaries</a>	Describes the use of Parameter Dictionaries.
Chapter 8	<a href="#">CPE History and Troubleshooting</a>	Describes how to troubleshoot CPE, using device information, made available through Cisco BAC.
Chapter 9	<a href="#">Managing Cisco Broadband Access Center</a>	Describes the various options that help manage Cisco BAC.
Chapter 10	<a href="#">Database Management</a>	Describes how to manage and maintain the RDU database.
Chapter 11	<a href="#">Monitoring Cisco Broadband Access Center</a>	Describes how to monitor the Cisco BAC servers.
Chapter 12	<a href="#">Configuring CWMP Service</a>	Describes how to configure the CWMP service for use with Cisco BAC.
Chapter 13	<a href="#">Configuring CWMP Service Security</a>	Describes how to enhance security options using Cisco BAC.
Chapter 14	<a href="#">CWMP Device Operations</a>	Describes the operations that you can perform on the device using Cisco BAC.
Chapter 15	<a href="#">Understanding the Administrator User Interface</a>	Describes how to access Cisco BAC using the administrator user interface.
Chapter 16	<a href="#">Using the Administrator User Interface</a>	Describes administration activities, including searching for and viewing device information.
Chapter 17	<a href="#">Configuring Broadband Access Center</a>	Describes the configuration activities that are performed using the Cisco BAC administrator application.
Chapter 18	<a href="#">Scripting Framework</a>	Describes DPE scriptable extension framework which facilitates creating extension scripts, adding extension scripts in Cisco BAC, and verifying the script status in the DPE.



Chapter	Title	Description
Chapter 19	<a href="#">RDU and DPE Connection Management</a>	Describes the RDU TCP connection management, RDU batch concurrency and RDU DPE synchronization.
Chapter 20	<a href="#">Cisco BAC Support Tools and Advanced Concepts</a>	Describes Cisco BAC tools intended to help configure, maintain speed, and improve the installation, deployment, and use of Cisco BAC.
Chapter 21	<a href="#">Troubleshooting Broadband Access Center</a>	Describes how to troubleshoot Cisco BAC servers.
	<a href="#">Glossary</a>	Defines terminology used in this guide and generally applicable to the technologies being discussed.

## Conventions

This document uses the following conventions:

Convention	Indication
<b>bold font</b>	Commands and keywords and user-entered text appear in <b>bold font</b> .
<i>italic font</i>	Document titles, new or emphasized terms, and arguments for which you supply values are in <i>italic font</i> .
[ ]	Elements in square brackets are optional.
{ x   y   z }	Required alternative keywords are grouped in braces and separated by vertical bars.
[ x   y   z ]	Optional alternative keywords are grouped in brackets and separated by vertical bars.
string	A nonquoted set of characters. Do not use quotation marks around the string or the string will include the quotation marks.
<code>courier font</code>	Terminal sessions and information the system displays appear in <code>courier font</code> .
< >	Nonprinting characters such as passwords are in angle brackets.
[ ]	Default responses to system prompts are in square brackets.
!, #	An exclamation point (!) or a pound sign (#) at the beginning of a line of code indicates a comment line.



### Note

Means *reader take note*.



### Caution

Means *reader be careful*. In this situation, you might perform an action that could result in equipment damage or loss of data.

## Product Documentation

**Note**

---

We sometimes update the printed and electronic documentation after original publication. Therefore, you should also review the documentation on [Cisco.com](http://www.cisco.com) for any updates.

---

You can view the marketing and user documents for Cisco Broadband Access Center at:

[http://www.cisco.com/en/US/products/sw/netmgtsw/ps529/tsd\\_products\\_support\\_series\\_home.html](http://www.cisco.com/en/US/products/sw/netmgtsw/ps529/tsd_products_support_series_home.html)

The following document gives you the list of user documents for Cisco Broadband Access Center 3.8:

[http://www.cisco.com/en/US/docs/net\\_mgmt/broadband\\_access\\_center/3.8/documentation/overview/Cisco\\_BAC38\\_DocOverview.html](http://www.cisco.com/en/US/docs/net_mgmt/broadband_access_center/3.8/documentation/overview/Cisco_BAC38_DocOverview.html)

## Related Documentation

**Note**

---

We sometimes update the printed and electronic documentation after original publication. Therefore, you should also review the documentation on [Cisco.com](http://www.cisco.com) for any updates.

---

The following document gives you the list of user documents for Cisco Prime Network Registrar 8.1:

[http://www.cisco.com/en/US/docs/net\\_mgmt/prime/network\\_registrar/8.1/doc\\_overview/guide/CPNR\\_8\\_1\\_Doc\\_Guide.html](http://www.cisco.com/en/US/docs/net_mgmt/prime/network_registrar/8.1/doc_overview/guide/CPNR_8_1_Doc_Guide.html)

The following document gives you the list of user documents for Cisco Access Registrar 5.0:

[http://www.cisco.com/en/US/docs/net\\_mgmt/access\\_registrar/5.0/roadmap/guide/PrintPDF/ardocgd.html](http://www.cisco.com/en/US/docs/net_mgmt/access_registrar/5.0/roadmap/guide/PrintPDF/ardocgd.html)

## Obtaining Documentation and Submitting a Service Request

For information on obtaining documentation, submitting a service request, and gathering additional information, see *What's New in Cisco Product Documentation* at:

<http://www.cisco.com/en/US/docs/general/whatsnew/whatsnew.html>.

Subscribe to *What's New in Cisco Product Documentation*, which lists all new and revised Cisco technical documentation, as an RSS feed and deliver content directly to your desktop using a reader application. The RSS feeds are a free service.



# CHAPTER 1

## Broadband Access Center Overview

---

This chapter provides an overview of Cisco Broadband Access Center (Cisco BAC).

Cisco BAC automates the tasks of provisioning and managing customer premises equipment (CPE) in a broadband service provider network.

With the high-performance capabilities of Cisco BAC, you can scale the product to suit networks of virtually any size, even those with millions of CPE. It also offers high availability, made possible by the product's distributed architecture and centralized management.

Cisco BAC supports provisioning and managing of CPE by using the Broadband Forum's CPE WAN Management Protocol (CWMP), a standard defined in the TR-069 specification. Cisco BAC integrates the capabilities defined in TR-069 to increase operator efficiency and reduce network-management problems.

Cisco BAC supports devices based on the TR-069, TR-098, TR-104, TR-106, TR-181, and TR-196 standards. These devices include Ethernet and ADSL gateway devices, wireless gateways, VoIP ATAs, and other devices compliant with CWMP. Cisco BAC also provides for runtime-extensible data models to support any upcoming data-model standards or any vendor-specific data models based on CWMP.

Cisco BAC provides such critical features as redundancy and failover. Cisco BAC can be integrated into new or existing environments through the use of a provisioning application programming interface (API) that lets you control how Cisco BAC operates.

You can use the provisioning API to register devices in Cisco BAC, assign device configuration policies, execute any CWMP operations on the CPE, and configure the entire Cisco BAC provisioning system.

This chapter includes the following sections:

- [Features and Benefits, page 1-1](#)
- [Supported Technology, page 1-3](#)

## Features and Benefits

Cisco BAC helps service providers provision and manage the rapidly expanding number of home networking devices.

Cisco BAC supports mass-scale provisioning and managing of Femtocell Access Point (FAP) devices that function as mini 3G cell tower in customer premises and backhaul call using the customer's internet connection. Apart from supporting the FAP devices, Cisco BAC also supports provisioning and managing of Digital Life Controller (DLC) devices based on TR-069 protocol.

This section describes the basic features and benefits that the Cisco BAC architecture offers:

- **Configuration management:** Vastly simplified in Cisco BAC through configuration templates, which provide an easy, yet flexible mechanism to assign configurations for CPE. You can use the template-processing mechanism to customize configurations for millions of devices by using a small number of templates.

By using these XML-based templates, you can set configuration parameters and values, and notification and access controls on a device. Configuration templates allow:

- Conditionals, to include or exclude sections of a template based on, among others, Cisco BAC property values.
  - Includes, to include template content from other files.
  - Parameter substitution, to substitute Cisco BAC property values into template parameters.
  - Prerequisites, to evaluate whether the template is applicable to a device at given time.
- **Firmware management:** Maintaining and distributing sets of firmware image files to corresponding CPE through the Cisco BAC system. A firmware rules template, associates the firmware image files to groups of devices. Cisco BAC uses the rules in the associated firmware rules template to evaluate the firmware that is downloaded to the device.

Using the firmware management feature, you can view firmware information on devices, add firmware images to the database, and apply the image files to specific CPE.

- **Massive scalability:** Enhanced by partitioning CPE into provisioning groups; each provisioning group is responsible for only a subset of the CPE. A provisioning group is designed to be a logical (typically geographic) grouping of servers, usually consisting of one or more Device Provisioning Engines (DPEs).

A single provisioning group can handle the provisioning needs of up to 500,000 devices. As the number of devices grows past 500,000, you can add additional provisioning groups to the deployment.

- **Standards-based security:** Cisco BAC is designed to provide a high degree of security by using CWMP, outlined in the TR-069 standard. The CWMP security model is also designed to be scalable. It is intended to allow basic security to accommodate less robust CPE implementations, while allowing greater security for those that can support more advanced security mechanisms.

Cisco BAC integrates the Secure Sockets Layer (SSL) version 3.0 and the Transport Layer Security (TLS) version 1.0 protocols into its CWMP ACS implementation. By using HTTP over SSL/TLS (also known as HTTPS), Cisco BAC provides confidentiality and data integrity, and allows certificate-based authentication between the various components.

- **Easy integration with back-end systems, using Cisco BAC mechanisms such as:**
  - The Cisco BAC Java API, which can be used to perform all provisioning and management operations.
  - The Cisco BAC publishing extensions, which are useful in writing RDU data into another database.
  - The Cisco BAC Data Export tool, with which you can write device information from the Cisco BAC system to a file.
  - The SNMP agent, which simplifies integration for monitoring Cisco BAC.
  - The DPE command line interface, which simplifies local configuration when you use it to copy and paste commands.
- **Extensive server management:** Cisco BAC provides extensive server performance statistics, thereby enabling monitoring and troubleshooting.

- **Device diagnostics and troubleshooting:** You use this feature to focus on a single device and collect diagnostics information for further analysis. Cisco BAC provides several features to assist diagnosis:
  - **Device history**—Provides a detailed history of significant events that occur in a device provisioning lifecycle.
  - **Device faults**—Detects devices with recurring faults, which can cause bottlenecks and affect network performance.
  - **Device troubleshooting**—Provides detailed records of device interactions with Cisco BAC servers for a set of devices that are designated for such troubleshooting.
  - **Direct device operations**—Operations such as IP Ping and Get Live Data can be run on the device for more insight.
- **Multi-instance object support:** This feature introduces support for discovering and updating the CPE parameters associated with multiple object instances, without specifying the actual instance number. The multi-instance object support in the template, adds the flexibility to apply the configuration on selective object instances.
- **Scriptable framework:** This feature introduces the scriptable extension service which facilitates running the Java scripts based DPE extensions. This feature also provides the support to load and unload the extensions dynamically without restarting the DPE.

## Supported Technology

This Cisco BAC release supports the provisioning and managing of CPE only through CWMP, outlined in the TR-069 specification. However, virtually any data models based on TR-069, TR-098, TR-104, TR-106, TR-181, and TR-196 extensions are supported.

## CWMP Technology

TR-069 is a standard for remote management of CPE. This standard defines CWMP, which enables communication between CPE and an autoconfiguration server (ACS).

CWMP details a mechanism that increases operator efficiency and reduces network management problems through its primary capabilities. These capabilities include:

- Autoconfiguration
- Firmware Management
- Status and Performance Monitoring
- Device Diagnostics and Troubleshooting

In addition to CWMP, the TR-069 specification defined a version 1.0 of the data model for Internet Gateway Device (IGD), which has since been expanded by TR-098. CWMP, as defined in TR-069, works with any data model extended from CWMP, including those defined in TR-098, TR-104, TR-106, TR-181, and TR-196, upcoming new ones, or those that are vendor specific.

## TR-196

TR-196 standard provides the data model for the Femto Access Point (FAP) for remote management purposes using the TR-069 CWMP.

The Cisco BAC template-based mechanism to assign configurations for devices is enhanced to support the TR-196 devices in the service provider's network. Cisco BAC provides two additional parameter dictionary files to support the following TR-196 data models:

- TR-196 Amendment 1
- TR-196 Issue 2 and TR-181 Issue 2 Amendment 2

Cisco BAC also provides a Generally Available (GA) scriptable extensions targeting residential 3G features of above TR-196 data models. You can use the corresponding properties to configure the extension and the TR-196 data model to be used for any device.

The support for discovering multiple objects instances associated with a parameter, is also available for TR-196 devices.



## CHAPTER 2

# Broadband Access Center Architecture

---

This chapter describes the system architecture implemented in this Cisco Broadband Access Center (Cisco BAC) release.

This chapter includes the following sections:

- [Cisco BAC Deployment, page 2-1](#)
- [Architecture, page 2-2](#)

## Cisco BAC Deployment

Cisco BAC provisions devices are based on the TR-069, TR-098, TR-104, TR-106, TR-181, and TR-196 standards. This includes Ethernet and ADSL gateway devices, wireless gateways, VoIP ATAs, and other devices compliant with the CPE WAN Management Protocol (CWMP).

[Figure 2-1](#) represents a typical, fully redundant, CWMP deployment in a Cisco BAC network.

Figure 2-1 CWMP Deployment in Cisco BAC

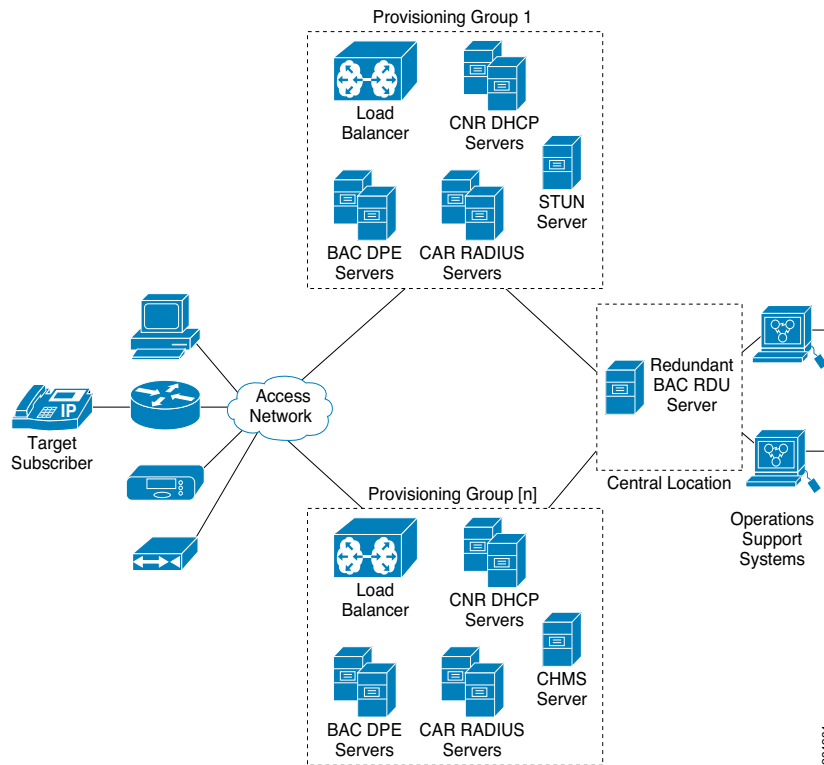

## Architecture

This section describes the basic Cisco BAC architecture including:

- Regional Distribution Unit (RDU) that provides:
  - The authoritative data store of the Cisco BAC system.
  - Support for processing application programming interface (API) requests.
  - Monitoring of the system’s overall status and health.
 See [Regional Distribution Unit, page 2-4](#), for additional information.
- Device Provisioning Engines (DPEs) that provide:
  - Interface with customer premises equipment (CPE).
  - Configuration and firmware policy instructions cache.
  - Autonomous operation from the RDU and other DPEs.
  - CPE WAN Management Protocol (CWMP) service.
  - IOS-like command line interface (CLI) for configuration.
  - Hypertext Transfer Protocol (HTTP) file service.
 See [Device Provisioning Engines, page 2-4](#), for additional information.



- STUN server:
  - Supports a UDP based connection request mechanism defined in TR069 Annex G to allow Cisco BAC to initiate a session with a CPE that is operating behind a NAT Gateway.
- Cisco Management Heartbeat Server (CMHS) server:
  - A new connection request method that allows Cisco BAC to send connection requests to DLC devices through the CMHS server, using BAC north bound API interfaces or BAC Admin UI.
- Client API that provides total client control over the system's capabilities.
- Provisioning Groups that provide:
  - Logical grouping of DPE servers, CAR-RADIUS servers and CNR-DHCP servers in a redundant cluster.
  - Redundancy and scalability

See [Provisioning Groups, page 2-6](#), for additional information.

- The Cisco BAC process watchdog that provides:
  - Administrative monitoring of all critical Cisco BAC processes.
  - Automated process restart capability.
  - Ability to start and stop Cisco BAC component processes.
  - Ability to send the SNMP trap if any BAC process fails to start or stop, or stops unexpectedly. SNMP trap is a mechanism that the trap receiver uses to get the information about the process or component failure. A SNMP trap is also sent if Cisco BAC process watchdog fails to start on any of the servers that run Cisco BAC components. Cisco BAC process watchdog reports all the critical conditions of BAC components through SNMP trap.

See [Cisco BAC Process Watchdog, page 2-7](#), for additional information.

- An administrator user interface that provides:
  - Support for adding, deleting, and modifying CWMP devices; searching for devices, retrieving device details, and running device operations.
  - Support for configuring global defaults and defining custom properties.
  - Ability to view additional performance statistics.
  - Management of firmware rules and configuration templates.
 See [Administrator User Interface, page 9-4](#), for additional information.
- An SNMP agent that supports:
  - Third-party management systems.
  - SNMP version v2.
  - SNMP Notification.
 See [SNMP Agent, page 2-7](#), for additional information.
- Cisco Network Registrar servers that provide:
  - Dynamic Host Configuration Protocol (DHCP).
 See [Cisco Network Registrar, page 2-8](#), for additional information.

## Regional Distribution Unit

The Regional Distribution Unit (RDU) is the primary server in the Cisco BAC provisioning system. It is installed on a server running the Solaris 10 or Linux 5.x operating system.

The functions of the RDU include:

- Managing preprovisioned and discovered data from devices.
- Generating instructions for DPEs and distributing them to DPE servers for caching.
- Cooperating with DPEs to keep them up to date.
- Processing API requests for all Cisco BAC functions.
- Managing the Cisco BAC system.

The RDU supports the addition of new technologies and services through an extensible architecture.

Cisco BAC currently supports one RDU per installation. Use of clustering software from Veritas or Sun is recommended for providing RDU failover. Use of RAID (Redundant Array of Independent Disks) shared storage is recommended in such a setup.

## Device Provisioning Engines

The Device Provisioning Engine (DPE) communicates with the CPE on behalf of the RDU to perform provisioning or management functions.

The RDU generates instructions that the DPE must perform on the device. These instructions are distributed to the relevant DPE servers, where they are cached. These instructions are then used during interactions with the CPE to perform tasks, such as configuration of devices, firmware upgrades, and data retrieval.

Each DPE caches information for up to 500,000 devices, and multiple DPEs can be used to ensure redundancy and scalability.

The DPE manages these activities:

- Synchronization with RDU to retrieve the latest set of instructions for caching.
- Communication with CPE using HTTP and HTTPS for file download service.
- Authentication and encryption of communication with CPE.
- Authenticate and Authorize CPE by processing the request from RADIUS server.

The DPE is installed on a server that is running the Solaris 10 or Linux 5.x operating system. The DPE is configured and managed by using the CLI, which you can access locally or remotely using Telnet. See the *Cisco Broadband Access Center 3.8 DPE CLI Reference*, for specific information on the CLI commands that a DPE supports.

See these sections for other important information:

- [DPE Licensing, page 2-5](#)
- [DPE-RDU Synchronization, page 19-3](#)

Also, familiarize yourself with the concept of instruction generation, which is described in [Instruction Generation and Processing, page 4-14](#).

## DPE Extension

The DPE extension interface provides several levels of extensibility that range from ability to make minor changes to existing behavior via an extension to a complete overhaul of DPE behavior that allows it to perform any logic with HTTP or CWMP. It can even function independent of the RDU. The DPE extension simply augments the existing CWMP behavior.

However, when DPE is extended in such a way that RDU is either not required or is not used to store all device records, alternative licensing is needed. The Feature Pack licensing feature, described in [DPE Licensing, page 2-5](#), provides the alternative licenses.

## DPE Licensing

Licensing controls the number of DPEs (nodes) that you can use. If you attempt to install more DPEs than you are licensed to have, those new DPEs will not be able to register with the RDU, and will be rejected. Existing licensed DPEs remain online.



---

**Note**

For licensing purposes, a registered DPE is considered to be one node.

---

Whenever you change licenses, by adding a license, extending an evaluation license, or through the expiration of an evaluation license, the changes take immediate effect.

When you delete a registered DPE from the RDU database, a license is freed. Since the DPEs automatically register with the RDU, you must take the DPE offline if the intention is to free-up the license. Then, delete the DPE from the RDU database by using the RDU administrator user interface.



---

**Note**

The functions enabled using a specific license, continue to operate even when the corresponding license is deleted from the system.

---

Cisco BAC now provides a mechanism to license DPE extension feature packs. The feature pack licenses indicate the count of the devices that can be processed by the feature pack extension. The feature pack licenses can be added to the RDU through Cisco BAC admin UI or API independently with or without CWMP / DPE licenses.

DPEs that are rejected during registration because of licensing constraints, do not appear in the administrator user interface. To determine the license state, you need to examine the log files of the RDU and the DPE.

## Provisioning Groups

A provisioning group is designed to be a logical (typically geographic) grouping of servers that usually consist of one or more DPEs, CNR-DHCP servers and CAR-RADIUS servers. Each DPE in a given provisioning group, caches identical sets of instructions from the RDU; thus enabling redundancy and load balancing.

A single provisioning group can handle the provisioning needs of up to 500,000 devices. As the number of devices grows past 500,000, you can add additional provisioning groups to the deployment.

**Note**

The servers for a provisioning group are not required to reside at a regional location, they can just as easily be deployed in the central network operations center.

For more information, see:

- [Discovery of ACS URL, page 2-6](#)
- [Provisioning Group Scalability, page 2-7](#)

## Discovery of ACS URL

In the distributed architecture that Cisco BAC provides, the RDU is the centralized aggregation point that never directly interacts with a CPE. Any required interactions with the CPE are delegated to the provisioning group.

Each device identifies the provisioning group to which it connects by the URL of a single autoconfiguration server (ACS); in other words, the DPE. Until the URL is updated, the device contacts the DPE at the same URL.

All redundant DPEs in a given provisioning group, must share a single ACS URL. The RDU has to be aware of the URL that is associated with each provisioning group and, by extension, of all DPEs in that provisioning group. The RDU uses its knowledge of the provisioning group's ACS URL to redirect devices to a new provisioning group, when required.

The RDU automatically learns the provisioning group's ACS URL from DPE registrations; or the ACS URL is configured on the provisioning group object, using the API or the administrator user interface. For information on configuring the ACS URL, see [Provisioning Group Configuration Workflow, page 3-8](#).

The CPE can determine the ACS (DPE) URL in one of two ways:

- By preconfiguring the URL on the device. This ACS URL is the configured URL of the Cisco BAC server that is associated with each provisioning group. The URL is preconfigured on the device before it is shipped to the customer, and is also known as the assigned URL.

- By discovering the URL via DHCP. This ACS URL is returned in response to a DHCP Discover, a DHCP Request, or a DHCP Inform. This mechanism is limited to deployments of primary Internet gateway devices, because it requires the ability to make DHCP requests to the WAN side.



**Note** Assigning a URL using preconfiguration is a more secure mechanism than one discovered using DHCP.

## Provisioning Group Scalability

Provisioning groups enhance the scalability of the Cisco BAC network by making each provisioning group responsible for only a subset of devices. This partitioning of devices can be along regional groupings or any other policy that the service provider defines. When the size of the provisioning group is restricted, the DPEs can be more effective in caching the necessary information.

To scale a deployment, the service provider can:

- Upgrade existing DPE server hardware.
- Add DPE servers to a provisioning group.
- Add provisioning groups.

## Cisco BAC Process Watchdog

The Cisco BAC process watchdog is an administrative agent that monitors the runtime health of all Cisco BAC processes. This watchdog process ensures that if a process stops unexpectedly, it is automatically restarted.

The Cisco BAC process watchdog can be used as a command line tool to start, stop, restart, and determine the status of any monitored processes.

See [Cisco BAC Process Watchdog, page 9-1](#), for additional information on how to manage the monitored processes.

## SNMP Agent

Cisco BAC provides basic SNMP v2-based monitoring of the RDU and the DPE servers. The Cisco BAC SNMP agents support SNMP informs and traps. You can configure the SNMP agent on the DPE by using `snmp-server` CLI commands, and on the RDU by using the SNMP configuration command-line tool.

See [Monitoring Servers by Using SNMP, page 11-5](#), for additional information on the SNMP configuration command line tool, and the [Cisco Broadband Access Center 3.8 DPE CLI Reference](#), for additional information on the DPE CLI.

## Logging

Logging of events is performed at the DPE and the RDU. In some unique situations, DPE events are additionally logged at the RDU to give them higher visibility. Log files are located in their own log directories and can be examined by using any text processor.

You can compress the files for easier e-mailing to the Cisco Technical Assistance Center or system integrators for troubleshooting and fault resolution. You can also access the RDU and the DPE logs from the administrator user interface.

For detailed information on log levels and structures, and how log files are numbered and rotated, see [Logging, page 21-2](#).

## Access Registrar

CAR is a RADIUS (Remote Authentication Dial-In User Service) server that enables multiple dial-in Network Access Server (NAS) devices to share a common authentication, authorization, and accounting database.

For additional information on Access Registrar, see the [User Guide for Cisco Access Registrar 5.0](#) and [Installation Guide for Cisco Access Registrar 5.0](#).

## RADIUS

CAR is based on a client/server model, which supports AAA (authentication, authorization, and accounting). The client is the Network Access Server (NAS) and the server is CAR. The client passes user information onto the RADIUS server and acts on the response it receives.

The server, on the other hand, is responsible for receiving user access requests, authenticating and authorizing users, and returning all necessary configuration information that the client can then pass on to the user.

Cisco BAC now supports RADIUS for device authentication. CAR provides an extension mechanism to allow customization of RADIUS requests and responses. Cisco BAC handles the Authentication and Authorization request through this extension.

## Cisco Network Registrar

Cisco Network Registrar provides the DHCP functionality in Cisco BAC. The DHCP extension points on Network Registrar integrate Cisco BAC with Network Registrar. Using these extensions, the CNR registers itself with Cisco BAC.

**Note**

---

Cisco Network Registrar (CNR) is re-branded to Cisco Prime Network Registrar starting with the 8.0 release.

---

For additional information on Cisco Prime Network Registrar, see the [Cisco Prime Network Registrar 8.1 User Guide](#), [Cisco Prime Network Registrar 8.1 CLI Reference Guide](#), and [Cisco Prime Network Registrar 8.1 Installation Guide](#).

## DHCP

The DHCP server automates the process of configuring IP addresses on IP networks. The protocol performs many of the functions that a system administrator carries out when connecting a device to a network. DHCP automatically manages network-policy decisions and eliminates the need for manual configuration. This feature adds flexibility, mobility, and control to networked device configurations.

## LeaseQuery

The LeaseQuery feature allows you to request lease information from the Network Registrar DHCP servers. In this release, the LeaseQuery feature is being used by Connection Request and Femto Authorization Service.

The Connection Request performs the LeaseQuery by providing the list of DHCP servers, whereas the Femto Authorization Service performs the LeaseQuery, using the provisioning group. In case of Femto Authorization Service, the DPE sends DHCP LeaseQuery messages only to the DHCP servers registered for the device's provisioning group, which prevents querying all DHCP servers in the network.

Among all responses, the response from the server that last communicated with the devices, is taken as the authoritative answer.

In earlier Cisco BAC versions, the LeaseQuery feature relied on the operating system to select the source interface and the source port for sending LeaseQuery requests. In this release, you can configure the RDU to use a specific interface and source port.

For detailed information on configuring LeaseQuery in this Cisco BAC release, see [Configuring Lease Query, page 17-27](#).







# CHAPTER 3

## Configuration Workflows and Checklists

This chapter is divided into two major sections that define the processes to follow when configuring Cisco Broadband Access Center (Cisco BAC) components to support various technologies.

This chapter includes the following sections:

- [Component Workflows, page 3-1](#)
- [Technology Workflows, page 3-3](#)

### Component Workflows

This section describes the workflows you must follow to configure each Cisco BAC component for the technologies supported by Cisco BAC. These configuration tasks are performed before configuring Cisco BAC to support specific technologies.

The component workflows described in this section are arranged in a checklist format and include:

- [RDU Checklist](#)
- [DPE Checklist](#)

### RDU Checklist

[Table 3-1](#) identifies the workflow to follow when configuring the RDU.

**Table 3-1** RDU Workflow Checklist

Procedure	Refer to...
1. Configure the system syslog service for use with Cisco BAC.	<a href="#">Installation Guide for Cisco Broadband Access Center 3.8</a>
2. Access the Cisco BAC administrator user interface.	<a href="#">Configuring the Administrator User Interface, page 15-1</a>
3. Change the admin password.	<a href="#">Configuring the Administrator User Interface, page 15-1</a>
4. Add the appropriate license keys.	<a href="#">Managing License Keys, page 17-20</a>

**Table 3-1 RDU Workflow Checklist (continued)**

Procedure	Refer to...
5. Configure the RDU database backup procedure.	<a href="#">Backup and Recovery, page 10-4</a>
6. Configure the RDU SNMP agent.	<a href="#">Using the snmpAgentCfgUtil.sh Tool, page 11-6</a>

## DPE Checklist

You must perform the tasks described in [Table 3-2](#) after those described in [Table 3-1](#).



### Note

Items marked with an asterisk (\*) are mandatory tasks or procedures.

**Table 3-2 DPE Configuration Checklist**

Procedure	Refer to ...
1. Configure the system syslog service for use with Cisco BAC.	<a href="#">Cisco Broadband Access Center 3.8 Installation Guide.</a>
2. Change the passwords.*	The <b>password</b> command described in the <a href="#">Cisco Broadband Access Center 3.8 DPE CLI Reference.</a>
3. Configure the provisioning interface.	The <b>interface ethernet [intf0   intf1]</b> command described in the <a href="#">Cisco Broadband Access Center 3.8 DPE CLI Reference.</a>
4. Configure the Cisco BAC shared secret.*	The <b>dpe shared-secret</b> command described in the <a href="#">Cisco Broadband Access Center 3.8 DPE CLI Reference.</a>
5. Configure the DPE to connect to the desired RDU.*	The <b>dpe rdu-server</b> command described in the <a href="#">Cisco Broadband Access Center 3.8 DPE CLI Reference.</a>
6. Configure the network time protocol (NTP).	Solaris or Linux documentation for configuration information.
7. Configure the provisioning group name.*	The <b>dpe provisioning-group primary</b> command described in the <a href="#">Cisco Broadband Access Center 3.8 DPE CLI Reference.</a>
8. Configure the required routes to the RDU as well as to the devices in the network.	Solaris or Linux documentation for configuration information.
9. Configure the DPE SNMP agent.	The SNMP agent commands in the <a href="#">Cisco Broadband Access Center 3.8 DPE CLI Reference.</a>
<b>Note</b>	You can configure the SNMP agent using either the DPE command line interface or the snmpAgentCfgUtil.sh tool. For more information, see <a href="#">Using the snmpAgentCfgUtil.sh Tool, page 11-6.</a>

**Table 3-2** DPE Configuration Checklist (continued)

Procedure	Refer to ...
10. Verify that the DPE successfully connected to the RDU and was registered.	<a href="#">Viewing Servers, page 16-22</a>
11. Configure the home provisioning group redirection service on the DPE	The <b>interface ip x.x.x.x. pg-communication</b> and <b>service cwmp-redirect 1 enable</b> commands described in the <a href="#">Cisco Broadband Access Center 3.8 DPE CLI Reference</a> .

## Technology Workflows

This section describes the tasks that you must perform when configuring Cisco BAC to support specific technologies; in this case, CWMP. These configuration tasks are performed after configuring Cisco BAC components.

The CWMP technology workflows described in this section are arranged in a checklist format and include:

- [RDU Configuration Workflow, page 3-3](#)
- [DPE Configuration Workflow, page 3-5](#)

## RDU Configuration Workflow

[Table 3-3](#) identifies the configuration tasks you must perform to configure the RDU for the CWMP technology.

**Table 3-3** RDU Configuration Workflow

Procedure	Refer to ...
1. Create service profiles by using the Cisco BAC Class of Service.  Define custom properties referenced in templates from the administrator user interface. The custom properties can be referenced in configuration and firmware rules templates.  For each service, you must:	<a href="#">Configuring Custom Properties, page 17-5</a>
a. Create a configuration template.  Add the configuration template to the RDU from the administrator user interface.	<a href="#">Adding Files, page 17-17</a>
b. Create a firmware rules template.  – Add the firmware images to the RDU from the administrator user interface.  – Add the firmware rules template to the RDU from the administrator user interface.	<a href="#">Adding Files, page 17-17</a>

**Table 3-3 RDU Configuration Workflow (continued)**

Procedure	Refer to ...
<p>c. Create a Class of Service from the administrator user interface.</p> <p>Remember to:</p> <ul style="list-style-type: none"> <li>– Specify the configuration template file.</li> <li>– Specify the firmware rules file.</li> <li>– Optionally, specify properties.</li> </ul>	<a href="#">Configuring the Class of Service, page 17-1</a>
<p>2. Configure default settings for the CWMP technology from the administrator user interface.</p> <ul style="list-style-type: none"> <li>– Set the default Class of Service; for example, for unknown devices.</li> <li>– Set the Connection Request Service defaults from any of the following pages: <b>Configuration &gt; Class of Service;</b> <b>Configuration &gt; Defaults;</b> and <b>Devices.</b></li> </ul>	<a href="#">Configuring Defaults, page 17-6</a>
<p>3. Preregister the CWMP devices.</p>	<a href="#">Preregistering Device Data in Cisco BAC, page 3-4</a>

## Preregistering Device Data in Cisco BAC

Preregistering adds the device record to the RDU before the device makes initial contact with the DPE. The DPE is also known as the autoconfiguration server (ACS). This task is typically executed from the provisioning API. However, you can preregister device data from the administrator user interface as well.

To preregister device data in Cisco BAC:

**Step 1** Add the device record to the RDU database by using the API or the administrator user interface.

To add a device record from the administrator user interface:

- a. Choose **Devices > Manage Devices**.
- b. On the Manage Devices page, click **Add**.  
The Add Device page appears.
- c. Enter values in the appropriate fields. The required and recommended provisioning attributes for a preregistered device are:

---

### Required

- Device identifier
- Registered Class of Service
- Home provisioning group

---

### Additional Typical Attributes

Additional attributes may be required depending on customer premises equipment (CPE) authentication methods.

---

- 
- Owner identifier
  - CPE password, if client authentication using unique client certificates is not enabled.
  - Connection Request username. This step is optional.
  - Connection Request password. This step is optional.
- 

### Optional

---

Connection Request Methods on the Class of Service. This step is optional.

Configuring the connection request method enables device authentication of the autoconfiguration server. Choose from:

- Discovered
  - Use FQDN
  - Use IP
- 

- Step 2** Verify whether the device record is preregistered. To do this:
- Examine the Device Details. To do this:
 

From the **Devices > Manage Devices** page, click the **View Details** icon (🔍) corresponding to the device. From the Device Details page:

    - Check if the device settings are correct.
    - Look for discovered parameters; these parameters are not displayed if the device is yet to initiate its first contact with the DPE.
    - Check the Device History log.
  - Examine the RDU and the DPE log files (see [Logging, page 21-2](#)).
- Step 3** Configure the device to send periodic informs to the DPE. To do this, set the *PeriodicInformEnable* and the *PeriodicInformInterval* variables in a configuration template.
- Step 4** Initiate device contact with Cisco BAC for the first time. To initiate device contact, do one of the following:
- Initiate a connection request from the API.
  - Wait for the next periodic contact from the device.
  - Reboot.
- Step 5** Verify the first device contact with Cisco BAC. From **Device > Manage Devices > Device Details**, check if discovered properties are visible. Also, check the history log for details.
- 

## DPE Configuration Workflow

This section describes how you can provide CWMP support at the DPE, by configuring:

- CWMP services for CWMP management on the DPE.  
See [Configuring CWMP Service on the DPE, page 3-6](#).
- HTTP file services for firmware management on the DPE.  
See [Configuring HTTP File Service on the DPE, page 3-7](#).
- Configuring HTTP auth service on DPE.

## Configuring CWMP Service on the DPE

Table 3-4 identifies the configuration tasks that you must perform to configure the CWMP services on the DPE.

**Table 3-4 DPE Configuration Workflow - CWMP Management**

Procedure	Refer to ...
<p>Configure the CWMP services that run on the DPE. Configuring the CWMP technology on the DPE requires that you enable at least one CWMP service. To enable a CWMP service, enter:</p> <pre>service cwmp num enable true</pre> <p>where <i>num</i> identifies the CWMP service, which could be 1 or 2.</p> <p>By default, the CWMP service is:</p> <ul style="list-style-type: none"> <li>- Enabled on service 1.</li> <li>- Disabled on service 2.</li> </ul>	<p>The CWMP Technology Commands described in the <a href="#">Cisco Broadband Access Center 3.8 DPE CLI Reference</a>.</p>
<p>1. Configure the port on which the CWMP service communicates with the CPE.</p> <p>By default, the CWMP service is configured to listen on:</p> <ul style="list-style-type: none"> <li>- Port 7547 for service 1.</li> <li>- Port 7548 for service 2.</li> </ul>	<p>The <b>service cwmp num port port</b> command described in the <a href="#">Cisco Broadband Access Center 3.8 DPE CLI Reference</a>.</p>
<p>2. Configure client authentication for the CWMP service.</p> <p>To limit security risks during client authentication, we recommend using the Digest mode (the default configuration).</p> <p>You should not allow client authentication in the Basic mode, or altogether disable Basic and Digest authentication.</p>	<p>The <b>service cwmp num client-auth mode</b> command described in the <a href="#">Cisco Broadband Access Center 3.8 DPE CLI Reference</a>.</p>
<p>3. Configure client authentication using certificates through SSL for the CWMP service.</p>	<p>The <b>service cwmp num ssl client-auth mode</b> command described in the <a href="#">Cisco Broadband Access Center 3.8 DPE CLI Reference</a>.</p>
<p>4. Configure the DPE to request configuration from the RDU for devices unknown to the DPE.</p> <p>Enabling this feature may allow a Denial of Service attack on the RDU.</p>	<p>The <b>service cwmp num allow-unknown-cpe</b> command described in the <a href="#">Cisco Broadband Access Center 3.8 DPE CLI Reference</a>.</p>

## Configuring HTTP File Service on the DPE

Table 3-5 identifies the configuration tasks that you must perform to configure the HTTP file services running on the DPE.

**Table 3-5 DPE Configuration Workflow - Firmware Management**

Procedure	Refer to ...
<p>Configure the HTTP file service that runs on the DPE.</p> <p>Configuring firmware management on the DPE requires that you enable at least one HTTP file service. To enable a HTTP file service, enter:</p> <pre>service http num enable true</pre> <p>where <i>num</i> identifies the HTTP file service, which could be 1 or 2.</p> <p>By default, the HTTP service is:</p> <ul style="list-style-type: none"> <li>– Enabled on service 1.</li> <li>– Disabled on service 2.</li> </ul>	<p>The CWMP Technology Commands described in the <a href="#">Cisco Broadband Access Center 3.8 DPE CLI Reference</a>.</p>
<p>1. Configure the port on which the HTTP file service communicates with the CPE.</p> <p>By default, the HTTP file service is configured to listen on:</p> <ul style="list-style-type: none"> <li>– Port 7549 for service 1.</li> <li>– Port 7550 for service 2.</li> </ul>	<p>The <b>service http num port port</b> command described in the <a href="#">Cisco Broadband Access Center 3.8 DPE CLI Reference</a>.</p>
<p>2. Configure client authentication for the HTTP file service.</p> <p>To limit security risks during client authentication, we recommend that you use the Digest mode (the default configuration).</p> <p>You should not allow client authentication in the Basic mode, or altogether disable Basic and Digest authentication.</p>	<p>The <b>service http num client-auth mode</b> command described in the <a href="#">Cisco Broadband Access Center 3.8 DPE CLI Reference</a>.</p>
<p>3. Configure client authentication by using certificates through SSL for the HTTP file service.</p>	<p>The <b>service http num ssl client-auth mode</b> described in the <a href="#">Cisco Broadband Access Center 3.8 DPE CLI Reference</a>.</p>

## Configuring HTTP Auth Service on the DPE

Table 3-6 below identifies the configuration tasks that you must perform to configure the AUTH services on the DPE.

**Table 3-6 DPE Configuration Workflow - AUTH Management**

Procedure	Refer to ...
Configure the Auth service that run on the DPE. To enable a Auth service, enter: <pre>service auth 1 enabled true</pre> By default, the Auth service is enabled.	The CWMP Technology Commands described in the <a href="#">Cisco Broadband Access Center 3.8 DPE CLI Reference</a> .
Configure the http interface on which the Auth service is running on. To configure the Auth service interface, enter: <pre>service auth 1 address (host_fqdn)</pre> By default, the Auth service is configured to listen on <code>localhost</code> .	The <code>service http num port port</code> command described in the <a href="#">Cisco Broadband Access Center 3.8 DPE CLI Reference</a> .
Configure the port on which the Auth service communicates with the CAR-EP. To configure the Auth service port, enter: <pre>service auth 1 port port_num</pre> By default, the Auth service is configured to listen on <code>7551</code> .	The <code>service http num client-auth mode</code> command described in the <a href="#">Cisco Broadband Access Center 3.8 DPE CLI Reference</a> .
Enables or disables use of HTTP over SSL/TLS for the Auth service. To enable SSL/TLS for the Auth Service interface, enter: <pre>service auth 1 ssl enabled true</pre>	The <code>service http num ssl client-auth mode</code> described in the <a href="#">Cisco Broadband Access Center 3.8 DPE CLI Reference</a> .

## Provisioning Group Configuration Workflow

Provisioning groups are automatically created when the DPE is first configured to be in a particular provisioning group (see [Adding DPE to a Provisioning Group, page 12-18](#)), and then it registers with the RDU. After the provisioning group is created, you can configure it by assigning the URL of the Cisco BAC server from the administrator user interface.

Before configuring the provisioning group URL, familiarize yourself with Cisco BAC concepts regarding local and regional redundancy. These concepts are described in [Provisioning Group Scalability and Failover, page 12-16](#).



### Note

We recommend that you assign a URL to the provisioning group right when you create the provisioning group. Assigning the URL enables CPE redirection between provisioning groups. If you are using a load balancer, ensure that the address of the load balancer is used as the ACS URL.



To configure the ACS URL of a provisioning group from the administrator user interface:

- 
- Step 1** On the primary navigation bar, click **Servers > Provisioning Groups**.  
The Manage Provisioning Groups page appears.
- Step 2** Click the identifier link of the correct provisioning group.  
The View Provisioning Group Details page appears.
- Step 3** In the Provisioning Group Properties area, enter the URL in the ACS URL field.



**Note** Remember that the URL that you configure overrides the discovered ACS URL.

---

- Step 4** Click **Submit**.  
The provisioning group now contacts Cisco BAC at the URL that you configured.
- 

## Configuring Home Provisioning Group Redirection Service on the DPE

Cisco BAC provides redirection to the home provisioning group of a device by having the provisioning groups communicate among themselves (see [Redirecting CPE to Home Provisioning Group, page 14-7](#)).

To enable the home provisioning group redirection feature, you must configure the home provisioning group redirection service on the DPE.

[Table 3-7](#) identifies the configuration tasks that you must perform to configure the home provisioning group redirection service on the DPE.

**Table 3-7 Home Provisioning Group Redirection Configuration**

Procedure	Refer to...
<p><b>1.</b> Configure the DPE to use the interface identified by the IP address for communication with other provisioning groups.</p> <p>If you do not configure the DPE to use this interface, the DPE always binds to the localhost.</p>	<p>The <b>interface ip <i>x.x.x.x</i>. pg-communication</b> command described in the <a href="#">Cisco Broadband Access Center 3.8 DPE CLI Reference</a>.</p>
<p><b>2.</b> Configure the cwmp-redirect service on the DPE.</p> <p>To enable the cwmp-redirect service, enter:</p> <pre>service cwmp-redirect 1 enable true</pre>	<p>The <b>service cwmp-redirect 1 enable</b> command described in the <a href="#">Cisco Broadband Access Center 3.8 DPE CLI Reference</a></p>

For information on CLI commands used for the cwmp-redirect service, see the [Cisco Broadband Access Center 3.8 DPE CLI Reference](#).





## CHAPTER 4

# CPE Management Overview

---

This chapter describes the management of customer premises equipment (CPE) by using the CPE WAN Management Protocol for Cisco Broadband Access Center (BAC).

This chapter includes the following sections:

- [CWMP Overview, page 4-1](#)
- [Cisco BAC Device Object Model, page 4-2](#)
- [Discovering CPE Parameters, page 4-4](#)
- [Multi-Instance Object Support, page 4-5](#)
- [Instruction Generation and Processing, page 4-14](#)
- [Device Deployment in Cisco BAC, page 4-16](#)
- [Initial Provisioning Flows, page 4-18](#)
- [Assigning Devices to Provisioning Groups, page 4-20](#)
- [Device Diagnostics, page 4-21](#)
- [Configuring SNMP Trap for CPEs, page 4-21](#)

## CWMP Overview

Cisco BAC communicates with CPE through the CPE WAN Management Protocol (CWMP) according to parameters described in the TR196, TR-069, and other related data model specifications. CWMP encompasses secure management of CPE, including:

- Autoconfiguration and dynamic service provisioning
- Firmware management
- Device diagnostics
- Performance and status monitoring

Cisco BAC supports devices based on the TR-069, TR-098, TR-104, TR-106, TR-181, and TR-196 standards. This support includes Ethernet and ADSL gateway devices, wireless gateways, VoIP ATAs, and other devices compliant with CWMP. This release also provides for runtime-extensible data models to support any upcoming data-model standards or any vendor-specific data models.

# Cisco BAC Device Object Model

The Cisco BAC device object model is crucial in controlling the configuration and firmware rules that are generated as instructions for the DPE to manage devices. This process occurs at the RDU, and is controlled through named attributes and relationships.

The main objects in the device object model are:

- IPDevice—Represents a network entity that requires provisioning.
- Owner ID—Represents an external identifier for a subscriber.
- Device Type—Represents the type of the device.
- ProvGroup—Represents a logical grouping of devices serviced by a specific set of DPEs.
- Class of Service—Represents the configuration profile to be assigned to a device.
- File—Serves as a container for files used in provisioning that include templates and firmware images.
- Group—Is a customer-specific mechanism for grouping devices.

Common among the various objects in the Cisco BAC device data model are:

- Name. For example, Gold Class of Service
- Attributes. For example, Device ID and a fully qualified domain name (FQDN)
- Relationships. For example, the relationship of a device to a Class of Service
- Properties. For example, a property which specifies that a device must be in a provisioning group.

See [Figure 4-1](#) for a description of the interaction between the various objects in the device data model.

**Figure 4-1** Device Object Model

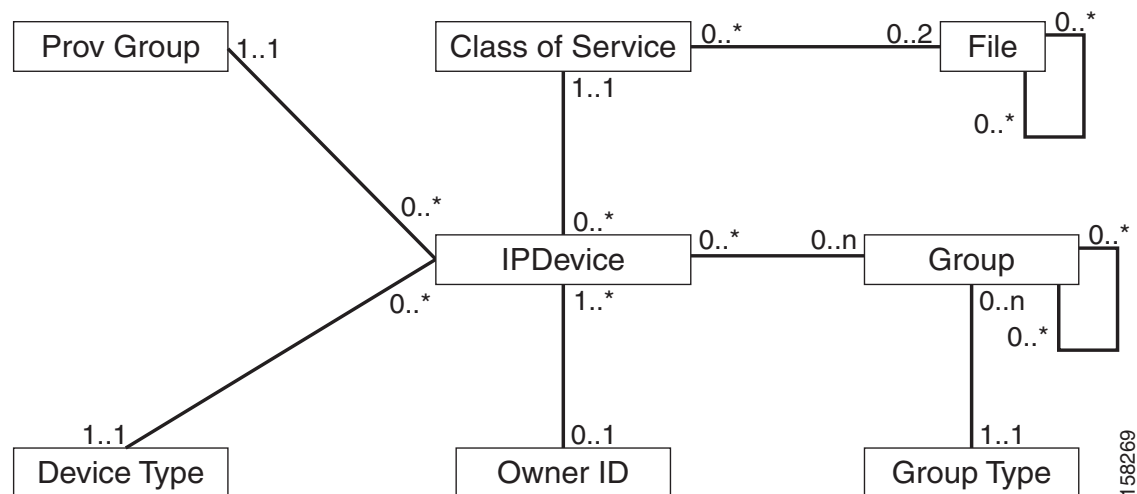

In the Cisco BAC device object model, the IPDevice is related to the Class of Service, the Provisioning Group, and the Device Type. The Class of Service is then related to the Configuration Template and the Firmware Rules Template. Files can be related to one another, such as the firmware rules template being related to the firmware image.

Table 4-1 describes the attributes and relationships unique to each object in the data model.

**Table 4-1 Device Object Relationships**

Object	Related to ...
<p><b>IP Device</b></p> <ul style="list-style-type: none"> <li>• Could be preregistered or unregistered (See <a href="#">Device Deployment in Cisco BAC, page 4-16</a>).</li> <li>• Attributes include Device ID (OUI-Serial) and FQDN</li> </ul>	<ul style="list-style-type: none"> <li>• Owner ID</li> <li>• Provisioning Group</li> <li>• Class of Service</li> <li>• Device Type</li> </ul>
<p><b>Owner ID</b></p> <ul style="list-style-type: none"> <li>• Is associated with devices and, therefore, cannot exist without a device related to it.</li> <li>• Enables grouping; for example, you can group all devices belonging to <i>Joe</i>.</li> </ul>	IP Device
<p><b>Device Type</b></p> <ul style="list-style-type: none"> <li>• Stores defaults common to all devices of a technology, specifically CWMP.</li> <li>• Enables grouping; for example, you can group all CWMP devices.</li> </ul>	IP Device
<p><b>File</b></p> <ul style="list-style-type: none"> <li>• Stores files used in provisioning; for example, configuration template and firmware rules template</li> </ul>	Class of Service
<p><b>Class of Service</b></p> <ul style="list-style-type: none"> <li>• Attributes include Type, Name, and Properties. (For details, see <a href="#">Class of Service, page 4-3</a>.)</li> </ul>	<ul style="list-style-type: none"> <li>• IP Device</li> <li>• File</li> <li>• Configuration Template (optional)</li> <li>• Firmware Rules Template (optional)</li> </ul>

### Class of Service

Class of Service is an RDU abstraction that represents the configuration to be handed to the device in the form of templates. It enables you to group devices into configuration sets, which are service levels or different packages that are to be provided to the CPE.

The different Classes of Service are:

- **Registered**—Specified by the user when the device is registered. This Class of Service is explicitly added to the device record using the application programming interface (API).
- **Selected**—Selected by the RDU for a device that, for one reason or another, cannot retain its registered Class of Service.
- **Related**—Related to the device by being registered, selected, or both.

If the selected Class of Service for a device is changed, the Instruction Generation Service regenerates instructions for the device configuration.

If the registered Class of Service for a device is changed, it regenerates instructions for the generated device configuration even if it is not the selected Class of Service, since it could impose a policy that would change the selected Class of Service.

Other concepts related to the device data model are:

- [Property Hierarchy, page 4-4](#)
- [Custom Properties, page 4-4](#)

## Property Hierarchy

While processing configuration templates for substitutable parameters, Cisco BAC searches objects for this property using a certain order called Property Hierarchy.

Cisco BAC properties allow you to access and store data in Cisco BAC using the API. Preprovisioned, discovered, and status data can be retrieved through the properties of corresponding objects, using the API. Properties also enable you to configure Cisco BAC at the appropriate level of granularity (from system level to device groups and to individual devices).

The Cisco BAC property hierarchy gives you the flexibility to define system-wide or service class defaults that can be overridden by individual devices.

Cisco BAC allows you to store any number of properties on objects in its data model. You can reference these properties in configuration templates or firmware rules. You can use properties in this property hierarchy:

1. Device
2. Group (priority is set through the Group Type, see [Managing Group Types, page 16-18](#))
3. Provisioning Group
4. Class of Service
5. Device Type
6. System Defaults

## Custom Properties

Custom properties allow for the definition of new properties, which can then be stored on any object via the API.

Custom properties are variable names defined in the RDU, and must not contain any spaces. The template parser works from bottom up when locating properties in the hierarchy and converts the template option syntax. For detailed information, see [Custom Properties, page 5-15](#).

## Discovering CPE Parameters

Cisco BAC is enabled to read CPE parameters using Remote Procedure Calls (RPCs) as defined in CWMP. This is made possible through the Data Synchronization Instruction. This instruction discovers data from the CPE device, reports it to the RDU, and keeps the RDU up-to-date when CPE device data changes.

This instruction can be used to keep the RDU up-to-date on such key parameters as the software version and the model name. These parameters may, in turn, be used to generate other instructions, such as configuration instructions specific to a given device type.

Table 4-2 lists the default parameters that Cisco BAC discovers.

**Table 4-2** Default Discovered Parameters

Parameter	Description
Inform.DeviceId.Manufacturer	Identifies the manufacturer of the CPE.
Inform.DeviceId.ManufacturerOUI	Identifies the unique identifier of the CPE manufacturer.
Inform.DeviceId.ProductClass	Identifies the product or class of product over which the manufacturer's <i>SerialNumber</i> parameter is unique.
InternetGatewayDevice.DeviceInfo.HardwareVersion	Identifies the hardware version of the CPE.
InternetGatewayDevice.DeviceInfo.SoftwareVersion	Identifies the software version currently installed on the CPE.
InternetGatewayDevice.DeviceInfo.ModelName	Identifies the model name of the CPE.
InternetGatewayDevice.ManagementServer.ParameterKey	Specifies the value of the <i>ParameterKey</i> from the most recent <i>SetParameterValues</i> , <i>AddObject</i> , or <i>DeleteObject</i> call from the server.

These parameters can be updated using the API (using the `/server/acs/discover/parameters` property) or via the administrator user interface (see [Discovering Data from Devices](#), page 12-11).



**Note**

Even if the device has a different root object, such as `Device`, instead of `InternetGatewayDevice`, the parameters are still discovered.

## Multi-Instance Object Support

In this release, the multi-instance object support introduces the ability to discover the multi-instance object parameters from the device without specifying the actual instance number. Multi-instance object support is available as an usability improvement in the following BAC modules to aid deployment:

- [Configuration Template](#)
- [Firmware Rules Template](#)
- [Parameter Discovery](#)
- [Display Live Data Operation](#)

This feature will be functional only when the RDU and all the DPEs are upgraded to Cisco BAC 3.8. To configure the configuration template and the firmware template with multi-instance objects the value of the newly introduced *templateVersion* attribute value should be 3.0.

## Configuration Template

Earlier to this release of BAC, the scope of configuration template represented only the possible set parameter values and set parameter attributes that could be performed. There was no mechanism to discover object names.

In this release, the template scope is extended to include the following:

- The ability to discover object names
- The ability to discover parameter values
- The ability to delete object instances
- The ability to add object instances

A new attribute sync-method is introduced in the configuration template. The sync-method instructs the configuration sync process to interact with the device to discover the object instances. For the discovered object instances the ACS has total control to configure the parameters available in the object's sub-tree. The following are the available sync-methods.

Sync-method	Description
discovered	If this condition is specified, BAC discovers the object instances based on the instance attribute value specified for the object instance.
replace-all	If this condition is specified, BAC first discovers the parameter value for the specified parameter name from all the object instances. For the discovered object instances the following operations are possible: <ul style="list-style-type: none"> <li>• If a matching object instance is found with the specified parameter value, it updates the object instance with the new parameter value.</li> <li>• If no matching instance is found, BAC creates an object instance with the new parameter value.</li> <li>• If an object instance is found with the different parameter value, that object instance is deleted.</li> </ul>
replace-augment	This operates same as replace-all, except that BAC retains the instances that does not match the parameters configured.
delete-all	If this condition is specified, BAC simply deletes all the available instances at that level.
delete	If this condition is specified, BAC deletes the instance that match the value specified in the instance attribute.

Any one of the following instance attribute must be mandatorily used with *discovered* and *delete* sync-method:

- all() - This option indicates BAC to discover all the instances
- last() - This option indicates BAC to discover the last instance
- compare(parameterName operation matchValue) - This option indicates BAC to discover the object instances in which the parameter and the value are in accordance with the operation.



**Note** Valid compare operators are: equals, equalsIgnoreCase, notEquals, lessThan, lessThanEquals, greaterThanEquals, greaterThan.



- Index - This option can be used for direct indexing and accepts a valid positive integer. This is the index into the returned instance names. For example, index value 1 returns the first instance.

In configuration template, the expression parameters in pre-requisites can also be configured with multi-instance object parameters, with any of the discovered options. For more information on prerequisites, see [Prerequisites, page 5-9](#).

#### Example 4-1 Multi-Instance Object Using replace-all in Configuration Template

The following example illustrates usage of multi-instance object using replace-all in configuration template:

```
<Configuration templateVersion="3.0">
  <ParameterDictionaries>
    <ParameterDictionary>tr196-cwmp-dictionary-v2.0.xml</ParameterDictionary>
  </ParameterDictionaries>
  <ObjectInstance name="Device">
    <ObjectInstance name="Services">
      <ObjectInstance name="FAPService">
        <ObjectInstance name="{i}" sync-method="discovered" instance="all()">
          <ObjectInstance name="CellConfig">
            <ObjectInstance name="UMTS">
              <ObjectInstance name="RAN">
                <ObjectInstance name="NeighborList">
                  <ObjectInstance name="IntraFreqCell"
sync-method="replace-all" primary-keys="PLMNID,LAC,RNCID">
                    <ObjectInstance name="{i}">
                      <Parameter>
                        <Name>RAC</Name>
                        <Value>10</Value>
                      </Parameter>
                      <Parameter>
                        <Name>PLMNID</Name>
                        <Value>VAR(name=FC-PLMN-ID,
defaultValue=123452)</Value>
                      </Parameter>
                      <Parameter>
                        <Name>LAC</Name>
                        <Value>65532</Value>
                      </Parameter>
                      <Parameter>
                        <Name>RNCID</Name>
                        <Value>18</Value>
                      </Parameter>
                    </ObjectInstance>
                  <ObjectInstance name=" " >
                    <Parameter>
                      <Name>RAC</Name>
                      <Value>11</Value>
                    </Parameter>
                    <Parameter>
                      <Name>PLMNID</Name>
                      <Value>123452</Value>
                    </Parameter>
                    <Parameter>
                      <Name>LAC</Name>
                      <Value>65533</Value>
                    </Parameter>
                    <Parameter>
                      <Name>RNCID</Name>
                      <Value>21</Value>
                    </Parameter>
                  </ObjectInstance>
                </ObjectInstance>
              </ObjectInstance>
            </ObjectInstance>
          </ObjectInstance>
        </ObjectInstance>
      </ObjectInstance>
    </ObjectInstance>
  </ObjectInstance>
</Configuration>
```



The behavior of BAC to push the above template configuration during configuration sync is explained below:

1. BAC discovers the instances in the object `Device.Services.FAPService`. by issuing `GetParameterNames` RPC with next level set to true.
2. Since `last()` method is used, it gets the last instance and discovers the instances in the next level by issuing `GetParameterNames` RPC for the parameter `Device.Services.FAPService.{last()}.REM.UMTS.GSM.Cell.{i}`. with next level set to true.
3. BAC performs `DeleteObject` one by one on all the instances returned.

#### **Example 4-3 Multi-Instance Object Using delete in Pre-requisites of Configuration Template**

The following example illustrates usage of multi-instance object using delete in pre-requisites of configuration template:

```
<Configuration templateVersion="3.0">
  <ParameterDictionaries>
    <ParameterDictionary>tr196-cwmp-dictionary.xml</ParameterDictionary>
  </ParameterDictionaries>
  <Prerequisites>
    <MaintenanceWindow>
      <StartTime>00:00:00</StartTime>
      <Duration>15:00</Duration>
    </MaintenanceWindow>
    <Expression>
      <ParameterName>Device.Services.FAPService.{i}.REM.UMTS.GSM.Cell.{i}.BSIC
      </ParameterName>
      <InstanceConfiguration>
        <Instance>
          <Path>Device.Services.FAPService.{i}.REM.UMTS.GSM.Cell.</Path>
          <Value>compare(LAC lessThanEquals 65534)</Value>
        </Instance>
        <Instance>
          <Path>Device.Services.FAPService.</Path>
          <Value>last()</Value>
        </Instance>
        <MatchCondition>OR</MatchCondition>
      </InstanceConfiguration>
      <Value>18</Value>
      <Operator>matchAllIgnoreCase</Operator>
    </Expression>
  </Prerequisites>
  <ObjectInstance name="Device">
  <ObjectInstance name="Services">
    <ObjectInstance name="FAPService">
      <ObjectInstance sync-method="discovered" instance="last() ">
        <ObjectInstance name="REM.UMTS.GSM.Cell" sync-method="delete" instance="2">
        </ObjectInstance>
      </ObjectInstance>
    </ObjectInstance>
  </ObjectInstance>
</Configuration>
```

The behavior of BAC to apply the above template configuration during configuration sync is explained below:

1. During configuration sync execution, BAC validates the time to ensure that the configuration sync falls in the maintenance window

2. Next, BAC validates the expression. Since the expression parameters are configured with multi-instance object parameters, BAC first discovers and identify the instances to evaluate the expression.
3. After the expression is evaluated to true, BAC discovers the instance for Device.Services.FAPService. by using GetParameterNames RPC with next level set to true.
4. To discover the multi-instance object at next level, it issues GetParameterNames RPC for Device.Services.FAPService.{last()}.REM.UMTS.GSM.Cell.
5. Finally, BAC issues DeleteObject Message for the instance in the second index in the returned array.

#### Example 4-4 Invalid Example-Adding a Template Without Instance Attribute

The following example illustrates adding a template without the instance attribute.

```
<tc:Template
  xmlns:xsi="http://www.w3.org/2001/XMLSchema-instance"
  xmlns:tc="urn:com:cisco:bac:common-template"
  xmlns="urn:com:cisco:bac:cwmp-template"
  xsi:schemaLocation="urn:com:cisco:bac:common-template CommonTemplateConstructs.xsd">
  <Configuration templateVersion="3.0">
    <ParameterDictionaries>
      <ParameterDictionary>tr196-parameter-dictionary.xml</ParameterDictionary>
    </ParameterDictionaries>
    <ObjectInstance name="Device">
      <ObjectInstance name="Services">
        <ObjectInstance name="FAPService">
          <ObjectInstance name="{i}" sync-method="discovered"
instance="compare(DeviceType equals CWMP1)">
            <ObjectInstance name="AccessMgmt">
              <ObjectInstance name="MemberDetail">
                <ObjectInstance name="{i}" sync-method="discovered">
                  <Parameter>
                    <Name>Enable</Name>
                    <Value>>true</Value>
                  </Parameter>
                  <Parameter>
                    <Name>IMSI</Name>
                    <Value>310410268739757</Value>
                  </Parameter>
                </ObjectInstance>
              </ObjectInstance>
            </ObjectInstance>
          </ObjectInstance>
        </ObjectInstance>
      </ObjectInstance>
    </ObjectInstance>
  </Configuration>
</tc:Template>
```

When this template is added through API or admin UI, the following validation error is displayed:

```
Error: Template file validation has failed with the following error.
[Missing instance attribute for the sync-method 'discovered']
```

## Firmware Rules Template

Earlier to this release, the expression support in the firmware rules was not flexible enough to handle multi-instance objects in the parameter names. This enhancement is extended to firmware rules template where BAC discovers the multi-instance parameters to evaluate the expression.

You can specify multi-instance parameter name in the expression, and the discover mechanism of these objects can be configured using the newly introduced template element InstanceConfiguration.

#### Example 4-5 Multi-Instance Object in Expression

The following example illustrates usage of multi-instance object in expression:

```
<Expression>
  <ParameterName>Device.Services.FAPService.{i}.REM.GSM.Cell.{i}.LAC
</ParameterName>
  <InstanceConfiguration>
    <Instance>
      <Path>Device.Services.FAPService</ Path>
      <Value>last()</Value >
    </Instance>
    <Instance>
      <Path>Device.Services.FAPService.{i}.REM.GSM.Cell</ Path>
      <Value>compare(PLMNID equals 123456)</Value >
    </Instance>
    <MatchCondition>OR</MatchCondition>
  </InstanceConfiguration>
  <Value>4660</Value>
  <Operator>match</Operator>
</Expression>
```

In the above expression the multi-instance object parameter name Device.Services.FAPService.{i}.REM.GSM.Cell.{i}.LAC is used. The InstanceConfiguration discovers the multi-instance object instances Device.Services.FAPService.{i} and Device.Services.FAPService.{i}.REM.GSM.Cell.{i}. The Value tag supports all the available instance discover methods like all(), last(), compare(parameterName operation matchValue) and index. The new tag MatchCondition is available in the instance configuration, which is used to evaluate the multiple expressions only in case there are multiple instances discovered.

#### Example 4-6 Multi-Instance Object in Firmware Rule Template

The following example illustrates usage of multi-instance object in firmware rule template:

```
<tc:Template
  xmlns:xsi="http://www.w3.org/2001/XMLSchema-instance"
  xmlns:tc="urn:com:cisco:bac:common-template"
  xmlns="urn:com:cisco:bac:firmware-template"
  xsi:schemaLocation="urn:com:cisco:bac:common-template CommonTemplateConstructs.xsd">

  <FirmwareTemplate templateVersion="3.0">
    <ParameterDictionaries>
      <ParameterDictionary>tr196-cwmp-dictionary-v2.0.xml</ParameterDictionary>
    </ParameterDictionaries>

    <Prerequisites>
      <MaintenanceWindow>
        <StartTime>00:00:00</StartTime>
        <Duration>15:00</Duration>
      </MaintenanceWindow>

      <Expression>

<ParameterName>Device.Services.FAPService.{i}.REM.UMTS.GSM.Cell.{i}.BSIC</ParameterName>
      <InstanceConfiguration>
        <Instance>
          <Path>Device.Services.FAPService.{i}.REM.UMTS.GSM.Cell.</Path>
          <Value>compare(LAC lessThanEquals 65534)</Value>
```

```

        </Instance>
        <Instance>
            <Path>Device.Services.FAPService.</Path>
            <Value>last()</Value>
        </Instance>
        <MatchCondition>OR</MatchCondition>
    </InstanceConfiguration>
    <Value>18</Value>
    <Operator>matchAllIgnoreCase</Operator>
</Expression>
<Expression>

<ParameterName>Device.Services.FAPService.{i}.REM.UMTS.GSM.Cell.{i}.PLMNID</ParameterName>
    <InstanceConfiguration>
        <Instance>
            <Path>Device.Services.FAPService.</Path>
            <Value>all()</Value>
        </Instance>
        <Instance>
            <Path>Device.Services.FAPService.{i}.REM.UMTS.GSM.Cell.</Path>
            <Value>2</Value>
        </Instance>
        <MatchCondition>OR</MatchCondition>
    </InstanceConfiguration>
    <Value>123451</Value>
    <Value>123452</Value>
    <Operator>matchIgnoreCase</Operator>
</Expression>
</Prerequisites>

    <FirmwareRule name="FAPRule">
    <Expression>
        <InformParameterName>Inform.EventCode</InformParameterName>
        <Value>1 BOOT</Value>
        <Value>2 PERIODIC</Value>
        <Operator>match</Operator>
    </Expression>

    <Expression>

<ParameterName>Device.Services.FAPService.{i}.REM.UMTS.GSM.Cell.{i}.BSIC</ParameterName>
    <InstanceConfiguration>
        <Instance>
            <Path>Device.Services.FAPService.{i}.REM.UMTS.GSM.Cell.</Path>
            <Value>1</Value>
        </Instance>
        <Instance>
            <Path>Device.Services.FAPService.</Path>
            <Value>compare(DeviceType equalsIgnoreCase fap)</Value>
        </Instance>
        <MatchCondition>OR</MatchCondition>
    </InstanceConfiguration>
    <Value>18</Value>
    <Operator>matchAllIgnoreCase</Operator>
</Expression>

    <InternalFirmwareFile>
        <FileName>sample-firmware-image.bin</FileName>
        <DeliveryTransport>service http 1</DeliveryTransport>
    </InternalFirmwareFile>
    </FirmwareRule>
</FirmwareTemplate>
</tc:Template>

```

## Parameter Discovery

Multi-instance object parameters can now be specified in the data discovery. This support is extended for preregistered and unregistered devices.

### Preregistered Devices

For preregistered devices, the multi-instance object parameters can be configured in the parameter `IPDeviceKeys.CWMP_CUSTOM_DISCOVER_PARAMETERS` as in the example below:

```
/IPDevice/custom/discover/parameters= Device.Services.FAPService. {i}.REM.GSM.Cell. {i}.LAC,
Device.Services.FAPService. {i}.REM.GSM.Cell.1.PLMNID
```

### Unregistered Devices

For unregistered devices, the multi-instance object parameters can be configured in the parameter `ServerDefaultsKeys.CWMP_UNKNOWN_CPE_PARAMETERS` as in the example below:

```
/server/acs/unknown/parametersToRetrieve=
Device.Services.FAPService. {i}.REM.GSM.Cell. {i}.LAC,
Device.Services.FAPService. {i}.REM.GSM.Cell.1.PLMNID
```

## Display Live Data Operation

The device operation enables you to view live device parameter values. The parameters retrieved from the device are selected from a Parameter List file, which is an XML file that details all the parameters.

If the multi-instance object parameters are configured in the Parameter List XML file, the device operation retrieves the parameter values from all the available instances in the device.

The following example illustrates the usage of multi-instance object support to retrieve live device data.

```
<ParameterList xmlns:xsi="http://www.w3.org/2001/XMLSchema-instance"
xsi:noNamespaceSchemaLocation="ParameterListSchema.xsd">
  <ParameterDictionaries>
    <ParameterDictionary>tr196-cwmp-dictionary-v2.0.xml</ParameterDictionary>
  </ParameterDictionaries>
  <Parameter>
    <Name> Device.Services.FAPService. {i}.REM.GSM.Cell. {i}.LAC</Name>
  </Parameter>
  <Parameter>
    <Name> Device.Services.FAPService. {i}.REM.GSM.Cell.1.PLMNID </Name>
  </Parameter>
  <Parameter>
    <Name>Device.Services.FAPService. {i}.REM.UMTS.GSM.CellNumberOfEntries</Name>
  </Parameter>
</ParameterList>
```

## Instance Sorting

In all the operations, when selecting the instances based on the instance configuration, you sort the list of instances returned in `GetParameterNames` RPC call. The discovered object instances can be sorted when the property `ProvGroupKeys.ENABLE_INSTANCE_SORTING (/provGroup/enable/instanceSorting)` is enabled.

This property can be configured at the Provisioning Group level in the object hierarchy. For details, see [Provisioning Group Configuration Workflow, page 3-8](#).

# Instruction Generation and Processing

Instruction generation is the process of generating specific instruction sets for CWMP devices. By using technology extensions, through which device technologies are incorporated into Cisco BAC, device details are combined with provisioning rules to produce instruction sets appropriate to the CPE. These instructions are then forwarded to the DPEs in the device's provisioning group and cached there.

The scriptable extensions are also supported in Cisco BAC. The extension points are defined in DPE for running the java based extension scripts. These scripts are executed in DPE, whenever the device establishes connection with the DPE. The extension scripts are added in the RDU database and forwarded to the DPE cache. For more information on scriptable extension service, see [Scripting Framework, page 18-1](#).

When a device is activated in a Cisco BAC deployment, it initiates contact with the Cisco BAC server. After contact is established, the device's preconfigured policy, based on configuration templates or firmware rules templates associated with the device, determine the management actions undertaken by the DPE.

This preconfigured policy determines the device's level of service, also known as Class of Service. Device configurations can include customer-required provisioning information, such as authentication information, periodic inform rate, and Class of Service. This authoritative provisioning information for the device is forwarded to DPEs from the RDU as device configuration instructions.

Instructions are logical operations which the DPE autoconfiguration server (ACS) performs for a specific device. The instructions may map directly into a CWMP remote procedure call (RPC), for example, `GetParameterValues`; or, they may combine additional logic with multiple CWMP RPCs, such as firmware rules.

IGS could be controlled using the new API property, `ApiCommandKeys.IGS_ENABLE`. This property determines whether IGS should be triggered or not. The API command uses this property to control the regeneration of device configuration being affected by other API commands.

When this property is set to `False` in the map of associated properties of an API command, the command skips the regeneration of the configuration process and it returns immediately with a warning message. The API commands affected by this property are:

- `replaceFile`
- `changeClassOfServiceProperties`
- `changeProvGroupProperties`
- `changeNodeProperties`
- `changeDefaults`

For the list of other API commands see [Non-concurrent Commands, page 19-2](#).

The RDU requests that instructions be processed, by passing "InstructionRecords" to the DPE. The DPE server then converts these "InstructionRecords" to "Instructions", and returns the results to the RDU as "InstructionResponseRecords".

Cisco BAC generates instructions through:

- The Instruction Generation Extension—Generates "InstructionRecords" for a single device.
- The Instruction Generation Service—Generates "InstructionRecords" for more than one device.

You can access statistics from the Instruction Generation Service from the administrator user interface at **Servers > RDU > View Regional Distribution Unit Details**.

Among the various instructions that the RDU generates are:



- **Data Synchronization Instruction (DataSyncRecord)**—Keeps the RDU up-to-date on various CPE parameters, such as the software version and the model name. These parameters may, in turn, be used in generating other instructions, such as configuration instructions that are specific to a given device type.

Some parameters are checked on every connection, while others are checked only when a change in the firmware version occurs. For details, see [Discovering Data from Devices](#), page 12-11.

- **Routable IP Address Instruction (RoutableIPAddressRecord)**—Discovers if a particular device is reachable, enabling the DPE to create a TCP connection with a device in order to service a connection request. The instruction retrieves the WAN IP address for the device, PPP or DHCP, and compares it with the source IP address. If the IP addresses are different, the instruction updates the RDU.
- **Firmware Rules Instruction (FirmwareRulesRecord)**—Determines the firmware image to be downloaded to a device. The firmware image files are associated to groups of devices by a firmware rules template.

Cisco BAC uses the rules in the associated template to evaluate the firmware to be downloaded to the CPE. This instruction takes effect only if the device has been associated with a firmware rules template.

- **Configuration Synchronization Instruction (ConfigSyncRecord)**—Triggers a synchronization of the CPE configuration that is stored in the DPE cache. This instruction comes into effect only if the device has been associated with a configuration template. The process of configuration synchronization is explained in the subsequent section.

When the Signed Configuration feature is enabled, the RDU parses the `ToBeSigned` tag specified in the configuration template and sets the corresponding value on the CWMP parameter object.

By default, the `ToBeSigned` flag on the CWMP parameter object is set to `False`. For more information on Signed Configuration, see [Signed Configuration for Devices](#), page 13-20.

## Device Configuration Synchronization

During the process of CPE configuration synchronization, a device's configuration is automatically synchronized based on the configuration template associated with the device's Class of Service object. The process of synchronizing the CPE configuration according to the `ConfigSync` instruction stored in the DPE for this device is called Configuration Synchronization.

As part of this process, the DPE configures all parameters values and attributes found in the configuration template associated with a device through its Class of Service, so that:

- Notifications reflect those configured in the configuration template. For more information on Notifications, see [Notification](#), page 5-8.
- Access control for all parameters reflects that configured in the configuration template. For more information on access control, see [Access Control](#), page 5-9.

CPE configuration is associated with a unique configuration key. This configuration key is saved in the DPE database, and is used as the *ParameterKey* parameter in RPCs that are forwarded to the CPE.

Every time the CPE establishes a connection with the DPE, the device reports the value for the *ParameterKey*—in the form of a configuration revision number—by using the Inform message that the device forwards to the DPE. The DPE compares this value with the one in its cache for the particular device. A mismatch of the values, triggers the DPE and the device synchronization process.

During the process of configuration synchronization:

1. The DPE receives a *ParameterKey* from the device. If the value of this *ParameterKey* matches the one stored in the DPE, no synchronization is initiated. If the *ParameterKey* values differs, the synchronization process continues.
2. If access control is set in its configuration, the DPE sets the *AccessList* parameter to ACS-only. The access control feature is, by default, enabled. For more information on access control, see [Access Control, page 5-9](#).
3. If you enable the notification feature, the DPE sets notification attributes as specified in the device configuration. Notifications are, by default, enabled. For more information on notifications, see [Notification, page 5-8](#).
4. After the DPE configures the parameter values on the device according to the template, it sets a new configuration revision number in the *ParameterKey* argument. This revision number is used to determine if the device configuration is synchronized the next time the device and the DPE establish a connection.

If the device connection with the DPE times out during the synchronization process, the CPE attempts to reconnect to the DPE.

In this scenario, the value of the *ParameterKey* in the Inform message remains the same, because only a successful synchronization process changes the *ParameterKey* value. When the CPE reconnects to the DPE, the DPE initiates another round of synchronization with the original *ParameterKey* value.

5. The synchronization process ends with the DPE forwarding the new value for the *ParameterKey* attribute in its last update to the CPE.

In some situations, you must update the device even if the *ParameterKey* on the DPE matches the one on the device.

To force a configuration synchronization:

- 
- Step 1** From the **Devices** page, locate the device whose configuration you want to synchronize.
  - Step 2** Click the **Operations** icon () corresponding to the device.  
The Device Operations page appears.
  - Step 3** From the drop-down list under Perform Device Operation, select Force Configuration Synchronization.
  - Step 4** Click **Submit**.  
The device configuration is synchronized with the DPE.
- 

## Device Deployment in Cisco BAC

A Cisco BAC deployment is divided into provisioning groups, with each provisioning group responsible only for a subset of the devices. All services provided by the provisioning group are implemented to provide fault tolerance.



**Note** A key principle of device management is that the RDU does not directly communicate with devices. All device interactions are delegated to DPEs in the provisioning group to which the device belongs.

Cisco BAC provides two device deployment options, which can also be used in combination:

- Preregistered—The device record is added to the RDU before the device makes initial contact with the DPE, also known as the ACS.
- Unregistered—The device makes contact with the DPE, before the device record is added to the RDU.

## Preregistered Devices

In this scenario, device data is preprovisioned into Cisco BAC, and the device is associated with a specific Class of Service. The Class of Service can correspond to a service that the subscriber registered for or a default configuration.

A preregistered device is preconfigured with certain parameters specific to the service provider. These parameters are typically “burnt-in” as factory defaults.



### Note

---

If you reset the device to factory defaults, the settings on the device revert to the preburnt configuration, and the device may go through the reconfiguration process.

---

Device data is preregistered in Cisco BAC. This is typically done through the API; alternatively, it can be done using the administrator user interface.

Preconfiguration involves three important issues:

- The device must be able to establish network connectivity. For DSL devices, this typically involves using auto-detection of ATM PVC and using PPP for authentication. The IP address is obtained using PPP or using DHCP. Other devices typically use an existing internet connection and local DHCP for address assignment.
- CPE must contact the configuration servers of the appropriate service provider; in other words, the CPE must know the ACS URL. The ACS URL can be preburnt into the device (assigned) or discovered using DHCP from the WAN side.
- The service provider must be able to associate the CPE with a specific subscriber. This process is typically accomplished by the Operations Support Systems (OSS) application responsible for subscriber registration. Cisco BAC is updated with appropriate data to provision device configuration.

## Unregistered Devices

In this scenario, no device data is prepopulated into Cisco BAC. Device data is added to Cisco BAC only when the device first contacts a Cisco BAC server.

Cisco BAC allows unregistered devices (with no preconfigured parameters) to appear on a network and gain default access. However, the lack of support for preregistering device data into Cisco BAC restricts authentication options for unregistered devices, to using mechanisms based on certificates as opposed to shared secrets.

The lack of preregistered data also means that Cisco BAC has to dynamically classify the devices and determine the default configuration of a device.

**Note**

With no preregistered device data available, the chances of a Denial of Service attack increase, as unknown devices are not authenticated.

## Initial Provisioning Flows

This section describes the configuration workflow for a device, which differs based on whether a device is preregistered or unregistered.

Figure 4-2 shows a common initial configuration flow.

**Figure 4-2** Initial CPE Configuration Workflow

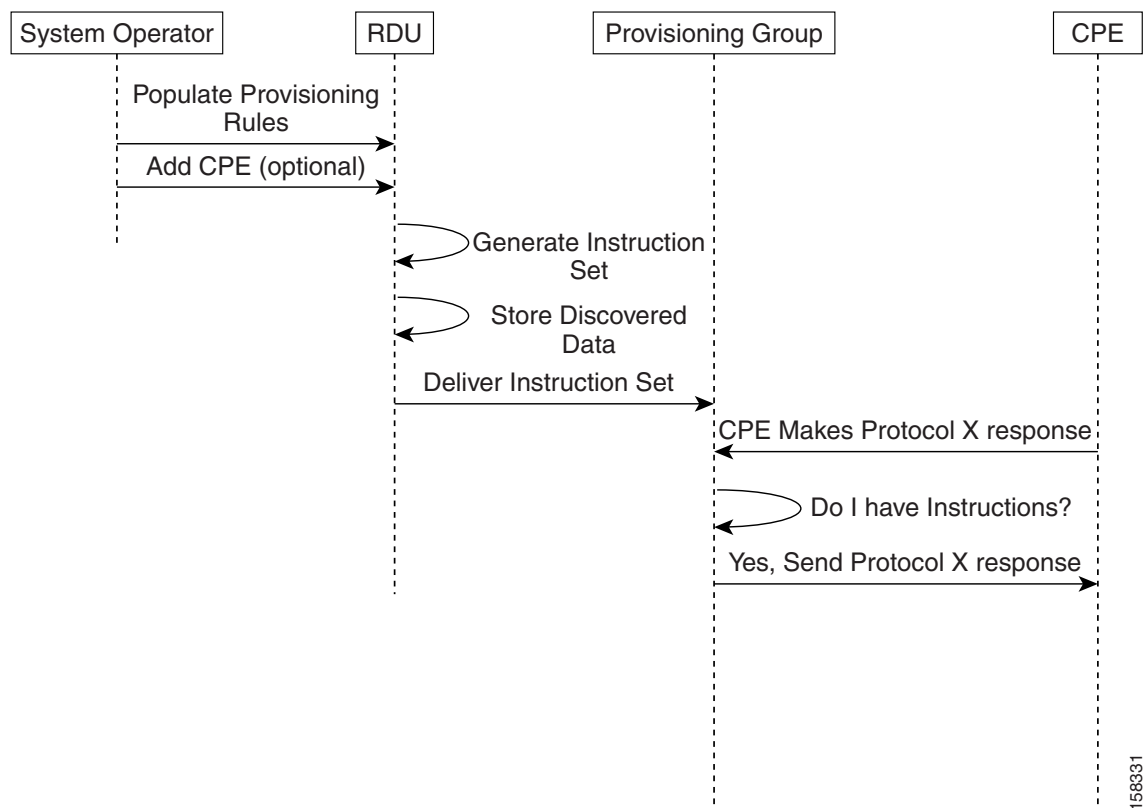

158331

## For Preregistered Devices

- From the Cisco BAC API, the RDU is populated with specifically defined configurations and rules for various types of devices. The device is preconfigured and associated with a Class of Service.
- The preregistered device finds its provisioning group by contacting the Cisco BAC server at a preconfigured URL, and initiates autoprovisioning with provisioning group servers (DPEs).
- The RDU generates instructions appropriate for the device. The resulting device instructions direct DPE responses to various CPE protocol events, such as a TR-069 Inform and an HTTP file request.

- d. The device instruction set is forwarded to the DPE and cached there. Now, the DPE is programmed to handle subsequent CPE protocol interactions for this device autonomously from the RDU. After the device is added to the network and a configuration is generated for the device, the device boots to allow the DPE to begin its interactions with the preregistered device.
- e. During interactions with the device, additional information can be discovered and forwarded to the RDU. In this case, the RDU may decide to generate new instructions and forward them to all DPEs.

## For Unregistered Devices

- a. From the Cisco BAC API, the RDU is populated with specifically defined configurations and rules for various device types.
- b. During bootup, when the DPE receives a device request, it performs a local search for instructions cached for the specific CPE. Because the CPE has never previously contacted the DPE and because device data was not preregistered into Cisco BAC, no instructions are found.

The DPE then packs all relevant CPE information into an “instruction set” generation request, and forwards the request to the RDU. At the same time, the device request is rejected, forcing the device to retry. Also, the device receives the configured SOAP request/response extensions from DPE cache and the extensions are executed for the device. Unknown device extensions are configured in CWMP defaults and are sent to DPE cache. For more information on configuring extensions for unknown devices, see [Configuring Extensions for Unknown Devices, page 18-4](#).

- c. The RDU generates instructions appropriate for the CPE and distributes it to all DPEs within the device’s provisioning group. The resulting CPE instructions direct DPE responses to various CPE protocol events, such as a TR-069 Inform, and an HTTP file request.
- d. The CPE is now registered and the details are stored in the RDU. The RDU captures the CPE registration time. The property to retrieve the registered time is `/IPDevice/registeredTime`. This property value can be obtained through the API `IPDevice.getDetails()` call.
- e. The device instruction set is delivered to the DPE and cached there. Now, the DPE is programmed to handle all subsequent CPE protocol interactions for this device autonomously from the RDU.

The following parameters are discovered by Cisco BAC for unknown devices:

- `Whether the device IP address is routable or NAT’ed.`
- `Inform.DeviceId.Manufacturer.`
- `Inform.DeviceId.ManufacturerOUI.`
- `Inform.DeviceId.ProductClass.`
- `InternetGatewayDevice.DeviceInfo.HardwareVersion.`
- `InternetGatewayDevice.DeviceInfo.SoftwareVersion.`
- `InternetGatewayDevice.DeviceInfo.ModelName.`
- `InternetGatewayDevice.ManagementServer.ParameterKey.`



---

**Note** You can change the default list of discovered parameters. See [Discovering Data from Devices, page 12-11](#).

---

- f. The device then reconnects, and receives the configuration instructions generated for it from the RDU and cached at the DPE.

# Assigning Devices to Provisioning Groups

Devices can be assigned to a provisioning group in three ways: explicitly, automatically, or using a combination of both.

## Explicit Assignment

You can explicitly assign a device to a provisioning group. After devices appear in the default provisioning group, the provisioning system may, using the API, assign the device to a new provisioning group. On next contact with the device, Cisco BAC redirects the device.

To set the device to contact the assigned provisioning group, change the URL of the Cisco BAC server to the URL of the provisioning group URL. The Cisco BAC server URL is stored, and from then on, the device contacts Cisco BAC at the new address.

To move the device from one provisioning group to another, change the home provisioning group of the device using the API or the administrator user interface. Each provisioning group has a URL associated with it. To facilitate the move, on next contact, the ACS URL on the device is changed to the new provisioning group URL.

## Automatic Membership

If a device has not been explicitly assigned to a provisioning group, the device stays in the provisioning group in which it is brought up. This allows a network-directed assignment of CPE to the provisioning groups. You can use the automatic membership feature for roaming devices, enabling the local provisioning group to service these devices when they are moved.

When a device appears in a new provisioning group, it is automatically assigned to the new provisioning group, and the device data is purged from the old provisioning group. This process involves communicating with the RDU, which, in turn, updates the DPEs in the old and new provisioning groups. This is an expensive process; therefore, take care to prevent a large number of device migrations.

Automatic assignment of a device to a provisioning group works only if the DPEs are configured to allow unknown (unregistered) devices that do not show up in any provisioning group.

If the devices do show up in another provisioning group and the provisioning group is configured to allow access for unknown devices, Cisco BAC automatically assigns the device to the provisioning group.

For details on how to configure access for unknown devices, see the [Cisco Broadband Access Center 3.8 DPE CLI Reference](#).

## Combined Approach

You can explicitly assign devices and allow automatic membership of devices to a provisioning group. For example, a generic unregistered device that appears on the network in a provisioning group is automatically assigned to it. Subsequently, the OSS explicitly assigns the device to another provisioning group by using the API.

## Device Diagnostics

CWMP supports device troubleshooting and diagnostics features that you use to focus on a single device and collect diagnostics information for further analysis. This feature enables you to query devices for any data, including:

- Configuration
- Live statistics
- Fault indications
- Log file
- Diagnostics results

Device diagnostics is made possible in Cisco BAC through a set of operations that can be run on the device. These include:

- Reboot—Reboots the device. This reboot is primarily intended for diagnostic purposes.
- Request Connection—Initiates a connection request with Cisco BAC.
- Factory Reset—Resets a preregistered device settings to its original factory settings, to before a subscriber-specific configuration was burnt in.
- Display Live Data—Views device parameters directly from a device. You can define the parameters you want to appear.
- Ping Diagnostic—Enables you to perform an IP ping diagnostics test from the device to any host.
- Force Firmware Upgrade—Forces a CPE to update its firmware.
- Force Configuration Synchronization—Enables you to force an individual CPE to synchronize its configuration.

For details on performing these device operations, see [Performing Operations on Devices, page 16-14](#).

Cisco BAC also provides the following features to help troubleshooting:

- Device History—Provides a detailed history of significant events that occur in a device provisioning lifecycle. See [Device History, page 8-1](#).
- Device Faults—Detects devices with recurring faults, which can cause bottlenecks and affect network performance. See [Device Faults, page 8-6](#).
- Device Troubleshooting—Provides detailed records of device interactions with Cisco BAC servers for a set of devices that are designated for such troubleshooting. See [Device Troubleshooting, page 8-9](#).
- Performance Statistics—Provides detailed performance statistics that are related to system performance across major components. It also provides an analysis of the statistical data to aid troubleshooting. See [Monitoring Performance Statistics, page 11-14](#).

## Configuring SNMP Trap for CPEs

The fault management module of Cisco BAC facilitates CPEs to raise alarms and send events when any fault occurs. The fault management module can be enhanced to support the SNMP trap facility. With the SNMP trap facility, DPE receives the events from the CPEs and converts them into SNMP traps. DPE further sends these SNMP traps to the trap receiver.

The following components are configured in Cisco BAC for SNMP Trap facility:

- RDU, see [Configuration at RDU Level, page 4-22](#)
- DPE and Trap Receiver, see [Configuration at DPE Level, page 4-22](#)
- Device, see [Configuration at Device Level, page 4-23](#)

### Configuration at RDU Level

To configure RDU for SNMP trap facility:

---

**Step 1** Create or update the BAC configuration template to support expedited and queued alarms.

The following parameters must be set in the configuration template:

- For expedited alarms:
  - FAPService.{i}.FaultMgmt.SupportedAlarm.{i}.ReportingMechanism=0 {Expedited}
  - FAPService.{i}.FaultMgmt.ExpeditedEvent=Active
- For Queued alarms
  - FAPService.{i}.FaultMgmt.SupportedAlarm.{i}.ReportingMechanism=1 {Queued}
  - FAPService.{i}.FaultMgmt.QueuedEvent=Active

For information on how to author configuration template, see [Authoring Configuration Templates, page 5-14](#).

**Step 2** Add this configuration template to the RDU database:

- a. Log into the Cisco BAC admin UI.
- b. Choose **Configuration** on the primary navigation bar.
- c. Choose **Files** on the secondary navigation bar. The View Files page appears.
- d. Click **Add**.  
The Add Files page appears.
- e. Choose **Configuration Template** from the File Type drop-down list.
- f. Browse for the Source File Name.
- g. Add the configuration template name in the File Name field.
- h. Click **Submit**.

**Step 3** Associate this configuration template with the required Class of Service. For details, see [Configuring the Class of Service, page 17-1](#).

---

### Configuration at DPE Level

To configure DPE for SNMP trap facility:

---

**Step 1** Configure the SNMP alarm property values in the DPE. The following alarm property values must be configured in the DPE to support SNMP trap:

- AlarmIdentifier
- AlarmRaisedTime
- AlarmChangedTime



- ManagedObjectInstance
- EventType
- ProbableCause
- SpecificProblem
- PerceivedSeverity
- AdditionalText
- AdditionalInformation

These SNMP alarm property values can be configured in `dpe.properties` file through DPE CLI. For details on DPE CLI, see [Cisco Broadband Access Center 3.8 DPE CLI Reference](#).

- Step 2** Customize the `/cpeAlarm/alarmParams` property in `dpe.properties` file to include SNMP alarm property values. The SNMP alarm property values configured for this property are seen in the SNMP traps.

The default setting for `/cpeAlarm/alarmParams` property is:

```
/cpeAlarm/alarmParams=EventTime,AlarmIdentifier,EventType,ProbableCause,PerceivedSeverity
```

- Step 3** Configure the trap receiver to receive the SNMP traps from the DPE. The trap receiver is added as SNMP host with the required community and listening port. For information on how to add SNMP host and community, see [Using the snmpAgentCfgUtil.sh Tool, page 11-6](#).



**Note** You can configure multiple trap receivers to receive SNMP traps from the CPEs.

### Configuration at Device Level

To configure the device for SNMP trap facility:

- Step 1** Modify the device property hierarchy to include the following properties:

- `/IPDevice/cpeAlarmTable`
- `/IPDevice/cpeAlarm/prefixEID`
- `/IPDevice/cpeAlarm/prefixCustomProp`

[Table 4-3](#) provides the significance of these properties along with the possible and default values.

**Table 4-3 Properties - SNMP Trap Facility**

Property	Possible values	Default Values	Description
<code>/IPDevice/cpeAlarmTable</code>	None/Queued/Expedited	None	None – BAC will not process any alarms in the inform. Queued – BAC will fetch all the alarms from Queued alarm table in the inform and send traps. Expedited – BAC will fetch alarms from Expedited alarm table in the inform and send traps.

**Table 4-3 Properties - SNMP Trap Facility (continued)**

Property	Possible values	Default Values	Description
/IPDevice/cpeAlarm/prefixEID	True/False	False	If set to true, then EID will be prefixed with ManagedObject Instance and AlarmIdentifier.
/IPDevice/cpeAlarm/prefixEID	Any Custom Property	-	If set, then the custom property will be prefixed with the ManagedObject Instance in the SNMP trap.

For details on how to add these properties in the device property hierarchy, see [Modifying Device Records](#), page 16-11.

- Step 2** Configure these properties to be available in `/IPDevice/properties/available/pg`.
- Step 3** Perform a force synchronization of the device with the DPE to update the device configuration. For details, see [Forcing a Configuration Synchronization](#), page 16-17.
- Step 4** Reboot the device and verify if the trap receiver receives the SNMP traps from the DPE.

The SNMP trap consists of the alarm property values. [Table 4-4](#) describes the OIDs (Object Identifiers) that are used in device MIB for these SNMP alarm property values.

**Table 4-4 OID mapping**

OID	.FaultMgmt.ExpeditedEvent.{i}.	.FaultMgmt.QueuedEvent.{i}.
cenAlarmInstanceID	AlarmIdentifier	AlarmIdentifier
cenAlarmTimestamp	EventTime	EventTime
cenAlarmManagedObject Class	ManagedObjectInstance	ManagedObjectInstance
cenAlarmDescription	EventType	EventType
cenUserMessage1	ProbableCause	ProbableCause
cenUserMessage2	SpecificProblem	SpecificProblem
cenAlarmSeverity/cenAlarmSeverityDefinition	PerceivedSeverity	PerceivedSeverity
cenUserMessage3	AdditionalText	AdditionalText
cenUserMessage3	AdditionalInformation	AdditionalInformation
cenAlarmStatusDefinition	NotificationType	NotificationType
cenAlarmType	unknown(1), direct(2), indirect(3), mixed(4)	unknown(1), direct(2), indirect(3), mixed(4)
cenAlarmServerAddress	DPE address	DPE address



## CHAPTER 5

# Configuration Templates Management

---

This chapter details the templates that Cisco Broadband Access Center (BAC) supports for device configuration and device management.

This chapter includes the following sections:

- [Overview, page 5-1](#)
- [Features of Cisco BAC Templates, page 5-4](#)
- [Authoring Configuration Templates, page 5-14](#)
- [Using the Configuration Utility, page 5-22](#)

## Overview

Cisco BAC provides an extensible template-based mechanism to assign configurations for devices that are compliant with the CPE WAN Management Protocol (CWMP). This template-processing mechanism simplifies configuration management, enabling customized configurations for millions of customer premises equipment (CPE) by using a small number of templates.

The result of processing a template is an instruction, which is forwarded to the DPEs in a device's provisioning group. This instruction contains all the necessary information for the DPE to configure the device.

Before attempting to create your own template file, familiarize yourself with information on:

- Parameter dictionaries (see [Parameter Dictionaries, page 7-1](#))
- Firmware templates (see [Firmware Management, page 6-1](#))

By using Cisco BAC templates, you can create a template file in an easily readable format, and edit it quickly and simply. You must add template files to the RDU by using the administrator user interface or the API, before any Class of Service can reference it.

Cisco BAC templates are XML documents written according to a published schema. When instructions are generated for a given device at the RDU for distribution to DPEs, a common template processor retrieves a template by using the device's Class of Service object.

It then evaluates the template values, such as Includes and Conditionals, and substitutes template variables with their values. The resulting output is an XML object which represents a processed template.

The syntax and content of the processed configuration template is validated when it is added to the Cisco BAC system, ensuring that the XML template is well-formed. This validation also ensures that parameter names and values are consistent with definitions in the parameter dictionary, an XML file that defines the supported objects and parameters. (See [Parameter Dictionaries](#), page 7-1.)

**Note**

This type of validation occurs only when a template is added to the system or when the content of an existing template is replaced

Cisco BAC uses the XML schemas that are defined in various files to generate instructions for device configurations. [Table 5-1](#) lists these files and their locations.

**Table 5-1 Files Used in Configuration Template Processing**

File	Purpose	Options Available in Cisco BAC
Configuration Template Samples	Defines device configuration	Sample templates
	<b>Sample templates are located at:</b> <BPR_HOME>/rdu/samples/cwmp	
Configuration Template Schema	Validates configuration template syntax	Default template schemas
	<b>Default template schemas are located at:</b> <ul style="list-style-type: none"> <li>• CWMP configuration schema                &lt;BPR_HOME&gt;/rdu/templates/cwmp/schema/CwmpTemplateConstructs.xsd</li> <li>• Common template schema                &lt;BPR_HOME&gt;/rdu/templates/cwmp/schema/CommonTemplateConstructs.xsd</li> </ul>	
Parameter Dictionary	Validates configuration template content	Default dictionaries Custom dictionaries
	<b>Default dictionaries are located at:</b> <ul style="list-style-type: none"> <li>• &lt;BPR_HOME&gt;/rdu/templates/cwmp/dictionary/tr069-cwmp-dictionary.xml</li> <li>• &lt;BPR_HOME&gt;/rdu/templates/cwmp/dictionary/tr098-cwmp-dictionary.xml</li> <li>• &lt;BPR_HOME&gt;/rdu/templates/cwmp/dictionary/tr104-cwmp-dictionary.xml</li> <li>• &lt;BPR_HOME&gt;/rdu/templates/cwmp/dictionary/tr106-cwmp-dictionary.xml</li> <li>• &lt;BPR_HOME&gt;/rdu/templates/cwmp/dictionary/tr196-cwmp-dictionary-v1.1.xml</li> <li>• &lt;BPR_HOME&gt;/rdu/templates/cwmp/dictionary/tr196-cwmp-dictionary-v2.0.xml</li> <li>• &lt;BPR_HOME&gt;/rdu/templates/cwmp/dictionary/tr196-cwmp-dictionary-IGD-v1.1.xml</li> <li>• &lt;BPR_HOME&gt;/rdu/templates/cwmp/dictionary/tr196-cwmp-dictionary-IGD-v2.0.xml</li> <li>• &lt;BPR_HOME&gt;/rdu/templates/cwmp/dictionary/basic-cwmp-dictionary.xml</li> </ul>	
Parameter Dictionary Schema	Validates parameter dictionary syntax	Default dictionary
	<b>Parameter dictionary schema is located at:</b> Schema for TR-069, TR-098, TR-104, TR-106, TR-181, and TR-196 dictionaries <BPR_HOME>/rdu/templates/cwmp/schema/TemplateDictionarySchema.xsd	

Cisco BAC supports multiple instance object which is available in the configuration template. This facilitates discovering and updating parameters for the selective object instances without specifying the object instance number. For more information on multi-instance object support see, [Multi-Instance Object Support, page 4-5](#).

You can manage template files, configuration and firmware rules, by using the administrator user interface.



A configuration template comprises the following components:

- **ObjectInstance**—Represents an instance of a TR-069 CPE node. You must specify the object's 'name.'

An object may include other objects and parameters, both of which, in turn, may include other elements in line with the TR-069 specification.

A CPE object may contain:

- Object—Describes an instance of a CPE node.
  - Parameters—Describes a CPE parameter and must have a value, and Notification, Access Control, or both. (See [Parameters, page 5-6.](#))
  - Notification—Enables notification of changes in the value on all child parameters of this parameter at all levels. (See [Notification, page 5-8.](#))
  - Access Control—Controls whether or not entities other than the autoconfiguration server (user, SNMP, UPnP, and so on) can change values of any configuration parameters under this object. (See [Access Control, page 5-9.](#))
- **Parameter Dictionary**—Contains definitions used to validate the objects and parameters in configuration templates. Cisco BAC supports only one dictionary per template. (See [Parameter Dictionaries, page 7-1.](#))
  - **Prerequisites**—Optionally, indicates the conditions that must be met before a device can be configured. These conditions may include:
    - MaintenanceWindow—Enables you to specify the time that a configuration is to be applied to a device.
    - Expressions—Enable you to specify any parameters that need to match on the device as a prerequisite to applying the configuration; for example, a particular software or hardware version of a device.

See [Figure 5-3](#) for a graphical representation of the prerequisite schema. For detailed information on using the prerequisite option, see [Prerequisites, page 5-9.](#)

Adding a configuration template to Cisco BAC would fail if there are errors in the template. To avoid configuration errors, ensure that all:

- Object names and parameter names exist in the parameter dictionary.
- Parameter values are of the type specified in the parameter dictionary.
- Parameters that are not writable do not have a value. However, they may have the Notification, Access Control attributes, or both set.
- Substitutable variables are defined in the system through Cisco BAC custom property or device property.

# Parameters

This section describes the schema associated with parameter objects in the configuration templates (see Figure 5-2).

Figure 5-2 Parameter Schema

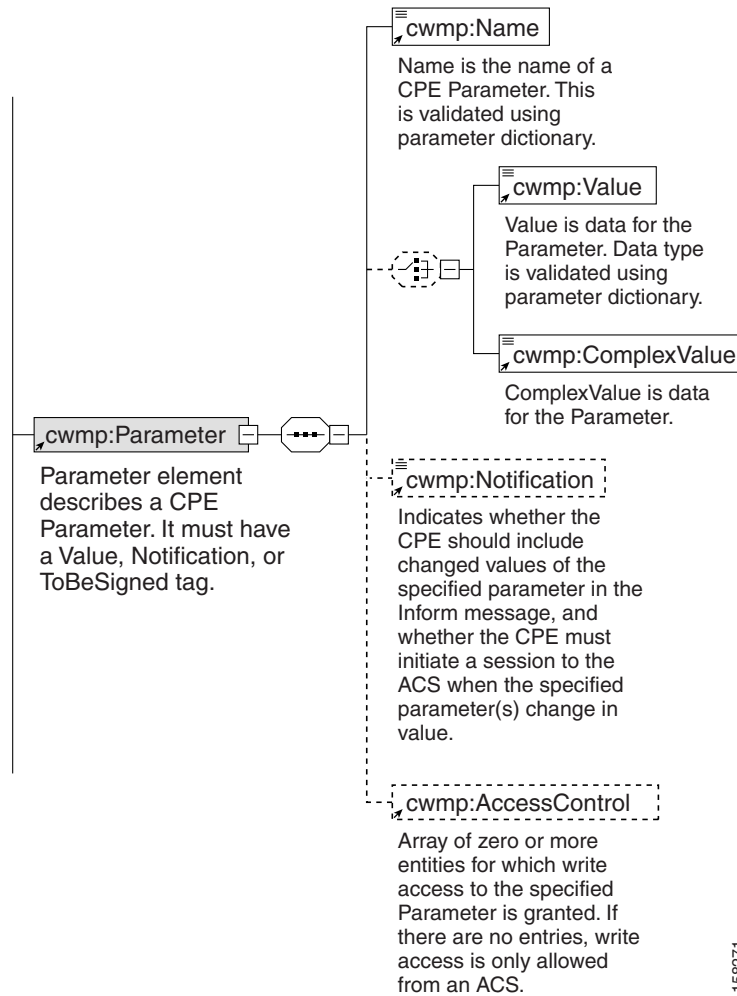

The CPE parameter contains a name-value pair:

The name identifies the parameter, and has a hierarchical structure similar to files in a directory, with each level separated by a dot (.). Each level corresponds to an object instance: Some objects have a single instance or singletons, other objects have multiple instances. The parameter lists for both object instances are described in subsequent sections.

The value of a parameter may be one of several data types defined in the TR-069 specification. These data types are **string**, **int**, **unsignedInt**, **boolean**, **dateTime**, and **base64**, each of which is validated by a parameter dictionary (see Table 7-1 for data type definitions).



Example 5-1 illustrates how you can configure values for a parameter:

### Example 5-1 Configuring Parameter Values

```
<tc:Template
xmlns:xsi="http://www.w3.org/2001/XMLSchema-instance"
xmlns:tc="urn:com:cisco:bac:common-template"
xmlns="urn:com:cisco:bac:cwmp-template"
xsi:schemaLocation="urn:com:cisco:bac:common-template CommonTemplateConstructs.xsd">

  <Configuration>
    <ParameterDictionaries>
      <ParameterDictionary>tr069-cwmp-dictionary.xml</ParameterDictionary>
    </ParameterDictionaries>
    <ObjectInstance name="InternetGatewayDevice">
      <ObjectInstance name="ManagementServer">
        <Parameter>
          <Name>PeriodicInformEnable</Name>
          <Value>>true</Value>
        </Parameter>
        <Parameter>
          <Name>PeriodicInformInterval</Name>
          <Value>86400</Value>
        </Parameter>
      </ObjectInstance>
    </ObjectInstance>
  </Configuration>
</tc:Template>
```

## Parameter List for Single Instance Object

This is an example of a single instance, or singleton:

```
InternetGatewayDevice.UserInterface.
```

The parameters of a singleton can be represented as:

```
InternetGatewayDevice.UserInterface.PasswordRequired = true
InternetGatewayDevice.UserInterface.ISPName = SBC
```

## Parameter List for Multiple Instance Objects

The TR-069 specification defines some objects that can have multiple instances, with each instance assigned a number. You use the parameter dictionary to define the objects that can have multiple instances.

For example, `InternetGatewayDevice.Layer3Forwarding.Forwarding` is a multiple instance object.

Two instances of that object can be represented as described:

```
InternetGatewayDevice.Layer3Forwarding.Forwarding.1.Enable = true
InternetGatewayDevice.Layer3Forwarding.Forwarding.2.Enable = false
```



### Note

Instance numbers are generated by the device. A parameter dictionary uses `{i}` to represent the objects which can have multiple instances. Configuration templates must use the actual instance number to indicate the object which is being modified, such as `InternetGatewayDevice.WANDevice.1.WANConnectionNumberOfEntries`.

## Notification

By using the Cisco BAC Notification attribute, a device can notify the DPE of parameter value changes. Notifications, by default, are turned off.

If Notification is enabled, it specifies that a device should include the changed values of a particular parameter in the device Inform message to the DPE, and that the device must initiate a session to the DPE whenever the value of that particular parameter is changed.

Cisco BAC supports the following values for the Notification attribute as defined in the TR-069 specification:

- `Off`—Notification set to off.

The device need not inform Cisco BAC of a change to the specified parameter(s).

- `Passive`—Notification set to Passive.

Whenever the specified parameter value changes, the device must include the new value in the `ParameterList` in the Inform message that is sent the next time that Cisco BAC establishes a session.

- `Active`—Notification set to Active.

Whenever the specified parameter value changes, the device must initiate a session with Cisco BAC, and include the new value in the `ParameterList` in the associated Inform message. Whenever a parameter change is sent in the Inform message due to a nonzero Notification setting, the Event code `4 VALUE CHANGE` must be included in the list of Events.



### Note

The device returns a `notification request rejected` error if an attempt is made to set Notification on a parameter deemed inappropriate; for example, a continuously varying statistic.

## Configuring Notification

The following example illustrates how you can configure the Notification attribute.

In this example, a configuration file is defined and generated for a `UserInterface` object, with Notification set to `Active` for all parameters. The `ISPName` parameter overrides this Notification and sets it to `Passive`.

```

<!--Set Notification of object InternetGatewayDevice.UserInterface.-->

<ObjectInstance name="InternetGatewayDevice">
  <ObjectInstance name="UserInterface">
    <Notification>Active</Notification> <!-- applies to all parameters under this
                                     object -->
    <Parameter>
      <Name>PasswordRequired</Name>
      <Value>>true</Value>
    </Parameter>
    <Parameter>
      <Name>WarrantyDate</Name>
      <Value>2001-02-23T09:45:30+04:30</Value>
    </Parameter>
    <Parameter>
      <Name>ISPName</Name>
      <Value>SBC</Value>
      <Notification>Passive</Notification> <!--applies to only this parameter-->
    </Parameter>
    <Parameter>
      <Name>ISPHomePage</Name>

```

```

        <Value>www.sbc.com</Value>
    </Parameter>
</ObjectInstance>
</ObjectInstance>

```

## Access Control

Access control in Cisco BAC is enabled through the *AccessControl* attribute of the CPE that you can control by using configuration templates. CPE parameters can be changed using LAN autoconfiguration protocol if access control is set to allow such access. For instance, if the *AccessControl* attribute is set to *Subscriber*, then the subscriber on the LAN can change the parameter value.

The value of the *AccessControl* attribute is an array of zero or more entities for which *write* access to a specific parameter is granted. If no entries are present, only updates to the parameter value are allowed from Cisco BAC.

Cisco BAC defines only one entity in this list, in line with the TR-069 specification: *Subscriber*. This enables *write* access by the subscriber on the LAN, such as through the LAN-side DSL CPE Configuration protocol or through the UPnP protocol.

## Configuring Access Control

The following example illustrates how to set access control in Cisco BAC by using configuration templates:

```

<ObjectInstance name="InternetGatewayDevice">
  <ObjectInstance name="ManagementServer">
    <AccessControl> <!--Allow LAN-side updates of this object and parameters
under it -->
      <Entity>Subscriber</Entity>
    </AccessControl>
    <Parameter>
      <Name>PeriodicInformEnable</Name>
      <Value>true</Value>
    </Parameter>

    <Parameter>
      <Name>PeriodicInformEnable</Name>
      <AccessControl/> <!-- Allow updates only from ACS (BAC) -->
    </Parameter>
  </ObjectInstance>
</ObjectInstance>

```

## Prerequisites

Cisco BAC templates include a prerequisites option, which indicates what conditions must be met before configuring the device. For example, a prerequisite may specify that the device to which you apply a configuration must meet the requirement of a specific hardware or software version.

Prerequisite rules are embedded into an instruction, which is sent to the DPE. The DPE then interrogates the device as necessary to determine if the prerequisites match.

Figure 5-3 illustrates the schema of the prerequisites option:

Figure 5-3 Prerequisite Schema

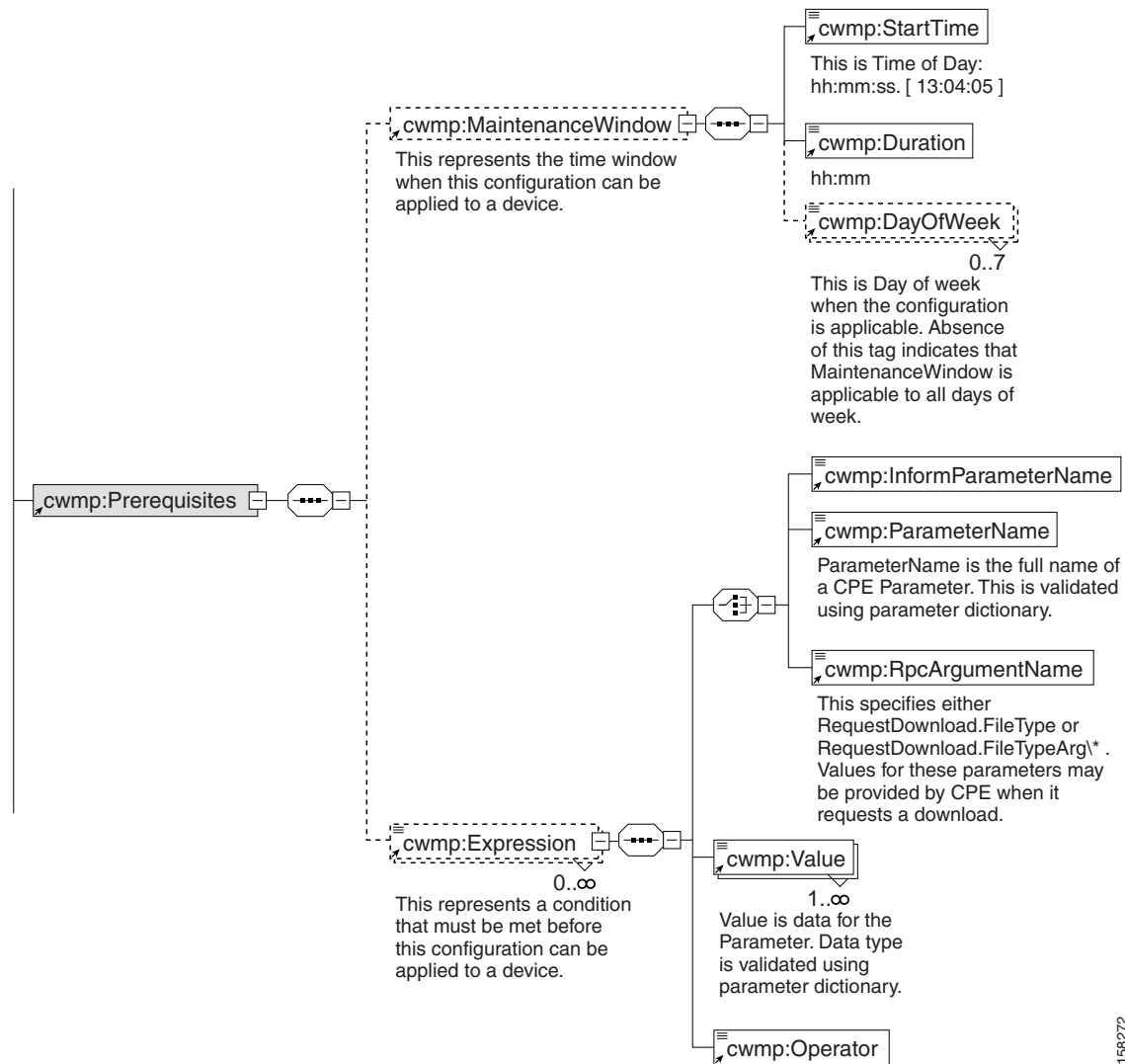

158272

You use prerequisites to manipulate configuration generation through:

- Expressions
- MaintenanceWindow

## Expressions

Expressions are conditionals that use information from device properties. They may use Parameters, InformParameters or rpcArguments. Expressions are used within prerequisites and firmware rules and are processed when a device contacts Cisco BAC to retrieve its configuration.

If the expressions that you specify evaluates to *true*, the condition(s) is met, and the corresponding configuration or firmware rule is applied to the device. For detailed information, see [Using Conditionals, page 5-19](#).

The *Prerequisites* tag may contain zero or more expressions.

### SendHttpErrorOnFail

When the prerequisites specified in the configuration template are not met, and the `sendHttpErrorOnFail` attribute is set, an HTTP error with the specified code is sent to the device, and the corresponding configuration is not applied to the device.

#### Example 5-2 Configuring Prerequisite - sendHttpErrorOnFail

In this example, when the software version of the device is not 1.1, an HTTP error code is sent to the device.

```
<Prerequisites sendHttpErrorOnFail="503">
  <Expression>
    <ParameterName>InternetGatewayDevice.DeviceInfo.SoftwareVersion</ParameterName>
    <Value>1.1</Value>
    <Operator>match</Operator>
  </Expression>
</Prerequisites>
```

## MaintenanceWindow

Use the `MaintenanceWindow` setting to specify the time window within which you want to apply a particular configuration to a specific CPE. This evaluation is performed at the DPE on device contact; as such, the DPE local time is used.



### Note

You should configure the server on which the DPE runs with automatic time server synchronization, such as NTP.

`MaintenanceWindow` comprises:

- *StartTime*—Specifies a time value indicating the beginning of a maintenance window. This value is defined as *hh:mm:ss*.
- *Duration*—Specifies a time value indicating the duration from *StartTime* when the configuration can be applied. This value is defined as *hh:mm*.
- *DayOfWeek*—Specifies the days of the week when you can apply the configuration. Absence of this tag indicates that the rule is valid for all days of the week. This tag is optional.

You can use these elements to specify the time window when this rule can run, thus providing the ability to limit configuration upgrades to late in the night when subscribers are most likely sleeping.

The *Prerequisites* tag may contain zero or one `MaintenanceWindow`.

**Example 5-3 Configuring MaintenanceWindow**

In the following example, the values of the *StartTime*, *Duration*, and *DayOfWeek* tags define the period when this rule is in effect. This template takes effect at 1 a.m. for a period of 5 hours, on every Monday, Tuesday, and Friday.

```
<Prerequisites>
  <MaintenanceWindow>
    <StartTime>01:00:00</StartTime>
    <Duration>05:00</Duration>
    <DayOfWeek>Monday</DayOfWeek>
    <DayOfWeek>Tuesday</DayOfWeek>
    <DayOfWeek>Friday</DayOfWeek>
  </MaintenanceWindow>
</Prerequisites>
```

**Device Contact During MaintenanceWindow**

A key concept in MaintenanceWindow is ensuring that devices contact Cisco BAC during the window.

You can configure the devices to contact the DPE at a given date and time, by setting a value for the *PeriodicInformTime* variable in the configuration template. Also, set the *RandomDateTimeInRange* tag to designate a time range when the device can contact Cisco BAC.

See [Example 5-4](#) for how to configure a device to contact Cisco BAC during a MaintenanceWindow.

**Example 5-4 Configuring Device to Contact Cisco BAC During MaintenanceWindow**

In the following example, the device contacts Cisco BAC for the first time on January 1, 2007, between 3 a.m. and 4 a.m. After the initial contact, the device continues to contact Cisco BAC every 30 minutes.

- *PeriodicInformEnable* is set to *true* to indicate that the device must periodically send device information to Cisco BAC using the Inform method call.
- *PeriodicInformInterval* is set to 30 minutes (1800 seconds), requesting the device to attempt to contact Cisco BAC every 30 minutes. This duration is the interval within which the device attempts to connect with Cisco BAC if *PeriodicInformEnable* is *true*.
- *PeriodicInformTime* is set to a date and time when the device should initiate contact with Cisco BAC.

```
<ObjectInstance name="InternetGatewayDevice">
  <ObjectInstance name="ManagementServer">
    <Parameter>
      <Name>PeriodicInformEnable</Name>
      <Value>true</Value>
    </Parameter>
    <Parameter>
      <Name>PeriodicInformInterval</Name>
      <Value>1800</Value>
    </Parameter>
    <Parameter>
      <Name>PeriodicInformTime</Name>
      <ComplexValue>
        <RandomDateTimeInRange>
          <StartDateTime>2006-01-27T01:00:00+03:00</StartDateTime>
          <RandomizationIntervalMinutes>60</RandomizationIntervalMinutes>
        </RandomDateTimeInRange>
      </ComplexValue>
    </Parameter>
  </ObjectInstance>
</ObjectInstance>
```

For detailed information on PeriodicInformInterval, see the Broadband Forum's Technical Report on TR-069.

You can initiate a firmware upgrade in a similar fashion. Firmware upgrades are typically carried out only within a specific time range. After defining a firmware rule template with the MaintenanceWindow option set, associate the firmware rule template to a Class of Service object by using the administrator user interface.

After you finish this task, the firmware rule is pushed to the DPE. The DPE evaluates the firmware rule and ensures that the firmware upgrade is executed during the specific time.

## Configuring Prerequisites

This section illustrates how to configure the prerequisite option.

### **Example 5-5** Configuring Prerequisites - Maintenance Window

In this example, the prerequisite indicates that this template will come into effect at 1 a.m. for a duration of 5 hours. During this time, this template can be applied to any device that contacts Cisco BAC and has an EventCode of 1 BOOT and the manufacturer as Acme, Inc.

### **Example 5-6** Prerequisite Using Expression

```
<Prerequisites>
  <MaintenanceWindow>
    <StartTime>01:00:00</StartTime>
    <Duration>5:00</Duration>
  </MaintenanceWindow>
  <Expression>
    <InformParameterName>InternetGatewayDevice.DeviceInfo.EventCode</InformParameterName>
    <Value>1 BOOT</Value>
    <Operator>match</Operator>
  </Expression>
  <Expression>
    <ParameterName>InternetGatewayDevice.DeviceInfo.Manufacturer</ParameterName>
    <Value>Acme, Inc</Value>
    <Operator>matchIgnoreCase</Operator>
  </Expression>
</Prerequisites>
```

### **Example 5-7** Prerequisite Using Regular Expression (Regex)

```
<Prerequisites>
  <MaintenanceWindow>
    <StartTime>01:00:00</StartTime>
    <Duration>5:00</Duration>
  </MaintenanceWindow>
  <Expression>
    <InformParameterName>Inform.EventCode</InformParameterName>
    <Value>^[0-9]\s\w</Value>
    <Operator>regexMatch</Operator>
  </Expression>
</Prerequisites>
```

# Authoring Configuration Templates

You can use Cisco BAC to generate instructions for customized configurations for many devices from a single template by using template constructs. Parameter substitution and conditional inclusion or exclusion of template content, controlled by values from the Cisco BAC property hierarchy, create a custom configuration from a template. A template may include other templates, providing a mechanism to reuse common configurations.

You must add template files to the RDU by using the administrator user interface or the API, before any Class of Service can reference it.



## Note

The XML elements in a template are divided into two groups:

- Elements that are not prefixed by **tc** are unique to configuration templates.
- Elements prefixed by **tc** are generic constructs that are the same for configuration templates and for firmware rule templates.

A configuration template, with `Configuration` as the root element, must follow a structure similar to [Example 5-8](#).

### Example 5-8 Sample Configuration Template

```
<tc:Template
xmlns:xsi="http://www.w3.org/2001/XMLSchema-instance"
xmlns:tc="urn:com:cisco:bac:common-template"
xmlns="urn:com:cisco:bac:cwmp-template"
xsi:schemaLocation="urn:com:cisco:bac:common-template CommonTemplateConstructs.xsd">
<Prerequisites>
  <MaintenanceWindow>
    <StartTime>01:00:00</StartTime>
    <Duration>2:30</Duration>
  </MaintenanceWindow>
  <Expression>
    <ParameterName>InternetGatewayDevice.DeviceInfo.Manufacturer</ParameterName>
    <Value>Acme, Inc</Value>
    <Operator>matchIgnoreCase</Operator>
  </Expression>
</Prerequisites>
<Configuration>
  <ParameterDictionaries>
    <ParameterDictionary>tr069-cwmp-dictionary.xml</ParameterDictionary>
  </ParameterDictionaries>
  <ObjectInstance name="InternetGatewayDevice">
    <ObjectInstance name="ManagementServer">
      <Parameter>
        <Name>PeriodicInformEnable</Name>
        <Value>true</Value>
      </Parameter>
      <Parameter>
        <Name>PeriodicInformInterval</Name>
        <Value>86400</Value>
      </Parameter>
    </ObjectInstance>
  </ObjectInstance>
</Configuration>
</tc:Template>
```



Configuration templates support:

- **Parameter substitution**—Substitutes values from the Cisco BAC property hierarchy into XML element content and element attributes by using the `VAR()` construct. (For details, see [Using Parameter Substitution, page 5-16](#).)
- **Includes**—Build a set of reusable template snippets. Includes are useful for defining options that are common across many service classes without having to duplicate the options in several templates. (For details, see [Using Includes, page 5-17](#).)
- **Conditionals**—Include or exclude blocks of text within a template. The text blocks that you can enclose within the conditional statements are limited to parameter and object instance elements. (For details, see [Using Conditionals, page 5-19](#).)

## Custom Properties

Cisco BAC properties provide access to data that is stored in Cisco BAC using the API. Using the API, you can use the properties of corresponding objects to retrieve preprovisioned, discovered, and status data. You can use properties to configure Cisco BAC at the appropriate level of granularity (from system level to device group and to individual device). See [Property Hierarchy, page 4-4](#) for details.

You can use custom properties to define additional customizable device information to be stored in the RDU database. You typically use these properties to substitute parameter values in configuration templates and firmware rule templates.

The template parser works from the bottom up while locating properties in the hierarchy (device first, followed by the Group, provisioning group, then the Class of Service, device type, and system defaults) and converts the template option syntax.

For details on substituting template parameters using the `VAR()` construct, see the subsequent section.

### **Example 5-9 Retrieving Username or Password from Device**

The following example illustrates how you can use templates to retrieve properties from different levels; for instance, username and password credentials from a device.

```
<tc:Template>
  <Configuration>
    <ParameterDictionaries>
      <ParameterDictionary>tr069-cwmp-dictionary.xml</ParameterDictionary>
    </ParameterDictionaries>
    <ObjectInstance name="InternetGatewayDevice">
      <ObjectInstance name="ManagementServer">
        <Parameter>
          <Name>PeriodicInformEnable</Name>
          <Value>>true</Value>
        </Parameter>
        <Parameter>
          <Name>PeriodicInformInterval</Name>
          <Value>20</Value>
          <Notification>Active</Notification>
        </Parameter>
        <Parameter>
          <Name>ConnectionRequestUsername</Name>
          <Value>VAR(name=/dt/username, defaultValue="User")</Value>
        </Parameter>
        <Parameter>
          <Name>ConnectionRequestURL</Name>
          <Value>VAR(name=/dt/pk, defaultValue="http://testURL")</Value>
        </Parameter>
      </ObjectInstance>
    </ObjectInstance>
  </Configuration>
</tc:Template>
```

```

        </ObjectInstance>
    </ObjectInstance>
</Configuration>
</tc:Template>

```

To configure custom properties from the administrator user interface, choose the **Configuration > Custom Property** tabs. Use the Add Custom Property page to add or delete custom properties. For details, see [Configuring Custom Properties, page 17-5](#).

**Caution**

If you remove custom properties that a template references, the RDU fails to generate instructions for a device.

## Using Parameter Substitution

Values from the Cisco BAC property hierarchy are substituted into a template by using the `VAR()` construct, to produce a custom configuration from a configuration template. The `VAR()` construct can appear in an XML element value or element attribute. You can also use it to substitute full or partial values.

The following list describes the constructs that Cisco BAC supports for parameter substitution:

- Cisco BAC property value into XML element content
- Cisco BAC property value into XML element attribute
- Default value
- XML partial element content
- Values with special characters

### Syntax Description

`VAR(token=someChar, name=someProperty, defaultValue=someValue)`

- *token*—Specifies the character that delimits subsequent fields. This element is optional and defaults to a comma (,).

**Note**

If the default value contains a comma (,), then start the `VAR()` construct by specifying a token character. This token must not appear in the default value. Also, ensure that the token character precedes the `VAR` end bracket.

- *name*—Specifies the name of the custom property to be substituted or the Standard Device properties to be referenced.
- *defaultValue*—Specifies the value to use if the referenced property is not available.

#### Example 5-10 Setting a Value to a Cisco BAC Custom Property

```
<Value>VAR(name=/cpe/version, defaultValue=4)</Value>
```

#### Example 5-11 Referencing Standard Device Property

```
<Value>VAR(name=/IPDevice/connectionRequestPath, defaultValue="http://test")</Value>
```



**Note** The API constant for `/IPDevice/connectionRequestPath` is `IPDeviceKeys.CONNECTION_REQUEST_PATH`.

**Example 5-12 Using a default value With a Comma**

```
<Value>VAR(token=; ;name=/cpe/usrStr; defaultValue=4,5;)</Value>
```

**Example 5-13 Creating a String Value based on a Cisco BAC Property**

```
<Value>CWMP_VAR(name=/cpe/version, defaultValue=4).bin</Value>
```

If `cpe/version` is `1-08` then the Value will be `CWMP_1-08.bin`.

## Using Includes

Include files let you build a set of reusable template snippets. These files are useful for defining options that are common across many service classes without having to duplicate the options in several templates.

You can include the content of a particular file into a template by using the **tc:include** construct. After inserting the content of included files into the host template, the parameter dictionary that is specified in the host template validates the content of the resulting template.



**Note** If included templates use objects and parameters not defined in the same dictionary as the host template, parameter validation fails during instruction generation.

The **tc:Include** element specifies the *href* attribute, where *href* identifies the name of the Cisco BAC template file that is included in the host template. Use double quotation marks (") when using an include directive in template.



**Note** Ensure that Include files are of the same file type as the template. For instance, when adding a configuration template, all the included files must be of the Configuration Template file type.

**Example 5-14 Include Files**

The following example displays the content of a host template, and an included template.

**Included Template: *informInterval.xml***

```
<!-- enable and set Periodic Inform value -->
<tc:Template xsi="http://www.w3.org/2001/XMLSchema-instance"
:tc="urn:com:cisco:bac:common-template" = "urn:com:cisco:bac:cwmp-template"
:schemaLocation="urn:com:cisco:bac:common-template CommonTemplateConstructs.xsd">
  <Configuration>
    <ParameterDictionaries>
      <ParameterDictionary>tr069-cwmp-dictionary.xml</ParameterDictionary>
    </ParameterDictionaries>
    <ObjectInstance name="InternetGatewayDevice">
      <ObjectInstance name="ManagementServer">
        <Parameter>
          <Name>PeriodicInformEnable</Name>
          <Value>>true</Value>
        </Parameter>
      </ObjectInstance>
    </ObjectInstance>
  </Configuration>
</tc:Template>
```

```

        </Parameter>
        <Parameter>
            <Name>PeriodicInformInterval</Name>
            <Value>30</Value>
        </Parameter>
    </ObjectInstance>
</ObjectInstance>
</Configuration>
</tc:Template>

```

### Host Template: *cwmp-config.xml*

```

<!-- set Periodic Inform value based on content of informInterval-cwmp.xml -->
<!-- set ManagmentServer.URL -->
<tc:Template xsi="http://www.w3.org/2001/XMLSchema-instance"
:tc="urn:com:cisco:bac:common-template" = "urn:com:cisco:bac:cwmp-template"
:schemaLocation="urn:com:cisco:bac:common-template CommonTemplateConstructs.xsd">
<Configuration>
    <ParameterDictionaries>
        <ParameterDictionary>tr069-cwmp-dictionary.xml</ParameterDictionary>
    </ParameterDictionaries>
    <tc:include href="informInterval.xml" />
    <ObjectInstance name="InternetGatewayDevice">
        <ObjectInstance name="ManagementServer">
            <Parameter>
                <Name>URL</Name>
                <Value>http://10.44.64.200:9595/acs</Value>
            </Parameter>
        </ObjectInstance>
    </ObjectInstance>

</Configuration>
</tc:Template>

```

### Template After Inserting Included File: *informInterval.xml*

```

<!-- set ManagmentServer.URL -->
<tc:Template xsi="http://www.w3.org/2001/XMLSchema-instance"
:tc="urn:com:cisco:bac:common-template" = "urn:com:cisco:bac:cwmp-template"
:schemaLocation="urn:com:cisco:bac:common-template CommonTemplateConstructs.xsd">
<Configuration>
    <ParameterDictionaries>
        <ParameterDictionary>tr069-cwmp-dictionary.xml</ParameterDictionary>
    </ParameterDictionaries>
    <ObjectInstance name="InternetGatewayDevice">
        <ObjectInstance name="ManagementServer">
            <Parameter>
                <Name>PeriodicInformEnable</Name>
                <Value>true</Value>
            </Parameter>
            <Parameter>
                <Name>PeriodicInformInterval</Name>
                <Value>30</Value>
            </Parameter>
        </ObjectInstance>
    </ObjectInstance>
    <ObjectInstance name="InternetGatewayDevice">
        <ObjectInstance name="ManagementServer">
            <Parameter>
                <Name>URL</Name>
                <Value>http:// 10.44.64.200:9595/acs</Value>
            </Parameter>
        </ObjectInstance>
    </ObjectInstance>

```

```
</Configuration>
</tc:Template>
```

## Using Conditionals

Cisco BAC supports powerful conditional expressions in template constructs to provide ultimate configuration customization.

You can use conditional expression constructs to include or exclude blocks of text within a template. These construct elements are **tc:if**, **tc:choose**, and **tc:when**. You use the **tc:if** construct for simple single conditionals.

You can use a combination of **tc:choose**, **tc:when**, and **tc:otherwise** for a logical **if...else if...else** construct. The **tc:if** and the **tc:when** constructs require a *test* attribute. A *test* attribute is an expression that can be evaluated, and the resulting object can be converted to a Boolean operator (*true* or *false*).

The **tc:choose** element selects one from a number of possible alternatives. This element contains a sequence of **tc:when** elements, followed by an optional **tc:otherwise** element. Each **tc:when** element has a single attribute, *test*, which specifies an expression.

The content of the **tc:when** and the **tc:otherwise** elements is a valid template segment. When a **tc:choose** element is processed, each of the **tc:when** elements is tested in turn, by evaluating the expression and converting the resulting object to a Boolean operator.

The content of the first—and only the first—**tc:when** element whose test is true is instantiated. If no **tc:when** is true, the content of the **tc:otherwise** element is instantiated. If no **tc:when** element is true and no **tc:otherwise** element is present, nothing is created.



### Note

Within expressions, you can use single (') or double quotes (") to delimit literal strings. The template processor interprets a quotation mark ( ' or " ) as terminating the attribute. To avoid this problem, you can enter the marks as a character reference (&quot; or &apos;). (See [Table 5-2](#).) Alternatively, the expression can use single quotes (') if the attribute is delimited with double quotes (") or vice-versa.

[Table 5-2](#) lists the conditional template constructs that this Cisco BAC release supports.

**Table 5-2** Conditional Template Constructs Supported in Cisco BAC

Conditional statement	If
Conditional statement	If...else if...else
Conditional statement	or
Conditional expression	and
Conditional expression	lessThan
Conditional expression	lessThanEquals
Conditional expression	greaterThan
Conditional expression	greaterThanEquals
Conditional expression	contains, notContains
Conditional expression	containsIgnoreCase, notContainsIgnoreCase
Conditional expression	equals, notEquals
Conditional expression	equalsIgnoreCase, notEqualsIgnoreCase

**Table 5-2 Conditional Template Constructs Supported in Cisco BAC (continued)**

Conditional expression	when..otherwise
Conditional expression	choose

XML does not support the left angle bracket (<) and the ampersand (&). Instead, use the predefined entities (described in [Table 5-3](#)) for these characters.

**Table 5-3 XML Definitions in Cisco BAC**

Instead of ...	Use ...
< (less than)	&lt;
<= (less than or equal)	&lt;=
> (greater than)	&gt;
>= (greater than or equals)	&gt;=
& (ampersand)	&amp;
' (apostrophe)	&apos;
" (double quotes)	&quot;

The following examples illustrate various conditional expressions:

**Example 5-15 Numerical Test Condition**

Using 100 as a number:

```
<tc:if test="VAR(name=/cpe/version, defaultValue=20) greaterThan 100">
  <Parameter>
    <Name>Enable</Name>
    <Value>>false</Value>
  </Parameter>
</tc:if>
```

**Example 5-16 String Test Condition**

Using 100 as string:

```
<tc:if test="VAR(name=/cpe/version, defaultValue=20) greaterThan '100'">
  <Parameter>
    <Name>Enable</Name>
    <Value>>false</Value>
  </Parameter>
</tc:if>
```



**Note** When comparing digits as numbers, 20 is less than 100. However, when an operator is used with a string, comparing digits as strings makes 20 greater than 100.

**Example 5-17 Looking for Text in a Cisco BAC Property**

Using text `cwmp`:

```
<tc:if test="contains(VAR(name=/cpe/UsrStr, defaultValue=linksys), 'cwmp')">
  <Parameter>
    <Name>Enable</Name>
    <Value>>false</Value>
  </Parameter>
</tc:if>
```

### Example 5-18 Looking for Text in Single Quotes

Using `cwmp`'s `test`:

```
<tc:if test="contains(VAR(name=/cpe/UsrStr, defaultValue=linksys), '&quot;cwmp's
test&quot;')">
  <Parameter>
    <Name>Enable</Name>
    <Value>>false</Value>
  </Parameter>
</tc:if>
```

### Example 5-19 Looking for Text in Double Quotes

Using `cwmp` `test`:

```
<tc:if test="contains(VAR(name=/cpe/UsrStr, defaultValue=linksys), 'cwmp
&quot;test&quot;')">
  <Parameter>
    <Name>Enable</Name>
    <Value>>false</Value>
  </Parameter>
</tc:if>
```

The text blocks that you can enclose within the conditional statements are limited to `Parameter` and `Object` elements.

### Example 5-20 Choosing from Alternatives (Using `choose` and `when` Syntax)

The following example describes the syntax when using `tc:choose` and `tc:when`:

```
<tc:choose>
  <tc:when test="VAR(name=/cpe/version,defaultValue=11) greaterThan 12">
    <Parameter>
      <Name>UpgradeAvailable</Name>
      <Value>>true</Value>
    </Parameter>
  </tc:when>
  <tc:when test="VAR(name=/db/version,defaultValue=15) greaterThan 14">
    <Parameter>
      <Name>UpgradeAvailable</Name>
      <Value>>true</Value>
    </Parameter>
  </tc:when>
  <tc:otherwise>
    <Parameter>
      <Name>UpgradeAvailable</Name>
      <Value>>false</Value>
    </Parameter>
  </tc:otherwise>
</tc:choose>
```

### Example 5-21 Choosing from Alternatives (Using `choose` and `if` Syntax)

The following example describes the syntax when using `tc:choose` and `tc:if`:

```

<tc:choose>
  <tc:if test="contains(VAR(name=FC-ACTIVATED-INFORM-ENABLE, defaultValue=false),
'true')">
    <Parameter>
      <Name>PeriodicInformInterval</Name>
      <Value>21600</Value>
    </Parameter>
  </tc:if>
  <tc:else>
    <Parameter>
      <Name>PeriodicInformInterval</Name>
      <Value>1200</Value>
    </Parameter>
  </tc:else>
</tc:choose>

```

## Using the Configuration Utility

You can use the configuration utility to test, validate, and view TR-069 template files: configuration and firmware rules. These activities are critical to successful deployment of instructions for individualized configuration files. (For more information on templates, see [Authoring Configuration Templates, page 5-14](#).)

The configuration utility is available only when the RDU is installed, and it is installed in the <BPR\_HOME>/rdu/bin directory.

All examples in this section assume that the RDU is operating and that these conditions apply:

- The BAC application is installed in the default home directory (*/opt/CSCObac*).
- The RDU login name is **bacadmin**.
- The RDU login password is **changeme**.



### Note

Some of the examples provided in this section were truncated whenever the omitted formation is of no consequence to the example or its outcome. Instances where this occurs are identified by an ellipsis (...) that precede the example summary.

This section discusses:

- [Running the Configuration Utility, page 5-23](#)
- [Adding a Template to Cisco BAC, page 5-23](#)
- [Validating XML Syntax for a Local Template File, page 5-24](#)
- [Validating XML Syntax for a Template Stored in Cisco BAC, page 5-24](#)
- [Testing Template Processing for a Local Template File, page 5-25](#)
- [Testing Template Processing for a Template Stored in Cisco BAC, page 5-26](#)
- [Testing Template Processing for a Cisco BAC Template File and a Device, page 5-27](#)



## Running the Configuration Utility

In subsequent procedures and examples, the phrase running the configuration utility means to enter the **runCfgUtil.sh** command from the directory specified. To run the configuration utility, run this command from the `<BPR_HOME>/rdu/bin` directory:

```
runCfgUtil.sh options
```

The available *options* include:

- **-cwmp**—Specifies the input file is to be processed as a CWMP technology configuration template file. Use **-cwmp** with the **-a** option.
- **-a {sc | gc}**—Specifies a required action, which could be either:
  - **sc**—To specify a syntax check to test if the XML template and dictionary are well-formed. Use **sc** with the **-I** option.
  - **gc**—To process a configuration template the same way as the Instruction Generation Service (IGS) would. Use **gc** with the (**-I** and **-data**), or the (**-I** and **-i**) options.
- **-I filename**—Identifies the input file to be on the local file system. For example, if the name of your input file is *any\_file*, enter **-I any\_file**.



---

**Note** Do not use **-I** with the **-r** option.

---

- **-o filename**—Saves the output of template processing in XML format into the specified file. For example, to save the output in a file called *op\_file*, enter **-o op\_file**. This is an optional element.
- **-i device id**—Specifies the device to use for variable substitution when processing the template. Variable values are retrieved by using the device's properties. Use with the **-r** option.
- **-r filename**—Specifies name of template stored in the RDU. Use this option instead of the **-I** option.
- **-u username**—Specifies the username to be used when connecting to the RDU.
- **-p password**—Specifies the password to be used when connecting to the RDU.
- **-firmware**—Specifies the input file to be a firmware rule template. Otherwise, assume configuration template.

## Adding a Template to Cisco BAC

To use the configuration utility to test BAC templates:

- 
- Step 1** Develop the template as described in [Authoring Configuration Templates, page 5-14](#). If the template includes other templates, make sure all the referenced templates are in the same directory.
  - Step 2** Run the configuration utility on the local file system. You can check the syntax for the template, or have the configuration utility process template as IGS would, and return XML output.  
If the processed template uses `VAR()` constructs to reference a device property, the resulting output will contain the default values for those `VAR()` constructs.
  - Step 3** Add the template (and any included templates that are used) to the RDU.

If the template uses `VAR()` constructs to reference a device property, use the device option to generate a sample template.

**Step 4** After all tests succeed, configure a Class of Service to use the template.

## Validating XML Syntax for a Local Template File

Use the `runCfgUtil.sh` command to validate template files stored on the local file system.

### Syntax Description

```
runCfgUtil.sh -cwmp -a sc -l file
```

- **-cwmp**—Identifies the input file to be processed as a CWMP template file.
- **-a sc**—Specifies a syntax check.
- **-l**—Specifies that the input file is on the local file system.
- *file*—Identifies the input template file being validated.

To use a template file that is on the local file system:

**Step 1** Change directory to `/opt/CSCObac/rdu/samples/cwmp`.

**Step 2** Select a template file to use.



**Note** This example uses an existing template file called `sample-cwmp-config.xml`. The **-cwmp** option is used because this is a CWMP template. Run the configuration utility by using this command:

```
/opt/CSCObac/rdu/bin/runCfgUtil.sh -cwmp -a sc -l sample-cwmp-config.xml
```

- **-cwmp**—Identifies the input file as a CWMP template file.
- **-l**—Specifies that the input file is on the local file system.
- **sample-cwmp-config.xml**—Identifies the input template file being validated.

After running the utility, results similar to these should appear:

```
Broadband Access Center Configuration Utility
Version: 3.0, Revision: 1.26
validating configuration template sample-cwmp-config.xml...
>sample-cwmp-config.xml is valid.
```

## Validating XML Syntax for a Template Stored in Cisco BAC

Use the `runCfgUtil.sh` command to validate template files that are in the RDU database.

### Syntax Description

```
runCfgUtil.sh -cwmp -a sc -r file -u username -p password
```

- **-cwmp**—Identifies the input file to be processed as a CWMP template file.
- **-a sc**—Specifies a syntax check.
- **-r file**—Identifies the input file as a file that has been added to the RDU.
- **-u username**—Specifies the username to use when connecting to the RDU.
- **-p password**—Specifies the password to use when connecting to the RDU.

To validate a template file that has been added to the RDU:

---

**Step 1** Change directory to `/opt/CSCObac/rdu/samples/cwmp`.

**Step 2** Select a template file to use.



**Note** This example uses an existing template file called `sample-cwmp-config.xml`. The **-cwmp** option is used because a CWMP template is being used.

---

**Step 3** Run the configuration utility by using this command:

```
./runCfgUtil.sh -cwmp -a sc -r sample-cwmp-config.xml -u admin -p changeme
```

- **sample-cwmp-config.xml**—Identifies the input file.
- **admin**—Identifies the username.
- **changeme**—Identifies the password.
- **-cwmp**—Identifies the file as a CWMP template.

After running the utility, results similar to these should appear:

```
Broadband Access Center Configuration Utility
Version: 3.0, Revision: 1.26
validating configuration template sample-cwmp-config.xml...
>sample-cwmp-config.xml is valid.
```

---

## Testing Template Processing for a Local Template File

Use the **runCfgUtil.sh** command to test template processing for a local template file.

**Syntax Description** `runCfgUtil.sh -cwmp -a gc -l file -o file`

- **-cwmp**—Identifies the input file to be processed as a CWMP template file.
- **-a gc**—Specifies instructions for configuration generation.
- **-l file**—Specifies that the input file is on the local file system.
- **-o file**—Specifies that the processed template be saved in XML format into the specified file.

To test template processing for a local template file:

---

**Step 1** Change directory to `/opt/CSCObac/rdu/samples/cwmp`.

**Step 2** Select a template file to use. This example uses the existing template file, `sample-cwmp-config.xml`.

**Step 3** Run the configuration utility by using this command:

```
./opt/CSCOBac/rdu/bin/runCfgUtil.sh -cwmp -a gc -l sample-cwmp-config.xml -o output.xml
```

- **sample-cwmp-config.xml**—Identifies the input file.
- **output.xml**—Identifies the file in which to save the processed template in XML format.

After running the utility, results similar to these should appear:

```
Broadband Access Center Configuration Utility
Version: 3.0, Revision: 1.26
generating configuration from sample-cwmp-config.xml...
output.xml generated successfully.
```

You can view the configuration from the *output.xml* file.

## Testing Template Processing for a Template Stored in Cisco BAC

Use the `runCfgUtil.sh` command to test the template processing for a template in the RDU database.

### Syntax Description

```
runCfgUtil.sh -cwmp -a gc -r file -o file -u username -p password
```

- **-cwmp**—Identifies the input file to be processed as a CWMP template file.
- **-a gc**—Specifies instructions for configuration generation.
- **-r file**—Identifies the input file as a file that has been added to the RDU.
- **-o file**—Specifies that the processed template be saved in XML format into the specified file.
- **-u username**—Specifies the username to use when connecting to the RDU.
- **-p password**—Specifies the password to use when connecting to the RDU.

To test the template processing for a template stored in Cisco BAC:

**Step 1** Change directory to */opt/CSCOBac/rdu/samples/cwmp*.

**Step 2** Select a template file to use. This example uses the existing template file, *sample-cwmp-config.xml*.

**Step 3** Run the configuration utility by using this command:

```
./runCfgUtil.sh -cwmp -a sc -r sample-cwmp-config.xml -o output.xml -u admin -p changeme
```

- **sample-cwmp-config.xml**—Identifies the input file.
- **output.xml**—Identifies the file in which the generated configuration is to be saved in XML format.

After running the utility, results similar to these should appear:

```
Broadband Access Center Configuration Utility
Version: 3.0, Revision: 1.26
generating configuration from sample-cwmp-config.xml...
output.xml generated successfully.
```

You can view the configuration from the *output.xml* file.

## Testing Template Processing for a Cisco BAC Template File and a Device

Use the **runCfgUtil.sh** command to test the template processing for a file stored in the RDU database and associated with a device.

### Syntax Description

```
runCfgUtil.sh -cwmp -a gc -r file -o file -i deviceID -u username -p password
```

- **-cwmp**—Identifies the input file to be processed as a CWMP template file.
- **-a gc**—Specifies instructions for configuration generation.
- **-r file**—Identifies the input file as a file that has been added to the RDU.
- **-o file**—Specifies that the processed template be saved in XML format into the specified file.
- **-i deviceID**—Specifies the device to use. Variable values are retrieved using the device properties.
- **-u username**—Specifies the username to use when connecting to the RDU.
- **-p password**—Specifies the password to use when connecting to the RDU.

To test the template processing for a file stored in the RDU and associated with a device:

- Step 1** By using the administrator user interface, add the template file */opt/CSCObac/rdu/samples/cwmp/sample-cwmp-var-config.xml* to Cisco BAC.



**Note** The *sample-cwmp-var-config.xml* template has a reference to the */IPDevice/connectionRequestUsername* device property. The API constant for the property is `IPDeviceKeys.CONNECTION_REQUEST_USERNAME`.

- Step 2** Select a template file to use. This example uses the existing template file, *sample-cwmp-var-config.xml*.
- Step 3** Identify a device that is already in Cisco BAC and use that device's ID. This example uses a device with the */IPDevice/connectionRequestUsername* property set to *testUser*.
- Step 4** Identify the device to use. This example assumes that the device exists in the RDU and has the variables set as properties.
- Step 5** Run the configuration utility by using this command:

```
./runCfgUtil.sh -cwmp -a gc -r sample-cwmp-var-config.xml -i OUI-1234 -o output.xml -u admin -p changeme
```

- **sample-cwmp-var-config.xml**—Identifies the input file.
- **OUI-1234**—Identifies the ID of the device. The Device ID used here is for example purposes only.
- **output.xml**—Identifies the file in which to save the processed template in XML format.
- **bacadmin**—Identifies the default username being used in this example.
- **changeme**—Identifies the default password being used in this example.

After running the utility, results similar to these should appear:

```
Broadband Access Center Configuration Utility
Version: 3.0, Revision: 1.26
generating configuration from sample-cwmp-var-config.xml...
output.xml generated successfully.
```

**Note**

---

You can open the *output.xml* file to view the configuration. The

`VAR (name=/IPDevice/connectionRequestUsername, defaultValue=test)` statement will be replaced with *testUser*.

---



## CHAPTER 6

# Firmware Management

---

This chapter describes firmware management for TR-069 compliant devices in Cisco Broadband Access Center (Cisco BAC).

This chapter includes the following sections:

- [Overview, page 6-1](#)
- [Firmware Management Mechanisms, page 6-2](#)
- [Managing Firmware Files, page 6-5](#)
- [Authoring Firmware Rules Templates, page 6-6](#)
- [Using Template Constructs with Firmware Rule Templates, page 6-13](#)

## Overview

Firmware management consists of maintaining and distributing sets of firmware image files to corresponding customer premise equipment (CPE) through the Cisco BAC system. A firmware rules template associates the firmware image files to groups of devices. Cisco BAC uses the rules in the associated firmware rules template to evaluate which firmware to download to the device.

The firmware management functionality allows the administrator to view firmware information on devices, to add firmware images to the database, and to apply the image files to specific devices.

Cisco BAC supports two mechanisms for CPE firmware management:

- Policy-based firmware management through firmware rules templates.
- Direct firmware management through device operations API.

See [Firmware Rule Templates, page 6-2](#), and [Direct Firmware Management, page 6-4](#), for detailed information.

In the process of firmware management, regardless of the management method used, the device is instructed to obtain a new firmware image file from a file server. Cisco BAC provides a file service in its DPE. However, you can also direct CPE to other file servers.

Firmware rules can apply firmware to devices, based on a match of any preprovisioned or discovered device parameters, including device group membership, model, type, current state, type of connectivity, and so on.

The DPE triggers the firmware download by issuing a Download RPC with the location of the file on a file server and authentication credentials, if any. Cisco BAC supports HTTP and HTTP over SSL, called SSL/TLS in this chapter, for file downloads on DPE servers.

This download can be initiated in various modes:

- Firmware-rule based, in which firmware rules may or may not allow the download of the file requested by a device, or may download a different file. Firmware rules are executed whenever a device connects to the DPE.
- The device may contact the DPE, based on periodic contact after a reboot or a specific action, such as an user-initiated upgrade by clicking in the local user interface of the device. Regardless of how the device contacts the DPE, the firmware rules, determine whether the upgrade is needed and is allowed at the time of the particular interaction.
- Proxy, in which an external application invokes the API download operation for a specific device and specifies the firmware image file location. The DPE then executes the Download RPC on the device, causing the device to download the file from the specified location.

The download can occur in three ways:

- Immediate, in which the DPE connects to the device and instructs the device to download the firmware.
- On-connect, in which the DPE instructs the device to download the firmware on next contact with the device.
- Asynchronous, in which the DPE instructs the device to download the firmware without reserving the PACE thread at RDU. The operation result is sent to the API client in an `AyncOperationEvent`.

The multiple instance object support is available in the firmware template, which facilitates discovering the device parameters for multiple object instances. The parameter value associated with the discovered object instances is matched with the parameter values specified in the template, and further firmware rule is applied based on the match condition. For more information on multi-instance object support, see [Multi-Instance Object Support, page 4-5](#).

## Firmware Management Mechanisms

This section describes CPE firmware-management mechanisms provided by Cisco BAC. These comprise:

- Policy-based firmware management through firmware rules templates. See [Firmware Rule Templates, page 6-2](#), for detailed information.
- External firmware management through proxy operations. See [Direct Firmware Management, page 6-4](#), for detailed information.

## Firmware Rule Templates

You use rule templates to set policy-based firmware management. The firmware rules templates are XML documents written according to a published schema document. Each template must be stored in a file and uploaded into Cisco BAC.

Each firmware rules template contains one or more rules which trigger firmware updates based on specific conditions. Any number of such templates can be added to Cisco BAC, through the administrator user interface or API. The template is associated with a Class of Service object using the `COS_CWMP_FIRMWARE_RULES_FILE` property. Each device, in turn, is assigned to a Class of Service. (For information on Cisco BAC object relationships, see [Cisco BAC Device Object Model, page 4-2](#).)



In this model, you can make convenient updates to the definition of the rules, which apply to a large number of devices. When the rules template is updated, CPE that are indirectly associated with the template through the Class of Service are managed according to the new policy.

When the device establishes a connection with Cisco BAC, its firmware and configuration are automatically synchronized based on the configuration and firmware rules cached at the DPE. First, the firmware rules are executed, and if appropriate, the device firmware is updated. Then, the device configuration is synchronized.

Earlier to this release, the only file type supported by Cisco BAC was "1 Firmware Upgrade Image". With this release of Cisco BAC, firmware download is enhanced to allow upgrade of CPE devices with different vendor specific TR-069 download file types. Now vendor can define file type in both internal and external firmware rule tag.

Cisco BAC provides a two-stage firmware rule processing. First, the templates are processed at the RDU where template constructs such as conditionals and substitutable parameters are interpreted (See [Using Template Constructs with Firmware Rule Templates, page 6-13](#)).

This processing allows customization of rules for devices based on data available at the RDU (such as device properties and grouping). This data could be preprovisioned by using the API. Data previously discovered from the device and stored at the RDU can also be used in constructing the templates.

After the template has been processed, the resulting rules are sent to the DPEs in the device's provisioning group. The rules, in turn, can have dynamic matching criteria, which enable further granularity in firmware rules policy.

To determine if a firmware update is needed, the rules engine at the DPE evaluates the firmware rules. Firmware rules allow a firmware update to be triggered on match of:

- Inform event types
- Device RequestDownloadRPC arguments
- Inform parameter values
- Any other device parameter values
- MaintenanceWindow time

**Note**

You can use the MaintenanceWindow option to schedule firmware downloads to a device. For details, see [Device Contact During MaintenanceWindow, page 5-12](#).

Together, these rules provide a powerful mechanism to create policy for managing firmware. For example, an administrator can write a rule that forces all devices of a certain model with a certain current firmware version to upgrade to a different firmware, during a specific service time window.

The DPE logs an entry for all cases of firmware selection by using rules. It also logs an entry if none of the rules match. This logging mechanism can be useful to track devices that have no firmware image file associated with them or if the device firmware is simply up to date.

Cisco BAC uses the XML schemas that are defined in various files to generate instructions for device configurations. [Table 6-1](#) lists these files and their locations.

**Table 6-1 Files Used in Firmware Rules Template Processing**

File	Purpose	Options Available in Cisco BAC
Firmware Rules Template Samples	Defines device configuration	Sample templates
	<b>Sample templates are located at:</b> <BPR_HOME>/rdu/samples/cwmp	
Firmware Rule Template Schema	Validates firmware rules template syntax	Default template schemas
	<b>Default template schemas are located at:</b> <ul style="list-style-type: none"> <li>Firmware rules template schema &lt;BPR_HOME&gt;/rdu/templates/cwmp/schema/FirmwareTemplateSchema.xsd</li> <li>Common template schema &lt;BPR_HOME&gt;/rdu/templates/cwmp/schema/CommonTemplateConstructs.xsd</li> </ul>	
Parameter Dictionary	Validates firmware rules template content	Default dictionaries
	<b>Default dictionaries are located at:</b> <ul style="list-style-type: none"> <li>&lt;BPR_HOME&gt;/rdu/templates/cwmp/dictionary/tr069-cwmp-dictionary.xml</li> <li>&lt;BPR_HOME&gt;/rdu/templates/cwmp/dictionary/tr098-cwmp-dictionary.xml</li> <li>&lt;BPR_HOME&gt;/rdu/templates/cwmp/dictionary/tr104-cwmp-dictionary.xml</li> <li>&lt;BPR_HOME&gt;/rdu/templates/cwmp/dictionary/tr106-cwmp-dictionary.xml</li> <li>&lt;BPR_HOME&gt;/rdu/templates/cwmp/dictionary/tr196-cwmp-dictionary-v1.1.xml</li> <li>&lt;BPR_HOME&gt;/rdu/templates/cwmp/dictionary/tr196-cwmp-dictionary-v2.0.xml</li> <li>&lt;BPR_HOME&gt;/rdu/templates/cwmp/dictionary/tr196-cwmp-dictionary-IGD-v1.1.xml</li> <li>&lt;BPR_HOME&gt;/rdu/templates/cwmp/dictionary/tr196-cwmp-dictionary-IGD-v2.0.xml</li> <li>&lt;BPR_HOME&gt;/rdu/templates/cwmp/dictionary/basic-cwmp-dictionary.xml</li> </ul>	
Parameter Dictionary Schema	Validates parameter dictionary syntax	Default dictionary
	<b>Parameter dictionary schema is located at:</b> Schema for TR-069, TR-098, TR-104, TR-106, TR-181, and TR-196 dictionaries <BPR_HOME>/rdu/templates/cwmp/schema/TemplateDictionarySchema.xsd	

## Direct Firmware Management

The Cisco BAC device operations API allows the OSS to execute operations on individual devices. Among other operations, Cisco BAC provides standard CWMP RPC operations.

Managing firmware using device operations API gives the OSS precise control over operations performed on CPE. The OSS issues specific API calls which correspond to remote procedure calls (RPCs) necessary for CPE firmware update.

For example, a Download RPC can be invoked on the device using a corresponding API call. This command contains the URL of the firmware image file that the device should download and, if necessary, authentication credentials.

For detailed information on device operations, see [CWMP Device Operations, page 14-1](#).

**File Service**

In the process of firmware management and regardless of which management method is used, the device is instructed to obtain a new firmware file from a file server. Cisco BAC provides a file service in its DPE servers. However, CPE can also be directed to other file servers if necessary. For the various configuration options that Cisco BAC supports, see [CWMP Service Configuration, page 12-1](#).

## Managing Firmware Files

Firmware file management comprises the management of firmware image files and firmware rule template files. This functionality allows the administrator or applications by using the API to add, delete, or replace firmware image files and firmware rule template files, and view and search firmware image files and file information.

You can manage firmware through the administrator user interface, or through the API. To manage firmware image file and firmware rule templates on the administrator user interface, choose **Configuration > Files**.

Firmware rule template files determine the firmware image for a device. These files are stored in the RDU database with the file type `Firmware Rules Template`.

Firmware image files are stored in the RDU database with file type `Firmware File`. Each firmware image file has a firmware version that is specified by using the `Firmware Version` attribute. The DPE uses the firmware version information to evaluate firmware rules.

**Note**

While firmware images are managed using the central server (RDU), they are automatically distributed or deleted from the appropriate DPEs.

Firmware file management allows the following operations for each file type:

**Table 6-2** *Firmware File Management Operations*

Firmware Image File	Firmware Rules Template
Add	Add You can add a firmware rule template file to the system only if it is valid; otherwise, Cisco BAC displays error messages explaining the type of error in the template.
Delete You cannot delete an existing firmware image file if it is referenced in a firmware rules template. To successfully delete a firmware image file, remove the reference to the firmware file in the firmware rules template.	Delete You cannot delete a firmware rules template if it is referenced by a Class of Service. To successfully delete a firmware rules template, remove the reference to the Class of Service.
Retrieve contents	Retrieve contents
Retrieve file attributes, such as size, name, and properties	-

Table 6-2 Firmware File Management Operations (continued)

Firmware Image File	Firmware Rules Template
<p>Replace contents and/or modify file attributes/properties</p> <p>You can replace an existing firmware image file even if the file is associated to a firmware file template using the API. The administrator user interface, however, notifies of existing associations before replacing a firmware image file.</p> <p>When a firmware image file's contents are replaced, IGS regenerates firmware rules for each affected device and IGS distributes them to the DPEs in the device's provisioning group. Subsequently, when the device contacts the DPE, new rules are executed.</p>	<p>Replace file contents, modify file attributes and properties, or both</p>
Search by name, suffix, regex or file type	-
-	<p>View templates in tabular form from the administrator user interface</p> <p>Templates appear in tabular form only if they do not include conditionals.</p>

## Authoring Firmware Rules Templates

Firmware rule templates in Cisco BAC are based on an XML schema file located at `<BPR_HOME>/rdu/templates/cwmp/schema/FirmwareTemplateSchema.xsd`.

Firmware rules execute after processing an Inform from the device. They are also triggered after the device issues a RequestDownload RPC.

A firmware rules template comprises:

- **FirmwareTemplate**—The root element, which can contain a Prerequisites tag, and one or more named FirmwareRule elements.

Firmware rules are processed in order and, once a firmware rule matches, further rules are not processed.

- **TemplateVersion**—A TemplateVersion attribute has been introduced to support the different firmware file types and the download of large firmware files. In the FirmwareTemplate configuration file, the template version must be set to 3.0 to enable multi-instance object support feature. If the template version is not provided or is set to 1.0, the new features will not work as expected.

- **Prerequisites**—Contains conditions which must be met before the rules listed in the firmware rule template are processed. Prerequisites may contain zero or one MaintenanceWindow, and zero or more Expressions.

You can enable Expressions and MaintenanceWindow for firmware templates just as it is done for configuration templates.

- **MaintenanceWindow**—Describes the time range within which the firmware rule template is valid for processing. For detailed information, see [Prerequisites, page 5-9](#).

- Expression—Zero or more expression for evaluating this rule; has the same syntax and definition as the Expression defined for the *FirmwareRule* element. For detailed information, see [Expression and Regular Expression, page 6-7](#).
- **FirmwareRule**—Each FirmwareRule element provides:
  - Expression—Zero or more expressions for evaluating this rule. The rules triggers a firmware update if all expressions in a given rule match. For detailed information, see [Expression and Regular Expression, page 6-7](#).
  - InternalFirmwareFile or ExternalFirmwareFile—One of the two must be specified.
  - InternalFirmwareFile is used if the Cisco BAC file service is utilized, and the firmware image file has been added to the system using the API or the administrator user interface.
  - ExternalFirmwareFile provides information for firmware image files located on external file servers.

For detailed information, see [Internal Firmware File vs. External Firmware File, page 6-10](#).

## Expression and Regular Expression

Expressions provide a conditional way to apply the firmware rules based on value match. If the value is a range, Regular Expression (Regex) is used for defining the firware rule in firmware rule template. Regular expression provides a conditional way to apply the firmware rules based on Regex pattern match. Each expression or Regex must provide a *ParameterName*, *InformParameterName* or *RpcArgumentName* tag, one or more *Value* tags and an *Operator* tag.

The value of the event returned from the CPE, and the condition specified for the event determines whether the firmware rule is applied to the CPE. The firmware rules are defined in the firmware template with the appropriate event, Regex pattern associated with the event, and the condition for applying the firmware rule.

Regex support is also available in the configuration templates prerequisites. For more information on configuring prerequisites, see [Configuring Prerequisites, page 5-13](#).

Cisco BAC processes these tags in sequence to match and assign a firmware image file to the CPE.

### ParameterName

Specifies the name of a TR-069 parameter. The *ParameterName* is validated by using the relevant parameter dictionary.

The DPE may have this parameter available from Inform or from prior GetParameterValues RPCs calls within the same session. If the parameter value is not available in the session when processing the rule, the DPE queries the device for the missing parameter values before proceeding with evaluation of the rules.

For additional information, see [Parameters, page 5-6](#).

### InformParameterName

Specifies the name of an Inform parameter that is not described in the parameter dictionary. This entry is not validated.

For example, the expression in the following example evaluates to *true* if the device `Inform.EventCode` includes either of the specified values:

```
<Expression>
  <InformParameter>Inform.EventCode</InformParameter>
  <Value>1 BOOT</Value>
```

```
<Value>3 SCHEDULED</Value>
<Operator>match</Operator>
</Expression>
```

Cisco BAC supports the following parameter names in the InformParameter tag:

- Inform.DeviceId.Manufacturer
- Inform.DeviceId.ManufacturerOUI
- Inform.DeviceId.ProductClass
- Inform.DeviceId.SerialNumber
- Inform.EventCode

For information on the values for Inform.EventCode, refer to the DSL Forum's Technical Report on TR-069.

### Value

Specifies data for the Parameter. One or more possible values might be listed for a given parameter. The data type for a value is validated by using a dictionary when possible.

In the expression, if you need to set a value that contains comma, then specify each item of the value separated by a comma in separate value tag. For example, the comma-separated value *12.4(22)T, RELEASE SOFTWARE (fc1)* can be set as in the following expression:

```
<Expression>
<ParameterName>InternetGatewayDevice.DeviceInfo.SoftwareVersion</ParameterName>
<Value>12.4(22)T</Value>
<Value>RELEASE SOFTWARE (fc1)</Value>
<Operator>match</Operator>
</Expression>
```

You can also set the value as empty.

### RpcArgumentName

Specifies the name for a parameter that the device reports. The possible values are RequestDownload.FileType and RequestDownload.FileTypeArg\\*

- RequestDownload.FileType indicates the type of file that the device is requesting to download.
- RequestDownload.FileTypeArg\\* indicates any argument that the device might have provided in a download request message. The asterisk (\*) denotes the actual argument name.

See [Example 6-3](#).

### Operator

Evaluates the Parameter and the Value. In evaluating the expression, the *Operator* may be one of the following:

- match—Specifies that the device parameter value must match at least one of the values in a case-sensitive comparison.
- matchIgnoreCase—Specifies that the device parameter value must match at least one of the values in a case-insensitive comparison.
- matchAll—Specifies that the device parameter value must match all of the values in a case-sensitive comparison.
- matchAllIgnoreCase—Specifies that the device parameter value must match all of the values in a case-insensitive comparison.

- `noMatch`—Specifies that the device parameter value must not match any of the values in a case-sensitive comparison.
- `noMatchIgnoreCase`—Specifies that the device parameter value must not match any of the values in a case-insensitive comparison.

#### Example 6-1 Expression - match InformParameterName

In the following sample expression, the match condition indicates that the subsequent rules are valid when the *InformParameter* `Inform.EventCode` has exactly the value `1 BOOT`. The device reports this value in the Inform message when it contacts the autoconfiguration server (ACS).

```
<Expression>
<InformParameterName>Inform.EventCode</InformParameterName>
  <Value>1 BOOT</Value>
  <Operator>match</Operator>
</Expression>
```

#### Example 6-2 Expression - match RpcArgumentName (RequestDownload.FileType)

In the following sample expression, the match condition indicates that the subsequent rules should be in effect when the *RpcArgumentName* `RequestDownload.FileType` matches exactly the value `1 Firmware Upgrade Image`.

```
<Expression>
  <RpcArgumentName>RequestDownload.FileType</RpcArgumentName>
  <Value>1 Firmware Upgrade Image</Value>
  <Operator>match</Operator>
</Expression>
```

#### Example 6-3 Expression - match RpcArgumentName (RequestDownload.FileTypeArg)

In the following sample expression, the match condition indicates that the subsequent rules should be in effect when the *RpcArgumentName* `RequestDownload.FileTypeArg.Version` matches the value `1.1`.



**Note** The CWMP specification defines `Version` to be a `FileTypeArg` that you can use if File Type is Web Content.

```
<Expression>
  <RpcArgumentName>RequestDownload.FileType</RpcArgumentName>
  <Value>2 Web Content</Value>
  <Operator>match</Operator>
</Expression>
<Expression>
  <RpcArgumentName>RequestDownload.FileTypeArg.Version</RpcArgumentName>
  <Value>1.1</Value>
  <Operator>match</Operator>
</Expression>
```

#### Example 6-4 Expression - noMatch ParameterName

In the following sample expression, the match condition indicates that the subsequent rules should be in effect when the *Parameter* `InternetGatewayDevice.DeviceInfo.SoftwareVersion` does not match the software version `1.02`.

```
<Expression>
  <ParameterName>InternetGatewayDevice.DeviceInfo.SoftwareVersion</ParameterName>
```

```
<Value>1.02</Value>
<Operator>noMatch</Operator>
</Expression>
```

While specifying the Regex pattern, the operator tag may be one of the following:

- **regexMatch**—Indicates a condition that is set to ensure that the firmware rule is applied only when the device parameter value matches the Regex pattern.
- **regexNoMatch**—Indicates a condition that is set to ensure that the firmware rule is applied only when the device parameter value does not match the Regex pattern.

#### Example 6-5 Expression - regexMatch

In the following sample expression, the regexMatch condition indicates that the firmware rule comes into effect when the *Parameter Inform.EventCode* matches Regex pattern `^[0-9]\s\w`.

```
<Expression>
  <InformParameterName>Inform.EventCode</InformParameterName>
  <Value>^[0-9]\s\w</Value>
  <Operator>regexMatch</Operator>
</Expression>
```

If the condition is specified as regexNoMatch, the firmware rule is applied only when the *Inform.EventCode* does not match the Regex pattern `^[0-9]\s\w` specified in the value tag.



**Note**

---

Under expression, if the operator is regexMatch or regexNoMatch, ensure that only one value tag is used.

---

## Internal Firmware File vs. External Firmware File

The Internal and External firmware image file elements define whether the firmware image files are located within the Cisco BAC file server or at remote file server.

### InternalFirmwareFile

The InternalFirmwareFile element describes the filename of the firmware image that was added to the RDU and automatically distributed to DPEs and the delivery transport method employed to download the firmware image to a device. It comprises:

- *FileName*—Specifies the name of the file in the RDU database.
- *DeliveryTransport*—Specifies service HTTP 1 or service HTTP 2 transfer.

You should configure the corresponding file service (HTTP 1 or HTTP 2) on the DPE. For configuration details, see the [Cisco Broadband Access Center 3.8 DPE CLI Reference](#).

If you define multiple services on the DPE with the same transport, for example, two HTTP, the DPE chooses the first one to service the device.

- *FileType*—Specifies the vendor specific download FileType element. This element is optional. The default value is 1 Firmware Upgrade Image. The template version must be set to 2.0 to enable this feature.
- *Location*—Specifies the location where the files are stored. Possible values are Cache and File System. The default value is Cache. Specifying the location is optional and to enable this, you must set the template version to 2.0.



- *FileSize*—Specifies the size of the file. This is mandatory when the location is File System. The FileSize can also be set to 0.

### Examples

```
<InternalFirmwareFile>
  <FileName>sample-firmware-image1.bin</FileName>
  <DeliveryTransport>service http 1</DeliveryTransport>
  <FileType>X CISCO_COM DLCImage</FileType>
  <Location>File System</Location>
  <FileSize>1234</FileSize>
</InternalFirmwareFile>
```

## ExternalFirmwareFile

The ExternalFirmwareFile element describes the name of a firmware image file located at a remote server. It comprises:

- *FileURL*—Specifies the URL for a firmware image file located at remote location.
- *FileSize*—Specifies the size of the firmware image file to be downloaded. The FileSize can also be set to 0.
- *AuthenticationCredentials*—Specifies the username and password to use if HTTP authentication is enforced by the file server. The username and password are transmitted using the Download RPC to the device.
- *FileType*—Specifies the vendor specific download FileType element. This element is optional. The default value is 1 Firmware Upgrade Image. The template version must be set to 2.0 to enable this feature.



**Note** Ensure that you use SSL/TLS for CWMP to avoid transferring passwords in clear text.

You can use substitutable parameters to make the template-processing engine derive a device-specific username and password from the device record when processing firmware rules at the RDU.

### Examples

```
<ExternalFirmwareFile>
  <FileURL>http://imageserver.isp.com/sample-firmware-image.bin</FileURL>
  <FileSize>3449</FileSize>
  <AuthenticationCredentials>
    <HttpUserName>test</HttpUserName>
    <HttpPassword>changeme</HttpPassword>
  </AuthenticationCredentials>
  <FileType>X CISCO_COM DLCImage</FileType>
</ExternalFirmwareFile>
```

## Sample Firmware Rules Template

The following is an example of a firmware template that supports the new feature like multi-instance object support and features supported in earlier versions of firmware template.

```
<FirmwareTemplate templateVersion="3.0">
  <Prerequisites>
```

```

<MaintenanceWindow>
  <StartTime>01:00:00</StartTime>
  <Duration>5:00</Duration>
</MaintenanceWindow>
<Expression>
  <InformParameterName>Device.DeviceInfo.EventCode</InformParameterName>
  <Value>1 BOOT</Value>
  <Operator>match</Operator>
</Expression>
<Expression>
  <ParameterName>Device.DeviceInfo.HardwareVersion</ParameterName>
  <Value>W3GFP-100-Rev 6.0</Value>
  <Operator>matchIgnoreCase</Operator>
</Expression>
<Expression>
  <ParameterName>Device.Services.FAPService.{i}.REM.UMTS.GSM.Cell.{i}.BSIC</ParameterName>
  <InstanceConfiguration>
    <Instance>
      <Path>Device.Services.FAPService.</Path>
      <Value>last()</Value>
    </Instance>
    <Instance>
      <Path>Device.Services.FAPService.{i}.REM.UMTS.GSM.Cell.</Path>
      <Value>compare(LAC lessThanEquals 65534)</Value>
    </Instance>
    <MatchCondition>OR</MatchCondition>
  </InstanceConfiguration>
  <Value>18</Value>
  <Operator>matchAllIgnoreCase</Operator>
</Expression>
</Prerequisites>
<FirmwareRule name="InternalFileRule">
  <Expression>
    <InformParameterName>Device.DeviceInfo.SoftwareVersion</InformPaameterNam>
    <Value>5.4.0</Value>
    <Operator>match</Operator>
  </Expression>
  <Expression>
    <ParameterName>Device.Services.FAPService.{i}.REM.UMTS.GSM.Cell.{i}.BSIC</ParameterName>
    <InstanceConfiguration>
      <Instance>
        <Path>Device.Services.FAPService.</Path>
        <Value>compare(DeviceType equalsIgnoreCase fap)</Value>
      </Instance>
      <Instance>
        <Path>Device.Services.FAPService.{i}.REM.UMTS.GSM.Cell.</Path>
        <Value>1</Value>
      </Instance>
      <MatchCondition>OR</MatchCondition>
    </InstanceConfiguration>
    <Value>18</Value>
    <Operator>matchAllIgnoreCase</Operator>
  </Expression>
  <InternalFirmwareFile>
    <FileName>sample-firmware-image.bin</FileName>
    <DeliveryTransport>HTTP</DeliveryTransport>
    <Location>File System</Location>
    <FileSize>1234</FileSize>
    <FileType>X CISCO_COM DLCImage</FileType>
  </InternalFirmwareFile>
</FirmwareRule>
<FirmwareRule name="ExternalFirmwareRule">

```

```

<Expression>
  <InformParameterName>Device.DeviceInfo.SoftwareVersion</InformParameterName>
  <Value>5.4.1</Value>
  <Operator>match</Operator>
</Expression>
<ExternalFirmwareFile>
  <FileURL>http://10.10.10.10:889/sample-firmware-image.bin</FileURL>
  <FileSize>3449</FileSize>
  <AuthenticationCredentials>
    <HttpUserName>test</HttpUserName>
    <HttpPassword>changeme</HttpPassword>
  </AuthenticationCredentials>
  <FileType>X CISCO_COM DLCImage</FileType>
</ExternalFirmwareFile>
</FirmwareRule>
</FirmwareTemplate>

```

## Using Template Constructs with Firmware Rule Templates

You can use the Cisco BAC template-processing mechanism to generate customized configurations for a large numbers of CPE by using a small number of templates. The use of template constructs enables this mechanism.

Template constructs are any of the **tc:include**, **tc:if**, and **tc:choose** conditional statements, which are used in conjunction with Cisco BAC properties. The template processor processes the constructs when generating instructions for a device. The instructions are then forwarded to the DPE and cached there.

FirmwareRules, on the other hand, are tags within a firmware rule template and describe the firmware image to send to the device. Firmware rules may include expressions that are evaluated when the device contacts Cisco BAC to retrieve configuration. If the expressions evaluate to *true*, the device is instructed to download a specific firmware image file.

Firmware rules can apply firmware to devices based on a match of any preprovisioned or discovered device parameters, including device group membership, model, type, current state, type of connectivity, and so on. This processing is done at the RDU, with the preprovisioned or discovered data available at the central server.

This release supports the following general classes of template constructs:

- Parameter substitutions—Rule content can be inserted based on parameter values stored on device records or other objects within the Cisco BAC data model.

See [Using Parameter Substitution, page 6-14](#) for more information.

- Includes—One template may include another.

See [Using Includes, page 6-14](#) for more information.

- Conditional expressions—Rule content can be inserted based on evaluation of conditional statements.

See [Using Conditionals, page 6-15](#) for more information.

You use XML tags with the prefix **tc** to specify these template constructs.



### Note

Elements prefixed by **tc** are generic constructs that are the same for firmware rule templates and configuration templates.

Cisco BAC firmware rules constructs are based on the XML schema defined in the file located at:

- `<BPR_HOME>/rdu/templates/cwmp/schema/FirmwareTemplateSchema.xsd`
- `<BPR_HOME>/rdu/templates/cwmp/schema/CommonTemplateConstructs.xsd`



---

**Note** The XML namespace of the Cisco BAC Common Template constructs is defined as `xmlns:tc='urn:com:cisco:bac:common-template'`.

---

## Using Parameter Substitution

Values from the Cisco BAC property hierarchy are substituted into a template by using the `VAR()` construct, in order to produce firmware rules specific to a given device. The `VAR()` construct can appear in an XML element value or element attribute. It can also be used to substitute full or partial values.

The following list describes the constructs that Cisco BAC supports for parameter substitution:

- Cisco BAC property value into XML element content
- Cisco BAC property value into XML element attribute
- Default value
- XML partial element content
- Values with special characters

For syntax and specific examples, see [Using Parameter Substitution, page 5-16](#).

## Using Includes

You use Include files to build a set of reusable template snippets. These files are useful for defining options that are common across many classes, without having to duplicate the options in several templates.

You can include the content of a particular file to a template by using the `tc:include` construct. After inserting the content of included files into the host template, the Parameter Dictionary specified in the host template, validates the content of the resulting template.



**Note**

---

If included templates use objects and parameters that are not defined in the same dictionary as the host template, parameter validation fails during instruction generation.

---

The `tc:Include` element specifies the `href` attribute, where `href` identifies the name of the Cisco BAC template file that is included in the host template. Use double quotation marks (") when using an Include directive in a template.



**Note**

---

When one template is included in another, the parameter dictionary and prerequisite tags from the included template are ignored. The schema of the firmware template enforces the location of an Include tag within a firmware template.

---

For syntax and specific examples, see [Using Includes, page 5-17](#).

## Using Conditionals

Cisco BAC supports powerful conditional expressions in template constructs to enable ultimate configuration customization. You can use these conditional expression constructs to include or exclude blocks of text within a template. These construct elements are **tc:if**, **tc:choose**, and **tc:when**. For detailed information and specific examples on conditionals, see [Using Conditionals, page 5-19](#).

By using conditionals, you can also enable devices to bypass firmware upgrade. If a device does not match the required conditions specified in the firmware rules template, then the device bypasses an upgrade. See [Example 6-6](#).

### Example 6-6 Firmware Upgrade Bypass

The following is an example of a firmware rule template that describes a firmware upgrade bypass using the **if** construct.

If `checkVersion` is set to *true*, the rules check the software version on the device; if the version does not match, firmware upgrade is bypassed. If `checkVersion` is set to *false*, the rules do not check for the software version and the device gets instructions on firmware download.

```
<tc:Template xmlns:xsi="http://www.w3.org/2001/XMLSchema-instance"
xmlns:tc="urn:com:cisco:bac:common-template" xmlns="urn:com:cisco:bac:firmware-template"
xsi:schemaLocation="urn:com:cisco:bac:common-template CommonTemplateConstructs.xsd">
<FirmwareTemplate>
  <ParameterDictionaries>
    <ParameterDictionary>tr069-cwmp-dictionary.xml</ParameterDictionary>
  </ParameterDictionaries>
  <!-- Upgrade rule: if software version is 0.00.22, direct the device to download
sample-firmware-image.bin -->
  <!-- devices that do not have software version 0.00.22 , will bypass firmware
upgrade. -->
<FirmwareRule name="LinksysWAG54G2Rule">
  <tc:if test="equals(VAR(name=/cpe/checkVersion,defaultValue=false), true)">
    <Expression>
      <ParameterName>InternetGatewayDevice.DeviceInfo.SoftwareVersion</ParameterName>
      <Value>0.00.22</Value>
      <Operator>matchIgnoreCase</Operator>
    </Expression>
  </tc:if>

  <InternalFirmwareFile>
    <FileName>sample-firmware-image.bin</FileName>
    <DeliveryTransport>service http 1</DeliveryTransport>
  </InternalFirmwareFile>
</FirmwareRule>
```





## CHAPTER 7

# Parameter Dictionaries

---

This chapter describes Parameter Dictionaries which are used in the process of configuring and managing customer premises equipment (CPE) for CWMP.

This chapter includes the following sections:

- [Overview, page 7-1](#)
- [Using Default Dictionaries, page 7-2](#)
- [Custom Dictionaries, page 7-3](#)
- [Parameter Dictionary Syntax, page 7-3](#)
- [Managing Parameter Dictionaries through User Interface, page 7-5](#)

## Overview

Parameter dictionaries are XML files that list valid objects and parameters that Cisco BAC uses to configure a CWMP device. The dictionaries validate the objects and parameters used in the configuration and firmware rule templates.

Parameter dictionaries provide metadata about the supported objects and parameters, such as name, type, writeability and readability. Each dictionary is stored in a file and added to the RDU through the management API or the administrator user interface.

Configuration and firmware rule templates include a *ParameterDictionary* tag, an indicator of which dictionary defines the parameters in a given template. Cisco BAC validates configuration and firmware rule templates by using the dictionary to which the templates refer. All parameter names and values in the configuration and firmware rule template must be compatible with the parameters referenced in the parameter dictionary.

Figure 7-1 illustrates the schema of a parameter dictionary.

**Figure 7-1** Parameter Dictionary Schema

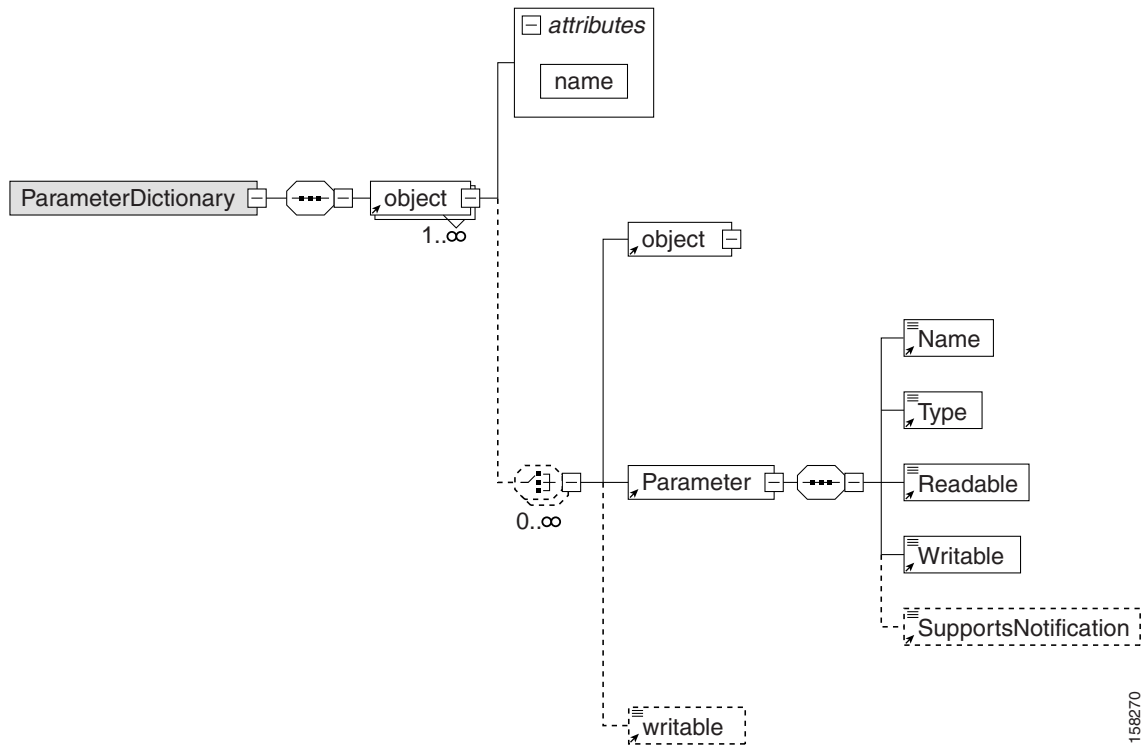

Configuration or firmware rules template processing fails during instruction generation if there are errors in the template. To avoid configuration instruction generation errors, ensure that all:

- The object names and parameter names exist in the dictionary.
- The parameter values specified in templates directly or through substitutable parameters are of the type specified in the dictionary.
- Parameters that are not writable do not have a value. However, they may have the notification, access control, or both attributes set in configuration templates.

## Using Default Dictionaries

This Cisco BAC release provides default dictionaries according to the parameters defined in the TR-069, the TR-098, TR-104, TR-181, and the TR-196 specifications. Each of the specifications cover the following data models:

- TR-069—Internet Gateway Device data model 1.0.
- TR-098—Internet Gateway Device data model 1.1, including extensive QoS capabilities.
- TR-104—VoIP data model for gateway or standalone ATA.
- TR-181—Device data model for TR-069 issue 2 amendment 2.
- TR-196—Femto Access Point Service data model amendment 1 and issue 2.

For administrative convenience, the *basic-cwmp-dictionary.xml* dictionary provides a combination of all standard parameters (TR-098 and TR-104).



These default dictionaries are located at:

- <BPR\_HOME>/rdu/templates/cwmp/dictionary/tr069-cwmp-dictionary.xml
- <BPR\_HOME>/rdu/templates/cwmp/dictionary/tr104-cwmp-dictionary.xml
- <BPR\_HOME>/rdu/templates/cwmp/dictionary/tr098-cwmp-dictionary.xml
- <BPR\_HOME>/rdu/templates/cwmp/dictionary/tr196-cwmp-dictionary-v1.1.xml
- <BPR\_HOME>/rdu/templates/cwmp/dictionary/tr196-cwmp-dictionary-v2.0.xml
- <BPR\_HOME>/rdu/templates/cwmp/dictionary/tr196-cwmp-dictionary-IGD-v1.1.xml
- <BPR\_HOME>/rdu/templates/cwmp/dictionary/tr196-cwmp-dictionary-IGD-v2.0.xml
- <BPR\_HOME>/rdu/templates/cwmp/dictionary/basic-cwmp-dictionary.xml

**Note**

---

You cannot modify or delete the default dictionaries in Cisco BAC.

---

You can add new user-defined dictionaries that templates reference. This feature enables Cisco BAC support for CPE parameter models, including vendor-specific parameters. For additional information, see the subsequent section on [Custom Dictionaries](#). Cisco BAC support for vendor-specific dictionaries enables its use with any emerging data models such as WT-135 (IPTV STB) or WT-140 (NAS).

## Custom Dictionaries

CWMP includes an extensibility mechanism that allows the use of vendor-specific parameters in addition to the standard parameters. Thus, you can add custom dictionaries to the Cisco BAC system to support any CPE. You can use this feature to support devices with practically any data model, including emerging standard data models such as WT-135 (IPTV STB) or WT-140 (NAS).

You can add, view, replace, or delete custom dictionaries to or from Cisco BAC through the administrator user interface or the management API.

**Note**

---

You cannot use custom dictionaries for configuration templates. Cisco BAC configuration templates can only use the parameter dictionaries in the Cisco BAC database.

---

While adding custom dictionaries, ensure that they are based on the parameter dictionary schema, described in earlier sections.

---

## Parameter Dictionary Syntax

Cisco BAC validates the syntax of a parameter dictionary according to the Parameter Dictionary Schema, located at <BPR\_HOME>/rdu/templates/cwmp/TemplateDictionarySchema.xsd.

If you want to add a vendor-specific parameter to a standard object, remember to define all higher-level standard objects and their parameters in the custom dictionary.

Cisco BAC supports all data types that are defined in the TR-069 and TR-196 specification. The Parameter Dictionary specifies the data types that this Cisco BAC release supports, as listed in [Table 7-1](#):

**Table 7-1 Cisco BAC Supported Data Types**

Type	Description
String	A maximum allowed length may be listed using the <code>string (N)</code> syntax, where (N) is the maximum string length in characters.  You can also give a value range by using the <code>string[Min:Max]</code> syntax, where the Min and the Max values are inclusive. If Min or Max are missing, this indicates no limit.
int	An integer in the range of -2147483648 to +2147483647, inclusive.  You can give a value range by using the <code>int[Min:Max]</code> syntax, where the Min and the Max values are inclusive. If Min or Max are missing, this indicates no limit.
unsignedInt	An unsigned integer in the range 0 to 4294967295, inclusive.  You can give a value range using the <code>unsignedInt[Min:Max]</code> syntax, where the the Min and the Max values are inclusive. If Min or Max are missing, this indicates no limit.
boolean	A value, where 1 represents true, and 0 represents false.
dateTime	The time expressed in UTC (Universal Coordinated Time) unless stated otherwise; for example, <b>2004-01-03T03:04:05-(or +)05:00</b>
base64	You can use the <code>base 64 (N)</code> syntax to specify a maximum allowed length, where (N) is the maximum length in characters after Base64 encoding.
hexBinary	You can use the <code>hexBinary (N)</code> syntax to specify a maximum allowed length, where (N) is the maximum length in characters after hex encoding.  You can also give a value range by using the <code>int[Min:Max]</code> syntax, where the Min and the Max values are inclusive. If Min or Max are missing, this indicates no limit.

## Sample Parameter Dictionary

The following is a sample from the TR-069 parameter list, with its corresponding dictionary schema:

Name	Type	Write	Read
InternetGatewayDevice	Object	-	R
InternetGatewayDevice.DeviceInfo	Object	-	R
X_HGI_ALG	Object	-	R
X_08017_ChipModel	string	-	R
ALGNumberOfEntries	unsignedInt	-	R
Manufacturer	string(64)	-	R

```
<ParameterDictionary xmlns:xsi="http://www.w3.org/2001/XMLSchema-instance"
xsi:noNamespaceSchemaLocation="TemplateDictionarySchema.xsd">
<Object name="InternetGatewayDevice">
```

```

<Object name="DeviceInfo">
  <Writable>>false</Writable>
  <Parameter>
    <Name>Manufacturer</Name>
    <Type>string(64)</Type>
    <Readable>>true</Readable>
    <Writable>>false</Writable>
  </Parameter>
  <Parameter>
    <Name>X_08017_ChipModel</Name>
    <Type>string</Type>
    <Readable>>true</Readable>
    <Writable>>false</Writable>
  </Parameter>
</Object>
<!-- custom property: InternetGatewayDevice.X_HGI_ALG -->
<!-- as defined for HGI's Application Layer Gateway Management -->
<Object name="X_HGI_ALG">
  <Parameter>
    <Name>ALGNumberOfEntries</Name>
    <Type>unsignedint</Type>
    <Readable>>true</Readable>
    <Writable>>false</Writable>
  </Parameter>
</Object>
</Object>
</ParameterDictionary>

```

## Managing Parameter Dictionaries through User Interface

You can use the administrator user interface to manage parameter dictionary files, and view, add, delete, or replace parameter dictionaries. To export files, see [Exporting Files, page 17-19](#).



### Note

You cannot modify or delete the default dictionaries.

## Adding Parameter Dictionaries

To add a new parameter dictionary to the Cisco BAC RDU database:

- Step 1** Choose **Configuration** on the Primary Navigation bar.
- Step 2** Choose **Files** on the Secondary Navigation bar. The View Files page appears.
- Step 3** Click **Add**.  
The Add Files page appears.
- Step 4** Choose Parameter Dictionary from the File Type drop-down list.
- Step 5** Browse for the Source File Name.
- Step 6** Enter the File Name.
- Step 7** Click **Submit**.

The View Files page appears with the new file.

## Viewing Parameter Dictionaries

To view the content of a file in the Cisco BAC RDU database:

- 
- Step 1** Choose **Configuration** on the Primary Navigation bar.
  - Step 2** Choose **Files** on the Secondary Navigation bar.  
The View Files page appears.
  - Step 3** From the File Type drop-down list, select **Parameter Dictionary**.
  - Step 4** Click the **View Details** icon () corresponding to the file that you had specified for a search.  
The content of the Parameter Dictionary appears.
- 

## Deleting Parameter Dictionaries

To delete an existing parameter dictionary from the RDU database:



---

**Note** You cannot delete built-in default dictionaries.

---

- Step 1** Choose **Configuration > Files**.
  - Step 2** From the File Type drop-down list, select **Parameter Dictionary**.
  - Step 3** Check the file you want to delete.
  - Step 4** Click **Delete**.  
The View Files page appears without the deleted file.
- 

## Replacing Parameter Dictionaries

To replace the content of an existing parameter dictionary file in the Cisco BAC RDU database:



---

**Note** You cannot modify built-in default dictionaries.

---

- Step 1** Choose **Configuration > Files**.
- Step 2** From the File Type drop-down list, select **Parameter Dictionary**.
- Step 3** From the search results, click the link corresponding to the file you want to replace.  
The Replace File page appears. Note that the selected filename already appears on this page.
- Step 4** Browse for the source file to be used as a replacement for the displayed file.

**Step 5** Click Submit.

After submitting the replacement file, a confirmation page appears to indicate that, after replacement, Cisco BAC will regenerate instructions for the affected devices.

**Step 6** Click **OK**.

The View Files page appears.

---





# CHAPTER 8

## CPE History and Troubleshooting

This chapter describes how to troubleshoot the device using device information.

This chapter includes the following sections:

- [Device History, page 8-1](#)
- [Device Faults, page 8-6](#)
- [Device Troubleshooting, page 8-9](#)

### Device History

This section describes the Device History feature, which provides a detailed history of significant events that occur in a device-provisioning lifecycle. This feature can be helpful for troubleshooting.

You can view device history through the API or through the administrator user interface.

- To retrieve the history of a specific device, invoke the following API:  
`com.cisco.provisioning.cpe.api.ipdevice.history getHistory` (DeviceID *deviceID*)
- To retrieve the history of a specific device using the administrator user interface, see [Viewing Device History, page 16-12](#).

[Table 8-1](#) details the specific record types supported by the Cisco BAC Device History feature:

**Table 8-1 Supported Device History Records**

Record Type	Description	Message Format
AddedAutomatically	Recorded when a previously unregistered device is automatically added to Cisco BAC after contacting the DPE.	<i>time</i> : Device record was automatically created.
	<b>Example:</b> Tue Jul 11 18:41:42 EDT 2006: Device record was automatically created.	
AddedViaAPI	Recorded when a device is added to Cisco BAC by using the client API.	<i>time</i> : Device record was added via API by user <i>username</i> .
	<b>Example:</b> Tue Jul 11 18:41:42 EDT 2006: Device record was added via API by user "admin".	

Table 8-1 Supported Device History Records (continued)

Record Type	Description	Message Format
UpdatedViaAPI	Recorded when a device record stored at the RDU was modified using the client API.	<i>time</i> : Device record was updated <i>reason</i> by user <i>username</i> .
	<b>Example:</b> Tue Jul 11 18:41:42 EDT 2006: Device record was updated via API command "IPDevice.changeClassOfService" by user "admin".	
FirstContact	Recorded when a device first contacts Cisco BAC.	<i>time</i> : Device made first contact with Cisco BAC.
	<b>Example:</b> Tue Jul 11 18:41:42 EDT 2006: Device made first contact with Cisco BAC.	
CPEDiscoveredData Updated	Recorded when a device reports new values for a device parameter, which are tracked by the RDU as discovered data.  For details on discovered parameters, see <a href="#">Discovering CPE Parameters, page 4-4</a> .	<i>time</i> : Recorded updates of <i>number</i> parameter values discovered from device.
	<b>Example:</b> Tue Jul 11 18:41:42 EDT 2006: Recorded updates of 2 parameter values discovered from device.	
ConfigGenRequested	Recorded when device instruction regeneration is initiated for a device. The resulting instructions are sent to all DPEs in the device's provisioning group.	<i>time</i> : Device policy instructions regeneration initiated as a result of <i>reason</i> by user <i>username</i> .
	<b>Example:</b> Tue Jul 11 18:41:42 EDT 2006: Device policy instructions regeneration initiated as a result of execution of API Command "IPDevice.performOperation" by user "admin".	
ConfigUpdated	Recorded when Cisco BAC activates a new configuration on a device.	<i>time</i> : Device was configured according to configuration version: <i>configuration revision</i> .
	<b>Example:</b> Tue Jul 11 18:41:42 EDT 2006: Device was configured according to configuration version: 215438bb.	
UpdatedConfig Available	Recorded when new configuration instructions for the device have been sent from the RDU to the DPEs.	<i>time</i> : Configuration policy for device was updated; new version: <i>configuration revision</i> .
	<b>Example:</b> Tue Jul 11 18:41:42 EDT 2006: Configuration policy for device was updated; new version: 215438bb.	



Table 8-1 Supported Device History Records (continued)

Record Type	Description	Message Format
ReportedNewConfig	Recorded when a device reports using a new configuration using the <i>ParameterKey</i> contained in the Inform message.	<i>time</i> : Device reported new configuration version: <i>configuration revision</i> .
	<b>Example:</b> Tue Jul 11 18:41:42 EDT 2006: Device reported new configuration version: 215438bb.	
NewOperationQueued	Recorded when a new device operation is initiated through the client API or the administrator user interface and is queued by Cisco BAC for execution on a device.	<i>time</i> : On-connect operation <i>operation name</i> with ID <i>operation ID</i> was queued by user <i>username</i> .
	<b>Example:</b> Tue Jul 11 18:41:42 EDT 2006: On-connect operation "SetParamValues" with ID "15e2ccd:10c5f4b2ad0:80000024" was queued by user "admin".	
OperationExecuted	Recorded when an operation initiated through the client API or the administrator user interface is successfully executed on a device.	<i>time</i> : <i>Operation mode operation name</i> with ID <i>operation id</i> was executed on the device.
	<b>Example:</b> Tue Jul 11 18:41:42 EDT 2006: On-connect operation "SetParamValues" with ID "15e2ccd:10c5f4b2ad0:80000024" was executed on the device.	
OperationRemoved	Recorded when a device operation queued within Cisco BAC is removed.	<i>time</i> : On-connect operation <i>operation name</i> with ID <i>operation id</i> was removed.
	<b>Example:</b> Tue Jul 11 18:41:42 EDT 2006: On-connect operation "GetParamValues" with ID "15e2ccd:10c5f4b2ad0:80000025" was removed.	
ReportedNewFirmware	Recorded when a device reports by using new firmware using the Inform message.	<i>time</i> : Device reported new firmware/software version: <i>firmware/software version</i> .
	<b>Example:</b> Tue Jul 11 18:41:42 EDT 2006: Device reported new firmware/software version: 6d9bfec2.	
UpdatedFirmwareRules Available	Recorded when new firmware rules for the device have been sent from the RDU to the DPEs.	<i>time</i> : Firmware rules for device were updated; new version: <i>firmware rules revision</i> .
	<b>Example:</b> Tue Jul 11 18:41:42 EDT 2006: Firmware rules for device were updated; new version: 6d9bfec2.	

## Configuring Device History

You use the Device History feature to record significant events in a device-provisioning lifecycle. This section describes how to enable or disable this feature.

### Enabling Device History

Device History is, by default, enabled. To enable or disable this feature from the API, change the `SERVER_DEVICE_HISTORY_ENABLE_KEY` property.

**Note**

Every time Device History is enabled or disabled, a message is logged in *audit.log*. Device history is also stored in the troubleshooting log.

To enable or disable Device History through the administrator user interface:

- 
- Step 1** Choose **Configuration** on the Primary Navigation bar or Main Menu page.
  - Step 2** Choose **Defaults** on the Secondary Navigation bar.  
The Configure Defaults page appears.
  - Step 3** Click **System Defaults**.
  - Step 4** On the defaults page, against Device History, click the **Enabled** radio button.

**Note**

To disable the device history feature, click the **Disabled** radio button. When Device History is disabled, no new updates to any existing device or details of any new device are recorded in the device history. However, existing events are retained.

- Step 5** Click **Submit**, or click **Reset** to return to default values.
- 

### Viewing Device History

To view the device history from the administrator user interface:

- 
- Step 1** From the **Devices** page, locate the device whose history you want to view. You can use one of the search types for this purpose.
  - Step 2** Click the **View Details** icon (🔍) corresponding to the correct device.  
The Device Details page appears.
  - Step 3** Against View Device History Details, click the **View Details** icon.  
The Device History Details page appears.
- 

You can retrieve device history by using the API command `IPDevice.getDeviceHistory()`.

## Configuring Device History Size

To configure the maximum number of device history entries from the administrator user interface, choose **Configuration > Defaults > System Defaults**. Enter a value in the field corresponding to Maximum Device History Entries. The default number of entries is 40.

To configure this number from the API, set the `SERVER_MAX_DEVICE_HISTORY_SIZE` property.

If you reduce the value of the Maximum Device History Entries, the existing records which exceed the limit do not get purged until a new device history is recorded. At that point, the device's history is updated according to the limit on maximum device history entries that the administrator sets.

If the maximum number has been increased, the older entries are retained. If the maximum number has been decreased, the oldest entries are deleted.

## Device History Records

The device history records are logged in a rolling list. When the list reaches the limit that the administrator specifies, the oldest entry is removed. However, the following records are never deleted:

- AddedViaAPI (in the case of preregistered devices)
- AddedAutomatically (in the case of unregistered devices)
- FirstContact

To optimize Cisco BAC performance that extensive recording of device activity might impact, you can enable or disable specific event types with the following system properties from the API:



**Note** These properties are, by default, disabled. These options impact device history only if you have enabled the Device History feature.

- `SERVER_DEVICE_HISTORY_IMMEDIATE_OP_ENABLE_KEY`

Records OperationExecuted history for immediate operations.

- `SERVER_DEVICE_HISTORY_PROXY_OP_ENABLE_KEY`

Records the NewOperationQueued, OperationRemoved, and OperationExecuted history for on-connect device operations.



**Note** If you disable the `SERVER_DEVICE_HISTORY_IMMEDIATE_OP_ENABLE_KEY` property and enable the `SERVER_DEVICE_HISTORY_PROXY_OP_ENABLE_KEY` property, the immediate operation is disabled and the on-connect operation is enabled.

- `SERVER_DEVICE_HISTORY_GEN_CONFIG_ENABLE_KEY`

Records ConfigGenRequested history.

To enable or disable these properties from the administrator user interface:

- 
- Step 1** Choose the **Configuration > Defaults** page.
- Step 2** Click the **System Defaults** link on the left corner of the screen.

- Step 3** Click the radio buttons corresponding to the operation you want to enable or disable:
- To enable recording the history of immediate operations, click the **Enabled** radio button corresponding to Immediate Operation History.
  - To enable recording the history of on-connect operations, click the **Enabled** radio button corresponding to On-Connect Operation History.
  - To enable recording the history of configuration generation, click the **Enabled** radio button corresponding to Instruction Generation History.
- To disable these operations, click the corresponding **Disabled** radio button.
- Step 4** Click **Submit**.
- 

## Device Faults

In large installations, devices with recurring faults can cause bottlenecks and affect performance. Recurring faults can result from a device malfunction or misconfiguration of Cisco BAC. You can use Cisco BAC to detect recurring faults occurring at the RDU and the DPE servers through the Recurring Device Faults feature.

You can also configure Cisco BAC to ignore and not store the CWMP faults reported by the CPE. The fault values must be specified in the *dpe.properties* file with comma separation, for example, */dpe/cwmp/fault/ignore=9003, 9801*.

The DPE will filter the CPE faults with fault codes 9003 and 9801 while reporting the faults. This feature is helpful when faults from Customer Premises Equipment (CPE) to Cisco BAC are expected for certain standard operations such as a reboot or recurrent faults.

A recurrent fault is one that occurs many times over a short period of time, or one with high chances of occurring repeatedly. For instance, a fault may occur when an attempt is made to configure a device and if the device is missing a parameter.

Such a fault qualifies as recurring even if it happens only once, because this operation is executed on every device contact. However, if a one-time device operation is initiated from the API and results in a fault, this fault is returned to the API client in the operation response and is not considered to be recurring.

Also, consider the following scenarios:

- A configuration template at the RDU may refer to a property that was deleted from the system. Every time the RDU tries to generate instructions for devices by using this template, an error occurs. This error qualifies the device as the one causing a recurring fault and is reported to the user.
- A device sends an invalid or incomplete Inform message because of a bug in the device firmware. The same Inform is generated on every device contact. This problem also qualifies as a recurring fault.

This feature provides details about the last fault for given devices as well as aggregated fault statistics for the system as a whole, the RDU server, and each DPE server.

The following operations monitor device faults on the RDU and the DPE:

---

**At the RDU:**

Failures during instruction generation.

Failures during extension execution.

---

**At the DPE:**

Violations of the CPE WAN Management Protocol.

Failures during DataSync instruction processing, which is responsible for discovering data from a device and updating the RDU.

Failures during FirmwareRules instruction processing, which is responsible for executing firmware rules configured in the RDU firmware rules templates.

Failures during ConfigSync instruction processing, which is responsible for updating device configuration according to RDU configuration templates.

Failures during UnknownDevice instruction processing, which is responsible for processing unknown or unregistered devices.

---

The RDU and the DPE maintain a list of recurring faults. Each fault contains the date and time of occurrence, the ID of the device, and a fault description.

Faults automatically expire and are purged from the system as soon as their lifetime expires. After a fault is purged from the system, the statistics are adjusted accordingly.



**Note**

Cisco BAC limits the number of devices returned in the device fault list on the administrator user interface to 1,000. If the number of devices with faults exceeds 1,000, the operator will see a message stating that more devices have faults than just those on the screen.

To avoid impacting performance, Cisco BAC does not store fault information on the disk. If you restart the server, you will lose fault data that was maintained by that server in its memory. However, if faults repeat again, they are reported.

---

## Retrieving Device Faults

Device fault information is available using the API and the administrator user interface.

From the API, you can call the following properties:

- `Configuration.getRDUDetails`—Returns the list of devices with faults at the RDU.
- `Configuration.getDPEDetails`—Returns the list of devices with faults at the DPE.
- `IPDevice.getDetails`—Returns information about faults related to the device.

From the administrator user interface, choose:

- **Servers > RDU**—Displays device fault statistics at the RDU level and aggregated for all DPEs. Statistics appear for the following periods of time by default: 1, 3, 12, and 72 hours.
- **Servers > Provisioning Groups > Manage Provisioning Groups > View Provisioning Group Details**—Displays device fault statistics for each DPE in a provisioning group.

- **Servers > DPEs > Manage Device Provisioning Engines > View Device Provisioning Engines Details**—Displays the number of devices with faults, if any. Against Device with Faults, click the **View Details** icon. The Device Details page appears, detailing device fault statistics at the DPE level.



**Note** The Device with Faults option, along with the **View Details** icon, appears on the **View Device Provisioning Engines Details** page only if there are devices with faults.

- **Devices > Manage Devices > Device Details**—Displays the last fault, if any, for the selected device, as described in [Figure 8-1](#).

**Figure 8-1** Fault Description on Device Details Page

Device Details		
Use this page to view the details of the device listed.		
<b>Device Details</b>		
Device Type:	CWMP	
Device ID:	0012AA-000005AA006A	
FQDN:	bac_test-wrtp54g-4.bac.com	
Host Name:	bac_test-wrtp54g-4	
Domain Name:	bac.com	
Provisioning Group:	<a href="#">default</a>	
Home Provisioning Group:	default	
CPE Password:	****	
Connection Request User Name:	0012AA-000005AA006A	
Connection Request Password:	****	
Device Properties:	/IPDevice/connectionRequestMethod = Discovered	
Registered Class Of Service:	<a href="#">test-std</a>	
Owner Identifier:	testOID	
CPE Configuration Revision:	1e26604a	
CPE Firmware Rule Revision:	6d9bfec2	
Related Group Name (Group Type):		
Troubleshooting:	Disabled	
View Device History Details		
<b>Discovered Parameters</b>		
Has Routable IP Address	true	
Inform.DeviceId.Manufacturer	Acme	
Inform.DeviceId.ManufacturerOUI	0012AA	
Inform.DeviceId.ProductClass	Acme	
InternetGatewayDevice.DeviceInfo.HardwareVersion	1.0002.0	
InternetGatewayDevice.DeviceInfo.ModelName	WAG54G V.2	
InternetGatewayDevice.DeviceInfo.SoftwareVersion	1.00.26	
InternetGatewayDevice.ManagementServer.ConnectionRequestURL	http://10.5.43.7:1234/	
InternetGatewayDevice.ManagementServer.ParameterKey	1e26604a	
<b>Faulty Device List</b>		
Last Fault Time	Location	Fault Description
Thu, 11 May 2006 17:20:06 EDT	bac_test.cisco.com	A processing fault has occurred. Soap Fault: [9003] - Invalid arguments Last Instruction: SetParameterValuesInstruction

Cisco BAC maintains details of the most recent device with fault at each server. On account of DPE redundancy, a specific device over time will contact multiple DPEs, and may make it to a fault list on one or each of those DPEs.

The same device may also have recurring faults at the RDU. Cisco BAC provides an aggregated view of device faults at all servers. However on each server, no more than one fault for each device is tracked at any given time. Any device with faults is removed from the memory when it expires.

You can configure the number of faults to be displayed on this page in the DPE using the property `/dpe/DeviceFaultCount`. The default value of this property is 1000.

## Managing Chatty Clients

In this release of Cisco BAC, you can use the Chatty client feature to detect devices that make an excessive number of TR-069 or HTTP file server calls. You can use this feature to reduce the adverse impact of Chatty devices on services that are provided to other devices.

Using this feature, you can detect the Chatty devices and throttle their access to the DPE. This feature is enabled by default on the DPE. You can disable this feature from the DPE CLI, using the `chatty-client filter enabled {true | false}` command. (For more information, see the [Cisco Broadband Access Center 3.8 DPE CLI Reference](#).)

The following properties are used to configure this feature on the DPE:

- `SampleTimeInterval`—Indicates the duration, in seconds, for which the DPE monitors the activity of a device. The default is 30 seconds.
- `SampleHitsToThrottle`—Indicates the number of events received from the device during the sample time interval. The default is 15.
- `QuietTimeInterval`—Indicates the duration, in seconds, for which the DPE monitors the activity of a throttled device. The default is 10 seconds.
- `QuietHitsToLeaveThrottled`—Indicates the number of events received from the device during the quiet time interval. The default is 5.

You can configure these properties using the DPE CLI. For more information, see the [Cisco Broadband Access Center 3.8 DPE CLI Reference](#).

Cisco BAC uses the Chatty client filter to monitor the CPE events based on the device identifier. If the number of events received from the device during the sample time interval is greater than the value configured for the `Sample-hits-to-throttle` property, the DPE throttles the device. When a device is in a throttled state, all events that the device generates, are discarded.

Cisco BAC continues to monitor the activity on the throttled device to determine whether the device can be restored to the Normal state. If the device generates fewer events than the value configured for the `Sample-hits-to-throttle` property, the DPE moves the device to the Quiet state.

While in the Quiet state,

- If the number of events received from the device during the Quiet time interval is greater than the value configured for the `Quiet-hits-to-leave-throttled` property, the DPE moves the device to throttled state.
- If the number of events received from the device during the quiet time interval is less than the value configured for the `Quiet-hits-to-leave-throttled` property, the DPE restores the device to the Normal state.

## Device Troubleshooting

You can use this feature to collect highly detailed troubleshooting information about one or multiple specific devices. Troubleshooting information includes all server interactions related to a given device or a group of devices. This information includes administrator user interface operations, RDU API operations, DPE interactions with the CPE, and inter-server DPE-to-RDU interactions.

You can enable or disable troubleshooting for one or a number of specific devices without turning logging on, and without searching through log files for specific device information.

Cisco BAC maintains a list of devices, based on the device identifier, for which detailed troubleshooting information is collected.

Troubleshooting information is stored centrally at the RDU and is maintained for each device. The DPEs do not store this data. Instead, the DPE forwards this information to the RDU which writes it to the device log file, `troubleshooting.log`, in the `<BPR_DATA>/rdu/logs` directory when it receives this information.

If the connection from the DPE to the RDU is lost, any new troubleshooting events occurring on the DPE are discarded. The logging of troubleshooting information resumes only after the RDU-DPE connection is restored.

The `troubleshooting.log` file is different from other log files such as `rdu.log`, `dpe.log`, and `audit.log`. The `troubleshooting.log` file only logs detailed troubleshooting information relating to a specific set of devices in the troubleshooting mode.

**Note**

---

The tracking feature is turned off until one or more devices are added to the troubleshooting group.

---

When you enable or disable troubleshooting on a specific device, the change takes place immediately at all servers (RDU and DPEs); you do not have to reboot the RDU or the DPEs. The log files on the respective servers lists the current list of devices in the troubleshooting mode.

**Caution**

---

Additional memory and disk space is required whenever the device troubleshooting feature is used. As the number of tracked devices increases, so does the amount of memory and disk space that is required to support the number of logs that are created.

---

## Configuring Device Troubleshooting

The Device Troubleshooting feature is disabled until one or more devices are put into troubleshooting mode. This section describes how you can enable or disable troubleshooting for a device from the administrator user interface. It also describes how to view a list of devices in troubleshooting mode and how to view troubleshooting log for a given device.

You can configure the maximum number of devices in troubleshooting mode to prevent inadvertently putting too many devices in this mode, and thus, diminishing server performance. By default, this number is set at 100.

To configure the maximum number of the devices allowed in troubleshooting mode from the administrator user interface, click the Systems Defaults page using the **Configuration > Defaults** tabs. Enter a value in the Maximum Troubleshooting Device Count field.

## Enabling Troubleshooting for a Device

To enable troubleshooting for a device, the device must be preregistered in the Cisco BAC RDU. If the device is not yet preregistered, add the device from the Manage Devices page by clicking the **Add** button. For information on adding devices, see [Adding Device Records, page 16-11](#).

To enable troubleshooting for a device that already resides in the RDU database:

- 
- Step 1** From the Manage Devices page, click the Search Type drop-down list, and select the Device Identifier Option Search option. You can use the wildcard function for this search. (See [Table 16-1](#).)
  - Step 2** Click **Search**.  
A list of devices appears.



- Step 3** Click the Identifier link corresponding to the device that you want to track. The Modify Device page appears, listing various device parameters.
- Step 4** Click the **Enabled** radio button corresponding to the Troubleshooting parameter.
- Step 5** Click **Submit**. Troubleshooting is now enabled for the device.
- To verify if a given device is enabled for troubleshooting, you can access the Device Details page, and view status against Troubleshooting.
- 

## Disabling Troubleshooting for a Device

To disable troubleshooting for a device:

- Step 1** From the **Devices** tab, locate the device that you want to delete. You can use one of the search types for this purpose.
- Step 2** Click the Identifier link corresponding to the device that you want to delete from the troubleshooting list. The Modify Device page appears.
- Step 3** Against the Troubleshooting parameter, click the **Disabled** radio button.
- Step 4** Click **Submit**.
- 

## Viewing List of Devices in Troubleshooting Mode

When you enable troubleshooting for a device, the device is automatically added to a special device group which contains a list of devices in troubleshooting mode. The group type is **system** and the group name is **troubleshooting**. You can access the list of devices in this group from the API or the administrator user interface.

To view a list of devices currently enabled for troubleshooting:

- Step 1** From the **Manage Devices** page, click the Search Type drop-down list, and select **Group Search**.
- Step 2** From the Group (Group Type) drop-down list, select the troubleshooting (system) option to view all the devices in troubleshooting mode.
- Step 3** Click **Search**.
- 

You can also see the list of devices in troubleshooting mode is by viewing the RDU log (*rdu.log*) and the DPE log (*dpe.log*). The list of devices is logged whenever the server is started and whenever there is a change in the list of devices that are enabled for troubleshooting.

The devices enabled for troubleshooting appear in the log files with the log level of 5-notification. For more information on log files, see [Logging, page 21-2](#).

## Viewing Device Troubleshooting Log

You can view the troubleshooting log file of a specific device in one of two ways.

- Complete the procedure described in [Viewing List of Devices in Troubleshooting Mode, page 8-11](#). Then, follow these steps:

---

**Step 1** When a list of the devices in troubleshooting mode appears, click the **View Details** icon corresponding to a specific device.

The Device Details page appears.

**Step 2** Against View Troubleshooting Log, click the **View Details** icon.

The View Log File Contents page appears.

---

- Complete the following procedure:

---

**Step 1** From the Manage Details page under the **Devices** tab, click the Search Type drop-down list, and select the Device Identifier Option Search option. You can use the wildcard character (\*) for this search.

**Step 2** Click **Search**.

A list of devices appears.

**Step 3** Click the View Details icon corresponding to the device whose log file you want to check.

The Device Details page appears.

**Step 4** Against View Troubleshooting Log, click the **View Details** icon.

The View Log File Contents page appears.

---

The color coding for the device troubleshooting log entries is:

- BAC-TROUBLESHOOTINGINFO—Informational messages are marked in white.
- BAC-TROUBLESHOOTINGINPUT—Details of messages received by Cisco BAC servers are marked in grey.
- BAC-TROUBLESHOOTINGOUTPUT—Details of messages sent by Cisco BAC servers are marked in green.
- BAC-TROUBLESHOOTINGERROR—Error messages are marked in red.



## CHAPTER 9

# Managing Cisco Broadband Access Center

---

This chapter describes the various subcomponents within Cisco Broadband Access Center (BAC) that you can use to manage the system.

This chapter includes the following sections:

- [Cisco BAC Process Watchdog, page 9-1](#)
- [Administrator User Interface, page 9-4](#)
- [Command Line Interface, page 9-5](#)
- [SNMP Agent, page 9-6](#)
- [Cisco BAC Tools, page 9-7](#)

## Cisco BAC Process Watchdog

The Cisco BAC process watchdog is an administrative process that monitors the runtime health of all Cisco BAC processes. This watchdog process ensures that, if a process stops unexpectedly, it is automatically restarted. One instance of the Cisco BAC process watchdog runs on every system which runs Cisco BAC components.

You can use the Cisco BAC watchdog as a command-line tool to start, stop, restart, and determine the status of any monitored processes.

You can enable the SNMP trap facility for Cisco BAC process watchdog. The SNMP traps are sent only when:

- there is a change in component's state.
- the component is gracefully shut down.

If a monitored application fails to start or stops unexpectedly, the Cisco BAC process watchdog reports the critical condition associated with the monitored application to the trap receiver through SNMP trap. The Cisco BAC process watchdog will wait for a prescribed amount of time before attempting to restart the monitored application. When the monitored application restarts, the Cisco BAC process watchdog sends another SNMP trap to the SNMP trap receiver informing the change in application's state.

At the beginning, restart attempt is made at an interval of 1 second, and is increased exponentially with every subsequent attempt until the interval becomes 5 minutes. After that, the process restart is attempted at 5-minute intervals until successful. Five minutes after a successful restart, the period is automatically reset to 1 second again.

For example:

- Process A fails.
- The Cisco BAC process watchdog server sends an SNMP trap informing the critical condition associated with the process A.
- The Cisco BAC process watchdog server attempts to restart it and the first restart fails.
- The Cisco BAC process watchdog server waits for 2 seconds, and attempts to restart it and the second restart fails.
- The Cisco BAC process watchdog server waits for 4 seconds, and attempts to restart it and the third restart succeeds.
- The Cisco BAC process watchdog server sends the SNMP trap to the trap receiver informing the change in state of process A.

## Using Cisco BAC Process Watchdog from the Command Line

The Cisco BAC watchdog agent automatically starts whenever the system boots up. Consequently, this watchdog also starts those Cisco BAC system components installed on the same system. You can also control the Cisco BAC watchdog through a simple command-line utility by running the `/etc/init.d/bprAgent` command.

Table 9-1 describes the command line interface commands available for use with the Cisco BAC watchdog process.

**Table 9-1 Cisco BAC Watchdog Agent CLI Commands**

Command	Description
<code>bprAgent start</code>	Starts the Cisco BAC watchdog agent, including all monitored processes.
<code>bprAgent stop</code>	Stops the Cisco BAC watchdog agent, including all monitored processes.
<code>bprAgent restart</code>	Restarts the Cisco BAC watchdog agent, including all monitored processes.
<code>bprAgent status</code>	Gets the status of the Cisco BAC watchdog agent, including all monitored processes.
<code>bprAgent start <i>process-name</i></code>	Starts one particular monitored process. The value <i>process-name</i> identifies that process.
<code>bprAgent stop <i>process-name</i></code>	Stops one particular monitored process. The value <i>process-name</i> identifies that process.
<code>bprAgent restart <i>process-name</i></code>	Restarts one particular monitored process. The value <i>process-name</i> identifies that process.

**Table 9-1 Cisco BAC Watchdog Agent CLI Commands (continued)**

Command	Description
bprAgent status <i>process-name</i>	Gets the status of one particular monitored process. The value <i>process-name</i> identifies that process.

The *process-name* mentioned in Table 9-1 can be:

- rdu—Specifies the RDU server.
- dpe—Specifies the DPE server.
- stun—Specifies the STUN server.
- snmpAgent—Specifies the SNMP agent.
- tomcat—Specifies the administrator user interface.
- cli—Specifies the DPE command line interface.

When the operating system (Solaris and Linux) is rebooted, the Cisco BAC process watchdog is first stopped, allowing Cisco BAC servers to shut down properly. To shut down or reboot the operating system gracefully, use the **init 6** command.

The **reboot** command does not execute application shut down hooks and kills Cisco BAC processes rather than shutting them down. While this action is not harmful to Cisco BAC, it may delay server start-up and skew certain statistics and performance counters.

The events that trigger an action in the Cisco BAC watchdog daemon, including process crashes and restarts, are logged in a log file, `<BPR_HOME>/agent/logs/agent.log`. The watchdog daemon also logs important events to syslog under standard `local6` facility.

## Enabling SNMP Trap for Cisco BAC Process Watchdog

The Cisco BAC process watchdog can be configured to send SNMP traps to the trap receiver for all the critical conditions of Cisco BAC components. The critical conditions include:

- BAC process fails to start, restart, or stop
- BAC process stops unexpectedly
- Cisco BAC process watchdog fails to start or stop

The Cisco BAC process watchdog runs on the following BAC components:

- RDU
- DPE
- CLI
- Tomcat
- SNMPAgent
- STUNServer

To enable SNMP trap for Cisco BAC process watchdog:

- 
- Step 1** Log into Cisco BAC host as root.
- Step 2** Set the following parameters in *CbsServerTable.xml* file located at *<BPR\_HOME>/snmp/xmlFiles/CISCO-BACC-SERVER-MIB*:
- *cbsServerType* - *<component>*
  - *cbsNotifEnableFlags* - 1
- Step 3** Configure the trap receiver to receive the SNMP traps from the BAC components. The trap receiver is added as SNMP host with the required community and listening port. For information on how to add SNMP host and community, see [Using the snmpAgentCfgUtil.sh Tool, page 11-6](#).
- Step 4** Start, stop, or restart the BAC components or watchdog, and verify if the trap receiver receives the SNMP traps.
- 

## Administrator User Interface

The Cisco BAC administrator user interface is a web-based application for central management of the Cisco BAC system. You can use this interface to:

- Configure global defaults
- Define custom properties
- Set up Classes of Service
- Manage firmware rules and configuration templates
- Add and edit device information
- Group devices
- Execute device operations
- View server status and statistics
- View device history
- View server logs
- Manage users

Refer to these chapters for specific instructions on how to use this interface:

- [Understanding the Administrator User Interface, page 15-1](#), describes how to access and configure the Cisco BAC administrator user interface.
- [Using the Administrator User Interface, page 16-1](#), provides instructions for performing administrative activities involving the monitoring of various Cisco BAC components.
- [Configuring Broadband Access Center, page 17-1](#), describes tasks that you perform to configure Cisco BAC.

# Command Line Interface

The Cisco BAC CLI is an IOS-like command line interface which you use to configure as well as view the status of the DPE by using Telnet. The CLI supports built-in command help and command autocompletion.

You can enable authentication of the CLI through a locally configured login and enable passwords, or through a remote username and password for a TACACS+ service.

To access the DPE CLI, open a Telnet session to port 2323 from a local or remote host.

## Accessing the DPE CLI from a Local Host

To access the CLI from a local host, you can use:

```
# telnet localhost 2323
```

or

```
# telnet 0 2323
```

## Accessing the DPE CLI from a Remote Host

To access the CLI from a remote host, enter:

```
# telnet remote-hostname 2323
```

**Note**

If you cannot establish a Telnet connection to the CLI, the CLI server might not be running. You may need to start the server; enter:

```
# /etc/init.d/bprAgent start cli
```

After you access the CLI, you must enter the DPE password to continue. The default login and enable passwords are **changeme**.

See the [Cisco Broadband Access Center 3.8 DPE CLI Reference](#), for specific information on the CLI commands that a DPE supports.

## SNMP Agent

Cisco BAC provides basic SNMP v2-based monitoring of the DPE and RDU servers. The Cisco BAC SNMP agents support SNMP informs and traps. You can configure the SNMP agent on the DPE by using the `snmp-server` CLI commands, and on the RDU by using SNMP configuration CLI commands.

The SNMP agent also provides support for monitoring essential Cisco BAC details, such as server state, server-specific statistics, communication between servers, and license information.

For additional information on the SNMP configuration command line tool, see [Monitoring Cisco Broadband Access Center, page 11-1](#). For additional information on the DPE CLI, refer to the [Cisco Broadband Access Center 3.8 DPE CLI Reference](#).



# Cisco BAC Tools

Cisco BAC provides automated tools that you use to perform certain functions more efficiently.

Table 9-2 lists the various tools that this Cisco BAC release supports:

**Table 9-2** List of Cisco BAC Tools

Tool	Description	Refer ...
Configuration Tool	Used to test, validate, and view Cisco BAC template and configuration files.	<a href="#">Using the Configuration Utility, page 5-22</a>
Cisco BAC Process Watchdog	Interacts with the Cisco BAC watchdog daemon to observe the status of the Cisco BAC system components, and stop or start servers.	<a href="#">Using Cisco BAC Process Watchdog from the Command Line, page 9-2</a>
SNMP Agent Configuration Tool	Sets the log level of the RDU, and enables or disables debugging log output.	<a href="#">Using the snmpAgentCfgUtil.sh Tool, page 11-6</a>
RDU Log Level Tool	Retrieves device information from the Cisco BAC backup database and exports the information to a flat file.	<a href="#">The RDU Log Level Tool, page 21-5</a>
Device Export Tool	Sets threshold values for one or more file systems. When these thresholds are surpassed, an alert is generated until additional disk space is available.	<a href="#">Using the deviceExport.sh Tool, page 20-1</a>
Disk Space Monitoring Tool	Manages certificates in a certificate store in support of HTTP over SSL services on the DPE.	<a href="#">Using the disk_monitor.sh Tool, page 20-4</a>
Keytool Utility	Enables you to temporarily reset bacadmin authentication to local RDU, when TACACS+ authentication is enabled.	<a href="#">Configuring DPE Keystore by Using the Keytool, page 13-3</a>
Password Reset Tool	Sets the log level of the RDU, and enables or disables debugging log output.	<a href="#">Using the resetAdminPassword.sh Tool, page 20-5</a>
Event Monitor Tool	Used to view the events that are being fired in Cisco BAC.	<a href="#">Using the runEventMonitor.sh Tool, page 20-5</a>





## CHAPTER 10

# Database Management

---

This chapter contains information on RDU database management and maintenance. The RDU database is the Broadband Access Center (BAC) central database. The Cisco BAC RDU requires virtually no maintenance other than to ensure availability of sufficient disk space. As the administrator, you must understand and be familiar with database backup and recovery procedures.

This chapter includes the following sections:

- [Understanding Failure Resiliency, page 10-1](#)
- [Database Files, page 10-2](#)
- [Disk Space Requirements, page 10-3](#)
- [Backup and Recovery, page 10-4](#)
- [Changing Database Location, page 10-7](#)

## Understanding Failure Resiliency

The RDU database uses a technique known as Write-ahead logging to protect against database corruption that could result from unforeseen problems, such as an application crash, system failure, or power outage.

Write-ahead logging involves writing a description of any database change to a database log file before writing the change into the database files. This mechanism allows the repair of any incomplete database writes that can result from system failures.

The RDU server performs an automatic recovery each time it is started. During this recovery process, the database log files are used to synchronize the data with the database files. Database changes that were written into the database log, but not into the database, are written into the database during this automatic recovery.

In this way, write-ahead logging virtually guarantees that the database does not become corrupted when the RDU server crashes because the database is automatically repaired when the RDU server is restarted.

Write-ahead logging requires these conditions to work properly:

- You must set up the file system and physical storage so that they guarantee that the data is flushed to physical storage when requested. For example, a storage system with SDRAM-only write cache, which loses data during system failure, is not appropriate.

However, a disk array with battery-backup write cache that guarantees that the data gets persisted, even in the event of a system failure, is acceptable. A system without battery-backed write cache should flush data disk when requested instead of performing in-memory data caching.

- You must set up the file system with a 8192-byte block size to match the RDU database block size. This setting is usually the default unless explicitly adjusted.

## Database Files

The RDU database stores data in binary files using the file system you have mounted on the partition containing the files. It is essential to choose and configure a file system in a way that it is not susceptible to long recovery times after system failures.

Database files are vital to the operation of the RDU. Therefore, take extra precautions to safeguard them against accidental removal or other manual manipulation. Follow standard system administration practices to safeguard these important files.

For example, these files should always have permissions that allow only root user access. Additionally, it is a good practice to never log into your production system as a root user, but rather log in as a less privileged user and use the sudo command to perform tasks requiring root privileges.

## Database Storage File

The RDU server stores its database in a file called `bpr.db`, which resides in the database directory. This directory is located in the `<BPR_DATA>/rdu/db` directory and is configured by specifying the `<BPR_DATA>` parameter during a component installation. See [Changing Database Location, page 10-7](#), for additional information on moving the database.



### Note

The database file is normally accessed in a random fashion. You should therefore, select a disk with the fastest seek time and rotational access latency to obtain the best database performance.

## Database Transaction Log Files

The RDU server stores database transaction logs in 10-MB files that are stored in the database log directory. You configure this directory during installation by specifying the `<BPR_DBLOG>` parameter. The log directory is located in the `<BPR_DBLOG>/rdu/dblog` directory. See [Changing Database Location, page 10-7](#), for additional information on moving the transaction logs to a new directory.

Database log files are named in numeric sequence, starting at `log.00000001`, `log.00000002`, and so on.



### Note

The disk on which transaction logs are stored is usually accessed in a sequential manner, with data being appended to the log files. Select a disk that can efficiently handle this access pattern to achieve the best database performance. We recommend that you locate the database transaction logs directory on the fastest disk on the system. Also, ensure that 1 GB disk space is available.

## Automatic Log Management

Database transaction logs files are used to store transaction data until that data is completely written into the database. After that, the transaction log data becomes redundant and the files are then automatically removed from the system. Under normal circumstances there should be only a few log files in the database transaction log directory. Over time, you will notice that older transaction logs disappear and newer ones are created.

**Caution**

---

Database transaction logs are an integral part of the database. Manual deletion of transaction log files will result in database corruption.

---

## Miscellaneous Database Files

The database directory contains additional files that are essential to database operation. These files, in addition to the rdu.db file, are found in the <BPR\_DATA>/rdu/db directory and are copied as part of the database backup:

- **DB\_VERSION**—Identifies the physical and logical version of the database and is used internally by the RDU.
- **history.log**—Used to log activity about essential database management tasks, such as automatic log file deletion, backup, recovery, and restore operations. In addition to providing useful historical information for the administrator, this log file is essential to RDU database operation.

## Disk Space Requirements

The size of a fully populated database depends on a number of factors:

- Device objects that the RDU manages.
- Custom properties stored on each object.
- Device history records tracked for each device.

The approximate estimates for disk space required on each partition are:

- <BPR\_DATA>, approximately 3 to 5 KB per device object
- <BPR\_DBLOG>, at least 500 MB

**Caution**

---

These numbers are provided as a guideline only and do not eliminate the need for normal system monitoring.

---

You can use the **disk\_monitor.sh** tool to monitor available disk space and alert the administrator. See [Using the disk\\_monitor.sh Tool, page 20-4](#), for additional information.

## Handling Out of Disk Space Conditions

When the RDU server runs out of disk space, it generates an alert through the syslog facility and the RDU log. The RDU server then tries to restart automatically. When attempting to restart, the RDU server may again encounter the `out of disk space` error and attempt to restart again.

The RDU server continues trying to restart until free disk space becomes available. Once you free up some disk space on the disk that is operating near a limit, the next time the RDU restarts it will succeed.

If the size of your database grows beyond the capacity of the current disk partition, then you should move the database to a new disk or partition. For information on how to do this, see [Changing Database Location, page 10-7](#).



### Note

It is a good practice to monitor disk space utilization to prevent failure. See [Using the `disk\_monitor.sh` Tool, page 20-4](#), for additional information.

## Backup and Recovery

The RDU server supports a highly efficient backup process that can be performed without stopping the server or suspending any of its activities. Database backup and recovery involves these stages:

- Backup—Takes a snapshot of the RDU database from a live server.
- Recovery—Prepares the database snapshot for re-use.
- Restore—Copies the recovered database snapshot to the RDU server.

Automated tools are provided for each of these steps. You can use these tools in either interactive mode or silent mode, but you must have root privileges to use the tools.



### Note

A non root user is provided with privilege to create directory only under the directories with non root access.

## Database Backup

Backup is the process of copying the database files into a backup directory. The files can then be compressed and placed on tape or other archive.

RDU database backup is highly efficient because it involves just copying files without interrupting server activity. However, because it involves accessing the RDU database disk, backup may adversely affect RDU performance. The opposite is also true; RDU activity happening during backup will adversely affect backup performance. Therefore, you should perform backups during off-peak hours.

Other than concurrent system activity, backup performance also depends on the underlying disk and file system performance. Essentially, backup will perform as fast as database files can be copied from source to target.

Use the **backupDb.sh** tool, in the `<BPR_HOME>/rdu/bin` directory, to perform database backups:

- To use this tool, you must provide the target directory where the backup files will be placed. This directory should be on a disk or partition that has available disk space equivalent to 120% of the current database file size.

- As illustrated in the following example, this tool automatically creates a time stamped subdirectory, under the directory you specify and places the backups there.

### Examples

Here is an example of using the **backupDb.sh** tool:

```
# backupDb.sh /var/backup
```

where */var/backup* identifies the database backup directory.

In this example, all backup database files are stored in a directory called */var/backup/rdu-backup-09252002-130345*. The last subdirectory (*rdu-backup-20020925-130345*) is automatically created with a current timestamp.



#### Note

The timestamped subdirectory format is *rdu-backup-yyyyMMdd-HHmmss*. In this example, the subdirectory would be *rdu-backup-04272006-175430*, meaning that the directory contains a backup that was started at 5:54:30 pm on April 27, 2006.

The **backupDb.sh** tool also reports progress to the screen and logs its activity into *history.log*.



#### Note

When using the **backupDb.sh** tool, you can use a **-help** option to obtain usage information. You can also use the optional **-nosubdir** flag to disable, if necessary, the automatic creation of the subdirectory.

## Database Recovery

Database recovery is the process of restoring the database to a consistent state. Since backup is performed on a live RDU, the database can be changing while it is being copied. The database log files, however, ensure that the database can be recovered to a consistent state.

Recovery is performed on a snapshot of a database. In other words, this task does not involve touching the database on the live RDU server. The recovery task can be performed either immediately following a backup or prior to restoring the database to the RDU server.



#### Note

We recommend that you perform database recovery immediately after each backup. This way, the backed up database can be more quickly restored in case of emergency.

The duration of database recovery depends on the number of database log files that were copied as part of the backup, which in turn depends on the level of RDU activity at the time of the backup. The more concurrent activity RDU experiences during the backup, the more transaction log files have to be copied as part of the backup and the longer is the recovery. Generally, recovering a database takes from 10 to 60 seconds per transaction log file.

Use the **recoverDb.sh** tool, located in the *<BPR\_HOME>/rdu/bin* directory, to perform recovery of the snapshot of a database. When you use this tool, you must provide the location of the backup. This is also the directory in which the recovery will be performed.

**Examples**

Here is an example of using the **recoverDb.sh** tool:

```
# recoverDb.sh /var/backup/rdu-backup-20060427-130345
```

In this example, the snapshot located in the /var/backup/rdu-backup-20060427-130345 directory will be recovered to a consistent state. The progress of the recovery operation will appear on screen and the activity will be recorded in the history.log file in the snapshot directory.

**Note**

When using the **recoverDb.sh** tool, you can use the **-help** option to obtain usage information on the tool.

**Database Restore**

Restoring the database is the process of copying the previously recovered database snapshot to the database location used by the RDU server. Only a database that has been previously recovered can be restored.

Since restoring the database means replacing the current RDU database, it is very important that you first properly remove and archive the old database.

**Note**

Never delete the database you are replacing. You might need a copy of an old database to simplify future system diagnostics.

Use the **restoreDb.sh** tool, located in the <BPR\_HOME>/rdu/bin directory, to replace the current RDU database with another database. When using this tool, you must specify an input directory. This directory must contain the recovered backup snapshot of the database to be restored to the RDU server.

**Note**

Before running the **restoreDb.sh** tool, you must stop the RDU server. Also, remember to back up the database, then remove the database files from the rdu/db and the rdu/dblog directories.

**Examples**

Here is an example of running the **restoreDb.sh** tool:

```
# restoreDb.sh /var/backup/rdu-backup-20060427-130345
```

In this example, the database found in the /var/backup/rdu-backup-20060427-130345 directory is restored to the RDU server.

**Note**

When using the **restoreDb.sh** tool, you can use the **-help** option to obtain usage information on the tool.

You must restart the RDU after the restore operation is completed. The RDU log file will contain successful startup messages.

This tool displays progress on the monitor and logs its activity in the history.log file.



# Changing Database Location

You can move the database from one partition or disk to another on the same system. You might sometimes want to do this for administrative reasons. This process requires stopping the RDU server and the Cisco BAC process watchdog.

The process of changing the database location involves changing system parameters and copying the appropriate files to the new location. You can adjust one or both of the following parameters:

- **<BPR\_DATA>**—This parameter is initially set during installation and points to a directory that is used to store the database, and many other important files, such as logs, configuration files, and so on.

This directory also stores log data for the Cisco BAC process watchdog, the DPE (if installed on the same system), RDU, and SNMP agent, among others.

- **<BPR\_DBLOG>**—This parameter is initially set during installation and points to the directory that stores database transaction log files.

The values for the above parameters are recorded in a file called **<BPR\_DATA>/bpr\_definitions.sh**. Any change to this file requires that you restart all BAC components running on the system.

To change the location of the database and transaction logs:

- 
- Step 1** Run the **/etc/init.d/bprAgent stop** command to stop the BAC process watchdog and all Cisco BAC components.
  - Step 2** Make a backup copy of **<BPR\_HOME>/bpr\_definitions.sh** file.
  - Step 3** Edit the file and change either or both the **<BPR\_DATA>** and **<BPR\_DBLOG>** parameters to new directories.
  - Step 4** Save the file.
  - Step 5** Copy or move the directory structure and contents of the original **<BPR\_DATA>** and/or **<BPR\_DBLOG>** directories to new location(s). If you make a copy, ensure that all file and directory permissions are preserved.
  - Step 6** Run the **/etc/init.d/bprAgent start** command to start the BAC process watchdog and all BAC components.
  - Step 7** Monitor the appropriate log files to ensure that all components have successfully started.
-





# CHAPTER 11

## Monitoring Cisco Broadband Access Center

---

This chapter describes how you can monitor the central RDU servers and the DPE servers in a Cisco Broadband Access Center (BAC) deployment.

This chapter includes the following sections:

- [Syslog Alert Messages, page 11-1](#)
- [Monitoring Servers by Using SNMP, page 11-5](#)
- [Monitoring Server Status, page 11-12](#)
- [Monitoring Performance Statistics, page 11-14](#)
- [Traffic Profiling, page 11-18](#)

### Syslog Alert Messages

Cisco BAC generates alerts through the syslog service. Syslog is a client-server protocol that manages the logging of information. Cisco BAC syslog alerts are not a logging service; they provide a notification that a problem exists, but do not necessarily define the specific cause of the problem. You might find this information in the appropriate Cisco BAC log files.

### Message Format

When Cisco BAC generates an alert message, the format is:

*XXX-#-####: Message*

- *XXX*—Identifies the facility code, which can include:
  - RDU (regional distribution unit).
  - DPE (device provisioning engine).
  - AGENT (Cisco BAC process watchdog).
- *#*—Identifies the severity level in use. The three levels of alerts are:
  - 1, which is alert.
  - 3, which is error.
  - 6, which identifies informational messages.
- *###*—Identifies the numeric error code as described in the following sections.

- *Message*—Provides the alert text or message.

## RDU Alerts

Table 11-1 identifies the RDU alerts.

**Table 11-1 RDU Alerts**

Alert	Description
RDU-1-101: RDU ran out of disk space	Indicates that the storage partition that the RDU server uses ran out of space. After encountering this error, the RDU attempts to restart automatically, but will typically encounter the same error again until more storage space is available.  See <a href="#">Cisco BAC Support Tools and Advanced Concepts, page 20-1</a> , for additional information on upgrading the disk.
RDU-1-103: RDU ran out of memory	Indicates that the RDU ran out of memory. After encountering this error, the RDU server restarts automatically.
RDU-1-111: Evaluation key for technology <i>[technology_name]</i> expired	Appears if an evaluation key for the technology specified expires. You must contact Cisco sales or TAC for a new license key.
RDU-1-115: You have used <i>[percent]</i> percent of available <i>[technology_name]</i> licenses	Identifies the quantity of licences used (in percentage) out of the total number of allowable licenses. Appears when you reach 80% of the license capacity.
BPR-RDU-4-1140: DNS took <i>X</i> seconds for lookup of address <i>[10.0.0.1/test.com]</i> ; Check DNS configuration and health of servers	Indicates that Cisco BAC performance may be slow due to delayed response from the DNS. The alert is generated whenever IP Address look-up takes more than 60 seconds.
<b>Note</b>	Whenever an RDU syslog alert is sent, additional details (if any) can be found in log file <BPR_DATA>/rdu/logs/rdu.log.

## DPE Alerts

Whenever a DPE syslog alert is sent, you can find additional details in the DPE logs.

You can use the **show log** command to access the DPE logs. See [Cisco Broadband Access Center 3.8 DPE CLI Reference](#), for additional information.

Some DPE errors are also propagated to the RDU server log files. You can find these in the <BPR\_DATA>/rdu/logs/rdu.log file.

Table 11-2 identifies the DPE alerts.

**Table 11-2** DPE Alerts

Alert	Description
DPE-1-102: DPE ran out of disk space	<p>The storage partition that the DPE server uses ran out of space. You have three options:</p> <ol style="list-style-type: none"> <li>Clear out any excess support bundles that may reside on the disk. You can do this by moving those support bundles to another machine and then running the <b>clear bundles</b> command from the DPE CLI.</li> <li>Run the <b>clear logs</b> command from the DPE CLI to clear more disk space.</li> <li>As a last resort, run the <b>clear cache</b> command from the DPE CLI to remove any cache files and force the DPE to resynchronize with the RDU server.</li> </ol>
DPE-1-104: DPE ran out of memory	<p>The DPE process ran out of memory. After encountering this error condition, the DPE restarts automatically.</p> <p>Determine how many device configurations are on the DPE; the larger the number of device configurations, the more memory is used.</p> <p>To reduce device configurations, limit the number of devices in the provisioning groups that the DPE serves.</p>
<p>DPE-1-109: Failed to connect to RDU</p> <p>Clear:</p> <p>DPE-1-123: Successfully connected to RDU</p>	<p>The RDU cannot be contacted. You must:</p> <ol style="list-style-type: none"> <li>Verify that the DPE network is configured and connected correctly.</li> <li>Check that the DPE is configured to connect to the proper RDU, and that the connecting port is configured properly by using the <b>dpe rdu-server</b> command.</li> <li>Check that the RDU process is running on the correct server and listening on the correct port. The DPE attempts to reconnect to the RDU process every few seconds until a connection is established.</li> </ol>

**Table 11-2 DPE Alerts (continued)**

Alert	Description
DPE-1-125: Configured extension script file is missing	The configured script file is not available in the DPE cache. This alert will be fired only once per script.
Clear: DPE-1-126: Configured extension script file is available	This error cannot be manually cleared. Once the error is cleared, a clear alert is fired.
DPE-1-127: Configured extension script file failed for the device	The configured script for a device has failed. This alert will be fired only once for a script failure per device.
Clear: DPE-1-128: Configured extension script file executed for the device	This error cannot be manually cleared. Once the error is cleared, a clear alert is fired.

## Watchdog Agent Alerts

Whenever the watchdog process sends a syslog alert, you can find error details (if any) in the <BPR\_DATA>/agent/logs/agent\_console.log file and the log files corresponding to the specific component mentioned in the alert (if any).

For example, if you receive an alert similar to `The rdu unexpectedly terminated`, you would check the RDU server log file (<BPR\_DATA>/rdu/logs/rdu.log) for additional information. [Table 11-3](#) identifies the watchdog agent alerts.

**Table 11-3 Watchdog Agent Alerts**

Alert	Description
AGENT-3-9001: Failed to start the <i>component</i>	Indicates that the watchdog has failed to start the specified component.
AGENT-3-9002: The <i>component</i> unexpectedly terminated	Indicates that the specified component, that the agent process monitors, unexpectedly failed.
AGENT-3-9003: Failed to stop the <i>component</i>	Indicates that a component did not stop when the watchdog agent attempted to stop it.
AGENT-6-9004: The <i>component</i> has started	Is generated any time the watchdog agent successfully starts a component. This message is for informational purposes only.
AGENT-6-9005: The <i>component</i> has stopped	Is generated any time the watchdog agent a successfully stops a component. This message is for informational purposes only.

The *component* variable presented in the watchdog agent alerts list shown in [Table 11-3](#) represents any of these component values:

- rdu
- dpe

- stun
- tomcat
- cli
- snmpAgent

## Access Registrar Extension Point Alerts

Whenever a Cisco BAC Access Registrar extension point syslog alert is sent, you can find additional details in the Access Registrar log file in `<AR_HOME>/logs/name_radius_1_log`.

**Table 11-4** Access Registrar Extension Point Alerts

Alert	Description
<p><b>Error:</b></p> <p>Auth HTTP Adapter: Failed to initialize Background thread pool and Request queue, due to <i>Exception_message</i></p> <p><b>Clear:</b></p> <p>Auth HTTP Adapter: Background thread pool and Request queue initialized successfully.</p>	<p>The Access Registrar failed to initialize the background threads and queue in the extension point service.</p>
<p><b>Error:</b></p> <p>Auth HTTP Adapter: Failed to initialize Http connections, due to <i>Exception_message</i></p> <p><b>Clear:</b></p> <p>Auth HTTP Adapter: Http connections initialized successfully.</p>	<p>The Access Registrar failed to initialize the HTTP connection manager in the extension point service.</p>
<p><b>Error:</b></p> <p>Auth HTTP Adapter: Extension point unable to find a usable Auth Service.</p> <p><b>Clear:</b></p> <p>Auth HTTP Adapter: HTTP message POST successful.</p>	<p>The alert message will be sent if the Extension point could not find a usable DPE Auth service.</p>

## Monitoring Servers by Using SNMP

Cisco BAC supports management of servers using SNMP. Specifically, an SNMP-based management system can be used to monitor Cisco BAC server state, license utilization information, server connections, and server-specific statistics.

## SNMP Agent

The Cisco BAC SNMP agents support SNMP informs and traps, collectively called as notifications hereafter. You can configure the SNMP agent on the DPE by using `snmp-server` CLI commands, and on the RDU by using the `snmpAgentCfgUtil.sh` tool.

See [Using the snmpAgentCfgUtil.sh Tool, page 11-6](#), for additional information on the SNMP configuration command line tool, and the [Cisco Broadband Access Center 3.8 DPE CLI Reference](#), for additional information on the DPE CLI.

## MIB Support

Cisco BAC supports several different MIBs. These include:

- CISCO-BACC-DPE-MIB
- CISCO-BACC-RDU-MIB
- CISCO-BACC-SERVER-MIB

[Table 11-5](#) summarizes the MIB support in Cisco BAC:

**Table 11-5 Cisco BAC-Supported MIBs**

Installation Component	MIBs Supported
DPE	CISCO-BACC-SERVER-MIB
	CISCO-BACC-DPE-MIB
RDU	CISCO-BACC-SERVER-MIB
	CISCO-BACC-RDU-MIB

The RDU SNMP agent supports the CISCO-BACC-RDU-MIB, which defines managed objects for the RDU. This MIB defines statistics related to the state of the RDU and the statistics on the communication interface between the RDU and DPE.

The DPE SNMP agent supports the CISCO-BACC-DPE-MIB, which defines managed objects for the DPE. This MIB provides some basic DPE configuration and statistics information.

The SNMP agent supports the CISCO-BACC-SERVER-MIB. This MIB defines the managed objects that are common to all servers on Cisco BAC. This MIB supports the monitoring of multiple Cisco BAC servers when they are installed on the same device. The `ciscoBaccServerStateChanged` notification is generated every time a server state change occurs.



### Note

For a description of all objects, refer to the corresponding MIB files under the `<BPR_HOME>/rdu/mibs` directory.

## Using the snmpAgentCfgUtil.sh Tool

You can use the `snmpAgentCfgUtil.sh` tool to manage the SNMP agent.

By using this tool, which is located in the `<BPR_HOME>/snmp/bin` directory, you can add (or remove) your host to a list of other hosts that receive SNMP notifications, and start and stop the SNMP agent process.



**Note**

The default port number of an SNMP agent is 8001.

You can use the **snmpAgentCfgUtil.sh** tool for:

- [Adding a Host, page 11-7](#)
- [Deleting a Host, page 11-7](#)
- [Adding an SNMP Agent Community, page 11-8](#)
- [Deleting an SNMP Agent Community, page 11-9](#)
- [Starting the SNMP Agent, page 11-9](#)
- [Stopping the SNMP Agent, page 11-9](#)
- [Changing the SNMP Agent Location, page 11-10](#)
- [Setting Up SNMP Contacts, page 11-10](#)
- [Displaying SNMP Agent Settings, page 11-11](#)

## Adding a Host

You use this command to add the host address to the list of hosts that receive SNMP notifications from the SNMP agent.

### Syntax Description

```
snmpAgentCfgUtil.sh add host host-addr community community [udp-port port]
```

- *host-addr*—Specifies the IP address of the host that you want to add to the list of hosts.
- *community*—Specifies the community (read or write) to use while sending SNMP notifications.
- *port*—Identifies the UDP port used for sending the SNMP notifications.

### Examples

```
# ./snmpAgentCfgUtil.sh add host test.cisco.com community trapCommunity udp-port 162
OK
Please restart [stop and start] SNMP agent.
```

**Note**

The changes that you introduce through this command do not take effect until you restart the SNMP agent by using the **/etc/init.d/bprAgent restart snmpAgent** command. For detailed information, see [Cisco BAC Process Watchdog, page 9-1](#).

## Deleting a Host

You use this command to remove a host from the list of those receiving SNMP notifications from the SNMP agent.

### Syntax Description

```
snmpAgentCfgUtil.sh delete host host-addr
```

*host-addr*—Specifies the IP address of the host that you want to delete from the list of hosts.

**Examples**

```
# ./snmpAgentCfgUtil.sh delete host test.cisco.com
OK
Please restart [stop and start] SNMP agent.
```



**Note** The changes that you introduce through this command do not take effect until you restart the SNMP agent by using the `/etc/init.d/bprAgent restart snmpAgent` command. For detailed information, see [Cisco BAC Process Watchdog, page 9-1](#).

**Adding an SNMP Agent Community**

You use this command to add an SNMP community string to restrict access to the SNMP agent. The SNMP community name is used as a shared secret, with SNMP managers accessing the Cisco BAC SNMP agent.

**Syntax Description**

```
snmpAgentCfgUtil.sh add community string [ro | rw]
```

- *string*—Identifies the SNMP community.
- **ro**—Assigns a read-only (**ro**) community string. Only *get* requests (queries) can be performed. The *ro* community string allows **get** requests, but no **set** operations. The network management system and the managed device must reference the same community string.
- **rw**—Assigns a read-write (**rw**) community string. SNMP applications require read-write access for **set** operations. The *rw* community string enables write access to object identifier (OID) values.



**Note** The default **ro** and **rw** community strings are `bacread` and `bacwrite`, respectively. Cisco recommends that you change these values before deploying Cisco BAC. To change them, add new community names and delete the default ones.

**Examples**

```
# ./snmpAgentCfgUtil.sh add community fsda54 ro
OK
Please restart [stop and start] SNMP agent.
```



**Note** The changes that you introduce through this command do not take effect until you restart the SNMP agent by using the `/etc/init.d/bprAgent restart snmpAgent` command. For detailed information, see [Cisco BAC Process Watchdog, page 9-1](#).

## Deleting an SNMP Agent Community

You use this command to delete an SNMP community string to prevent access to the SNMP agent.

### Syntax Description

```
snmpAgentCfgUtil.sh delete community string [ro | rw]
```

- *string*—Identifies the SNMP community
- **ro**—Assigns a read-only (**ro**) community string
- **rw**—Assigns a read-write (**rw**) community string



#### Note

For additional information on the **ro** and **rw** community strings, see [Adding an SNMP Agent Community, page 11-8](#).

### Examples

```
# ./snmpAgentCfgUtil.sh delete community fsda54 ro
OK
Please restart [stop and start] SNMP agent.
```



#### Note

The changes that you introduce through this command do not take effect until you restart the SNMP agent by using the `/etc/init.d/bprAgent restart snmpAgent` command. For detailed information, see [Cisco BAC Process Watchdog, page 9-1](#).

## Starting the SNMP Agent

You use this command to start the SNMP agent process on which Cisco BAC is already installed.



#### Note

You can also start the SNMP agent by invoking the Cisco BAC watchdog process agent by using the `/etc/init.d/bprAgent start snmpAgent` command. For more information, see [Using Cisco BAC Process Watchdog from the Command Line, page 9-2](#).

### Examples

```
# ./snmpAgentCfgUtil.sh start
Process snmpAgent has been started
```

## Stopping the SNMP Agent

You use this command to stop the SNMP agent process on any Solaris computer on which Cisco BAC is already installed.



#### Note

You can also stop the SNMP agent by invoking the Cisco BAC watchdog process agent by using the `/etc/init.d/bprAgent stop snmpAgent` command. For more information, see [Using Cisco BAC Process Watchdog from the Command Line, page 9-2](#).

**Examples**

```
# ./snmpAgentCfgUtil.sh stop
Process snmpAgent has stopped
```

**Configuring an SNMP Agent Listening Port**

You use this command to specify the port number to which the SNMP agent will listen. The default port number that the RDU SNMP agent uses is 8001.

**Syntax Description**

```
snmpAgentCfgUtil.sh udp-port port
```

*port*— Identifies the port number to which the SNMP agent will listen.

**Examples**

```
# ./snmpAgentCfgUtil.sh udp-port 8001
OK
Please restart [stop and start] SNMP agent.
```

**Changing the SNMP Agent Location**

You use this command to enter a string of text that you use to indicate the location of the device running the SNMP agent. For example, you could use this string to identify the physical location of the device. You can enter any string up to 255 characters long.

**Syntax Description**

```
snmpAgentCfgUtil.sh location location
```

*location*—Specifies the character string identifying the agents location.

**Examples**

In this example, the physical location of the SNMP agent is in an equipment rack identified as *equipment rack 5D*:

```
# snmpAgentCfgUtil.sh location "equipment rack 5D"
```

**Setting Up SNMP Contacts**

You use this command to enter a string of text that you use to identify the contact person for the SNMP agent, together with information on how to contact this person. For example, you could use this string to identify a specific person including that person's telephone number. You can enter any string up to 255 characters long.

**Syntax Description**

```
snmpAgentCfgUtil.sh contact contact-info
```

*contact-info*— Specifies the character string identifying the individual to contact concerning the SNMP agent.

**Examples**

In this example, the contact name is *Ace Duffy* and the telephone extension is *1234*:

```
# ./snmpAgentCfgUtil.sh contact "Ace Duffy - ext 1234"
```

**Displaying SNMP Agent Settings**

You use this command to display all current SNMP settings.

**Syntax Description**

```
snmpAgentCfgUtil.sh show
```

**Examples**

```
# ./snmpAgentCfgUtil.sh show
Location                : Washington_1
Contact                 : John
Port Number             : 8001
Notification Type       : trap
Notification Recipient Table :
    [ Host IP address, Community, UDP Port ]
    [ 10.10.10.1, public, 162 ]
Access Control Table    :
    Read Only Communities
        bacread
    Read Write Communities
        bacwrite
```

**Specifying SNMP Notification Types**

You use this command to specify which types of notifications (traps or informs) the SNMP agent will send. By default, the agent sends traps; although you can set this to send SNMP informs instead.

**Note**

For the SNMP trap feature to work, you must enable the notification flag. In other words, the value for the MIB variable `0cbsNotifEnableFlags` (OID = `.1.3.6.1.4.1.9.9.349.1.1.1.5.1`) must be set to 1.

**Syntax Description**

```
snmpAgentCfgUtil.sh inform [retries retry_count timeout timeout] | trap
```

Where the parameter is the back-off timeout between retries.

**Examples**

```
snmpAgentCfgUtil.sh inform retries 3 timeout 1000
OK
Please restart [stop and start] SNMP agent.
```



**Note** Use the `snmpAgentCfgUtil.sh show` command to verify your configuration settings.

```
# ./snmpAgentCfgUtil.sh show
Location                : <unknown>
Contact                 : <unknown>
Port Number             : 8001
Notification Type       : inform
Notification Retries    : 3
```

```

Notification Timeout      : 1000
Notification Recipient Table :
    [ Host IP address, Community, UDP Port ]
Access Control Table      :
    Read Only Communities
        bacread
    Read Write Communities
        bacwrite

```

## Monitoring Server Status

This section describes how you can monitor the performance of the RDU and DPE servers in a Cisco BAC deployment. These servers are the central RDU server and the DPE servers.

You can check server statistics from the:

- Administrator user interface
- DPE CLI
- RDU and DPE log files using the administrator user interface or the DPE CLI.

## Using the Administrator User Interface

To view server statistics available on the administrator user interface:

- 
- Step 1** On the Primary Navigation Bar, click the **Server** tab.
- Step 2** The Secondary Navigation Bar displays your options: DPEs, Provisioning Group, RDU. Click the:
- **DPEs** tab to monitor all DPEs currently registered in the Cisco BAC database.
  - **RDU** tab to display RDU status and statistics.
- Step 3** If you clicked:
- **DPEs**—The Manage Device Provisioning Engine page appears. Each DPE name on this page is a link to another page that shows the details for that DPE. Click this link to display the details page.
  - **RDU**—The View Regional Distribution Unit Details page appears.
- 

## Using the DPE CLI

You can run the **show dpe** command to view the status of the DPE server. This command does not indicate if the DPE is running successfully, only that the process itself is currently executing. However, when the DPE is running, you can use statistics that this command displays to determine if the DPE is successfully servicing requests.

You can use the **show run** command to view the current configuration settings on the DPE.

### Example 11-1 show dpe Output

```
dpe# show dpe
```

```
BAC Agent is running
Process dpe is not running
```

This result occurs when the DPE is not running.

```
dpe# show dpe
BAC Agent is running
Process dpe is running

Broadband Access Center [BAC 3.8 <SOL_BAC_3_5_200081208_1446>].
Connected to RDU
Caching 10001 device configs and [3] files.
100 sessions succeeded and 12 sessions failed.
200 file requests succeeded and 3 file requests failed.
34 immediate device operations succeeded, and 0 failed.
12 home PG redirections succeeded, and 0 failed.
Using Signature key name [] with a validity of [3600].
Running for [12] days [20] hours [59] mins [5] secs.
```

This result occurs when the DPE is running.

### Example 11-2 show run output

```
dpe# show run
dpe service-auth xml-schema enable true
dpe shared-secret <value is set>
interface ip 10.86.147.122 pg-communication
log level 5-notification
no debug
service auth 1 address 127.0.0.1
service auth 1 enabled true
service auth 1 port 7551
service auth 1 ssl enabled false
service cwmp 1 client-auth digest
service cwmp 1 enabled true
service cwmp 1 port 7547
service cwmp 1 ssl cipher all-cipher-suites
service cwmp 1 ssl client-auth none
service cwmp 1 ssl enabled false
service cwmp 1 ssl keystore server-certs <value is set> <value is set>
service cwmp 2 client-auth digest
service cwmp 2 enabled false
service cwmp 2 port 7548
service cwmp 2 ssl cipher all-cipher-suites
service cwmp 2 ssl client-auth none
service cwmp 2 ssl enabled true
service cwmp 2 ssl keystore server-certs <value is set> <value is set>
service cwmp session timeout 60000
service cwmp-redirect 1 attempts 3
service cwmp-redirect 1 limit 20
service cwmp-redirect 1 lookup enabled true
service cwmp-redirect 1 respond enabled true
service cwmp-redirect 1 retry-after-timeout 60
service cwmp-redirect 1 status-period 5000
service cwmp-redirect 1 timeout 500
service http 1 client-auth digest
service http 1 enabled true
service http 1 port 7549
service http 1 ssl cipher all-cipher-suites
service http 1 ssl client-auth none
service http 1 ssl enabled false
service http 1 ssl keystore server-certs <value is set> <value is set>
service http 2 client-auth digest
```

```

service http 2 enabled false
service http 2 port 7550
service http 2 ssl cipher all-cipher-suites
service http 2 ssl client-auth none
service http 2 ssl enabled true
service http 2 ssl keystore server-certs <value is set> <value is set>
snmp-server community bacread ro
snmp-server community bacwrite rw
snmp-server contact <unknown>
snmp-server location <unknown>
snmp-server udp-port 8001
tacacs-server retries 2
tacacs-server timeout 5

```



**Note** For more information, see the [Cisco Broadband Access Center 3.8 DPE CLI Reference](#).

## Monitoring Performance Statistics

Cisco BAC provides a rich set of statistics to aid in troubleshooting system performance. The statistics are available across different major components, including the RDU, the Provisioning API Command Engine, and device operations.

You can enable the collection of performance statistics from the administrator user interface or from the DPE CLI.

- To enable or disable performance statistics on the RDU, from the user interface, choose **Configuration > Defaults > System Defaults**.
  - To enable this feature, against Performance Statistics Collection, click the **Enabled** radio button.
  - To disable this feature, against Performance Statistics Collection, click the **Disabled** radio button.
- To enable or disable performance statistics on the DPE, from the DPE CLI in the enabled mode, enter **debug dpe statistics**. To disable performance statistics from the CLI, use the **no debug dpe statistics** command.



**Note** Before using any debug command, ensure that DPE debugging is enabled by running the **debug on** command. For more information, see the [Cisco Broadband Access Center 3.8 DPE CLI Reference](#).

After you enable the performance statistics feature, you can choose to view performance statistics from the perfstat.log file or analyze the data by using the **runStatAnalyzer.sh** tool.

You can also view CWMP statistics specifically by using the administrator user interface. Choose **Servers > DPEs > Manage Device Provisioning Page > View Device Provisioning Engines Details**. (See [Figure 16-7](#).)

For details on performance statistics collection, see:

- [Understanding perfstat.log, page 11-15](#)
- [Using runStatAnalyzer.sh, page 11-15](#)



## Understanding *perfstat.log*

You can monitor performance statistics by using the data recorded in the *perfstat.log* file, in which statistics data is logged at specific intervals; this time interval is 5 minutes. The *perfstat.log* file resides in separate directories for the RDU (`<BPR_DATA>/rdu/logs/statistics`) and the DPE (`<BPR_DATA>/dpe/logs/statistics`).

Each *perfstat.log* file stores data for a minimum of one day and a maximum of 30 days. Since you can turn on and turn off the performance statistics feature, the logs may not represent data for consecutive days.

The *perfstat.log* file is renamed every day by using the *perfstat.N.log* format, where *N* is any value between 1 and 100. For example, *perfstat.100.log* will be the oldest log while *perfstat.1.log* will be the most recent renamed *perfstat.log* file.



**Note** The data is stored in comma-separated vector format. The format of each statistic is `yyyymmdd:hh:mm, component, interval-in-milliseconds, stat1-tag, stat1-value, stat2-tag, stat2-value, ...` *Stat1-tag* and *stat1-value* specify the tag ID and the value of each statistic, respectively.

## Using *runStatAnalyzer.sh*

You can use Cisco BAC to analyze and provide a summary of performance statistics by using the **runStatAnalyzer.sh** tool. To analyze collected performance statistics, run the **runStatAnalyzer.sh** tool from the:

- `<BPR_HOME>/rdu/bin` directory for the RDU.
- `<BPR_HOME>/dpe/bin` directory for the DPE.

### Syntax Description

```
# runStatAnalyzer.sh [-d perfddata-dir] [-s start-time] [-e end-time] [-c component]
[-f output-format] [-help] [-help components] [-help statistics [component]]
```

- **perfddata-dir**—Specifies the directory from which performance statistics are analyzed. This is the *perfstatN.dat* file located in the following default directories:
  - `<BPR_HOME>/rdu/logs/statistics` for the RDU
  - `<BPR_HOME>/dpe/logs/statistics` for the DPE
- *start-time*—Specifies the time from which collected data is to be analyzed. By default, all collected statistics are reported. Use this time format to specify *start-time*: `yyyy-mm-dd:hh:mm`.
- *end-time*—Specifies the time until which data collected data is to be analyzed. By default, all collected statistics are reported. Use this time format to specify *end-time*: `yyyy-mm-dd:hh:mm`.

- *component*—Specifies the Cisco BAC component for which you want to analyze statistics. You can choose to specify all components (by using the **all** option) or specify from the following list of supported components:

Component Option	Description	Applicable at	
		RDU	DPE
<b>pace</b>	Provisioning API Command Engine	<b>P</b>	
<b>rdu</b>	Regional Distribution Unit	<b>P</b>	
<b>ext</b>	Extensions	<b>P</b>	
<b>cwmp</b>	CWMP Service		<b>P</b>
<b>httpfile</b>	HTTP File Service		<b>P</b>
<b>proxyreq</b>	Proxy Request Operations	<b>P</b>	<b>P</b>
<b>leasequery</b>	Lease Query		<b>P</b>
<b>Authservice</b>	AUTH service		<b>P</b>
<b>cmhscr</b>	CMHS Connection Request	<b>P</b>	
<b>scriptableExt</b>	Scriptable Extension		<b>P</b>
<b>moip</b>	Multi-Instance Object Processing		<b>P</b>

**Note** By default, statistics are analyzed for all components.

- *output-format*—Specifies the format of the output you want, which could be:
  - **summary**—Provides output of the transaction rate summary. This is the default option.



**Note** The summarized transaction rate is calculated based on the 5-minute interval data recorded in *perfstat.log*.

- **log**—Provides output similar to a log message.
- **-help**—Provides usage information on the **runStatAnalyzer.sh** tool.
- **-help components**—Provides information on the Cisco BAC component for which you can analyze statistics.
- **-help statistics component**—Provides information on the statistics that each Cisco BAC component returns. You can choose to view help for all components (by using the **all** option) or for individual components: **pace**, **rdu**, **ext**, **cwmp**, **httpfile**, **proxyreq**.

### Example 11-3 Log Output Through runStatAnalyzer.sh

```
# runStatAnalyzer.sh -s 2006-04-11:12:59 -e 2006-04-11:13:09 -c pace -f log

2006-04-11:12:59 PACE statistics last 5 minutes- In Queue 0; Dropped 0; Dropped-Full Queue
0; Batches Received 0; Internal Batches Received 0; Succeed 0; Failed 0; Processed 0;
Processing avgTime 0 msec; Batch maxTime 0 msec; In Queue maxTime 0 msec; Processing
maxTime 0 msec; CRS Completed 0
2006-04-11:13:04 PACE statistics last 5 minutes- In Queue 0; Dropped 0; Dropped-Full Queue
0; Batches Received 0; Internal Batches Received 0; Succeed 0; Failed 0; Processed 0;
Processing avgTime 0 msec; Batch maxTime 0 msec; In Queue maxTime 0 msec; Processing
maxTime 0 msec; CRS Completed 0
```

```
2006-04-11:13:09 PACE statistics last 5 minutes- In Queue 0; Dropped 0; Dropped-Full Queue
0; Batches Received 0; Internal Batches Received 0; Succeed 0; Failed 0; Processed 0;
Processing avgTime 0 msec; Batch maxTime 0 msec; In Queue maxTime 0 msec; Processing
maxTime 0 msec; CRS Completed 0
```



**Note** The number of statistics available varies on the component specified.

#### Example 11-4 Summary Output Through runStatAnalyzer.sh

```
# runStatAnalyzer.sh -s 2006-04-11:12:59 -e 2006-04-11:13:29 -c pace -f summary
```

```
2006-04-11:13:04 PACE statistics last 5 minutes- In Queue 0; Dropped 0; Dropped-Full Queue
0; Batches Received 0; Internal Batches Received 0; Succeed 0; Failed 0; Processed 0;
Processing avgTime 0 msec; Batch maxTime 0 msec; In Queue maxTime 0 msec; Processing
maxTime 0 msec; CRS Completed 0
2006-04-11:13:29 PACE statistics last 30 minutes- In Queue 0; Dropped 0; Dropped-Full
Queue 0; Batches Received 0; Internal Batches Received 0; Succeed 0; Failed 0; Processed
0; Processing avgTime 0 msec; Batch maxTime 0 msec; In Queue maxTime 0 msec; Processing
maxTime 0 msec; CRS Completed 0
```



**Note**

Summarized data is visible only if a complete set of data is available for the given interval. For example, the summary output of a 30-minute summarized interval appears only if there is 30 minutes worth of data. Based on the data available, the summarized time intervals are 5 minutes, 30 minutes, 60 minutes, 3 hours, 6 hours, 12 hours, 24 hours, 7 days, 14 days, 21 days, and 30 days.

## Monitoring STUN Statistics

Cisco BAC STUN server provides a rich set of statistics to aid in troubleshooting system performance and error conditions while communicating with the device. It also performs troubleshooting when connection requests are received from RDU and forwarded to the device.

For details on STUN statistics collection see, [Understanding stunstatistics.log](#), page 11-17.

## Understanding *stunstatistics.log*

You can monitor performance statistics by using the data recorded in the *stunstatistics.log* file, in which statistics data is logged at specific intervals. By default, the time interval is set to 15 minutes.

You can configure the interval in *stun.properties* available under `STUN_HOME/stun/conf` directory. The *stunstatistics.log* file resides in `STUN_DATA/stun/logs/`.

#### Example 11-5 Sample Logs Collected Through *stunstatistics.log* File

```
Number of Binding Request Received=40,
Number of Binding Response Sent=40,
Number of Binding Timeout Discovery Response Sent=0,
Number of Binding Update Received=60,
Number of Binding Update Authentication Success=25,
Number of Binding Update Authentication Failure (401-Unauthorized)=35,
Number of Binding Update Authentication Failure (420-Unknown Attribute)=0,
Number of Binding Update Authentication Failure (431-Integrity Check Failure)=0,
Number of Binding Update Authentication Failure (432-Missing Username)=0,
Number of Binding Update Authentication Failure (500-Server Error)=0,
Number of Dropped Requests (Network Failures)=0,
```

```

Number of UDP Connection Request Failure (Binding Mapping Not Found)=9,
Number of UDP Connection Request Failure (Shared Secret Not Configured)=0,
Number of UDP Connection Request Failure (Network Failures)=0,
Number of UDP Connection Request Sent=54,
Number of CXF Connection Request Received=27,
Number of CXF Connection Response Success=18,
Number of CXF Service Authentication Failure (Unauthorized)=0,
Number of CXF Service Authentication Failure (Protocol Header Not Found)=0

```

## STUN Binding Information

The STUN server stores the binding information from the device in its cache. You can view the binding information at any point of time by running the utility `dumpStunBindingInfo.sh` available under `STUN_HOME/stun/internal/bin` directory.

### Using `dumpStunBindingInfo.sh`

To display the collected STUN binding information, run the `dumpStunBindingInfo.sh` tool from the `STUN_HOME/stun/internal/bin` directory.

**Syntax Description** `dumpStunBindingInfo.sh [-?] [-file]`

where:

- `-?`—Prints this usage message
- `-file`—Bindinginfo file to be parsed

Here binding info file is available under the `STUN_DATA/stun/` directory.

## Traffic Profiling

Cisco BAC provides details about the traffic between the CPE and the DPE to provide visibility into flows that may be causing issues. This traffic profiling provides statistics on the following:

- Number of CWMP sessions handled
- Number of devices rejected
- Number of HTTP file requests handled
- Home Provisioning Group redirection status
- Traffic caused by chatty clients

The periodic statistics provides details, including the name of each Remote Procedure Call (RPC) and the specific types of Inform messages. The following RPC methods are monitored and reported:

- `GetRPCMethods`
- `SetParameterValues`
- `GetParameterValues`
- `SetParameterAttributes`
- `GetParameterAttributes`

- AddObject
- DeleteObject
- Download
- Reboot
- Inform
- TransferComplete
- AutonomousTransferComplete
- GetQueuedTransfers
- ScheduleInform
- SetVouchers
- GetOptions
- Upload
- FactoryReset
- GetAllQueuedTransfers
- Kicked
- RequestDownload

To enable or disable traffic statistics on the RDU, from the user interface, choose **Configuration > Defaults > System Defaults**.

- To enable this feature, against Performance Statistics Collection, click the **Enabled** radio button.
- To disable this feature, against Performance Statistics Collection, click the **Disabled** radio button.

To enable or disable traffic statistics on the DPE, from the DPE CLI in the enabled mode, enter **debug dpe statistics**. To disable traffic profiling from the CLI, use the **no debug dpe statistics** command.

After you enable the traffic statistics feature, you can view the traffic statistics from the *perfstat.log* file or analyze the data by using the **runStatAnalyzer.sh** tool.

You can view the traffic statistics by using the administrator user interface. Choose **Servers > DPEs > Manage Device Provisioning Page > View Device Provisioning Engines Details**.





## CHAPTER 12

# Configuring CWMP Service

---

This chapter describes how to configure the CWMP service in Cisco Broadband Access Center (BAC).

This chapter includes the following sections:

- [CWMP Service Configuration, page 12-1](#)
- [Connection Request Service, page 12-2](#)
- [Provisioning Group Scalability and Failover, page 12-16](#)

## CWMP Service Configuration

CWMP is a specification of a set of remote procedure calls (RPCs), for example, `GetParameterValues`, `SetParameterValues`, and so on. These RPCs define the generic mechanism by which Cisco BAC reads or writes parameters to customer premises equipment (CPE) in order to manage it. These parameters include:

- Device configuration information
- Status information
- Performance statistics

You can enable or disable CWMP features on the DPE by using the DPE CLI.

Among the features that you can configure on the DPE are:

- HTTP-based Basic or Digest authentication
- Certificate-based authentication
- HTTP over SSL/TLS service settings
- Handling of unknown devices
- Debugging settings
- Session management settings
- CWMP service settings
- HTTP file service settings

For information on how to configure these properties, see the [Cisco Broadband Access Center 3.8 DPE CLI Reference](#).

## Configuring Service Ports on the DPE

You can configure the ports on which the CWMP services communicate with a device. You can independently configure each instance of the CWMP services—the CWMP RPC service and the HTTP file service—to suit your requirements. [Table 12-1](#) describes how you configure ports for each service.

**Table 12-1** Configuring Service Ports

Command	Syntax Description	Default
<b>Configuring the CWMP RPC Service</b>		
<code>service cwmp num port port</code>	<ul style="list-style-type: none"> <li><code>num</code>—Identifies the CWMP service, which could be 1 or 2.</li> <li><code>port</code>—Identifies the port number that the service should use.</li> </ul> <p><b>Example:</b></p> <pre>dpe# service http 1 port 7547 % OK (Requires DPE restart "# dpe reload")</pre>	By default, the CWMP service is configured to listen on: <ul style="list-style-type: none"> <li>Port 7547 for service 1.</li> <li>Port 7548 for service 2.</li> </ul>
<b>Configuring the HTTP File Service</b>		
<code>service http num port port</code>	<ul style="list-style-type: none"> <li><code>num</code>—Identifies the HTTP file service, which could be 1 or 2.</li> <li><code>port</code>—Identifies the port number that the service should use.</li> </ul> <p><b>Example:</b></p> <pre>dpe# service http 1 port 7549 % OK (Requires DPE restart "# dpe reload")</pre>	By default, the HTTP file service is configured to listen on: <ul style="list-style-type: none"> <li>Port 7549 for service 1.</li> <li>Port 7550 for service 2.</li> </ul>

For more configuration instructions, see the [Cisco Broadband Access Center 3.8 DPE CLI Reference](#).

## Connection Request Service

Connection requests instruct the device to establish a CWMP session with the DPE. You can use the Cisco BAC connection request service to activate a configuration on a device, execute firmware changes to the device, or execute immediate operations upon the device.

Initiated by the DPE, connection requests are the only method available to the DPE to establish a session with a device. Once a session is established, the device or the DPE may perform any RPCs, including device operations and configuration changes.

[Figure 12-1](#) describes the flow of a connection request in Cisco BAC. The RDU delegates the connection request to the best available DPE in the provisioning group of the device. Once the connection request ends, the DPE notifies the RDU of the result.



Figure 12-1 Connection Request in BAC

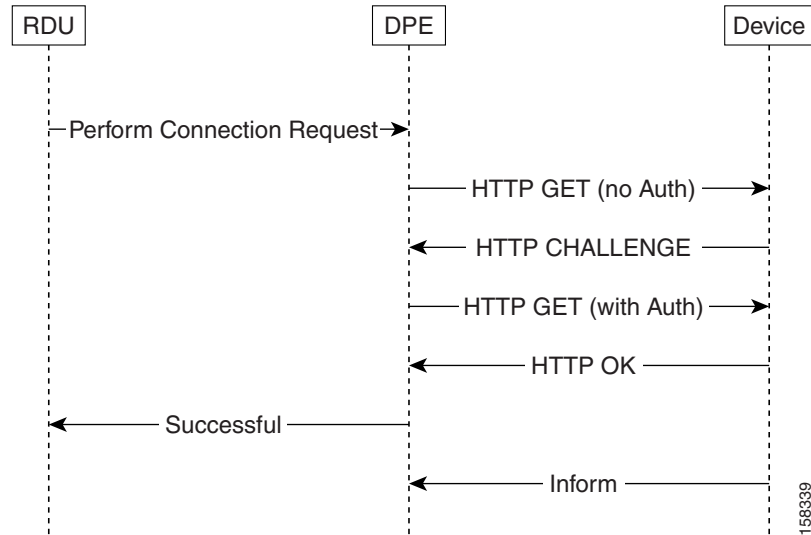

## Configuring Connection Request Options

You can use Cisco BAC to control the behavior of connection requests by configuring your preferences for:

- [Configuring Authentication](#)
- [Configuring Connection Request Methods](#)
- [Configuring Reachability](#)



### Note

You can set your preferences on the device object or in its property hierarchy.

## Configuring Authentication

Two properties that you set on the device object in the RDU affect authentication. They are:

- On the API:
  - `IPDeviceKeys.CONNECTION_REQUEST_USERNAME`
  - `IPDeviceKeys.CONNECTION_REQUEST_PASSWORD`
- On the administrator user interface:
  - **Devices > Modify Device > Connection Request User Name** field
  - **Devices > Modify Device > Connection Request Password** field

You can also set the connection request username and password while adding a device on the Add Device page, and change the username and password in the Modify Device page.

Both properties control the connection request username and password that are used in DPE-CPE authentication. This username and password differ from the username and password used to authenticate CWMP sessions between the DPE and a device. These properties are for a single device; thus, they can be set only on the device object.

If you do not specify a Connection Request password, a Connection Request password is automatically generated for the device using the connection request master secret. If you do not specify the Connection Request username, the device ID is used.

It is up to the device to issue an authentication challenge during connection request authentication, as illustrated in [Figure 12-1](#). The DPE expects to be challenged with HTTP Digest authentication. There is no DPE configuration for connection request handling.

The API properties do not automatically update device parameters. You must preconfigure the corresponding values on the device or configure the values using a configuration template which can reference these properties.

## Autogenerating Connection Request Passwords

In this release of Cisco BAC, Connection Request passwords can be autogenerated or specified by the Operational Support System (OSS).

### Cisco BAC Generated Passwords:

In this approach, Cisco BAC generates a unique Connection Request password for each CWMP device. The password is encrypted using the connection request master secret and forwarded to the DPEs. You specify the connection request master secret in the CWMP Defaults page in the administrator user interface (see [CWMP Defaults, page 17-7](#)).

The DPEs derive the device passwords by using the hash message authentication code. If the DPE fails to authenticate using the current password, Cisco BAC attempts to authenticate by using the old password derived from the earlier master secret. Cisco BAC stores the last 15 passwords, by default, and attempts authentication by using each of these passwords in reverse order, until authentication succeeds.

To use autogenerated passwords, you have to specify the value, `__AUTO_GENERATED__` for Connection Request password in the configuration template.

When the RDU attempts a connection request to a device:

- If `/IPDevice/connectionRequestPassword` property is not specified in the device record, the RDU assumes that an autogenerated password is used for that device.
- If `/IPDevice/connectionRequestUsername` property is not specified in the device record, the RDU uses the device ID as the user name for that device.

### OSS Provided Passwords:

In this approach, you can provide passwords that may or may not be unique to each device. The Connection Request password is set on the `/IPDevice/connectionRequestPassword` property in the device record. When the password is set on the property, the following changes are triggered in the system:

- This RDU-provided password is used as the Connection Request password, instead of the autogenerated password at the DPE. As a rule, the password set on the device takes precedence over the autogenerated password.
- The hash key for the device reverts to the legacy format (*DeviceConfHash*).

You can also set the Connection Request username and password in the device configuration templates.

- If the username and password are set on both the device record and the configuration template, the username and password set in the device record are used.

- If the username and password are present only on the configuration template (and not in the device record), this password is used instead of the auto-generated password.

## Configuring Connection Request Methods

You can specify the method in which Cisco BAC attempts to perform a connection request by using the provisioning API or the administrator user interface. The selected method dictates how Cisco BAC determines the connection request URL to be used to contact the device.

The API property `IPDeviceKeys.CONNECTION_REQUEST_METHOD` specifies the connection request method (subsequent descriptions provide the details of each method).



### Note

You can specify this property anywhere in the device hierarchy.

To configure the default connection request method by using the administrator user interface, choose **Configuration > Default > CWMP Defaults**, and select an option from the drop-down list.

Cisco BAC supports the following methods to configure a connection request:

- Discovered
- Using FQDN
- Using IP
- LeaseQuery
- Annex G
- Use CMHS

When selecting a connection request method, it is important to consider performance and manageability, as each method provides different levels of both.

### Discovered Connection Request

The Discovered method, during CPE interactions with the DPE, modifies the data synchronization instruction to discover the device's connection request URL, which corresponds to the parameter `InternetGatewayDevice.ManagementServer.ConnectionRequestURL`, whenever the DPE interacts with the device. The RDU records any updates to this parameter value and uses it when making connection requests.



### Note

This value must be discovered before connection requests are attempted.

Because this parameter value changes each time the device's WAN IP address changes and every update has to be stored at the RDU, it is not the optimal method for connection requests.

### Use FQDN Connection Request

The Use FQDN method uses the fully qualified domain name (FQDN) specified for the device at the RDU to construct a connection request URL for the device. It uses the FQDN along with the values specified in the following properties on the API:

- `IPDeviceKeys.CONNECTION_REQUEST_PORT`
- `IPDeviceKeys.CONNECTION_REQUEST_PATH`

You can also specify these properties on the administrator user interface:

---

**Step 1** Choose **Devices > Manage Devices**.

**Step 2** Use one of these methods:

- Add a device record. To do this, click the **Add** button. The Add Device page appears.
- Search for a device record. To do this,
  - a. Specify a Search Type and enter values for the screen components that are unique to the search type that you select.

A list of devices appears.

- b. Click the Identifier link corresponding to the desired device.

The Modify Device page appears.

**Step 3** From the Property Name drop-down list, select the `/IPDevice/connectionRequestPort` and `/IPDevice/connectionRequestPath` properties, and enter appropriate values in the Property Value field.



---

**Note** The API constants for `/IPDevice/connectionRequestPort` and `/IPDevice/connectionRequestPath` are `IPDeviceKeys.CONNECTION_REQUEST_PORT` and `IPDeviceKeys.CONNECTION_REQUEST_PATH`, respectively.

---

**Step 4** Click **Add**.

---

You can specify the port and path properties anywhere in the property hierarchy.



---

**Note** Because the Use FQDN method relies on the DNS being updated with the device's correct IP address, you do not need to update Cisco BAC whenever the device IP address changes. Subsequently, this option is the most scalable one for connection requests.

---

## Use IP Connection Request

The Use IP method discovers the device's WAN IP address by using the same mechanism as the Discovered method. Then, it constructs a connection request URL for the device by using the values in the following API properties:

- `IPDeviceKeys.CONNECTION_REQUEST_PORT`
- `IPDeviceKeys.CONNECTION_REQUEST_PATH`

You can also specify these properties on the administrator user interface:

---

**Step 1** Choose **Devices > Manage Devices**.

**Step 2** Use one of these methods:

- Add a device record. To do this, click the **Add** button. The Add Device page appears.
- Search for a device record. To do this,
  - a. Specify a Search Type and enter values for the screen components that are unique to the search type that you select.

A list of devices appears.

- b. Click the Identifier link corresponding to the desired device.

The Modify Device page appears.

- Step 3** From the Property Name drop-down list, select the `/IPDevice/connectionRequestPort` and `/IPDevice/connectionRequestPath` properties, and enter appropriate values in the Property Value field.



**Note** The API constants for `/IPDevice/connectionRequestPort` and `/IPDevice/connectionRequestPath` are `IPDeviceKeys.CONNECTION_REQUEST_PORT` and `IPDeviceKeys.CONNECTION_REQUEST_PATH`, respectively.

- Step 4** Click **Add**.

Because the Use IP method relies on the RDU having the device's WAN IP address, it requires the WAN IP address to be discovered before connection requests are attempted. Also, because the device's WAN IP address changes, the RDU must be updated with the new IP address. Subsequently, this option is not the optimal method for connection requests.

## Using LeaseQuery

The LeaseQuery method discovers the latest IPsec address of the HNB from Cisco Network Registrar DHCP server. It first forms the Connection request URL by using the following API properties and then sends it to HNB through SeGW (Security Gateway).

- `IPDeviceKeys.CONNECTION_REQUEST_PORT`
- `IPDeviceKeys.CONNECTION_REQUEST_PATH`

You can also specify these properties on the administrator user interface:

- Step 1** Choose **Devices > Manage Devices**.

- Step 2** Use one of these methods:

- Add a device record. To do this, click **Add**. The Add Device page appears.
- Search for a device record. To do this,
  - a. Specify a Search Type and enter values for the screen components that are unique to the search type that you select. A list of devices appears.
  - b. Click the Identifier link corresponding to the desired device. The Modify Device page appears.

- Step 3** From the Property Name drop-down list, select the `/IPDevice/connectionRequestMethod`, `/IPDevice/connectionRequestPort` and `/IPDevice/connectionRequestPath` properties, and enter the appropriate values in the Property Value field.



**Note** The API constants for `/IPDevice/connectionRequestMethod`, `/IPDevice/connectionRequestPort` and `/IPDevice/connectionRequestPath` are `IPDeviceKeys.CONNECTION_REQUEST_METHOD`, `IPDeviceKeys.CONNECTION_REQUEST_PORT`, and `IPDeviceKeys.CONNECTION_REQUEST_PATH`, respectively.

- Step 4** Click **Add**.

## Configuring STUN Parameters (Annex G)

Cisco BAC now includes the TR-069 Annex G support for remotely managing CPE devices which are connected through a NAT gateway. Annex G uses a STUN server to identify a CPEs public IP address and port details.

The STUN server also tracks all the changes being made to the CPEs. Annex G uses a UDP based connection request mechanism defined in TR069 Annex G to allow Cisco BAC to initiate a session with the CPEs.

---

**Step 1** Choose **Devices > Manage Devices**.

**Step 2** Use one of these methods:

- Add a device record. To do this:  
Click the Add button. The Add Device page appears.
- Search for a device record. To do this,
  - a. Specify a Search Type and enter values for the screen components that are unique to the search type that you select.  
A list of devices appears.
  - b. Click the Identifier link corresponding to the desired device.  
The Modify Device page appears.

**Step 3** From the Property Name drop-down list, select the */IPDevice/connectionRequestPort* and */IPDevice/connectionRequestPath* properties, and enter appropriate values in the Property Value field.

Configure the following properties at the property hierarchy level:

- */IPDevice/cr/stunEnable*
- */IPDevice/cr/stunServerAddress*
- */IPDevice/cr/stunServerPort*
- */IPDevice/cr/stunServerHttpPort*
- */IPDevice/cr/stunServerHttpUsername*
- */IPDevice/cr/stunServerHttpPassword*

The API constants for */IPDevice/cr/stunEnable*, */IPDevice/cr/stunServerAddress*, */IPDevice/cr/stunServerHttpPort*, */IPDevice/cr/stunServerPort*, */IPDevice/cr/stunServerHttpUsername*, and */IPDevice/cr/stunServerHttpPassword* are:

`IPDeviceKeys.STUN_ENABLED`, `IPDeviceKeys.STUN_SERVER_ADDRESS`,  
`IPDeviceKeys.STUN_SERVER_PORT`, `IPDeviceKeys.STUN_SERVER_HTTP_PORT`,  
`IPDeviceKeys.STUN_HTTP_USER_NAME`, and `IPDeviceKeys.STUN_HTTP_PASSWORD`, respectively.

**Step 4** Click **Add**.

---

You can specify the port and path properties anywhere in the property hierarchy.

## Configuring CMHS Connection Request (Use CMHS)

This method allows Cisco BAC to send connection request to CPE devices using the CMHS server, using BAC NB API Interfaces or BAC Admin UI.

When RDU receives the connection request message, it sends the message to the CMHS server that is configured in the BAC properties hierarchy. The CMHS NB API client contacts the CMHS server that the DLC is most likely be connected to.

- 
- Step 1** Choose **Devices > Manage Devices**.
- Step 2** Use one of these methods:
- Add a device record. To do this:  
Click Add. The Add Device page appears.
  - Search for a device record. To do this:
    - a. Specify a Search Type and enter values for the screen components that are unique to the search type that you select.  
A list of devices appears.
    - b. Click the Identifier link corresponding to the desired device.  
The Modify Device page appears.
- Step 3** From the Property Name drop-down list, select the `/IPDevice/connectionRequestMethod` property, and select **Use CMHS** from the Property Value drop-down list.
- Step 4** Click **Add**.
- Step 5** Create a group type called CMHS. See [Adding a Group Type, page 16-19](#) for details on how to add a new group type.
- Step 6** Add a group with type CMHS for each CMHS server which needs to be considered to send CMHS connection request. See [Adding a New Group, page 16-20](#) for details on how to add a new group.
- Step 7** Configure the following properties with CMHS server details, host, http port, user name and password, in the BAC properties hierarchy at group level.
- `/IPDevice/cr/cmhsNbApiAddress`
  - `/IPDevice/cr/cmhsNbApiPort`
  - `/IPDevice/cr/cmhsNbApiUsername`
  - `/IPDevice/cr/cmhsNbApiPassword`



---

**Note** CMHS groups must not be used for any other purpose other than configuring CMHS server details for CMHS connection requests.

---

If you do not specify any values for the properties `/IPDevice/cr/cmhsNbApiUsername` and `/IPDevice/cr/cmhsNbApiPassword`, the default values are taken from `cmhs.properties` file available in the `BAC_HOME/rdu/conf/` folder. For the property `/IPDevice/cr/cmhsNbApiPort`, the default value is 80.



---

**Note** You can use the API `IPDevice.changeNodeProperties()`, if want to change any of the BAC properties for the CMHS group.

---

- Step 8** Configure CMHS Server List Property, `/IPDevice/cr/cmhsServerListPropertyName` with a deployment specific Custom Property name. It needs to be set on BAC property hierarchy using BAC NB API or UI.

This Custom Property is not pre-defined by BAC. It needs to be created and populated with comma separated values of CMHS groups names. These values need to be considered while sending CMHS connection request.



**Note** The API constants for /IPDevice/connectionRequestMethod, is `IPDeviceKeys.CONNECTION_REQUEST_METHOD`.

## Configuring External URLs on DPE

The ACS URL is the configured URL of the Cisco BAC server associated with each provisioning group. The devices use this URL to contact the DPEs in a given provisioning group. The RDU uses this URL to perform various operations, such as redirecting the devices to the home provisioning group.

The ACS URL that the DPE issues, depends on the URL that is configured for each of the CWMP services. You can use the following commands to configure the external URL for each service running on the DPE:

Command	Description
<code>service cwmp 1 external-url url</code>	Configures the DPE to represent externally the specified external URL as the URL of the CWMP service 1.
<code>service cwmp 2 external-url url</code>	Configures the DPE to represent externally the specified external URL as the URL of the CWMP service 2.
<code>service http 1 external-url url</code>	Configures the DPE to represent externally the specified external URL as the URL of the HTTP service 1.
<code>service http 2 external-url url</code>	Configures the DPE to represent externally the specified external URL as the URL of the HTTP service 2.

For specific information about using these commands, see the [Cisco Broadband Access Center 3.8 DPE CLI Reference](#).

For CWMP services, the URL of the CWMP service that is first enabled on the DPE is sent to the RDU as the discovered ACS URL.

## Disabling Connection Requests

You can choose to disable the connection request service. This option is useful if there is no STUN server and a device is behind NAT setup. Connection requests are not possible in such scenarios.



**Note** You can use ConnectionRequest via API device operations even if you disable connection requests.



## Configuring Reachability

Reachability plays an important role in configuring connection requests. In earlier versions of Cisco BAC, connection requests were refused if a device's reported IP address and its source IP address did not match. This was because this implies that the device used the NAT standard, and therefore, configuration requests did not normally succeed. You could change this behavior from the administrator user interface or the API.

Cisco BAC supports a new standalone STUN server to handle the UDP connection requests feature. A UDP based connection request mechanism defined in TR069 Annex G, allows Cisco BAC to initiate a session with a CPE that is operating behind a NAT gateway. STUN Service can be run on Solaris or Linux.

By using the API, set the property `IPDeviceKeys.FORCE_ROUTABLE_IP_ADDRESS` to `true` to allow TCP based connection requests regardless of a mismatch in the device source IP address.

From the administrator user interface:

---

**Step 1** Choose **Devices > Manage Devices**.

**Step 2** Use one of these methods:

- Add a device record. To do this:

Click the Add button. The Add Device page appears.

- Search for a device record. To do this,

- a. Specify a Search Type and enter values for the screen components that are unique to the search type that you select.

A list of devices appears.

- b. Click the Identifier link corresponding to the desired device.

The Modify Device page appears.

**Step 3** From the Property Value drop-down list, select `/IPDevice/forceRouteIPAddress`, and set a property value.

The API constant for `/IPDevice/forceRouteIPAddress` is `IPDeviceKeys.FORCE_ROUTABLE_IP_ADDRESS`.

**Step 4** Click **Add**.



---

**Note** You can specify this property anywhere on the device's hierarchy.

---

## Discovering Data from Devices

This section describes the Discovery of Data feature, which you use to retrieve a predefined set of parameters from the device, and store these parameters in the RDU for future use.

You can use this discovered data to manage device firmware and device configurations by providing some key attributes of the device and its current configuration. Discovered parameters are updated at the RDU any time their values change on the device.

You can configure data discovery at the RDU. The RDU forwards discovery policy instructions and the values of parameters, discovered for each device during the previous discovery process, to the appropriate DPEs. During interactions with the device, the DPE consults the discovery policy instructions specific to the device to determine what parameters need to be discovered.

After parameter values are discovered, existing device parameters are compared with those already stored for the device. If the values have changed or are being obtained for the first time, this data is updated at the RDU. If the RDU is not available to receive the update, the newly discovered data is dropped, and the entire process of data discovery is initiated the next time the device connects with the DPE.

Discovered parameters are stored on device records and you can view them by using the administrator user interface or obtain them through the API `IPDevice.getDetails()` call. `IPDevice-getDetails()` API also retrieves the device data along with the device property hierarchy. To view discovered parameters using the user interface, access the Manage Devices page under the **Devices** tab on the primary navigation bar.

Locate the device by using the search options, and click the **View Details** icon (🔍) corresponding to the device. The Device Details page appears, displaying details of the discovered parameters for the device.

Multi-instance object support is available in data discovery for preregistered and unknown devices. For more information on multi-instance object support, see [Multi-Instance Object Support, page 4-5](#).

The following sections describe:

- [Configuring Data Discovery, page 12-12](#)
- [Troubleshooting Data Discovery, page 12-13](#)
- [Automatic IMEI Update, page 12-15](#)

## Configuring Data Discovery

Data discovery policy is configured using the RDU and includes parameters checked:

- On every device contact.
- Only upon a firmware upgrade.

While the discovery of data process executes every time a device establishes contact with the DPE, you can configure validation of certain parameters to occur only if the device has reported a new firmware version. This check eliminates the need to validate parameters whose values change only with a firmware upgrade.

For example, the device model name does not change without a firmware upgrade; thus, you do not need to check this parameter on the device unless the firmware has been upgraded.

Cisco BAC ships with a default configuration for data discovery. You can augment this default configuration in two ways:

- Add parameters to a custom list.
- Change the default list. This option, however, is not recommended.

### Configuring Parameters Checked on Every Contact

You can configure the default list of parameters discovered everytime the device connects with the DPE by using the `ServerDefaultsKeys.CWMP_DISCOVER_PARAMETERS` property. You can add more parameters to the default list by providing a comma-separated list of parameters as a value to the `IPDeviceKeys.CWMP_CUSTOM_DISCOVER_PARAMETERS` property.

The default list includes:

- Inform.DeviceId.Manufacturer
- Inform.DeviceId.ManufacturerOUI
- Inform.DeviceId.ProductClass
- InternetGatewayDevice.DeviceInfo.HardwareVersion
- InternetGatewayDevice.DeviceInfo.SoftwareVersion
- InternetGatewayDevice.ManagementServer.ParameterKey

For example:

```
IPDeviceKeys.CWMP_CUSTOM_DISCOVER_PARAMETERS= InternetGatewayDevice.ManagementServer.URL,
InternetGatewayDevice.ManagementServer.PeriodicInformEnable
```

### Configuring Parameters Checked on Firmware Upgrade

You can configure the default list of parameters discovered after every firmware upgrade by using the `ServerDefaultsKeys.CWMP_FIRMWARE_CHANGED_CPE_PARAMETERS` property. This default list includes the `InternetGatewayDevice.DeviceInfo.ModelName` parameter.

To customize this list to include more parameters, use the `IPDeviceKeys.CWMP_CUSTOM_FIRMWARE_CHANGED_PARAMETERS` property.

### Troubleshooting Data Discovery

You can also troubleshoot data discovery from the DPE CLI by using any of the tasks described in [Table 12-2](#).

**Table 12-2** Troubleshooting Discovery of Data from DPE

Task	Use ...	Description
Enable info-level logging	dpe# <b>log level 6-info</b>	Displays information messages

Table 12-2 Troubleshooting Discovery of Data from DPE (continued)

Task	Use ...	Description
View device log	<pre>dpe# show log</pre> <pre>dpe# show log last 100</pre> <pre>dpe# show log run</pre> <p><b>Note</b> You can use any of the three listed commands.</p>	<p>Displays recent DPE log entries.</p> <p>Displays the last 100 lines of the DPE log.</p> <p>Displays the running DPE log.</p>
<p><b>Example</b></p> <p>The output of the <b>show log run</b> command has been shortened for demonstration purposes.</p> <pre>dpe# show log run</pre> <p>% Press &lt;enter&gt; to stop.</p> <pre>2006 08 04 00:47:01 EDT: %BAC-DPE-6-0104: Obtained configuration for device [0014BF-CJJ005B00009] from RDU.</pre> <pre>2006 08 04 00:47:21 EDT: %BAC-CWMP-6-5129: Device [0014BF-CJJ005B00009]. Source IP [10.86.147.149]. Retrieving [1] discovered CPE parameters.</pre> <pre>2006 08 04 00:47:21 EDT: %BAC-CWMP-6-5107: Device [0014BF-CJJ005B00009]. Source IP [10.86.147.149]. Sent [GetParameterValues] message.</pre> <pre>2006 08 04 00:47:21 EDT: %BAC-CWMP-6-5106: Device [0014BF-CJJ005B00009]. Source IP [10.86.147.149]. Received [GetParameterValuesResponse] message.</pre> <pre>2006 08 04 00:47:21 EDT: %BAC-CWMP-6-5120: Device [0014BF-CJJ005B00009]. Source IP [10.86.147.149]. New data discovered from CPE. Queued update of [7] parameters to RDU.</pre> <p><b>Note</b> Discovery of data is successful if the output of the <b>show log</b> commands is similar to the sample output featured here.</p>		

**Table 12-2 Troubleshooting Discovery of Data from DPE (continued)**

Task	Use ...	Description
Enable debugging	<pre>dpe# debug on</pre> <pre>dpe# debug service cwmp num data-sync</pre> <p><i>num</i>—Specifies the instance of the CWMP service, which could be 1 or 2.</p>	Enables debug logging of the data synchronization process for the CWMP service
View data discovery configuration for a specific device	<pre>dpe# show device-config device-id</pre> <p><i>device-id</i>—Specifies the ID of the device.</p>	Displays the device configuration cached at the DPE.

For specific information on using these commands, see the [Cisco Broadband Access Center 3.8 DPE CLI Reference](#).

**Note**

You can use the provisioning API to execute many of the operations that are possible from the administrator user interface.

## Automatic IMEI Update

Cisco BAC now provides the capability to discover the International Mobile Equipment Identity (IMEI) number that is unique to every device.

After the IMEI is discovered, it is stored on Hostname field in the device record in the RDU and is used as the secondary Device ID. In the Admin GUI, the Hostname field is available in the Device Details page. The auto-discover IMEI feature functions in the same way for both known and unknown devices.

To enable IMEI update:

- 
- Step 1** Configure BAC property `/IPDevice/custom/discover/parameters` with CPE IMEI parameter name.
  - Step 2** Configure BAC IMEI update property `/IPDevice/secondary-deviceID/cpe-param`, also called as Secondary Device ID CPE Parameter field with CPE IMEI parameter name.  
 You can set the IMEI update property `/IPDevice/secondary-deviceID/cpe-param` property in Cisco BAC property hierarchy through Class of Service page. This property is listed under the **Property Name** drop-down list.
  - Step 3** Configure BAC property `/IPDevice/properties/available/pg` with BAC IMEI update property name `/IPDevice/secondary-deviceID/cpe-param`.
- 

To disable IMEI update, Configure BAC IMEI update the `/IPDevice/secondary-deviceID/cpe-param` property with value set to empty string or **NOT\_SUPPORTED**. This disables IMEI update on hostname field.

# Provisioning Group Scalability and Failover

This section describes the scalability and failover features provided in this release of Cisco BAC.

Cisco BAC's scalability and failover provide a high degree of availability to suit networks of virtually any size, even those with millions of devices deployed. The product also provides such critical features as DPE redundancy and failover protection.

Scalability in a Cisco BAC deployment is accomplished through provisioning groups, each of which is a cluster of redundant DPE servers that communicate with a set of CPE. Provisioning groups enhance the scalability of the Cisco BAC network by making each provisioning group responsible only for a subset of devices.

This partitioning of devices can be along regional groupings or any other policy defined by the service provider.

To scale a deployment, the administrator can:

- Upgrade existing DPE server hardware.
- Add DPE servers to a provisioning group.
- Add provisioning groups and redistribute devices among them.

Cisco BAC supports explicit assignment and automatic membership of devices to provisioning groups. For more information, see [CPE Management Overview, page 4-1](#).

## Redundancy in Cisco BAC

Redundancy helps to ensure:

- High availability for your network applications.
- Users do not experience long network delays or black holes due to a single point of failure.

Cisco BAC supports local as well as regional server redundancy.

### Local Redundancy

The Cisco BAC provisioning group is a cluster of redundant DPE servers that communicate with a set of devices. A single URL identifies each provisioning group.

You can configure local redundancy by using any software or hardware that provides load-balancing features, such as the Cisco Application Control Engine (ACE) 4710.

### Regional Redundancy

Regional redundancy ensures that DPEs in a different location temporarily process CPE requests in case of regional failure. The simplest way of facilitating this deployment is to set up DPEs within a provisioning group in different geographic locations. In such a setup, CPE requests are serviced by DPEs located in different regions, providing regional failover within the confines of the provisioning group.

In some deployments, however, you may require that CPE requests be processed by servers in one location and fail over to DPEs in another location only in case of failure. In such a scenario, you can also locate DPEs for a provisioning group in different regions yet configure the network such that, under normal conditions, CPE requests are directed only to a subset of the DPEs in a particular region.

Typically, you can configure regional redundancy by using DNS techniques. To configure the network for regional redundancy, ensure that the Cisco BAC hostname of a given provisioning name normally resolves to IP address(es) representing one set of DPEs.

However, when none of the DPE servers in that set responds to keepalives, such as ICMP, HTTP GET, or a TCP handshake, the DNS server should resolve the Cisco BAC hostname to the IP address(es) of the DPEs from a second set. CPE requests are then directed to a different set of DPEs.

Since DPEs in both sets belong to the same provisioning group, the new DPEs are ready to respond to requests. Subsequent DNS lookup requests fall back to the primary set of DPEs as soon as they become available.

## DPE Load-Balancing

Cisco BAC supports the following mechanisms for DPE redundancy and load-balancing:

- [Using DNS Round Robin, page 12-17](#)
- [Using a Hardware Load Balancer, page 12-17](#)

### Using DNS Round Robin

In using the DNS round-robin mechanism, the DNS server shuffles the list of DPE IPs when resolving the autoconfiguration server (ACS) hostname for the device. The device then takes the first IP address in the list as the ACS hostname.

This option is not recommended if the service provider does not control DNS caching servers. Also, DNS round-robinning performs less than ideally in a power outage scenario, when a large number of devices may receive the same order IP address cached by the DNS server, thus impacting performance. To work around this issue, Cisco recommends configuring a very short TTL of 1 second on the DNS server.

### Using a Hardware Load Balancer

When a hardware load balancer is used, the ACS URL contains the IP address or is resolved by the DNS server to a single IP address. All DPEs for a provisioning group are hidden behind a single virtual IP address of the hardware load balancer, such as Cisco ACE 4710.

The ACE provides load balancing and SSL/TLS acceleration for TR-069 traffic between the CWMP devices and the DPEs. You can configure the ACE to translate its virtual IP address to a specific DPE IP address, based on a load-balancing algorithm. ACE performs a series of checks and calculations to determine the DPE that can best service each device request according to the load-balancing algorithm.

ACE also provides stickiness that allows the same device to maintain multiple simultaneous or subsequent connections with the same DPE for the duration of a session.

A redundant pair of load balancers can improve redundancy and may service more than one provisioning group.

## Adding DPE to a Provisioning Group

This section describes how to add a DPE to a new provisioning group. In adding a DPE to a provisioning group, there are three possible options:

- Adding a DPE to a provisioning group
- Add a DPE to a provisioning group in a deployment that uses a hardware load balancer, such as Cisco ACE 4710, between the device and the DPE. In this case, you must update the load balancer.
- Adding a DPE to a provisioning group in a deployment in which a DNS server, using round robin, resolves to multiple DPEs for a provisioning group.

To add a DPE to a provisioning group:

---

**Step 1** Configure the DPE from the DPE CLI. Among the configurations you must perform are:

- Specifying the provisioning group to which the DPE must belong. Enter:

```
dpe# dpe provisioning-group primary name
```

- *name*—Identifies the assigned primary provisioning group.

- Specifying the RDU to which the DPE connects. Enter:

```
dpe# dpe rdu-server {host | ip} port
```

- *host*—Identifies the FQDN of the host on which the RDU is running.
- *ip*—Identifies the IP address of the RDU.
- *port*—Identifies the port number on which RDU is listening for DPE connections. By default, this port number is 49187.

- Configuring the FQDN for a specific interface. The provisioning FQDN is the FQDN that is given to a device to contact the specific DPE interface. Enter:

```
dpe# interface ethernet {intf0 | intf1} provisioning fqdn fqdn
```

- *intf0 | intf1*—Identifies the Ethernet interface.
- *fqdn*—Identifies the FQDN that is set on the specified interface.

You must use the same FQDN for all DPEs in a given provisioning group. If DPEs are located behind the load balancer, use the FQDN of the load balancer as the interface FQDN, and ensure that it is the same for all DPEs which are part of the same load-balancing group.

You must also configure the CWMP service and the HTTP file service on one DPE to match the configurations on other DPEs.

For more information on configuration options, see the [Cisco Broadband Access Center 3.8 DPE CLI Reference](#). Also, see [Configuration Workflows and Checklists, page 3-1](#).

**Step 2** Start the DPE by using the **dpe start** command, and allow the DPE to synchronize and populate device configuration instructions from the RDU.

**Step 3** Optionally, if you are using a load balancer, add the DPE address to the load balancer.

**Step 4** Optionally, if you are using the DNS round robin technique, add the DPE address to the DNS server.

---





## CHAPTER 13

# Configuring CWMP Service Security

---

This chapter describes security options for Cisco Broadband Access Center's (BAC) CWMP services, including authentication and encryption. It describes how to enable HTTP over SSL transport, called SSL in this chapter, for the CWMP services and the HTTP file services on the DPE, and use the certificate-management tool to create a certificate store on the DPE.

This chapter includes the following sections:

- [Overview, page 13-1](#)
- [Key and Certificate Management in Cisco BAC, page 13-2](#)
- [Configuring SSL Service, page 13-3](#)
- [Configuring Security for DPE Services, page 13-11](#)
- [Configuring Security for RDU Services, page 13-18](#)
- [Signed Configuration for Devices, page 13-20](#)

## Overview

Cisco BAC supports secure provisioning of CWMP devices by using SSL, specifically SSL 3.0 and TLS 1.0, as defined in RFC 2246. It supports device authentication based on shared secrets with the DPE by using Basic and Digest authentication as defined in RFC 2617.

Cisco BAC provides multiple services at the DPE: two instances of the CWMP service and two instances of the HTTP file service. You enable and configure each service independently, with different security options providing the flexibility of handling various devices differently on the same DPE.

Cisco BAC also provides secure device authentication by using unique or generic client certificates.

- **Generic**—Enables device certificate authentication through SSL by using a generic certificate that is common to all customer premises equipment (CPE) or a large subset of CPE. For example, all VoIP devices in a given deployment may have the same generic certificate that the service provider issues.

The client certificate is validated against a signing authority key, but does not establish identity of a given device. The device identifier is formed by using the data provided using HTTP Basic or Digest authentication; or by using the data in the CWMP Inform message.

- **Unique**—Enables client certificate authentication through SSL by using the unique certificate that each device provides. After the client certificate is validated by using the signing certificate authority's public key, the device's unique identifier is formed by using the CN field of the client certificate.

Cisco BAC supports a unique option of performing client-certificate authentication at a hardware load balancer and SSL accelerator such as Cisco ACE 4710.

In this scenario, the ACE performs certificate validation, extracts information about the SSL session, specifically client certificate fields, from the device certificate, and inserts that data into special HTTP headers. Cisco BAC then retrieves the CN field from the ACE header ClientCert-Subject-CN to form the unique device identifier.

Cisco BAC allows a mix of authentication options. For example, you can validate that the device has a generic certificate by using SSL and then perform additional HTTP Basic or Digest authentication once SSL connection is established.

Cisco BAC also provides an option of no-device authentication. This option is useful if the device is authenticated downstream from the DPE and the identity that the device presents can be trusted. If the Cisco BAC DPE is configured to perform no-authentication, it extracts the device identity from the Inform message and trusts it.

You can encrypt traffic between the device and a DPE by using SSL. Cisco BAC supports a variety of cipher suites, which determine the encryption algorithms to be used with the device and the encryption key length. You can configure acceptable cipher suites on the DPE by using the CLI. Another option is to terminate SSL at a hardware load balancer and accelerator for higher scalability.

**Note**

Use the DPE CLI to configure security options for the CWMP service and the HTTP file service. For configuration instructions, see the [Cisco Broadband Access Center 3.8 DPE CLI Reference](#).

## Key and Certificate Management in Cisco BAC

The DPE stores the certificates that the SSL protocol requires for authentication in the keystore. This keystore is a database in the form of a file that contains private keys and their associated public key X.509 certificates.

There are two keystores on the DPE server. The keystores are the cacerts keystore and the server certificates keystore.

- The cacerts keystore contains public key certificates that the DPE trusts for authenticating devices' client certificates.
- The server certificates keystore contains the private key and the associated certificate chain for the server-side certificate, which is used to authenticate the DPE to the devices.

All DPE SSL services share a single cacerts keystore. This keystore can contain any number of signing authority certificates. The name of the cacerts keystore is fixed, and it must always reside in BPR\_HOME/jre/lib/security directory. Cisco BAC ships with a default cacerts keystore, which can be manipulated by adding and removing signing authority certificates.

In contrast to the cacerts keystore, there can be multiple server certificate keystores and you can configure each SSL service in the DPE to use a different server certificate keystore. Each server certificate keystore should contain only one certificate chain. The server certificate keystores must reside in the BPR\_HOME/dpe/conf directory.

If SSL is being terminated on the DPEs, and the provisioning group contains multiple DPEs, then all the DPEs must be configured with an identical keystore. An identical keystore is required since the same fully qualified domain name (FQDN) URL of the autoconfiguration server (ACS) is used to resolve to all DPEs in the provisioning group.

As defined in the TR-069 specification, the ACS URL must be identical to the Common Name (CN) value of the server certificate, which is imported into the keystore.

The DPE ships with a default sample server certificates keystore, called `servercerts`, which contains a self-signed server certificate.

However, because a CWMP device does not normally trust self-signed certificates, you cannot use the sample keystore to enable SSL for device provisioning. Instead, you must obtain a signed ACS certificate with private key and use it to create a new server certificate keystore (see [Configuring DPE Keystore by Using the Keytool](#), page 13-3). You can use the default keystore to test the SSL service link before acquiring and configuring an ACS certificate.

## Configuring SSL Service

To enable SSL on Cisco BAC:

- 
- Step 1** Create a server certificate keystore, which contains the private key and the associated ACS public key certificate. This process also requires updating the `cacerts` keystore to load the public certificate of the signing authority for the server certificate.
  - Step 2** Optionally, if you would like to configure CPE authentication to use client certificates, update the `cacerts` keystore with the public key of the CPE certificate authority root certificate, which can validate CPE certificates. For details, see [Configuring DPE Keystore by Using the Keytool](#), page 13-3.
  - Step 3** Configure the DPE to use the new server certificate keystore from the DPE CLI. For details, see [Configuring Security for DPE Services](#), page 13-11.
  - Step 4** Enable SSL transport for the CWMP service or the HTTP file service by using the DPE CLI. For more details, see [Configuring Security for DPE Services](#), page 13-11.



---

**Note** To ensure that the changes you make to the keystore take effect, you must restart the DPE by using the `dpe reload` command from the CLI, or the `/etc/init.d/bprAgent restart dpe` command from the watchdog agent command line (see [Using Cisco BAC Process Watchdog from the Command Line](#), page 9-2).

---

## Configuring DPE Keystore by Using the Keytool

You use Cisco BAC to configure the server certificate keystore and the `cacerts` keystore by using the `keytool` utility. The `keytool` is a key and certificate-management utility, which you use to administer the certificates on the DPE server.

The `keytool` utility resides in the Cisco BAC default installation directory, at `/opt/CSCObac/jre/bin/keytool`. Run the `keytool` utility by using a secure connection to the DPE server.



---

**Note** You must execute the `keytool` utility bundled with this Cisco BAC version, because the keystore file format varies between `keytool` releases.

---

To configure a server certificate:

- 
- Step 1** Create a new server keystore with a new private key by using `keytool`. See [Generating Server Certificate Keystore and Private Key for a New Certificate](#), page 13-6, for details.
  - Step 2** Generate a certificate-signing request (CSR). See [Generating a Certificate-Signing Request](#), page 13-7, for details.
  - Step 3** Request a public certificate from the signing authority by using CSR. See [Generating a Certificate-Signing Request](#), page 13-7, for details.
  - Step 4** Load the public key of the signing authority into the `cacerts` keystore. See [Importing Signing Authority Certificate into Cacerts Keystore](#), page 13-8, for details.
  - Step 5** Load the signed server certificate into the server keystore. See [Importing the Signed Certificate into Server Certificate Keystore](#), page 13-9, for details.
  - Step 6** Put the new keystore file in the `DPE BPR_HOME/dpe/conf` directory.
  - Step 7** At the CLI, configure one of the DPE services to use the new keystore. See [Configuring SSL Service](#), page 13-3, for details.
  - Step 8** Restart the DPE by using the `dpe reload` command from the CLI, or the `/etc/init.d/bprAgent restart dpe` command from the watchdog agent command line (see [Using Cisco BAC Process Watchdog from the Command Line](#), page 9-2).
- 



**Note**

To enable the use of client certificates for device authentication, ensure that the public certificate of the signing authority for device certificates is loaded into the `cacerts` keystore. Follow the procedure described in [Importing Signing Authority Certificate into Cacerts Keystore](#), page 13-8, for details.

---

#### Importing an Existing Signed Server Certificate

If you already have the signed server certificate and you want to load it into the keystore, you must know the private key that is associated with the certificate. In this case, instead of following the procedure described above, follow the steps outlined in this section. Use the PKCS#12 file format, which combines both the private key and the signed certificate. You can load this file into a keystore by using the `keystore import-pkcs12` command.

To configure a server certificate with an existing signed server certificate:

- 
- Step 1** Load the existing private key and certificates into a DPE-compatible file, used in authenticating the DPE to SSL clients, by using the `keystore import-pkcs12` command.

When using this command, the syntax is:

```
keystore import-pkcs12 keystore-filename pkcs12-filename keystore-password key-password
export-password export-key-password
```

- *keystore-filename*—Identifies the keystore file to create. If it already exists, it will be overwritten.



**Note**

Remember to specify the full path of the keystore file.

---

- *pkcs12-filename*—Identifies the PKCS#12 file from which you intend to import the key and certificate.

- *keystore-password*—Identifies the private key password and the keystore password that you used when you created your keystore file. This password must be between 6 and 30 characters.
- *key-password*—Identifies the password used to access keys within DPE keystore. This password must be between 6 and 30 characters.
- *export-password*—Identifies the password used to decrypt the key in the PKCS#12 file. The export password must be between 6 and 30 characters.
- *export-key-password*—Identifies the password used to access keys within the PKCS#12 keystore. This password must be between 6 and 30 characters.

For example:

```
dpe# keystore import-pkcs12 example.keystore example.pkcs12 changeme changeme changeme
changeme
% Reading alias [1]

% Reading alias [1]: key with format [PKCS8] algorithm [RSA]

% Reading alias [1]: cert type [X.509]

% Created JKS keystore: example.keystore

% OK
```

- Step 2** Copy the new keystore file into the DPE *BPR\_HOME/dpe/conf* directory.
- Step 3** At the CLI, configure one of the DPE services to use the new keystore. See [Configuring SSL Service, page 13-3](#), for details.
- Step 4** Restart the DPE by using the **dpe reload** command from the CLI, or the **/etc/init.d/bprAgent restart dpe** command from the watchdog agent command line (see [Using Cisco BAC Process Watchdog from the Command Line, page 9-2](#)).

## Using the Keytool Commands

The keytool utility uses command arguments to configure a DPE keystore. [Table 13-1](#) lists the keytool commands and their descriptions.

**Table 13-1 Keytool Commands**

<b>-alias</b> <i>alias</i>	Identifies the identity assigned to a keystore entry, which stores the certificate chain and the private key. Subsequent keytool commands must use the same alias to refer to the entity.
<b>-dname</b> <i>dname</i>	Identifies the X.500 Distinguished Names used to identify entities, such as those that the subject and the issuer named.
<b>-file</b> <i>csr_file</i>	Identifies the CSR file to be exported.
<b>-file</b> <i>cert_file</i>	Identifies the file from which the certificate is to be read.
<b>-keyalg</b> <i>keyalg</i>	Identifies the algorithm to be used for key-pair creation. The values are DSA (default) and RSA.
<b>-keysize</b> <i>keysize</i>	Specifies a keysize, whose values must be in multiples of 64 bits.
<b>-keypass</b> <i>keypass</i>	Identifies the password assigned to a key pair.
<b>-keystore</b> <i>keystore</i>	Customizes the name and location of a keystore.

**Table 13-1** Keytool Commands (continued)

<b>-noprompt</b>	Specifies that no prompts are to be issued during an import operation.
<b>-provider</b> <i>provider_class_name</i>	Identifies the name of the cryptographic service provider's master class file when the service provider is not listed in the security properties file.
<b>-rfc</b>	Specifies that the output of the MD5 fingerprint of a certificate, which appears in printable-encoding format.
<b>-storepass</b> <i>storepass</i>	Identifies the password assigned to a keystore.
<b>-sigalg</b> <i>sigalg</i>	Specifies the algorithm to be used to sign the certificate.
<b>-storetype</b> <i>storetype</i>	Identifies the type assigned to a keystore or an entry into a keystore.
<b>-trustcacerts</b>	Specifies that additional certificates are considered for the chain of trust.
<b>-v</b>	Specifies that the output of the MD5 fingerprint of a certificate is printed in human-readable format.
<b>-validity</b> <i>valDays</i>	Identifies an expiration period. The default is 90 days.

**Note**

For additional information on keytool and general certificate-management concepts, refer to Sun Microsystems documentation.

## Generating Server Certificate Keystore and Private Key for a New Certificate

The **keytool -genkey** command generates a key pair (a public key and an associated private key), and wraps the public key into an X.509 self-signed certificate, which is stored as a single-element certificate chain. This certificate chain and the private key are stored in a new keystore entry identified by alias.

**Note**

The name that you use for the alias is insignificant. Its purpose is to identify a key pair within the keystore if you had multiple key pairs. In the context of Cisco BAC, you should have only one key pair in the server certificate keystore, but you can have multiple keystores.

### Example 13-1 Keytool -genkey

The following example uses *train-1.keystore* as the name of the keystore file. You can use any file name, but using *servercerts* is not recommended because this conflicts with the sample keystore that Cisco BAC provides.

```
dpe# ./keytool -keystore train-1.keystore -alias train-1 -genkey -keyalg RSA
Enter keystore password: changeme
What is your first and last name?
[Unknown]: train-1.bac.test
What is the name of your organizational unit?
[Unknown]: BAC Training
What is the name of your organization?
[Unknown]: Acme Device, Inc.
What is the name of your City or Locality?
[Unknown]: Boxborough
What is the name of your State or Province?
```

```

[Unknown]: MA
What is the two-letter country code for this unit?
[Unknown]: US
Is CN=train-1.bac.test, OU=BAC Training, O="Acme Device, Inc.", L=Boxborough, ST=MA, C=US
correct?
[no]: yes

Enter key password for <train-1>
(RETURN if same as keystore password):

```

In this example, *train-1.bac.test* goes into the CN field of the certificate and represents the FQDN that the ACS URL contains. According to the TR-069 specification, the device validates the certificate signature and ensures that the CN field in the certificate matches that of the URL it contacts.

## Displaying Self-Signed Certificate

The **keytool -list** argument displays the contents of the keystore entry identified by alias. If you do not specify an alias, the entire contents of the keystore appear.

If you combine **-list** with **-v**, the certificate chain associated with the alias appears. The following **keytool -list** sample output displays the keystore containing a single self-signed certificate.

### Example 13-2 Keytool -list

```

# ./keytool -keystore train-1.keystore -list -v
Enter keystore password: changeme

Keystore type: jks
Keystore provider: SUN

Your keystore contains 1 entry

Alias name: train-1
Creation date: Nov 8, 2005
Entry type: keyEntry
Certificate chain length: 1
Certificate[1]:
Owner: CN=train-1.bac.test, OU=BAC Training, O="Acme Device, Inc.", L=Boxborough, ST=MA,
C=US
Issuer: CN=train-1.bac.test, OU=BAC Training, O="Acme Device, Inc.", L=Boxborough, ST=MA,
C=US
Serial number: 43714f22
Valid from: Tue Nov 08 20:21:38 EST 2005 until: Mon Feb 06 20:21:38 EST 2006
Certificate fingerprints:
    MD5: CF:D4:CB:D1:20:6F:8C:12:ED:EA:2F:21:53:57:E5:1D
    SHA1: DD:AE:96:02:71:55:F8:1F:14:4F:D7:64:9C:FE:91:DE:65:C9:BB:49

```

## Generating a Certificate-Signing Request

At this point in the procedure, the keystore contains a private key and a X.509 self-signed certificate. If the DPE ACS tries to respond with this certificate to a device's initial handshake, the device will reject the certificate with a TLS alert *bad CA*, indicating that the certificate authority that the CPE trusted did not sign the certificate. Therefore, the signing authority that the CPE trusts must sign the certificate.



### Note

To support SSL, the device must have a list of preconfigured public certificates of signing authorities that it trusts. One of the authorities that the device trusts must sign the ACS certificate.

The **keytool -certreq** command parameter generates a certificate-signing request (CSR). This command generates the CRS in the industry standard PKCS#10 format.

### Example 13-3 Keytool -certreq

The following example uses a keystore with a preexisting self-signed certificate under **alias** *train-1* to generate a certificate-signing request and output the request into the *train-1.csr* file.

```
dpe# ./keytool -keystore train-1.keystore -alias train-1 -certreq -file train-1.csr
Enter keystore password: changeme
```

The next step is to submit the CSR file to your signing authority. Your signing authority or your administrator, who is in possession of the private key for the signing authority, will generate a signed certificate based on this request. From the administrator, you must also obtain the public certificate of the signing authority.

### Verifying the Signed Certificate

After you have received the signed certificate, use the **keytool -printcert** command to verify if the self-signed certificate is in the correct file format and uses the correct owner and issuer fields. The command reads the certificate from the **-file cert\_file** parameter, and prints its contents in a human-readable format.

### Example 13-4 Keytool -printcert

The *train-1.crt* file in this example identifies the signed certificate that the administrator provides.

```
dpe# ./keytool -printcert -file train-1.crt
Owner: CN=train-1.bac.test, OU=BAC Training, O="Acme Device, Inc.", ST=MA, C=US
Issuer: EMAILADDRESS=linksys-certadmin@cisco.com, CN=Acme Device Provisioning Root
Authority 1, OU=Acme Device Certificate Authority, O="Acme Device, Inc.", L=Irvine,
ST=California, C=US
Serial number: 1
Valid from: Tue Nov 08 12:40:28 EST 2005 until: Thu Nov 08 12:40:28 EST 2007
Certificate fingerprints:
    MD5: 25:8E:98:C5:5C:23:5C:A0:4D:51:CF:2A:AA:2A:FC:42
    SHA1: 05:C1:2D:C6:94:78:D1:40:88:6A:55:67:43:27:68:D3:AC:43:C6:A5
```



#### Note

The keytool can print X.509 v1, v2, and v3 certificates, and PKCS#7-formatted certificate chains comprising certificates of that type. The data to be printed must be provided in binary-encoding format, or in printable-encoding format (also known as Base64 encoding) as defined by the RFC 1421.

## Importing Signing Authority Certificate into Cacerts Keystore

Before importing the certificate into the server certificate keystore, you must import the public certificate of the signing authority into the cacerts keystore; because when a certificate is being imported into the keystore, the keytool checks if a chain of trust can be established between the certificate and its signing authority. If a chain of trust cannot be established, an error message appears.



**Note**

The cacerts file bundled with Cisco BAC ships with several root certificate common third-party signing authorities. You can manage the cacerts keystore by using the keytool utility. The default cacerts keystore password is **changeit**. The cacerts database file resides in the *BPR\_HOME/jre/lib/security* directory. The cacerts keystore does not need to be copied anywhere. The DPE will use the new keystore as soon as it is restarted.

**Example 13-5 Keytool -import Signing Authority Certificate**

```
# ./keytool -import -alias DeviceProvRoot -file rootCA4.crt -keystore
/opt/CSCObac/jre/lib/security/cacerts
Enter keystore password: changeit
Owner: EMAILADDRESS=linksys-certadmin@cisco.com, CN=Acme Device Provisioning Root
Authority 1, OU=Acme Device Certificate Authority, O="Acme Device, Inc.", L=Irvine,
ST=California, C=US
Issuer: EMAILADDRESS=linksys-certadmin@cisco.com, CN=Acme Device Provisioning Root
Authority 1, OU=Acme Device Certificate Authority, O="Acme Device, Inc.", L=Irvine,
ST=California, C=US
Serial number: 8bcbc07a0768c1eb78e6c5c93c0c2ff0
Valid from: Fri Jul 01 21:22:12 EDT 2005 until: Mon Jun 29 21:22:12 EDT 2015
Certificate fingerprints:
    MD5: C4:D4:09:6A:60:34:A0:00:96:4F:4D:47:23:86:8C:FA
    SHA1: B0:CC:6D:CD:BB:62:1B:A1:15:D3:2D:68:7E:D0:4A:0C:91:C2:A5:FD
Trust this certificate? [no]: yes
Certificate was added to keystore.
```

**Note**

The keytool can import X.509 v1, v2, and v3 certificates, and PKCS#7-formatted certificate chains comprising certificates of that type. The data to be imported must be provided in binary-encoding format, or in printable-encoding format (also known as Base64 encoding) as defined by the RFC 1421.

## Importing the Signed Certificate into Server Certificate Keystore

Once you import the public certificate of the signing authority into the cacerts keystore, you must import the signed server certificate into the DPE server certificate keystore. You will already have a keystore with private key and corresponding self-signed certificate (public key).

By importing the certificate reply (signed certificate), the keystore is modified to associate the signed certificate with the existing private key in the server certificate keystore.

When importing the certificate reply into the keystore, you must use the **-trustcacerts** flag with the **-import** command for certificates in the *cacerts* file to be used to establish chains of trust with the certificate reply in the subject's keystore.

**Example 13-6 Keytool -import (Signed Server Certificate)**

```
dpe# ./keytool -import -trustcacerts -file train-1.crt -keystore train-1.keystore -alias
train-1
Enter key password: changeme2
Enter keystore password: changeme
Certificate reply was installed in keystore.
Certificate was added to keystore.
```

After you import the signed server certificate into the DPE server certificate keystore, use the keytool **-printcert** command to verify the keystore contents, as outlined in [Verifying the Signed Certificate, page 13-8](#). The **-printcert** output should now show the issuer to be the signing certificate authority, and that a chain of trust has been established using the signing authority with the root trusted certificate.

## Importing Certificates for Client Authentication

This step is required only if you have configured client authentication by using client certificates on the DPE. If you have enabled client authentication by using client certificates, the cacerts keystore must contain the public certificate of the signing authority that signed the CPE client certificates. This certificate must be present to enable the DPE to validate certificates presented to it.

### Example 13-7 Keytool -import (Signing Authority Certificate)

```
# ./keytool -import -alias DeviceClientRoot -file rootCA3.crt -keystore
/opt/CSCObac/jre/lib/security/cacerts
Enter keystore password: changeit
Owner: EMAILADDRESS=linksys-certadmin@cisco.com, CN=Acme Device Client Root Authority 1,
OU=Acme Device Certificate Authority, O=Acme Device LLC., L=Irvine, ST=California, C=US
Issuer: EMAILADDRESS=linksys-certadmin@cisco.com, CN=Acme Device Client Root Authority 1,
OU=Acme Device Certificate Authority, O=Acme Device LLC., L=Irvine, ST=California, C=US
Serial number: d07d8a7badba7cb6446998b1ea89879f
Valid from: Fri Jul 01 21:19:50 EDT 2005 until: Mon Jun 29 21:19:50 EDT 2015
Certificate fingerprints:
    MD5: 40:B0:40:49:37:3A:51:1F:0D:78:B6:B3:E2:2C:1A:E8
    SHA1: 96:F5:84:71:84:CC:0A:A2:1E:7B:44:A2:B6:F5:B7:3D:C4:9F:81:3B
Trust this certificate? [no]: yes
Certificate was added to keystore
```



#### Note

This procedure is exactly the same as the one described in [Importing Signing Authority Certificate into Cacerts Keystore, page 13-8](#). In both cases, you are loading the public certificate of the signing authority. If the signing authority of the server certificates is the same as the signing authority for the device certificates, you must add the certificate only once.

### Providing the DPE with the service-provider keystore

Once you have a new service certificate keystore, which contains the signed public key certificate, you must move the keystore file to the DPE. The file must be moved to the `BPR_HOME/dpe/conf` directory.

### Example 13-8 Move Keystore to DPE Configuration Directory

```
# mv train-1.keystore /opt/CSCObac/dpe/conf
```

Once you complete this step, you can configure the DPE services to use the new keystore by using the DPE CLI.



#### Note

You do not need to copy the cacerts keystore anywhere. The DPE will use the new keystore as soon as it is restarted.

For more information, see [Configuring Security for DPE Services, page 13-11](#). For additional information on DPE configuration commands, see the [Cisco Broadband Access Center 3.8 DPE CLI Reference](#).

## Configuring Security for DPE Services

This section describes how to configure authentication options and configure SSL on the DPE services.

You can configure DPE security options from the DPE CLI. For more information, see the [Cisco Broadband Access Center 3.8 DPE CLI Reference](#).

The DPE supports running two CWMP and two HTTP file services concurrently. Each service can have a different configuration of security options and runs on a different port. By default, only one CWMP and one HTTP service are enabled, and they are configured without SSL. Two additional services are configured for SSL, but are disabled by default.

Table 13-2 specifies the defaults settings for each instance of the CWMP service and the HTTP file service:

**Table 13-2** Default Settings for CWMP Technology

	CWMP Service		HTTP File Service	
	Service 1	Service 2	File Service 1	File Service 2
<b>Default Mode</b>	Enabled	Disabled	Enabled	Disabled
<b>Authentication</b>	Digest	Digest	Digest	Digest
<b>Port Number</b>	7547	7548	7549	7550
<b>SSL Protocol</b>	Disabled	Enabled	Disabled	Enabled

## Configuring SSL on a DPE

To enable SSL on any given service:

- 
- Step 1** Configure HTTP client authentication. You can enable authentication in the Basic or Digest mode, or disable HTTP authentication.
  - Step 2** Enable the SSL protocol for the service.
  - Step 3** Configure the port through which the device contacts the service on the DPE.
  - Step 4** Set the keystore filename, keystore password, and key password.
  - Step 5** Configure client certificate authentication by using SSL. You can configure client authentication to use generic or unique client certificates.
  - Step 6** Optionally, disable other instances of the CWMP service or HTTP file service.
  - Step 7** Enable an instance of a service, which could be the CWMP service or the HTTP file service.
  - Step 8** Restart the DPE by using the **dpe reload** command to ensure that the changes take effect.
- 

## Enabling SSL for the CWMP Service

The following example describes the commands that you use to enable SSL for an instance of the CWMP service. In this example, double authentication is enabled for the SSL clients by using client certificates and HTTP authentication in Basic mode.

```
dpe# service cwmp 2 client-auth basic
```

```

% OK (Basic authentication was enabled. Digest authentication was disabled. Requires DPE
restart "> dpe reload")

dpe# service cwmp 2 port 7548
% OK (Requires DPE restart "> dpe reload")

dpe# service cwmp 2 ssl enable true
% OK (Requires DPE restart "> dpe reload")

dpe# service cwmp 2 ssl keystore train-1.keystore changeme changeme2
% OK (Requires DPE restart "> dpe reload")

dpe# service cwmp 2 ssl client-auth client-cert-unique
% OK (Requires DPE restart "> dpe reload")

dpe# service cwmp 1 enabled false
% OK (Requires DPE restart "> dpe reload")

dpe# service cwmp 2 enable true
% OK (Requires DPE restart "> dpe reload")

dpe# dpe reload
Process dpe has been restarted.

% OK

```



---

**Note** This example configures SSL transport on CWMP instance 2. The example assumes that the `train-1.keystore` is preloaded with the signed public key certificate for the server and that the keystore file was moved to the `BPR_HOME/dpe/conf` directory on the DPE.

---

## Enabling SSL for the HTTP File Service

The following example describes the commands that you use to enable the SSL protocol for an instance of the HTTP file service. In this example, client authentication is disabled; thus allowing access without an authentication challenge.

```

dpe# service http 2 client-auth none
% OK (Requires DPE restart "> dpe reload")

dpe# service http 2 port 7550
% OK (Requires DPE restart "> dpe reload")

dpe# service http 2 ssl enable true
% OK (Requires DPE restart "> dpe reload")

dpe# service http 2 ssl keystore train-1.keystore changeme changeme2
% OK (Requires DPE restart "> dpe reload")

dpe# service http 2 ssl client-auth none
% OK (Requires DPE restart "> dpe reload")

dpe# service http 1 enable false
% OK (Requires DPE restart "> dpe reload")

dpe# service http 2 enable true
% OK (Requires DPE restart "> dpe reload")

```

```
dpe# dpe reload
Process dpe has been restarted.
```

```
% OK
```

**Note**

For detailed information, see the [Cisco Broadband Access Center 3.8 DPE CLI Reference](#).

## Configuring CPE Authentication

CPE authentication is supported through:

- Shared secret by using HTTP Basic or Digest authentication.
- Client certificates by using SSL. You can use certificate-based client authentication in lieu of or in addition to shared secret HTTP-based authentication.
- External client certificate authentication. In this scenario, the SSL connection is terminated at the hardware load balancer, which also authenticates the client.

The objective of authentication is to establish a trusted device ID, which is used to look up device instructions in the DPE cache. This device ID correlates to the device identifier preprovisioned for the device record at the Cisco BAC RDU database. In case of shared secret HTTP-based authentication, the username serves to establish the identity of the device and is treated as a device ID.

In case of authentication using unique client certificates, the device ID is obtained from the device certificate's CN field. With client certificate authentication by an external entity (such as a Cisco ACE 4710 load balancer), the certificate data, including the CN field, is passed to the DPE in the HTTP headers.

You can also choose the option of having no client authentication if clients are trusted. For example, the clients can already be authenticated for network access based on the subscriber physical line. In this case, you can configure Cisco BAC with no-authentication and it will derive the trusted device ID from the Inform message.

You can configure CPE authentication options from the DPE CLI.

### Shared Secret Authentication

Cisco BAC supports HTTP authentication based on a shared password between the CPE and the DPE. This authentication is available in two modes: Basic and Digest.

**Note**

To limit security risks during client authentication, Cisco recommends using the Digest mode (the default configuration). You should not allow client authentication in the Basic mode.

To configure authentication in the Basic or Digest mode from the DPE CLI, use:

```
# service {cwmp | http} num client-auth mode
```

- *num*—Identifies an instance the service, which could be 1 or 2.
- *mode*—Identifies the client authentication mode for the service. The client authentication mode could be:
  - basic—Enables Basic HTTP authentication.
  - digest—Enables Digest HTTP authentication. This is the default configuration.
  - none—Disables Basic and Digest authentication.

For detailed information, see the [Cisco Broadband Access Center 3.8 DPE CLI Reference](#).

### Changing a Device Password

You can configure the shared secret for the device in Cisco BAC. The shared secret is stored on the device record by using the `IPDeviceKeys.CPE_PASSWORD` property. The CPE must prove knowledge of this password during HTTP-based authentication.

In the Basic mode, the password is transmitted as encoded clear text, while in the Digest mode, the device is allowed to prove knowledge of the password (shared secret) without transmitting it.

You can configure the password:

- On the API, using the property `IPDeviceKeys.CPE_PASSWORD`.
- On the administrator user interface, using the CPE Password field in the **Devices > Add Device** or **Modify Device** pages.



#### Note

You cannot change the CPE password if the DPE connection to the RDU is not available.

The CPE password is optional if you have enabled client authentication by using SSL and with client certificates.

A distinction should be drawn between changing the password used by Cisco BAC and the password used by the device. When you configure a password on the device record in Cisco BAC, the outcome differs depending on the previous value of the password.

If the password was already set on the device record, Cisco BAC changes it and initiates the process of changing the password on the actual device. However, if the prior password value on the device record did not exist (or was an empty string), Cisco BAC sets the new password on the device record, but does not initiate the change of password on the actual device.

Hence, if you wish to change the password from the existing value to another value only in Cisco BAC, you must first reset the value in Cisco BAC (set it to an empty string) and then set it to a new value.

[Figure 13-1](#) describes the process that Cisco BAC uses to change the password on the actual device. This process is complicated by the fact that Cisco BAC needs to use the old password to authenticate the device first, and then set the new password. Only after the password change is acknowledged can Cisco BAC forget the previous password and remove it from its database.

Figure 13-1 Change Password Flow

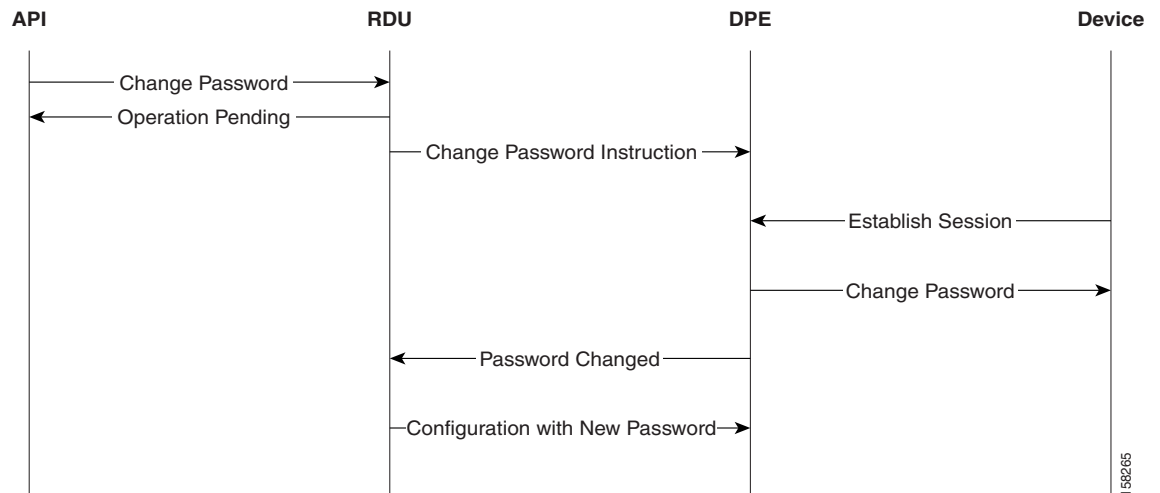

After the password is changed on the device object in the RDU, the change password instruction is included in the device configuration. At this point, the old password is still used to authenticate the device. The new configuration instruction is then forwarded to all the DPEs in the device's provisioning group.

When the device creates its next session with Cisco BAC, the device is authenticated with its old password; then, its new password is set using the SetParameterValues RPC. Once the DPE notifies the RDU of the change, the RDU changes the device password and generates a new configuration instruction, which includes the new password. Thereafter, the old password is no longer stored in Cisco BAC.

It is possible to change the new password up until it is set on the device. For example, if the original password of a device (*password*) has been changed to *newpassword*. But with the device yet to connect with Cisco BAC in order to set the new password, you can still change the password; for this purpose of this example, assume that the password is now changed to *n3wpa550d*.

The device continues to be authenticated with the old password (*password*) until the device connects to Cisco BAC. The new password (*n3wpa550d*) is set during the device's next session with Cisco BAC.

### Correcting a Device Password

You can also change an incorrectly spelled password, in the RDU. For example, if you entered *password* instead of *passwd*, first remove the password and then submit it. At this point, the device object does not have a password associated with it. Then, add the password on the device.



**Note** Use this method to change the password in Cisco BAC, but not the one on the device.

To correct a device password from the administrator user interface:

- Step 1** From **Devices > Manage Devices**, click the Identifier link corresponding to the correct device. The Modify Device page appears.
- Step 2** Delete the device password in the CPE Password field.
- Step 3** Click **Submit**.
- Step 4** Return to the **Modify Device** page and enter the correct password.

**Step 5** Click **Submit**.

The password is now changed on the device record in the RDU; no change of password on the actual device is initiated after this procedure.

---

## Client Certificate Authentication

You can configure the DPE to require a validated device-provided certificate for authentication. These certificates could be:

- **Generic**—Enables device certificate authentication through SSL by using a generic certificate common to all CPE or a large subset of CPE.
- **Unique**—Enables client certificate authentication through SSL by using the unique certificate that each CPE provides.

If the device certificates are unique, it is not necessary to use HTTP authentication. But if the same certificate is used for all devices (that is, a single device certificate that a service provider uses), you should configure an additional HTTP authentication.

To configure client certification authentication from the DPE CLI, use:

```
# service {cwmp | http} num ssl client-auth mode
```

- *num*—Identifies the instance of the service, which could be 1 or 2. By default, client certificate authentication with SSL is:
  - Disabled for service 1.
  - Disabled for service 2.
- *mode*—Identifies the mode of client certificate authentication. Cisco BAC supports:
  - *client-cert-generic*—Uses a certificate common to a set of devices.
  - *client-cert-unique*—Uses a certificate unique to a device.
  - *client-cert-ext*—Uses a load balancer, such as ACE, to validate the client certificate.
  - *none*—Disables client certificate authentication.

## External Client Certificate Authentication

An SSL connection can be terminated outside of the DPE, such as at a load balancer. In this case, the DPE may be configured without SSL service.

If a load balancer such as ACE, is used to terminate the SSL connections, the DPE does not receive the unique certificate, making it impossible to identify the device without HTTP authentication (Basic or Digest). To overcome this, the load balancer inserts additional HTTP headers that include the certificate information.

If a single session includes multiple TCP connections, each of the connections will be authenticated (if enabled). The session cookie binds the device to the existing session state.



## Authentication Options in Cisco BAC

This section provides a summary of possible combinations of client-authentication options available in Cisco BAC for the CWMP and the HTTP file services. You can configure each instance of these services separately from the DPE CLI to suit your requirements.

Cisco BAC supports HTTP authentication in the Basic and Digest modes based on a shared password between the CPE and the DPE. If HTTP-based authentication is used, Cisco recommends use of the Digest mode.

You can also configure CPE authentication by using certificates unique to each CPE. In this case, HTTP authentication is not necessary. However, if you configure CPE authentication using generic certificates that are common to all CPE or a large subset of CPE, it is recommended that you configure the DPE to require an additional HTTP authentication.

Table 13-3 lists the various options that Cisco BAC supports and the commands you use to configure authentication from the DPE CLI. For details on each command, see the [Cisco Broadband Access Center 3.8 DPE CLI Reference](#).

**Table 13-3 Authentication Options in Cisco BAC**

Option	Refer to ...
<b>Using HTTP</b>	
Enable device authentication by using HTTP in the Basic or Digest mode	<code>service { cwmp   http } num client-auth { basic   digest }</code>
Disable device authentication using HTTP	<code>service { cwmp   http } num client-auth none</code>
<b>Note</b> If device authentication using HTTP is disabled, trusted device identity is formed using the values in the Inform message from the device.	
<b>Using SSL</b>	
Enable device authentication in HTTP Basic or Digest mode over SSL connection but without client certificate authentication	<code>service { cwmp   http } num client-auth { basic   digest }</code> <code>service { cwmp   http } num ssl client-auth none</code>
Enable device authentication in HTTP Basic or Digest mode over SSL connection based on unique client certificates	<code>service { cwmp   http } num client-auth { basic   digest }</code> <code>service { cwmp   http } num ssl client-auth client-cert-unique</code>
<b>Note</b> When you configure the DPE to require HTTP-based (Basic or Digest) and authentication by using unique certificates, the device is authenticated by using both mechanisms. In this double authentication scenario, the device's unique identifier is formed by using the CN field of the client certificate; thus establishing trusted device ID.	
Enable device authentication in HTTP Basic or Digest mode over SSL connection based on generic client certificates	<code>service { cwmp   http } num client-auth { basic   digest }</code> <code>service { cwmp   http } num ssl client-auth client-cert-generic</code>

Table 13-3 Authentication Options in Cisco BAC (continued)

Option	Refer to ...
Enable device authentication by using HTTP Basic or Digest authentication and client certificate authentication by ACE	<code>service { cwmp   http } num client-auth { basic   digest }</code> <code>service { cwmp   http } num ssl client-auth client-cert-ext</code>
<b>Note</b> In this double authentication scenario, the trusted device ID is established based on authentication by ACE and communicated to the DPE using the HTTP headers.	
Enable device authentication based on client certificates validated by ACE	<code>service { cwmp   http } num ssl client-auth client-cert-ext</code>
Disable device authentication and client certificate authentication.	<code>service { cwmp   http } num client-auth none</code> <code>service { cwmp   http } num ssl client-auth none</code>
<b>Note</b> If device authentication and client-certificate authentication is disabled, devices are considered to be trusted or pre-authenticated, and the DPE uses data from the CWMP Inform message to establish trusted device identity.	
Disable HTTP-based device authentication and enable client authentication through SSL by using the unique certificate provided by each CPE	<code>service { cwmp   http } num client-auth none</code> <code>service { cwmp   http } num ssl client-auth client-cert-unique</code>
Disable HTTP-based device authentication and enable client authentication through SSL by using a generic certificate	<code>service { cwmp   http } num client-auth none</code> <code>service { cwmp   http } num ssl client-auth client-cert-generic</code>
<b>Note</b> If HTTP-based device authentication is disabled and client-certificate authentication is enabled to use generic certificates, devices are considered to be trusted or pre-authenticated and the DPE uses data from the CWMP Inform message to establish trusted device identity.	
Disable HTTP-based device authentication and enable authentication based on client certificates validated by ACE	<code>service { cwmp   http } num client-auth none</code> <code>service { cwmp   http } num ssl client-auth client-cert-ext</code>

## Configuring Security for RDU Services

Cisco BAC supports local authentication as well as TACACS+ authentication. Local authentication is managed locally at the:

- DPE server, for DPE CLI
- RDU server, for the
  - Administrator user interface
  - Cisco BAC APIs

TACACS+ authentication relies on the TACACS+ protocol to support centrally managed user authentication using the TACACS+ server. The TACACS+ username, login password, and enable password are configurable at the TACACS+ server.

You can select one of the authentication modes by using the administrator user interface. Local authentication option is the default.

## RDU Authentication Mode Settings

You can select either local or TACACS+ authentication by using the administrator user interface. To enable TACACS+ authentication:

- 
- Step 1** Choose **Configuration** on either the Primary Navigation bar or Main Menu page.
- Step 2** Choose **Defaults** from the Secondary Navigation bar.  
The Configure Defaults page appears.
- Step 3** Click **TACACS+ Defaults** link on the left pane.  
The TACACS+ Defaults page appears.
- Step 4** Check the **TACACS+ Authentication** check box.
- Step 5** Set the TACACS+ server and encryption key.  
You can specify up to maximum of 5 TACACS+ servers. The order of the entries determines the order in which the TACACS+ servers are tried.
- Step 6** Set the TACACS+ Client Read/Write timeout.  
This is the time that the TACACS+ client waits for a TACACS+ server to reply to TACACS+ protocol requests. The range is from 1 to 300 seconds. The default is 5 seconds and applies to all TACACS+ servers.
- Step 7** Set the TACACS+ Client Maximum retries.  
This is the number of times that the TACACS+ client attempts a valid TACACS+ protocol exchange with a TACACS+ server if it fails to respond to initial request. The range is from 0 to 10. The default is 1 and applies to all TACACS+ server defined.
- Step 8** Click **Submit**.
- 

## TACACS+ Authentication and Authorization in RDU

When TACACS+ authentication is enabled, the client attempts user login authentication to each server sequentially in the list until a successful authentication exchange is executed, or the list is exhausted. If the list is exhausted, the client automatically falls back into the local authentication mode (using the local system password).

After the TACACS+ authentication is done, the user authorization (i.e., user role as Admin, read-write user or read-only user) is retrieved from the RDU database. You can specify the user role (read-write or a read-only) in the Add Users page in the administrator user interface.

# Signed Configuration for Devices

Cisco BAC uses the Signed Configuration feature to sign a portion of the CPE configuration that is targeted to be passed by the CPE to a third-party, such as an aggregation device. For example, a CPE with Femtocell functionality passes the access control entries to the Femtocell Gateway.

The configuration is signed using a secret key that is shared between Cisco BAC and the Gateway. This Signed Configuration eliminates the need to separately configure the Gateway for each individual CPE. The signature provides proof to the Gateway that the configuration:

- Was generated by Cisco BAC.
- Was not falsified during transmit.
- Is targeted for a specific CPE.
- Is targeted for a specific Gateway.
- Is current.

To prevent replay attacks, the time of the signature generation and its validity period are also incorporated in the signature.

## Signature Expiration

Cisco BAC is configured with a signature validity period that determines the window during which the device communicates the signed data and signature to the Gateway. If the device communicates the data to the gateway beyond that validity period, the gateway rejects the signature.

The gateway can also be configured to cache configurations beyond their signature validity period, provided the device reconnects to the gateway within a certain interval. This behavior reduces the load of signature regenerations for active devices and allows the device to not persist a security-sensitive signature across reboots.

## Signature Regeneration

The DPE generates a new signature and sets it on a device only if:

- The Signed Configuration parameters at the RDU are changed in the data model or in the configuration template.
- The device reports to the DPE that the Gateway rejected the signature for reasons such as invalidity or expiration.
- Device reports to the DPE that it does not have a signature.

## Configuration Interfaces

You can enable the Signed Configuration feature in Cisco BAC by configuring the following properties:

- Signature Validity—Specifies the number of seconds for which the signature is considered valid
- Signature Key Name—Indicates the name of the key that is used by the gateway to look up the shared secret key. You must change the signature key name when the secret key is changed.
- Secret Key—Specifies the secret that is used to compute the signature.

These properties can be configured using the CWMP Defaults page in the administrator user interface or by using the *IPDevice.changeDefaults* API.

You must also create a configuration template for the device. To generate the Signed Configuration, at least one parameter in the template must be flagged to be signed. You can flag any TR069 parameter to be signed.

For example:

```
<Parameter>
<Name>MyParameter</Name>
<Value>Sample Value</Value>
<ToBeSigned>true</ToBeSigned>
</Parameter>
```

Depending on the target Gateway, there can be a minimum set of required parameters that must be specified as signed. Here is a sample CWMP configuration template:

```
<tc:Template
...
<configuration>
<ParameterDictionaries>
  <ParameterDictionary>femto-cwmp-dictionary.xml</ParameterDictionary>
</ParameterDictionaries>
<ObjectInstance name="Device">
  <ObjectInstance name="Services">
    <ObjectInstance name="X_00000C_FAPService">

    <ObjectInstance name="AccessControl">
      <Parameter>
        <Name>ACL</Name>
        <Value>VAR(name=FC-ACL, defaultValue="")</Value>
        <ToBeSigned>true</ToBeSigned>
      </Parameter>
    </ObjectInstance>

  </ObjectInstance>
</ObjectInstance>
</ObjectInstance>
</ObjectInstance>
```

## Monitoring the Signed Configuration Feature

You can monitor the Signed Configuration feature in Cisco BAC from the administrator user interface or DPE CLI. You have the following options:

- Choose **Configuration > Files**. Click the View icon (🔍) corresponding to the Configuration Template to view the configuration parameters that are designated to be signed.
- From the **Devices > Manage Devices** page, click the **View Details** icon (🔍) corresponding to the device. The following device faults are reported in the Device Details page:
  - Signature rejected by the gateway because the validity period has expired.
  - Signature rejected by the gateway because of an unknown secret key name
  - Signed data rejected by the gateway because it is missing required parameters

- Incompatible device. Template contains parameters designated for signing, but the device does not report any expected support for the Signed Configuration feature
- To get basic information about the Signed Configuration process, enable the INFO logging level on the RDU and the DPEs. At this level of logging, the following are logged:
  - Changes in the Signed Configuration (in *rdulog*)
  - Details on the generation and setting of a new signature on a device (in *dpe.log*)
  - Indications of signature rejection by the device (in *dpe.log*)
- You can use the **debug on** and **debug service cwmp num cpe-signed-config-sync** commands to obtain the low-level tracing information in addition to the INFO level logging.

## Troubleshooting Signed Configuration Feature

When a device is placed in troubleshooting mode, all logging and debugging level details associated with Signature Generation are incorporated into the device troubleshooting log file. To view the device troubleshooting log file, see [Viewing Device Troubleshooting Log, page 8-12](#).

You can use the *perfstat.log* to view statistics on the number of times that the DPE:

- Generates and sets the signature on a device.
- Receives signature faults from a device.



# CHAPTER 14

## CWMP Device Operations

This chapter describes the device operations mechanism in Cisco Broadband Access Center (BAC). By using this mechanism, you can run CPE WAN Management Protocol (CWMP) remote procedure calls for a device and perform maintenance tasks, such as changing a device's provisioning group.

This chapter includes the following sections:

- [Overview, page 14-1](#)
- [Connection Modes for Device Operations, page 14-2](#)
- [Managing a Device's Provisioning Group, page 14-6](#)

### Overview

You use device operations to run individual CWMP remote procedure calls (RPCs) against a device immediately, or the next time the device connects to Cisco BAC. By using this feature from the provisioning API, you can troubleshoot, collect data, or customize the interaction between a device and Cisco BAC.

Device operations are submitted in a batch by using the `IPDevice.performOperation()` API call. For details, refer to the API Javadoc which is available at `BPR_HOME/docs/nb-api/javadoc`.

You can perform some operations from the administrator user interface. This section is focused on describing the concepts behind device operations, regardless of whether they are initiated using the API or the administrator user interface.

During a Cisco BAC installation, several sample files are copied to the `BPR_HOME/rdu/samples` directory, which contains:

- The `cwmp` directory, which features `*parameter-list.xml` files that describe parameter lists used to retrieve live device data by using the administrator user interface.
- The `nb-api` directory, which features `CwmpDiagnosticImmediateExample.java` and `CwmpDiagnosticOnConnectExample.java` files that describe how you can perform device operations by using the API.

The device operations supported in this Cisco BAC release are listed in [Table 14-1](#).

**Table 14-1** Device Operations Supported in Cisco BAC

Operation Name	Description
CreateObjectInstance	Creates object instances within a device's data model
DeleteObjectInstance	Deletes objects from a device's data model

**Table 14-1** Device Operations Supported in Cisco BAC (continued)

Operation Name	Description
Download	Instructs the device to perform a file download
FactoryReset	Resets a device's settings to its factory default state
Reboot	Instructs the device to reboot
GetParamAttributes	Retrieves attributes for a device's parameters
GetParamNames	Retrieves names of parameters exposed by a device
GetParamValues	Retrieves parameter values from a device's parameter space
GetRPCMethods	Retrieves a device's list of supported RPC methods
SetParamAttributes	Sets the value of device parameter attributes, such as Notification and Access List
SetParamValues	Sets the value of device parameters
ChangeProvGroup	Redirects a device to a new provisioning group
GenerateConfig	Regenerates the instruction set for a device
PassThrough	Sends a generic SOAP message to the device
RemoveOperation	Removes a pending on-connect device operation
RequestConnection	Initiates a connection request to a device

All device operations are executed before other configuration services, such as data synchronization, configuration synchronization, and firmware rules download.

**Caution**

You should not perform device configuration updates using device operations. The configuration process can overwrite any settings that you configured by using device operations.

## Connection Modes for Device Operations

Cisco BAC enables the performing of device operations in three modes:

- Immediate
- On-connect
- Asynchronous

### Immediate Mode

An immediate execution assumes that the device is reachable and is performed by the DPE first issuing a connection request to the device. If the device is not reachable, the operations automatically fail. You can run multiple operations in the same batch to improve performance, creating a single connection request and, thus, a single management session with the CWMP device.

A client uses a timeout period to post the API batch in immediate mode. If no timeout is set, the duration for immediate operations to time out is, by default, 60 seconds. If a device operation times out or its batch times out, an error is returned.



**Note**

Before attempting to run immediate operations against a device, ensure that the device is reachable and that Cisco BAC is configured to perform connection requests to the device. See [Connection Request Service](#), page 12-2.

Figure 14-1 illustrates the high-level flow for immediate operations.

**Figure 14-1 Immediate Operation Mode Workflow**

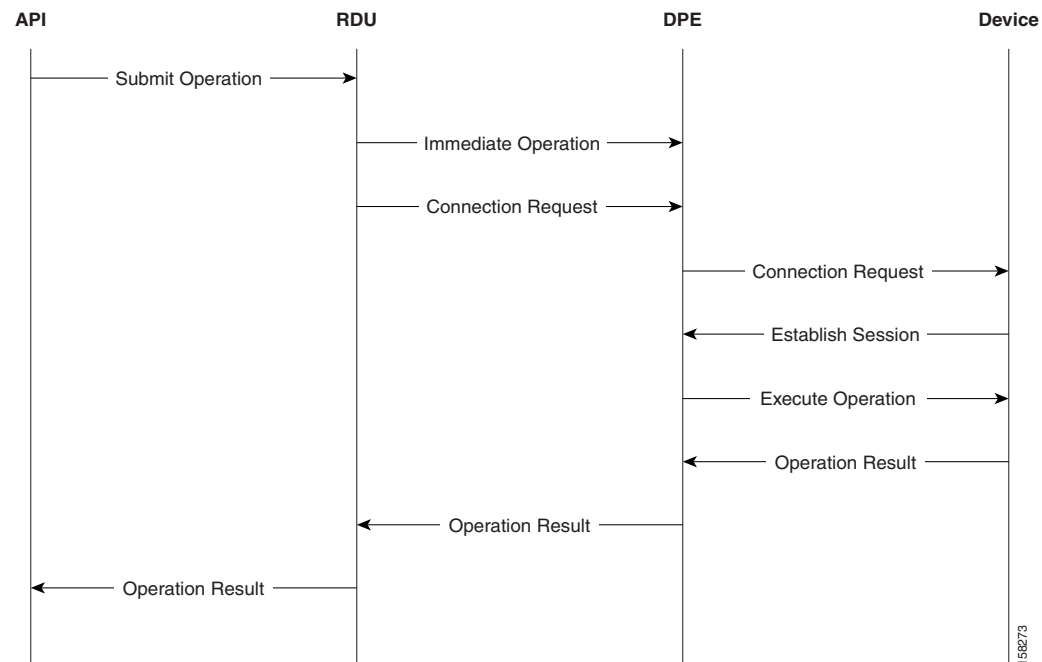

When the `performOperation()` API method is invoked specifying an immediate execution, the RDU constructs and sends corresponding operation instructions to all DPEs in the device's provisioning group. Then, the RDU sends a connection request instruction to a specific DPE within the provisioning group; the DPE, in turn, sends a connection request notification to the device.

When the device establishes a connection with the DPE, the DPE creates a new session and performs the operation upon the device. When the session is closed, the DPE returns the result of the operation to the RDU, which forwards the result to the API client in the Batch's command status.

**Note**

You must use the batch mode flag, `AUTOMATIC` during the immediate mode.

## On-Connect Mode

You can use an on-connect execution to support devices that are not reachable. It is best used in conjunction with periodic Inform RPCs from the CWMP device.

On-connect operations persist at each DPE in the device's provisioning group. They are not removed from the DPEs until the RDU instructs the DPEs to do so (after notifying the client of the execution results using an `AsyncOperationEvent`).

Figure 14-2 illustrates the high-level flow for on-connect operations.

**Figure 14-2 On-connect Operation Mode Workflow**

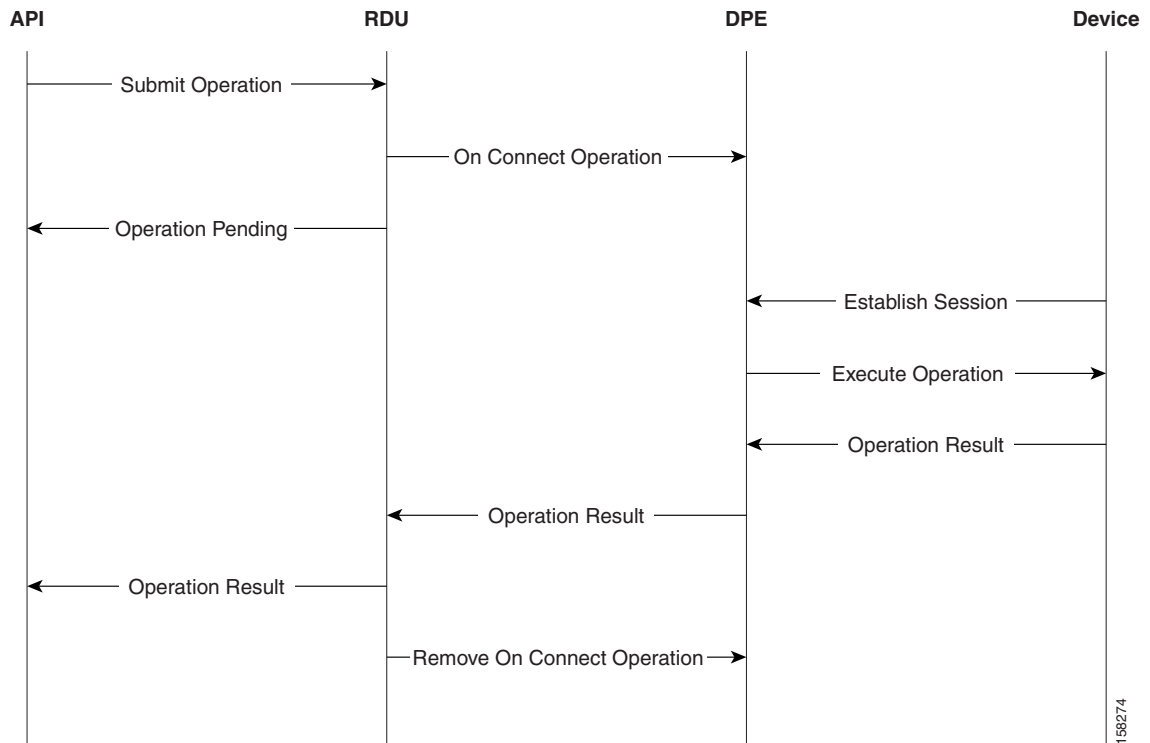

The API client constructs an `IPDeviceOperation` specifying an on-connect execution. It registers the appropriate `AsyncOperationEvent` listeners, then invokes the `performOperation()` API method. The RDU then constructs and sends corresponding operation instructions to all DPEs in the device's provisioning group. The DPEs save the operation in their internal database. The RDU batch completes, and the `BatchStatus` is returned to the API client.

The DPE does not initiate a connection request notification to the device, as it does while running an immediate operation.

When the device connects to the DPE the next time, the DPE creates a new session with the device and runs the operation upon the device. When the session is closed, the operation result is sent to the RDU, and the RDU sends an `AsyncOperationEvent` to any registered API client listeners.

Immediate operations are always run before on-connect operations. While you can use Cisco BAC to mix modes of operations along with the built-in instructions, you must ensure that the instructions do not override one other.

For example, if the device's configuration template specifies `False` for `InternetGatewayDevice.ManagementServer.PeriodicInformEnable` and a device operation changes that to `True`, the configuration template, which runs only after the device operation, overrides it to `False`.

## Asynchronous Mode

Asynchronous mode facilitates the RDU to execute the asynchronous immediate operation without reserving a PACE thread for the complete operation. The TR-069 IPDevice operations like GetParameterValues and GetParamValues RPC can be performed with this mode. This feature helps in increasing the RDU efficiency in serving more number of API operation requests.

The asynchronous operation is performed as follows:

1. The API client submits asynchronous operation batches to the RDU.
2. The RDU sends the asynchronous operation request to the DPE.
3. After receiving an acknowledgment from the DPE, RDU sends a connection request to DPE. The DPE then sends a connection request to the CPE.
4. The DPE sends the connection request result to the RDU.
5. If connection request fails, DPE sends an AsyncOperationEvent event to the RDU with the connection request status and the RDU releases the PACE thread.
6. When the connection request to CPE is successful, the CPE establishes a session in a separate thread, and the DPE executes the asynchronous operation on the CPE.
7. The CPE sends the operation results to DPE, and DPE further sends the operation result to RDU.
8. RDU processes the operation result and further sends an AsyncOperationEvent event to API client with the operation result.

Figure 14-3 illustrates the high-level flow for asynchronous operations.

**Figure 14-3 Asynchronous Operation Mode Workflow**

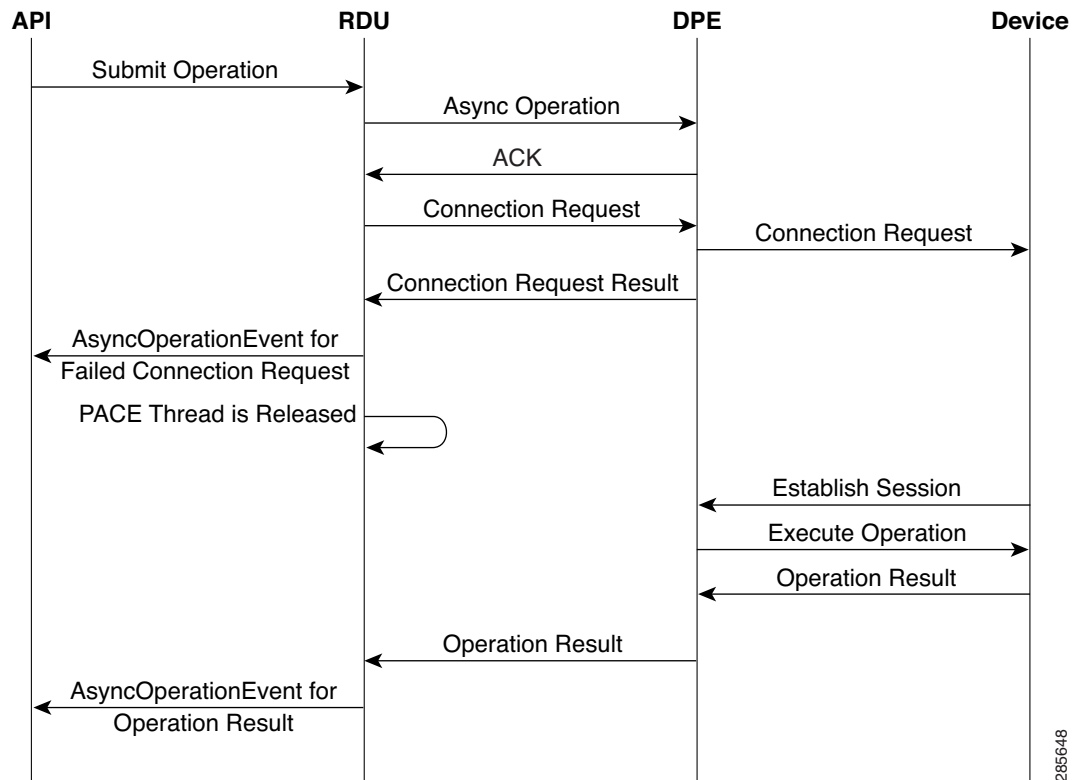

**Note**

---

You must use the batch mode flag, `ASYNC_AUTOMATIC` during the asynchronous operation mode.

---

The API command `Configuration.getRDUDetails()` is enhanced to report statistics of the following asynchronous operations:

- Total number of asynchronous operation requests received by the RDU.
- Total number of asynchronous operation succeeded.
- Total number of asynchronous operation failed.
- Minimum time taken for asynchronous operation.
- Maximum time taken for asynchronous operation.
- Average time taken for asynchronous operation.
- Total time taken for all asynchronous operations.
- Total number of asynchronous immediate operations failed due to acknowledgment failed from DPE.
- Total number of asynchronous operations failed due to DPE server not found in Provisioning Group.
- Total number of asynchronous operations failed due to connection request error.
- Total number of asynchronous operations failed due to connection request failed.
- Total number of connection request succeeded for asynchronous operations requests.

## Conditional Execution

Additionally, immediate and on-connect operations are conditionally executed based on the TR-069 Event Codes in the Inform message from the device. If no intersection occurs between the reported Event Codes in the device's Inform and the list of Event Codes specified in the operation, the operation is not executed.

For example, an operation might be conditional upon the Inform Event Code list including `6 CONNECTION REQUEST`. Therefore, the operation only executes if the device reports it is connecting because of an autoconfiguration server (ACS) connection request. If the device reports it is connecting for any other reason, for instance a periodic Inform, the operation does not execute.

## Managing a Device's Provisioning Group

The provisioning group for a CWMP device is specified on the device object in the RDU. On the:

- Provisioning API, through the `IPDeviceKeys.HOME_PROV_GROUP` property.
- Administrator user interface, through the Home Provisioning Group drop-down list in the Devices pages.

In managing a device's provisioning group, occasionally, you might need to redirect or correct the provisioning group of a device:

- [Redirecting CPE to Home Provisioning Group, page 14-7.](#)

In this scenario, the device communicates with a specific provisioning group, for example PG1, and you want to redirect it to communicate with its home provisioning group, PG2.

- [Correcting a Device's Provisioning Group](#), page 14-8.

In this scenario, the device's provisioning group in Cisco BAC is incorrect and must be changed only in Cisco BAC; for example, the device attempts to contact PG1 but is provisioned for PG2 in Cisco BAC.

Both use cases are described in detail in the following sections.

**Note**

---

You cannot change a device's provisioning group if the DPE cannot connect to the RDU.

---

## Redirecting CPE to Home Provisioning Group

Cisco BAC redirects a device to its home provisioning group by having the provisioning groups communicate among themselves to find the device's correct home provisioning group.

When a device attempts to establish a session with a DPE, the DPE searches its cache for an entry related to that device. If it cannot find an entry for that device, it sends home provisioning group queries to the DPEs in other provisioning groups.

**Note**

---

If the home provisioning group is down or is not responding, the DPE that receives the Inform message returns the *503 Service Unavailable* error along with the *Retry-After* header. Thereafter, the session with the device is dropped.

---

To select the best available DPE in each provisioning group, the DPE maintains the status data of all other DPEs in the deployment. The DPE sends a status request at configured time intervals to update its knowledge of the state of other provisioning groups.

Each state has a corresponding integer value. The higher the value, the better the state of the provisioning group. The DPE, using its knowledge of the current state of other DPEs, selects a DPE in the highest state in each provisioning group.

After sending the home provisioning group query, the DPE waits for a response from the other provisioning groups. If a provisioning group responds that the device belongs to its group, then the DPE redirects the device to its home provisioning group.

[Figure 14-4](#) highlights the basic flow when a device attempts to establish a session with the wrong provisioning group.

Figure 14-4 Redirecting CPE to Home Provisioning Group

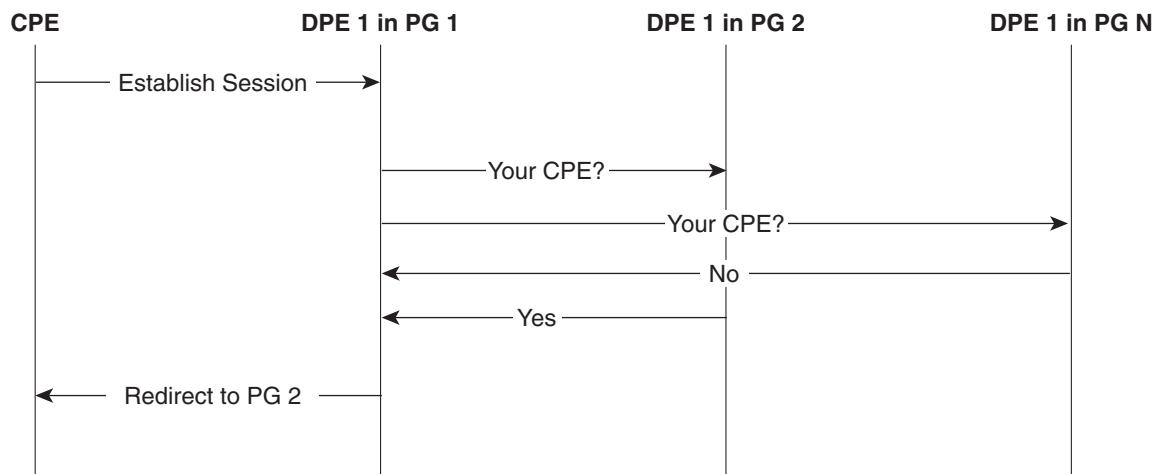

1. The CPE attempts to establish a session with DPE 1 in provisioning group 1 (PG 1).
2. DPE 1 in PG 1 searches its cache for the device.  
If it cannot find an entry for that device, the DPE sends a request to the best available DPE in each provisioning group to find out whether the device belongs to that group.  
Only one DPE per provisioning group is queried.
3. The DPEs that receive the request in each provisioning group, send their reply to DPE 1.  
If a provisioning group responds that the device belongs to its group, then DPE 1 in PG 1 redirects the CPE to its home provisioning group.
4. The CPE attempts to establish a session with its home provisioning group.

To enable the home provisioning group redirection feature, you must configure the home provisioning group redirection service on the DPE. See [Configuring Home Provisioning Group Redirection Service on the DPE](#), page 3-9.

## Correcting a Device's Provisioning Group

You can also just reset an incorrect provisioning group specification on the device. In this scenario, you do not need to change the actual device—you only need to update Cisco BAC.

To change an incorrect provisioning group from the API, invoke the `IPDevice.changeProperties()` API and include the `IPDeviceKeys.HOME_PROV_GROUP` property with the corrected provisioning group. For details, refer to the API Javadoc which is available at `BPR_HOME/docs/nb-api/javadoc`.

To change an incorrect provisioning group specification from the administrator user interface:



### Note

If you change the home provisioning group from the administrator user interface, you only correct the provisioning group in Cisco BAC; the change does not affect the device.

- Step 1** Click the **Devices** tab on the primary navigation bar.

The Manage Devices page appears.

- Step 2** Click the Identifier link corresponding to the correct device.
- Step 3** Select your options from the Home Provisioning Group drop-down list.
- Step 4** Click **Submit** to save the changes to the device.

The device is now assigned to a specific provisioning group.

---







# CHAPTER 15

## Understanding the Administrator User Interface

---

This chapter describes how to access the Cisco Broadband Access Center (BAC) administrator user interface and explains the interface.

This chapter includes the following sections:

- [Configuring the Administrator User Interface, page 15-1](#)
- [Accessing the Administrator User Interface, page 15-2](#)
- [Understanding the Administrator User Interface Icons, page 15-4](#)

[Using the Administrator User Interface, page 16-1](#), explains how to use the user interface to perform administrative activities. In addition, the *Cisco Broadband Access Center 3.8 DPE CLI Reference*, contains descriptions of the CLI commands used to access, monitor, and control the Device Provisioning Engines (DPEs).

## Configuring the Administrator User Interface

When you install the RDU, the installation program also installs the administrator user interface. The administrator user interface starts by default, when the RDU is installed.

Before you use the administrator user interface, examine the *adminui.properties* file. This file contains a variety of controls that specify the behavior of the interface.

You can open this file by using any text editor, and change its content to perform the functions that you want. After your changes are complete and saved, restart the user interface so that all the changes take effect.

To start the administrator user interface, enter:

```
# etc/init.d/bprAgent tomcat start
```

To stop the administrator user interface, enter:

```
# etc/init.d/bprAgent tomcat stop
```

You can configure the user interface by using the options available in the *adminui.properties* file. These options are controlled by Cisco BAC settings or defined in the *adminui.properties* file in the `BPR_HOME/rdu/conf` directory.

The configuration parameters are:

- `/adminui/port`—Specifies the listening port of the RDU. This port number is, by default, 49187.
- `/adminui/fqdn`—Specifies the fully qualified domain name of the host on which the RDU is running. This value is, by default, the FQDN of the host; for example, `bac_test.ACME.COM`.

- `/adminui/maxReturned`—Specifies the maximum number of search results. This number is, by default, 1000.
- `/adminui/pageSize`—Specifies the number of search results displayed per page. You can set this number at 25, 50, or 75. The default value is 25.
- `/adminui/refresh`—Specifies if the refresh function is enabled or disabled. This option is, by default, disabled.
- `/adminui/extensions`—Specifies if the use of extensions in Cisco BAC is enabled or disabled. You use extensions to augment Cisco BAC behavior or add support for new device technologies. The use of extensions is, by default, enabled.
- `/adminui/maxFileSize`—Specifies the maximum size of a file uploaded to Cisco BAC. This file size is, by default, 10 MB.
- `/adminui/refreshRate`—Specifies the duration (in seconds) after which a screen is refreshed. This value is, by default, 90 seconds. Before setting a value for this option, ensure that the `/adminui/refresh` option is enabled.
- `/adminui/timeout`—Specifies the duration (in minutes) after which an idle session is timed out. This period is, by default, set as 300 minutes.
- `/adminui/noOfLines`—Specifies the last number of lines from the `rdu.log` or the `dpe.log` that will be displayed on the user interface. The number of lines that appear, by default, is 250.
- `/adminui/noOfFiles`—Specifies the number of troubleshooting log files that you can view. The number of files you can view is, by default, 1. The maximum number of files that you can view at a given time is 5.

**Example 15-1 Sample `adminui.properties` File**

```
/adminui/port=49187
/adminui/fqdn=doc.cisco.com
/adminui/maxReturned=1000
/adminui/pageSize=25
/adminui/refresh=disabled
/adminui/extensions=enabled
/adminui/maxFileSize=10000000
/adminui/refreshRate=90
/adminui/timeout=300
/adminui/noOfLines=250
/adminui/noOfFiles=1
```

## Accessing the Administrator User Interface

You can access the administrator user interface from any computer that can access the URL corresponding to the Cisco BAC application.

### Logging In

You can log into the user interface as an Administrative user, a Read/Write user, or a Read-Only user. Although each user type has different capabilities, as described in [User Management, page 16-1](#), you access the user interface in the same way.

Complete this procedure to access the administrator user interface:

**Step 1** Launch your web browser.

[Table 15-1](#) lists the browsers supported in this Cisco BAC release.

**Table 15-1 Browser Platform Support**

Platform	Supported Browsers
Windows 2000 (Service pack 2)	Internet Explorer 6.0 and above
Windows 2000, Windows XP, Solaris, Linux	Mozilla 3.0.8

**Step 2** Enter the administrator's location using this syntax:

**http:** //*machine\_name*/

- *machine\_name*—Identifies the computer on which the Regional Distribution Unit (RDU) is running.



**Note** To access the administrator user interface by using HTTP over SSL, also known as HTTPS, enter: **https:** //*machine\_name*/

The server-side of the administrator application runs on a computer port. By default, this port number is:

- 80 for HTTP over TCP
- 443 for HTTP over SSL

The main login page appears.

**Step 3** Enter the default username (**bacadmin**) and password (**changeme**).

If you are logging in for the first time, the Change Password screen appears. Enter a new password and confirm it.. Note that the FQDN of the RDU server you are logged into appears in the User Login area.

**Step 4** Click **Login**,

The Main Menu page appears.

**Step 5** Use the link at the top of the page to add new Cisco BAC licenses.

From this page, you can enter the technology licenses that you are authorized to use. For more information, see [Configuring Broadband Access Center, page 17-1](#).

## Logging Out



To log out of Cisco BAC:

- 
- Step 1** Click **Logout** at the top right corner of any page.  
A confirmation dialog appears.
- Step 2** Click **OK**.  
This returns you to the User Login page.
- 

## Understanding the Administrator User Interface Icons

The Cisco BAC administrator user interface features icons, which you can use to perform specific functions. [Table 15-2](#) defines these icons.

**Table 15-2 Administrator User Interface Icons**

Icon	Description
	This icon serves as: <ul style="list-style-type: none"> <li>• View Details icon—Enables you to view details of a given device or file.</li> <li>• Operations icon—Enables you to run operations on a given device.</li> </ul>
	Delete icon—Deletes a specific object.
	Export icon—Exports the contents of a specific file to the client's computer.

These icons are used in sections describing procedures that you perform using the administrator user interface. These sections include:

- [Using the Administrator User Interface, page 16-1](#)
- [Configuring Broadband Access Center, page 17-1](#)



# CHAPTER 16

## Using the Administrator User Interface

---

This chapter describes the administration tasks performed from the Cisco Broadband Access Center (BAC) administrator user interface. These tasks mainly involve monitoring the actions of various Cisco BAC components.

This chapter includes the following sections:

- [User Management, page 16-1](#)
- [Device Management, page 16-4](#)
- [Group Management, page 16-18](#)
- [Viewing Servers, page 16-22](#)



### Note

The procedures described in this chapter are presented in a tutorial manner. Wherever possible, examples are included to illustrate the possible results of each procedure.

For details on server configurations, see [Configuring Broadband Access Center, page 17-1](#).

---

## User Management

Managing users involves adding, modifying, and deleting users who administer Cisco BAC. Depending on your user type, you can use this menu to add, modify, and delete users. This menu displays all users configured to use Cisco BAC and identifies their user types.

There are three types of Cisco BAC users: an Administrator, a Read/Write user, and a Read-Only user. Each has different levels of access, with unique permissions to ensure access control and the integrity of provisioning data.

The assigned user type appears near the top right corner of every screen on the administrator user interface.

## Administrator

Cisco BAC recognizes only one administrator and allows this user to view, add, modify, delete device data, and create other users. As an Administrator, you can also change other users' permissions from Read/Write to Read Only, and vice-versa. In addition, you have the ability to change the passwords of any other user type.

You cannot delete the "Administrator" user.

## Read/Write User

As a Read/Write user, you can perform the same functions as the administrator except creating other users, changing the user types of others, or changing their passwords. Read/Write users can change their own password.

## Read-Only User

As a Read-Only user, you have basic access including the ability to change your password and to view, but not change, device data. You cannot perform any action that is considered disruptive. You cannot, for example, perform reset or regenerate instructions.

This section contains instructions for managing Cisco BAC users including:

- [Adding a New User](#)
- [Modifying Users](#)
- [Deleting Users](#)



**Note**

You can add and delete users only if you are logged in as the Administrator.

## Adding a New User

Adding a new user is a simple process of entering the user's name and creating a password. However, while creating a new user you do have to determine which type of user it will be: a Read/Write user or a Read-Only user. Cisco BAC comes with one Administrator user already created; you cannot create an Administrator as a new user.

To add a new user:

- Step 1** Click **Users**, from the Main Menu or the Primary Navigation bar.  
The Manage Users page appears. (See [Figure 16-1](#).)
- Step 2** Click **Add** to display the Add User page.

**Figure 16-1** Manage Users Page

User	Description	Role	Delete
admin	Administrator	Administrator	
user-1	Test	Read Write	

Result Pages: 1

- Step 3** Enter the new user's username and a password.

**Step 4** Confirm the new user's password, and select whether the new user's role is to be read only or read/write. See [User Management, page 16-1](#), for complete descriptions of each user type.

**Step 5** Enter a short description of the new user.



**Tip** Use the description field to identify the user's job or position, something that identifies the unique aspects of the new user.

**Step 6** Click **Submit**.

The Manage Users page appears with the new user added.



**Note** The new user's password must be recorded and stored in a safe place. This helps prevent loss or theft of the password and possible unauthorized entry.

## Modifying Users

Although any user type can modify their password and user description, only the administrator can modify any other user's information.

To modify user properties:

**Step 1** From the Main Menu or the Primary Navigation bar, click **Users**.

The Manage User page appears.

**Step 2** Click the correct user name to display the Modify User page for that user.

**Step 3** Make the necessary changes to the password, user type (provided that you are logged in as the Administrator), and the user's description.

**Step 4** Click **Submit**.

The Manage Users page appears with the modified user information.

## Deleting Users

Only the administrator can delete any other user that appears in the Manage Users page. You cannot delete the default user, called **bacadmin**.

To delete a user:

- 
- Step 1** From the Main menu or the Primary Navigation bar, click **Users**.  
The Manage User page appears.
- Step 2** Click the **Delete** icon () corresponding to the user you want to delete.
- Step 3** The Delete User dialog box appears. Click **OK**.  
The Manage Users page appears without the deleted user.
- 

## Device Management

Use the Devices menu to provision and manage TR-069 and TR-196 enabled devices. You can:

- Search for a specific device or for a group of devices that share criteria that you specify. See [Searching for Devices, page 16-5](#).
- Add, modify, or delete devices in the RDU database. See:
  - [Adding Device Records, page 16-11](#)
  - [Deleting Device Records, page 16-11](#)
- View device data, such as configuration, properties, discovered data, and faults. See [Viewing Device Details, page 16-7](#).
- Regenerate device instructions. See [Regenerating Device Instructions, page 16-12](#).
- Relate and unrelate any device to a specific group. See [Relating and Unrelating Devices, page 16-13](#).
- Enable device troubleshooting. See [Configuring Device Troubleshooting, page 8-10](#).
- Perform various operations, such as an IP Ping, and live data retrieval, on the device to gain more insight. See [Performing Operations on Devices, page 16-14](#).

## Manage Devices Page

The Manage Devices page appears when you click **Devices** on the Main menu or the Primary Navigation bar. This page, shown in [Figure 16-2](#), contains the fields and controls necessary to perform all device management functions.



Figure 16-2 Manage Devices Page

**Broadband Access Center** Logout

Configuration **Devices** Groups | Servers | Users

User: admin Role: Administrator

---

**CISCO SYSTEMS** **Manage Devices**  
Use this page to manage devices, then to view the details of the device listed.

Search Type: Device Identifier Search | Device Identifier or Device Identifier wildcard: \* | Page Size: 25 | Search

Add | Delete | Regenerate | Relate | Unrelate

<input type="checkbox"/>	Identifier	Device Type	Details	Operations
<input type="checkbox"/>	<a href="#">cwmp-5</a>	CWMP	<a href="#">Details</a>	<a href="#">Operations</a>
<input type="checkbox"/>	<a href="#">cwmp-3</a>	CWMP	<a href="#">Details</a>	<a href="#">Operations</a>
<input type="checkbox"/>	<a href="#">cwmp-91</a>	CWMP	<a href="#">Details</a>	<a href="#">Operations</a>
<input type="checkbox"/>	<a href="#">cwmp-32</a>	CWMP	<a href="#">Details</a>	<a href="#">Operations</a>

Result Pages: 1

158322

## Searching for Devices

By using Cisco BAC, you can search for device information in a number of different ways.

To select the search type, from the Manage Devices page, click the Search Type drop-down list. Subsequent search pages contain screen components that may be unique to the search type selected.

The Manage Device page utilizes two separate but related areas to generate search results that let you perform many device management functions. These areas are the Search Type drop-down list that defines which search to perform, and search value field, which qualifies the search type. You can perform these searches:

- **Device Identifier Search**—Searches by using the device ID. This search function supports wildcard searching at the end of the search string. You can also look up a single device by providing a complete device ID of a specific device.
- **FQDN Search**—Searches by using the fully qualified domain name (FQDN) associated with the device.
- **Group Search**—Searches devices which are part of a particular group.
- **Owner ID search**—Searches by using the owner ID associated with the device. The owner ID may identify the service subscriber's account number, for example. This search function does not support wildcard searching.
- **Registered Class of Service Search**—Searches by using the Class of Service that a device has been provisioned with.
- **Related Class of Service Search**—Searches by using both the registered and selected Class of Service.
- **Selected Class of Service Search**—Searches by using the Class of Service selected by the RDU for a device that, for one reason or another, cannot retain its registered Class of Service.

Some searches that you can perform allow the use of a wildcard character (\*) to enhance the search function. Cisco BAC provides specific wildcards for each search, as described in [Table 16-1](#).

**Table 16-1 Searches Supported for Device Management**

Menu Search	Search Type Options
Device Identifier Search	Full Device Identifier or partial Device Identifier followed by a wildcard asterisk (*) character at the end of the string.  For example, to search for a device with the ID 0010BF-ZAA001A00001, you can try 0010BF-*, but searching by using *-ZAA001A00001 does not yield results.
FQDN Search	Full FQDN or partial FQDN string beginning with an wildcard asterisk (*) character.  For example, to search for a device with the FQDN IGW-1234.ACME.COM, you can try: <ul style="list-style-type: none"> <li>• *.acme.com</li> <li>• *.com</li> <li>• *</li> </ul>
Group Search	Group Name (Group Type) <ul style="list-style-type: none"> <li>• Drop-down list</li> </ul> Full Device Identifier or partial Device Identifier followed by a wildcard asterisk (*) character at the end of the string.
Owner ID Search	Owner ID  Wildcard searches are not supported. You must enter the complete owner ID.
Registered Class of Service Search	Class of Service (Type) <ul style="list-style-type: none"> <li>• Drop-down box</li> </ul>
Related Class of Service Search	Class of Service (Type) <ul style="list-style-type: none"> <li>• Drop-down box</li> </ul>
Selected Class of Service Search	Class of Service (Type) <ul style="list-style-type: none"> <li>• Drop-down box</li> </ul>

In addition, a Page Size drop-down lets you limit the number of search results displayed per page. You can select 25, 50, or 75 results for display. When the number of search results is greater than the selected page size, paging controls appear in the lower left corner of the page. These controls let you scroll forward or backward one page at a time, or to select a specific page.



**Note**

A maximum of 1,000 results are returned for any query, with a maximum of 75 results displayed per page. You can change the default maximum by modifying the `/adminui/maxReturned` property, in the `BPR_HOME/rdu/conf/adminui.properties` file, and then running the **bprAgent restart tomcat** command (located in the `/etc/init.d/` directory) to restart the Cisco BAC Tomcat component.

## Device Management Controls

These buttons are located directly below the search function fields and are generally used in conjunction with the search function. For example, you might search for devices belonging to a specific group of devices in order to perform some sort of management function. The following buttons are available, although each management function may not be available depending on the search type used.

### Add

The Add button lets you add a new device to the RDU database. See [Adding Device Records, page 16-11](#), for the appropriate instructions.

### Delete

The Delete button lets you delete any selected device(s) from the RDU database. See [Deleting Device Records, page 16-11](#), for the appropriate instructions.

### Regenerate

Use the Regenerate button to force immediate regeneration of instructions for selected device(s).

### Relate

The Relate button lets you associate a device (by using its Device ID) with a specific group (referred to as Node in the API).

### Unrelate

The Unrelate button cancels the relationship between a selected device and the group that the device is currently related to.

Searching for devices returns results under the following headings or links that appear on the page:

### Identifier

Identifies all devices matching the search criteria. Each of the identifiers displayed has a link to another page from which you can modify the device.

### Device Type

Displays the available device type; in this case, CWMP.

### Details

Displays all available details for the selected device. See [Viewing Device Details, page 16-7](#), for additional information.

### Operations

Displays a drop-down list of available device operations. See [Performing Operations on Devices, page 16-14](#), for additional information.

## Viewing Device Details

You can view the details of any device identified in the search results.

To view any device details, click the **View Details** icon () corresponding to the device you want to view, and the Device Details page appears.

Figure 16-3 provides a sample Device Details page.

**Figure 16-3** Device Details Page

Device Details	
Device Type:	CWMP
Device ID:	42
FQDN:	42.default.com
Host Name:	42
Domain Name:	default.com
Provisioning Group:	<a href="#">default</a>
Home Provisioning Group:	default
Old Provisioning Group:	
CPE Password:	
Connection Request User Name:	
Connection Request Password:	
Device Properties:	
Registered Class Of Service:	default
Owner Identifier:	
CPE Configuration Revision:	298f54e
CPE Firmware Rule Revision:	1b735cef
Selected Access:	REGISTERED
Selected Class of Service:	<a href="#">unprovisioned-cwmp</a>
Selected Explanation:	Because the device is registered.
Selected Reason:	REGISTERED
Related Group Name (Group Type):	<a href="#">nodePrefix1(nodeType1)</a>
Troubleshooting:	Disabled
View Device History Details:	<a href="#">63</a>
Registered On:	Fri, 11 Nov 2011 00:55:34 EST

Table 16-2 identifies the fields shown in Figure 16-3.

**Table 16-2** Device Details Page

Field or Button	Description
<b>Device Details</b>	
Device Type	Identifies the device type.
DeviceID	Identifies the device identifier.
FQDN	Identifies the fully qualified domain name for the selected device. For example, IGW-1234.ACME.COM is a fully qualified domain name.
Host Name	Identifies the host. For example, in the FQDN description above, IGW-1234 is the hostname.
Domain Name	Identifies the domain within which the host resides. For example, in the FQDN description above, ACME.COM is the domain name.
Provisioning Group	Identifies the provisioning group to which the device has been pre-assigned or assigned automatically.

Table 16-2 Device Details Page (continued)

Field or Button	Description
Home Provisioning Group	Identifies the provisioning group to which the device should belong.
Old Provisioning Group	Identifies the provisioning group to which the device was earlier belonging.
CPE Password	Identifies the password used to authenticate the device when establishing a connection to Cisco BAC. This password is used only for HTTP-based authentication of the customer premises equipment (CPE).  For security purposes, it returns a string with asterisk (*) characters regardless of the actual value unless the password has not been set, in which case an empty value is displayed.
Connection Request User Name	Identifies the username used to authenticate a ConnectionRequest from Cisco BAC to the CPE.
Connection Request Password	Identifies the password used to authenticate a ConnectionRequest from Cisco BAC to the CPE. For security purposes, this parameter returns an empty string regardless of the actual value.
Device Properties	Identifies any properties, other than those that appear on this page, that can be set for this device. This field includes the display of custom properties.
Registered Class of Service	Identifies the Class of Service assigned to this device. If a different Class of Service has been selected for the device by extension, an additional field with Selected Class of Service appears.
Owner Identifier	Identifies the device. This may be a user ID, and account number, or may be blank.  <b>Note</b> The owner identifier is an alpha numeric field which can also contain the special characters (\$, @, !, ~, &, %, ^, #, *, -, _ , , +, = etc.).
CPE Configuration Revision	Identifies the configuration rules revision number, which is set for the device <i>ParameterKey</i> following a successful configuration synchronization.
CPE Firmware Rule Revision	Identifies the firmware rules revision for this CPE.
Related Group Name (Group Type)	Identifies the group(s) name and type to which this device is related. See <a href="#">Group Management, page 16-18</a> , for additional information.
Troubleshooting	Identifies if CPE troubleshooting is enabled or disabled.  <b>Note</b> If troubleshooting is enabled, a View Troubleshooting Log link appears on this page.
View Device History Details	Provides a link to the history of configuration changes on the CPE.
Registration On	The time stamp when the device is registered with RDU.

Table 16-2 Device Details Page (continued)

Field or Button	Description
<b>Discovered Parameters</b>	
<b>Note</b> This section includes any parameters discovered from the device. This section does not appear unless discovered parameters are available for the device. For details on how to configure discovered parameters, see <a href="#">Discovering CPE Parameters, page 4-4</a> .	
Has Routable IP Address	Identifies if a device is generally reachable; that is, if the source IP address of the last request was the same as the WAN IP address reported by the CPE in the Inform message.
Inform.DeviceId.Manufacturer	Identifies the manufacturer of the CPE reported in the last Inform message.
Inform.DeviceId.ManufacturerOUI	Identifies the unique identifier of the manufacturer of the CPE reported in the last Inform message.
Inform.DeviceId.ProductClass	Identifier a manufacturer's product or class of product over which the <i>SerialNumber</i> parameter is unique. The device reports this parameter in the Inform message.
InternetGatewayDevice.DeviceInfo.HardwareVersion	Identifies the hardware version of the CPE.
InternetGatewayDevice.DeviceInfo.ModelName	Identifies the model name of the CPE.
InternetGatewayDevice.DeviceInfo.SoftwareVersion	Identifies the software version currently installed on the CPE. The software version is also known as firmware version.
InternetGatewayDevice.ManagementServer.ParameterKey	Specifies the value of the <i>ParameterKey</i> reported by the device in the last Inform message or last set by the DPE, whichever occurred last.
<b>Faulty Device List</b>	
<b>Note</b> This information is displayed only if faults occur at the devices. For more information, see <a href="#">Device Faults, page 8-6</a> .	
Last Fault Time	Specifies the date and time that a recurring fault occurred for this device.
Location	Specifies the server on which this fault occurred.
Fault Description	Provides a description of the recurring fault.

## Managing Devices

The Devices menu lets you add devices to the RDU databases and update preprovisioned data. Device management includes:

- Adding, deleting, and modifying RDU device records
- Regenerating instructions
- Relating selected devices to management objects, such as Provisioning Group, Class of Service, Group, and so on.
- Executing operations on devices. These operations are actually performed on the device and include:
  - Reboot

- Request Connection
- Factory Reset
- Display Live Data
- Ping Diagnostic
- Force Firmware Upgrade
- Force Configuration Synchronization

For detailed information on these operations, see [Performing Operations on Devices, page 16-14](#).

This section describes how to perform the various device management functions on new or existing devices.

## Adding Device Records

To add a device record:

- 
- Step 1** From the Manage Devices page, click **Add**.  
The Add Device page appears.
- Step 2** Choose the device type and Class of Service, and complete the other fields on the page.
- Step 3** In addition to the fields described earlier in this section, you can optionally add new values for existing property name/value pairs.
- Property Name—Identifies the name of the custom or built-in device property.
  - Property Value—Identifies the value of the property.
- To add the property, click **Add**.
- Step 4** Click **Submit** to add the device, or **Reset** to clear all fields.
- 

## Modifying Device Records

To modify a device record:

- 
- Step 1** From the Manage Devices page, click the Identifier link corresponding to the correct device.  
The Modify Device page appears.
- Step 2** Enter the data in the correct field. You can modify any existing property name/value pairs by clicking **Add**, or delete any of them by clicking the **Delete** button.
- Step 3** Click **Submit** to save the changes made to this device, or **Reset** to clear all fields.
- 

## Deleting Device Records

Deleting device records is a simple process, but one that you should use carefully. To undo the delete, you must restore a previously backed up database or re-add the device.

**Note**

See [Database Restore, page 10-6](#), for additional information if restoration of a backed-up database becomes necessary.

To delete a device record:

**Step 1** From the Manage Devices page, locate the device that you want to delete. You can use one of the search types for this purpose.

**Step 2** Select the check box associated with the correct device.

**Step 3** Click **Delete**.

The device record stored in the RDU database is removed.

## Viewing Device History

To view the history of a device configuration:

**Step 1** From the Manage Devices page, locate the device whose history you want to view. You can use one of the search types for this purpose.

**Step 2** Click the **View Details** icon corresponding to the device.

The Device Details page appears.

**Step 3** Against View Device History Details, click the **View Details** icon.

The Device History Details page appears.

## Regenerating Device Instructions

The Regenerate button or API operation force immediate regeneration of instructions for the device. These instructions are sent to the DPEs in the device's provisioning group. Normally, the process of regenerating the instruction is automatically triggered following changes to device, Class of Service, or other such impacting changes.

However, after a change to a Class of Service, the system takes time to regenerate instructions for all devices. This button can be used to expedite regeneration of instructions for a given device. This may be desirable during proactive troubleshooting.

Device instructions are automatically regenerated whenever:

- A file related to a Class of Service, that is, a template, is updated.
- The default Class of Service for a device type is changed.
- The provisioning group object is changed using the administrator user interface or the API.
- The Class of Service object properties are changed.
- The DPE sends a configuration regeneration request to the RDU.
- The device properties or relationship is updated.



Some instructions cannot be automatically regenerated because the Cisco BAC system cannot determine if the change impacts device instructions. In such cases, you must manually regenerate instructions by using the `generationConfiguration()` method or the administrator user interface. Instructions that must be manually regenerated are those that become necessary whenever:

- A technology default is changed.
- The system defaults are changed.

**Note**

Regardless of how instructions are regenerated, they are not propagated to the devices until the device configuration is activated, that is, the device contacts the DPE either on schedule or as a result of a connection request initiated from the DPE.

## Relating and Unrelating Devices

You can define any number of arbitrary groups. The Relate function lets you associate a device to a specific group, which is in turn associated with a specific group type.

### Relating a Device to a Group

**Note**

You can relate devices to groups only one by one using the administrator user interface.

To relate a device to a group:

- Step 1** From the Manage Devices page, locate the device which you want to relate to a group. You can use one of the search types for this purpose.
- Step 2** Check the check box corresponding to the device Identifier, and click the **Relate** button.  
The Relate Device to Group(s) page appears.
- Step 3** Select the Group Type from the drop-down list and the Group(s) from the list of defined groups.

**Note**

To select multiple groups from the Group list, press **Control** or **Shift**.

- Step 4** Click **Submit**.  
The Manage Devices page appears.  
To verify whether the device has been added to the group, click the **View Details** icon corresponding to the device. On the Device Details page that appears, check the status against Related Group Name (Group Type).

### Unrelating a Device from a Group

**Note**

You can relate devices to groups only one by one, using the administrator user interface.

To unrelate a device to a group:

- 
- Step 1** From the Manage Devices page, locate the device which you want to unrelate from a group.
- Step 2** Check the check box corresponding to the device Identifier, and click the **Unrelate** button.  
The Unrelate Device from Group page appears.
- Step 3** From the list of defined Group(s), select the group(s) from which you want to unrelate the device.



---

**Note** To select multiple groups from the Group list, press **Control** or **Shift**.

---

- Step 4** Click **Submit**.  
The Manage Devices page appears.
- 

### Searching Devices in a Group

To search for devices belonging to a particular group:

- 
- Step 1** From the Manage Devices page, select the Group Search option from the drop-down list under Search Type.  
The Group Name (Group Type) and the Device Identifier options appear.
- Step 2** From the Group Name (Group Type) drop-down list, select the Group Name of the devices that you want to search.
- Step 3** Enter a device ID in the Device Identifier field, or use a wildcard (\*).
- Step 4** Click **Search**.  
The devices related to the group appears.
- 

### Performing Operations on Devices

You can perform the following functions from the Device Operations page:

- **Reboot**—Enables you to reboot the device. This operation is primarily intended for diagnostic purposes.
- **Request Connection**—Instructs the device to establish a CWMP session with Cisco BAC.
- **Factory Reset**—Enables you to reset a preregistered device settings to its original factory settings.
- **Display Live Data**—Enables you to view live device parameter values.

You can choose the parameters that you want to view for this device operation by selecting from the options under the Parameter List File drop-down box. Each parameter list is an XML file that details the parameters each file will return; click the **View Details** icon to view the parameters.

You can also define the parameters that you want to be retrieved in parameter lists. Cisco BAC provides a sample list of live data templates which specify various parameters to be read during a view live data query.

- **Ping Diagnostic**—Enables you to perform an IP ping diagnostics test from the device to any host.

**Note**

---

For all of the above operations, if the device is not reachable, an error message appears.

---

- **Force Firmware Upgrade**—Enables you to force a device to update its firmware on next contact regardless of the MaintenanceWindow restrictions set in the firmware rules.
- **Force Configuration Synchronization**—Enables you to force an individual device to synchronize its configuration regardless of the current configuration version on the device.

**Note**

---

The operations forcing a firmware upgrade or a configuration synchronization take effect on the next device contact with the autoconfiguration server (ACS).

---

### Performing a Reboot

To reboot the device:

- 
- Step 1** From the **Devices > Manage Devices** page, locate the correct device.
- Step 2** Click the **Operations** icon () corresponding to the device.  
The Device Operations page appears.
- Step 3** From the drop-down list under Device Operation, select **Reboot**.
- Step 4** Click **Submit**.
- 

### Performing a Request Connection

To force the device to initiate a connection request:

- 
- Step 1** From the **Devices > Manage Devices** page, locate the correct device.
- Step 2** Click the **Operations** icon corresponding to the device.  
The Device Operations page appears.
- Step 3** From the drop-down list under Device Operation, select **Request Connection**.
- Step 4** Click **Submit**.
-

## Performing a Factory Reset

To reset device settings to its original factory settings:

- 
- Step 1** From the **Devices > Manage Devices** page, locate the correct device.
  - Step 2** Click the **Operations** icon corresponding to the device.  
The Device Operations page appears.
  - Step 3** From the drop-down list under Device Operation, select **Factory Reset**.
  - Step 4** Click **Submit**.
- 

## Displaying Live Data

To display parameters from a device:

- 
- Step 1** From the **Devices > Manage Devices** page, locate the correct device.
  - Step 2** Click the **Operations** icon corresponding to the device.  
The Device Operations page appears.
  - Step 3** From the drop-down list under Device Operation, select **Display Live Data**.
  - Step 4** Enter a duration in seconds for the operation to time out. The default timeout is 90 seconds.
  - Step 5** From the Parameter List File drop-down list, select the file, each of which is an XML file that details the parameters that are returned.
  - Step 6** Click on the **View Details** icon to view the parameters.



---

**Note** You can also view these sample templates under the **Configuration > Files** tabs. From the View Files page, select the Parameter List option under the File Type drop-down list. Click **Search**. A list of sample parameter list files appears.

---

- Step 7** Click **Submit**.



---

**Note** If the device is not reachable, an error message appears.

---

## Performing a Ping Diagnostic

To perform a ping operation to a device by using its IP address:

- 
- Step 1** From the **Devices > Manage Devices** page, locate the correct device.
  - Step 2** Click the **Operations** icon corresponding to the device.  
The Device Operations page appears.
  - Step 3** From the drop-down list under Device Operation, select **Ping Diagnostic**.
  - Step 4** Enter values in the following fields:

- Device operation timeout (in seconds)—Specifies the duration after which the Ping operation times out.
- Name of the hostname to be pinged—Identifies the hostname of the CPE to be pinged.
- Interface—Identifies the WAN interface from which the Ping should originate on the CPE.
- Number of repetitions—Specifies the number of times the Ping operation should run.
- Time out—Specifies the timeout for the Ping packet.
- Data block size—Specifies the size of each Ping packet.
- DSCP—Specifies the DSCP value in each Ping packet.

**Step 5** Click **Submit**.

---

### Forcing a Firmware Upgrade

To force a firmware upgrade on a device on next contact and bypassing the MaintenanceWindow restrictions set in the firmware rules:

- Step 1** From the **Devices > Manage Devices** page, locate the device whose configuration you want to synchronize.
- Step 2** Click the **Operations** icon corresponding to the device.  
The Device Operations page appears.
- Step 3** From the drop-down list under Perform Device Operation, select **Force Firmware Upgrade**.
- Step 4** Click **Submit**.
- 

### Forcing a Configuration Synchronization

To force a device to synchronize its configuration on next contact with the DPE regardless of the current configuration version on the device:

- Step 1** From the **Devices > Manage Devices** page, locate the device whose configuration you want to synchronize.
- Step 2** Click the **Operations** icon corresponding to the device.  
The Device Operations page appears.
- Step 3** From the drop-down list under Perform Device Operation, select **Force Configuration Synchronization**.
- Step 4** Click **Submit**.  
The device configuration is synchronized with the DPE.
-

## Setting Device Operations Timeout

You can set the duration within which an operation is to be executed on device. After that period, the operation times out.

**Note**

In addition to the procedure described in this section, you can set the default timeout duration in the Device Operation Timeout field using **Configuration > Defaults > CWMP Defaults**.

To set the timeout value for a device operation:

- 
- Step 1** From the **Devices > Manage Devices** page, locate the correct device.
  - Step 2** Click the **Operations** icon corresponding to the device.  
The Device Operations page appears.
  - Step 3** From the drop-down list under Device Operation, select the operation you want to perform.
  - Step 4** Enter a value (in seconds) in the Device Operation Timeout field. The default value for a device operation to time out is 90 seconds.
  - Step 5** Click **Submit**.
- 

## Group Management

Group management allows the creation, modification, and deletion of groups and group types.



**Note**

Group priorities in the property hierarchy (see [Property Hierarchy, page 4-4](#)) are handled through group types.

## Managing Group Types

Access the Manage Groups page (shown in [Figure 16-4](#)) by selecting Groups from either the main menu or the primary menu bar. Group Type is the default setting when this page appears.

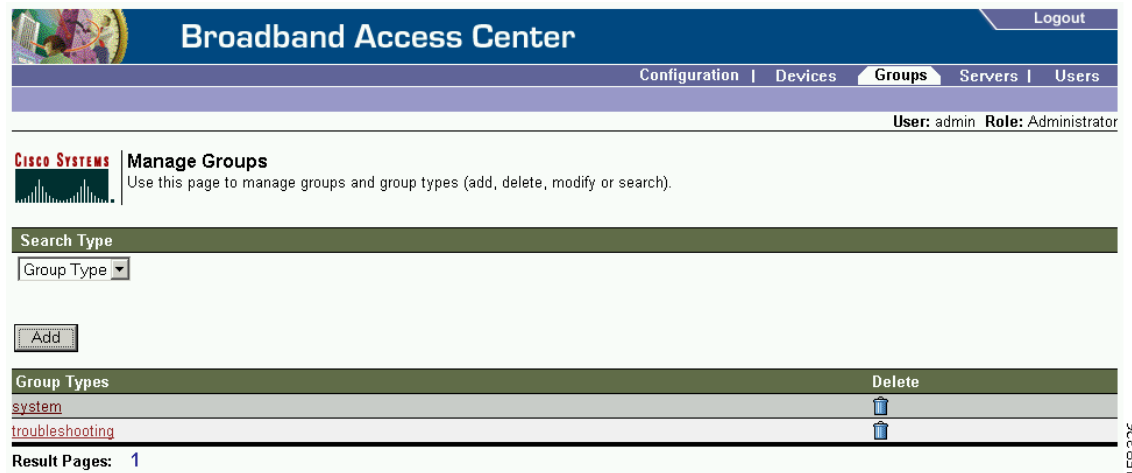
Figure 16-4 Manage Groups Page



156326

## Adding a Group Type

To add a new group type:

- Step 1** Click the **Groups** tab to open the Manage Groups page.
- Step 2** Change the **Search Type** to Group Type.
- Step 3** Click **Add** to open the Add Group Type page. (See [Figure 16-5](#).)

Figure 16-5 Add Group Type Page

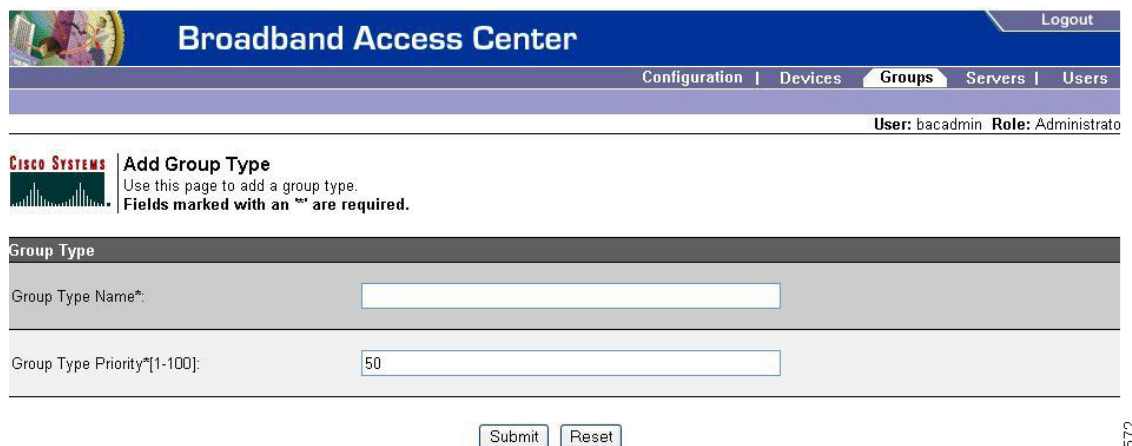

251672

- Step 4** Enter a name for the group type.
- Step 5** Enter the priority value for the group type.

The value can range from 1 through 100, with 1 as the highest priority. For example, if the priority values of two member groups are 5 and 20, respectively, then the group with priority value 5 has more priority than the group with priority value 20.

The Group Type Priority is, by default, set to 50.

If two member groups have the same priority value, the group type names are sorted in alphabetical order to decide the priority. If this results in two member groups with the same priority, they are sorted based on the group names.

**Step 6** Click **Submit**.

The new group type is recorded in the RDU, and the new group type appears on the Manage Group Types page.

---

## Modifying Group Types

To modify group type priority:

---

**Step 1** Click the **Groups** tab to open the Manage Groups page.

**Step 2** Change the **Search Type** to Group Type.

**Step 3** Click the name of the group type to open the Modify Group Type page.

**Step 4** Make the necessary changes to the Group Type Priority.

**Step 5** Click **Submit**.

The Manage Groups page appears with the modified description.

---

## Deleting Group Types

To delete group types:

---

**Step 1** Click the **Groups** tab to open the Manage Groups page

**Step 2** Locate the correct group type and click the **Delete** icon () corresponding to it.

**Step 3** In the Delete Group Type dialog box, click **OK** to delete the selected group type, or **Cancel** to return to the previous page.

The Manage Groups page appears without the deleted Group Type.

---

## Managing Groups

You can create and modify groups, and delete unwanted groups.

### Adding a New Group

To add a new group:

---

**Step 1** Select **Group** from the drop-down list on the Manage Groups page.

**Step 2** Click **Add**.

The Add Group page appears (shown in [Figure 16-6](#)).



Figure 16-6 Add Group Page

**Step 3** Enter the name for the new group.

Group name can contain alphanumeric characters and other characters such as, underscore (\_), hyphen (-), period (.), colon (:), and at sign (@) characters. The group name is validated against these characters. If the group name contains characters other than these, Add Group operation fails.

**Step 4** Select the appropriate Group Type from the drop-down list.

**Step 5** In addition to the above fields, you can optionally add new values for existing property name/value pairs.

- **Property Name** - Identifies the name of the custom or built-in device property.
- **Property Value** - Identifies the value of the property.

To add the property, click **Add**

**Step 6** Click **Submit** to add the device, or **Reset** to clear all fields.

## Modifying a Group

To modify group properties:

**Step 1** Select **Group** from the drop-down list on the Manage Groups page.

**Step 2** Select the group that needs to be modified from the group list.

The Modify Group page appears.

**Step 3** Make the necessary changes and Click **Submit**.

The Manage Group page appears with the appropriately modified description.

## Deleting Groups

You can delete any group that appears in the Manage Groups page by checking the box corresponding to the correct group and clicking the **Delete** button.

## Relating/Unrelating Groups to Groups

The relate and unrelate functions are used to establish a relationship between group objects. To either relate or unrelate this relationship:

- 
- Step 1** Click **Relate** or **Unrelate**, as desired, for the selected group.  
The Relate Group or the Unrelate Group page appears.
- Step 2** Select the appropriate Group Type from the drop-down list and select the group to which the node will be related/unrelated.
- Step 3** Click **Submit**.  
The Manage Groups page appears.
- 

## Viewing Group Details

To view details of a group:

- 
- Step 1** From the Manage Groups page, select the Group option from the Search Type drop-down list.
- Step 2** Select the correct Group Type and enter the Group or Group wildcard in the appropriate field.
- Step 3** Click **Search**.
- Step 4** Click the link corresponding to the Group whose details you want to view.  
The Modify Group page appears, with details of the Group Name and Group Type.
- 

## Viewing Servers

This section describes the Cisco BAC server pages:

- [Viewing Device Provisioning Engines, page 16-22](#)
- [Viewing Provisioning Groups, page 16-26](#)
- [Viewing Regional Distribution Unit Details, page 16-27](#)

## Viewing Device Provisioning Engines

The Manage Device Provisioning Engines page lets you monitor the list of all DPEs currently registered with the Cisco BAC database. Each DPE name displayed on this page is a link to another page that shows the details for that DPE. Click this link to display the details page, which is similar to [Figure 16-7](#).



### Note

The RDU determines the names of the DPEs by performing a reverse DNS lookup on the DPE interfaces through which the DPE contacts the RDU.

---

Figure 16-7 View Device Provisioning Engine Details Page

**Broadband Access Center** Logout

Configuration | Devices | Groups | **Servers** | Users

**DPEs** | NRs | Provisioning Groups | RDU

User: bacadmin Role: Administrator

---

**CISCO SYSTEMS** | **View Device Provisioning Engines Details**  
 Use this page to view the current values for the device provisioning engine that you selected.

Device Provisioning Engine Details	
Host Name:	bacdev1-t5120-2-d5.cisco.com
Port:	49186
IP Address:	10.81.88.83
Primary Provisioning Group(s):	<a href="#">prov1</a>
Properties:	/provgroup/discovered/acsUrl=http://bacdev1-t5120-2-d5.cisco.com:7547/acs,/dpe/pgCommunicationIp=10.81.88.83
Version:	BAC 3.6BETA3 (test-build)
UpTime:	13 day(s) 18 hour(s) 59 min(s) 44 sec(s)
State:	Ready
Device with Faults:	0
Log Files	
DPE Log File	<a href="#">63</a>
Files:	1
Number Of Devices:	1
CWMP Statistics	
Sessions succeeded:	0
Sessions failed:	0
File Requests succeeded:	0
File Requests failed:	0
Immediate Device Operations succeeded:	0
Immediate Device Operations failed:	0
Home PG Redirection Statistics	
Succeeded:	0
Failed:	0

Table 16-3 identifies the fields and buttons shown in Figure 16-7.

Table 16-3 View Device Provisioning Engine Details Page

Field or Button	Description
<b>Device Provisioning Engine Details</b>	
Host Name	Identifies the DPE hostname.
Port	Identifies the DPE port number from which DPE established connection to the RDU.
IP Address	Identifies the IP address of the DPE.
Primary Provisioning Group(s)	Identifies the primary provisioning group that the selected DPE belongs to. This is an active link that, if clicked, displays the Provisioning Group Details page for that provisioning group.
Properties	Identifies which properties have been configured for this DPE.
Version	Identifies the version of DPE software currently in use.
UpTime	Specifies the total time that the DPE has been operational since its last start-up.

282575

**Table 16-3 View Device Provisioning Engine Details Page (continued)**

Field or Button	Description
State	Identifies whether the DPE is ready for operations. These states include: <ul style="list-style-type: none"> <li>• Registering</li> <li>• Initializing</li> <li>• Synchronizing</li> <li>• Populating</li> <li>• Ready</li> <li>• Offline</li> </ul> If this field reads Offline, the options from the Uptime field onwards do not appear. The DPE is prepared to service client requests in any state except Offline.
Device with Faults	Displays number of devices with faults at this DPE. If number is greater than zero, features the View Details icon which if clicked, displays details of devices with faults.
<b>Log Files</b>	
DPE Log File	Features the View Details icon that if clicked displays the View Log File Contents page, which provides details of <i>dpe.log</i> .
Files	Identifies the number of files, such as firmware images, that are cached at the DPE.
Number of Devices	Identifies the number of CWMP devices for which the DPE maintains instructions. In a fully synchronized DPE, this number should equal the number of CWMP devices in the DPE's provisioning group.
<b>CWMP Statistics</b>	
<b>Note</b> This section displays statistics from the last time the DPE was started.	
Sessions succeeded	Identifies the number of successful CWMP sessions.
Sessions failed	Identifies the number of failed CWMP sessions.
File Requests Succeeded	Identifies the number of successful firmware file download requests.
File Requests Failed	Identifies the number of failed firmware file download requests.
Immediate Device Operations Succeeded	Identifies the number of immediate device operations that succeeded.
Immediate Device Operations failed	Identifies the number of immediate device operations that failed.
<b>Home PG Redirection Statistics</b>	
Succeeded	Identifies the number of successful home provisioning group redirections.
Failed	Identifies the number of failed home provisioning group redirections.

## Viewing Network Registrar Extension Point Details

The NRs option, from the Servers menu, displays the current values for the network registrar extension points. Figure 16-8 illustrates a sample NR details page.

**Figure 16-8** View Network Registrar Extension Point Details Page

The screenshot shows the 'Broadband Access Center' administrator interface. The top navigation bar includes 'Logout', 'Configuration', 'Devices', 'Groups', 'Servers', and 'Users'. Below this, there are sub-menus for 'DPEs', 'NRs', 'Provisioning Groups', and 'RDU'. The user is identified as 'bacadmin' with the role of 'Administrator'. The main content area is titled 'View Network Registrar Extension Point Details' and includes a sub-header 'View this page to view the current values for the Network Registrar extension point that you selected.' Below this is a table with the following data:

Network Registrar Extension Point Details	
Host Name:	bacdev1-t5120-2-d5.cisco.com
IP Address:	10.81.88.83
Provisioning Group:	<a href="#">prov1</a>
Properties:	
Version:	BAC 3.6BETA2 (SOL_BAC3_6_20110410_2101_174)
UpTime:	1 hour(s) 43 min(s) 16 sec(s)
State:	Ready

Table 16-4 identifies the fields and buttons shown in Figure 16-8.

**Table 16-4** View Network Registrar Details Page

Field or Button	Description
<b>Network Registrar Details</b>	
Host Name	Identifies the hostname of the system that is running the regional distribution unit.
IP Address	Identifies the IP address assigned to the NR.
Provisioning Group	Identifies the primary provisioning group that the selected NR belongs to. This is an active link that, if clicked, displays the Provisioning Group Details page for that provisioning group
Properties	Identifies properties configured for the NR.
Version	Specifies the version of NR software currently in use.
UpTime	Specifies the total time that the NR has been operational since its last period of downtime.
State	Identifies whether the NR is ready to respond to requests. The only state that is featured using the administrator user interface is Ready.

## Viewing Provisioning Groups

The Manage Provisioning Groups page lets you monitor all current provisioning groups. Each provisioning group appearing in this list is a link to its own details page. Click this link to display the details page, which is similar to [Figure 16-9](#).

**Figure 16-9** View Provisioning Group Details Page

**Broadband Access Center** Logout

Configuration | Devices | Groups | **Servers** | Users

DPEs | NRs | **Provisioning Groups** | RDU

User: bacadmin Role: Administrator

---

**CISCO SYSTEMS** **View Provisioning Group Details**  
Use this page to view the current values for the provisioning group that you selected.

Provisioning Group Details	
Name:	prov2
Primary Device Provisioning Engine(s):	bacdev3-t5240-1-d6.cisco.com 0 devices with fault
Network Registrar Extension Point(s):	

Provisioning Group Properties	
Discovered ACS URL:	http://bacdev3-t5240-1-d6.cisco.com:7547/acs
LeaseQuery Servers V4:	10.81.88.83, 10.81.88.137
ACS URL (Overrides Discovered ACS URL):	<input type="text" value="http://teat7547/acs"/>

[Table 16-5](#) identifies the fields and buttons shown in [Figure 16-9](#). The fields described in [Table 16-5](#) may include active links that, if clicked, display the appropriate details page.

**Table 16-5** View Provisioning Groups Details Page

Field or Button	Description
<b>Provisioning Group Details</b>	
Name	Identifies the provisioning group name selected from the List Provisioning Groups page.
Primary Device Provisioning Engine(s)	Identifies the hostnames of the DPEs that are primary for this provisioning group.
<b>Provisioning Group Properties</b>	
Discovered ACS URL	Identifies the DPE URL through which the provisioning group connects to the DPE. Discovered URL is based on DPE interface configured for provisioning operations using the DPE CLI.  The parameters is based on registration information from the DPE which registered last with the RDU. This URL is used for operations such as redirection of CPE to a different provisioning group.
LeaseQuery Servers V4	The list of Cisco Network Registrar servers that are registered for this provisioning group.

**Table 16-5** View Provisioning Groups Details Page (continued)

Field or Button	Description
ACS URL (Overrides Discovered ACS URL)	Identifies the configured URL of the Cisco BAC server associated with each provisioning group. This URL is used by devices to contact the DPEs in a given provisioning group, and is used for operations such as redirection of CPE to a different provisioning group.
Submit	Activates or implements the changes you have made.
Reset	Returns all settings to their previous settings.

## Viewing Regional Distribution Unit Details

The RDU option, from the Servers menu, displays details of the RDU. [Figure 16-10](#) illustrates a sample RDU details page.

**Figure 16-10** View Regional Distribution Unit Details Page

The screenshot shows the Broadband Access Center interface. The top navigation bar includes 'Logout', 'Configuration', 'Devices', 'Groups', 'Servers', and 'Users'. The 'Servers' menu is expanded, showing 'DPEs', 'NRs', 'Provisioning Groups', and 'RDU'. The user is identified as 'User: bacadmin Role: Administrator'.

The main content area is titled 'View Regional Distribution Unit Details' and includes the instruction: 'Use this page to view the current values for the regional distribution unit that you selected.'

Regional Distribution Unit Details		
Host Name:	bacdev1-t5120-2-d5.cisco.com	
Port:	49187	
IP Address:	10.81.88.83	
Properties:		
Version:	BAC 3.6BETA3 (test-build)	
UpTime:	13 day(s) 20 hour(s) 11 min(s) 13 sec(s)	
State:	Ready	
PACE Statistics		
Batches Processed:	1762	
Batches Succeeded:	1761	
Batches Dropped:	0	
Batches Failed:	1	
Average Processing Time:	21 ms	
Average Batch Processing Time:	24 ms	
IGS		
State:	IDLE	
Requests Processed:	16	
Log Files		
RDU Log File		
Audit Log File		
Device Statistics		
Number of CWMP Devices:	3	
Device Faults Statistics		
	RDU	All DPEs
Devices with Faults in Last 1 Hour(s):	0	0
Devices with Faults in Last 3 Hour(s):	0	0
Devices with Faults in Last 12 Hour(s):	0	0
Devices with Faults in Last 72 Hour(s):	0	0

[Table 16-6](#) identifies the fields and buttons shown in [Figure 16-10](#).

282577

**Table 16-6** View RDU Details Page

Field or Button	Description
<b>Regional Distribution Unit Details</b>	
Host Name	Identifies the host name of the system that is running the regional distribution unit.
Port	Identifies the RDU listening port number for connections from the DPEs. The default port number is 49187, but a different port can be selected during installation of the RDU.
IP Address	Identifies the IP address assigned to the RDU.
Properties	Identifies properties configured for the RDU.
Version	Specifies the version of RDU software currently in use.
UpTime	Specifies the total time that the RDU has been operational since its last period of downtime.
State	Identifies whether the RDU is ready to respond to requests. The only state that is featured using the administrator user interface is Ready.
<b>PACE Statistics</b>	
Batches Processed	Identifies how many individual batches have been processed since the last RDU start-up.
Batches Succeeded	Identifies how many individual batches have been successfully processed since the last RDU start-up.
Batches Dropped	Identifies how many batches have been dropped since the last RDU start-up.
Batches Failed	Identifies how many batches have failed processing since the last RDU start-up.
Average Processing Time	Identifies the average time, in milliseconds, that it takes to process the batch excluding the time it spends in the queue if RDU is too busy.
Average Batch Processing Time	Identifies the average time, in milliseconds, that it takes to process the batch including the time it spends in the queue if RDU is too busy.
<b>IGS</b>	
This is the Instruction Generation Service.	
State	Identifies the operational state of the instruction generation service. This could be: <ul style="list-style-type: none"> <li>• Idle—Specifies that the IGS is not processing regeneration requests.</li> <li>• Regeneration—Specifies that the IGS is processing regeneration requests.</li> <li>• Waiting Regeneration—Specifies that the IGS is unable to regenerate instructions for a device. When the IGS is stuck in this state, consult the rdu.log for details.</li> </ul>
Requests Processed	Identifies the number of instruction generation requests processed since last RDU start-up.
Elapsed Time	Identifies, in seconds, the time elapsed since the start of regeneration.
Devices Regenerated	Identifies the number of device instructions regenerated since the regeneration process started.



**Table 16-6 View RDU Details Page (continued)**

<b>Field or Button</b>	<b>Description</b>
Regeneration rate	Identifies the cumulative rate of device instructions regenerated since the regeneration process started.
Requests pending	Identifies the number of regeneration requests in queue.
<b>Log Files</b>	
RDU Log File	Features the View Details icon, that, if clicked, displays the View Log File Contents page, which provides details of the rdu.log file.
Audit Log File	Features the View Details icon, that, if clicked, displays the View Log File Contents page, which provides details of the audit.log file.
<b>Device Statistics</b>	
Number of CWMP Devices	Identifies the number of devices in the RDU database.
<b>Device Faults Statistics</b>	
Devices with Faults in Last 1 Hour(s)	Identifies the number of devices with faults over the last one hour, at both the RDU and the DPEs.
Devices with Faults in Last 3 Hour(s)	Identifies the number of devices with faults over the last three hours, at both the RDU and the DPEs.
Devices with Faults in Last 12 Hour(s)	Identifies the number of devices with faults over the last 12 hours, at both the RDU and the DPEs.
Devices with Faults in Last 72 Hour(s)	Identifies the number of devices with faults over the last 72 hours, at both the RDU and the DPEs.





# CHAPTER 17

## Configuring Broadband Access Center

This chapter describes the Cisco Broadband Access Center (BAC) configuration tasks that you perform by selecting the options in the Configuration menu.

This chapter includes the following sections:

- [Configuring the Class of Service, page 17-1](#)
- [Configuring Custom Properties, page 17-5](#)
- [Configuring Defaults, page 17-6](#)
- [Managing Files, page 17-15](#)
- [Managing License Keys, page 17-20](#)
- [Managing RDU Extensions, page 17-23](#)
- [Publishing Provisioning Data, page 17-26](#)

## Configuring the Class of Service

By using the Cisco BAC administrator user interface, you can configure the Classes of Service offered to your customers. You can use the administrator user interface to add, modify, view, or delete any selected Class of Service. Start with the Manage Class of Service page, as shown in [Figure 17-1](#).

**Figure 17-1** Manage Class of Service Page

The screenshot shows the Cisco Broadband Access Center administrator interface. The top navigation bar includes 'Logout' and a menu with 'Configuration', 'Devices', 'Groups', 'Servers', and 'Users'. The 'Configuration' menu is expanded to show 'Class of Service', 'Custom Property', 'Defaults', 'Files', 'License Keys', and 'Publishing'. The 'Class of Service' page is titled 'Manage Class of Service' and includes a description: 'Use this page to manage (add, modify or delete) a class of service.' Below this, there is a 'Class of Service' dropdown menu set to 'CWMP' and an 'Add' button. A table lists existing classes of service with delete icons:

Class of Service	Delete
<a href="#">sample-bronze-cwmp</a>	
<a href="#">sample-gold-cwmp</a>	
<a href="#">unprovisioned-cwmp</a>	

Result Pages: 1

158332

Table 17-1 identifies the fields and buttons shown in Figure 17-1.

**Table 17-1** *Manage Class of Service Page*

Field or Button	Description
<b>Class of Service</b>	
Class of Service	A drop-down list that identifies the technology classes of service that you can search for. Available selections, as they appear on screen, include: <ul style="list-style-type: none"> <li>• CWMP.</li> </ul> <b>Note</b> For additional information on these areas of technology, see <a href="#">Configuring Defaults, page 17-6</a> .
<b>Add</b>	Lets you add a new Class of Service.
<b>Class of Service</b>	
Class of Service list	Displays the names of Class of Service objects.
<b>Delete</b>	Lets you delete selected Classes of Service.

Table 17-2 identifies the fields and buttons shown in the Add Class of Service page.

**Table 17-2** *Add Class of Service Page*

Field or Button	Description
<b>Class of Service Name and Type</b>	
Class of Service Name	Lets you enter the name of the new Class of Service.
Class of Service Type	A drop-down list that identifies the types of Classes of Service that you can select.
Configuration Template File	A drop-down list that identifies the configuration template file that you associate with a Class of Service.
Firmware Rule File	A drop-down list that identifies the firmware rules file that you associate with a Class of Service.
<b>Property Name/Value</b>	
Property Name	Specifies the appropriate property. You can select the correct property from the drop-down list.
Property Value	Specifies the value for the property name. You can select the correct value from the drop-down list.
<b>Add</b>	Adds the new Property Name:Property Value pair to create the new Class of Service.
<b>Submit</b>	Activates or implements the changes you have made.
<b>Reset</b>	Returns all settings to their previous settings.

## Adding a Class of Service

To add a specific Class of Service:

- 
- Step 1** Choose **Configuration** on the Primary Navigation bar.
- Step 2** Choose **Class of Service** from the Secondary Navigation bar.
- Step 3** Click **Add**.
- The Add Class of Service page appears. This page identifies the various settings for the selected Class of Service.
- Step 4** Enter the name of your new class of service.
- For example, assume that you want to create a new Class of Service called Gold-Classic for CWMP. You might enter **provisioned-cwmp** as the Class of Service Name, and choose CWMP from the service type drop-down list.
- Step 5** Choose a Configuration Template File. For example, choose sample-cwmp-config.xml from the configuration file template drop-down list.
- Step 6** Choose also a Firmware Rule File. For example, choose sample-cwmp-firmware-rules.xml from the firmware rule file drop-down list.
- Step 7** Enter a Property Name and Property Value in the appropriate fields. This lets you configure standard or custom properties for this class of service object.
- For example, choose as property name /IPDevice/connectionRequestMethod. Choose Discovered from the Property Value drop-down list and then continue with the rest of this procedure.
-  **Note** The API constant for /IPDevice/connectionRequestMethod is `IPDeviceKeys.CONNECTION_REQUEST_METHOD`.
- Multiple Property Name:Property Value pairs could appear on this page. You use the **Delete** button to remove any unwanted pairs from the class of service.
- 
- Step 8** Click **Add** to add the property to the defining Class of Service.
- Step 9** Click **Submit** to finalize the process or **Reset** to return all fields to their previous setting.
- After submitting the Class of Service, the Manage Class of Service page appears to show the newly added Class of Service.
- 

## Modifying a Class of Service

You can modify the Classes of Service by selecting the various properties and assigning appropriate property values. When creating a Class of Service for the first time you select all of the appropriate properties and assign values to them.

If you make a mistake, or your business requirements for a certain Class of Service change, you can either change the property value before submitting your previous changes or delete the Property Name:Property Value pair altogether.

**Note**

Changes to the Class of Service object trigger the Instruction Generation Service (IGS) to regenerate instructions for all affected devices and send instructions to the DPEs. IGS does this task as a background job. The status of the IGS can be observed using the View RDU Details page.

To add, delete, or modify Class of Service properties:

- Step 1** Choose **Configuration** on the Primary Navigation bar.
- Step 2** Choose **Class of Service** from the Secondary Navigation bar.
- Step 3** Choose the Class of Service to be modified.
- Step 4** Click the link corresponding to the correct Class of Service.

The Modify Class of Service page appears; note that the selected Class of Service name and type appear below the page description.

- To add a new property to the selected Class of Service:
  - Select the first property that you want assigned to the selected Class of Service, from the Property Name drop-down and then, after choosing the appropriate value for that property, click **Add**.
  - Repeat for any other properties you want to assign to the selected Class of Service.
- To delete a property for the selected Class of Service:
  - Locate the unwanted property in the list immediately above the Property Name drop-down.
  - Click the **Delete** button.
- To modify the value currently assigned to a property:
  - Delete the appropriate property as described above.
  - Add the same property back to the Class of Service while entering the new Property Value.

**Note**

If you delete a property that is required for your business process, you must add it back, and select the appropriate value, before you submit the change.

- Step 5** Click **Submit** to make the modifications to the class of service.

Each property added to a Class of Service, appears when you click **Submit**. After doing so, a confirmation page appears to regenerate the instructions for the devices with the selected Class of Service.

- Step 6** Click **OK**.

The modified Class of Service will be available in the Manage Class of Service page.

## Deleting a Class of Service

You can delete any existing Class of Service but, before you attempt to do so, you must ensure that there are no devices associated with that Class of Service.

**Tip**

Where there are large numbers of devices associated with a Class of Service to be deleted, use the Cisco BAC application programmers interface (API) to write a program to iterate through these devices to reassign another Class of Service to the devices.

To delete a Class of Service:

- Step 1** Choose **Configuration** on the Primary Navigation bar.
- Step 2** Choose **Class of Service** from the Secondary Navigation bar.
- Step 3** Click the **Delete** icon () for the correct Class of Service, and a confirmation dialog box appears.

**Note**

A Class of Service cannot be deleted if devices are associated with it or, if it is designated as the default Class of Service. Therefore, you cannot delete the **unprovisioned-cwmp** Class of Service object.

- Step 4** Click **OK** to delete the file, or **Cancel** to return to the Manage Class of Service page. (See [Figure 17-1](#).)

If you try to delete a Class of Service with devices associated with it, this error message is displayed:

```
The following error(s) occurred while processing your request.  
Error: Class Of Service [sample-COS] has devices associated with it, unable to delete  
  
Please correct the error(s) and resubmit your request.
```

The specific Class of Service is specified within the error message. In this example this is represented by *sample-COS*.

## Configuring Custom Properties

Custom properties let you specify additional customizable device information to be stored in the RDU database. The Custom Property configuration page is found under the Configuration menu, and you use this page to add or delete custom properties.

**Caution**

Although you can delete custom properties if they are currently in use, doing so could cause extreme difficulty to other areas where the properties are in use.

After the custom property is defined, you can use it in this property hierarchy. See [Authoring Configuration Templates, page 5-14](#), for how to use the property hierarchy. Properties can be configured on the following objects for use in the property hierarchy:

- Device
- Group
- Provisioning Group
- Class of Service

- Device Type
- System defaults

Group priorities in the property hierarchy (see [Property Hierarchy, page 4-4](#)) are handled through group types.

---

**Step 1** Choose **Configuration** on the Primary Navigation bar.

**Step 2** Choose **Custom Property** on the Secondary Navigation bar,

The Manage Cisco BAC Custom Properties page appears.

- To add a custom property:
  - Click **Add** on the Manage Cisco BAC Custom Properties page,  
The Add Custom Property page appears.
  - Enter the name of the new custom property.
  - Choose a custom property value type from the drop-down list.
  - Click **Submit** when complete.

After the property has been added to the administrative database, the Manage Cisco BAC Custom Properties page appears.

- To delete a custom property:
    - Identify the custom property to be deleted from the Manage Cisco BAC Custom Properties page.
    - Click the **Delete** icon corresponding to the correct custom property,  
The custom properties deletion dialog box appears.
    - Click **OK** to delete the custom property.
- 

## Configuring Defaults

The Defaults page, found under the Configuration option, lets you access the default settings for the overall system, including the Regional Distribution Unit (RDU), and the CWMP technology.

## Selecting Configuration Options

The procedure for configuring specific default types is identical. Complete this procedure to access the desired defaults page and then refer to the appropriate section within this chapter for a description of the various page components.

---

**Step 1** Choose **Configuration** on either the Primary Navigation bar or Main Menu page.

**Step 2** Choose **Defaults** from the Secondary Navigation bar.

The Configure Defaults page appears.



- Step 3** Choose the correct default type from the list to the left of the screen.  
The appropriate defaults page appears.

## CWMP Defaults

The CWMP Defaults page (Figure 17-2) displays a list of CWMP technology configuration settings.

**Figure 17-2** Configure CWMP Defaults Page

STUN Server Port:	<input type="text" value="3478"/>
STUN HTTP Server Port:	<input type="text" value="8000"/>
STUN HTTP Server User Name:	<input type="text" value="bacadmin"/>
STUN HTTP Server Password:	<input type="password" value="....."/>
SOAP Request Sender Extension:	<input type="text"/>
SOAP Response Sender Extension:	<input type="text"/>
Incoming Event Viewer Extension:	<input type="text"/>
Outgoing Event Viewer Extension:	<input type="text"/>
SOAP Request Sender Extension for Unknown Devices:	<input type="text"/>
SOAP Response Sender Extension for Unknown Devices:	<input type="text"/>

302575

Table 17-3 describes all fields and buttons appearing in Figure 17-2.

**Table 17-3** Configure CWMP Defaults Page

Field or Button	Description
Configuration Generation Extension Point	Identifies the common extension points executed before any other technology extension point is executed.
Activation Extension Point	Identifies the extension point that activates a device.
Service Level Extension Point	Identifies the extension point that determines what Class of Service to use for configuration generation and returns that information to the RDU.

**Table 17-3** *Configure CWMP Defaults Page (continued)*

<b>Field or Button</b>	<b>Description</b>
Default Class of Service	Changes to the default Class of Service cause regeneration of instructions for all devices associated with the default Class of Service.  The Instruction Generation Service (IGS) performs automatic regeneration of instructions and distributes them to appropriate DPEs. Any other changes made to this page do not affect the current devices.
Connection Request Method	Identifies the method in which Cisco BAC attempts to perform a connection request. You can choose to disable this feature by selecting the Disabled option, or choose from: <ul style="list-style-type: none"> <li>• Discovered</li> <li>• Use FQDN</li> <li>• Use IP</li> <li>• LeaseQuery</li> <li>• Annex G</li> <li>• Use CMHS</li> </ul> The selected method dictates how Cisco BAC determines the connection request URL to be used to contact the device.
Connection Request Path	Specifies the URL path based on the device IP address, using which the DPE constructs the Connection Request URL.
Connection Request Port	Specifies the device port number, using which the DPE constructs the Connection Request URL.
Device Operation Timeout	Specifies, in seconds, the time after which an operation on a device times out
Custom Discover Parameters	Specifies the custom parameter(s) in comma-separated format that are to be discovered from the device.
Custom Firmware Changed Parameters	Specifies custom parameters that are to be checked if the device reported a new firmware version.
Connection Request Master Secret	Specifies the value that is used along with the device identifier to generate a connection request password for a device, if autogeneration of connection request password is enabled.
Signature Key Name	Specifies the name of the key that is used by the gateway to look up the shared secret key. You must change the signature key name when the signature secret is changed.
Signature Validity	Specifies the number of seconds for which the signature is considered valid, following the signature timestamp. The default value is 3600.
Signature Secret	Specifies the secret that is used to compute the signature.
Secondary Device ID CPE Parameter	Specifies the IMEI number of the device which is used as the secondary device ID. It is stored in the device record in the RDU.
CMHS Server List Custom Property	Specifies the CMHS custom property name. It is not a predefined and must be specified.
Use Source Address For Connection Request	Check this box if you want to configure Cisco BAC to use the same source IP reported by the device.

**Table 17-3** *Configure CWMP Defaults Page (continued)*

<b>Field or Button</b>	<b>Description</b>
STUN Enabled	Check this box if you want the STUN server to be enabled for the device.
STUN Server Address	Specifies the STUN server address.
STUN Server Port	Specifies the STUN server port.
STUN HTTP Server Port	Specifies the STUN server HTTP port.
STUN HTTP Server User Name	Specifies the STUN server HTTP user name.
STUN HTTP Server Password	Specifies the STUN server HTTP password
SOAP Request Sender Extension	Specifies the script to be executed when the CPE sends a request to the DPE
SOAP Response Sender Extension	Specifies the script to be executed when the DPE sends a response to the CPE.
Incoming Event Viewer Extension	Specifies the script to be executed when the DPE receives an event of existing configuration from the CPE.
Outgoing Event Viewer Extension	Specifies the script to be executed when the DPE sends an event of required configuration to the CPE.
SOAP Request Sender Extension for Unknown Devices	Specifies the script to be executed when the unknown device sends a request to the DPE.
Soap Response Sender Extension for Unknown Devices	Specifies the script to be executed when the DPE sends response to the unknown device.
<b>Submit</b>	Activates or implements the changes you have made.
<b>Reset</b>	Returns all settings to their previous settings.

## RDU Defaults

When you click the RDU defaults link, the RDU Defaults page (see [Figure 17-3](#)) appears. Use this page to configure settings affecting RDU operations.

**Figure 17-3** Configure RDU Defaults Page

[Table 17-4](#) describes all fields and buttons appearing in [Figure 17-3](#).

**Table 17-4** Configure RDU Defaults Page

Field or Button	Description
Configuration Extension Point	Identifies the configuration extension executed before any other technology extension is executed.
Device Detection Extension Point	Identifies the extension used to determine a device's type.
Publishing Extension Point	Identifies the extension to be used for an RDU publishing plug-in. This is useful when you need to publish RDU data to another database.
Extension Point Jar File Search Order	Specifies the sequence in which the classes are searched in the Jar files that are listed in the preceding four fields.
Allow Unknown CPE	Check this option if you wish to enable devices, that need to be provisioned but are not yet added to the RDU.
<b>Submit</b>	Activates or implements the changes you have made.
<b>Reset</b>	Returns all settings to their previous settings.



**Note**

See [Managing RDU Extensions, page 17-23](#), for related information on RDU extension points.

# System Defaults

When you click the Systems Defaults link, the System Defaults page (see [Figure 17-4](#)) appears.

**Figure 17-4 System Defaults Page**

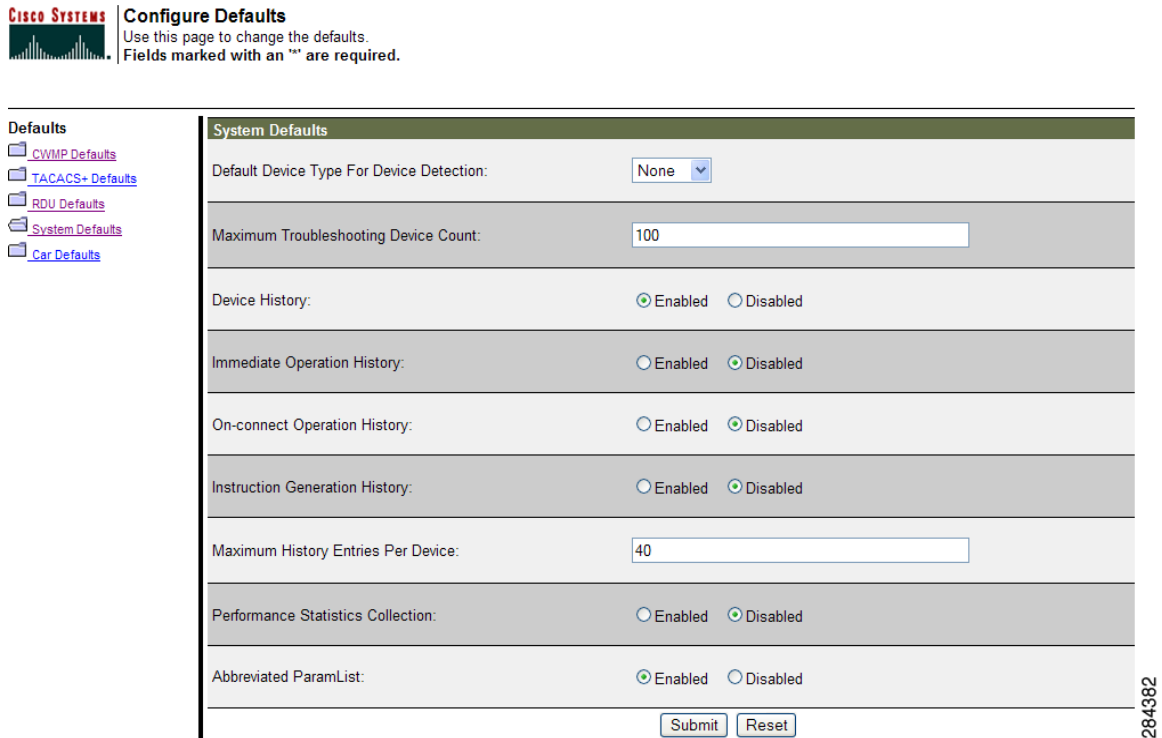

[Table 17-5](#) describes all fields and buttons appearing in [Figure 17-4](#).

**Table 17-5 Configure System Defaults Page**

Field or Button	Description
Default Device Type for Device Detection	<p>Identifies the default device type for a device not previously registered in the RDU. The options include:</p> <ul style="list-style-type: none"> <li>• CWMP</li> <li>• None</li> </ul> <p>If the device detection extension is unable to identify the device type, the “default type” (CWMP or None) specifies the device type. If you set the Default Device Type as None, the device record is not added to the RDU.</p> <p>Unregistered devices can request the RDU for configurations only if you have enabled the <b>service cwmp num allow-unknown-cpe</b> option from the DPE command line interface. Otherwise, a request from an unknown device is not forwarded to the RDU.</p>
Maximum Troubleshooting Device Count	<p>Identifies the maximum number of devices that you can troubleshoot at any one time. The default number is 100.</p>

**Table 17-5** *Configure System Defaults Page (continued)*

<b>Field or Button</b>	<b>Description</b>
Device History	Identifies if logging device record and device configurations is enabled or disabled.
Immediate Operation History	Identifies if logging of history of device operation initiated from the API using immediate mode is enabled or disabled.
On-Connect Operation History	Identifies if logging of history of device operation initiated from the API using on-connect mode is enabled or disabled.
Instruction Generation History	Identifies if logging the history of device instruction generation is enabled or disabled.
Maximum History Entries Per Device	Defines the maximum number of entries of device history that will be stored for each device. The default number of entries is 40.
Performance Statistics Collection	Determines if statistics collection is enabled. See <a href="#">Monitoring Performance Statistics, page 11-14</a> , on performance statistics.
Abbreviated ParamList	Enable this if you want to abbreviate the parameter names available in the configuration template. If enabled, parameter names are replaced with a dot (.).
<b>Submit</b>	Activates or implements the changes you have made.
<b>Reset</b>	Returns all settings to their previous settings.

## TACACS+ Defaults

When you click the TACACS+ Defaults link, the TACACS+ Defaults page appears.

**Figure 17-5** TACACS+ Defaults Page

Table 17-6 describes all fields and buttons appearing in Figure 17-5.

**Table 17-6** Configure TACACS+ Defaults Page

Field or Button	Description
TACACS+ Authentication	Allows you to enable or disable TACACS+ Authentication. TACACS+ Authentication is disabled by default.
TACACS+ Client Read/Write timeout	Specifies the duration that the TACACS+ client waits for a TACACS+ server to reply to TACACS+ protocol requests.  The range is from 1 to 300 seconds. The default is 5 seconds and applies to all TACACS+ servers
TACACS+ Client Maximum retries	Specifies the number of times the TACACS+ client attempts a valid TACACS+ protocol exchange with a TACACS+ server if it fails to respond to the initial request.  The range is from 0 to 10. The default is 1 and applies to all TACACS+ server defined

**Table 17-6** *Configure TACACS+ Defaults Page (continued)*

<b>Field or Button</b>	<b>Description</b>
TACACS Server 1	<p>Specifies the IP address or the hostname of the TACACS+ server that has the highest priority and serves as the first choice for the TACACS+ clients.</p> <p>When TACACS+ authentication is enabled, the client attempts user login authentication to each server sequentially in the list until a successful authentication exchange is achieved, or the list is exhausted.</p> <p>If the list is exhausted, the client automatically falls back to the local authentication mode.</p>
TACACS Server 1 Secret Key	Specifies the secret key used for encryption between the RDU and the TACACS+ server 1. The secret key is stored in the RDU database.
TACACS Server 2	Specifies the IP address or the hostname of the TACACS+ server that is queried by the TACACS+ client when the TACACS+ server 1 is unreachable.
TACACS Server 2 Secret Key	Specifies the secret key used for encryption between the RDU and the TACACS+ server 2.
TACACS Server 3	Specifies the IP address or the hostname of the TACACS+ server that is queried by the TACACS+ client when the TACACS+ server 1 and TACACS+ server 2 are unreachable.
TACACS Server 3 Secret Key	Specifies the secret key used for encryption between the RDU and the TACACS+ server 3.
TACACS Server 4	Specifies the IP address or the hostname of the TACACS+ server that is queried by the TACACS+ client when the TACACS+ server 1, TACACS+ server 2 and TACACS+ server 3 are unreachable.
TACACS Server 4 Secret Key	Specifies the secret key used for encryption between the RDU and the TACACS+ server 4.
TACACS Server 5	Specifies the IP address or the hostname of the TACACS+ server that is queried by the TACACS+ client when the TACACS+ server 1, TACACS+ server 2, TACACS+ server 3 and TACACS+ server 4 are unreachable.
TACACS Server 5 Secret Key	Specifies the secret key used for encryption between the RDU and the TACACS+ server 5.
<b>Submit</b>	Activates or implements the changes you have made.
<b>Reset</b>	Returns all settings to their previous settings.



If you remove one TACACS+ server and replace it with another server, the newly added server will have the same priority as the removed server.

To change the order of the TACACS+ servers in the priority list, remove all server addresses and re-enter them in the desired order.

## Managing Files

By using the Cisco BAC administrator user interface, you can manage the template files and the parameter dictionaries for dynamic generation for CWMP files, or software images for devices (see [Figure 17-6](#)). You can add, delete, replace, or export any file type, including:

- Configuration Template—These are XML files that contain CWMP configuration policy, including parameter value settings, Notification attributes and Access Control attributes. See [Authoring Configuration Templates, page 5-14](#), for additional information.
- Firmware File—These are images of device firmware, which can be downloaded to devices to upgrade their functionality. Cisco BAC treats this file type like any other binary file. See [Firmware Management, page 6-1](#), for additional information.
- Firmware Rules Template—These are XML files written according to a published schema document. Each firmware rules template contains one or more rules that trigger firmware updates based on specific conditions. See [Firmware Management, page 6-1](#), for additional information.
- JAR File—This file type is used to load Cisco BAC extensions.
- Parameter Dictionary—These are XML files that list valid objects and parameters used by Cisco BAC to configure a device. The dictionaries validate the objects and parameters used in the configuration and firmware rule templates. See [Parameter Dictionaries, page 7-1](#), for additional information.
- Parameter List—These XML files list a predefined set of parameters from the device that are retrieved every time the device contacts Cisco BAC.
- DPE Extension Script—These script files are main extension scripts having the main provisioning logic. For more information on extension scripts, see [Scripting Framework, page 18-1](#).
- Helper Script—These script files are utilities which can be used by multiple main extension scripts. The helper scripts are called from both the main extension scripts and other helper scripts.

**Note**

---

[Figure 17-6](#) is displayed after clicking the Search button on the Manage Files page.

---

Figure 17-6 Manage Files Page

**Broadband Access Center** Logout

[Configuration](#) | [Devices](#) | [Groups](#) | [Servers](#) | [Users](#)  
[Class of Service](#) | [Custom Property](#) | [Defaults](#) | **[Files](#)** | [License Keys](#) | [Publishing](#)

User: admin Role: Administrator

**CISCO SYSTEMS View Files**  
Use this page to view a file.

File Type:  File Name:  Page Size:

Files	View	File Type	Export
<input type="checkbox"/> sample-cwmp-config.xml		Configuration Template	
<input type="checkbox"/> sample-cwmp-firmware-rules.xml		Firmware Rules Template	
<input type="checkbox"/> IGD-WANConnectionDevice-1-parameter-list.xml		Parameter List	
<input type="checkbox"/> IGD-Stats-LANethernetInterfaceConfig-1-parameter-list.xml		Parameter List	
<input type="checkbox"/> IGD-Stats-WANIPConnection-1-parameter-list.xml		Parameter List	
<input type="checkbox"/> IGD-Stats-WANPPPoEConnection-1-parameter-list.xml		Parameter List	
<input type="checkbox"/> IGD-WANConnectionDevice-2-parameter-list.xml		Parameter List	
<input type="checkbox"/> IGD-LANDevice-parameter-list.xml		Parameter List	
<input type="checkbox"/> IGD-WANDevice-parameter-list.xml		Parameter List	
<input type="checkbox"/> IGD-VoiceService-parameter-list.xml		Parameter List	
<input type="checkbox"/> IGD-WANDSLInterfaceConfig-parameter-list.xml		Parameter List	
<input type="checkbox"/> IGD-Layer3Forwarding-parameter-list.xml		Parameter List	
<input type="checkbox"/> IGD-Entire-Object-Model-parameter-list.xml		Parameter List	
<input type="checkbox"/> IGD-WLANConfiguration-parameter-list.xml		Parameter List	
<input type="checkbox"/> IGD-IPPingDiagnostics-parameter-list.xml		Parameter List	
<input type="checkbox"/> IGD-WANDSLConnectionManagement-parameter-list.xml		Parameter List	
<input type="checkbox"/> IGD-Device-Summary-parameter-list.xml		Parameter List	
<input type="checkbox"/> tr104-cwmp-dictionary.xml		Parameter Dictionary	
<input type="checkbox"/> tr098-cwmp-dictionary.xml		Parameter Dictionary	
<input type="checkbox"/> tr069-cwmp-dictionary.xml		Parameter Dictionary	
<input type="checkbox"/> basic-cwmp-dictionary.xml		Parameter Dictionary	
<input type="checkbox"/> sample-firmware-image.bin		Firmware File	

Result Pages: 1

Table 17-7 identifies the fields and buttons shown in Figure 17-6.

Table 17-7 Manage Files Page

Field or Button	Description
<b>File Type</b>	
File Type	Identifies the file type.
File Name	Identifies the file name. This value can be a complete file name or can contain a wildcard character at the start of the string to match all files with a given suffix.
Page Size	Identifies the length of page to be displayed.
<b>Search</b>	Initiates the search for files with a name that matches the selected File Type and File Name search parameters.
<b>Add</b>	Adds a new file.
<b>Delete</b>	Removes any selected files from the database.
<b>Files</b>	

Table 17-7 Manage Files Page (continued)

Field or Button	Description
<b>File Type</b>	
Files list	Displays a list of files that match the search criteria. <b>Note</b> The check boxes immediately to the left of any selected item in this list must be checked before it can be deleted.
View	Displays the details of the selected file.
File Type	Identifies the type of file; for example, Configuration Template, Firmware Rules Template, Parameter List.
Export	Exports any selected file to the client's computer.

## Adding Files

To add an existing file to the RDU database:

**Step 1** Choose **Configuration** on the Primary Navigation bar.

**Step 2** Choose **Files** on the Secondary Navigation bar.

The View Files page appears.

**Step 3** Click **Add**.

**Step 4** Choose the File Type.



**Note** For Firmware file type, two additional fields are provided: Firmware Version and Description, both of which are purely informational. You can enter any string in these fields.

**Step 5** Browse for the Source File Name.

By default, file sizes up to 20 MB are supported.

**Step 6** Enter the File Name.

**Step 7** Click **Submit**.

The View Files page appears to indicate that the file has been added.

Cisco BAC now extends the http file service so that it can read the firmware file from the DPE file system or DPE cache

When the firmware image size is very large (say 100 MB), adding the file through RDU may not be efficient. These files can be manually transferred to all the DPEs using tools such as scp, ftp and later when device requests for these files, they can be transferred to the device from the DPE.

## Viewing Files

To view the contents of a file:

- 
- Step 1** Choose **Configuration** on the Primary Navigation bar.
  - Step 2** Choose **Files** on the Secondary Navigation bar.  
The View Files page appears.
  - Step 3** Search for the required file by using File Type.
  - Step 4** Click the **View Details** icon () corresponding to the File Type you had specified for a search.  
The View File page appears.
- 

## Replacing Files

To replace an existing file:

- 
- Step 1** Choose **Configuration** on the Primary Navigation bar.
  - Step 2** Choose **Files** on the Secondary Navigation bar.
  - Step 3** Select the link that corresponds to the file you want to replace from the search output list.  
The Replace File page appears. Note that the selected filename already appears on this page.
  - Step 4** Browse for the source file to be used as a replacement for the displayed filename.
  - Step 5** Click **Submit**.  
If you are updating a configuration or firmware template which is associated with a Class of Service, after submitting the replacement file, a confirmation page appears to indicate that Cisco BAC will regenerate instructions for the affected devices.  
The Instruction Generation Service automatically regenerates instructions for all devices associated with this template using the Class of Service association and sends new instructions to the appropriate DPEs.
  - Step 6** Click **OK**.  
The View Files page appears.
-

## Exporting Files

You can copy files to your local hard drive by using the export function.

**Note**

The procedure described below assumes that you are using Internet Explorer. This procedure is different if you are using Netscape Navigator.

To export a file:

- Step 1** Choose **Configuration** on the Primary Navigation bar.
- Step 2** Choose **Files** from the Secondary Navigation bar.
- Step 3** Identify the file that you want to export.
- Step 4** To export
  - Binary files, click the **Export** icon () and you are prompted to either open the file or save it.
  - XML files, such as templates, clicking the **Export** icon displays the file content. Therefore, you must right-click the **Export** icon and select **Save Target As**.
- Step 5** Return to the Cisco BAC administrator user interface.

## Deleting Files

Complete this procedure to delete an existing file:

- Step 1** Choose **Configuration** on the Primary Navigation bar.
- Step 2** Choose **Files** on the Secondary Navigation bar.
- Step 3** In the Files area, enter the filename of the file that you want to modify.
- Step 4** Click **Search**.

The appropriate file appears in the Files list.
- Step 5** Choose the appropriate file or files.
- Step 6** Click **Delete**.

**Caution**

Deleting a template file that is not directly linked to a Class of Service, but is referenced by another template file that is linked to a Class of Service, causes the instruction regeneration service to fail.

**Note**

You cannot delete a file associated with a Class of Service. You must remove the Class of Service association before proceeding. See [Configuring the Class of Service, page 17-1](#), for additional information.

# Managing License Keys

Software licenses are used to activate specific features or to increase the functionality of your installation. Each license is available as either a permanent license or an evaluation license.

- **Permanent**—A permanent license is purchased for use in your network environment and activates the specific features for which it is intended.
- **Evaluation**—An evaluation license enables functionality for a specific amount of time after installation. You can upgrade an evaluation license to a permanent license by entering a new permanent license number.



## Caution

Do not attempt to deploy into a fully operational network with an evaluation license key installed. Any provisioning done by using an evaluation license is disabled when that evaluation license expires.

When you upgrade from an evaluation license to a permanent license, you do not have to re-install the software or reconfigure Cisco BAC. You simply have to provide the permanent license using the Cisco BAC administrator user interface.

The Manage License Keys page (Figure 17-7) displays a list of licenses that have been entered for your implementation. This Cisco BAC release supports both evaluation and permanent licenses for the CWMP-compliant devices, and DPEs. The status of each available license appears as active, expired, or identifies the expiration date.



## Note

You can upgrade a permanent license to increase the number of authorized devices by adding an additional license. When you reach the limit of your number of licensed devices you cannot provision new devices, but existing devices that are already provisioned continue to receive service.

**Figure 17-7** Manage License Keys Page

Technology	License Key	Type	Devices	Status
CWMP	ASfT-tU-5\$R\$R-dnFt-sRR---Ugdd?6MPMLyHMa?cM9N sBBA-tU-5\$R\$R-dnFt-s---Elg?dnFt?s	Permanent	101000	Installed on November 22, 2011
DPE	ABT5-tU-5\$R\$R-6tz-AR---Ugdd?6MPMLyHMa?cM9N	Permanent	20	Installed on November 22, 2011
FP-FEMTOEXT-1.0	sBRK-zU-s\$R-3t13zFcDzWc-GRRR-s-A	Evaluation	-	Valid until November 23, 2011

License Key:

284466

## Adding and Modifying a License

To add, modify, or upgrade a license:

- 
- Step 1** Choose **Configuration** on the Primary Navigation bar.
  - Step 2** Choose **License Keys** on the Secondary Navigation bar.
  - Step 3** Obtain your new license key from either your Cisco Systems representative or the Cisco Technical Assistance Center (TAC) website. See the [Preface](#) in this guide for TAC contact information.
  - Step 4** Enter the new license key in the License Key field.
  - Step 5** Click **Add/Upgrade** to install the new license key.
    - If you enter a permanent license key, it overwrites the corresponding evaluation key (if that key was installed).
    - If you enter a license key (permanent or evaluation) for a new technology, it will appear in the technology list.
- 

## Managing DPE Feature Pack Extensions

Cisco BAC provides a mechanism to license DPE feature packs extension. The feature pack licenses indicate the count of the devices that can be processed by the feature pack extension. The feature pack licenses can be added to the RDU through BAC admin UI (**Configuration -> License Key**) or API independently with or without CWMP or DPE licenses.

You must buy enough CWMP licenses to cover the number of devices that would use the feature pack extensions. For instance, if you buy a Femto feature pack license for X number of devices and DLC feature pack license for Y number of devices, then you must buy CWMP License for at least X+Y number of devices.

The feature pack licensing leverages BAC's existing licensing mechanism. Adding feature pack licenses to the RDU is similar to adding other licenses such as DPE and CWMP.

The DPE feature pack license is similar to RDU, DPE and CWMP license. However, in the case of DPE feature pack license, the MANIFEST of the DPE feature pack extension JAR should have the attribute **Extension-Name** defined and its value should be in the format *FP- Technology Name - versionnumber*.

Where:

*FP*—Denotes it is a feature pack license.

*ExtensionName*— DPE extension technology name. For example, Femto, DLC, CPEaaS.

*VersionNumber*— DPE extension technology version. This version number must be the same or lower than the version of the feature pack license added in DPE. If not, the DPE registration fails.

A few examples for *FP- Technology Name - versionnumber* would be FP-CPEaaS-1.0, FP-CPEaaS2.0, FP-Femto-10, FP-DLC-1.0 and so on.

## Writing a New Class for DPE Feature Pack Extensions

This procedure illustrates how to write a new class for DPE feature pack extension. This section also provides details about how to add a new class and integrate it with the DPE.

To write the new class:

**Step 1** Create a Java source file for the custom publishing extension, and compile it.

**Step 2** Create a manifest file for the JAR file that will contain the extension class.

For detailed information on creating a manifest file and using the command-line JAR tool, see Java documentation.

For example:

```
Manifest-Version: 1.0
Ant-Version: Apache Ant 1.6.2
Created-By: 17.0-b16 (Sun Microsystems Inc.)
Implementation-Title: Cisco Broadband Access Center FemtoCell Extension
Implementation-Version: FEMTOEXT 3.7 (test-build)
Implementation-Vendor: Cisco Systems, Inc.
Extension-Name: FP-femtoext-3.7
```

Java JAR file manifests contain attributes that are formatted as name-value pairs and support a group of attributes that provide package versioning information.



### Note

Cisco BAC accepts only those extension JAR files that include a manifest with the *Extension-Name* attribute in the files.

**Step 3** For each new class being subclassed, create a mapping file in the directory *META-INF/services*.

The name of the mapping file is the same as the new class being subclassed. This mapping file contains the names of the new subclasses of that class.

For example create the mapping file:

```
META-INF/services/com.cisco.provisioning.cpe.extensions.dpe.spi.cwmp.SoapRequestSenderService
```

This file consists of the following:

```
# This example configures the class SoapRequestSenderProvider as a DPE service
# provider extension class attached to the DPE service SoapRequestSenderService.
# Service providers for:
# com.cisco.provisioning.cpe.extensions.dpe.spi.cwmp.SoapRequestSenderService
com.cisco.bac.femto.dpe.extensions.FemtoServiceEnablementExtension
```

**Step 4** Create the JAR file for the custom extension point in the directory *<BAC\_HOME>/dpe/conf/*.

For example:

```
C:\>jar cm0vf manifest.txt femto.jar com
added manifest
adding: com/(in = 0) (out= 0)(stored 0%)
adding: com/cisco/(in = 0) (out= 0)(stored 0%)
adding: com/cisco/bac/(in = 0) (out= 0)(stored 0%)
adding: com/cisco/bac/femto/(in = 0) (out= 0)(stored 0%)
adding: com/cisco/bac/femto/dpe/(in = 0) (out= 0)(stored 0%)
adding: com/cisco/bac/femto/dpe/extensions/(in = 0) (out= 0)(stored 0%)
adding: com/cisco/bac/femto/dpe/extensions/
FemtoServiceEnablementExtension.class(in = 4038) (out= 4038)(stored 0%)
```



C:\&gt;



**Note** You can give the JAR file any name. The name can be descriptive, but do not duplicate another existing JAR filename.

## Managing RDU Extensions

Creating a custom extension point is a programming activity that can, when used with the Cisco BAC administrator user interface, allow you to augment Cisco BAC behavior or add support for new device technologies.

Before familiarizing yourself with managing extensions, you should know the RDU extension points that Cisco BAC requires. At least one disruption extension must be attached to the associated technology's disruption extension point when disrupting devices on behalf of a batch.

[Table 17-8](#) lists the RDU extension points that Cisco BAC requires to execute extensions.

**Table 17-8** Required RDU Extension Points

Extension Point	Description	Use	Specific to Technology?
Common Configuration Generation	Executed to generate a configuration for a device.  Extensions attached to this extension point are executed after the technology-specific service-level selection extension and before the technology-specific configuration generation extensions.  The default extensions built into this release do not use this extension point.	Optional	No
Configuration Generation	Executed to generate a configuration for a device.	Required	Yes
Device Detection	Executed to determine a device technology based on information in the DHCP Discover request packet of the device.	Required	No
Disruption	Executed to disrupt a device.	Optional	Yes
Publishing	Executed to publish provisioning data to an external datastore. The default extensions built into Cisco BAC, do not include any publishing plug-ins.	Optional	No

Table 17-8 Required RDU Extension Points (continued)

Extension Point	Description	Use	Specific to Technology?
Service-Level Selection	Executed to select the service level to grant to a device.  Extensions attached to this extension point are executed before any common configuration generation extensions and the technology-specific configuration generation extensions.	Optional	Yes
Authentication	Executed to authenticate the user through remote authentication servers. Extensions will be attached to the extension points based on the authentication mode listed in RDU Defaults Page.  RADIUS extensions are default built in authentication extensions in BAC.	Required	Yes

Managing extensions includes:

- [Writing a New Class for RDU, page 17-24](#)
- [Installing RDU Custom Extensions, page 17-25](#)
- [Viewing RDU Extensions, page 17-26](#)



**Note**

You can specify multiple extension points by making them run one after another. You do this by specifying the extensions points in a comma-separated list.

## Writing a New Class for RDU

This procedure illustrates the entire custom extension creation process. You can create many different types of extensions; for the purposes of this procedure, a new Publishing Extension Point is used.

To write the new class:

**Step 1** Create a Java source file for the custom publishing extension, and compile it.

**Step 2** Create a manifest file for the JAR file that will contain the extension class.

For detailed information on creating a manifest file and using the command-line JAR tool, see Java documentation.

For example:

```
Name: com/cisco/support/extensions/configgeneration
Specification-Title: "TOD synchronization"
Specification-Version: "1.0"
Specification-Vendor: "General TW, Inc."
Implementation-Title: "Remove the time-servers DHCP option"
Implementation-Version: "1.0"
Implementation-Vendor: "Cisco Systems, Inc."
```

Java JAR file manifests contain attributes that are formatted as name-value pairs and support a group of attributes that provide package versioning information.

While Cisco BAC accepts extension JAR files that do not contain this information, we recommend that you include a manifest with versioning information in the files to track custom RDU extensions.

You can view manifest information from the administrator user interface using the **Servers > RDU > View Regional Distribution Unit Details** page.

Detailed information on the installed extension JAR files and the loaded extension class files appears after the Device Statistics section. You can view manifest information from the RDU logs also.

**Step 3** Create the JAR file for the custom extension point.

For example:

```
C:\>jar cm0vf manifest.txt removetimeservers.jar com
added manifest
adding: com/(in = 0) (out= 0)(stored 0%)
adding: com/cisco/(in = 0) (out= 0)(stored 0%)
adding: com/cisco/support/(in = 0) (out= 0)(stored 0%)
adding: com/cisco/support/extensions/(in = 0) (out= 0)(stored 0%)
adding: com/cisco/support/extensions/configgeneration/(in = 0) (out= 0)(stored 0%)
adding: com/cisco/support/extensions/configgeneration/
RemoveTimeServersExtension.class(in = 4038) (out= 4038)(stored 0%)
C:\>
```



---

**Note** You can give the JAR file any name. The name can be descriptive, but do not duplicate another existing JAR filename.

---

## Installing RDU Custom Extensions

After a Jar file is created, use the administrator user interface to install it:

- 
- Step 1** To add the new Jar file, see [Adding Files, page 17-17](#).  
Use the Browse function to locate the Jar file created in the procedure, [Writing a New Class for RDU, page 17-24](#), and select this file as the Source File; leaving the File Name blank assigns the same filename for both source and external. The filename is what you will see through the administrator user interface.
  - Step 2** Click **Submit**.
  - Step 3** Return to the RDU Defaults page and note that the newly added Jar file appears in the Extension Point Jar File Search Order field.
  - Step 4** Enter the extension class name in the Publishing Extension Point field.  
The RDU returns an error if the class name does not exist within the jar file or if Cisco BAC detects any other errors. This error occurs mostly when replacing a Jar file, if, for example, the class you set up is not found in the replacement Jar file.
  - Step 5** Click **Submit** to commit the changes to the RDU database.
  - Step 6** View the RDU extensions to ensure that the correct extensions are loaded.
-

## Viewing RDU Extensions

You can view the attributes of all RDU extensions directly from the View Regional Distribution Unit Details page. This page displays details on the installed extension Jar files and the loaded extension class files.

## Publishing Provisioning Data

Cisco BAC has the capability to publish the provisioning data it tracks to an external datastore in real time. To do this, a publishing plug-in must be developed to write the data to the desired datastore. The Manage Publishing page identifies information such as the plug-in name, its current status (whether it is enabled or disabled), and switch to enable or disable it.

You can enable as many plug-ins as required by your implementation but care must be exercised because the use of publishing plug-ins can decrease system performance.



### Note

Cisco BAC does not ship with any publishing plug-ins. You must create your own plug-ins and load them into Cisco BAC in the same way as JAR files are (see [Adding Files, page 17-17](#)). Then, manage the plug-ins from the Manage Publishing page.

## Publishing Datastore Changes

To enable or disable a publishing plug-in:

- 
- Step 1** Choose **Configuration** on the Primary Navigation bar.
  - Step 2** Choose **Publishing** on the Secondary Navigation bar.  
The Manage Publishing page appears. This page displays a list of all available database plug-ins and identifies the current status of each. C
  - Step 3** Click on the appropriate status indicator to enable or disable the required plug-in. Note that as you click the status, it toggles from enabled to disabled.
- 

## Modifying Publishing Plug-In Settings

These settings are a convenient way for plug-in writers to store plug-in settings in the RDU for their respective datastore. To modify the publishing plug-in settings:

- 
- Step 1** Choose **Configuration** on the Primary Navigation bar.
  - Step 2** Choose **Publishing** on the Secondary Navigation bar,  
The Manage Publishing page appears.
  - Step 3** Click the link corresponding to the plug-in you want to modify.  
The Modify Publishing Plug-Ins page appears.

Table 17-9 identifies the fields shown in the Modify Publishing Plug-Ins page.

**Table 17-9** *Modify Publishing Plug-ins Page*

Field or Button	Description
Plug-In	Identifies publishing plug-in name.
Server	Identifies the server name on which the data store resides.
Port	Identifies the port number on which the data store resides.
IP Address	Identifies the IP address of the server on which the data store resides. This is usually specified when the server name is not used.
User	Identifies the user to allow access to the data stored.
Password	Identifies the user's password which allows access to the data stored.
Confirm Password	This is used to confirm the password entered above.

- Step 4** Enter the required values in the Server, Port, IP Address, User, Password, and Confirm Password fields. These are all required fields and you must supply this information before proceeding.
- Click **Submit** to make the changes to the selected plug-in, or click **Reset** to clear all fields on this page.

## Configuring Lease Query

Cisco BAC, by default, binds to the IP addresses and ports that are described in the below table.

**Table 17-10** *Modify Publishing Plug-ins Page*

Protocol	IP Address	Port
IPv4	Wildcard	Any available port

The wildcard is a special local IP address. It usually means "any" and can only be used for bind operations.

You can also configure the IP address and port of your choice for lease query communication using the same properties. For example:

**/cnrQuery/clientSocketAddress=10.1.2.3:166**

Using this property, the DPE binds to the IP address and the port that you specify.





# CHAPTER 18

## Scripting Framework

---

This chapter describes the Scripting framework in Cisco BAC that involves configuring java script based DPE extensions.

This chapter includes the following sections:

- [Overview, page 18-1](#)
- [Script's Shared Scope, page 18-1](#)
- [Extension Script, page 18-2](#)
- [Integrating Extension Scripts in BAC, page 18-3](#)
- [Adding Extension Points to the Device Property, page 18-3](#)
- [Configuring Extensions for Unknown Devices, page 18-4](#)
- [Verifying Extension Scripts Availability in DPE Cache, page 18-5](#)
- [Verifying Status of the Extensions in DPE, page 18-5](#)

### Overview

Scriptable extension service facilitates running the java scripts based DPE extensions. Once the extension scripts are added in the RDU database, the RDU applies the scripts to the DPE cache. When the CPE boots and attempts to establish connection with the DPE, the extension scripts are executed based on the extensions configured in the device property hierarchy.

### Script's Shared Scope

Script's Shared Scope is a shared repository for extension scripts. Cisco BAC APIs like get properties from PG, fire extension specific events, debugging, logging, and so on, are put into the Script's Shared Scope so that the extension scripts can call them whenever required.

The following objects are added in the Script's Shared Scope for extension scripts:

**Table 18-1**      *Java Objects*

Object Name	API
request	CwmpHttpRequest
response	CwmpHttpResponse

**Table 18-1** Java Objects

Object Name	API
session	CwmpHttpSession
scriptSupport	ScriptSupport
service	CwmpHttpService
log	DefaultLogStream

By default the following frequently used Java packages are imported into the Script's Shared Scope:

```
java.lang.*;
java.util.*;
com.cisco.provisioning.cpe.cwmp.main.*;
com.cisco.provisioning.cpe.cwmp.soap.messages.*;
com.cisco.provisioning.cpe.cwmp.soap.types.*;
com.cisco.provisioning.cpe.extensions.dpe.api.events.*;
com.cisco.provisioning.cpe.extensions.dpe.faults.*;
com.cisco.csrc.dpe.extensions.script.*;
```

You can also add any third-party libraries into the Script's Scope by adding the jar files into /dpe/lib folder. During DPE start-up, the class loader will load all the jars available in /dpe/lib folder. You can import the Java packages in the extension scripts to make use of the Java classes available in the libraries loaded.

For example, you can import the java packages using the following command:

```
importPackage (Packages.com.mylib.test);
```

**Note**

Restart the DPE after adding the jar files.

## Extension Script

Extension scripts are classified into two categories:

- **DPE Extension Script**—These script files are main extension scripts having the main provisioning logic.

The following script is a sample DPE extension script:

```
log.debug(" Executing sample extension...");
var params = ["Device.DeviceInfo.SoftwareVersion"];
log.debug(" Getting SoftwareVersion info...");
var result = getParamValues(scriptSupport, response, params);
log.debug(" Got response from the device ==> ");
log.debug(result.toString());
```

- **Helper Script**—These script files are utilities which can be used by multiple main extension scripts. The helper scripts are called from both main extension scripts and other helper scripts.

The following script is a sample Helper script:

```
function getParamValues(scriptSupport, response, params)
{
    if (params && params.length > 0)
    {
```



```

        // With continuation support, the script gets the
        // response the in the same line as if using
        // a synchronous interface
        // sendAndReceive() sends the give message to the
        // device and receives the response message.
        return scriptSupport.sendAndReceive(response,
            scriptSupport.newGetParameterValuesMessage(params));
    }
    return null;
}

```

## Integrating Extension Scripts in BAC

The extension scripts are added to RDU database from the admin UI.

To add a new extension script to the Cisco BAC RDU:

- 
- Step 1** Choose **Configuration** on the primary navigation bar.
  - Step 2** Choose **Files** on the secondary navigation bar. The View Files page appears.
  - Step 3** Click **Add**.  
The Add Files page appears.
  - Step 4** Choose DPE Extension Script / Helper Script from the File Type drop-down list.
  - Step 5** Browse for the Source File Name.
  - Step 6** Add the .js file in the File Name field.
  - Step 7** Click **Submit**.  
The View Files page appears with the new file.
- 

The extension scripts can be viewed only after exporting the .js script file from the admin UI to your local machine. For more information on exporting extension scripts, see [Exporting Files, page 17-19](#).

## Adding Extension Points to the Device Property

Extensions can be configured in the device property hierarchy at Class of Service (CoS), Device, Group, Provisioning group and CWMP defaults.

The following extension points can be configured in the device:

- /IPDevice/extensions/soapRequestSender - The extension scripts configured are executed, when a request is received from the CPE.
- /IPDevice/extensions/soapResponseSender - The extension scripts configured are executed, when a response is sent to the CPE.
- /IPDevice/extensions/incomingEventViewer - The extension scripts configured are executed, when the event (existing configuration) is received from the CPE.
- /IPDevice/extensions/outgoingEventViewer - The extension scripts configured are executed, when the event (required configuration) is sent to the CPE.

To add scriptable extensions at CWMP Defaults level:

- 
- Step 1** Choose **Configuration** on either the primary navigation bar or main menu page.
- Step 2** Choose **Defaults** from the secondary navigation bar.  
The CWMP Defaults page appears. See [CWMP Defaults, page 17-7](#) for field description.
- Step 3** Configure the extension scripts for the required extensions.  
For example, specify *sampleExtension.js* in the **SOAP Request Sender Extension** field. Similarly, specify the required extension scripts in the **SOAP Response Sender Extension**, **Incoming Event Viewer Extension**, and **Outgoing Event Viewer Extension** fields.  
For information on adding extension scripts to the RDU database, see [Integrating Extension Scripts in BAC, page 18-3](#).
- Step 4** Click **Submit**.  
The scriptable extensions are added in the DPE.
- 

**Note**

If the extensions are not configured at Class of Service (CoS), Device, Group, or Provisioning group level in the device property hierarchy, by default, extensions configured under CWMP defaults are executed.

---

## Configuring Extensions for Unknown Devices

You can configure the extension list for unknown devices from the admin UI from the CWMP Defaults page. This enables the DPE to retrieve the list of default extensions and execute the extension scripts, when the unknown device establishes connection with the DPE.

To configure extensions for unknown devices:

- 
- Step 1** Add the extension script to the RDU database using DPE Extension Script file.  
For more details on how to add an extension script in BAC, see [Integrating Extension Scripts in BAC, page 18-3](#).
- Step 2** Configure the extension in the CWMP Defaults page.  
For more details on CWMP Defaults, see [CWMP Defaults, page 17-7](#).
- Step 3** Boot an unknown device.
- Step 4** Verify that the extension script is executed in DPE.  
For more details on verifying the status of the extensions loaded in DPE, see [Verifying Status of the Extensions in DPE, page 18-5](#).
-

## Verifying Extension Scripts Availability in DPE Cache

When the device boots, it contacts DPE and invokes the extension scripts available in DPE cache based on the extensions configured for the device.

To verify whether the extensions scripts are pushed to DPE cache from RDU:

**Step 1** Log into DPE CLI.

**Step 2** Verify that the extension scripts are available in the DPE cache, using the following command:

```
dpe# show files
```

The following is a sample output:

The list of files currently in DPE cache

filename	size
main.js	2161
passthroughtest.js	4106
sample-firmware-image.bin	4239368
sampleextension.js	3319
samplehelper.js	2645

```
DPE caching 5 external files.
Listing the first 5 files, 0 files omitted
```

## Verifying Status of the Extensions in DPE

The extensions scripts are executed in DPE, based on the extension points configured in device property hierarchy.

To verify if the extensions are executed in the DPE after booting the device:

**Step 1** Log into DPE CLI.

**Step 2** Enable debug for DPE extensions using the command:

```
debug dpe dpe-ext
```

**Step 3** Boot the device.

**Step 4** Observe the dpe.log file to verify if the scripts are executed in DPE. To view DPE logs see [Viewing the dpe.log File, page 21-8](#).

The following is a sample output:

```
[Device [00000C-1234567890] Session [149eb9f53A137fed6a9c353A80000023]. Extension
[sampleextension.js].]: [Executing script [sampleextension.js] for the first
time]
```



**Note** The result is displayed in the dpe.log file.





# CHAPTER 19

## RDU and DPE Connection Management

---

This chapter deals with RDU TCP Connection Management, RDU Batch Concurrency and RDU DPE synchronization.

This chapter includes the following sections:

- [TCP Connection Management, page 19-1](#)
- [RDU Batch Concurrency, page 19-2](#)
- [DPE-RDU Synchronization, page 19-3](#)

### TCP Connection Management

Communication between the RDU and its clients, such as DPEs, API, occurs over TCP. Each client creates a connection to the RDU that is maintained as long as the client desires.

Over this connection, clients submit batches to the RDU while the RDU replies with the batch results and additionally sends events. In order to maintain the connection, a heart beat is used when no other traffic is available. Timeouts are used to prevent the RDU and the clients from creating unwanted traffic.

### Heart Beat

Heart beat messages are initiated by the clients. The client sends a heart beat when a read timeout has occurred and it is in the process of receiving a message. On receiving this heart beat, the RDU echoes it. The client receives this echo and recognizes that the connection is alive. This cycle repeats itself until the connection is lost.

If the client fails to receive a reply after sending the heart beat (echo message), it closes its connection and attempts to open a new one.

The RDU will close the connection if no traffic is sent or received for two consecutive read timeouts. To change the number of read timeouts before closing the connection, you must set the following property in the RDU property file and restart the application. You can configure this property in the `BPR_HOME/rdu/rdu.properties` file.

`/messaging/connection/numReadTimeouts=value`

# RDU Batch Concurrency

In the Cisco BAC system, a provisioning client submits API requests to the RDU in the form of batches containing single or multiple commands. A command represents an operation that can be performed on an object in the RDU's database, for example, changing a device's Class of Service. Depending on the commands contained in the batch, the RDU runs the batch in one of two modes: concurrent or non-concurrent.

The commands contained within a batch determine the mode it is to be run with. When a batch is received at the RDU, its commands are checked and the batch is marked with the mode with which it must be run with. During the execution of a concurrent-mode batch, other concurrent-mode batches are allowed to be run, in parallel. The majority of batches executed are run in the concurrent mode.

If the batch is marked as non-concurrent, it is executed only when all the currently executing batches are completed in the RDU. The non-concurrent batch is run alone. After the batch completes running, the RDU processes the queued batches in the mode that they have been marked.

The reason concurrent and non-concurrent modes exist is to provide higher throughput at the RDU without losing data integrity. There are only a few commands that cause a batch to run in non-concurrent mode. They are mainly concerned with system configuration operations that are not called very often.

## Non-concurrent Commands

Along with Server Registration, if any of the following commands are present in a batch, it is run in non-concurrent mode.

### Configuration Interface

- addLicenseKey
- addUser
- addCustomPropertyDefinition
- addClassOfService
- addFile
- changeClassOfServiceProperties
- changeDPEDefaults
- changeExtensionPointSettings
- changeRDUDefaults
- changeSystemDefaults
- changeFileProperties
- changeProvGroupProperties
- changeUser
- deleteClassOfService
- deleteFile
- deleteLicenseKey
- removeCustomPropertyDefinition
- replaceFile

### IPDevice Interface

- addDeviceType
- changeDefaults
- deleteDeviceType
- regenConfigs
- IPDevice.addNode
- IPDevice.changeNodeProperties
- IPDevice.deleteNode
- IPDevice.addNodeType
- IPDevice.changeNodeTypePriority
- IPDevice.changeNodeTypeProperties
- IPDevice.deleteNodeType

## Long-Running Batch

A long-running batch is one that requires more than two seconds to run. The only batch that fits into this category is the synchronization batch submitted by the DPEs. Additional batches can become long running batches if custom extension points are used to interface with external systems (e.g. publishing to an external database).

Long-running batches, interleaved with non-concurrent batches, can create an impression that the RDU is not responding or is frozen. If a long-running batch is in progress and the next batch in the queue is a non-concurrent batch, the RDU waits for all current batches to finish before it starts to run the non-concurrent batch. It also will not start any other batches.

At those times, the RDU will seem to not respond. However, as soon as the long-running batch is completed, the RDU resumes running the queued batches. At this point, the RDU will respond again.

## DPE-RDU Synchronization

Cisco BAC supports multiple DPEs. The DPEs communicate with devices and the RDU. During installation, you must configure the following for each DPE:

- Name of the provisioning group to which this DPE belongs; this name determines the logical group of devices serviced by this DPE.
- The IP address and port number of the RDU.

The RDU generates the instructions for the device and sends the new instructions to all DPEs that service the provisioning group of the given device. The RDU will regenerate the instructions for a device when certain provisioning API calls are made at the RDU (such as changing the Class of Service of the device). The DPE stores the instructions and uses it to service subsequent requests.

The DPE persists all device instructions that it receives from the RDU to disk. Each instruction includes an identifier (device identifier or file name) and a revision number which is incremented every time the instruction is regenerated. In addition to events (dynamic notifications) fired by the RDU to all DPEs when a given configuration changes, there is also an automatic synchronization process which is used to bring DPE up-to-date with the RDU.

The DPE-RDU synchronization is a process of automatically updating the DPE cache to be consistent with the RDU. The DPE cache comprises the instruction cache, with instructions for devices, and the file cache, with files required for devices.

Under normal conditions, the RDU generates the events with instruction updates and sends them to all relevant DPEs to keep them up to date. Synchronization is needed if the DPE is missing some events because of connection loss. Such loss could be because of a network issue, the DPE server going down for administrative purposes, or a failure.

Synchronization also covers the special case when the RDU database is restored from backup. In this case, the DPE cache database must be returned to an older state to be consistent with the RDU.

**Note**

---

The RDU and DPE synchronization process is automatic and requires no administrative intervention. Throughout the synchronization process, the DPE is still fully capable of performing provisioning and management operations on the CPE.

---

The DPE triggers the synchronization process every time it establishes a connection with the RDU.

When the DPE first starts up, it establishes the connection to the RDU and registers with the RDU to receive updates of instruction changes. The DPE and RDU then monitor the connection by using heartbeat message exchanges.

When the DPE determines that it had lost its connection to the RDU, it automatically attempts to re-establish it. It continues attempting to do this with a backoff-retry interval until it is successful. The RDU also detects the lost connection and stops sending events to this DPE. Since the DPE may miss the update events from the RDU when the connection is down, the DPE performs synchronization every time it establishes a connection with the RDU.

During the process of connection establishment and registration with the RDU, the DPE is in the Registering state.

**Note**

---

To manually trigger the synchronization process for testing purpose, you can use the DPE CLI command **dpe reload** or break the connection by disconnecting and reconnecting the Ethernet cable.

---

The DPE requests a list of all the instructions it should have from the RDU. This list contains the identifiers for instructions and revision numbers, but not the actual instruction content. By using this list, the DPE determines which instructions in its store are inconsistent (wrong revision number), which ones are missing, and which ones to delete. Throughout the process of obtaining the synchronization list and comparing it with its store, the DPE is in the Synchronizing state.

As soon as the DPE finishes determining what to obtain from the RDU, it starts obtaining the instructions from the RDU. The DPE only obtains missing or out-of-date instructions. During this process, the DPE is in the Populating state.

The DPE populates at a fixed rate to ensure that the RDU is not overloaded with its requests. If multiple DPEs in the provisioning group are populating, the population time may be decreased as the requested instructions are sent to all DPEs in the provisioning group. After the DPE finishes populating, it is in the Ready state and fully synchronized with the RDU.

You can view the DPE state from the administrator user interface (see [Viewing Device Provisioning Engines, page 16-22](#)) or from the DPE CLI (by using the **show dpe** command).





## CHAPTER 20

# Cisco BAC Support Tools and Advanced Concepts

---

This chapter contains information on, and explains the use of, tools that help you maintain Cisco Broadband Access Center (BAC) as well as speed and improve the installation, deployment, and use of this product.

This chapter includes the following sections:

- [Using the deviceExport.sh Tool, page 20-1](#)
- [Using the disk\\_monitor.sh Tool, page 20-4](#)
- [Using the resetAdminPassword.sh Tool, page 20-5](#)
- [Using the runEventMonitor.sh Tool, page 20-5](#)
- [Using the changeARProperties.sh Tool, page 20-8](#)
- [Using the changeNRProperties.sh Tool, page 20-9](#)

For a list of other tools that are supported in this release, see [Cisco BAC Tools, page 9-7](#).



### Note

---

This section contains examples of tool use. In many cases, the tool filenames include a path specified as *BPR\_HOME*. This indicates the default installation directory location.

---

## Using the deviceExport.sh Tool

You can obtain information about devices by using the device export tool, which retrieves device information from the Cisco BAC system and exports it to a flat file. This file can, in turn, be used to import data into an external application.

The **deviceExport.sh** tool, located at the *BPR\_HOME/rdu/bin* directory, exports device information from the backup snapshot of the RDU database to a Comma Separated Value (CSV) format file.



### Note

---

You can use the device export tool only on the backup database; the tool does not export device information from the live RDU database.

---

You must provide a list of device properties that are to be exported in the control file. The control file is an XML file which defines the fields required for export. The tool provides an option to generate a sample control file, which you can edit to configure which properties to export.

You can generate the list of properties predefined in Cisco BAC and available for export by running the **deviceExport.sh -samplectrl** command. (For sample control output, see [Example 20-2](#).)

The CSV format is used widely to exchange data between applications. Keep the following rules in mind about a CSV format file:

- Each device outputs to one line.
- Each line terminates with the UNIX format line separator (\n).
- Each field is separated by a comma (,).
- If a field contains white space, a comma, or a line separator, it is enclosed by double quotes ("). If a field contains double-quotes, repeat the character twice to escape it; for instance, "file name" becomes ""file name"".
- A boolean field outputs as *true* or *false*.
- A byte array outputs to a string with UTF-8 encoding.
- If a field is a list, it converts into a formatted string with each item separated by comma; for instance, a node list outputs as "node1, node2, node3".
- If a field is a map, it is converted into a long string. The key and data is separated by a comma; for instance, a map output looks like: "(key1, data1)(key2, data2)(key3, data3)".
- If the field value is null or does not exist, the output is an empty string followed by a comma.
- The first line is the field name separated by a comma.
- There is no comma at the end of each record.

#### Example 20-1 Sample CSV Format

```
74:7b:7b:f0:e7:80,admin,true,2,"node1,node2,node3","(prop1,value1)(prop2,value2)",,,
```

#### Syntax Description

To use the **deviceExport.sh** command, use this syntax:

```
# ./deviceExport.sh [-help] [-samplectrl] controlfile backupdir outputdir
```

- *controlfile*—Identifies the path to the control file, which defines the fields required for export.
- *backupdir*—Identifies the path to the directory, which contains backed-up database files that are to be used as data source. (To back up your database, use the **backupDb.sh** tool; see [Backup and Recovery, page 10-4](#).)
- *outputdir*—Identifies the target location for the output files. If the directory does not exist, a new directory is created.
- **help**—Generates tool usage information.
- **samplectrl**—Generates the sample control file, which contains the supported properties and device types, in the current directory. The control file is an XML file that contains the supported properties and device types. You can remove unwanted properties or choose to export only certain types of devices by editing the XML file. See [Example 20-2](#) for output of a sample control file.

#### Example 20-2 Sample Control File

```
# ./deviceExport.sh -samplectrl
<?xml version='1.0' encoding='utf-8'?>
<!DOCTYPE CONTROLFILE SYSTEM "device-export-control.dtd">

<!--SAMPLE CONTROL FILE-->
```

```

<CONTROLFILE>

  <!--Start of field list(REQUIRED)
    The field list specifies the device properties that will be exported.
    All supported standard fields are listed below. Remove unwanted
    fields by deleting the line that contains the field name. Customer
    defined properties are not listed but can be added to the list.
  -->
  <FIELDLIST>
    <FIELD>GenericObjectKeys.OID_REVISION_NUMBER</FIELD>
    <FIELD>DeviceDetailsKeys.DEVICE_TYPE</FIELD>
    <FIELD>DeviceDetailsKeys.OWNER_ID</FIELD>
    <FIELD>DeviceDetailsKeys.NODE_DETAILS</FIELD>
    <FIELD>DeviceDetailsKeys.DEVICE_ID</FIELD>
    <FIELD>DeviceDetailsKeys.FQDN</FIELD>
    <FIELD>DeviceDetailsKeys.HOST</FIELD>
    <FIELD>DeviceDetailsKeys.DOMAIN</FIELD>
    <FIELD>DeviceDetailsKeys.IS_IN_REQUIRED_PROV_GROUP</FIELD>
    <FIELD>DeviceDetailsKeys.IS_REGISTERED</FIELD>
    <FIELD>DeviceDetailsKeys.IS_PROVISIONED</FIELD>
    <FIELD>DeviceDetailsKeys.PROV_GROUP</FIELD>
    <FIELD>DeviceDetailsKeys.CLASS_OF_SERVICE</FIELD>
    <FIELD>DeviceDetailsKeys.CLASS_OF_SERVICE_SELECTED</FIELD>
    <FIELD>DeviceDetailsKeys.PROPERTIES</FIELD>
    <FIELD>DeviceDetailsKeys.PROPERTIES_DETECTED</FIELD>
    <FIELD>DeviceDetailsKeys.PROPERTIES_SELECTED</FIELD>
    <FIELD>DeviceDetailsKeys.REASON</FIELD>
    <FIELD>DeviceDetailsKeys.EXPLANATION</FIELD>
    <FIELD>DeviceDetailsKeys.CONFIGURATION_REVISION</FIELD>
    <FIELD>DeviceDetailsKeys.FIRMWARE_CONFIGURATION_REVISION</FIELD>
    <FIELD>DeviceDetailsKeys.REPORTED_IP_ADDRESS</FIELD>
    <FIELD>DeviceDetailsKeys.SOURCE_IP_ADDRESS</FIELD>
    <FIELD>DeviceDetailsKeys.ROUTABLE_IP_ADDRESS</FIELD>
    <FIELD>DeviceDetailsKeys.DEVICE_FAULTS</FIELD>
    <FIELD>DeviceDetailsKeys.PENDING_ON_CONNECT_OPERATION_IDS</FIELD>
    <FIELD>DeviceDetailsKeys.PASSWORD_IS_PROTECTED</FIELD>
    <FIELD>IPDeviceKeys.HOME_PROV_GROUP</FIELD>
    <FIELD>IPDeviceKeys.CPE_PASSWORD</FIELD>
    <FIELD>IPDeviceKeys.CONNECTION_REQUEST_USERNAME</FIELD>
    <FIELD>IPDeviceKeys.CONNECTION_REQUEST_PASSWORD</FIELD>
  </FIELDLIST>
  <!--End of field list-->

</CONTROLFILE>

```

**Note**

The DOCTYPE CONTROLFILE SYSTEM references a .dtd file, device-export-control.dtd, which is used for XML validation. The file is installed in the BPR\_HOME/rdu/bin directory.

**Example 20-3 Exporting Data from Backup Snapshot**

This is an example of exporting data from a backup snapshot:

```
# ./deviceExport.sh control.xml rdu-backup-20061227-145538 /data/rduexport
Starting exporting devices...
```

```
Using backup database in /tmp/rdu-backup-20061227-145538
Device export finished in 28m11s.
```

**Note**

The exported file is generated in the specified directory; in the above example, in the /data/rduexport directory. You do not need to specify the full path to the directory.

Following a successful export from the Cisco BAC backup database, the Device Export tool creates a device file, which contains the list of device records that are successfully exported from the Cisco BAC backup database. The filename is `bac-device-details-yyyyMMdd-HHmmss.csv`:

Where `yyyyMMdd-HHmmss` identifies the time the file was generated.

## Using the `disk_monitor.sh` Tool

Monitoring available disk space is an important system administration task. You can use a number of custom written scripts or commercially available tools to do so. The `disk_monitor.sh` tool is a sample tool to accomplish this.

The `disk_monitor.sh` tool, located in the `BPR_HOME/rdu/sample/tools` directory, sets threshold values for one or more file systems. When these thresholds are surpassed, an alert is generated through the `syslog` facility, at 60-second intervals, until additional disk space is available.



### Note

Cisco recommends that, at a minimum, you use the `disk_monitor.sh` script to monitor the `BPR_DATA` and `BPR_DBLOG` directories.

### Syntax Description

```
# ./disk_monitor.sh file system-directory x
```

- `file system-directory`—Identifies any directory in a file system to monitor.
- `x`—Identifies the percentage threshold applied to the specified file system.

### Example 20-4 Monitoring Disk Space

Assume that you want to be notified when a file system (`/var/CSCObac`, for example) with database logs reaches 80% of its capacity. Enter the command:

```
# ./disk_monitor.sh /var/CSCObac 80&
```

When the database logs disk space reaches 80% capacity, an alert is sent to the `syslog` file:

```
Dec 7 8:16:03 perf-u80-1 BPR: [ID 702911 local6.warning] File system /var/bpr usage is 81% (threshold is 80%)
```



### Note

Make sure to configure Solaris or Linux to this on start-up, so that it is started after system reboots automatically.

## Using the resetAdminPassword.sh Tool

Cisco BAC supports both local authentication and TACACS+ authentication and you can use the **resetAdminPassword.sh** tool to reset the password for both local and TACACS+ authentication. Run the **resetAdminPassword.sh** tool from the `BPR_HOME/rdu/internal/db/bin` directory.

When the authentication is local if you use the **resetAdminPassword.sh** tool, it allows you to login with the default password **changeme**. After logging in, it will prompt you to change the password and you can change the password as you want.

When TACACS+ authentication is enabled, you can use the **resetAdminPassword.sh** tool to temporarily reset bacadmin authentication to local RDU. This tool allows you to login once with the password **changeme** to the RDU using the local reset admin password. After logging in, it will prompt you to change the password where you have to use the **changeme** password again. Then in the TACACS+ Defaults page you can change the password, as you want.

To enable local authentication, you have to manually change the authentication mode setting, after you login to the RDU. Otherwise, it will automatically fall back to TACACS+ authentication mode from next login.

To enable local authentication:

- 
- Step 1** Choose **Configuration** on either the Primary Navigation bar or Main Menu page.
  - Step 2** Choose **Defaults** from the Secondary Navigation bar.  
The Configure Defaults page appears.
  - Step 3** Click TACACS+ Defaults link on the left pane.  
The TACACS+ Defaults page appears
  - Step 4** Check the TACACS+ Authentication Disabled check box.
  - Step 5** Click **Submit**.
- 

**Note**

The authentication setting for other Cisco BAC users will not be affected by this tool. You must use the TACACS+ server administrative procedure to change the passwords.

---

## Using the runEventMonitor.sh Tool

You can run the **runEventMonitor.sh** tool to view the events that are being fired in Cisco BAC. You can run this tool from the `BPR_HOME/rdu/internal/bin` directory.

Table 20-1 describes the types of events that you can view from the event monitor:

**Table 20-1** Events that can be viewed from the Event Monitor

Event	Sub-Event	Description
Batch	Completion	Displays when a batch submitted by a client application ends. Contains the batch status.
Class of service	New	Indicates when a class of service is added to the system.
Class of service	Deleted	Indicates when a class of service is deleted from the system.
Configuration	Generated	Indicates when a configuration is generated.
Configuration	Uncommitted Generated	Indicates when a configuration that is temporarily stored at the DPE is generated.
Configuration	Rollback Uncommitted	Indicates that the uncommitted configuration should be discarded from the DPE.
Device	Changed Class Of Service	Indicates when a device changes its Class of Service.
Device	Changed IP Address	Indicates when a device's IP address changes.
Device	Deleted	Indicates when a device is deleted.
Device	Deleted Voice Service	Indicates when a voice service is deleted from a device.
Device	New Provisioned Device	Indicates when a device is added through the provisioning API.
Device	New Unprovisioned Device	Indicates when a device is added when booting on the network.
Device	New Voice Service	Indicates when a voice service is added to a device
Device	Roaming	Indicates when a device roams provisioning groups.
DHCP Criteria	New	Indicates when a DHCP criteria is added to the system.
DHCP Criteria	Deleted	Indicates when a DHCP criteria is deleted from the system.
External File	Added	Indicates when a file is added to the system.
External File	Deleted	Indicates when a file is deleted from the system.
External File	Replaced	Indicates when a file is replaced in the system.

**Table 20-1** Events that can be viewed from the Event Monitor (continued)

Event	Sub-Event	Description
Messaging	Connection Up	Indicates when a connection on the local instance of the messaging system starts.
Messaging	Connection Down	Indicates when a connection on the local instance of the messaging system stops.
Messaging	Queue Full	Indicates when the queue on the local instance of the messaging system is full and starts dropping messages.
Provisioning Group	Changed	Indicates when the provisioning group is changed.
Server Properties	Common Properties	Indicates when common properties that effect the RDU or DPE change.
System Configuration	Server Defaults Changed	Indicates when properties are changed on an user, RDU, or DPE.
System Configuration	System Configuration Changed	Indicates when the system configuration is changed.
System Configuration	System Defaults Changed	Indicates when defaults are changed.

**Syntax Description**

To run the event monitor, enter:

```
# /opt/CSCObac/rdu/internal/bin/runEventMonitor.sh [options]
```

Options are used to specify the RDU connection parameters and amount of output. You have the following options:

- **-noverbose**—Forces the event monitor to display only the types of events being fired, not their contents.
- **-host** *host*—Specifies the host where the RDU is located. Default is the localhost.
- **-port** *port*—Specifies the port on which the RDU is listening. Default is 49187.

**Example 20-5 Sample Event Monitor Output.**

If need help, please restart command with '?' parameter.

```
Verbose mode: true
RDU host: localhost
RDU port: 49187
```

```
Connecting to RDU...ok
```

```
Listening for events...
```

```
ExternalFileEvent added filename=gold.cm
  rev=1014671115124 (Mon Feb 25 16:05:15 EST 2002)
  source=BPR Provisioning API:BPR Regional Distribution Unit:AddExternalFile command
```

```
DeviceEvent newProvDevice ID=1,6,01:02:03:04:05:06
  rev=1014671179380 (Mon Feb 25 16:06:19 EST 2002)
```

```
source=BPR Provisioning API:BPR Regional Distribution Unit:AddIPDevice command IP=null
FQDN=null group=null
```

## Using the changeARProperties.sh Tool

The Cisco BAC installation program establishes values for configuration properties used by Cisco BAC extensions that are incorporated into the Access Registrar RADIUS server. You use the **changeARProperties.sh** command, which is found in the BPR\_HOME/car\_ep/bin directory, to change key configuration properties.

Invoking the script without any parameters displays a help message listing the properties that can be set.

To run this command:

- 
- Step 1** Change directory to BPR\_HOME/car\_ep/bin.
- Step 2** Run the **changeARProperties.sh** command using this syntax:

### **changeNRProperties.sh** options

Where options are:

- **-help**—Displays this help message. The **-help** option must be used exclusively. Do not use this with any other option.
- **-d**—Displays the current properties. The **-d** option must be used exclusively. Do not use this with any other option.
- **-s secret**—Identifies the Cisco BAC shared secret. For example, if the shared secret is the word **secret**, enter **-s secret**.
- **-q queue\_size**—Identifies the maximum number of the Access-Requests to be queued. For example, if you want to set the queue size to 1000, enter **-q 1000**.
- **-t thread\_count**—Identifies the maximum number of threads to be used to process the requests. For example, if you want to set the thread count to 10, enter **-t 10**.
- **-host addr**—Identifies the DPE Auth HTTP interface you want to use. For example, if you want to use the interface **localhost**, enter **-host localhost**.
- **-port port**—Identifies the DPE Auth HTTP interface port you want to use. For example, if you want to use the port 7551, enter **-port 7551**.
- **-url url**—Identifies the DPE Auth HTTP service url you want to use. For example, if you want to use the url **/auth**, enter **-url /auth**.
- **-ssl enabled/disabled**—Enables or disables the SSL/TLS connection between CAR and DPE. Enter **-ssl enabled** to enable it and **-ssl disabled** to disable it.
- **-x [true/false]**—Enables or disables XML Schema validation e.g. **-x true**



# Using the changeNRProperties.sh Tool

The Cisco BAC installation program establishes values for configuration properties used by Cisco BAC extensions that are incorporated into the Network Registrar DHCP server. You use the **changeNRProperties.sh** command, which is found in the BPR\_HOME/cnr\_ep/bin directory, to change key configuration properties.

Invoking the script without any parameters displays a help message listing the properties that can be set.

To run this command:

- 
- Step 1** Change directory to BPR\_HOME/cnr\_ep/bin.
- Step 2** Run the **changeNRProperties.sh** command using this syntax:

```
changeNRProperties.sh options
```

Where options are:

- **-help**—Displays this help message. The **-help** option must be used exclusively. Do not use this with any other option.
- **-d**—Displays the current properties. The **-d** option must be used exclusively. Do not use this with any other option.
- **-s secret**—Identifies the Cisco BAC shared secret. For example, if the shared secret is the word secret, enter **-s secret**.
- **-f fqdn**—Identifies the RDU FQDN. For example, if you use rdu.example.com as the fully qualified domain name, enter **-f rdu.example.com**.
- **-p port**—Identifies the RDU port you want to use. For example, if you want to use port number 49187, enter **-p 49187**.
- **-g prov\_group**—Identifies the provisioning group. For example, if you are using provisioning group called group1, enter **-g group1**.

## Examples

This is an example of changing the Network Registrar extensions by using the NR Extensions Properties tool:

```
#sh changeNRProperties.sh -g primary1
Current NR Properties:
RDU Port: 49187
RDU FQDN: rdu.example.com
Provisioning Group: primary1
Shared Secret: fggTaLg0XwKR8
```



### Note

You must restart your NR DHCP server for the changes to take effect.

This is an example of viewing the current properties:

```
#sh changeNRProperties.sh -d
Current NR Properties:
RDU Port: 49187
RDU FQDN: rdu.example.com
Provisioning Group: primary1
Shared Secret: fggTaLg0XwKR8
```





# CHAPTER 21

## Troubleshooting Broadband Access Center

This chapter provides the information on how to observe the RDU and DPE logs, and troubleshoot Cisco BAC.

This chapter includes the following sections:

- [Troubleshooting Checklist, page 21-1](#)
- [Logging, page 21-2](#)

### Troubleshooting Checklist

While troubleshooting with Cisco BAC, use the checklist described in [Table 21-1](#).

**Table 21-1**      **Troubleshooting Checklist**

Procedure	Refer to ...
1. Check whether the Cisco BAC processes are up on all systems on which Cisco BAC components are installed.	<a href="#">Using Cisco BAC Process Watchdog from the Command Line, page 9-2</a>
2. Check the Cisco BAC component logs for indications of high-severity errors. These include the information logged for: <ul style="list-style-type: none"><li>– RDU</li><li>– DPE</li></ul>	<a href="#">RDU Logs, page 21-5</a> <a href="#">DPE Logs, page 21-8</a>
3. View server uptime from the administrator user interface to confirm that the servers are not bouncing.	<a href="#">Viewing Servers, page 16-22</a>
4. View the RDU and DPE service performance statistics from the administrator's user interface. Observe any abnormal numbers, such as extended transaction times.	<a href="#">Viewing Servers, page 16-22</a>
5. Check the syslog alerts log.	<a href="#">Syslog Alert Messages, page 11-1</a>
6. Check the operating system and hardware resources, such as: <ul style="list-style-type: none"><li>– Disk space</li><li>– CPU time</li><li>– Memory</li></ul>	Solaris documentation for specific commands.

**Table 21-1 Troubleshooting Checklist (continued)**

Procedure	Refer to ...
7. If troubleshooting a specific device, view the history of the device configuration from the administrator user interface.	<a href="#">Viewing Device History, page 16-12</a>
8. If troubleshooting a specific device, view the device instructions that are cached at the DPE.	The <b>show device-config</b> command described in the <i>Cisco Broadband Access Center 3.8 DPE CLI Reference</i> .
9. Configure individual device troubleshooting from the administrator user interface and, after a period of time, inspect the troubleshooting log.	<a href="#">Configuring Device Troubleshooting, page 8-10</a>
10. View device fault data for the system, the RDU, the DPE, or a specific device.	<a href="#">Device Faults, page 8-6</a>
11. Configure a higher level of logging on the RDU or the appropriate DPE for detailed logging information.	The <a href="#">RDU Log Level Tool, page 21-5</a> The <b>log level</b> command as described in the <i>Cisco Broadband Access Center 3.8 DPE CLI Reference</i> .

## Logging

Logging of events is performed at both the DPE and RDU, and in some unique situations, DPE events are logged at the RDU to give them higher visibility. Log files are located in their own log directories and can be examined using any text file viewer. The files can be compressed to allow them to be easily e-mailed to the TAC or system integrators for troubleshooting and fault resolution.

This section describes:

- [Log Levels and Structures, page 21-3](#)
- [Configuring Log Levels, page 21-4](#)
- [Rotating Log Files, page 21-4](#)
- [RDU Logs, page 21-5](#)
- [The RDU Log Level Tool, page 21-5](#)
- [DPE Logs, page 21-8](#)
- [Access Registrar Logs, page 21-8](#)

## Log Levels and Structures

The log file structure is described here, and illustrated in [Example 21-1](#), and includes:

- Domain Name—This is the name of the computer generating the log files.
- Date and Time—This is the date on which a message is logged. This information also identifies the applicable time zone.
- Facility—This identifies the system which, in this case is the Cisco BAC.
- Sub-facility—This identifies the Cisco BAC subsystem or component.
- Security Level—The logging system defines seven levels of severity (log levels as described in [Table 21-2](#)) that are used to identify the urgency with which you might want to address log issues. The process of configuring log levels is described in [Configuring Log Levels, page 21-4](#):

**Table 21-2 Logging Levels**

Log Level	Description
0-Emergency	System unstable. Sets the logging function to save all emergency messages.
1-Alert	Immediate action needed. Sets the logging function to save all activities that need immediate action and those of a more severe nature.
2-Critical	Critical conditions exist. Sets the logging function to save all error messages and those of a more severe nature
3-Error	Error conditions exist. Sets the logging function to save all error messages and those of a more severe nature.
4-Warning	Warning conditions exist. Sets the logging function to save all warning messages and those of a more severe nature.
5-Notification	A normal, but significant, condition exists. Sets the logging function to save all notification messages and those of a more severe nature
6-Information	Informational messages. Sets the logging function to save all logging messages available
<b>Note</b>	Another level known as 7-DEBUG is used exclusively by Cisco for debugging purposes. Do not use this level except at the direction of the Cisco TAC.

- Msg ID—This is a unique identifier for the message text.
- Message—This is the actual log message.

**Example 21-1 Sample Log File**

Domain Name	Data and Time	Facility	Sub-facility	Security Level	Msg ID	Message
BAC1:	2006 04 21 07:28:00 EDT:	BAC-	RDU-	6	0236:	BAC Regional Distribution Unit starting up
BAC1:	2006 04 21 07:28:00 EDT:	BAC-	RDU-	6	0566:	Initialized API defaults
BAC1:	2006 04 21 07:28:00 EDT:	BAC-	RDU-	6	0568:	Initialized server defaults

Domain Name	Data and Time	Facility	Sub-facility	Security Level	Msg ID	Message
BAC1:	2006 04 21 07:28:00 EDT:	BAC-	RDU-	6	0569:	Created default admin user
BAC1:	2006 04 21 07:28:00 EDT:	BAC-	RDU-	6	0574:	Loaded 6 license keys
BAC1:	2006 04 21 07:28:00 EDT:	BAC-	RDU-	6	0575:	Database initialization completed in 471 msec
BAC1:	2006 04 21 07:28:00 EDT:	BAC-	RDU-	6	0015:	Unable to locate manifest file
BAC1:	2006 04 21 07:28:00 EDT:	BAC-	RDU-	6	0280:	Command error

## Configuring Log Levels

You can configure logging levels for both the RDU and the DPE to suit your specific requirements. For example, the logging level for the RDU could be set to Warning, and the level for the DPE could be set to Alert.

Log messages are written based on certain events taking place. Whenever an event takes place, the appropriate log message and level are assigned and, if that level is less than or equal to the configured level, the message is written to the log. The message is not written to the log if the level is higher than the configured value.

For example, assume that the log level is set to 4-Warning. All events generating messages with a log level of 4 or less, are written into the log file. If the log level is set to 6-Information, the log file will receive all messages. Consequently, configuring a higher log level results in a larger log file size.

To configure the log level on the DPE, using the **log level** command from the DPE command line. See the [Cisco Broadband Access Center 3.8 DPE CLI Reference](#), for detailed information.

To configure the log level on the RDU, see [The RDU Log Level Tool, page 21-5](#).

## Rotating Log Files

All log files, except *perfstat.log*, are numbered and rolled over based on a configured maximum file size. The default maximum file size is 10 MB. (To configure the maximum file size from the API, use the `ServerDefaultsKeys.SERVER_LOG_MAXSIZE` property.) After a log file touches the configured limit, the data is rolled over to another file. This file is renamed in the *XXX.N.log* format, where:

- *XXX*—Specifies the name of the log file.
- *N*—Specifies any value between 1 and 100.

For example, once *rdu.log* reaches the 10 MB limit, it is renamed as *rdu.1.log*. With every 10-MB increase in file size, the latest file is renamed as *rdu.2.log*, *rdu.3.log*, and so on. So, the *rdu.7.log* file will contain data more recent than *rdu.4.log*. However, the latest log information is always stored in *rdu.log*.

In the case of the *perfstat.log* file, the file is renamed everyday. The file is rolled over in the *perfstat.N.log* format, where *N* is any value between 1 and 100. For example, *perfstat.100.log* will be the oldest log while *perfstat.1.log* will be the most recent renamed *perfstat.log* file.

Cisco BAC stores up to 10 log files at a given time. For a list of log files in the RDU and DPE servers, see [RDU Logs, page 21-5](#), and [DPE Logs, page 21-8](#), respectively.

## RDU Logs

The RDU has two logs that it maintains in the *BPR\_DATA/rdu/logs* directory:

- *rdu.log*—Records all RDU events according to the configured logging severity level. (See [Setting the RDU Log Level, page 21-6](#), for instructions on setting the default log levels.) To view *rdu.log*, see [Viewing the rdu.log File, page 21-5](#).
- *audit.log*—Records all high-level changes to the Cisco BAC configuration or functionality including the user who made the change. To view *audit.log*, see [Viewing the audit.log File, page 21-5](#).
- *troubleshooting.log*—Records detailed device information for troubleshooting a specific device, or a group of devices without turning logging on, and without searching through log files for device- or group-specific information. To view *troubleshooting.log* from the administrator user interface, see [Viewing Device Troubleshooting Log, page 8-12](#).
- *perfstats.log*—Records device performance statistics to help troubleshoot issues related to system performance. For more information, see [Monitoring Cisco Broadband Access Center, page 11-1](#).

### Viewing the rdu.log File

You can use any text processor to view the *rdu.log* file. In addition, you can view the log file from the administrator user interface. To do this:

- 
- Step 1** Choose the **RDU** tab under **Servers**.  
The View Regional Distribution Unit Details page appears.
- Step 2** Click the **View Details** icon () corresponding to RDU Log File.  
The View Log File Contents page appears, displaying data from *rdu.log*.
- 

### Viewing the audit.log File

You can use any text processor to view the *audit.log* file. In addition, you can view the log file from the administrator user interface. To do this:

- 
- Step 1** Choose the **RDU** tab under **Servers**.  
The View Regional Distribution Unit Details page appears.
- Step 2** Click the **View Details** icon corresponding to Audit Log File.  
The View Log File Contents page appears, displaying data from *audit.log*.
- 

### The RDU Log Level Tool

Use the RDU log level tool to change the current log level of the RDU from the command line, using the **setLogLevel.sh** command. This tool is located in the *BPR\_HOME/rdu/bin* directory. [Table 21-2](#) identifies the available log levels and the types of message written to the log file when enabled.

We recommend that you keep the RDU logging level at the Warning level to help maintain a steady operations state. The Information level is recommended to be used with caution if you need to maintain steady state performance during debug operations.

You should exercise caution when running with the Information level set because this creates a great number of log entries, which in itself can adversely impact performance.

**Note**

---

The RDU process has to be up to execute the log level tool. Also, you must be a privileged user to run this tool by using the **setLogLevel.sh** command.

---

## Using the RDU Log Level Tool

All examples assume that the user name for the RDU is **bacadmin**, the password for the RDU is **changeme**, and the RDU server is up.

Enter this command to run the RDU log level tool:

```
setLogLevel.sh [0..6] [-help] [-show] [-default] [-debug]
```

where:

- **-[0..6]**—Identifies the logging level to be used. For a list of available levels, see [Table 21-2](#).
- **-help**—Displays help for the tool.
- **-show**—Displays the current log level set for the RDU server.
- **-default**—Sets the RDU to the installation default level 5 (notification).
- **-debug**— Sets an interactive mode to enable or disable tracing categories for RDU server.

**Note**

---

You should only enable the debug settings that the Cisco support staff recommends.

---

You can also use this tool to perform these functions:

- [Setting the RDU Log Level, page 21-6](#)
- [Viewing the RDU's Current Log Level, page 21-7](#)

## Setting the RDU Log Level

You can use this tool to change the logging level from one value to any other value.

The following example illustrates how to set the RDU logging level to the warning level, as indicated by the number 4 in the **setLogLevel.sh** command. The actual log level set is not important for the procedure, it can be interchanged as required.

To set the RDU logging level:

---

**Step 1** Change directory to BPR\_HOME/rdu/bin.

**Step 2** Run the RDU log level tool using this command:

```
setLogLevel.sh 4
```

This prompt appears:

```
Please type RDU username:
```



**Step 3** Enter the RDU username at the prompt. In this example, the default username (bacadmin) is used.

Please type RDU username: **bacadmin**

This prompt appears:

Please type RDU password:

**Step 4** Enter the RDU password for the RDU at the prompt. In this example, the default password (**changeme**) is used.

Please type RDU password: **changeme**

This message appears to notify you that the log level has been changed. In this example, the level was 5, for notification, and is now 4, for warning.

RDU Log level was changed from 5 (notification) to 4 (warning).

---

### Viewing the RDU's Current Log Level

You can use this tool to view the RDU log and determine which logging level is configured before attempting to change the value.

To view the RDU's current logging level:

---

**Step 1** Change directory to BPR\_HOME/rdu/bin.

**Step 2** Run this command:

```
setLogLevel.sh -show
```

This prompt appears:

Please type RDU username:

**Step 3** Enter the RDU username (**bacadmin**) and press **Enter**.

Please type RDU username: **bacadmin**

This prompt appears:

Please type RDU password:

**Step 4** Enter the RDU password (**changeme**) and press **Enter**.

Please type RDU password: **changeme**

This message appears:

The logging is currently set at level: 4 (warning)

All tracing is currently disabled.

---

## DPE Logs

The DPE maintains its logs at the `BPR_DATA/dpe/logs` directory.

- *dpe.log*—Records all events having the configured default level. In situations where the DPE undergoes catastrophic failure, such as engaging in a series of system crashes, the catastrophic errors are also logged into the *rdu.log* file.
- *perfstats.log*—Records device performance statistics to help troubleshoot issues related to system performance. For more information, see [Monitoring Cisco Broadband Access Center, page 11-1](#).

### Viewing the dpe.log File

You can use any text viewer to view the *dpe.log* file. In addition you can use the **show log** command, from the DPE CLI, to view the log file. See the [Cisco Broadband Access Center 3.8 DPE CLI Reference](#), for additional information.

You can also view the DPE log file using the Cisco BAC administrator user interface. To do this:

- 
- Step 1** Choose **Servers > DPEs**.
- Step 2** Click the link corresponding to the DPE whose log file you want to view.  
The View Device Provisioning Engines Details page appears.
- Step 3** To view the contents of the *dpe.log* file, click the **View Details** icon against DPE Log File in the Log Files area.
- 

## Access Registrar Logs

Cisco BAC generates trace messages from Cisco Access Registrar RADIUS server extensions. The RADIUS server trace resides in the **car-install-path/name\_radius\_1\_trace directory**; car-install-path is a variable and is specific to the value that you enter. The default location for the RADIUS server log file is `/opt/CSCOar/logs/name_radius_1_trace`.

The trace messages emitted using the RADIUS server extensions are based on the extension trace level setting. You can set values (described in Table below) at the trace level; the number you set makes that number the current setting of the extension-trace-level attribute for all extensions.

Use the **aregcmd** command trace to set the trace level in the specified server to a new value. The trace level governs how much information is displayed about the contents of a packet. When the trace level is zero, no tracing is performed. The higher the trace level, the more information displayed. The highest trace level currently used by the CAR server is trace level 5.



#### Note

Although the highest trace level supported by the CAR server is trace level 5, an extension point script might use a higher level. There is no harm in setting the trace to a level higher than 5.

The trace levels are inclusive, meaning that if you set trace to level 3, you will also get the information reported for trace levels 1 and 2. If you set trace level 4, you also get information reported for trace levels 1, 2, and 3. When you do not specify a server, CAR sets the trace level for all of the servers in the current cluster. When you do not specify a value for the trace level, CAR displays the current value of the trace level. The default is 0.

The syntax for setting the trace level is:

**trace** [*server*] [*level*]

**Table 21-3** Trace Levels

Log Level	Description
0	No trace performed.
1	Report when a packet is sent or received or when there is a change in a remote server's status.
2	Indicates the following: <ul style="list-style-type: none"> <li>• Which services and session managers are used to process a packet</li> <li>• Which client and vendor objects are used to process a packet</li> <li>• Detailed remote server information for LDAP and RADIUS, such as sending a packet and timing out</li> <li>• Details about poorly formed packets</li> <li>• Details included in trace level 1</li> </ul>
3	Indicates the following: <ul style="list-style-type: none"> <li>• Error traces in TCL scripts when referencing invalid RADIUS attributes.</li> <li>• Which scripts have been executed</li> <li>• Details about local UserList processing</li> <li>• Details included in trace levels 1 and 2</li> </ul>
4	Indicates the following: <ul style="list-style-type: none"> <li>• Information about advanced duplication detection processing</li> <li>• Details about creating, updating, and deleting sessions</li> <li>• Trace details about all scripting APIs called</li> <li>• Details included in trace levels 1, 2, and 3</li> </ul>
5	Indicates the following: <ul style="list-style-type: none"> <li>• Details about use of the policy engine including: <ul style="list-style-type: none"> <li>– Which rules were run</li> <li>– What the rules did</li> <li>– If the rule passed or failed</li> <li>– Detailed information about which policies were called</li> </ul> </li> <li>• Details included in trace levels 1, 2, 3, and 4</li> </ul>





## GLOSSARY

---

### A

- alert** A syslog or SNMP message notifying an operator or administrator of a problem.
- API** Application programming interface. Specification of function-call conventions that defines an interface to a service.
- audit logs** A log file containing a summary of major changes in the RDU database. This includes changes to system defaults, technology defaults, and classes of service.
- autoconfiguration server (ACS)** A server that provisions a device or a collection of devices. In Cisco BAC, the ACS refers to the Cisco BAC server and in some instances, the DPE.

---

### B

- broadband** Transmission system that multiplexes multiple independent signals onto one cable. In Telecommunications terminology; any channel having a bandwidth greater than a voice-grade channel (4 kHz). In LAN terminology; a co-axial cable on which analog signaling is used.
- Cisco Broadband Access Center (BAC)** An integrated solution for managing and provisioning broadband home networks. BAC is a scalable product capable of supporting millions of devices.

---

### C

- caching** Form of replication in which information learned during a previous transaction is used to process later transactions.
- cipher suites** Provide cryptographic algorithms that the SSL module requires to perform key exchange, authentication, and Message Authentication Code.
- customer premises equipment (CPE)** Terminating equipment, such as telephones, computers, and modems, supplied and installed at a customer location.
- CPE WAN Management Protocol (CWMP)** A standard defined in the TR-069 specification by the Broadband Forum. CWMP integrates the capabilities defined in TR-069 to increase operator efficiency and reduce network management problems.

---

**D**

**device provisioning engine (DPE)** DPE servers cache device instructions and perform CWMP services. These distributed servers automatically synchronize with the RDU to obtain the latest instructions and provide Cisco BAC scalability.

---

**F**

**fully qualified domain name (FQDN)** FQDN is the full name of a system, rather than just its hostname. For example, cisco is a hostname and www.cisco.com is an FQDN.

---

**H**

**HTTPS** *See* Secure Sockets Layer and Transport Layer Security.

---

**I**

**instruction generation** The process of generating policy instructions at the RDU for devices and distributing these instructions to the DPE. The instructions are cached by the DPE and inform about action needed to be performed on the CPE, which may include configuration, firmware upgrade or other operations.

**IP address** An IP address is a 32-bit number that identifies each sender or receiver of information that is sent in packets across the Internet.

---

**N**

**network address translation (NAT)** Mechanism for reducing the need for globally unique IP addresses. NAT allows an organization with addresses that are not globally unique to connect to the Internet by translating those addresses into globally routable address space. This is also known as Network Address Translation.

**network administrator** Person responsible for operation, maintenance, and management of a network. *See also* network operator.

**network operator** Person who routinely monitors and controls a network, performing such tasks as reviewing and responding to alarms, monitoring throughput, configuring new circuits, and resolving problems. *See also* network administrator.

**Network Time Protocol (NTP)** NTP is a protocol designed to synchronize server clocks over a network.

---

**P**

- provisioning API** A series of Cisco BAC functions that programs can use to make the operating system perform various functions.
- provisioning groups** Groupings of devices with a defined set of associated DPE servers, based on either network topology or geography.
- publishing** Publishing provides provisioning information to an external datastore in real time. Publishing plug-ins must be developed to write data to a datastore.

---

**R**

- redundancy** In internetworking, the duplication of devices, services, or connections so that, in the event of a failure, the redundant devices, services, or connections can perform the work of those that failed.
- regional distribution unit (RDU)** The RDU is the primary server in the Cisco BAC provisioning system. It manages generation of device instructions, processes all API requests, and manages the Cisco BAC system.

---

**S**

- Secure Sockets Layer (SSL)** A protocol for transmitting private documents via the Internet. SSL uses a cryptographic system that uses two keys to encrypt data: a public key known to everyone and a private or secret key known only to the recipient of the message. By convention, URLs that require an SSL connection start with https: instead of http:. BAC 3.0 supports SSLv3.
- See* Transport Layer Security.
- shared secret** A character string used to provide secure communication between two servers or devices.

---

**T**

- template files** XML files that contain configuration or firmware rules for devices.
- Transport Layer Security (TLS)** A protocol that guarantees privacy and data integrity between client/server applications communicating over the Internet. BAC 3.0 supports TLSv1.
- See* Secure Sockets Layer.
- TR-069** A standard which defines the CPE WAN Management Protocol (CWMP), which enables communication between CPE and an autoconfiguration server.

---

**V**

**Voice over IP (VoIP)** Mechanism to make telephone calls and send faxes over IP-based data networks with a suitable quality of service (QoS) and superior cost/benefit.

---

**W**

**watchdog agent** A watchdog agent is a daemon process that is used to monitor, stop, start and restart Cisco BAC component processes such as the RDU, JRun, and the SNMP agent.





## INDEX

### A

#### ACS

- definition [GL-1](#)
- URL, configuring [3-9](#)
- URL, discovery [2-6](#)

#### administrator user interface

- accessing [15-2](#)
- ACS URL, configuring [3-9](#)
- BAC architecture, and [9-4](#)
- configuring [15-1](#)
- connection request [12-5](#)
- device's provisioning group, correcting [14-8](#)
- device faults, viewing [8-7](#)
- device history, configuring [8-4](#)
- icons (table) [15-4](#)
- logging in [15-2](#)
  - HTTP transport [15-3](#)
  - SSL transport [15-3](#)
- logging out [15-4](#)
- parameter dictionaries, managing [7-5](#)
  - adding [7-5](#)
  - deleting [7-6](#)
  - replacing [7-6](#)
  - viewing [7-6](#)
- performance statistics, collecting
  - enabling, disabling [11-14](#)
- RDU extensions, managing
  - required points (table) [17-23](#)
- server, monitoring [11-12](#)

#### advanced concepts

- See tools and advanced concepts

#### agent, SNMP

- BAC architecture, and [9-6](#)
- MIB support [11-6](#)

#### alert messages [11-1 to ??, 11-5](#)

- alerts, definition [GL-1](#)
- message format [11-1](#)
- relating to

- DPE [11-2](#)
- RDU [11-2](#)
- watchdog process [11-4](#)

#### API, definition [GL-1](#)

#### architecture [2-1 to ??, 2-8](#)

- about DPEs [2-4](#)
- about provisioning groups [2-6](#)
- about RDU [2-4](#)
- administrator user interface [9-4](#)
- agents
  - SNMP [9-6](#)
  - watchdog process agent [9-2](#)

#### command line interface [9-5](#)

#### deployment [2-1](#)

#### logging [21-2, 21-3](#)

#### overview [2-2, 2-4](#)

#### watchdog process [2-7](#)

#### audit logs, definition [GL-1](#)

#### authentication

- about [13-13](#)
- available options [13-17](#)
- client certificate, configuring [13-16](#)
- external client certificate, configuring [13-16](#)

#### autoconfiguration server

- See ACS

**B**

backup and recovery of database [10-4 to 10-6](#)

**C**

caching, definition [GL-1](#)

cautions

regarding

custom properties, deleting [17-5](#)

disk space requirement figures [10-3](#)

network deployment with an evaluation license key [17-20](#)

template files, deleting [17-19](#)

troubleshooting devices [8-10](#)

cipher suites

definition [GL-1](#)

classes of service

about [4-3](#)

configuring

adding [17-3](#)

deleting [17-4](#)

modifying [17-3](#)

client certificate authentication

configuring [13-16](#)

command line interface

DPE, accessing [9-5](#)

configuration history

See device history

configuration template

about [5-1](#)

administrator user interface, using [17-15, 17-19](#)

authoring [5-14](#)

conditionals, using [5-19](#)

includes, using [5-17](#)

parameter substitution, using [5-16](#)

configuration utility

about [5-22](#)

template, adding [5-23](#)

template processing, testing [5-25, 5-26, 5-27](#)

template syntax, validating [5-24](#)

using [5-23](#)

features [5-4](#)

access control [5-9](#)

notification [5-8](#)

parameters [5-6, 5-7](#)

parameters, schema (figure) [5-6](#)

prerequisites [5-9, 5-13](#)

prerequisites, schema (figure) [5-10](#)

schema (figure) [5-4](#)

template processing files (table) [5-2, 6-4](#)

configuration workflows and checklists

component workflows

DPE checklist (table) [3-2](#)

RDU checklist (table) [3-1](#)

technology workflows

DPE configuration (tables) [3-5](#)

provisioning group configuration [3-8, 3-9](#)

RDU configuration (table) [3-3](#)

RDU configuration, preregistering device data [3-4](#)

configuring BAC

class of service

adding [17-3](#)

deleting [17-4](#)

modifying [17-3](#)

connection requests [12-2](#)

authentication [12-3](#)

disabling [12-10](#)

methods, discovered [12-5](#)

methods, use FQDN [12-5](#)

methods, use IP [12-5, 12-6](#)

reachability [12-11](#)

custom properties [17-5, 17-6](#)

CWMP service

DPE ports [12-2](#)

defaults

configuration options, selecting [17-6](#)

- CWMP [17-7](#)
- RDU [17-10](#)
- system [17-11](#)
- device history
  - enabling, disabling [8-4](#)
  - number of entries [8-5](#)
  - viewing [8-4](#)
- discovering device data
  - about [12-11](#)
  - parameters [12-12, 12-13](#)
- files, managing
  - adding [17-17](#)
  - deleting [17-19](#)
  - exporting [17-19](#)
  - replacing [17-18](#)
  - viewing [17-18](#)
- license keys [17-20, 17-21](#)
  - adding a license [17-21](#)
  - modifying a license [17-21](#)
- provisioning data, publishing
  - Datastore changes [17-26](#)
  - plug-in settings, modifying [17-26](#)
- RDU extensions, managing
  - custom extension points, installing [17-25](#)
  - new class, writing [17-24](#)
  - viewing [17-26](#)
- connection request service
  - about [12-2](#)
  - authentication [12-3](#)
  - disabling [12-10](#)
  - methods [12-5, 12-7](#)
    - discovered [12-5](#)
    - use FQDN [12-5](#)
    - use IP [12-6](#)
  - reachability [12-11](#)
  - workflow (figure) [12-3](#)
- CPE management
  - authentication [13-13](#)
    - available options [13-17](#)
    - client certificate, configuring [13-16](#)
    - external load balancer, configuring [13-16](#)
  - device assignment to provisioning groups [4-20](#)
    - automatic [4-20](#)
    - explicit [4-20](#)
    - explicit and automatic approach [4-20](#)
  - device configuration synchronization [4-15](#)
  - device deployment options [4-16](#)
    - preregistered [4-17](#)
    - unregistered [4-17](#)
  - discovering CPE parameters [4-4](#)
    - default parameters (table) [4-5](#)
  - instruction generation, and [4-14](#)
  - overview [4-1](#)
- customer premises equipment, definition [GL-1](#)
- custom properties
  - configuring [17-5](#)
  - overview [5-15](#)
- CWMP
  - about [1-3](#)
  - definition [GL-1](#)
- CWMP service, configuring
  - connection request [12-2](#)
    - authentication [12-3](#)
    - disabling [12-10](#)
    - method, discovered [12-5](#)
    - method, use FQDN [12-5](#)
    - method, use IP [12-5, 12-6](#)
    - reachability [12-11](#)
  - discovering device data
    - about [12-11](#)
    - parameters [12-12, 12-13](#)
    - troubleshooting [12-13](#)
  - DPE keystore, using keytool [13-3](#)
    - certificates for client authentication, importing [13-10](#)
    - certificate signing request, generating [13-7](#)
    - existing signed server certificate, importing [13-4](#)
    - keytool commands [13-5](#)

- self-signed certificate, displaying [13-7](#)
- server certificate and private key, generating [13-6](#)
- signed certificate, verifying [13-8](#)
- signed certificate into server certificate, importing [13-9](#)
- signing authority certificate into cacerts, importing [13-8](#)
- DPE ports [12-2](#)
- security
  - about [13-1](#)
  - key and certificate management [13-2](#)
- SSL, configuring [13-3](#)

## D

### database management

- backup and recovery
  - backing up [10-4](#)
  - recovering [10-5](#)
  - restoring [10-6](#)
- disk space requirements [10-3, 10-4](#)
  - caution regarding [10-3](#)
  - handling out [10-4](#)

### failure resiliency, understanding [10-1, 10-2](#)

### files [10-2 to 10-3](#)

- automatic log management [10-3](#)
- DB\_VERSION [10-3](#)
- history log [10-3](#)
- storage [10-2](#)
- transaction log [10-2](#)

### location, changing [10-7](#)

### defaults, configuring

- CWMP [17-7](#)
- RDU [17-10](#)
- system [17-11](#)

### device diagnostics

- configuration history, viewing [8-4](#)
- overview [4-21](#)

- performance statistics, monitoring [11-14](#)
  - runStatAnalyzer.sh tool, using [11-15](#)

### Device Export

- deviceExport.sh tool, using [20-1](#)

### device faults

- about [8-6](#)

### device history

- about [8-1](#)
- enabling, disabling [8-4](#)
- number of entries, configuring [8-5](#)
- records, logging [8-5](#)
- supported records (table) [8-1](#)
- viewing [8-4](#)

### device management

- about [16-10](#)
- administrator user interface, using
  - adding [16-11](#)
  - deleting [16-11](#)
  - devices menu [16-4](#)
  - displaying live data [16-16](#)
  - forcing configuration synchronization [16-17](#)
  - forcing firmware upgrade [16-17](#)
  - modifying [16-11](#)
  - performing a Ping test [16-16](#)
  - rebooting [16-15](#)
  - regenerating instructions [16-12](#)
  - relating, unrelating [16-13](#)
  - requesting a connection [16-15](#)
  - resetting to factory settings [16-16](#)
  - searches supported (table) [16-6](#)
  - setting operations timeout [16-18](#)
- controls [16-7](#)
- device details, viewing [16-7](#)
- Manage Devices page [16-4](#)
- searching for devices [16-7](#)
- See also CPE management
- device object model
  - overview [4-2](#)
  - relationships (figure) [4-2](#)

- relationships (table) [4-3](#)
- device operations
  - about [14-1](#)
  - conditional execution [14-6](#)
  - connection modes
    - asynchronous [14-5](#)
    - asynchronous workflow (figure) [14-5](#)
    - immediate [14-2](#)
    - immediate workflow (figure) [14-3](#)
    - on-connect [14-3](#)
    - on-connect workflow (figure) [14-4](#)
  - device's provisioning group, managing [14-6](#)
    - correcting [14-8](#)
  - sample files, accessing [14-1](#)
  - supported operations (table) [14-1](#)
- device troubleshooting
  - about [8-9](#)
  - configuring [8-10](#)
    - disabling [8-11](#)
    - enabling [8-10](#)
  - troubleshooting log, viewing [8-12](#)
  - viewing devices in troubleshooting mode [8-11](#)
- log entries [8-12](#)
- discovered connection request [12-5](#)
- disk space, monitoring
- disk space monitoring
  - disk\_monitor.sh tool, using [20-4](#)
- documentation
  - audience [2-xv](#)
  - related to this product [2-xviii](#)
- DPE (Device Provisioning Engine)
  - about [2-4](#)
  - alert messages [11-2](#)
  - command line interface [9-5](#)
  - component workflow checklist (table) [3-2](#)
  - definition [GL-2](#)
  - dpe.log file, viewing [21-8](#)
  - keystore configuring, using keytool [13-3](#)
  - certificates for client authentication, importing [13-10](#)
  - certificate signing request, generating [13-7](#)
  - existing signed server certificate, importing [13-4](#)
  - self-signed certificate, displaying [13-7](#)
  - server certificate and private key, generating [13-6](#)
  - signed authority certificate into cacerts, importing [13-8](#)
  - signed certificate into server certificate, importing [13-9](#)
- license keys [2-5](#)
- load balancing
  - DNS round robin, using [12-17](#)
  - hardware load balancer, using [12-17](#)
- performance statistics, collecting [11-14, 11-19](#)
  - runStatAnalyzer.sh tool, using [11-15](#)
- ports, configuring [12-2](#)
- RDU synchronization [19-3](#)
- SSL
  - about [13-11](#)
  - authentication options [13-17](#)
  - configuring [13-11](#)
  - configuring CWMP service, example [13-11](#)
  - configuring HTTP file service, example [13-12](#)
  - defaults (table) [13-11](#)
  - device authentication, configuring [13-13](#)
- states [19-4](#)
- technology workflow checklist
  - CWMP service (table) [3-6](#)
  - HTTP file service (table) [3-7](#)
- viewing
  - currently registered DPEs [16-22](#)

---

**F**

- firmware
  - about [6-1](#)
  - files, managing
    - administrator user interface, using [17-15, 17-19](#)

- file service [6-5](#)
- firmware image [6-5](#)
- firmware rules template [6-5](#)
- firmware rules template
  - authoring [6-6](#)
  - constructs [6-13](#)
  - expressions [6-7](#)
  - internal, external files [6-10](#)
  - regular expressions [6-7](#)
  - sample [6-11](#)
- management mechanisms [6-1, 6-4](#)
  - direct firmware [6-4](#)
  - policy based [6-2](#)
- upgrade
  - bypassing, example [6-15](#)
  - forcing [16-17](#)

## FQDN

- definition [GL-2](#)
- use FQDN, connection request [12-5](#)

## G

- group, managing
  - group types
    - deleting [16-20](#)
- groups, managing
  - about [16-20](#)
  - adding [16-20](#)
  - deleting [16-21](#)
  - details, viewing [16-22](#)
  - group types [16-18](#)
    - adding [16-19](#)
    - modifying [16-20](#)
  - modifying [16-21](#)
  - relating, unrelating groups [16-22](#)
- GUI (see administrator user interface)

- 
- icons, administrator user interface (table) [15-4](#)
  - instructions
    - generation, definition [GL-2](#)
    - generation and processing overview [4-14](#)
  - IP address
    - definition [GL-2](#)
    - use IP, connection request [12-6](#)

## K

- key, certificate management [13-2](#)
- keystore
  - about cacerts [13-2](#)
  - about server certificates [13-2](#)
  - configuring, using keytool [13-3](#)
    - certificates for client authentication, importing [13-10](#)
    - certificate signing request, generating [13-7](#)
    - self-signed certificate, displaying [13-7](#)
    - server certificate and private key, generating [13-6](#)
    - signed certificate, verifying [13-8](#)
    - signed certificate into server certificate, importing [13-9](#)
    - signing authority certificate into cacerts, importing [13-8](#)
  - keytool commands, using [13-5](#)
  - sample server certificates [13-3](#)

## L

- license keys, managing [17-20, 17-21](#)
  - adding a license [17-21](#)
  - DPE licensing [2-5](#)
  - modifying a license [17-21](#)
- logging
  - about [2-7](#)
  - BAC architecture, and [21-2, 21-3](#)

- log file, sample [21-3](#)
- log files, rotating [21-4](#)
- log levels, configuring [21-4](#)
- log levels and structures [21-3](#)
- log level tool [21-5](#)
  - current log level, viewing [21-7](#)
  - setting [21-6](#)
  - using [21-6](#)
- viewing log files
  - audit.log [21-5](#)
  - dpe.log [21-8](#)
  - perfstat.log [11-15](#)
  - rdu.log [21-5](#)
  - troubleshooting.log [8-12](#)

logging into BAC [15-2](#)

---

## M

- Multi-Instance Object Support [4-5](#)
  - Configuration Template [4-6](#)
  - Display Live Data Operation [4-13](#)
  - Firmware Rules Template [4-10](#)
  - Parameter Discovery [4-13](#)

---

## N

- NAT, definition [GL-2](#)
- network address translation
  - See NAT
- Network Time Protocol, definition [GL-2](#)

---

## O

- overview
  - configuration management [1-2](#)
  - device diagnostics and troubleshooting [4-21](#)
  - features and benefits [1-1](#)
  - firmware management [1-2](#)

- scalability [1-2](#)
- security [1-2](#)
- technology supported [1-3](#)

---

## P

- parameter dictionary
  - administrator user interface, using [7-5](#)
    - adding [7-5](#)
    - deleting [7-6](#)
    - replacing [7-6](#)
    - viewing [7-6](#)
  - custom [7-3](#)
  - default [7-2](#)
  - overview [7-1](#)
  - schema (figure) [7-2](#)
  - syntax [7-3](#)
- preregistered devices [4-16](#)
- preregistering device data [3-4](#)
- property hierarchy [4-4](#)
- provisioning API, definition [GL-3](#)
- provisioning data, publishing
  - Datastore changes [17-26](#)
  - plug-in settings, modifying [17-26](#)
- provisioning flows
  - initial configuration
    - preregistered devices [4-18](#)
    - unregistered devices [4-19](#)
  - initial configuration (figure) [4-18](#)
- provisioning groups
  - about [2-6](#)
  - ACS URL, configuring [3-9](#)
  - adding a DPE [12-18](#)
  - definition [GL-3](#)
  - device faults, viewing [8-7](#)
  - devices, assigning [4-20](#)
    - automatic [4-20](#)
    - explicit [4-20](#)
    - explicit and automatic [4-20](#)

- redundancy [12-16](#)
  - DNS round robin, using [12-17](#)
  - hardware load balancer, using [12-17](#)
  - local [12-16](#)
  - regional [12-16](#)
- technology workflow [3-8, 3-9](#)
- publishing, definition [GL-3](#)

---

## R

- RDU (Regional Distribution Unit)
  - about [2-4](#)
  - alerts [11-2](#)
  - component workflow checklist (table) [3-1](#)
  - definition [GL-3](#)
  - details, viewing [16-27](#)
  - extensions, managing
    - custom extension points, installing [17-25](#)
    - new class, writing [17-24](#)
    - viewing [17-26](#)
  - log level tool [21-5 to 21-7](#)
    - current log level, viewing [21-7](#)
    - setting [21-6](#)
    - using [21-6](#)
  - performance statistics, collecting [11-14, 11-19](#)
    - runStatAnalyzer.sh tool, using [11-15](#)
  - server, monitoring [11-12](#)
  - technology workflow checklist (table) [3-3](#)
- redundancy
  - local [12-16](#)
  - regional [12-16](#)
- redundancy, definition [GL-3](#)
- parameter dictionary [7-2](#)
- prerequisite [5-10](#)
- Scripting Framework [18-1](#)
  - Adding to the Device Property [18-3](#)
  - Extensions for Unknown Devices [18-4](#)
  - Integrating in BAC [18-3](#)
  - Verifying in DPE Cache [18-5](#)
  - Verifying Status in DPE [18-5](#)
- Secure Sockets Layer
  - See SSL
- security
  - See CWMP service, configuring
- server, monitoring
  - DPE
    - administrator user interface, using [11-12](#)
    - CLI, using [11-12](#)
  - performance statistics collection
    - monitoring [11-14](#)
    - perfstat.log, understanding [11-14](#)
    - runStatAnalyzer.sh tool, using [11-15](#)
  - RDU
    - administrator user interface, using [11-12](#)
  - SNMP agent [11-5](#)
- servers, viewing [16-22](#)
  - DPEs [16-22](#)
  - RDU details [16-27](#)
- service classes
  - See classes of service
- shared secret
  - configuring
    - device password, changing [13-14](#)
    - device password, correcting [13-15](#)
  - definition [GL-3](#)

---

## S

- schema (figures)
  - configuration [5-4](#)
  - parameter [5-6](#)
- SNMP agent
  - about [2-7](#)
  - MIB support [11-6](#)
  - snmpAgentCfgUtil.sh tool
    - community, adding [11-8](#)
    - community, deleting [11-9](#)



- contacts, setting up [11-10](#)
- hosts, adding [11-7](#)
- hosts, deleting [11-7](#)
- listening port, identifying [11-10](#)
- location, changing [11-10](#)
- notification types, specifying [11-11](#)
- settings, displaying [11-11](#)
- starting [11-9](#)
- stopping [11-9](#)

## SSL

- configuring [13-3, 13-11](#)
  - CWMP service, example [13-11](#)
  - DPE keystore, keytool commands (table) [13-5](#)
  - DPE keystore, using keytool [13-3, 13-10](#)
  - HTTP file service, example [13-12](#)

- definition [GL-3](#)

## synchronization

- configuration synchronization instruction [4-15](#)
- data synchronization instruction [4-15](#)
- device configuration [4-15](#)
- DPE-RDU [19-3](#)

---

## T

### template files, developing

- template file definition [GL-3](#)

### templates

- configuration [5-1, 5-13](#)
- configuration utility
  - running [5-23](#)
  - template, adding [5-23](#)
  - template processing, testing [5-25, 5-26, 5-27](#)
  - template syntax, validating [5-24](#)

### constructs

- conditionals [5-19](#)

### firmware rules [6-2, 6-4](#)

- authoring [6-6](#)
- constructs [6-13](#)

## TLS

- definition [GL-3](#)

- See [SSL](#)

## tools and advanced concepts

### configuration utility

- adding template file [5-23](#)
- running [5-23](#)
- testing template processing [5-25, 5-26, 5-27](#)
- validating template file [5-24](#)

- deviceExport.sh tool [20-1](#)

- disk\_monitor.sh tool [20-4](#)

- keytool utility [13-3](#)

- list of tools [9-7](#)

- RDU log level tool [21-5, 21-7](#)

- current log level, viewing [21-7](#)

- setting [21-6](#)

- using [21-6](#)

### snmpAgentCfgUtil.sh tool

- SNMP agent, starting [11-9](#)

- SNMP agent, stopping [11-9](#)

- SNMP agent community, adding [11-8](#)

- SNMP agent community, deleting [11-9](#)

- SNMP agent hosts, adding [11-7](#)

- SNMP agent hosts, deleting [11-7](#)

- SNMP agent location, changing [11-10](#)

- SNMP agent settings, displaying [11-11](#)

- SNMP contacts, setting up [11-10](#)

- SNMP listening port, identifying [11-10](#)

- SNMP notification types, specifying [11-11](#)

- watchdog agent tool [9-2](#)

- TR-069, definition [GL-3](#)

## Transport Layer Security

- See [TLS](#)

## troubleshooting

### alert messages

- DPE [11-2](#)

- message format [11-1](#)

- RDU alerts [11-2](#)

- syslog [11-1 to 11-5](#)

- watchdog process [11-4](#)

## devices

- configuration history, viewing [8-4](#)

- data discovery [12-13](#)

- in troubleshooting mode [8-9](#)

- recurring faults, viewing [8-7](#)

## performance statistics collection

- monitoring [11-14](#)

- perfstat.log [11-15](#)

- runStatAnalyzer.sh tool, using [11-15](#)

## servers, viewing

- DPEs details [16-22](#)

- provisioning groups details [16-26](#)

- RDU details [16-27](#)

## user management

- adding a new user [16-2](#)

- deleting users [16-4](#)

- modifying users [16-3](#)

---

**U**

- unregistered devices [4-16](#)

## users

- about [16-1](#)

- administrator [16-1](#)

## managing

- adding [16-2](#)

- deleting [16-4](#)

- modifying [16-3](#)

- read-only user [16-2](#)

- read-write user [16-2](#)

- users, managing [16-1, 16-4](#)

## using BAC

## devices, managing

- about [16-10](#)

- adding [16-11](#)

- controls [16-7](#)

- deleting [16-11](#)

- details, viewing [16-7](#)

- modifying [16-11](#)

- regenerating instructions [16-12](#)

- relating, unrelating [16-13](#)

## groups, managing

- adding [16-20](#)

- deleting [16-21](#)

- details, viewing [16-22](#)

- modifying [16-21](#)

- relating, unrelating [16-22](#)

---

**V**

- VoIP, definition [GL-4](#)

---

**W**

## watchdog process

- about [2-7, 9-1](#)

- agent, definition [GL-4](#)

- alerts [11-4](#)

- command line, using [9-2](#)

## Free Manuals Download Website

<http://myh66.com>

<http://usermanuals.us>

<http://www.somanuals.com>

<http://www.4manuals.cc>

<http://www.manual-lib.com>

<http://www.404manual.com>

<http://www.luxmanual.com>

<http://aubethermostatmanual.com>

Golf course search by state

<http://golfingnear.com>

Email search by domain

<http://emailbydomain.com>

Auto manuals search

<http://auto.somanuals.com>

TV manuals search

<http://tv.somanuals.com>