

Cisco Digital Set-Top Models Z870DVB and Z880DVB Digital Video Recorders



Notice for Installers

The servicing instructions in this notice are for use by qualified service personnel only. To reduce the risk of electric shock, do not perform any servicing other than that contained in the operating instructions, unless you are qualified to do so.

Note to System Installer

For this apparatus, the coaxial cable shield/screen shall be grounded as close as practical to the point of entry of the cable into the building. For products sold in the US and Canada, this reminder is provided to call the system installer's attention to Article 820-93 and Article 820-100 of the NEC (or Canadian Electrical Code Part 1), which provides guidelines for proper grounding of the coaxial cable shield.



This symbol is intended to alert you that uninsulated voltage within this product may have sufficient magnitude to cause electric shock. Therefore, it is dangerous to make any kind of contact with any inside part of this product.

Ce symbole a pour but d'alerter toute personne qu'un contact avec une pièce interne de ce produit, sous tension et non isolée, pourrait être suffisant pour provoquer un choc électrique. Il est donc dangereux d'être en contact avec toute pièce interne de ce produit.



CAUTION
RISK OF ELECTRIC SHOCK
DO NOT OPEN

AVIS
RISQUE DE CHOC ÉLECTRIQUE
NE PAS OUVRIIR

CAUTION: To reduce the risk of electric shock, do not remove cover (or back). No user-serviceable parts inside. Refer servicing to qualified service personnel.

WARNING
TO PREVENT FIRE OR ELECTRIC SHOCK, DO NOT EXPOSE THIS UNIT TO RAIN OR MOISTURE.



This symbol is intended to alert you of the presence of important operating and maintenance (servicing) instructions in the literature accompanying this product.

Ce symbole a pour but de vous avertir qu'une documentation importante sur le fonctionnement et l'entretien accompagne ce produit.

20080814_Installer820

U.S. Patents

A patent notice is affixed to this product. In addition, the product may also be covered by one or more of the following patents:

4,498,169; 4,692,919; 4,748,667; 4,829,569; 4,866,770; 4,885,775; 4,888,799; 4,890,319; 4,922,456; 4,922,532; 4,924,498; 4,965,534; 4,991,011; 5,003,384; 5,012,510; 5,029,207; 5,045,816; 5,053,883; 5,054,071; 5,058,160; 5,142,575; 5,142,690; 5,146,526; 5,155,590; 5,214,390; 5,225,902; 5,225,925; 5,235,619; 5,237,610; 5,239,540; 5,241,610; 5,247,364; 5,255,086; 5,257,403; 5,367,071; 5,270,809; 5,271,041; 5,272,752; 5,282,028; 5,285,497; 5,287,351; 5,301,028; 5,309,514; 5,317,391; 5,319,709; 5,341,425; 5,347,388; 5,347,389; 5,357,276; 5,359,601; 5,361,156; 5,367,571; 5,379,141; 5,379,145; 5,381,481; 5,390,337; 5,400,401; 5,406,558; 5,418,782; 5,420,866; 5,420,923; 5,425,101; 5,428,404; 5,430,568; 5,434,610; 5,436,749; 5,438,370; 5,440,632; 5,442,472; 5,455,570; 5,457,701; 5,471,492; 5,477,199; 5,477,262; 5,477,282; 5,477,370; 5,481,389; 5,481,542; 5,485,221; 5,493,339; 5,497,187; 5,500,758; 5,502,499; 5,506,904; 5,519,780; 5,539,822; 5,550,825; 5,579,055; 5,579,057; 5,583,562; 5,592,551; 5,596,606; 5,600,378; 5,602,933; 5,640,388; 5,657,414; 5,675,575; 5,684,876; 5,715,515; 5,724,525; 5,734,822; 5,740,300; 5,742,677; 5,754,940; 5,757,416; 5,771,064; 5,774,859; 5,825,829; 5,826,167; 5,850,305; 5,854,703; 5,870,474; 5,892,607; 5,920,626; 5,923,755; 5,930,024; 5,930,515; 5,937,067; 5,963,352; 5,966,163; 5,982,424; 5,991,139; 5,999,207; 6,005,631; 6,005,938; 6,016,163; 6,028,941; 6,029,046; 6,052,384; 6,055,244; 6,072,532; 6,105,134; 6,148,039; 6,157,719; 6,188,729; 6,195,389; 6,212,278; 6,215,530; 6,219,358; 6,240,103; 6,243,145; 6,246,767; 6,252,964; 6,272,226; 6,292,081; 6,292,568; 6,320,131; 6,374,275; 6,405,239; 6,411,602; 6,417,949; 6,424,714; 6,424,717; 6,433,906; 6,438,139; 6,463,586; 6,467,091; 6,476,878; 6,493,876; 6,510,519; 6,516,002; 6,516,412; 6,526,508; 6,538,595; 6,546,013; 6,560,340; 6,567,118; 6,570,888; 6,622,308; 6,629,227; 6,664,984; 6,667,994; 6,671,879; 6,674,967; 6,678,891; 6,714,598; 6,721,352; 6,721,956; 6,725,459; 6,738,982; 6,744,892; 6,744,967; 6,751,271; 6,760,918; 6,795,972; 6,802,077; 6,804,708; 6,811,447; 6,817,028; 6,822,972; 6,823,385; 6,832,386; 6,845,106; 6,868,473; 6,874,075; 6,889,191; 6,909,471; 6,917,622; 6,917,628; 6,922,412; 6,927,806; 6,928,656; 6,931,058; 6,937,729; 6,969,279; 6,971,008; 6,971,121; 6,978,310; 6,986,156; 6,988,900; 6,996,838; 7,010,801; 7,053,960; 7,065,213; 7,069,578; 7,069,578; D348065; D354959; D359737; D363932; D390217; D434753; D507240; D507535; D513407; D516518; RE36368; RE36988

20070417 Patents

Contents

- IMPORTANT SAFETY INSTRUCTIONS2
- Welcome4
- Safety First4
- Serial Number and MAC Address4
- About the Remote Control5
- Front Panel6
- Back Panel7
- Connecting the Set-Top8
- Connecting to a TV9
- Watch TV10
- Setup Wizard10
- Set Parental Control PIN10
- Revert to Factory Settings11
- Navigator Bar11
 - Color-Coded Options11
- Main Menu12
 - Accessing the Categories Menu12
- DVR Functions13
 - Controlling Live TV and Recordings13
 - Instant Recording14
 - Recording Menu15
 - Electronic Program Guide16
 - Manual Recording16
 - Recording Settings16
 - Electronic Program Guide16
 - Record from the Program Guide17
 - Block and Unblock Channels17
 - Program Information17
 - Options17
 - Favorite List18
 - Program Reminders18
 - Displaying Picture-in-Picture19
 - Mosaic19
 - Messages20
 - Pay-Per-View Events21
 - Troubleshooting22
 - No Picture22
 - No Color22
 - No Sound22
 - Disclaimer22

IMPORTANT SAFETY INSTRUCTIONS

- 1) Read these instructions.
- 2) Keep these instructions.
- 3) Heed all warnings.
- 4) Follow all instructions.
- 5) Do not use this apparatus near water.
- 6) Clean only with dry cloth.
- 7) Do not block any ventilation openings. Install in accordance with the manufacturer's instructions.
- 8) Do not install near any heat sources such as radiators, heat registers, stoves, or other apparatus (including amplifiers) that produce heat.
- 9) Do not defeat the safety purpose of the polarized or grounding-type plug. A polarized plug has two blades with one wider than the other. A grounding-type plug has two blades and a third grounding prong. The wide blade or the third prong are provided for your safety. If the provided plug does not fit into your outlet, consult an electrician for replacement of the obsolete outlet.
- 10) Protect the power cord from being walked on or pinched particularly at plugs, convenience receptacles, and the point where they exit from the apparatus.
- 11) Only use attachments/accessories specified by the manufacturer.
- 12)  Use only with the cart, stand, tripod, bracket, or table specified by the manufacturer, or sold with the apparatus. When a cart is used, use caution when moving the cart/apparatus combination to avoid injury from tip-over.
- 13) Unplug this apparatus during lightning storms or when unused for long periods of time.
- 14) Refer all servicing to qualified service personnel. Servicing is required when the apparatus has been damaged in any way, such as a power-supply cord or plug is damaged, liquid has been spilled or objects have fallen into the apparatus, the apparatus has been exposed to rain or moisture, does not operate normally, or has been dropped.

Power Source Warning

A label on this product indicates the correct power source for this product. Operate this product only from an electrical outlet with the voltage and frequency indicated on the product label. If you are uncertain of the type of power supply to your home or business, consult your service provider or your local power company.

The AC inlet on the unit must remain accessible and operable at all times.

Ground the Product



WARNING: Avoid electric shock and fire hazard! If this product connects to coaxial cable wiring, be sure the cable system is grounded (earthed). Grounding provides some protection against voltage surges and built-up static charges.



WARNING: Avoid electric shock and fire hazard! Do not locate an outside antenna system in the vicinity of overhead power lines or power circuits. Touching power lines or circuits might be fatal.

This product may contain a tuner capable of receiving off-the-air broadcasts.

Protect the Product from Lightning

In addition to disconnecting the AC power from the wall outlet, disconnect the signal inputs.

Verify the Power Source from the On/Off Power Light

When the on/off power light is not illuminated, the apparatus may still be connected to the power source. The light may go out when the apparatus is turned off, regardless of whether it is still plugged into an AC power source.

Eliminate AC Mains Overloads



WARNING: Avoid electric shock and fire hazard! Do not overload AC mains, outlets, extension cords, or integral convenience receptacles. For products that require battery power or other power sources to operate them, refer to the operating instructions for those products.

IMPORTANT SAFETY INSTRUCTIONS, continued

Handling Disposable Batteries

This product may contain disposable batteries. Heed the following warning and follow the Safety and Disposal instructions below.



WARNING: There is danger of explosion if the battery is mishandled or incorrectly replaced. Replace only with the same type of battery. Do not disassemble it or attempt to recharge it outside the system. Do not crush, puncture, dispose of in fire, short the external contacts, or expose to water or other liquids. Dispose of the battery in accordance with local regulations and instructions from your service provider.

Safety

- Insert batteries correctly. There may be a risk of explosion if the batteries are incorrectly inserted.
- Do not attempt to recharge 'disposable' or 'non-reusable' batteries.
- Please follow instructions provided for charging 'rechargeable' batteries.
- Replace batteries with the same or equivalent type that we recommend.
- Do not expose batteries to excessive heat (such as sunlight or fire).
- Do not expose batteries to temperatures above 100°C (212°F).

Disposal

- The batteries may contain substances that could be harmful to the environment.
- Recycle or dispose of batteries in accordance with the battery manufacturer's instructions and local/national disposal and recycling regulations.



廢電池請回收

- The batteries may contain perchlorate, a known hazardous substance, so special handling and disposal of this product might be necessary. For more information about perchlorate and best management practices for perchlorate-containing substance, see www.dtsc.ca.gov/hazardouswaste/perchlorate

Provide Ventilation and Select a Location

- Remove all packaging material before applying power to the product.
- Do not place this apparatus on a bed, sofa, rug, or similar surface.
- Do not place this apparatus on an unstable surface.
- Do not install this apparatus in an enclosure, such as a bookcase or rack, unless the installation provides proper ventilation.
- Do not place entertainment devices (such as VCRs or DVDs), lamps, books, vases with liquids, or other objects on top of this product.
- Do not block ventilation openings.

Protect from Exposure to Moisture and Foreign Objects



WARNING: Avoid electric shock and fire hazard! Do not expose this product to dripping or splashing liquids, rain, or moisture. Objects filled with liquids, such as vases, should not be placed on this apparatus.



WARNING: Avoid electric shock and fire hazard! Unplug this product before cleaning. Do not use a liquid cleaner or an aerosol cleaner. Do not use a magnetic/static cleaning device (dust remover) to clean this product.



WARNING: Avoid electric shock and fire hazard! Never push objects through the openings in this product. Foreign objects can cause electrical shorts that can result in electric shock or fire.

Service Warnings



WARNING: Avoid electric shock! Do not open the cover of this product. Opening or removing the cover may expose you to dangerous voltages. If you open the cover, your warranty will be void. This product contains no user-serviceable parts.

Check Product Safety

Upon completion of any service or repairs to this product, the service technician must perform safety checks to determine that this product is in proper operating condition.

Protect the Product When Moving It

Always disconnect the power source when moving the apparatus or connecting or disconnecting cables.

20090326_Cable_Safety

Welcome

Enjoy crystal clear pictures and CD quality sound with your Cisco® Z870DVB and Z880DVB Digital Video Recorders. Best of all, you can watch what you want to watch when you want to watch it at the press of a button. It's all described in this user guide. Go through it right away to learn about each feature and to help you enjoy your experience to the fullest.

Safety First

Before using the set-top, read the Important Safety Instructions section of this guide.

Serial Number and MAC Address

Your service provider may ask for the serial number or the MAC address of the set-top if your system requires troubleshooting in the future.

Look for the serial number and the MAC address on the bottom of the set-top.

Write the serial number here: _____

Write the MAC address here: _____

About the Remote Control



1. Set-top mode control
2. TV mode control
3. Power On and Off
4. Access DVR recordings
5. Watch live TV
6. Pause recording
7. Fast-forward recording
8. Set a recording
9. Access the Main Menu
10. Obtain program information
11. Go to last channel or previous menu item
12. Page through the program guide
13. Scroll through menu items
14. Access color-coded screen options
15. Access ON DEMAND features
16. Scroll through channels
17. Select Favorite channels
18. Access specific channels
19. Access Picture-in-Picture (PIP) features
20. Mute volume
21. Adjust volume
22. Page through the program guide
23. Exit the guide
24. Access the guide
25. Rewind recording
26. Play recording
27. Stop recording playback
28. Instant Replay (go back 7 seconds)

T13968

Front Panel

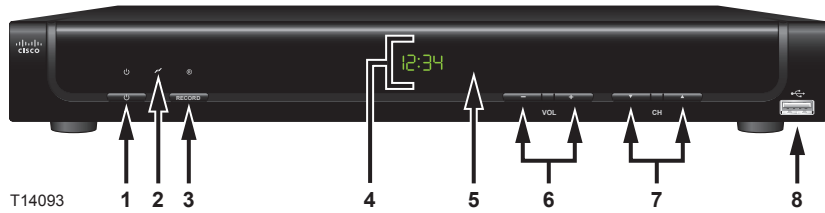

- | | |
|---------------------|---|
| 1 Power | Turns the set-top on and off |
| 2 Arrows | Indicates an active cable modem link |
| 3 Record | Press to enable an instant recording.
Note: Ⓜ illuminates to indicate a recording in progress |
| 4 Display | Displays the selected channel number and time of day |
| 5 IR Sensor | Receives the infrared signal from the remote control.
The sensor is behind the front panel |
| 6 Vol-, Vol+ | Adjusts volume |
| 7 CH-, CH+ | Scrolls through channels |
| 8 USB Port | Reserved for future use |

Back Panel

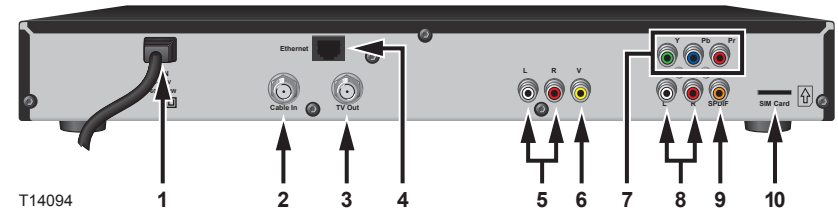

- | | |
|---------------------------|---|
| 1 AC In | Connects to a power receptacle |
| 2 Cable In | Connects to the coaxial cable that delivers the signal from your service provider |
| 3 TV Out | Connects to RF input of TV |
| 4 Ethernet | Connects to Ethernet-equipped device |
| 5 L/R | Connects to left/right audio inputs of TV or other device |
| 6 V | Connects to composite video input of TV |
| 7 Y PB PR | Connects to component video input of TV |
| 8 L/R | Connects to left/right audio inputs of TV or other device |
| 9 SPDIF | Connects to digital audio input of a TV or other device |
| 10 SIM Card Reader | Reserved for future use |

Connecting the Set-Top

To connect your set-top to your entertainment devices, complete these steps.



1

Connect your TV to the set-top. (See connection diagram.)



2

Plug the set-top and the TV into a power source that is not controlled by a wall switch.



POWER

3

Do not turn on the set-top or TV yet.



4

Wait for the green LED to illuminate. It may take several minutes for the set-top to receive the latest software, programming, and service information.



5

Press **POWER** on the remote control.

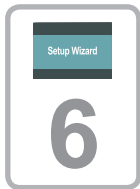

6

The first time you turn on the set-top, the Setup Wizard will start. Read and follow the directions on the screen to get your set-top ready for use.

Connecting to a TV



WARNING:

Electric shock hazard! Unplug all electronic devices before connecting or disconnecting any device cables to the set-top.

Back of Z880DVB

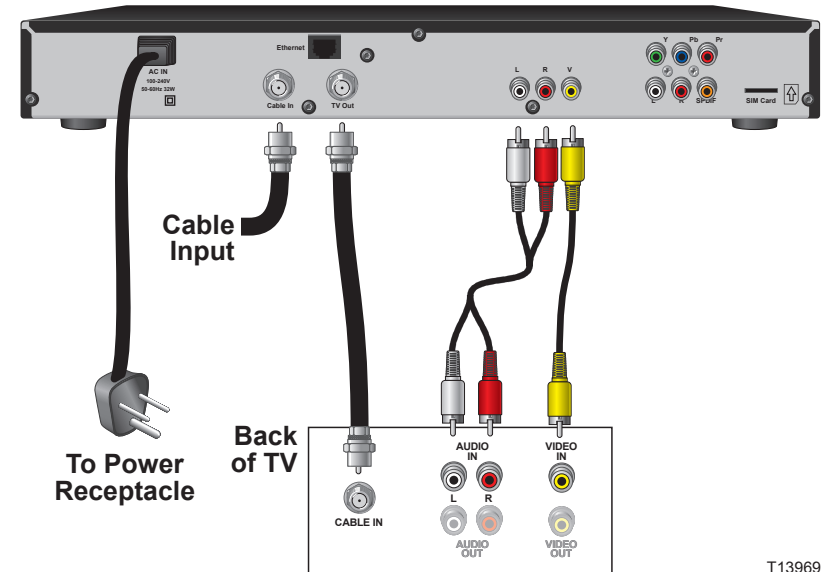

T13969

Watch TV

When you turn on the set-top, you will see a screen similar to this one until the set-top has downloaded the latest programming information.

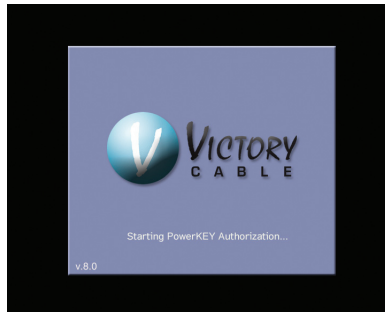

Setup Wizard

The first time you turn on the set-top, you may see the Setup Wizard window. In the Setup Wizard you can select the language and screen settings for your set-top.

Read and follow the directions on each screen of the Setup Wizard.

If you want to change any of the settings at a later time, you can access various settings by pressing the **HOME** key on the remote control and navigating to the **Settings** option.

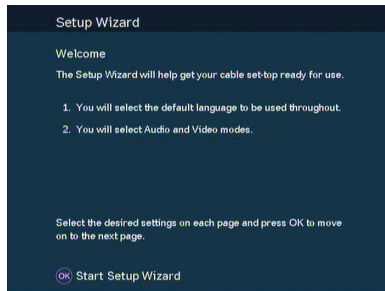

Set Parental Control PIN

To set the Parental Control PIN, press the **HOME** key on the remote control, access the **Settings** option, and scroll to **Set Block PIN**. The first time you select this option, you must enter the Default PIN number (4321). The next time you access the Expert Setup option, you can enter a new PIN number that is more meaningful to you.

Remember the PIN you choose because you will use it to block and unblock TV programs or channels for viewing.

Press the number keys on the remote control to enter your PIN number, and then press the **OK** key on the remote control.

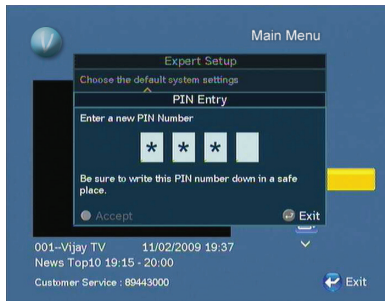

Revert to Factory Settings

All of your setup choices will be erased if you choose the Revert to Factory Settings option.

Navigator Bar

The Navigator Bar displays information about current and future programs.

To access the Navigator Bar, press the **INFO** key on the remote control.

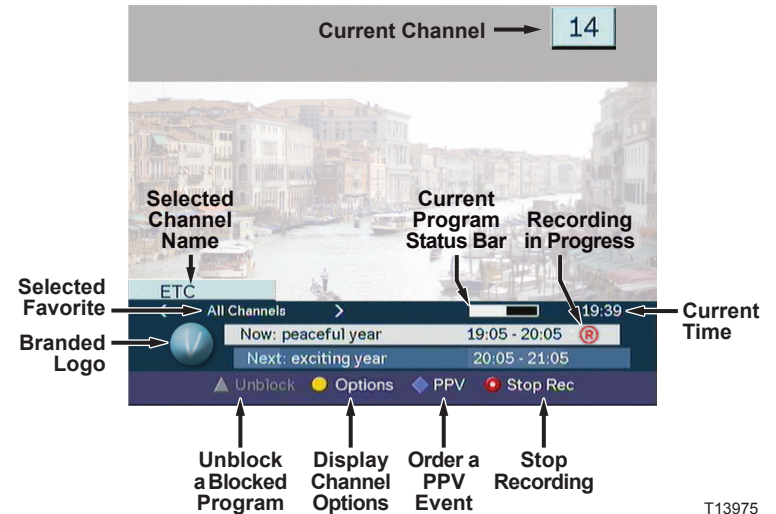

T13975

Color-Coded Options

The selection options at the bottom of the Navigator Bar (and on several other screens) are color-coded to match these four keys on your remote control. To access your selection, press the color-coded key on the remote control.



T13976

Main Menu

The Main Menu provides a menu of your favorite interactive services and popular channels. To access the Main Menu press the **HOME** button on your remote control.

Program Guide – Lists channel program schedules for the current and future days.

Categories – Provides a sub-set of program guide categories organized according to their type, such as entertainment and sports.

Favorites – Allows you to set up your favorite channels.

Recording Menu – Provides access to the scheduled list, recorded library, manual recording feature, and recording settings.

Settings – Allows you to modify the default set-top settings, such as audio mode.

Mosaic – Displays a group of video images that you can navigate and display a full-screen image.

Messaging – Allows you to access messages from your service provider.

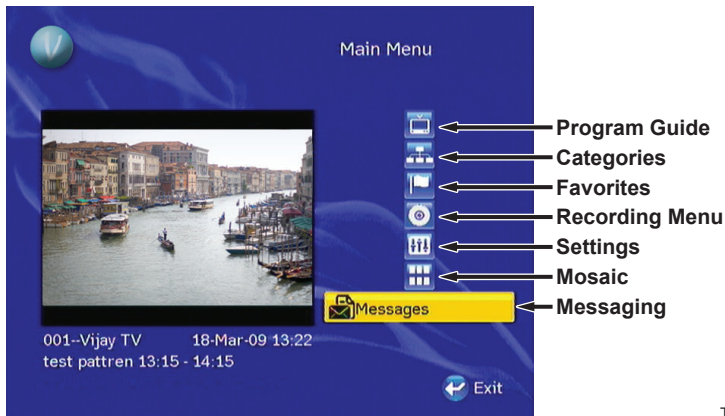

T13982

DVR Functions

Controlling Live TV and Recordings

You can control live TV and recordings while you are watching live TV because the DVR buffers (stores) 60 minutes of content. Follow these instructions to control live TV and your recordings.

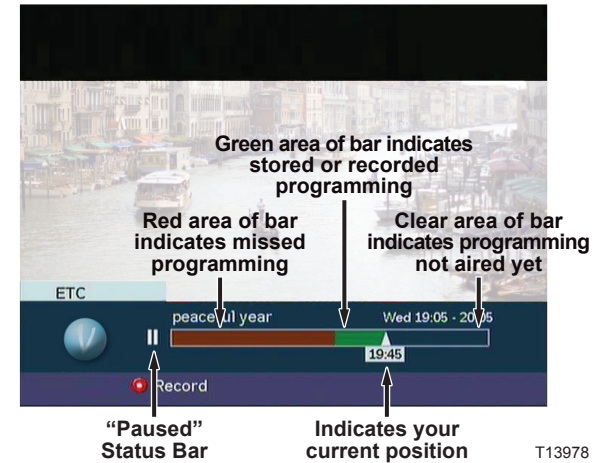

T13978

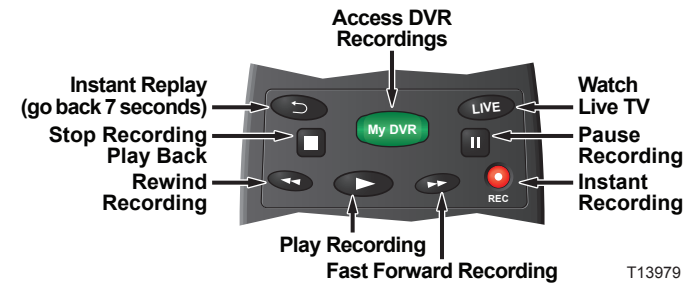

T13979

Controlling Live TV and Recordings, continued

1. Press the **PAUSE** button to pause live TV or a recording.
2. Press the **PLAY** button to resume playing live TV or a recording.
3. Press the **REWIND** or the **FAST FORWARD** buttons one, two, or three times to rewind or fast-forward at different speeds.
4. Press the **LIVE** button to catch up to live TV.
5. Press the **PAUSE** button and then press the **FORWARD** or **REWIND** keys to activate slow motion while watching live TV. To resume normal play, press the **PLAY** button again.
6. Press the **INSTANT REPLAY** button to see the last 7 seconds of live TV or recording.

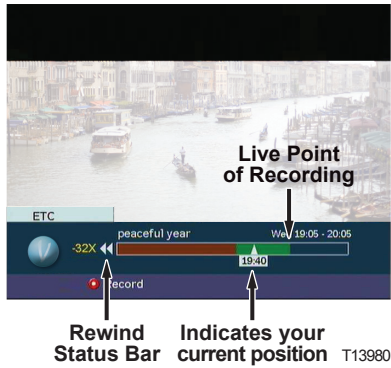

Instant Recording

To perform an Instant Recording, press **RECORD** on the remote control, navigate to the selection and press **OK**.

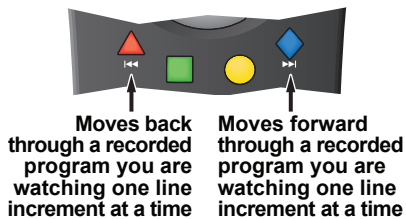

T14004

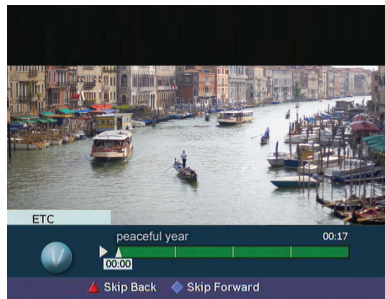

Recording Menu

The Recording Menu provides a menu of recording options for using and configuring DVR features. To access the Recording Menu press the **HOME** button on your remote control and navigate to the Recording Menu.

Scheduled List — Displays a list of programs scheduled to record.

Recorded Library — Displays a list of programs stored on your DVR.

Manual Recording — Allows you to manually set recordings by channel, date, and time.

Recording Settings — Allows you to set how you want your programs to be displayed in the Scheduled List and the Recorded Library.

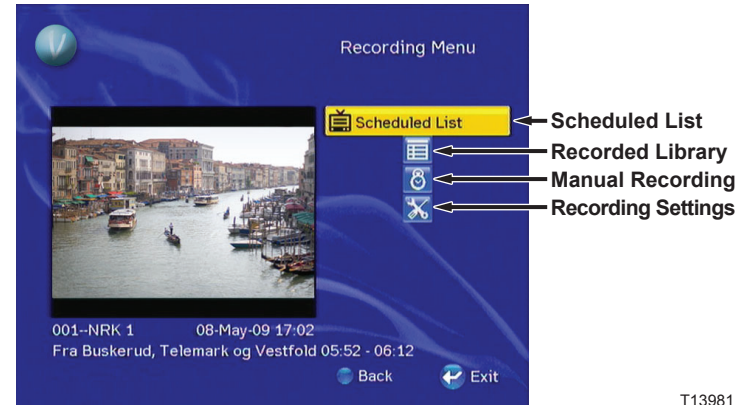

T13981

You can access the Recorded Library directly by pressing the **My DVR** button on the remote control.



Access DVR Recordings



T14005



Manual Recording

1. Access the **Recording Menu** screen from the Main Menu.
2. Select **Manual Recording** from the Recording Menu screen.
3. Use the arrow keys to find a channel you want to record and to set the time to record it.
4. Press **OK** to save and exit when you have made all your selections.



Recording Settings

The Recording Settings window enables you to set how to sort your programs in the Recording List and Scheduled List. You can sort the programs by channel, date, and time.



Electronic Program Guide

The Electronic Program Guide (EPG) displays channel program schedules for the current and future days.

Use the arrow keys and the **OK** key on the remote control to scroll through the guide and select the program you want to view.

Use the color-coded keys on the remote control to access the list of your favorite channels, program schedules for the previous or next day, or the timer screen for program reminders.

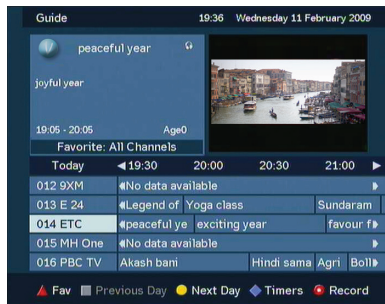

Record From the Program Guide

1. Press the **GUIDE** button.
2. Press the arrow buttons to select a program, and then press the **RECORD** button.
3. Choose your recording options and then press **OK**.
4. Review the recording you just set in the Scheduled List, press the **HOME** key to go to the Recording Menu, and then navigate to the Scheduled List.

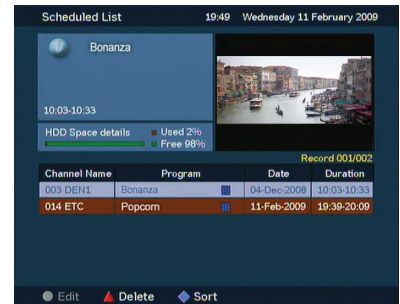

Block and Unblock Channels

You will see the Blocked Channel window when you tune to a program that is blocked by Parental Control Rating.

To unblock the program, press the **INFO** key on the remote control, press the red triangle key, and then enter your four-digit Parental Control PIN in the PIN Entry window.

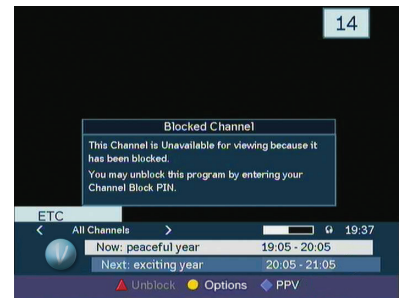

Program Information

To access program information, press the **INFO** key on the remote control.

The Info window displays detailed information about the current program. Press the right arrow key to scroll to information about the next program.



Options

To access the Options window, press the **INFO** key on the remote control, and then press the color-coded key on the remote control for the channel options.

The Options window displays selectable audio and video settings for the current channel.

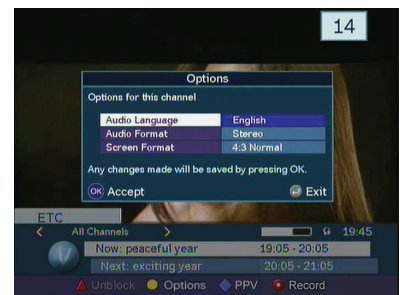

Favorite List

Access the Electronic Program Guide (EPG) by pressing the **GUIDE** key or from the Main Menu.

To access the Favorite window, press the color-coded key on the remote control.

To add, change, delete or move programs or channels in the list or to edit the Favorite list, press the color-coded key on your remote control.

To select a favorite program list, scroll through the list and then press **OK**.

If the set-top is in Radio mode, you will see a list of favorite radio channels.

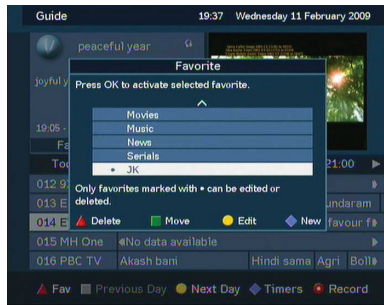

Program Reminders

You can set a timer to remind you that a specific program is about to begin.

You can access the Timers window from the EPG or from the Info window by pressing the color-coded key on the remote control.

If you set a reminder from the program Info window, all relevant information about the reminder is automatically filled in when the Set Reminder window is displayed.

When it is time for the event to start, a message appears on the screen 30 seconds before the start of the event. You have the option to tune to the channel or to cancel the timer.

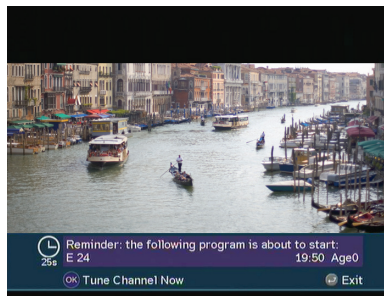
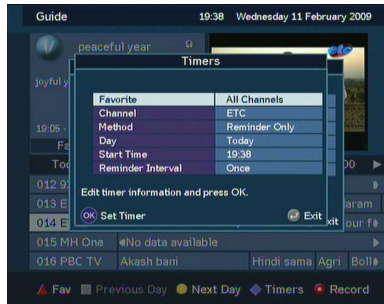

Displaying Picture-In-Picture (PIP)

1. Press the **PIP ON/OFF** button to display or hide the PIP screen.
2. Press the **PIP +** or **PIP -** buttons to change the PIP screen channel.
3. Press the **PIP SWAP** button to swap the TV program in the PIP screen with the program in the Main screen.
4. While the PIP screen is active, press the **INFO** button to display the Main screen channel banner.

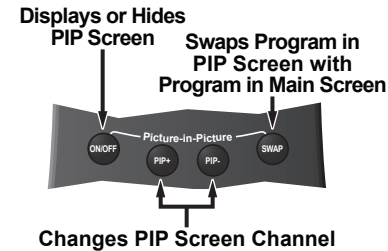

T13977



Mosaic

Mosaic displays a group of video images that you can navigate and display a full screen image. From the Main Menu, select **Mosaic** and select the **Mosaic Channel** to watch. Press the up, down, left, and right arrows on the remote to make your selection from the mosaic and press the **OK** button on your remote to tune to the service.



Messages

While you watch TV, your service provider can send you messages. Depending upon the severity, messages are delivered in a format appropriate for the message. An alert is a message from your service provider regarding your account and various promotions. When you receive an alert message, a message icon appears on the screen. You should check this message immediately.

When the mail icon is visible on the screen, press the **HOME** button on the remote to display the Main Menu screen. Select **Messages** and press **OK** on the remote to display a list of messages stored in the set-top.

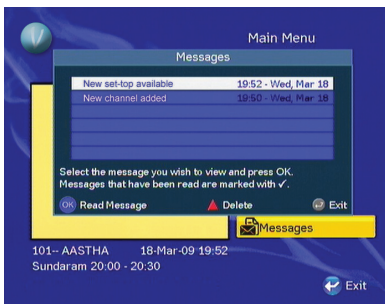

Pay-Per-View Events

To purchase a pay-per-view (PPV) event, press the color-coded key on the remote control.

In the PPV Event window, scroll to the event (program) you want to purchase. Read and follow the instructions for ordering the event.

Each event needs to be purchased through a call center or by sending a text message through your mobile phone. Contact your service provider for more information on how to order a PPV event.

Read and follow the instructions in the Confirm PPV Purchase window to order the event.

Then, select the **Yes, I have ordered!** option by pressing the color-coded key on the remote control to confirm your purchase. A program reminder (timer) will be automatically set for this PPV event.

If you press the **EXIT** key on the remote control, this indicates that you do not intend to purchase the event.

When it is time for the event to start, a message appears on the screen 30 seconds before the start of the event. You have the option to tune to the channel or to cancel the timer. The event will automatically begin if you do not press **OK** on the remote control within 30 seconds.

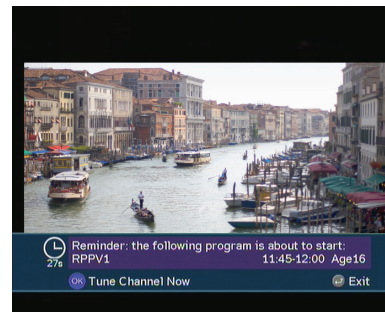
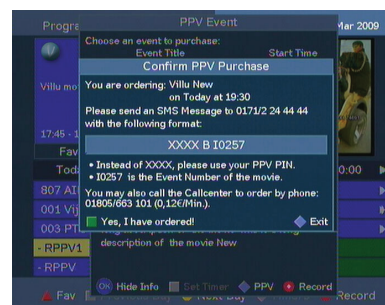
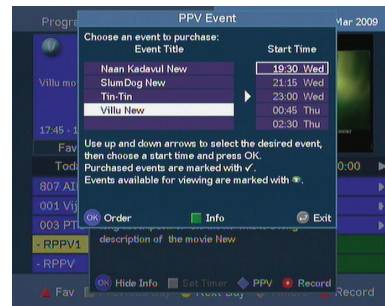

Troubleshooting

If the set-top does not perform as expected, the following tips may help. If you need further assistance, contact your service provider.

No Picture

- Plug the TV and set-top into an electrical outlet that is not controlled by a wall switch.
- Verify that all cables are properly connected.
- Verify that the Power to the TV is turned on.
- Verify that the TV is set to the proper input channel.

No Color

- Verify that the current TV program is broadcast in color.
- Adjust the TV color controls.
- Verify that all audio and coaxial cables are properly connected.

No Sound

- Verify that the TV and set-top are properly connected to an electrical outlet.
- Verify that all cables are properly connected.
- Verify that the TV is set to the proper input channel.
- Verify that the volume is turned on.

Disclaimer

Cisco Systems, Inc. assumes no responsibility for errors or omissions that may appear in this guide. We reserve the right to change this guide at any time without notice.



Service Provider Video Technology Group
5030 Sugarloaf Parkway
Box 465447
Lawrenceville, GA 30042 USA

678.277.1000

www.scientificatlanta.com

Cisco, Cisco Systems, the Cisco logo, the Cisco Systems logo and Scientific Atlanta are registered trademarks or trademarks of Cisco Systems, Inc. and/or its affiliates in the U.S. and certain other countries.

DVB is a trademark of the DVB project.

All other trademarks mentioned in this document are the property of their respective owners.

Product and service availability are subject to change without notice.

© 2009 Cisco Systems, Inc. All rights reserved.

May 2009

4026055 Rev A

Free Manuals Download Website

<http://myh66.com>

<http://usermanuals.us>

<http://www.somanuals.com>

<http://www.4manuals.cc>

<http://www.manual-lib.com>

<http://www.404manual.com>

<http://www.luxmanual.com>

<http://aubethermostatmanual.com>

Golf course search by state

<http://golfingnear.com>

Email search by domain

<http://emailbydomain.com>

Auto manuals search

<http://auto.somanuals.com>

TV manuals search

<http://tv.somanuals.com>