



## User's Guide

### Models 1690 and 1695

- Assembly
- Operation
- Safety
- Storage

Thanks for buying a BISSELL POWERSTEAMER™ Upright Deep Cleaner.

We're glad you purchased a BISSELL POWERSTEAMER™ Upright Deep Cleaner. Everything we know about floor care went into the design and construction of this complete, high-tech home cleaning system.

Your POWERSTEAMER™ is well made, and we back it with a full one-year warranty. We also stand behind it with a knowledgeable, dedicated Consumer Services department, so, should you ever have a problem, you'll receive fast, considerate assistance.

My great-grandfather invented the floor sweeper in 1876. Today, BISSELL is a global leader in the design, manufacture, and service of high quality homeware products like your POWERSTEAMER™.

Thanks again, from  
all of us at BISSELL.

Mark J. Bissell  
President and Chief Executive Officer

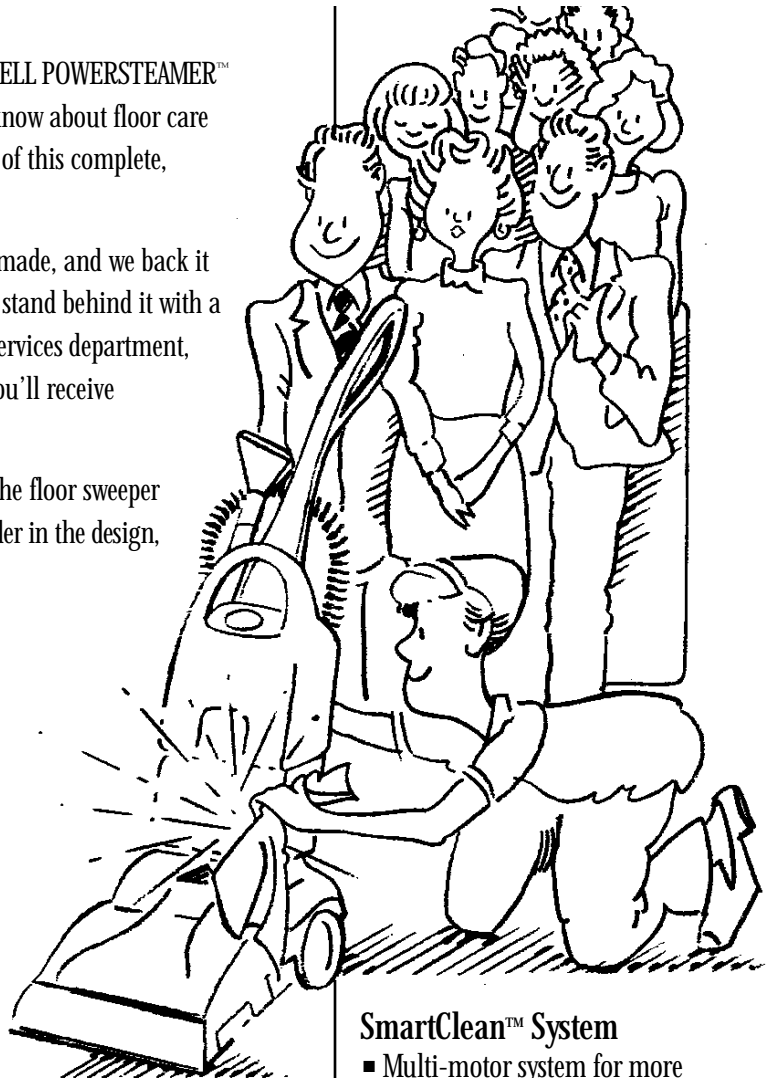

### SmartClean™ System

- Multi-motor system for more cleaning power
- SmartMix™ automatically adjusts formula to specific cleaning need
- Floating brush suspension adjusts to all floor surfaces
- On-board tools for above floor cleaning

# IMPORTANT SAFETY INSTRUCTIONS

**WARNING:** When using an electrical appliance, basic precautions should be observed, including the following. Read all instructions before using your POWERSTEAMER.™ To reduce the risk of electric shock, use indoors only. Do not immerse. Use only on surfaces moistened by cleaning process. Always connect to a properly grounded outlet. Unplug from outlet when not in use and before conducting maintenance or troubleshooting.

- Do not leave machine when it is plugged in
- Do not service machine when it is plugged in
- Do not use with damaged cord or plug
- Do not use machine if it has been dropped, damaged, left outdoors or dropped into water
- Do not expose to rain, store indoors.
- Do not handle unit with wet hands
- Do not pull or carry by cord, use cord as a handle, close door on cord, pull cord around sharp corners or edges, run appliance over cord, or expose cord to heated surfaces
- Do not carry the appliance while in use
- Do not unplug by pulling on cord-unplug by grasping plug
- Do not handle plug or appliance with wet hands
- Do not put any object into appliance openings, use with blocked opening, or restrict air flow
- Do not expose hair, loose clothing, fingers or body parts to openings or moving parts
- Do not pick up hot or burning objects
- Do not pick up flammable or combustible materials (lighter fluid, gasoline, kerosene, etc.) or use in the presence of explosive liquids or vapor
- Do not use appliance in an enclosed space filled with vapors given off by oil base paint, paint thinner, some moth proofing substances, flammable dust, or other explosive or toxic vapors
- Do not pick up toxic material (chlorine bleach, ammonia, drain cleaner, gasoline, etc.)
- Do not modify the 3-prong grounded plug
- Do not allow to be used as a toy
- Do not use for any purpose other than described in this User's Guide

- Use only manufacturer's recommended attachments
- Use only cleaning products formulated by BISSELL for use in this appliance
- Keep openings free of dust, lint, hair, etc.
- Keep appliance on a level surface
- Turn off all controls before unplugging
- Unplug by grasping the plug, not the cord
- Be extra careful when cleaning stairs
- Pay close attention when working around children

## SAVE THESE INSTRUCTIONS.

THIS MODEL IS FOR HOUSEHOLD USE ONLY.

## GROUNDING INSTRUCTIONS

This appliance must be connected to a grounded wiring system. If it should malfunction or break down, grounding provides a safe path of least resistance for electrical current, reducing the risk of electrical shock. The cord for this appliance has an equipment-grounding conductor and a grounding plug. It must only be plugged into an outlet that is properly installed and grounded in accordance with all local codes and ordinances.

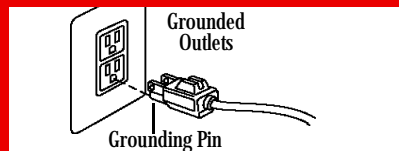

**WARNING:** Improper connection of the equipment-grounding conductor can result in a risk of electrical shock. Check with a qualified electrician or service person if you aren't sure if the outlet is properly grounded. DO NOT MODIFY THE PLUG. If it will not fit the outlet, have a proper outlet installed by a qualified electrician. This appliance is designed for use on a nominal 120-volt circuit, and has a grounding attachment plug that looks like the plug in the drawing above. Make certain that the appliance is connected to an outlet having the same configuration as the plug. No plug adapter should be used with this appliance.

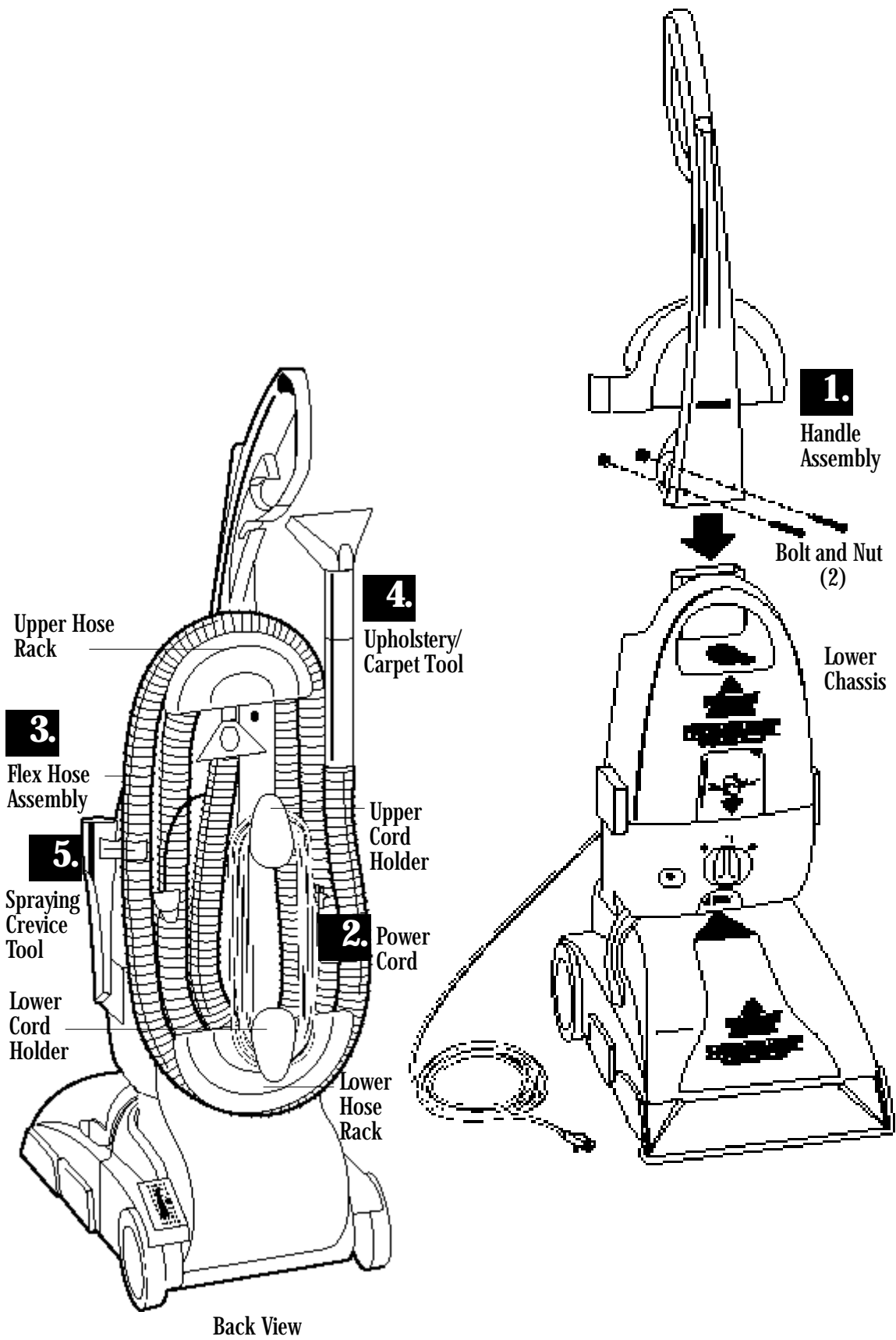

## How to use this guide

This User's Guide has been designed to help you get maximum satisfaction from your POWERSTEAMER™ Upright Deep Cleaner. You'll find assembly instructions for all cleaning tasks, safety precautions, pre-cleaning tips, and maintenance and troubleshooting instructions. Please read this Guide thoroughly before assembling your cleaner.

Pay particular attention to the assembly diagram, assembly instructions, and part names. Locate and organize all parts before assembly. Familiarize yourself with the parts and where they go. Following the Guide will greatly enhance your ability to get top performance from your cleaner for many years.

## How to put it together

The only thing you will need to assemble your cleaner is a Phillips head  screwdriver.

Your POWERSTEAMER™ is packaged as two primary components—the Lower Chassis and the Handle Assembly. Also included is a 10' Flex Hose Assembly and Upholstery/Carpet Tool. Additional attachments are included on some models.

**Handle Assembly.** Slide Handle Assembly (with attached Hose Rack/Cord Holder) down onto Lower Chassis until it will go no further. Secure by placing two (2) Phillips Head  bolts into front of Handle Assembly and into hex nuts at back of Lower Chassis unit, as shown.

**Power Cord.** Wrap Power Cord around upper and lower Cord Holders, and secure Plug to Cord with molded clip.

**NOTE:** Your POWERSTEAMER™ features a Cord Quick-Release. To easily release Power Cord, rotate upper Cord Holder and remove Cord. Use clip at back of Handle Assembly to secure Power Cord when using cleaner.

**Flex Hose Assembly.** Coil Flex Hose Assembly on back of POWERSTEAMER™ using the hose racks to guide and secure the Hose.

**Upholstery/Carpet Tool.** Connect Upholstery/Carpet Tool to end of Flex Hose Assembly by depressing the button at the end of the Hose. Slide the Tool over the Hose end until the button snaps into place in hole in Tool. Secure Hose/Tool unit in clamp at upper right side.

**Spraying Crevice Tool.** Clip Spraying Crevice Tool to Flex Hose Assembly just below the Upholstery/Carpet Tool using the Spraying Crevice Tool Hose Clip.

**Assembly is now complete.**

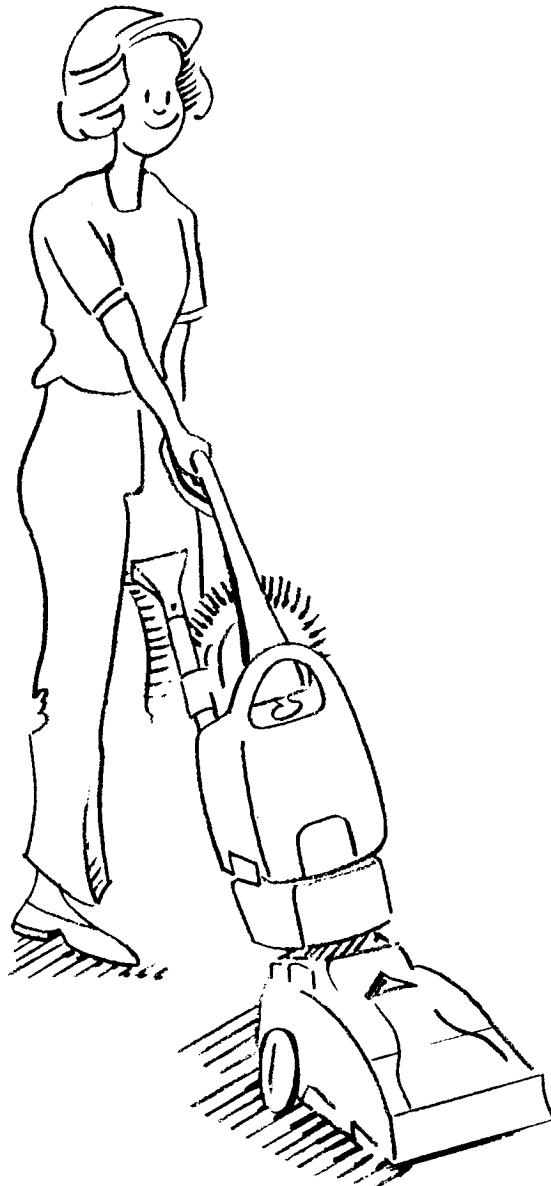

## How to begin...

### Deep cleaning carpet

1. Plan activities to give carpet time to dry.
2. Remove easily moved furniture (chairs, lamps, coffee/cocktail tables, etc.) from room.
3. Vacuum carpet thoroughly.
4. Decide where to begin—and end—your job. Clean in 3' x 4' sections, starting in areas farthest from exit. Plan to leave a path open to empty soiled water and refill cleaner.
5. Carpeting will dry in three to four hours, depending on carpet style and air circulation in room. A floor fan speeds drying.
6. Replace furniture on damp carpeting by placing waxed paper under furniture legs until floor dries completely.

### Deep cleaning upholstery

1. Check manufacturer's tag before cleaning. "W" or "WS" on the tag means you can use your POWERSTEAMER.™ If tag is coded with an "X" or "S" (with diagonal strike-through), or says "Dry Clean Only," do not proceed. Do not use on velvet or silk.
2. If manufacturer's tag is missing or not coded, check with your furniture dealer.
3. Check for colorfastness in an inconspicuous place.
4. If possible, check upholstery stuffing. Colored stuffing may bleed through fabric when wet.

Always vacuum thoroughly before you deep clean. If possible, move larger furniture to an area you will not be cleaning.

### Tip:

Deep cleaning carpeting and upholstery regularly can reduce dust and allergens in your home.

## Index

Safety instructions	2
Product view	3
How to put it together	4
How to begin	5
Index	5
Deep cleaning carpet	6-7
Cleaning upholstery & small areas	8-9
Cleaning bare floors	10-11
Putting it away	11
Troubleshooting	12
Parts	13
Warranty	14
Consumer services	14

# How to deep clean carpet

## Getting ready

1. Unfasten the Clean Water Tank Latch Assembly by lifting from the bottom with your fingers.
2. Remove Clean Water Tank Assembly by sliding it up the Handle Assembly until it comes free.
3. Take Clean Water Tank to sink area, remove Clean Water Tank Cap and fill Tank with hot (NOT boiling) tap water to fill line. Replace Cap securely.
4. Remove SmartMix™ Formula Tank Assembly from Clean Water Tank Assembly by grasping bottom with fingers and sliding it out.
5. Unscrew SmartMix™ Formula Tank Cap and Insert Assembly and add BISSELL Fiber Cleansing Formula™ to fill line. Reclose Cap tightly.
6. Slide SmartMix™ Formula Tank Assembly back into position in Clean Water Tank Assembly.
7. Replace Clean Water Tank Assembly by sliding Tank down the front of the Handle Assembly until it fits snugly against top of Lower Chassis. Secure with Clean Water Tank Latch Assembly.
8. Select SmartClean™ setting.
  - WATER ONLY - Use for gentle cleaning of delicate fabrics, or for (optional) rinsing following cleaning.
  - NORMAL - Water and Fiber Cleansing Formula are mixed to optimize normal cleaning. Use for everyday dirt and soil conditions.
  - HIGH TRAFFIC - Water and Fiber Cleansing Formula are mixed to optimize heavy cleaning. Use for entryways, hallways, heavy soil and stains. This setting may require more frequent refilling on the SmartMix™ bottle.
9. Unwrap Power Cord from Cord Holder and plug into 120 Volt, 60 Hz grounded outlet as described in Important Safety Instructions, page 2.  
If cleaner starts when first plugged in, switch cleaner OFF (O) until ready for use.

## Pre-treating (optional)

Pre-treat highly soiled carpet, such as hallways and other high-traffic areas.

1. Move POWERSTEAMER™ to an area to be cleaned.
2. Move 3-position Power Switch to the PRE-TREAT ( I ) position to activate solution pump.
3. Press Release Pedal on Left side of Lower Chassis with foot.
4. Pull Trigger on Handle Assembly to spray cleaning solution as you move cleaner over soiled areas.
5. Slowly move cleaner back and forth over carpet surface one time while depressing Trigger. Do not overwet.
6. Wait 5 - 10 minutes before full cleaning.

 **WARNING:** Use only BISSELL Fiber Cleansing Formula™ in your POWERSTEAMER™. Use of cleaning formulas which contain lemon or pine oil may damage this appliance and void warranty. Chemical spot cleaners or solvent-based soil removers should not be used. These products may react with the plastic materials used in your POWERSTEAMER™ causing cracking or pitting.

## Deep cleaning

1. Move Power Switch to CLEAN ( II ) position to activate solution pump and vacuum motor.
2. Press Release Pedal on left side of Lower Chassis with foot.
3. Slowly move cleaner back and forth over carpet surface one time while depressing Trigger. Do not overwet.
4. Repeat motion over same area without depressing Trigger.
5. Repeat Steps 3 and 4 until no more dirt can be removed.
6. Continue to clean entire carpet, working in 3' x 4' sections.
7. Empty the Dirty Water Tank Assembly when dirty water reaches the full line.
8. If the machine loses suction and/or motor noise rises in pitch, turn Power Switch to OFF. Check the Dirty Water Tank Assembly and empty the tank if it is full [see WHEN YOU'RE DONE, page 7].
9. If floor nozzle stops spraying, turn Power Switch to OFF and check water and cleaning solution levels. Refill if needed. Never run POWERSTEAMER™ dry.

## When you're done

1. Turn Power Switch to OFF (O) position.
2. Unplug Power Cord from outlet.
3. Remove and empty Clean Water Tank Assembly.
4. Press Release Pedal and tip Handle Assembly back with Handle Assembly.
5. Release Dirty Water Tank Latch Assembly at bottom of Lower Chassis.
6. Carefully lift Dirty Water Tank Assembly from Lower Chassis using Carry Handle Assembly.
7. Carry Tank to a toilet or sink, turn Circular Cap at back of unit counterclockwise to open, and pour to empty.
8. Fill Dirty Water Tank Assembly with clean water. Rinse thoroughly and discard water.
9. Remove Dirty Water Tank Triangle Lid and flush suction opening with clean water. Replace cover. Replace Circular Cap by turning clockwise.
10. Replace Clean Water Tank Assembly on Handle Assembly and secure with side latches.
11. Replace Dirty Water Tank Assembly on Lower Chassis and secure with Clean Water Tank Latch Assembly.
12. See PUTTING IT AWAY on page 11.

### Tip:

Deep cleaning stairs and high traffic areas on a regular basis can prolong carpet life.



**WARNING:** The Dirty Water Tank Assembly holds approximately one gallon of soiled liquid. A special float device in the tank will cause the cleaner to stop removing solution from carpet, and the motor sound to rise in pitch when the Dirty Water Tank Assembly is full. Failure to empty full tank will damage unit.

## How to clean upholstery and small areas

### Getting ready

#### Tip:

Check upholstery stuffing before cleaning. Colored stuffing may bleed through fabric when wet.

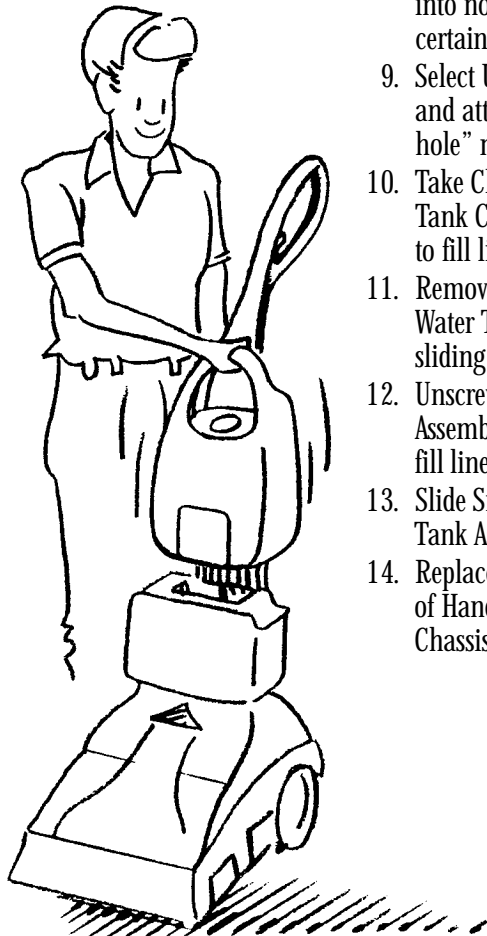

1. Unfasten the Clean Water Tank Assembly by lifting from the bottom with your fingers.
2. Remove Clean Water Tank Assembly by sliding it up the Handle Assembly until it comes free.
3. Remove Flex Hose Assembly from back of unit.
4. Tip Handle Assembly back by pressing Release Pedal on left side of Lower Chassis and pulling back on Handle Assembly.
5. Lift Dirty Water Tank Triangle Lid by pulling back on rear latch with finger.
6. Place triangle-shaped end of Flex Hose Assembly in Dirty Water Tank Triangle port by placing wide (bottom) end in first, then pushing latch end in until it snaps into place.
7. Tip Handle Assembly back to its full upright position.
8. Place Solution Tube Connector into the port at the lower left side of the Handle Assembly. Place tabs on Connector into notches in port, then turn clockwise to secure. Make certain Solution Tube is securely fastened to Connector.
9. Select Upholstery/Carpet Tool or Spraying Crevice Tool, and attach to Flex Hose Assembly using the "button-in-hole" method.
10. Take Clean Water Tank to sink area, remove Clean Water Tank Cap and fill Tank with hot (NOT boiling) tap water to fill line. Replace Cap securely.
11. Remove SmartMix™ Formula Tank Assembly from Clean Water Tank Assembly by grasping bottom with fingers and sliding it out.
12. Unscrew SmartMix™ Formula Tank Cap and Insert Assembly and add BISSELL Fiber Cleansing Formula™ to fill line. Reclose Cap tightly
13. Slide SmartMix™ bottle back into position in Clean Water Tank Assembly.
14. Replace Clean Water Tank Assembly. Slide Tank down front of Handle Assembly until it fits snugly against top of Lower Chassis. Secure with Clean Water Tank Latch Assembly.



15. Select SmartClean™ setting.
  - WATER ONLY - Use for gentle cleaning of delicate fabrics, or for (optional) rinsing following cleaning.
  - NORMAL - Water and Fiber Cleansing Formula are mixed to optimize normal cleaning. Use for everyday dirt and soil conditions.
  - HIGH TRAFFIC - Water and Fiber Cleansing Formula are mixed to optimize heavy cleaning. Use for entryways, hallways, heavy soil and stains. This setting may require more frequent refilling on the SmartMix™ bottle.
16. Unwrap Power Cord from Cord Holder and plug into 120 Volt, 60 Hz grounded outlet as described in Important Safety Instructions, page 2. If cleaner starts when first plugged in, switch off until ready for use.

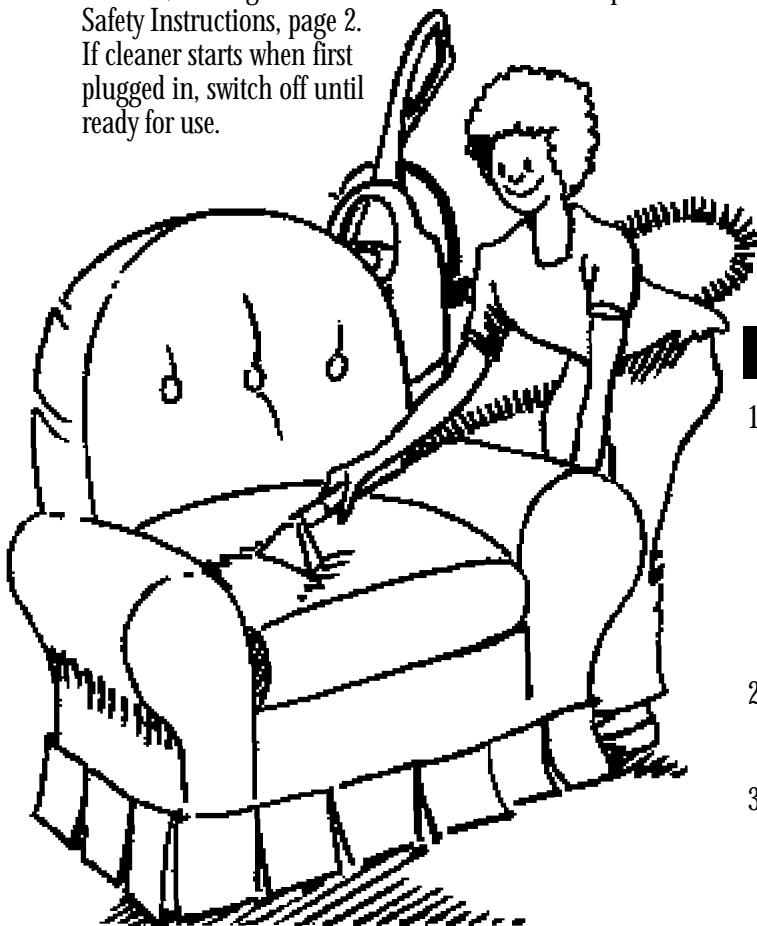

**⚠ WARNING:** Do not lay unit on its back with Clean Water Tank Assembly in place. Do not tip up foot with Dirty Water Tank Assembly in place.

**⚠ WARNING:** Use only BISSELL Fiber Cleansing Formula™ in your POWERSTEAMER™. Use of cleaning formulas which contain lemon or pine oil may damage this appliance and void warranty. Chemical spot cleaners or solvent-based soil removers should not be used. These products may react with the plastic materials used in your POWERSTEAMER™ causing cracking or pitting.

## Cleaning

1. Slowly move Upholstery/Carpet Tool back and forth over soiled surface, first using spray only, then spray and vacuum, finishing with vacuum only.  
NOTE: Use the Spraying Crevice Tool [optional on some models] to spray cleaning solution and remove soil from areas too small to be reached with the Upholstery/Carpet Tool.
2. Continue to clean soiled area, working in small sections, until no more dirt can be removed. Do not overwet.
3. If the machine loses suction and/or motor noise rises in pitch, turn Power Switch to OFF. Check the Dirty Water Tank Assembly and empty the tank if it is full [see WHEN YOU'RE DONE, page 7].
4. If spray tip stops spraying, turn Power Switch to OFF and check water and cleaning solution levels. Refill if needed.  
Never run POWERSTEAMER™ dry.

# How to clean bare floors

## Getting ready

NOTE: Your POWERSTEAMER™ is not recommended for cleaning wood floors.

- Use only BISSELL Floor Cleansing Formula™ on no-wax floors. Never use BISSELL Fiber Cleansing Formula™ or other carpet cleaners on bare floors.
- Sweep before starting.
- Remove old wax before cleaning.
- Leave an exit path.
- Allow at least 1/2 hour drying time.

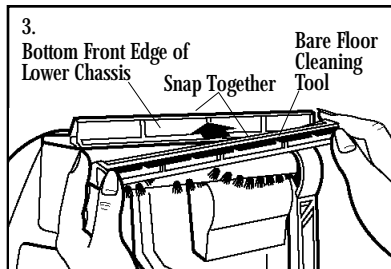

**WARNING:** Use only BISSELL Fiber Cleansing Formula™ in your POWERSTEAMER™. Use of cleaning formulas which contain lemon or pine oil may damage this appliance and void warranty. Chemical spot cleaners or solvent-based soil removers should not be used. These products may react with the plastic materials used in your POWERSTEAMER™ causing cracking or pitting.

1. Remove Clean Water Tank Assembly and Dirty Water Tank Assembly.
2. Tip POWERSTEAMER™ back for easier access to Nozzle.
3. Attach Bare Floor Cleaning Tool to Nozzle with strip facing forward, as shown. Align front edges and snap together.
4. Tip Handle Assembly back by pressing Release Pedal on left side of Lower Chassis and pulling back on Handle Assembly.
5. Take Clean Water Tank to sink area, remove Clean Water Tank Cap and fill Tank with hot (NOT boiling) tap water to fill line. Replace Cap securely.
6. Remove SmartMix™ Formula Tank Assembly from Clean Water Tank Assembly by grasping bottom with fingers and sliding it out.
7. Unscrew SmartMix™ Formula Tank Cap and Insert Assembly and add BISSELL Floor Cleansing Formula™ to fill line. Reclose Cap tightly.
8. Slide SmartMix™ bottle back into position in Clean Water Tank Assembly.
9. Replace Clean Water Tank Assembly. Slide Tank down front of Handle Assembly until it fits snugly against top of Lower Chassis. Secure with Clean Water Tank Latch Assembly.
10. Replace Dirty Water Tank Assembly.
11. Select SmartClean™ setting.
  - WATER ONLY - Use for gentle cleaning, or for (optional) rinsing following cleaning.
  - NORMAL - Water and Floor Cleansing Formula™ are mixed to optimize normal cleaning. Use for everyday dirt and soil conditions.
  - HIGH TRAFFIC - Water and Floor Cleansing Formula™ are mixed to optimize heavy cleaning. Use for entryways, hallways, heavy soil and stains. This setting may require more frequent refilling on the SmartMix™ bottle.

13. Unwrap Power Cord from Cord Retainer and plug into 120 Volt, 60 Hz grounded outlet as described in Important Safety Instructions, page 2.

## Cleaning

1. Slowly move the Bare Floor Cleaning Tool back and forth over soiled surface one time while depressing Trigger.  
Do not overwet.
2. Repeat motion over same area without depressing Trigger.
3. Repeat Steps 1 and 2 until no more dirt can be removed.
4. If machine loses suction and/or noise rises in pitch, turn Power Switch to OFF. Check the Dirty Water Tank Assembly and empty the tank if it is full (see WHEN YOU'RE DONE, page 7).
5. If spray tip stops spraying, turn Power Switch to OFF and check water and cleaning solution levels. Refill if needed.  
Never run POWERSTEAMER™ dry.



**WARNING:** The Dirty Water Tank Assembly holds approximately one gallon of soiled liquid. A special float device in the tank will cause the cleaner to stop removing solution from carpet, and the motor sound to rise in pitch when the Dirty Water Tank Assembly is full. Failure to empty full tank will damage unit.



**WARNING:** Do not lay unit on its back with Clean Water Tank Assembly in place. Do not tip up foot with Dirty Water Tank Assembly in place.

## Putting it away

1. Follow instructions in WHEN YOU'RE DONE, page 7.
2. Disconnect Solution Tube Connector by turning it counter-clockwise and gently pulling it straight from port.
3. Remove Flex Hose Assembly from Dirty Water Tank Triangle port.
4. Replace Dirty Water Tank Triangle Lid.
5. Coil Flex Hose Assembly in Hose Rack on back of POWERSTEAMER.™
6. Rinse Tools in clean running water, dry, and replace as shown in HOW TO PUT IT TOGETHER, page 4.
7. Wrap Power Cord around Cord Holder on back of POWERSTEAMER.™
8. Wipe all surfaces with a soft cloth.
9. Store cleaner upright in a protected, dry area.

NOTE: You may have water remaining in the Clean Water Tank Assembly, and BISSELL Fiber Cleansing Formula™ remaining in the SmartMix® dispenser. Never leave clean water in the Clean Water Tank Assembly or soiled solution in the Dirty Water Tank Assembly.

# Troubleshooting

## Reduced spray or no spray



### Possible Causes

### Remedies

Clean Water Tank Assembly empty

Refill Tank

SmartMix™ dispenser empty

Fill with BISSELL Fiber Cleansing Formula™

Spray Nozzle clogged

Clean Spray Nozzle

Pump not operating properly

Check electrical plug  
Power switch on?  
Turn POWERSTEAMER™ off and hold Trigger for 10-15 seconds. Turn Power Switch to “CLEAN” position and hold trigger for 10-15 seconds  
Call BISSELL Consumer Services

## Vacuum not picking up cleaning solution

### Possible Causes

### Remedies

Loose Triangle Cap

Check cap and snap securely into Dirty Water Tank Assembly

Dirty Water Tank Assembly not aligned/secured

Check Tank for proper alignment and secure with side latches

Flex Hose Assembly not secure

Check fit of Hose at Vacuum Port connections [Upholstery/Carpet Tool only]

Poor Tool position [Upholstery/Carpet Tool only]

Adjust angle; apply more downward pressure

Dirty Water Tank Assembly is full

Empty Dirty Water Tank Assembly

## Part numbers and descriptions

Item	Part No.	Part Name
1	010-9200	Flex Hose Assembly with 4" Upholstery/Carpet Tool
2	010-9201	4" Upholstery/Carpet Tool Assembly
3	603-0966	4" Removable Brush
4	603-0961	4" Window
5	603-0910	6" Upholstery/Carpet Tool Assembly
6	603-0911	6" Removable Brush
7	603-0912	6" Window
8	603-6110	Spray Tips (2)
9	010-9148	Spraying Crevice Tool
10	603-0905	Hose Clip
11	010-9130	Bare Floor Cleaning Tool
12	603-9040	Clean Water Tank Assembly
13	010-1645	Clean Water Tank Filler Cap
14	603-1640	Clean Water Tank Cap and Insert Assembly
15	014-9025	Dirty Water Tank Assembly
16	013-2856	Dirty Water Tank Triangle Cap
17	010-7055	Dirty Water Tank Drain Cap
18	603-7075	Bolts and Nuts (2 each)

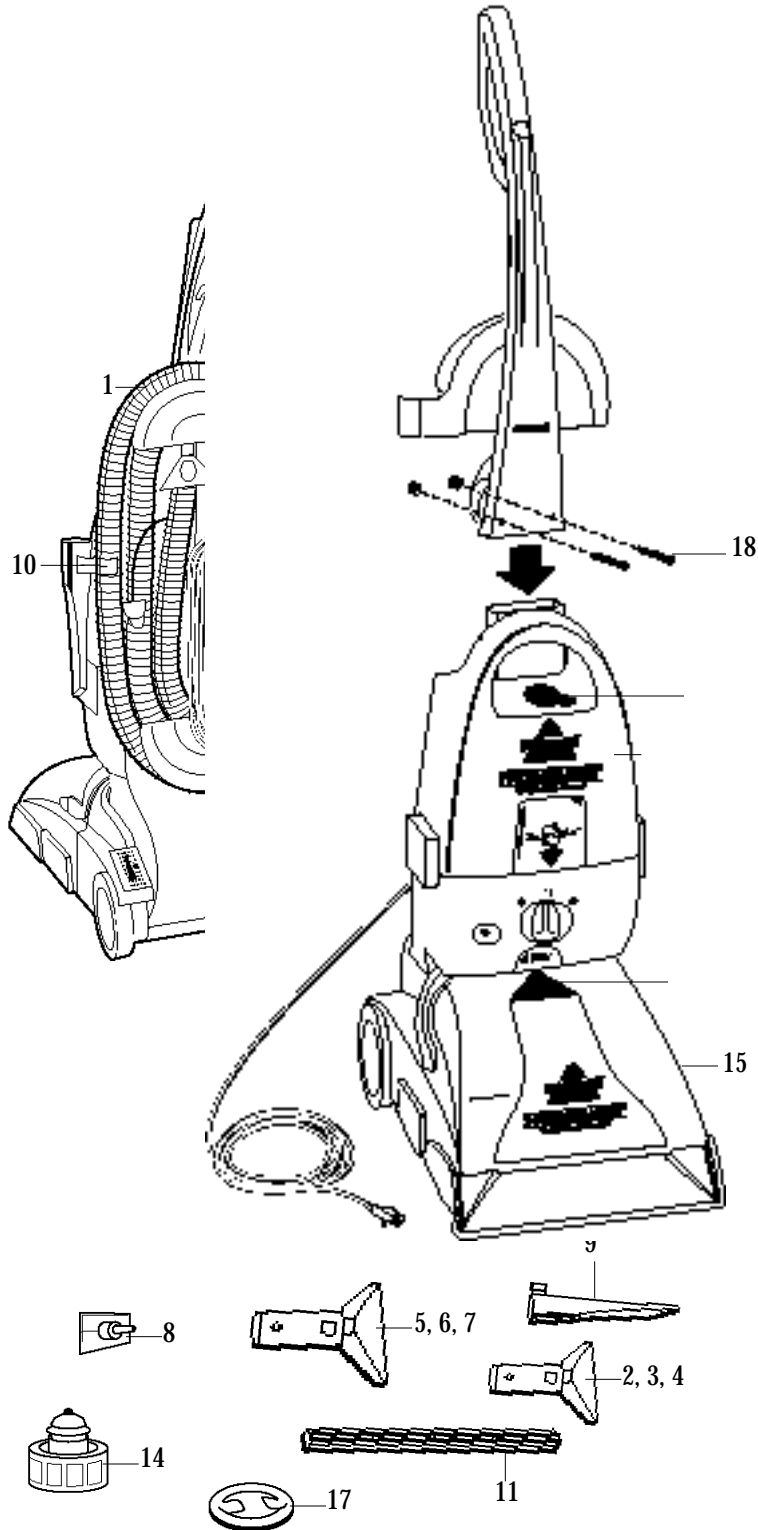

NOTE: To order replacement parts, or to order parts not originally included in your POWERSTEAMER™ model, call

**BISSELL Consumer Services**  
**1-800-237-7691**

Monday - Friday 8 a.m. — 7 p.m. EST  
 Saturday 9 a.m. — 1 p.m. EST

## About your warranty

This warranty gives you specific legal rights, and you may also have other rights which may vary from state to state. If you need additional instruction regarding this warranty or have questions regarding what it may cover, call BISSELL Consumer Services.

### One Year Warranty

BISSELL Inc., upon receipt of the product, will repair or replace, free of charge, any part which is defective or malfunctioning within one year of the purchase date, provided that it is used for personal and not commercial or rental service. If the deep cleaner cannot be repaired, BISSELL Inc. will replace or refund the full price.

### If your BISSELL product should require service

- 1. Call BISSELL Consumer Services (1-800-237-7691) for referral to an authorized BISSELL Service Center.**
- 2. If there is not an authorized BISSELL Service Center in your area, a BISSELL Consumer Services Representative will issue you a Return Authorization Number.**
- 3. Return the machine with a photocopy of proof of purchase. (Your dated sales receipt is your warranty – do not send original. )**

Insure the machine when shipping for your protection from loss.

## BISSELL Consumer Services

For information about repairs or replacement parts, or questions about your warranty, call:

**BISSELL Consumer Services**

**1-800-237-7691**

Monday - Friday 8 a.m. — 7 p.m. EST

Saturday 9 a.m. — 1 p.m. EST

Or write:

**BISSELL INC**

**PO Box 3606**

**Grand Rapids MI 49501**

**ATTN: Consumer Services**

When contacting BISSELL, have model number of unit available.

Please record your Model Number: \_\_\_\_\_

Please record your Purchase Date: \_\_\_\_\_

**NOTE: Please keep your original sales receipt. It is your warranty.**



Life's messy. Clean it up.™

©1997 BISSELL Inc  
Grand Rapids, Michigan  
All rights reserved. Printed in China  
Part Number 010-5710

## Free Manuals Download Website

<http://myh66.com>

<http://usermanuals.us>

<http://www.somanuals.com>

<http://www.4manuals.cc>

<http://www.manual-lib.com>

<http://www.404manual.com>

<http://www.luxmanual.com>

<http://aubethermostatmanual.com>

Golf course search by state

<http://golfingnear.com>

Email search by domain

<http://emailbydomain.com>

Auto manuals search

<http://auto.somanuals.com>

TV manuals search

<http://tv.somanuals.com>