



MX766/MW767/MX822ST  
Digital Projector  
User Manual



# Table of contents

## Important safety

**instructions ..... 3**

**Introduction..... 7**

Projector features.....7

Shipping contents .....8

Projector exterior view.....10

Controls and functions .....12

**Positioning your projector ..... 17**

Choosing a location.....17

Obtaining a preferred projected image size.....18

**Connection ..... 21**

Connecting a computer or monitor...23

Connecting Video source devices.....25

Connecting with document camera ...28

**Operation ..... 29**

Starting up the projector .....29

Adjusting the projected image .....30

Using the menus.....33

Securing the projector.....34

Switching input signal .....36

Magnifying and searching for details ...37

Selecting the aspect ratio .....38

Optimizing the image .....39

Setting the presentation timer .....43

Remote paging operations .....44

Hiding the image.....44

Freezing the image.....44

Operating in a high altitude environment.....45

Adjusting the sound.....45

Personalizing the projector menu display..... 46

Select the lamp saver mode..... 47

Use Teaching Template..... 48

Controlling the projector through a LAN environment..... 49

Displaying image through Q Presenter .. ..... 59

Using the Web Control Lock..... 63

Using the Projection Login Code ..... 63

Using the broadcasting function..... 64

Presenting From a USB Reader..... 64

Remote Desktop Control through Q Presenter ..... 68

PointDraw™ Pen ..... 70

Shutting down the projector ..... 70

Menu operation ..... 71

**Maintenance ..... 86**

Care of the projector..... 86

Lamp information ..... 87

**Troubleshooting..... 95**

**Specifications..... 96**

Dimensions ..... 97

Ceiling mount installation ..... 98

Wall mount installation ..... 99

Timing chart..... 101

**Warranty and Copyright information ..... 107**

# Important safety instructions

Your projector is designed and tested to meet the latest standards for safety of information technology equipment. However, to ensure safe use of this product, it is important that you follow the instructions mentioned in this manual and marked on the product.

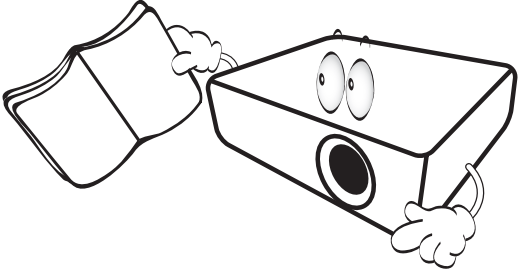
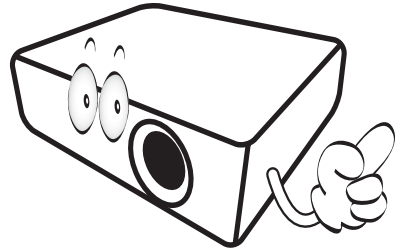
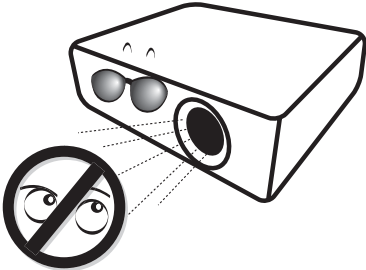
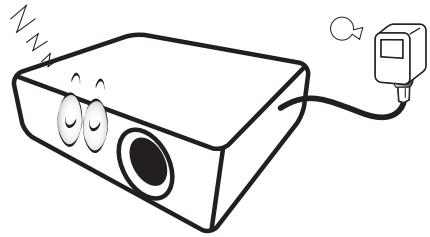
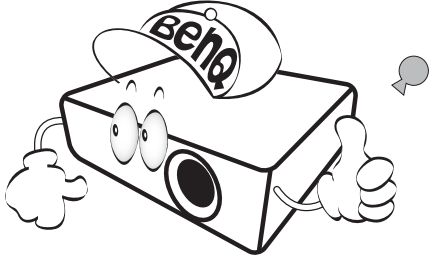
Safety Instructions	
<p>1. <b>Please read this manual before you operate your projector.</b> Save it for future reference.</p> 	<p>4. <b>Always open the lens shutter or remove the lens cap when the projector lamp is on.</b></p> 
<p>2. <b>Do not look straight at the projector lens during operation.</b> The intense light beam may damage your eyes.</p> 	<p>5. In some countries, the line voltage is NOT stable. This projector is designed to operate safely within a mains voltage between 100 to 240 volts AC, but could fail if power cuts or surges of <math>\pm 10</math> volts occur. <b>In areas where the mains voltage may fluctuate or cut out, it is recommended that you connect your projector through a power stabilizer, surge protector or uninterruptible power supply (UPS).</b></p> 
<p>3. <b>Refer servicing to qualified service personnel.</b></p> 	<p>6. Do not block the projection lens with any objects when the projector is under operation as this could cause the objects to become heated and deformed or even cause a fire.</p>

## Safety Instructions (Continued)

7. The lamp becomes extremely hot during operation. Allow the projector to cool for approximately 45 minutes prior to removing the lamp assembly for replacement.

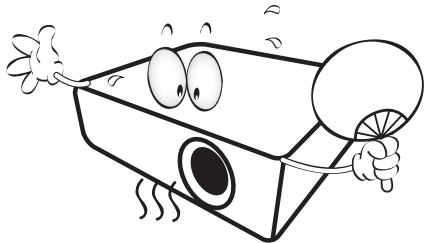

8. Do not operate lamps beyond the rated lamp life. Excessive operation of lamps beyond the rated life could cause them to break on rare occasions.

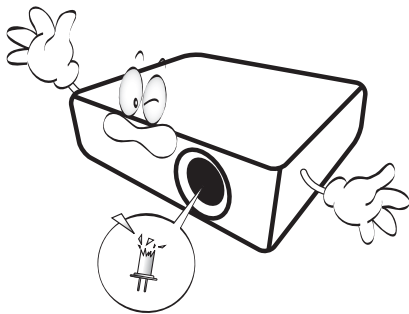

9. Never replace the lamp assembly or any electronic components unless the projector is unplugged.

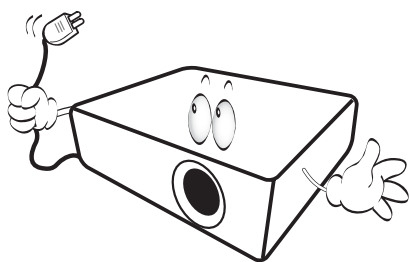

10. Do not place this product on an unstable cart, stand, or table. The product may fall, sustaining serious damage.

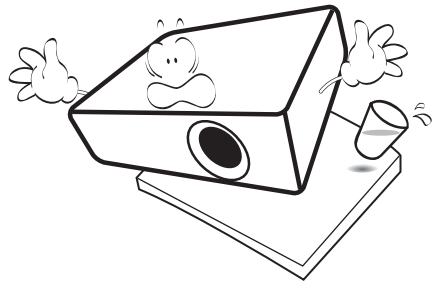

11. Do not attempt to disassemble this projector. There are dangerous high voltages inside which may cause death if you should come into contact with live parts. The only user serviceable part is the lamp which has its own removable cover. Under no circumstances should you ever undo or remove any other covers. Refer servicing only to suitably qualified professional service personnel.

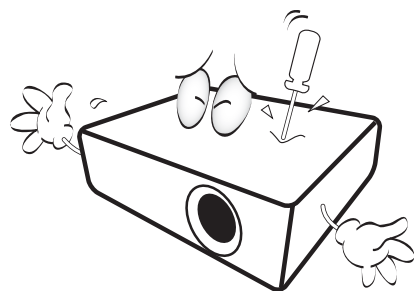

12. When the projector is under operation, you may sense some heated air and odor from its ventilation grill. It is a normal phenomenon and not a product defect.

## Safety Instructions (Continued)

13. Do not place this projector in any of the following environments.
- Space that is poorly ventilated or confined. Allow at least 50 cm clearance from walls and free flow of air around the projector.
  - Locations where temperatures may become excessively high, such as the inside of a car with all windows rolled up.
  - Locations where excessive humidity, dust, or cigarette smoke may contaminate optical components, shortening the projector's life span and darkening the image.

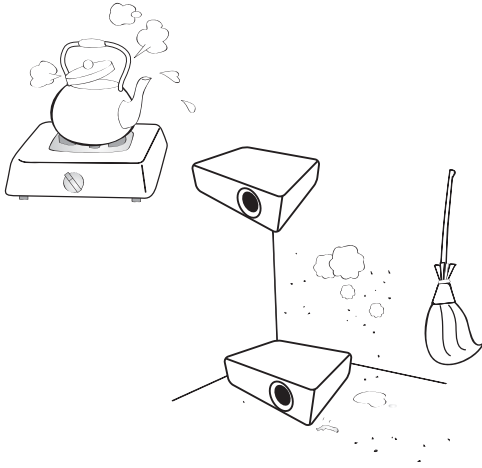

- Locations near fire alarms
- Locations with an ambient temperature above 40°C / 104°F
- Locations where the altitudes are higher than 3000 m (10000 feet).

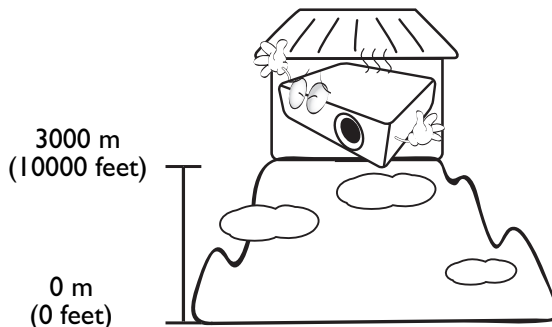

14. Do not block the ventilation holes.
- Do not place this projector on a blanket, bedding or any other soft surface.
  - Do not cover this projector with a cloth or any other item.
  - Do not place inflammables near the projector.

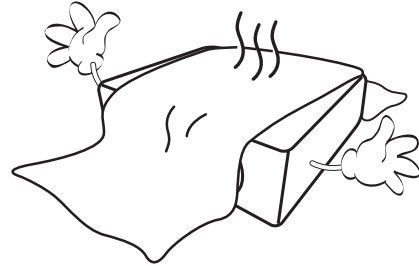

If the ventilation holes are seriously obstructed, overheating inside the projector may result in a fire.

15. Always place the projector on a level, horizontal surface during operation.
- Do not use if tilted at an angle of more than 10 degrees left to right, nor at angle of more than 15 degrees front to back. Using the projector when it is not fully horizontal may cause a malfunction of, or damage to, the lamp.

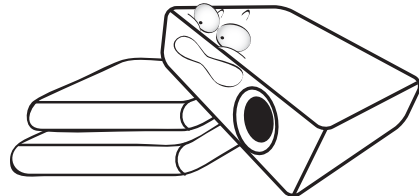

## Safety Instructions (Continued)

16. Do not stand the projector on end vertically. Doing so may cause the projector to fall over, causing injury or resulting in damage to the projector.

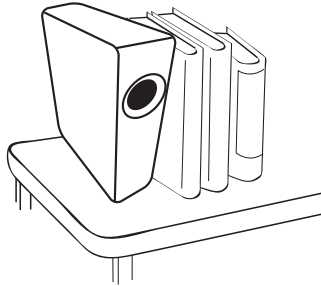

17. Do not step on the projector or place any objects upon it. Besides probable physical damage to the projector, doing so may result in accidents and possible injury.

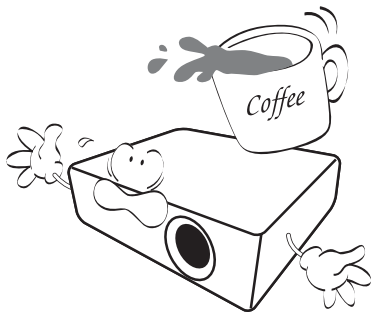

18. Do not place liquids near or on the projector. Liquids spilled into the projector may cause it to fail. If the projector does become wet, disconnect it from the power supply's wall socket and call BenQ to have the projector serviced.

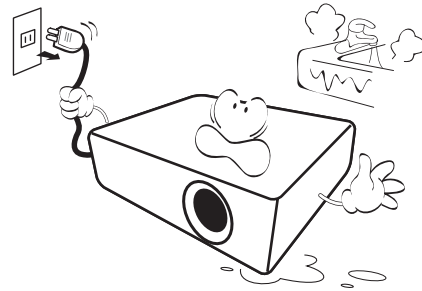

19. This product is capable of displaying inverted images for ceiling mount installation.



**Use only BenQ's Ceiling Mount Kit for mounting the projector and ensure it is securely installed.**

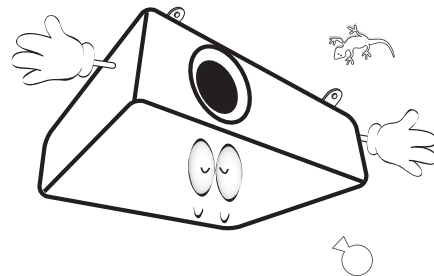

# Introduction

## Projector features

This model is one of the best projectors available in the world. You can enjoy the best video quality across various devices such as PC, laptop, DVD and VCR even document camera to bring all possibility to life.

The projector offers the following features.

- SmartEco™ starts your dynamic power saving
- LAN display for network control and web server
- LAN display 4-1 (maximum 4PC/ NB display to 1 projector)
- Remote desktop feature for LAN and USB display 1-M (maximum 1PC/ NB can display to 8 projectors at the same time)
- USB display supports computer connection via USB mini-B type to A type cable
- USB Reader supports USB flash drive or HDD display
- Variable audio output
- Microphone input with big speaker (20W x 1) can save extra audio systems for schools
- Wall color correction allowing projection on surfaces of several predefined colors
- Quick auto search speeding up the signal detecting process
- Selectable password protected function
- 3D color management allowing color adjustments to your liking
- Selectable quick cooling function makes the projector cool in a shorter time
- Presentation timer for better control of time during presentations
- One-key auto-adjustment to display the best picture quality
- Digital keystone correction to correct distorted images
- Adjustable color balance control for data/video display
- High brightness projection lamp
- Multi-language On-Screen Display (OSD) menus
- Component HDTV compatibility (YPbPr)
- Less than 0.5 W power consumption in standby mode
- WXGA (MW767), perfect for widescreen NB and PC, and provides 30% more images to XGA
- Optional PointDraw™ interactive pen and document camera to better your learning experience.



- **The apparent brightness of the projected image will vary depending on the ambient lighting conditions, selected input signal contrast/brightness settings, and is proportional to projection distance.**
- **The lamp brightness will decline over time and may vary within the lamp manufacturers specifications. This is normal and expected behavior.**

# Shipping contents

Carefully unpack and verify that you have all of the items shown below. If any of these items are missing, please contact your place of purchase.

## Standard accessories

 The supplied accessories will be suitable for your region, and may differ from those illustrated.

\*The warranty card is only supplied in some specific regions. Please consult your dealer for detailed information.

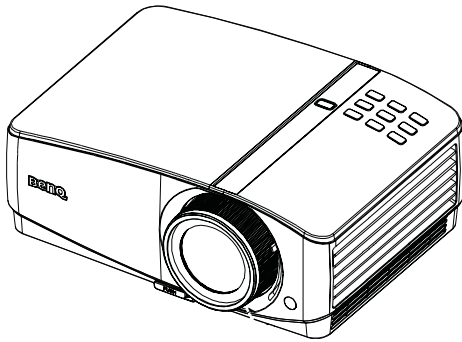

MX766/MW767 projector

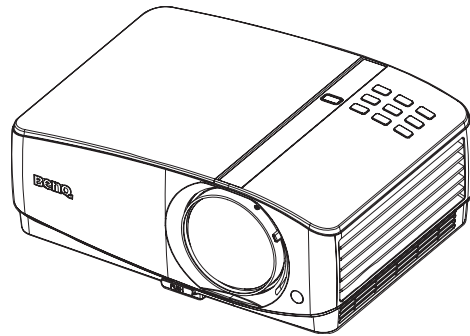

MX822ST projector

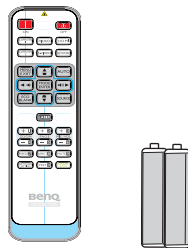

Remote control with batteries

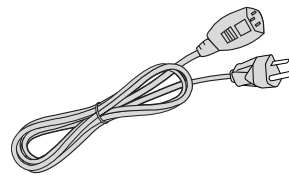

Power cord (2.9m for MX822ST)

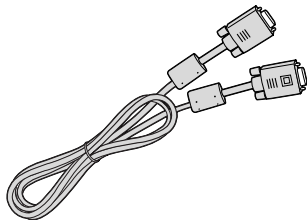

VGA cable



Quick start guide



User manual CD

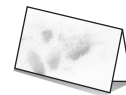

Warranty card\*



## Optional accessories

1. Spare lamp kit
2. Ceiling mount kit
3. BenQ wireless dongle
4. PointDraw pen
5. Wall mount kit
6. Document camera

\* The PointDraw pen is not sold worldwide. If you would like to purchase it, please contact the regional point of sale.

# Projector exterior view

## Front/upper side

(MX766/MW767)

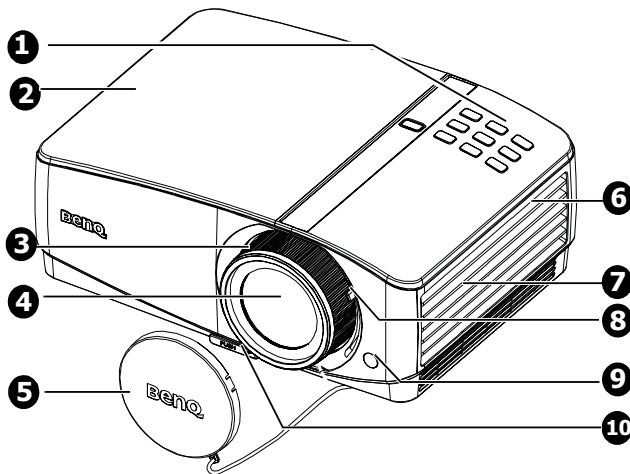

1. External control panel  
(See "Projector" on page 12 for details.)
2. Lamp cover
3. Focus ring (MX766/MW767)  
Focus slide lever (MX822ST)
4. Projection lens
5. Lens cover
6. Vent (heated air exhaust)
7. Speaker
8. Zoom slide lever (MX766/MW767)
9. Front IR remote sensor
10. Quick-release button

(MX822ST)

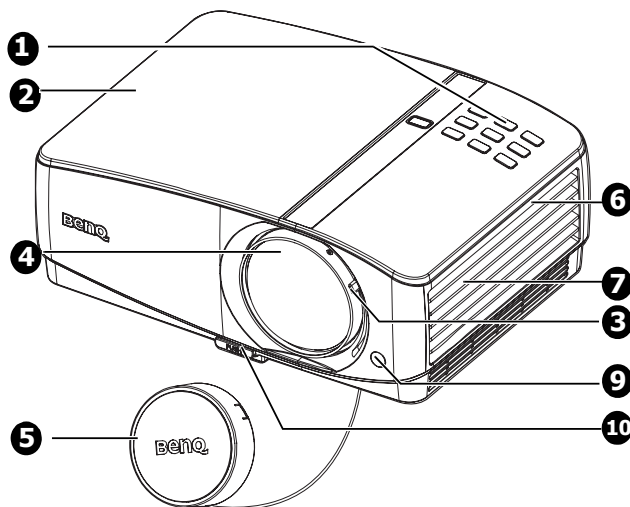

## Rear/lower side

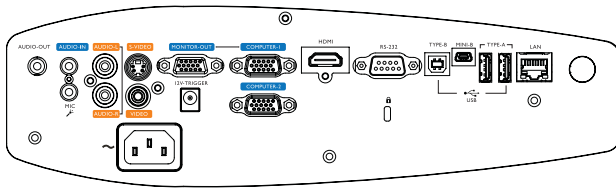

MX766/MW767

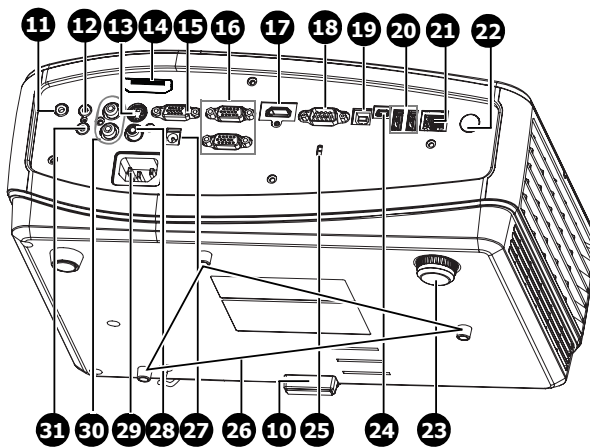

MX822ST

11. Audio output jack
12. Audio input jack
13. S-Video input jack
14. PD DONGLE IN jack (MX822ST)
15. RGB signal output jack
16. RGB (PC)/Component video (YPbPr/ YCbCr) signal input jack
17. HDMI input jack
18. RS-232 control port
19. USB B type jack
20. USB A type jack
21. RJ45 LAN input jack
22. Rear IR remote sensor
23. Rear adjuster foot
24. USB mini-B type jack
25. Kensington anti-theft lock slot
26. Ceiling mount holes
27. 12V DC output terminal Used to trigger external devices such as anelectric screen or light control, etc. Consult your dealer for how to connect these devices.
28. Video input jack
29. AC power cord inlet
30. Audio (L/R) input jack
31. Microphone input jack

# Controls and functions

## Projector

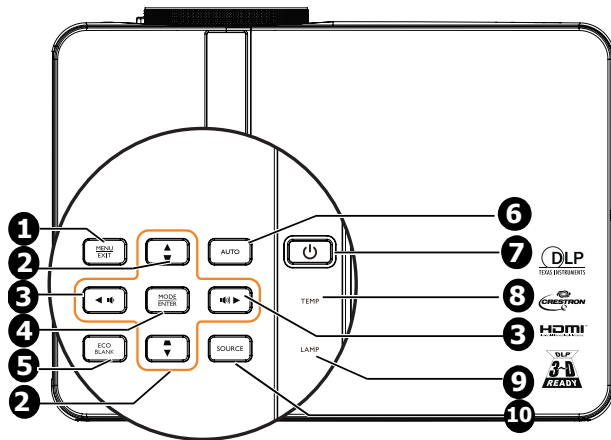

### 1. MENU/EXIT

Turns on the On-Screen Display (OSD) menu. Goes back to previous OSD menu, exits and saves menu settings.

### 2. Keystone/Arrow keys ( / Up, / Down)

Manually corrects distorted images resulting from an angled projection. See ["Correcting keystone" on page 32](#) for details.

### 3. Volume /Arrow keys ( / Left, / Right)

Adjusts the sound level.

When the On-Screen Display (OSD) menu is activated, the #2, and #3 keys are used as directional arrows to select the desired menu items and to make adjustments. See ["Using the menus" on page 33](#) for details.

### 4. MODE/ENTER

Selects an available picture setup mode. See ["Selecting a picture mode" on page 39](#) for details.

Activates the selected On-Screen Display (OSD) menu item. See ["Using the menus" on page 33](#) for details.

### 5. ECO BLANK

Used to hide the screen picture. See ["Hiding the image" on page 44](#) for details.

### 6. AUTO

Automatically determines the best picture timings for the displayed image. See ["Auto-adjusting the image" on page 30](#) for details.

### 7. Power/POWER indicator light

Toggles the projector between standby mode and on. See ["Starting up the projector" on page 29](#) for details.

Lights up or flashes when the projector is under operation. See ["Indicators" on page 96](#) for detail.

### 8. TEMPERATURE indicator light

Lights up red if the projector's temperature becomes too high. See ["Indicators" on page 96](#) for details.

### 9. LAMP indicator light

Indicates the status of the lamp. Lights up or flashes when the lamp has developed a problem. See ["Indicators" on page 96](#) for details.

### 10. SOURCE

Displays the source selection bar. See ["Switching input signal" on page 36](#) for details.

## **Mounting the projector**

We want you to have a pleasant experience using your BenQ projector, so we need to bring this safety matter to your attention to prevent possible damage to person and property.

If you intend to mount your projector on the ceiling or wall, we strongly recommend that you use a proper fitting BenQ projector ceiling mount kit or wall mount kit and that you ensure it is securely and safely installed.

If you use a non-BenQ brand projector mounting kit, there is a safety risk that the projector may fall from the ceiling or wall due to an improper attachment through the use of the wrong gauge or length screws.

You can purchase a BenQ projector ceiling mount or wall mount kit from the place you purchased your BenQ projector. BenQ recommends that you also purchase a separate Kensington lock compatible security cable and attach it securely to both the Kensington lock slot on the projector and the base of the mounting bracket. This will perform the secondary role of restraining the projector should its attachment to the mounting bracket become loose.

# Remote control

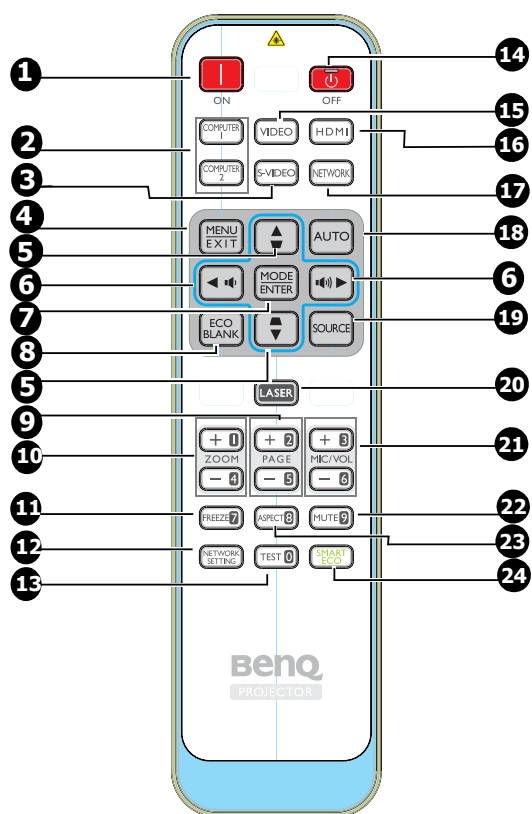

1. **ON**  
Turns on the projector. See ["Starting up the projector"](#) on page 29 for details.
2. **COMPUTER 1/COMPUTER 2**  
Displays RGB (PC)/Component video (YPbPr/ YCbCr) signal.
3. **S-VIDEO**  
Displays S-video signal.
4. **MENU/EXIT**  
Turns on the On-Screen Display (OSD) menu. Goes back to previous OSD menu, exits and saves menu settings. See ["Using the menus"](#) on page 33 for details.
5. **Keystone/Arrow keys (▼ /▲ Up, ▲ / ▼ Down)**  
Manually corrects distorted images resulting from an angled projection. See ["Correcting keystone"](#) on page 32 for details.
6. **Volume /Arrow keys (◀ / 🔊 Left, 🔊/ ▶ Right)**  
Adjusts the sound level.  
When the On-Screen Display (OSD) menu is activated, the #5, and #6 keys are used as directional arrows to select the desired menu items and to make adjustments. See ["Using the menus"](#) on page 33 for details.
7. **MODE/ENTER**  
Selects an available picture setup mode. See ["Selecting a picture mode"](#) on page 39 for details.
8. **ECO BLANK**  
Activates the selected On-Screen Display (OSD) menu item. See ["Using the menus"](#) on page 33 for details.
8. **ECO BLANK**  
Used to hide the screen picture. See ["Hiding the image"](#) on page 44 for details.
9. **PAGE + / -**  
Page up/down arrows when connected through USB to a PC. See ["Remote paging operations"](#) on page 44 for details.
10. **ZOOM + / -**  
Magnifies or reduces the projected picture size. See ["Magnifying and searching for details"](#) on page 37 for details.
11. **FREEZE**  
Freezes the projected image. See ["Freezing the image"](#) on page 44 for details.
12. **NETWORK SETTING**  
Enables Network Settings OSD menu.
13. **TEST**  
Displays the test pattern. See ["Using build-in test pattern"](#) on page 31 for details.
14. **OFF**  
Turns off the projector. See ["Shutting down the projector"](#) on page 70 for details.

**15. VIDEO**

Displays video signal.

**16. HDMI**

Displays HDMI signal.

**17. NETWORK**

Enables the network mode.

**18. AUTO**

Automatically determines the best picture timings for the displayed image. See ["Auto-adjusting the image" on page 30](#) for details.

**19. SOURCE**

Displays the source selection bar. See ["Switching input signal" on page 36](#) for details.

**20. LASER**

Emits visible laser pointer light for presentation purposes.

**21. MIC/VOL + / -**

Adjusts the microphone's sound level. See for details. See ["Adjusting the microphone's sound level" on page 46](#) for details.

**22. MUTE**

Toggles projector audio between on and off. See ["Muting the sound" on page 45](#) for details.

**23. ASPECT**

Selects the display aspect ratio. See ["Selecting the aspect ratio" on page 38](#) for details.

**24. SmartEco**

Displays the lamp mode selection bar (Normal/Economic/SmartEco).

**Operating the laser pointer**

The Laser Pointer is a presentation aid for professionals. It emits red colored light when you press it and the indicator lights up red.

The laser beam is visible. It is necessary to press and hold **LASER** for continuous output.

Avoid Exposure  
Laser radiation is emitted from this aperture



**Do not look into the laser light window or shine the laser light beam on yourself or others. See the warning messages on the back of the remote control prior to using it.**

The laser pointer is not a toy. Parents should be mindful of the dangers of laser energy and keep this remote control out of the reach of children.

Infra-Red (IR) remote control sensor is located on the front of the projector. The remote control must be held at an angle within 22.5 degrees perpendicular to the projector's IR remote control sensor to function correctly. The distance between the remote control and the sensor should not exceed 8 meters (~ 26 feet).

Make sure that there are no obstacles between the remote control and the IR sensor on the projector that might obstruct the infra-red beam.

- **Operating the projector from the front**
- **Operating the projector from the rear**

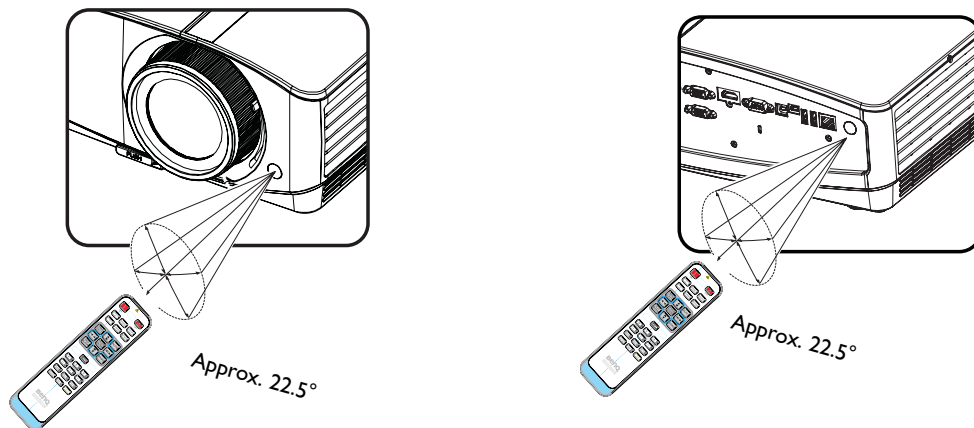

## Replacing the remote control battery

1. To open the battery cover, turn the remote control over to view its back, push on the finger grip on the cover and slide it up in the direction of the arrow as illustrated. The cover will slide off.
2. Remove any existing batteries (if necessary) and install two AAA batteries observing the battery polarities as indicated in the base of the battery compartment. Positive (+) goes to positive and negative (-) goes to negative.
3. Refit the cover by aligning it with the base and sliding it back down into position. Stop when it clicks into place.

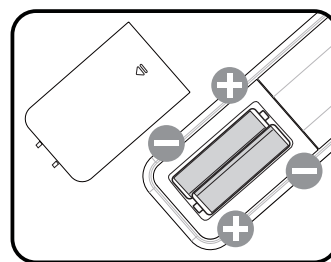
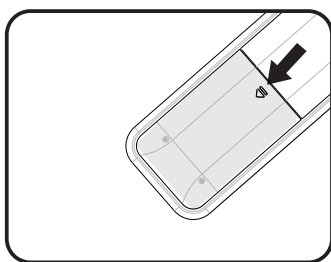

- **Avoid excessive heat and humidity.**
- **There may be battery damage if the battery is incorrectly replaced.**
- **Replace only with the same or equivalent type recommended by the battery manufacturer.**
- **Dispose of the used battery according to the battery manufacturer's instructions.**
- **Never throw a battery into a fire. There may be danger of an explosion.**
- **If the battery is dead or if you will not be using the remote control for a long time, remove the battery to prevent damage to the remote control from possible battery leakage.**



# Positioning your projector

## Choosing a location

Your room layout or personal preference will dictate which installation location you select. Take into consideration the size and position of your screen, the location of a suitable power outlet, as well as the location and distance between the projector and the rest of your equipment.

Your projector is designed to be installed in one of four possible installation locations:

### 1. Front Table

Select this location with the projector placed near the floor in front of the screen. This is the most common way to position the projector for quick setup and portability.

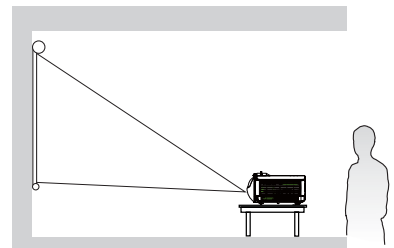

### 2. Front Ceiling

Select this location with the projector suspended upside-down from the ceiling in front of the screen.

Purchase the BenQ Projector Ceiling Mounting Kit from your dealer to mount your projector on the ceiling.

Set **Front Ceiling** in the **SYSTEM SETUP: Basic > Projector Installation** menu after you turn the projector on.

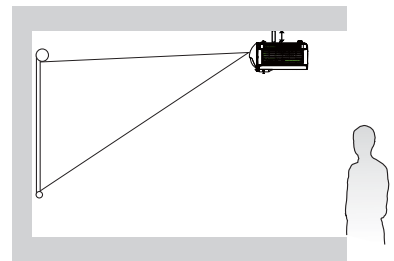

### 3. Rear Table

Select this location with the projector placed near the floor behind the screen.

Note that a special rear projection screen is required.

Set **Rear Table** in the **SYSTEM SETUP: Basic > Projector Installation** menu after you turn the projector on.

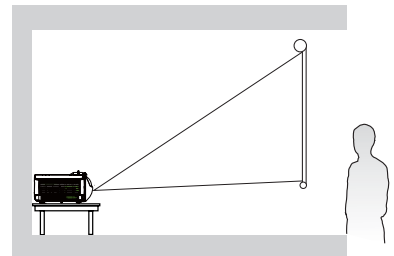

### 4. Rear Ceiling

Select this location with the projector suspended upside-down from the ceiling behind the screen.

Note that a special rear projection screen and the BenQ Projector Ceiling Mounting Kit are required for this installation location.

Set **Rear Ceiling** in the **SYSTEM SETUP: Basic > Projector Installation** menu after you turn the projector on.

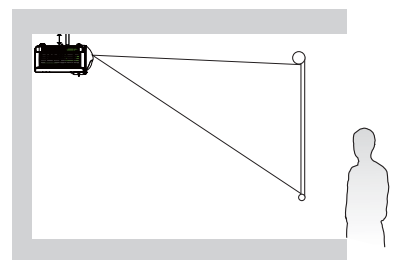

# Obtaining a preferred projected image size

The distance from the projector lens to the screen, the zoom setting (if available), and the video format each factors in the projected image size.

The projector should always be placed horizontally level (like flat on a table), and positioned directly perpendicular ( $90^\circ$  right-angle square) to the horizontal center of the screen. This prevents image distortion caused by angled projections (or projecting onto angled surfaces).

If the projector is mounted on a ceiling, it must be mounted upside-down so that it projects at a slightly downward angle.

You can see from the diagram on page 19, that this type of projection causes the bottom edge of the projected image to be vertically offset from the horizontal plane of the projector. When ceiling mounted, this refers to the top edge of the projected image.

If the projector is positioned further away from the screen, the projected image size increases, and the vertical offset also increases proportionately.

When determining the position of the screen and projector, you will need to account for both the projected image size and the vertical offset dimension, which are proportional to the projection distance.

BenQ has provided a table of screen sizes to assist you in determining the ideal location for your projector. There are two dimensions to consider, the perpendicular horizontal distance from the center of the screen (projection distance), and the vertical offset height of the projector from the horizontal edge of the screen (offset).

# Projection dimensions

Refer to "[Dimensions](#)" on page 97 for the center of lens dimensions of this projector before calculating the appropriate position.

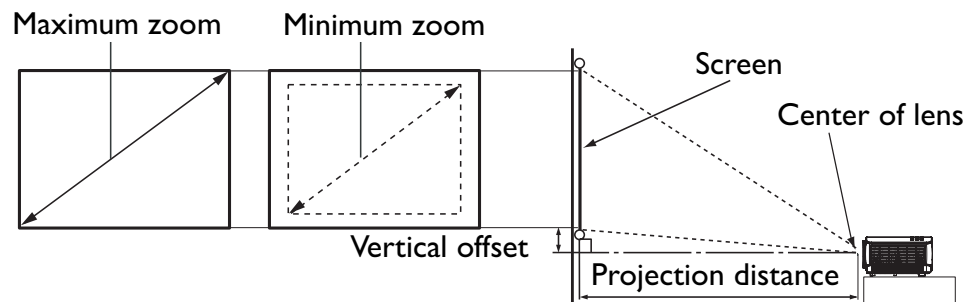

## MX766

Screen size				Distance from screen (m)			Vertical offset (cm)
Diagonal		W (cm)	H (cm)	Min length (max. zoom)	Average	Max length (min. zoom)	
Inch	cm						
30	76	61	46	1.09	1.39	1.69	6.9
40	102	81	61	1.47	1.87	2.27	9.1
60	152	122	91	2.23	2.83	3.43	13.7
80	203	163	122	2.99	3.79	4.58	18.3
100	254	203	152	3.74	4.74	5.74	22.9
120	305	244	183	4.50	5.70	6.90	27.4
150	381	305	229	5.64	7.14	8.64	34.3
200	508	406	305	7.54	9.54	11.53	45.7
250	635	508	381	9.44	11.94	14.43	57.2
300	762	610	457	11.34	14.33	17.32	68.6

## MW767

Screen size				Distance from screen (m)			Vertical offset (cm)
Diagonal		W (cm)	H (cm)	Min length (max. zoom)	Average	Max length (min. zoom)	
Inch	cm						
40	102	86	54	1.24	1.58	1.92	6.7
60	152	129	81	1.88	2.39	2.89	10.1
80	203	172	108	2.52	3.20	3.87	13.5
100	254	215	135	3.16	4.01	4.85	16.8
150	381	323	202	4.77	6.03	7.29	25.2
200	508	431	269	6.38	8.06	9.74	33.7
250	635	538	337	7.98	10.08	12.18	42.1
300	762	646	404	9.59	12.11	14.63	50.5

For example, If you are using the MX766 and a 150-inch screen, the projection distance is 7.14 m and with a vertical offset of 34.3 m.

If you are using the MX766 and your measured projection distance is 4.0 m (4000 mm), the closest match in the "[Distance from screen \(m\)](#)" column is 3.79 m. Looking across this row shows that a 80" (about 2.0 m) screen is required.

## MX822ST

Screen size				Distance from screen (m)	Vertical offset (cm)
Diagonal		W (cm)	H (cm)		
Inch	cm				
30	76	61	46	0.38	7
40	102	81	61	0.51	9
60	152	122	91	0.76	14
80	203	163	122	1.02	18
100	254	203	152	1.27	23
120	305	244	183	1.53	27
150	381	305	229	1.91	34
200	508	406	305	2.55	46
250	635	508	381	3.18	57
300	762	610	457	3.82	69

For example, if you are using a 120-inch screen, the average projection distance is 1.53 m and with a vertical offset of 27 cm.

If your measured projection distance is 2.0 m (200 cm), the closest match in the "[Distance from screen \(m\)](#)" column is 1.91 m. Looking across this row shows that a 150" (about 4.0 m) screen is required.

 **All measurements are approximate and may vary from the actual sizes. BenQ recommends that if you intend to permanently install the projector, you should physically test the projection size and distance using the actual projector in situ before you permanently install it, so as to make allowance for this projector's optical characteristics. This will help you determine the exact mounting position so that it best suits your installation location.**

# Connection

When connecting a signal source to the projector, be sure to:

1. Turn all equipment off before making any connections.
2. Use the correct signal cables for each source.
3. Ensure the cables are firmly inserted.

 • In the connections shown below, some cables may not be included with the projector (see "Shipping contents" on page 8). They are commercially available from electronics stores.

- For detailed connection methods, see pages 23-27.

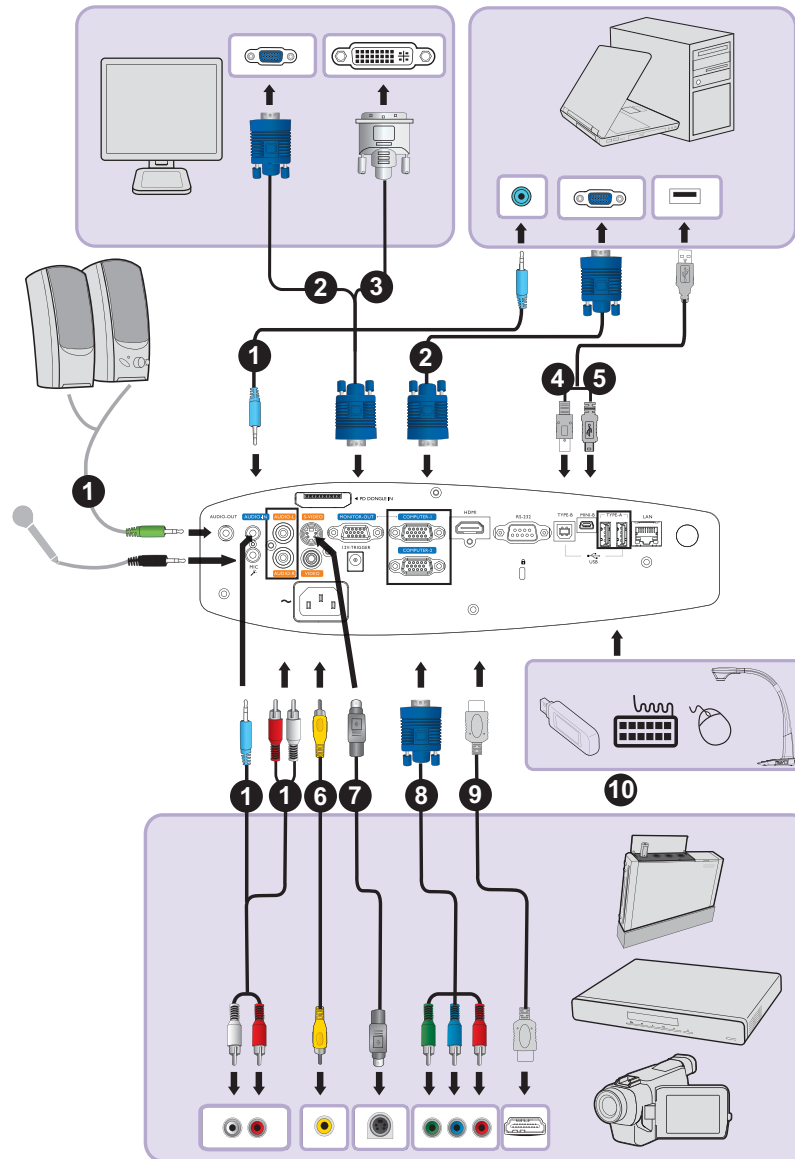

1. Audio cable	6. Video cable
2. VGA cable	7. S-Video cable
3. VGA to DVI-A cable	8. Component Video to VGA (DSub) adapter cable
4. USB B type to A type cable	9. HDMI cable
5. USB mini-B type to A type cable	10. USB flash drive/HDD/wireless dongle/ keyboard/mouse/document camera

Computer system requirements for USB display::

Operation System Requirements	Minimum Hardware Requirements
Windows XP	Supports USB 2.0
Windows Vista	CPU: Pentium 1G
Windows 7	RAM: 512MB RAM
Mac	Disk: 20MB hard driver space

Computer system requirements for WiFi display::

Operation System Requirements	Minimum Hardware Requirements
Windows XP	WiFi: 54 Mbps
Windows Vista	CPU: Pentium 1G
Windows 7	RAM: 512MB RAM
Mac	20MB hard driver space

Computer system requirements for LAN display::

Operation System Requirements	Minimum Hardware Requirements
Windows XP	LAN: 100 Mbps
Windows Vista	CPU: Pentium 1G
Windows 7	RAM: 512MB RAM
Mac	20MB hard driver space

# Connecting a computer or monitor

## Connecting a computer

The projector can connect to both IBM® compatibles and Macintosh® computers. A Mac adapter is needed if you are connecting legacy version Macintosh computers.

### To connect the projector to a notebook or desktop computer (using VGA):

1. Take the supplied VGA cable and connect one end to the D-Sub output socket of the computer.
2. Connect the other end of the VGA cable to the **COMPUTER 1** or **COMPUTER 2** signal input jack on the projector.
3. If you wish to make use of the projector speaker(s) in your presentations, take a suitable audio cable and connect one end of the cable to the audio output jack of the computer, and the other end to the **AUDIO** jack of the projector. When you connect audio output signal from a computer, please balance out the volume control bar to obtain an optimal sound effects.
4. If you wish, you can use another suitable audio cable and connect one end of the cable to the **AUDIO OUT** jack of the projector, and the other end to your external speakers (not supplied).

Once connected, the audio can be controlled by the projector On-Screen Display (OSD) menus. See ["Audio Settings" on page 73](#) for details.

The built-in speaker will be muted when the **AUDIO OUT** jack is connected.

### To connect the projector to a notebook or desktop computer (using USB):

1. Take a USB mini-B type to USB A type cable and connect one end to the A type jack of the computer.
2. Connect the other end of the cable to the **MINI-B** jack on the projector.

 • It may take several seconds to successfully display the screen for the first time plug-in.

• If computer's screen still can't be projected, please go to "My Computer", find the projector name (same as using a flash disk drive), then double click it.

• Projection speed will vary according to the computer capability.

### To connect the projector to a notebook or desktop computer (using LAN):

1. Take a RJ45 cable and connect one end to the LAN input jack of the projector and the other end to the RJ45 port.
2. Make sure that your computer is also connected to an internet cable. Please use Q Presenter program to connect network display and transfers the desktop contents of the host PC via local network connection. See ["Displaying image through Q Presenter" on page 59](#) for details.

 Do not use the RJ45 cable to connect the projector to your computer. Because this connection needs an IP router.

### To connect the projector to a notebook or desktop computer (using HDMI):

1. Take a HDMI cable and connect one end to the HDMI jack of the computer.

2. Connect the other end of the cable to the HDMI jack on the projector.

-  • Many notebooks do not turn on their external video ports when connected to a projector. Usually a key combo like FN + F3 or CRT/LCD key turns the external display on/off. Locate a function key labeled CRT/LCD or a function key with a monitor symbol on the notebook. Press FN and the labeled function key simultaneously. Refer to your notebook's documentation to find your notebook's key combination.
- Transmission speed and image quality will vary according to the bandwidth of local area network and the status of network usage.

## Connecting a monitor

If you want to view your presentation close-up on a monitor as well as on the screen, you can connect the **MONITOR OUT** signal output jack on the projector to an external monitor following the instructions below:

### To connect the projector to a monitor:



1. Connect the projector to a computer as described in "[Connecting a computer](#)" on [page 23](#).
2. Take a suitable VGA cable (only one supplied) and connect one end of the cable to the D-Sub input jack of the video monitor.  
Or if your monitor is equipped with a DVI input jack, take a VGA to DVI-A cable and connect the DVI end of the cable to the DVI input jack of the video monitor.
3. Connect the other end of the cable to the **MONITOR OUT** jack on the projector.

-  • The output signal for **MONITOR OUT** jack only works when the input signal comes from **COMPUTER 1** or **COMPUTER 2** jack. When the projector is powered on, the output signal from **MONITOR OUT** jack varies depending on the input signal from **COMPUTER 1** or **COMPUTER 2** jack.
- If you wish to use this connection method when the projector is in standby mode, make sure the **Monitor Out** function is turned on in the **SYSTEM SETUP: Advanced > Standby Settings** menu. See "[Standby Settings](#)" on [page 73](#) for details.

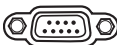

# Connecting Video source devices

You need only connect the projector to a Video source device using just one of the above connecting methods, however each provides a different level of video quality. The method you choose will most likely depend upon the availability of matching terminals on both the projector and the Video source device as described below:

Terminal name	Terminal appearance	Reference	Picture quality
HDMI	HDMI 	"Connecting an HDMI source device" on page 25	Best
Component Video	COMPUTER 	"Connecting a Component Video source device" on page 26	Better
S-Video	S-VIDEO 	"Connecting an S-Video/composite source device" on page 27	Good
Video	VIDEO 		Normal

## Connecting an HDMI source device

The projector provides an HDMI input jack that allows you to connect it to an HDMI source device like a DVD player, a DTV tuner, a display or a notebook computer.

HDMI (High-Definition Multimedia Interface) supports uncompressed video data transmission between compatible devices like DTV tuners, DVD players and displays over a single cable. It provides pure digital viewing and listening experience.

Examine your Video source device to determine if it has a set of unused HDMI output jacks available:

- If so, you can continue with this procedure.
- If not, you will need to reassess which method you can use to connect to the device.

### To connect the projector to an HDMI source device:

1. Take an HDMI cable and connect one end to the HDMI output jack of the HDMI source device.
2. Connect the other end of the cable to the HDMI signal input jack on the projector. Once connected, the audio can be controlled by the projector On-Screen Display (OSD) menus. See "[Audio Settings](#)" on page 73 for details.

-  • If the selected video image is not displayed after the projector is turned on and the correct video source has been selected, check that the Video source device is turned on and operating correctly. Also check that the signal cables have been connected correctly.

- In the unlikely event that you connect the projector to a DVD player via the projector's HDMI input and the projected picture displays wrong colors, please change the color space to YUV. See "[Changing Color Space](#)" on page 36 for details.

## Connecting a Component Video source device

Examine your Video source device to determine if it has a set of unused Component Video output jacks available:

- If so, you can continue with this procedure.
- If not, you will need to reassess which method you can use to connect to the device.

### To connect the projector to a Component Video source device:

1. Take a Component Video to VGA (D-Sub) adaptor cable and connect the end with 3 RCA type connectors to the Component Video output jacks of the Video source device. Match the color of the plugs to the color of the jacks; green to green, blue to blue, and red to red.
2. Connect the other end of the Component Video to VGA (D-Sub) adaptor cable (with a D-Sub type connector) to the **COMPUTER 1** or **COMPUTER 2** jack on the projector.
3. If you wish to make use of the projector speaker(s) in your presentations, take a suitable audio cable and connect one end of the cable to the audio output jack of the device, and the other end to the **AUDIO** jack of the projector.
4. If you wish, you can use another suitable audio cable and connect one end of the cable to the **AUDIO OUT** jack of the projector, and the other end to your external speakers (not supplied).

Once connected, the audio can be controlled by the projector On-Screen Display (OSD) menus. See "[Audio Settings](#)" on page 73 for details.

The built-in speaker will be muted when the **AUDIO OUT** jack is connected.

 **If the selected video image is not displayed after the projector is turned on and the correct video source has been selected, check that the Video source device is turned on and operating correctly. Also check that the signal cables have been connected correctly.**

## Connecting an S-Video/composite source device

Examine your Video source device to determine if it has an unused S-Video/composite output jack available:

- If it has both jacks, use the S-Video output jack for connection as the S-Video terminal provides better picture quality than the Video terminal.
- If it has either of the output jack, you can also continue with this procedure.
- If not, you will need to reassess which method you can use to connect to the device.

### To connect the projector to an S-Video/Video source device:

1. Take an S-Video/Video cable and connect one end to the S-Video/Video output jack of the Video source device.
2. Connect the other end of the S-Video/Video cable to the **S-VIDEO/VIDEO** jack on the projector.
3. If you wish to make use of the projector speaker(s) in your presentations, take a suitable audio cable and connect one end of the cable to the audio output jack of the device, and the other end to the **AUDIO (L/R)** jack of the projector.
4. If you wish, you can use another suitable audio cable and connect one end of the cable to the **AUDIO OUT** jack of the projector, and the other end to your external speakers (not supplied).

Once connected, the audio can be controlled by the projector On-Screen Display (OSD) menus. See ["Audio Settings" on page 73](#) for details.

The built-in speaker will be muted when the **AUDIO OUT** jack is connected.



- **If the selected video image is not displayed after the projector is turned on and the correct video source has been selected, check that the Video source device is turned on and operating correctly. Also check that the signal cables have been connected correctly.**

# Connecting with document camera

1. To connect the projector to a document camera via VGA:

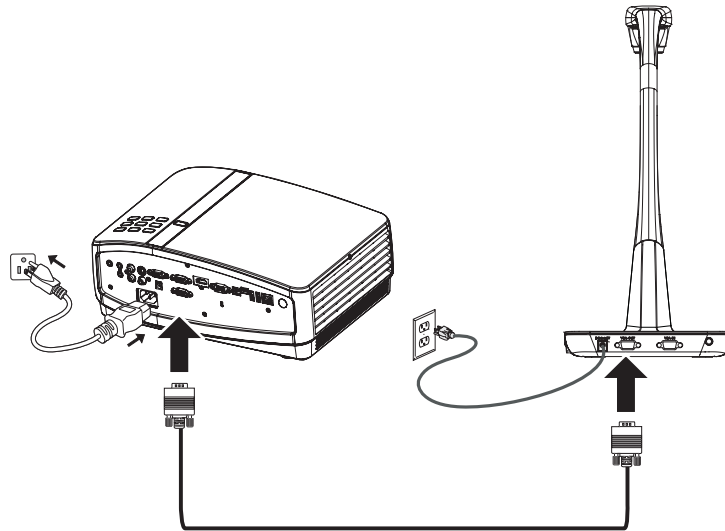

2. To connect the projector to a document camera via USB:

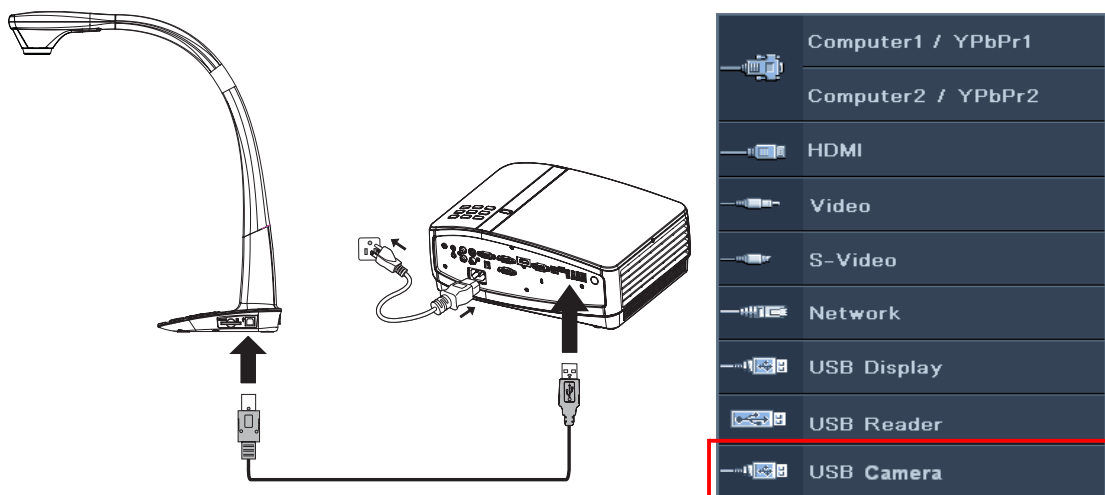

- i. The document camera is powered by the USB cable so a power cord is no need.
- ii. Press **SOURCE** on the projector or remote control. Switch the input signal to **USB Camera** and press **MODE/ENTER**. Once detected, the image from the document camera will display on the screen.

# Operation

## Starting up the projector

1. Plug the power cord into the projector and into a power outlet. Check that the **POWER indicator light** on the projector lights orange after power has been applied.



- Please use the original accessories (e.g. power cable) only with the device to avoid possible dangers such as electric shock and fire.
- If Direct power on function is activated in the **SYSTEM SETUP: Basic > Operation Settings** menu, the projector will turn on automatically after the power cord has been connected and power has been applied. See "**Direct Power On**" on page 72 for details.
- If Signal power on function is activated in the **SYSTEM SETUP: Basic > Operation Settings** menu, the projector will turn on automatically when VGA signal is detected. See "**Signal Power On**" on page 72 for details.

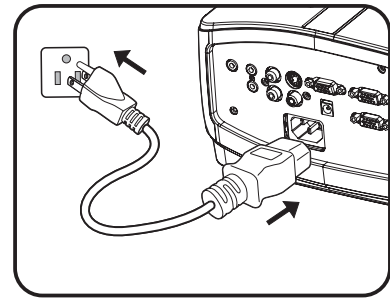

2. Make sure the lens cover is open. If it is closed, it could become deformed due to the heat produced by the projection lamp.

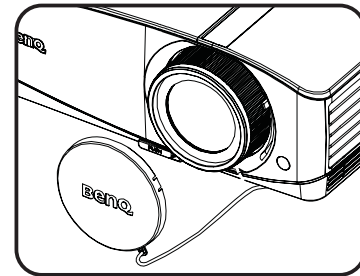

3. Press **Power** on the projector or **ON** on the remote control to start the projector. The **POWER indicator light** flashes and stays green when the projector is on. The start up procedure takes about 10-20 seconds. In the later stage of start up, a startup logo is projected. (If necessary) Use the focus ring/focus slide lever to adjust the image clearness.

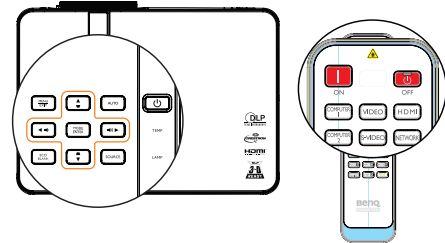

- If the projector is still hot from previous activity, it will run the cooling fan for approximately 90 seconds before energizing the lamp.

4. If the projector is activated for the first time, select your OSD language following the on-screen instructions.
5. If you are prompted for a password, press the arrow keys to enter a six digit password. See "**Utilizing the password function**" on page 34 for details.
6. Switch all of the connected equipment on.
7. The projector will start to search for input signals. The current input signal being scanned displays in the screen. If the projector doesn't

English	한국어	Hrvatski
Français	Svenska	Română
Deutsch	Nederlands	Norsk
Italiano	Türkçe	Dansk
Español	Čeština	Български
Русский	Português	suomi
中文 (繁)	ไทย	Indonesia
中文 (簡)	Polski	Ελληνικά
日本語	Magyar	हिन्दी
العربية		
Enter Confirm		MENU Exit

detect a valid signal, the message 'No Signal' will continue displaying until an input signal is found.

You can also press **SOURCE** on the projector or remote control to select your desired input signal. See "[Switching input signal](#)" on page 36 for details.

- ☞ • If no signal is detected for 3 minutes, the projector automatically enters **ECO BLANK** mode.

## Adjusting the projected image

### Adjusting the projection angle

The projector is equipped with 1 quick-release adjuster foot and 1 rear adjuster foot. These adjusters change the image height and projection angle. To adjust the projector:

1. Press the quick-release button and lift the front of the projector. Once the image is positioned where you want it, release the quick-release button to lock the foot in position.
2. Screw the rear adjuster foot to fine tune the horizontal angle.

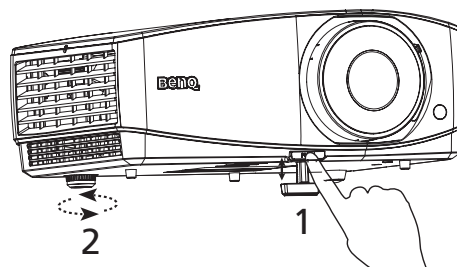

To retract the foot, hold up the projector while pressing the quick-release button, then slowly lower the projector. Screw the rear adjuster foot in a reverse direction.

If the projector is not placed on a flat surface or the screen and the projector are not perpendicular to each other, the projected image becomes trapezoidal. To correct this situation, see "[Correcting keystone](#)" on page 32 for details.

- ⚠ • Do not look into the lens while the lamp is on. The strong light from the lamp may cause damage to your eyes.
- Be careful when you press the adjuster button as it is close to the exhaust vent where hot air comes from.

### Auto-adjusting the image

In some cases, you may need to optimize the picture quality. To do this, press **AUTO** on the projector or remote control. Within 3 seconds, the built-in Intelligent Auto Adjust function will re-adjust the values of Frequency and Clock to provide the best picture quality.

- ☞ • The screen will be blank while **AUTO** is functioning.
- This function is only available when PC signal (analog RGB) is selected.

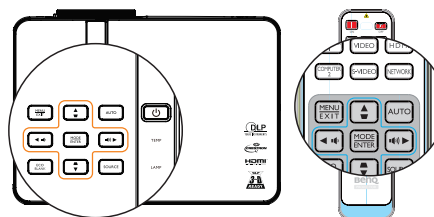

## Using build-in test pattern

You can adjust the image shape and focus status by observing the input signal content, or using the test pattern build-in OSD manual from OSD or remote control for better observe the shape changed.

Open the OSD menu and go to the **SYSTEM SETUP: Advanced > Test Pattern > On**. Press **MODE/ENTER**. The **Test Pattern** displays.

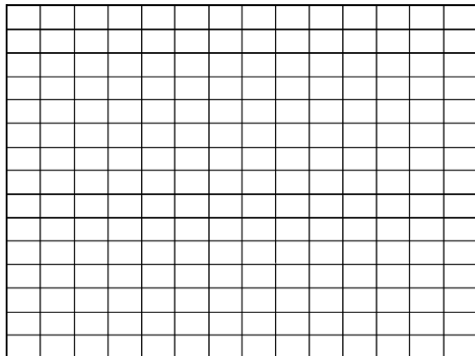
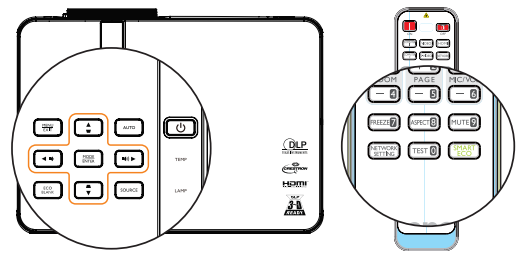

## Fine-tuning the image size and clarity

1. Adjust the projected image to the size that you need using the zoom slide lever. (MX766/MW767)



MX766/MW767

2. Then sharpen the image by using the focus ring/focus slide lever.

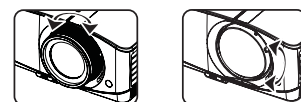
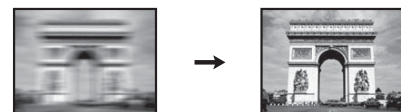





MX766/MW767 MW822ST

# Correcting keystone





Keystoning refers to the situation where the projected image is noticeably wider at either the top or bottom. It occurs when the projector is not perpendicular to the screen.

To correct this, besides adjusting the height of the projector, you will need to manually correct it following one of these steps.

- Using the remote control

Press  /  on the projector or remote control to display the Keystone correction page. Press  to correct keystoning at the top of the image. Press  to correct keystoning at the bottom of the image.

- Using the OSD menu

1. Press **MENU/EXIT** and then press  /  until the **DISPLAY** menu is highlighted.
2. Press  to highlight **Keystone** and press **MODE/ENTER**. The **Keystone** correction page displays.
3. Press  to correct keystoning at the top of the image or press  to correct keystoning at the bottom of the image.

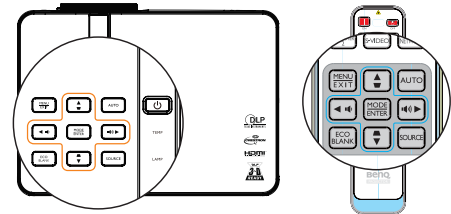

Press  / .

Press  / .



# Using the menus

The projector is equipped with On-Screen Display (OSD) menus for making various adjustments and settings.

Below is the overview of the OSD menu.



The following example describes how to set the OSD language.

1. Press **MENU/EXIT** on the projector or remote control to turn the OSD menu on.
3. Press **▼** to highlight **Language** and press **Enter** to select a preferred language.



2. Use **◀/▶** to highlight the **SYSTEM SETUP: Basic** menu.
4. Press **MENU/EXIT** twice\* on the projector or remote control to leave and save the settings.



\*The first press leads you back to the main menu and the second press closes the OSD menu.

# Securing the projector

## Using a security cable lock

The projector has to be installed in a safe place to prevent theft. Otherwise, purchase a lock, such as the Kensington lock, to secure the projector. You can locate a Kensington lock slot on the rear side of the projector. See item 25 on page 11 for details.

A Kensington security cable lock is usually a combination of key(s) and the lock. Refer to the lock's documentation for finding out how to use it.

## Utilizing the password function

For security purposes and to help prevent unauthorized use, the projector includes an option for setting up password security. The password can be set through the On-Screen Display (OSD) menu.

 **WARNING:** You will be inconvenienced if you activate the power-on lock functionality and subsequently forget the password. Print out this manual (if necessary) and write the password you used in this manual, and keep the manual in a safe place for later recall.

## Setting a password

 Once a password has been set, the projector cannot be used unless the correct password is entered every time the projector is started.

1. Open the OSD menu and go to the **SYSTEM SETUP: Advanced > Security Settings** menu. Press **MODE/ENTER**. The **Security Settings** page displays.
2. Highlight **Change Security** and press **MODE/ENTER**.
3. Highlight **Power on Lock** and select On by pressing **◀/▶**.
4. As pictured to the right, the four arrow keys (**▲**, **▶**, **▼**, **◀**) respectively represent 4 digits (1, 2, 3, 4). According to the password you desire to set, press the arrow keys to enter six digits for the password.

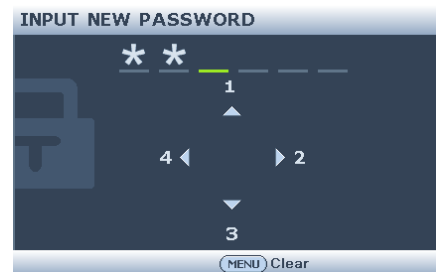

5. Confirm the new password by re-entering the new password.

Once the password is set, the OSD menu returns to the **Security Settings** page.

 **IMPORTANT:** The digits being input will display as asterisks on-screen. Write your selected password down here in this manual in advance or right after the password is entered so that it is available to you should you ever forget it.

Password: \_ \_ \_ \_ \_ \_

Keep this manual in a safe place.

6. To leave the OSD menu, press **MENU/EXIT**.

## If you forget the password

If the password function is activated, you will be asked to enter the six-digit password every time you turn on the projector. If you enter the wrong password, the password error message as pictured to the right displays lasting for three seconds, and the message 'INPUT PASSWORD' follows. You can retry by entering another six-digit password, or if you did not

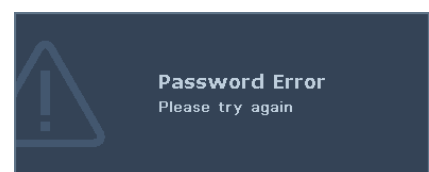

record the password in this manual, and you absolutely do not remember it, you can use the password recall procedure. See "[Entering the password recall procedure](#)" on page 35 for details.

If you enter an incorrect password 5 times in succession, the projector will automatically shut down in a short time.

## Entering the password recall procedure

1. Press and hold **AUTO** on the projector or remote control for 3 seconds. The projector will display a coded number on the screen.
2. Write down the number and turn off your projector.
3. Seek help from the local BenQ service center to decode the number. You may be required to provide proof of purchase documentation to verify that you are an authorized user of the projector.

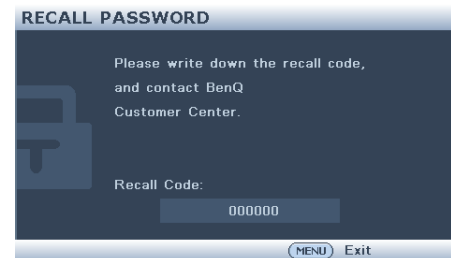

## Changing the password

1. Open the OSD menu and go to the **SYSTEM SETUP: Advanced > Security Settings > Change password** menu.
2. Press **MODE/ENTER**. The message '**INPUT CURRENT PASSWORD**' displays.
3. Enter the old password.
  - If the password is correct, another message '**INPUT NEW PASSWORD**' displays.
  - If the password is incorrect, the password error message displays lasting for three seconds, and the message '**INPUT CURRENT PASSWORD**' displays for your retry. You can press **MENU/EXIT** to cancel the change or try another password.
4. Enter a new password.



**IMPORTANT:** The digits being input will display as asterisks on-screen. Write your selected password down here in this manual in advance or right after the password is entered so that it is available to you should you ever forget it.

Password: \_\_\_\_\_

Keep this manual in a safe place.

5. Confirm the new password by re-entering the new password.
6. You have successfully assigned a new password to the projector. Remember to enter the new password next time the projector is started.
7. To leave the OSD menu, press **MENU/EXIT**.

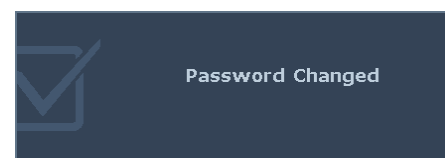

## Disabling the password function

To disable password protection, go back to the **SYSTEM SETUP: Advanced > Security Settings > Change Security Settings > Power on Lock** menu after opening the OSD menu system. Select Off by pressing ◀/▶. The message 'INPUT PASSWORD' displays. Enter the current password.

- If the password is correct, the OSD menu returns to the **Security Settings** page with 'Off' shown in the row of **Power on Lock**. You will not have to enter the password next time you turn on the projector.
- If the password is incorrect, the password error message displays lasting for three seconds, and the message '**INPUT PASSWORD**' displays for your retry. You can press **MENU/EXIT** to cancel the change or try another password.

☞ Though the password function is disabled, you need to keep the old password in hand should you ever need to re-activate the password function by entering the old password.

## Switching input signal

The projector can be connected to multiple devices at the same time. However, it can only display one full screen at a time. When starting up, the projector automatically searches for the available signals.

Be sure the **Quick Auto Search** function in the **SOURCE** menu is On (which is the default of this projector) if you want the projector to automatically search for the signals.

You can also manually cycle through the available input signals.

1. Press **SOURCE** on the projector or remote control. A source selection bar displays.
2. Press ▲/▼ until your desired signal is selected and press **MODE/ENTER**.

Once detected, the selected source information will display on the screen for seconds. If there is multiple equipment connected to the projector, repeat steps 1-2 to search for another signal.

☞ • The brightness level of the projected image will change accordingly when you switch between different input signals. Data (graphic) "PC" presentations using mostly static images are generally brighter than "Video" using mostly moving images (movies).

- The input signal type effects the options available for the Picture Mode. See "[Selecting a picture mode](#)" on page 39 for details.
- The native display resolution of MX766/MX822ST is in a 4:3 aspect ratio while the native display resolution of MW767 is in a 16:10 aspect ratio. For best display picture results, you should select and use an input signal which outputs at this resolution. Any other resolutions will be scaled by the projector depending upon the 'aspect ratio' setting, which may cause some image distortion or loss of picture clarity. See "[Selecting the aspect ratio](#)" on page 38 for details.

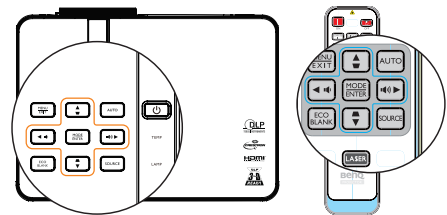

## Changing Color Space

In the unlikely event that you connect the projector to a DVD player via the projector's HDMI input and the projected picture displays wrong colors, please change the color space to YUV.

1. Press **MENU/EXIT** and then press ◀/▶ until the **SOURCE** menu is highlighted.
2. Press ▼ to highlight Color Space Conversion and press ◀/▶ to select a suitable color space.

 This function is only available when the HDMI input port is in use.

## Magnifying and searching for details

If you need to find the details on the projected picture, magnify the picture. Use the direction arrow keys for navigating the picture.

- Using the remote control
  1. Press **ZOOM+/ZOOM-** to display the Zoom bar.
  2. Press **ZOOM +** to magnify the center of the picture. Press the key repeatedly until the picture size is suitable for your need.
  3. Use the directional arrows (▲, ▼, ◀, ▶) on the projector or remote control to navigate the picture.
  4. To restore the picture to its original size, press **AUTO**. You can also press **ZOOM -**. When the key is pressed again, the picture is further reduced until it is restored to the original size.
- Using the OSD menu
  1. Press **MENU/EXIT** and then press ◀/▶ until the **DISPLAY** menu is highlighted.
  2. Press ▼ to highlight **Digital Zoom** and press **MODE/ENTER**. The Zoom bar displays.
  3. Repeat steps 2-4 in the section of "Using the remote control" above. Or if you are using the projector control panel, continue to the following steps.
  4. Press ▲ on the projector repeatedly to magnify the picture to a desired size.
  5. To navigate the picture, press **MODE/ENTER** to switch to the panning mode and press the directional arrows (▲, ▼, ◀, ▶) to navigate the picture.
  6. Use the directional arrows (▲, ▼, ◀, ▶) on the projector or remote control to navigate the picture.
  7. To reduce size of the picture, press **MODE/ENTER** to switch back to the zoom in/out functionality, and press **AUTO** to restore the picture to its original size. You can also press ▼ repeatedly until it is restored to the original size.

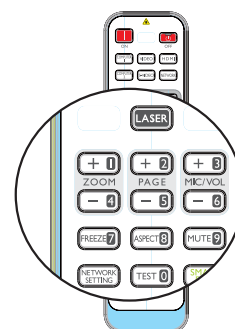

 The picture can only be navigated after the picture is magnified. You can further magnify the picture while searching for details.

# Selecting the aspect ratio

The 'aspect ratio' is the ratio of the image width to the image height.

With the advent of digital signal processing, digital display devices like this projector can dynamically stretch and scale the image output to a different aspect than that of the image input signal.

To change the projected image ratio (no matter what aspect the source is):

- Using the remote control
  1. Press **ASPECT** to show the current setting.
  2. Press **ASPECT** repeatedly to select an aspect ratio to suit the format of the video signal and your display requirements.
- Using the OSD menu
  1. Press **MENU/EXIT** and then press ◀ / ▶ until the **DISPLAY** menu is highlighted.
  2. Press ▼ to highlight **Aspect Ratio**.
  3. Press ◀ / ▶ to select an aspect ratio to suit the format of the video signal and your display requirements.

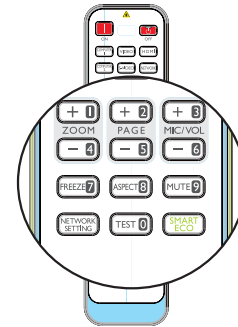

## About the aspect ratio

 In the pictures below, the black portions are inactive areas and the white portions are active areas. OSD menus can be displayed on those unused black areas.

1. **Auto:** Scales an image proportionally to fit the projector's native resolution in its horizontal or vertical width. This is suitable for the incoming image which is neither in 4:3 nor 16:9 and you want to make most use of the screen without altering the image's aspect ratio.
2. **Real:** The image is projected as its original resolution, and resized to fit within the display area. For input signals with lower resolutions, the projected image will display smaller than if resized to full screen. You could adjust the zoom setting or move the projector towards the screen to increase the image size if necessary. You may also need to refocus the projector after making these adjustments.
3. **4:3:** Scales an image so that it is displayed in the center of the screen with a 4:3 aspect ratio. This is most suitable for 4:3 images like computer monitors, standard definition TV and 4:3 aspect DVD movies, as it displays them without aspect alteration.

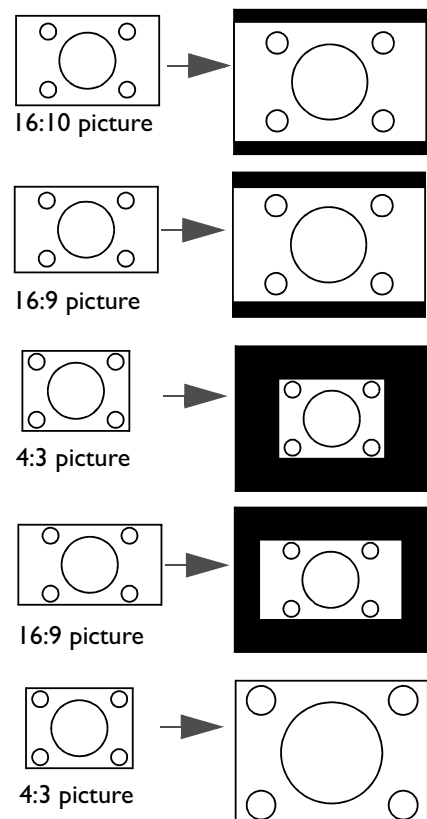

4. **16:9**: Scales an image so that it is displayed in the center of the screen with a 16:9 aspect ratio. This is most suitable for images which are already in a 16:9 aspect, like high definition TV, as it displays them without aspect alteration.
5. **16:10**: Scales an image so that it is displayed in the center of the screen with a 16:10 aspect ratio. This is most suitable for images which are already in a 16:10 aspect, like high definition TV, as it displays them without aspect alteration.

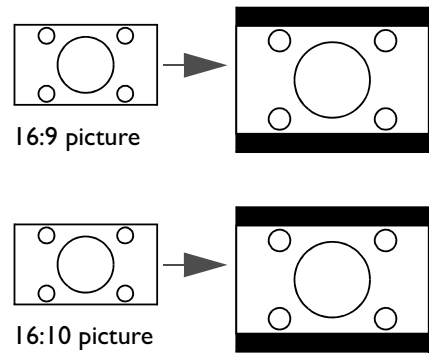

## Optimizing the image

### Selecting a picture mode

The projector is preset with several predefined picture modes so that you can choose one to suit your operating environment and input signal picture type.

To select an operation mode that suits your need, you can follow one of the following steps.

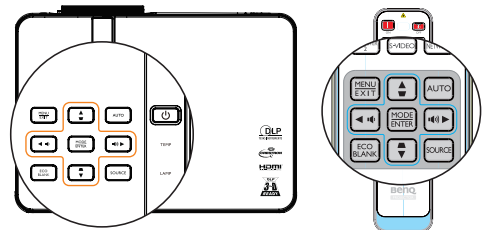

- Press **MODE/ENTER** on the remote control or projector repeatedly until your desired mode is selected.
- Go to the **PICTURE > Picture Mode** menu and press **◀/▶** to select a desired mode.

The picture modes are listed below.

1. **Dynamic mode**: Maximizes the brightness of the projected image. This mode is suitable for environments where extra-high brightness is required, such as using the projector in well lit rooms.
2. **Presentation mode (Default)**: Is designed for presentations. The brightness is emphasized in this mode.
3. **sRGB mode**: Maximizes the purity of RGB colors to provide true-to-life images regardless of brightness setting. It is most suitable for viewing photos taken with an sRGB compatible and properly calibrated camera, and for viewing PC graphic and drawing applications such as AutoCAD.
4. **Cinema mode**: Is appropriate for playing colorful movies, video clips from digital cameras or DVs through the PC input for best viewing in a blackened (little light) environment.
5. **User 1/User 2 mode**: Recalls the settings customized based on the current available picture modes. See "[Setting the User 1/User 2 mode](#)" on page 40 for details.

 **Picture mode is fixed in Presentation mode when PointDraw™ function is on.**

## Setting the User 1/User 2 mode

There are two user-definable modes if the current available picture modes are not suitable for your need. You can use one of the picture modes (except the User 1/User 2) as a starting point and customize the settings.

1. Press **MENU/EXIT** to open the On-Screen Display (OSD) menu.
2. Go to the **PICTURE > Picture Mode** menu.
3. Press **◀/▶** to select User 1 to User 2.
4. Press **▼** to highlight **Reference Mode**.

 This function is only available when User 1 or User 2 mode is selected up in the Picture Mode sub-menu item.

5. Press **◀/▶** to select a picture mode that is closest to your need.
6. Press **▼** to select a sub-menu item to be changed and adjust the value with **◀/▶**. See "[Fine-tuning the image quality in user modes](#)" below for details.
7. When all settings have been done, highlight **Save Settings** and press **MODE/ENTER** to store the settings.
8. The confirmation message '**Setting Saved**' displays.

## Using Wall Color

In the situation where you are projecting onto a colored surface such as a painted wall which may not be white, the **Wall Color** feature can help correct the projected picture's color to prevent possible color difference between the source and projected pictures.

To use this function, go to the **DISPLAY > Wall Color** menu and press **◀/▶** to select a color which is the closest to the color of the projection surface. There are several precalibrated colors to choose from: Light Yellow, Pink, Light Green, Blue, and Blackboard.

## Fine-tuning the image quality in user modes

According to the detected signal type, there are some user-definable functions available when User 1 or User 2 mode is selected. Based on your needs, you can make adjustments to these functions by highlighting them and pressing **◀/▶** on the projector or remote control.

### Adjusting Brightness

The higher the value, the brighter the image. And the lower the setting, the darker the image. Adjust this control so the black areas of the image appear just as black and that detail in the dark areas is visible.



### Adjusting Contrast

The higher the value, the greater the contrast. Use this to set the peak white level after you have previously adjusted the **Brightness** setting to suit your selected input and viewing environment.



### Adjusting Color

Lower setting produces less saturated colors. If the setting is too high, colors on the image will be overpowering, which makes the image unrealistic.



## Adjusting Tint

The higher the value, the more reddish the picture becomes. The lower the value, the more greenish the picture becomes.

## Adjusting Sharpness

The higher the value, the sharper the picture becomes. The lower the value, the softer the picture becomes.

## Adjusting Brilliant Color

This feature utilizes a new color-processing algorithm and system level enhancements to enable higher brightness while providing truer, more vibrant colors in picture. It enables a greater than 50% brightness increase in mid-tone images, which are common in video and natural scenes, so the projector reproduces images in realistic and true colors. If you prefer images with that quality, select On. If you don't need it, select Off.

On is the default and recommended selection for this projector. When Off is selected, the **Color Temperature** function is not available.

## Selecting a Color Temperature

The options available for color temperature\* settings vary according to the signal type selected.

1. **Cool:** Makes images appear bluish white.
2. **Normal:** Maintains normal colorings for white.
3. **Warm:** Makes images appear reddish white.

### \*About color temperatures:

There are many different shades that are considered to be "white" for various purposes. One of the common methods of representing white color is known as the "color temperature". A white color with a low color temperature appears to be reddish white. A white color with a high color temperature appears to have more blue in it.

## Setting a preferred color temperature

To set a preferred color temperature:

1. Highlight **Color Temperature** and select **Warm, Normal** or **Cool** by pressing ◀/ ▶ on the projector or remote control.
2. Press ▼ to highlight **Color Temperature Fine Tuning** and press **MODE/ENTER**. The Color Temperature Fine Tuning page displays.
3. Press ▲/▼ to highlight the item you want to change and adjust the values by pressing ◀/ ▶ .
  - **R Gain/G Gain/B Gain:** Adjusts the contrast levels of Red, Green, and Blue.
  - **R Offset/G Offset/B Offset:** Adjusts the brightness levels of Red, Green, and Blue.
4. Press **MENU/EXIT** to exit and save the settings

## 3D Color Management

In most installation situations, color management will not be necessary, such as in classroom, meeting room, or lounge room situations where lights remain on, or where building external windows allow daylight into the room.

Only in permanent installations with controlled lighting levels such as boardrooms, lecture theaters, or home theaters, should color management be considered. Color management

provides fine color control adjacent to allow for more accurate color reproduction, should you require it.

Proper color management can only be achieved under controlled and reproducible viewing conditions. You will need to use a colorimeter (color light meter), and provide a set of suitable source images to measure color reproduction. These tools are not provided with the projector, however, your projector supplier should be able to provide you with suitable guidance, or even an experienced professional installer.

The Color Management provides six sets (RGBCMY) of colors to be adjusted. When you select each color, you can independently adjust its range and saturation according to your preference.

If you have purchased a test disc which contains various color test patterns and can be used to test the color presentation on monitors, TVs, projectors, etc. You can project any image from the disc on the screen and enter the **3D Color Management** menu to make adjustments.

To adjust the settings:

1. Go to the **PICTURE** menu and highlight **3D Color Management**.
2. Press **MODE/ENTER** and the **3D Color Management** page displays.
3. Highlight **Primary Color** and press ◀/▶ to select a color from among Red, Yellow, Green, Cyan, Blue, or Magenta.
4. Press ▼ to highlight **Hue** and press ◀/▶ to select its range. Increase in the range will include colors consisted of more proportions of its two adjacent colors.

Please refer to the illustration to the right for how the colors relate to each other.

For example, if you select Red and set its range at 0, only pure red in the projected picture will be selected. Increasing its range will include red close to yellow and red close to magenta.

5. Press ▼ to highlight **Saturation** and adjust its values to your preference by pressing ◀/▶. Every adjustment made will reflect to the image immediately.

For example, if you select Red and set its value at 0, only the saturation of pure red will be affected.

**Saturation** is the amount of that color in a video picture. Lower settings produce less saturated colors; a setting of "0" removes that color from the image entirely. If the saturation is too high, that color will be overpowering and unrealistic.

6. Press ▼ to highlight **Gain** and adjust its values to your preference by pressing ◀/▶. The contrast level of the primary color you select will be affected. Every adjustment made will reflect to the image immediately.
7. Repeat steps 3 to 6 for other color adjustments.
8. Make sure you have made all of the desired adjustments.
9. Press **MENU/EXIT** to exit and save the settings.

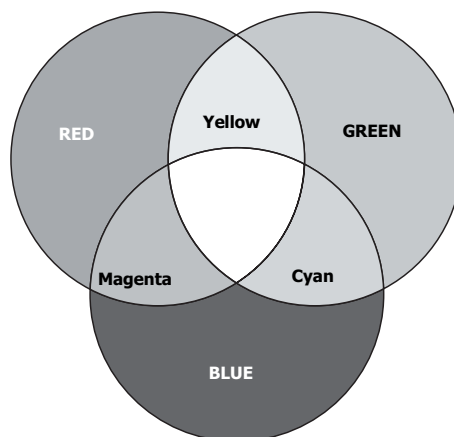

Resetting current or all picture modes

1. Go to the **PICTURE** menu and highlight **Reset Picture Settings**.
2. Press **MODE/ENTER** and press ▲/▼ to select **Current** or **All**.
  - **Current**: returns current picture mode to the factory preset settings.
  - **All**: returns all settings, except **User 1/User 2** in the **PICTURE** menu to the factory preset settings.

# Setting the presentation timer

The presentation timer can indicate the presentation time on the screen to help you achieve better time management when giving presentations. Follow these steps to utilize this function:

1. Go to the **SYSTEM SETUP: Basic > Presentation Timer** menu and press **MODE/ENTER** to display the **Presentation Timer** page.
2. Highlight **Timer Period** and decide the timer period by pressing ◀/▶. The length of time can be set from 1 to 5 minutes in 1-minute increments and 5 to 240 minutes in 5-minute increments.
3. Press ▼ to highlight **Timer Display** and choose if you want the timer to show up on the screen by pressing ◀/▶.

Selection	Description
Always	Displays the timer on screen throughout the presentation time.
1 Min/2 Min/3 Min	Displays the timer on screen in the last 1/2/3 minute(s).
Never	Hides the timer throughout the presentation time.

4. Press ▼ to highlight **Timer Position** and set the timer position by pressing ◀/▶.  
**Top-Left → Bottom-Left → Top-Right → Bottom-Right**
5. Press ▼ to highlight **Timer Counting Direction** and select your desired counting direction by pressing ◀/▶.

Selection	Description
Count Up	Increases from 0 to the preset time.
Count Down	Decrease from the preset time to 0.

6. Press ▼ to highlight **Sound Reminder** and decide if you want to activate sound reminder by pressing ◀/▶. If you select On, a double beep sound will be heard at the last 30 seconds of counting down/up, and a triple beep sound will be produced when the timer is up.
7. To activate the presentation timer, press ▼ and press ◀/▶ to select On and press **MODE/ENTER**.
8. A confirmation message displays. Highlight Yes and press **MODE/ENTER** to confirm. You will see the message "**Timer is On**" displaying on the screen. The timer starts counting at the time the timer is on.

## To cancel the timer, perform the following steps:

1. Go to the **SYSTEM SETUP: Basic > Presentation Timer** menu and highlight Off.  
**Press MODE/ENTER. A confirmation message displays.**
2. Highlight Yes and press **MODE/ENTER** to confirm. You will see the message "Timer is Off!" displaying on the screen.

# Remote paging operations

Connect the projector to your PC or notebook with a USB cable prior to using the paging function. See "[Connecting a computer](#)" on page 23 for details.

You can operate your display software program (on a connected PC) which responds to page up/down commands (like Microsoft PowerPoint) by pressing **PAGE +/-** on the remote control.

If remote paging function doesn't work, check if the USB connection is correctly made and the mouse driver on your computer is updated to the latest version.

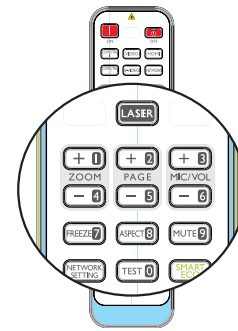

# Hiding the image

In order to draw the audience's full attention to the presenter, you can use **ECO BLANK** on the projector or **ECO BLANK** remote control to hide the screen image. Press any key on the projector or remote control to restore the image. The word 'BLANK' appears at the screen while the image is hidden. When this function is activated with an audio input connected, the audio can still be heard.

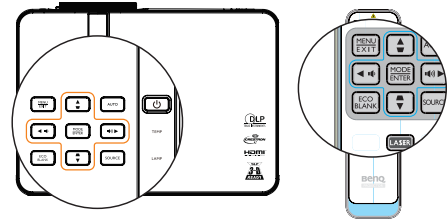

You can set the blank time in the **SYSTEM SETUP: Basic > Operation Settings > Blank Timer** menu to let the projector return the image automatically after a period of time when there is no action taken on the blank screen. The length of time can be set from 5 to 30 minutes in 5-minute increments.

- ⚠ Do not block the projection lens from projecting as this could cause the blocking object to become heated.
- No matter Blank Timer is activated or not, you can press any key (except the **PAGE +/-** key) on the projector or remote control to restore the picture.

# Freezing the image

Press **FREEZE** on the remote control to freeze the image. The word 'FREEZE' will display in the screen. To release the function, press any key (except the **PAGE +/-** key) on the projector or remote control.

Even if an image is frozen on the screen, the pictures are running on the video or other device. If the connected devices have active audio output, you will still hear the audio even though the image is frozen on screen.

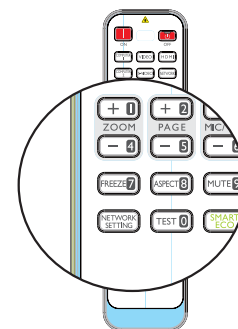

# Operating in a high altitude environment

We recommend you use the **High Altitude Mode** when your environment is between 1500 m –3000 m above sea level, and ambient temperature is between 0°C–35°C.

 **Do not use the High Altitude Mode if your altitude is between 0 m and 1500 m and ambient temperature is between 0°C and 35°C. The projector will be over cooled, if you turn the mode on under such a condition.**

To activate the **High Altitude Mode**:

1. Press **MENU/EXIT** and then press ◀/▶ until the **SYSTEM SETUP: Advanced** menu is highlighted.
2. Press ▼ to highlight **High Altitude Mode** and press ◀/▶ to select On. A confirmation message displays.
3. Highlight Yes and press **MODE/ENTER**.

Operation under "**High Altitude Mode**" may cause a higher decibel operating noise level because of increased fan speed necessary to improve overall system cooling and performance.

If you use this projector under other extreme conditions excluding the above, it may display auto shut-down symptoms, which is designed to protect your projector from over-heating. In cases like this, you should switch to High Altitude mode to solve these symptoms. However, this is not to state that this projector can operate under any and all harsh or extreme conditions.

## Adjusting the sound

The sound adjustments made as below will have an effect on the projector speaker(s). Be sure you have made a correct connection to the projector audio input. See "[Connection](#)" on [page 21](#) for how the audio input is connected.

### Muting the sound

To adjust the sound level, press **MUTE** on the remote control, or:

1. Press **MENU/EXIT** and then press ◀/▶ until the **SYSTEM SETUP: Advanced** menu is highlighted.
2. Press ▼ to highlight **Audio Settings** and press **MODE/ENTER**. The Audio Settings page displays.
3. Highlight **Mute** and select On.

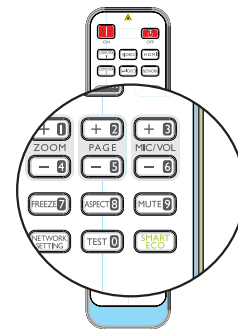

### Adjusting the sound level

To adjust the sound level, press ▶/|||) / |||)/◀ on the remote control or on the projector, or:

1. Repeat steps 1-2 above.
2. Highlight **VOLUME** and select a desired sound level.

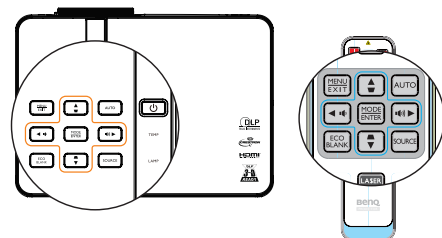

## Turning off the Power on/off ring tone

To turn off the ring tone:

1. Repeat steps 1-2 in Muting the sound section.
2. Highlight **Power on/off Ring Tone** and select Off.

 The only way to change Power on/off ring tone is setting On or Off here. Setting the sound mute or changing the sound level will not affect the Power on/off ring tone.

## Adjusting the microphone's sound level

To adjust the sound level, press **MIC/VOL +/-** on the remote control, or

1. Repeat steps 1-2 in Muting the sound section.
2. Highlight **Microphone volume** and select a desired sound level.

 Microphone sound will still function even though Mute is activated.

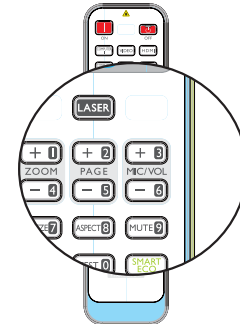

## Personalizing the projector menu display

The On-Screen Display (OSD) menus can be set according to your preferences. The following settings do not affect the projection settings, operation, or performance.

- **Menu display time** in the **SYSTEM SETUP: Basic > Menu Settings** menu sets the length of time the OSD will remain active after your last key press. The time length ranges from 5 to 30 seconds in 5-second increments. Use ◀/▶ to select a suitable time frame.
- **Menu position** in the **SYSTEM SETUP: Basic > Menu Settings** menu sets the OSD position in five locations. Use ◀/▶ to select a preferred position.
- **Language** in the **SYSTEM SETUP: Basic** menu sets your familiar language for the OSD menus. Use **Enter** to select your language.
- **Reminder Message** in the **SYSTEM SETUP: Basic > Menu Settings** menu sets whether to display reminder messages on screen. Use ◀/▶ to select your desired setting.
- **Splash Screen** in the **SYSTEM SETUP: Basic** menu sets a preferred logo screen to be displayed during projector start-up. Use ◀/▶ to select a screen.

# Select the lamp saver mode

- Using the remote control.

Press **SmartEco** and Highlight **Lamp Mode** and press ◀/▶ to select **Normal/Economic/SmartEco**.

- Using the OSD menu.

- Press **MENU/EXIT** and then press ◀/▶ until the **SYSTEM SETUP: Advanced** menu is highlighted.
- Press ▼ to highlight **Lamp Mode** and press **MODE/ENTER**. The Lamp Settings page displays.
- Highlight **Lamp Mode** and press ◀/▶ to select **Normal/Economic/SmartEco**. The lamp brightness vary from the different lamp mode, see the description list in table below.

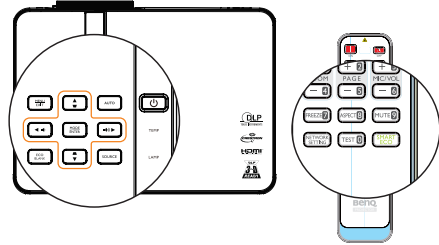

Lamp Mode	Description
Normal	100% lamp brightness.
Economic	Saves 20% lamp power consumption.
SmartEco	Saves up to 70% lamp power consumption depending on the content brightness level.

☞ If the **Economic mode** or **SmartEco mode** is selected, the light output will be reduced and result in darker projected pictures.

# Use Teaching Template

Making writing on the board easier for teachers, you can use build-in template by OSD.



Open the OSD menu and go to the **DISPLAY > Teaching Template** . Choose **Blackboard/Whiteboard**. > **Off/Letter Formation/Worksheet/Coordinate Chart**. The Teaching Template displays.

Teaching Template	Whiteboard	Blackboard
Letter Formation		
Worksheet		
Coordinate Chart		



# Controlling the projector through a LAN environment

Network Settings allow you to manage the projector from a computer using a web browser when the computer and the projector are properly connected to the same local area network.

## Configuring the Wired LAN Settings

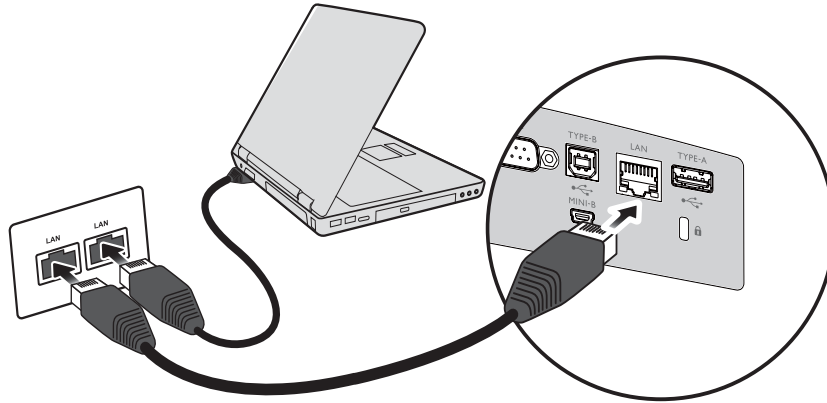

### If you are in a DHCP environment:

1. Take a RJ45 cable and connect one end to the LAN input jack of the projector and the other end to the RJ45 port.
2. Press **MENU/EXIT** and then press ◀ / ▶ until the **SYSTEM SETUP: Advanced** menu is highlighted.
3. Press ▼ to highlight **Network Settings** and press **MODE/ENTER**. The **Network Settings** page displays.
4. Press ▼ to highlight **Wired LAN** and press **MODE/ENTER**.
5. Press ▼ to highlight DHCP and press ◀ / ▶ to select On.
6. Press ▼ to highlight Apply and press **MODE/ENTER**.
7. Re-enter the **Wired LAN** page. The IP Address, Subnet Mask, Default Gateway, and DNS settings will be displayed. Note down the IP address.

☞ If the IP Address still does not display, contact your ITS administrator.

### If you are in a non-DHCP environment:

1. Repeat steps 1-4 above.
2. Press ▼ to highlight DHCP and press ◀ / ▶ to select Off.
3. Contact your ITS administrator for information on the IP Address, Subnet Mask, Default Gateway, and DNS settings.
4. Press ▼ to select the item you want to modify and enter the value.
5. Press ▼ to highlight Apply and press **MODE/ENTER**.

## Configuring the Wireless LAN Settings

1. Connect the BenQ wireless dongle (optional) to the USB TYPE-A input jack of the projector.
2. Highlight **Wireless LAN** in **SYSTEM SETUP: Advanced > Network Settings** menu and press **MODE/ENTER**.
3. For **AP** mode connection, you need to note SSID information, then search the projector with the same SSID in Q Presenter to start projection. For

**Infrastructure** mode connection, you need to select the projector's SSID which you want to connect. See "[Displaying image through Q Presenter](#)" on page 59 for details.

4. Use your computer's wireless connection utility to connect the network.

 If **WEP Key** is set in the projector, the user must enter the password of **WEP Key** to connect the network.

## Controlling the projector remotely through a web browser

Once you have configured the LAN settings, you can find the IP address for the projector in the bottom of the network screen. You can use any computer that is on the same local area network to control the projector.

1. Enter the address of the projector in the address bar of your browser and press Enter. For example: `http://10.60.7.31`

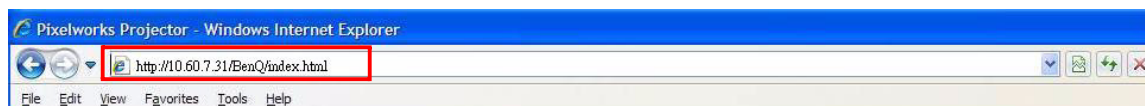
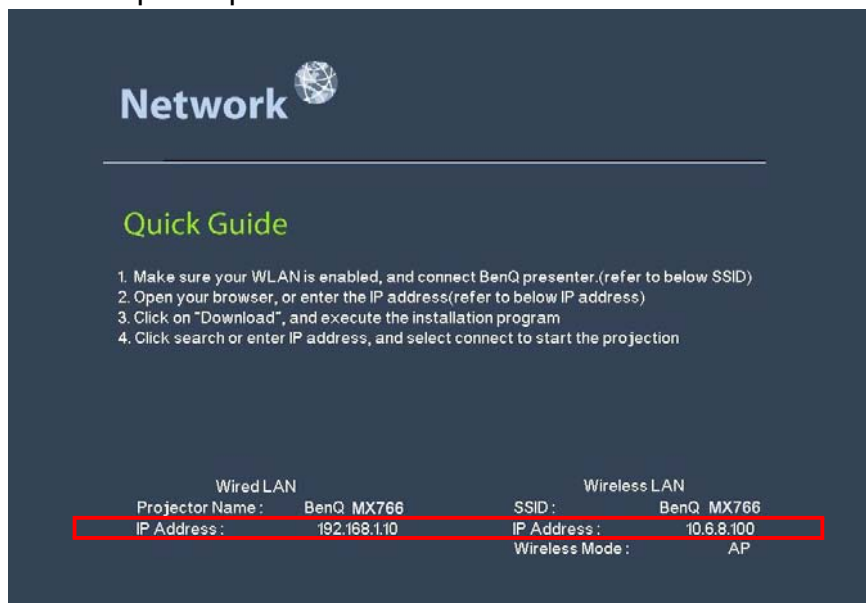

2. The BenQ remote network operation page opens.

 • The web page control supports IE version 7.0 or higher.

- The illustrations in web page control, Q Presenter and USB Reader sections are for the purpose of explanation and may differ from the actual design of your projector.

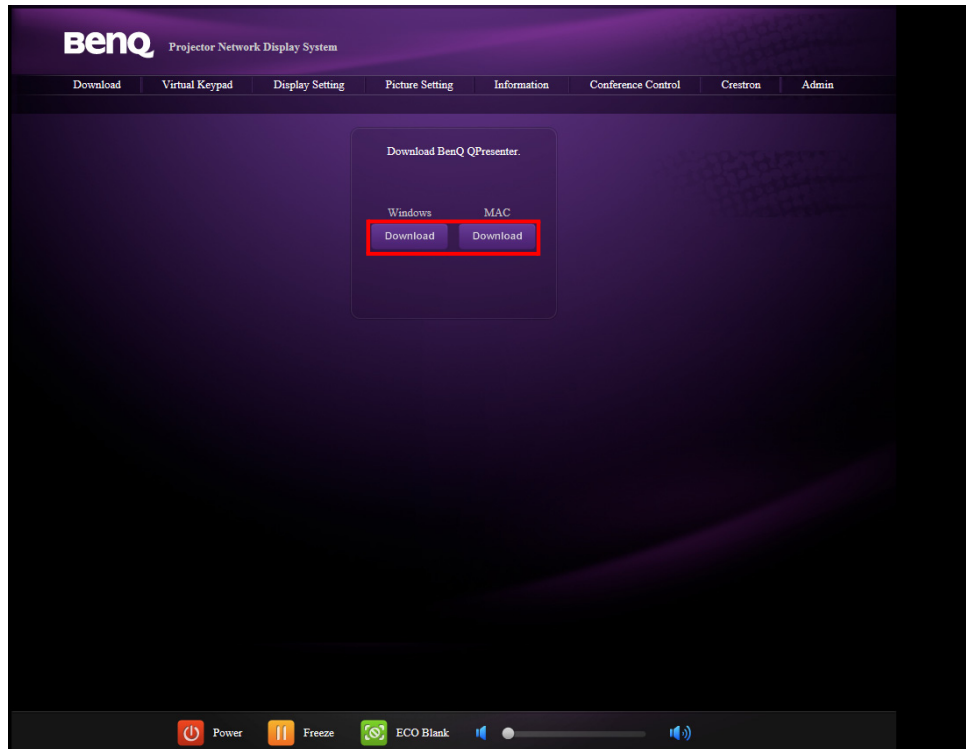

3. Click Download to save Q Presenter software on your computer.

☞ You can also link to the web page control from Q Presenter > Settings > Advanced Setting > Control projector via web page on page 62.

4. Execute the program installation.

5. Open Q Presenter, search and connect a network display. See "[Displaying image through Q Presenter](#)" on page 59 for details.

The Virtual Keypad page allows you to operate the projector as if you were using the remote control or control panel on the projector.

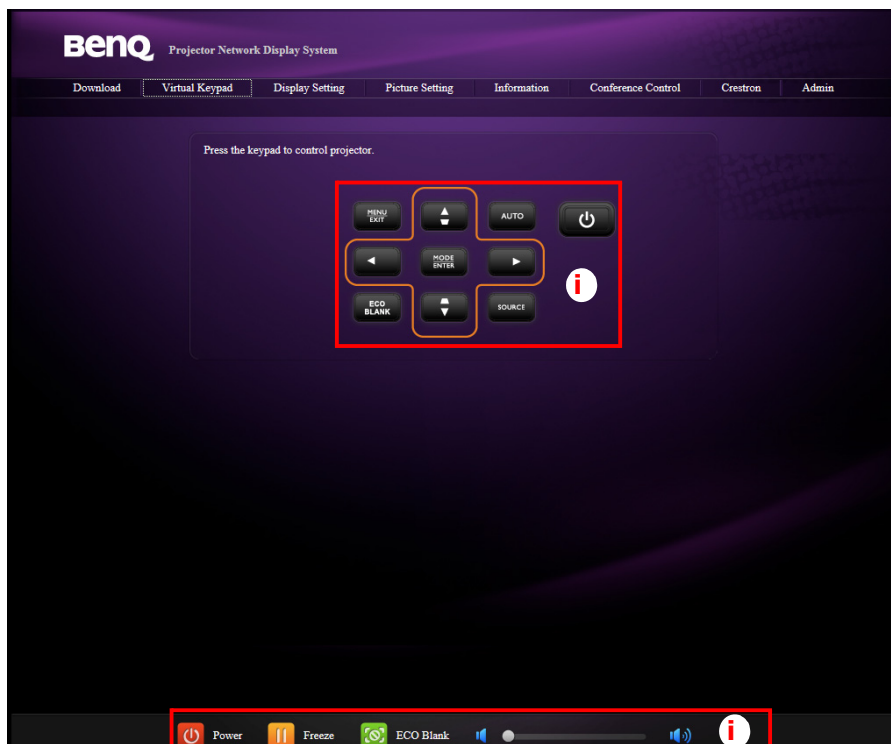

- i. These buttons function the same as the ones on the remote control. See ["Remote control" on page 14](#) for details.

The Display Setting page allows you to operate the projector as if you were using the OSD menus. These functions are some useful menu settings.

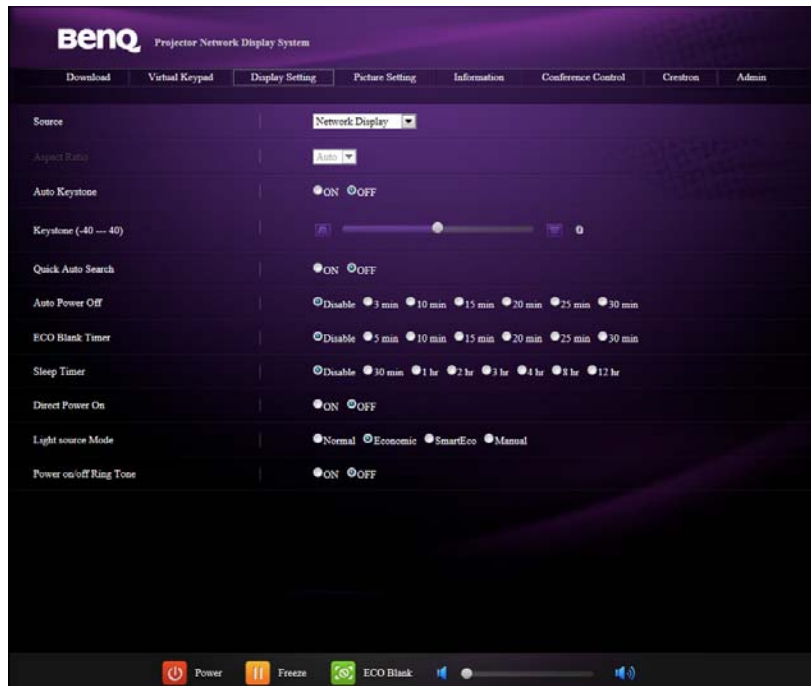

The Picture Setting page allows you to manage the projector as if you were using the **PICTURE** menu.

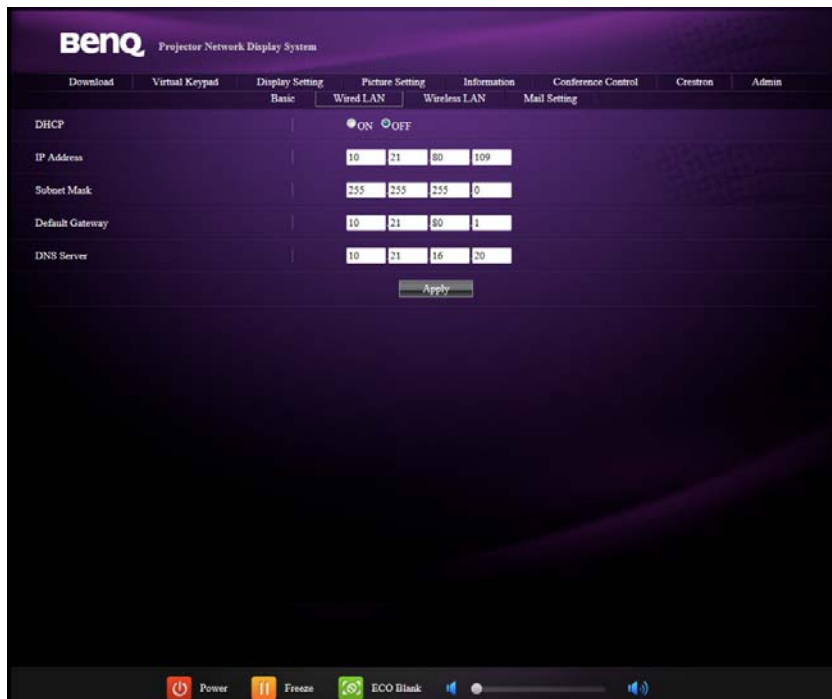

The Information page displays the information and status of this projector.

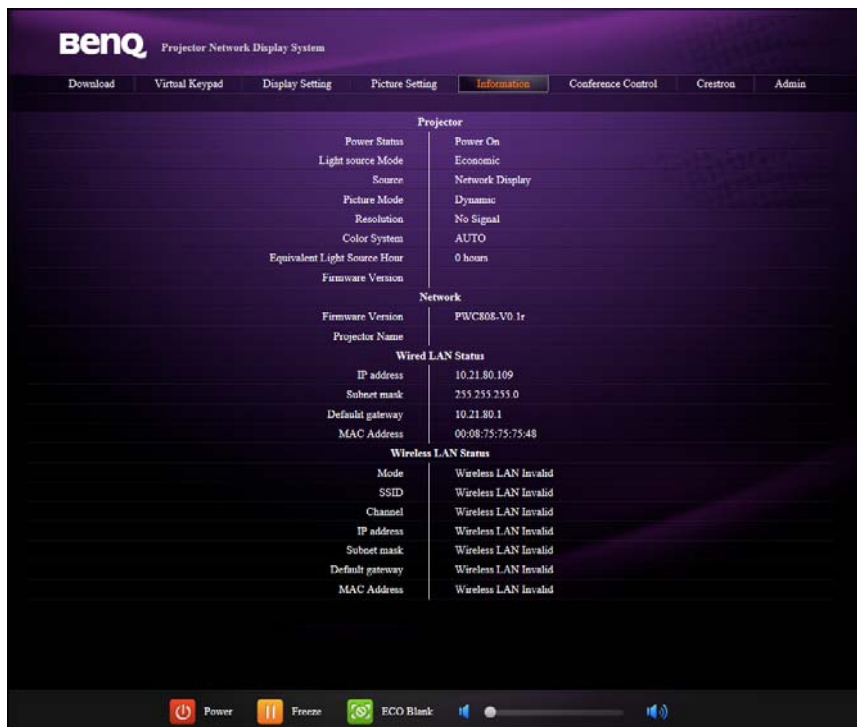

The Conference Control page allows you to control computer's display status of all the computers linked to this projector.

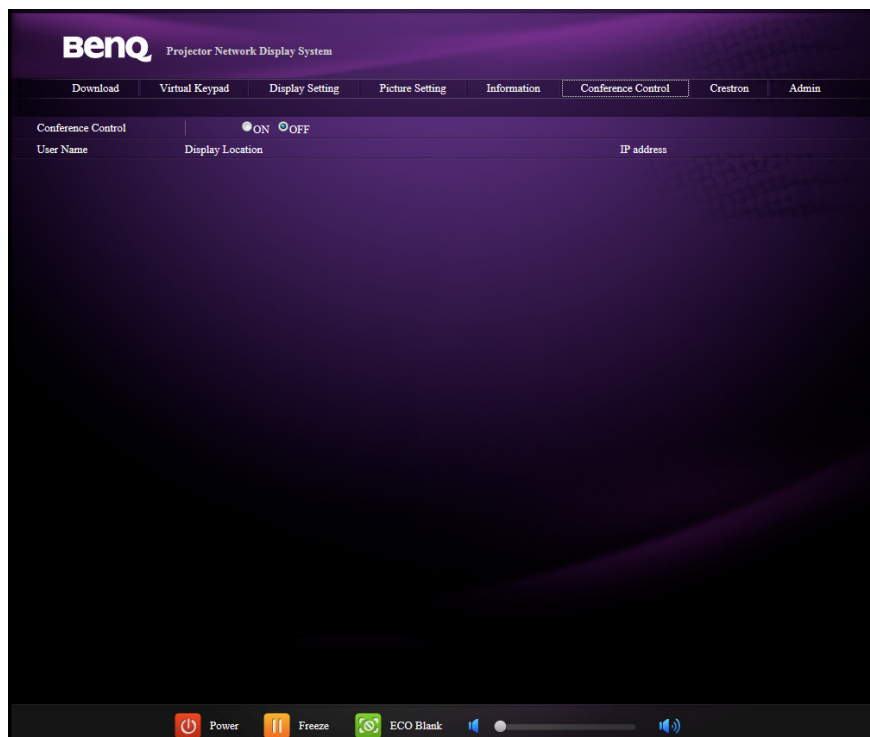

The Crestron page is only available when you are on a Wired LAN network. It also allows you to control the projector remotely. The Crestron supports RoomView version 6.2.2.9.



- i. These buttons function the same as the ones on the OSD menus or remote control. See "2. PICTURE" on page 71 and "Remote control" on page 14 for details.

 **The Menu button can also be used to go back to previous OSD menu, exit and save menu settings.**

- ii. To switch input source, click on your desired signal.
- iii. You can select a preferred OSD language.

The tools page allows you to manage the projector, configure the LAN control settings and secure access of remote network operation on this projector.

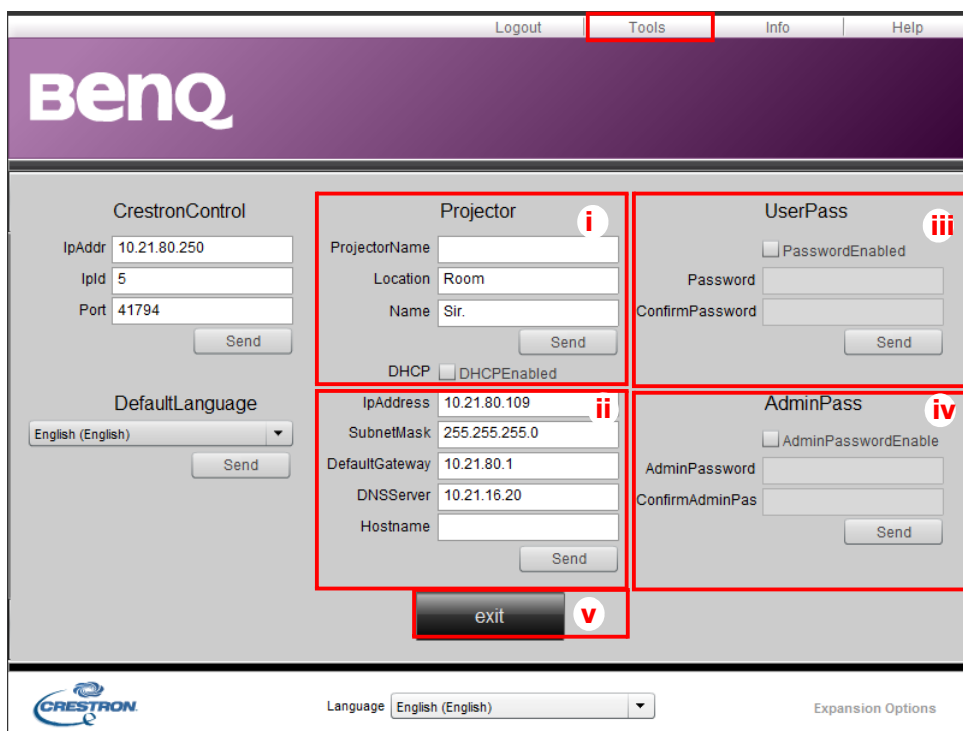

- i. You can name the projector, keep track of its location and the person in charge of it.
- ii. You can adjust the Wired LAN settings.
- iii. Once set, access to the remote network operation on this projector has been password-protected.
- iv. Once set, access to the tools page has been password-protected.

 After making the adjustments, press the **Send** button and the data will be saved in the projector.

- v. Press **exit** to go back to the Crestron remote network operation page.

The info page displays the information and status of this projector.

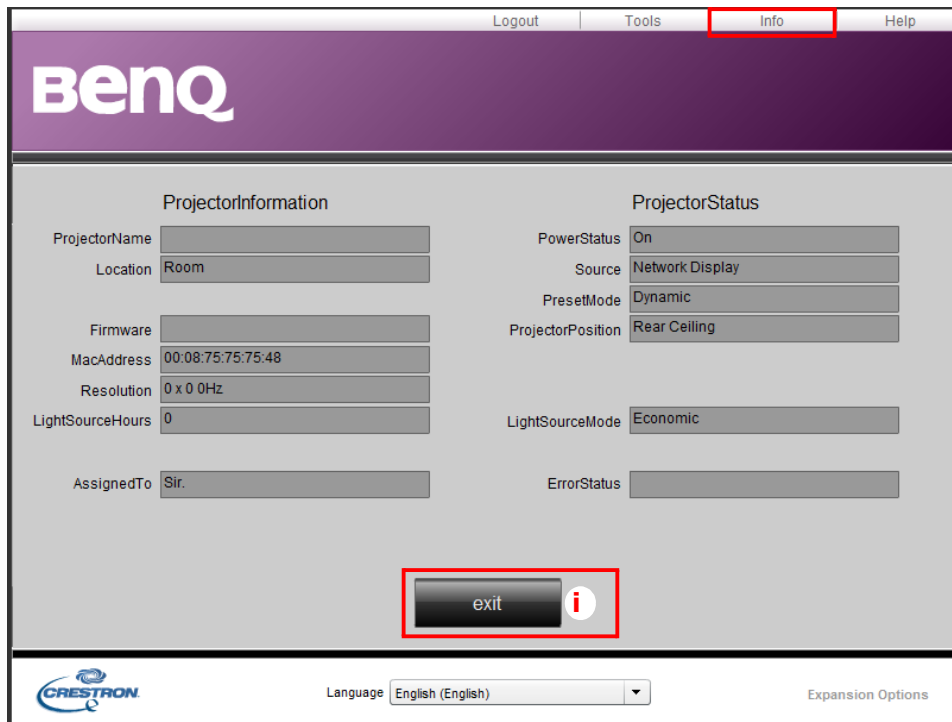

- i. Press **exit** to go back to the Crestron remote network operation page.

The Admin page allows you to enter Basic, Wired LAN, Wireless LAN and Mail pages once the password is entered. The default password is "0000". If you want to change the password, please enter Basic page.

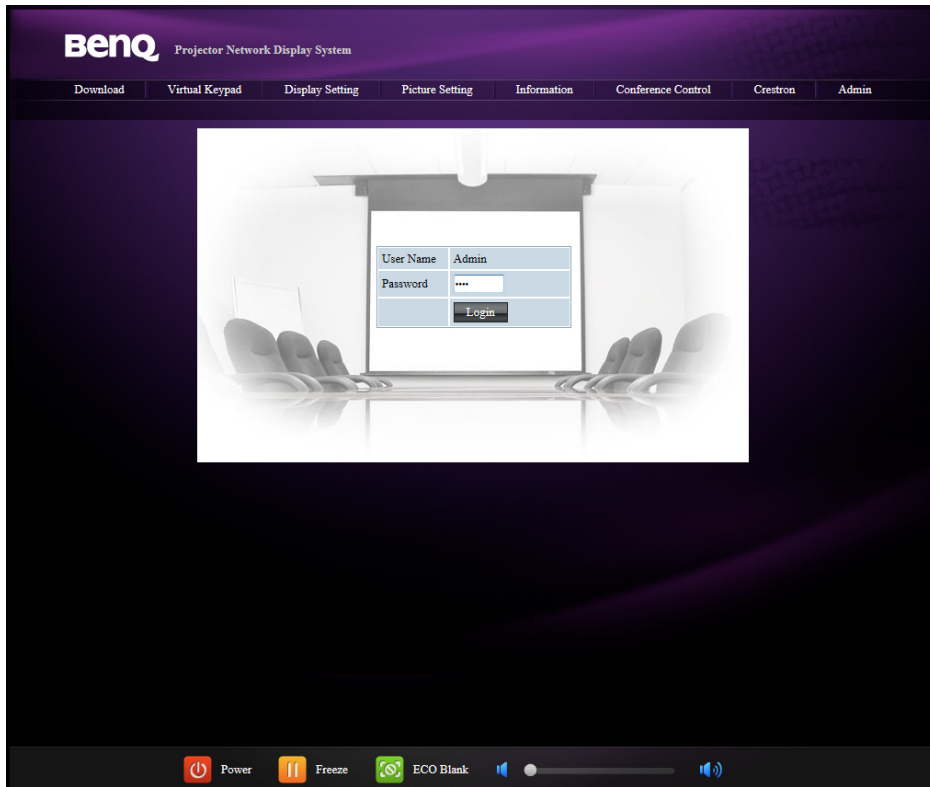

The Basic page allows you to change the password and select connected persons. The number of connected persons may affect the network display performance.

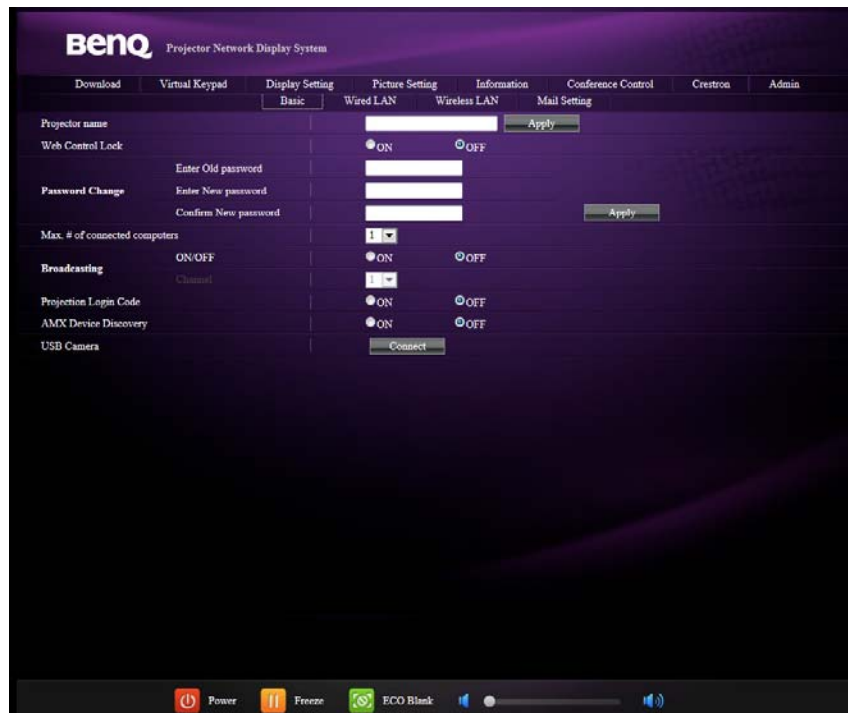



The Wired LAN page allows you to adjust the Wired LAN settings.

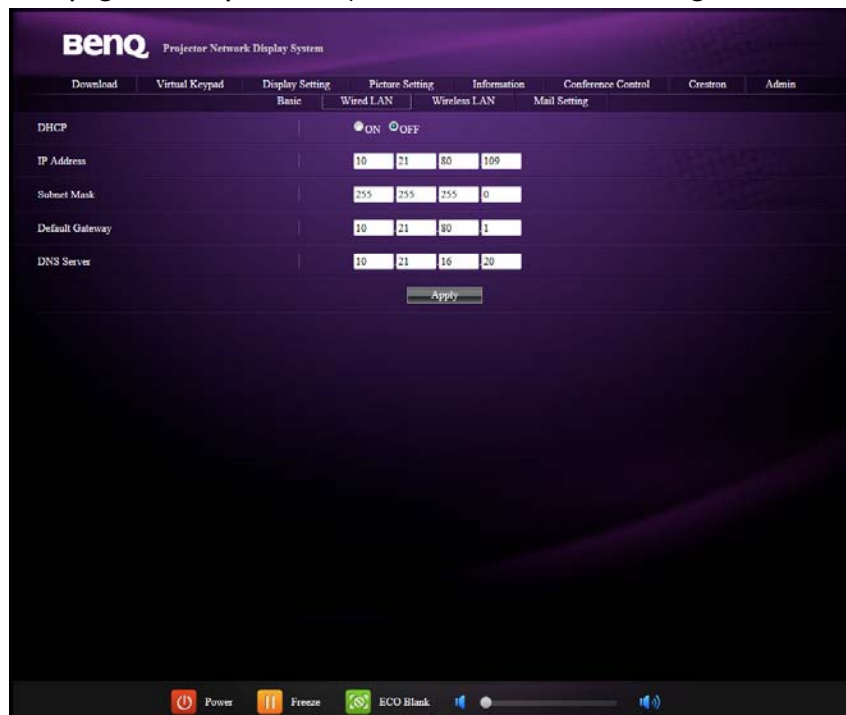

The Wireless LAN page allows you to adjust the Wireless LAN settings.

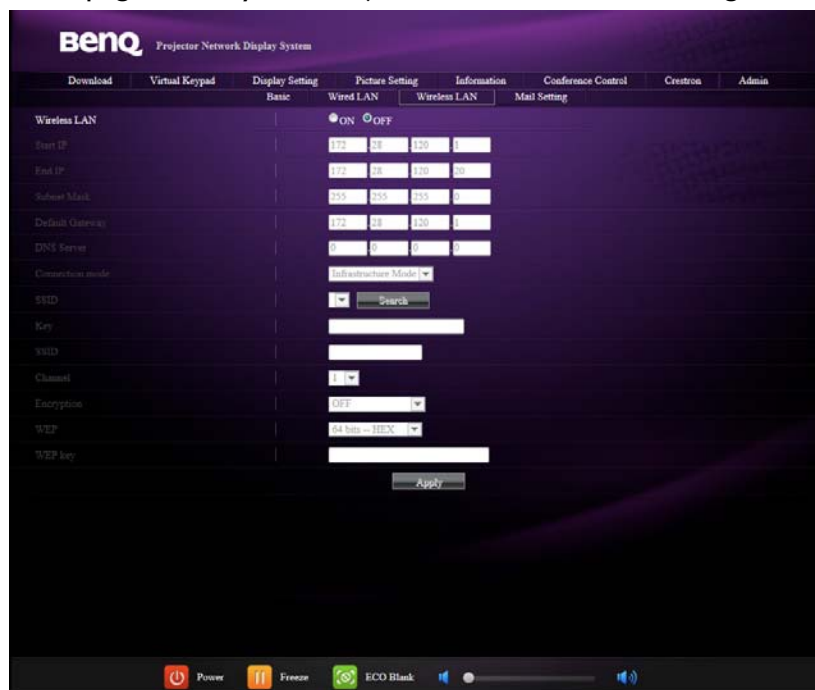

☞ Max. length for SSID string is 16 bytes. Please use a different SSID when more than two projectors are connecting through wireless LAN.

The Mail page allows you to send alert e-mail to your ITS administrator.

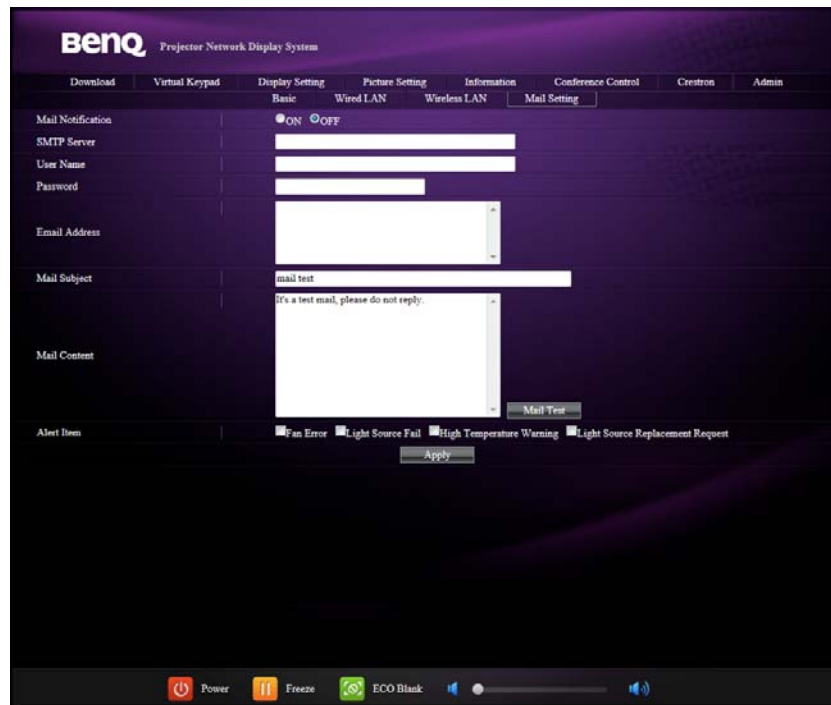

☞ You can first try the Mail Test function to check if the Alert Mail works.

# Displaying image through Q Presenter

The Q Presenter is an application running on the host PC. It connects to an available network display and transfers the desktop contents to the network display via local network connection.

 **Be sure to turn off other virtual network control programs before using Q Presenter.**

1. Connect the projector with the RJ45 cable, and make sure your laptop or computer also link to the LAN. See "[Configuring the Wired LAN Settings](#)" on page 49 and "[Configuring the Wireless LAN Settings](#)" on page 49 for details.
2. Find the IP address and enter the address of the projector in the address bar of your browser. See "[Controlling the projector remotely through a web browser](#)" on page 50 for details.
3. Download the Q Presenter, unzip it and complete program installation.
4. Once installed, double click the Q Presenter icon. The Q Presenter page appears.
5. Click the Search icon.

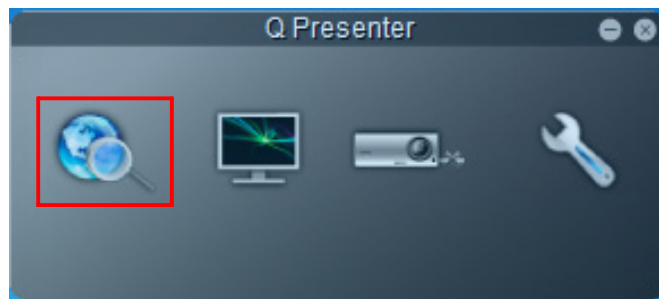

The Search page allows you to search and connect a network display.

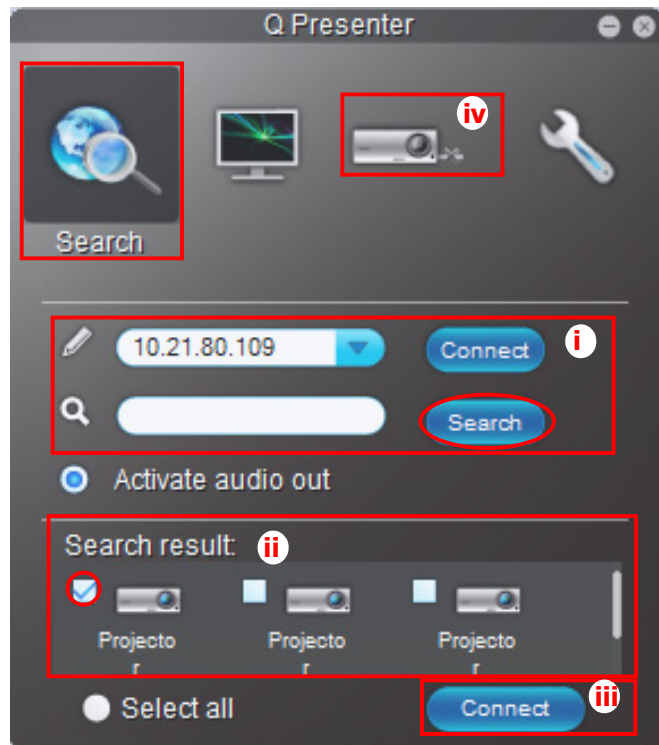

- i. You can key in the IP address (see "[Controlling the projector remotely through a web browser](#)" on page 50 for details.) or just click "Search".

- ii. Projectors linked in the LAN will be found. Then select the projector you want to link.
- iii. Click “Connect”. Then you should be able to see the image on projector.
- iv. You can click to disconnect all connected projectors..

The Special Feature page allows you to have some advanced functions to manage the display image on your projector.

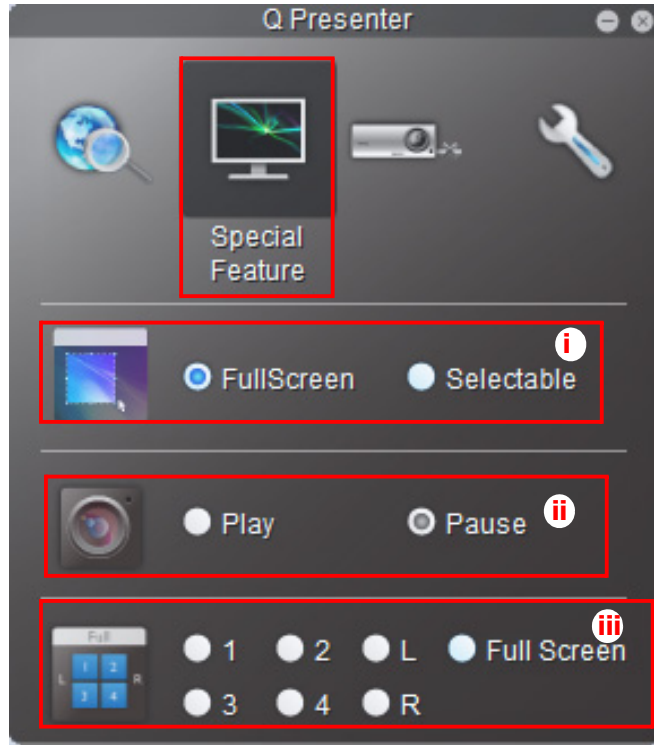

- i. Full Screen: whole image display on the projector. Selectable: a square will pop-up then you can move and drag the area you want to show the audience.

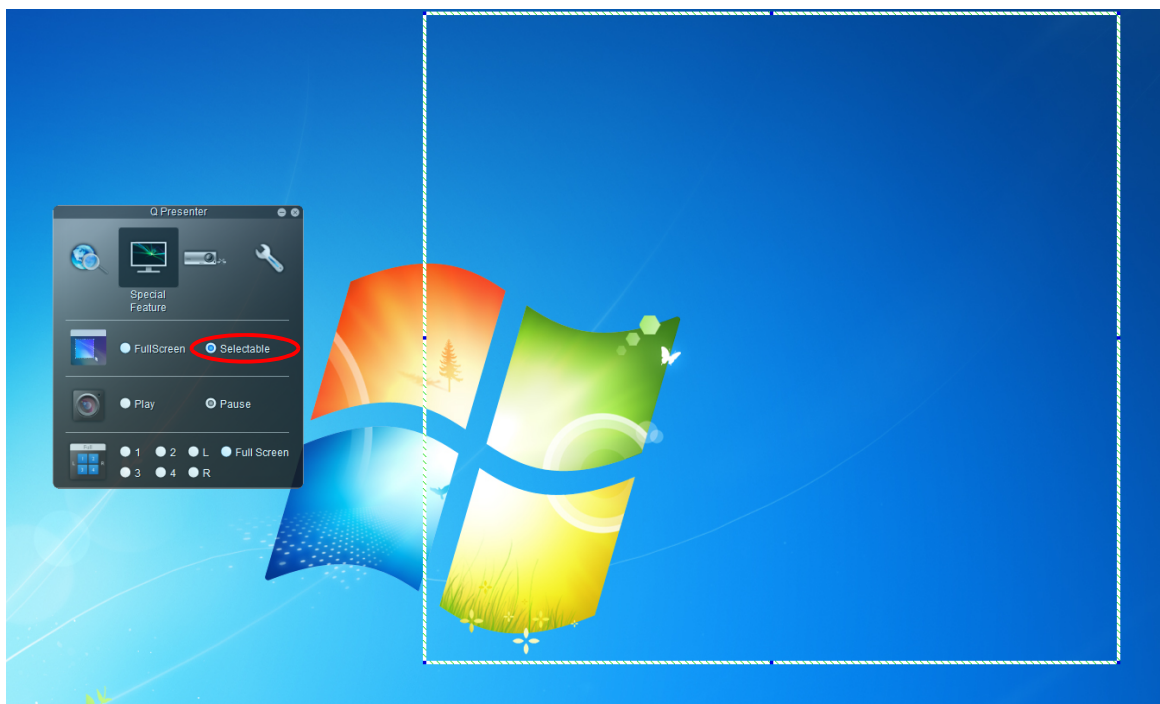

- ii. You can select to Play/Pause displaying desktop contents to connected network display.
- iii. 4-1 Display (up to 4 computers can shoot to 1 projector at the same time). Click the location you want to display. 4 locations can be chosen (1-4) or 2 places (L and R) if it's 2 computers. Once you click the place you want to display, the image appears on the projector. You can change the location anytime you want, even back to full screen or blank out.

The Basic and Advanced Settings pages allow you to configure the Q Presenter.

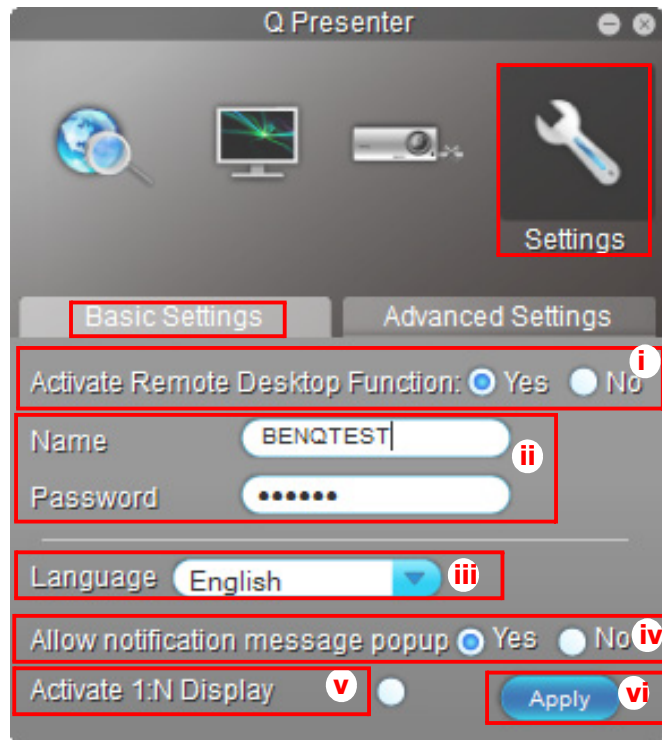

- i. You can select whether to activate Remote Desktop function. If the Remote Desktop function is activated, you can change the Name and Password. If it isn't activated, the Name and Password will be gray out.
- ii. You can set the name and password of the connected computer. The Name must be eight capital letters from A-Z & 0-9. The Password must be 6 digits from 1 to 4.
- iii. When you install the Q Presenter, the program will automatically identify the language of your computer's operating system and install the same language as your operating system. If your language isn't included, the system will keep English as the default setting.
- iv. You can select whether to allow notification message popup.
- v. Once you set to activate 1:N display, IPC/NB can display up to 8 projectors at the same time.
- vi. Once set, press Apply to save the changes.

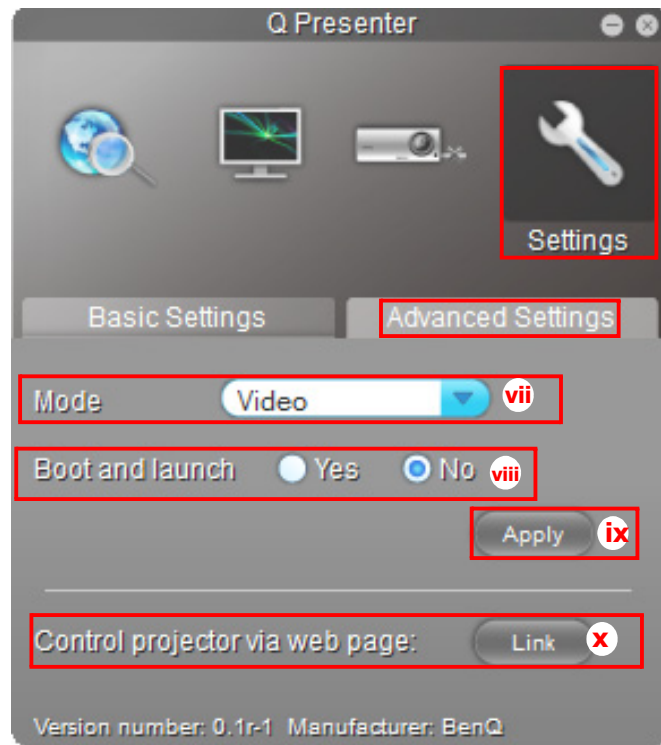

- vii. You can select Video or Graphic display mode. Graphic Mode: worse image quality but faster transmission speed. Video Mode: better image quality but slower transmission speed. However, the actual transmission performance was determined by the status of network usage at that time.
- viii. You can select whether to automatically open the Q Presenter application when the computer is powered on.
- ix. Once set, press Apply to save the changes.
- x. You can link to the BenQ remote network operation page on page 50.

# Using the Web Control Lock

This function is designed to prevent unauthorized people from maliciously changing the projector settings through the Projector Network Display System.

To enable the function:

1. After your computer is connected to the projector, enter the address of the projector in the address bar of your browser and press Enter.
2. Go to the Admin page of the Projector Network Display System.
3. Enter the current password.
4. Click ON in the Web Control Lock row.



The next time someone connects to this projector, the Projector Network Display System page provides limited functions.

To disable the function:

1. Go to the Admin page of the Projector Network Display System.
2. Enter the current password.
3. Click OFF in the Web Control Lock row.

You can also use the OSD menu to toggle this function:

1. Go to the **SYSTEM SETUP: Advanced > Security Settings > Change Security Settings** menu after opening the OSD menu system. Press **MODE/ENTER**. The message "INPUT PASSWORD" appears. Enter the current password.
2. If the password is correct, the OSD menu returns to the **Security Settings** page. Press **▼** to highlight **Web Control Lock** and press **◀/▶** to select **On** or **Off**.

# Using the Projection Login Code

This function is designed to ensure network display through the correct projector. To toggle this function:

1. Go to the **SYSTEM SETUP: Advanced > Network Settings** menu after opening the OSD menu system. Press **MODE/ENTER**.
2. Press **▼** to highlight **Projection Log In Code** and press **◀/▶** to select **On** or **Off**.

When this function is on, the projector generates a random 4-digit code in the upper right corner when you switch the source to Network Display. You need to key in this 4-digit code in the Q Presenter when connecting to the projector.

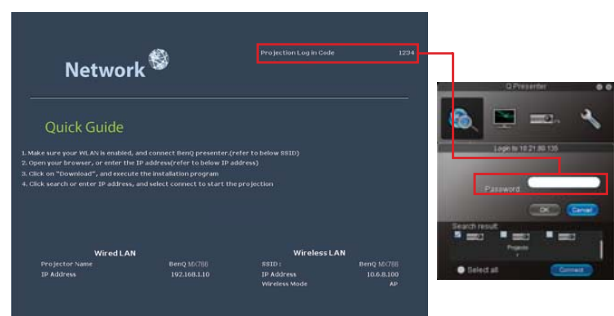

# Using the broadcasting function

When it comes to 1:N LAN Display, there are two ways to do this function:

1. By TCP/IP (support up to 8 projectors, original design)
2. By Multicast (support up to 255 projectors, this new design)

You can select channel 1, 2, 3, 4, 5, 6...25 with showing the correspondent IP (gray out).

There are 1~25 channels (25 IPs) for you to select freely:

239.192.19.21~239.192.19.45

If the channel is fixed at emergency channel, when projector detects image coming in from this channel, it will project this image automatically. There is no need to switch sources manually.

To activate this function:

 **The function requires special version of the QPresenter. Please download it from your User Manuel CD.**

1. Go to the **SYSTEM SETUP: Advanced > Network Settings** menu after opening the OSD menu system. Press **MODE/ENTER**.
2. Press **▼** to highlight **Broadcasting** and press **◀ / ▶** to select On.
3. Open the Advanced Settings page in the Qpresenter.
4. Click **Yes** in the Activating Broadcasting row and click **Apply**.

Or

1. Open the Projector Network Display System and go to the Basic page.
2. Click **On** in the **Broadcasting** row and select a channel using the drop-down list.
3. Open the Advanced Settings page in the Qpresenter.
4. Click **Yes** in the Activating Broadcasting row and click **Apply**.

-  • **This function is only available when the Network Display source is selected.**
- **The minimum system requirement for your computer is Intel Core 2 Duo 2.4GHz CPU, 2G DDR.**

# Presenting From a USB Reader

This feature displays a slide show of images stored on a USB flash drive connected to the projector. It can eliminate the need for a computer source.

## Image File Types

USB Reader displays image files in JPEG, GIF, TIFF, PNG and BMP formats.

-  • **A square box will display on the filename for unidentified characters.**
- **Thai filename is not supported.**
  - **Files in GIF, TIFF, PNG and BMP formats can be displayed for the file size smaller than WXGA (1280 x 800) only.**
  - **If a folder consists of more than 200 photos, only the first 200 photos can be displayed.**

## Preparation

To view your pictures as a slideshow, follow these steps:

1. Connect a USB flash drive to your computer and copy files from your computer to the USB flash drive.



2. Turn on your projector if needed.
3. Remove the USB flash drive from your computer and plug it into the USB TYPE-A jack of the projector.
4. The thumbnails display.

### Controlling USB Reader

While viewing thumbnails:



- i. Thumbnails
- ii. Selected folder
- iii. Supported file format

To	Press
open folder	Enter
scroll through thumbnails	four arrow keys
return to a previous page	Auto
exit USB Reader	Exit
change to a different page	◀ / ▶
go back to the first page of that folder	Back
start slide show	Slideshow when an image is highlighted.
adjust USB Reader settings	Setting

During slideshow:



To	Press
go to previous or next image	◀ / ▶
rotate the image by 90 degree clockwise/ counterclockwise	▲ / ▼ (Rotation is temporary; the image returns to its original orientation when you go back to thumbnails)
start/stop slideshow	Enter
return to a previous page	Auto

Settings page:

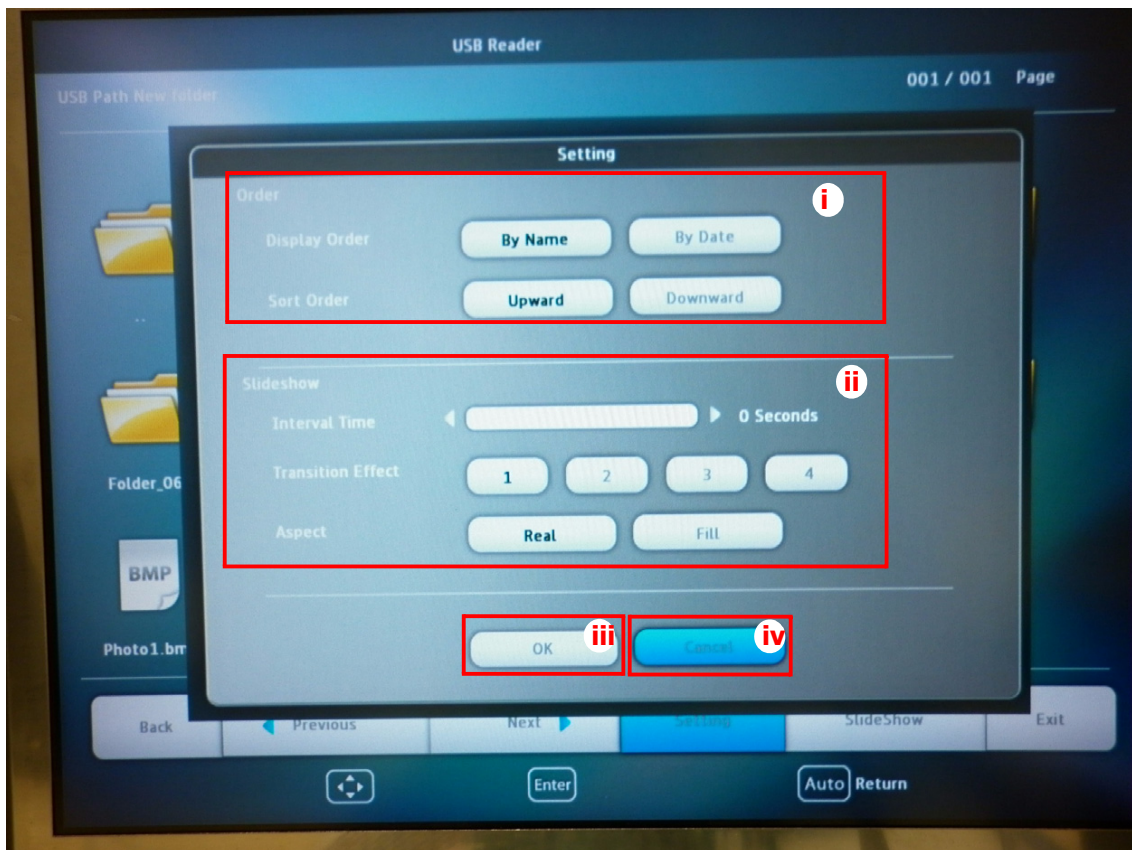

- i. You can adjust order settings.
- ii. You can adjust Slideshow settings.
- iii. Press **OK** to save the settings.
- iv. Press **Cancel** to ignore the change.

# Remote Desktop Control through Q Presenter

The Q Presenter can proceed the Remote Desktop Control (RDC) the host PC from projector site.

1. Setup the RDC login account (User name and Password ) in Q Presenter.

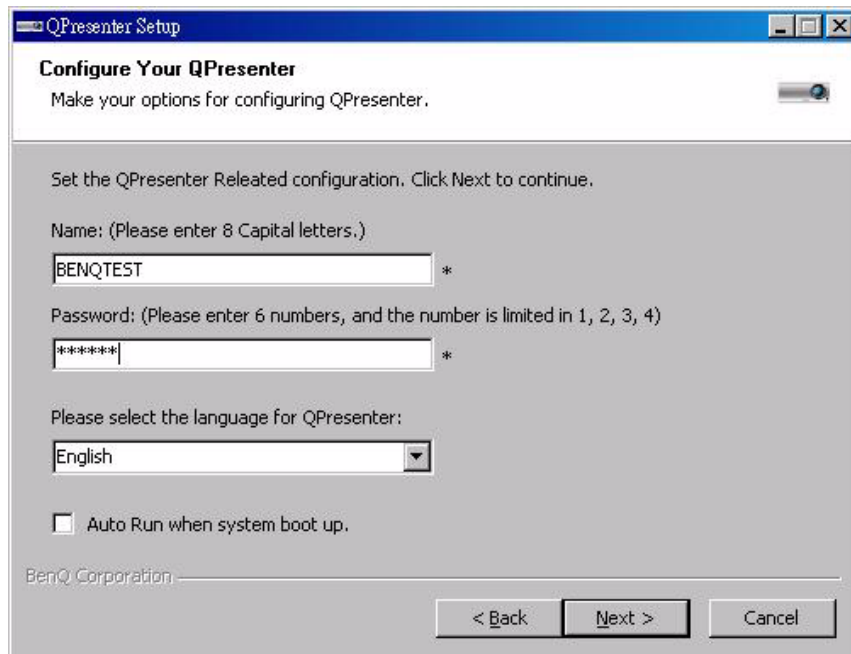

- Name: must be 8 English capital letters A~Z and number 0 ~9.
  - Password: must be 6 digits and limit the range from 1~4.
  - If there are lot of audience is watching the display while the user is entering the password, the number will be transferred to up, left, down, right in order from 1 to 4 of remote control's or projector's keypads .
  - If multiple same Q Presenter names are found, an error like "duplicate" is displayed in projector OSD.
2. Activate Remote Desktop Control Function in **Q Presenter > Settings > Basic Settings.**

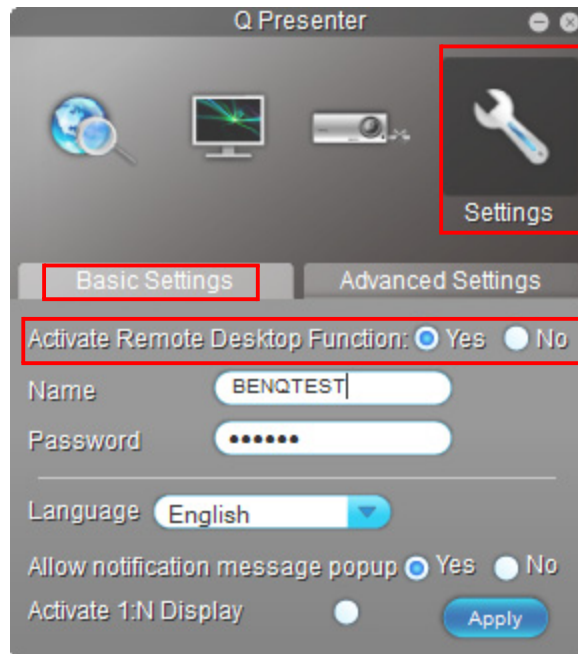

3. Open the OSD menu and go to the **SYSTEM SETUP: Advanced > Network Settings** menu. Press **MODE/ENTER**.
4. Highlight **Remote Desktop** and press **MODE/ENTER**.
5. Enter the **Account** and **Password** the same as step 1.
6. Highlight **Connect** and press **MODE/ENTER** to connect the selected PC.
7. Connect USB keyboard or mouse to control the host PC's desktop through the projector.

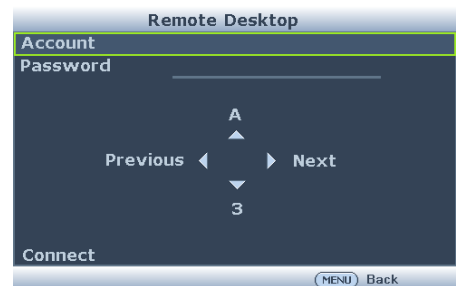

- ☞ • **Remote Desktop Control does not support PC Standby mode.**
- **Remote Desktop Control only supports LAN source so the projector source is fixed on LAN.**

# PointDraw™ Pen

The PointDraw™ pen works like a wireless mouse - but one that works in midair, not on your desktop. Just hold the pen in your hand, and point it at the projected image to point, click and drag. Please find latest compatible PointDraw™ pen user guide for more detail.

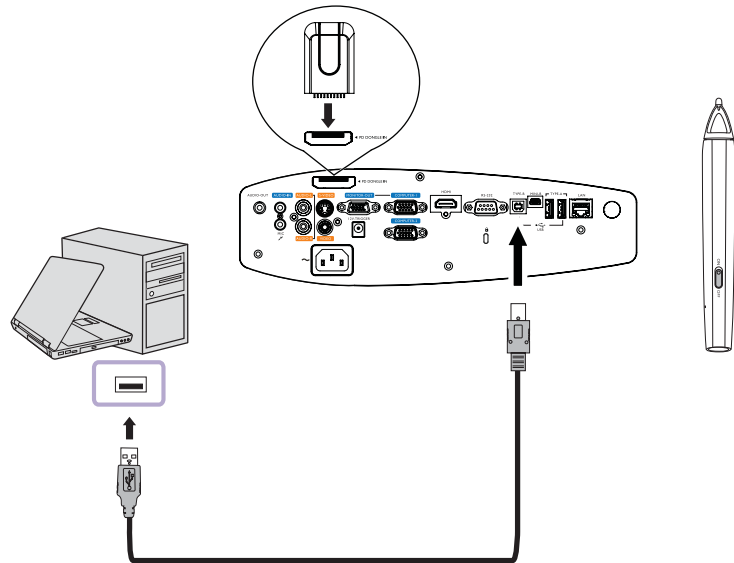

## Shutting down the projector

1. Press **Power** on the projector. A confirmation message displays prompting you. **If you don't respond in a few seconds, the message will disappear. If you use the remote control, press OFF to shut down the projector.**
2. Press **Power** on the projector a second time. The **POWER indicator light** flashes orange, the projection lamp shuts down, and the fans will continue to run to cool down the projector.

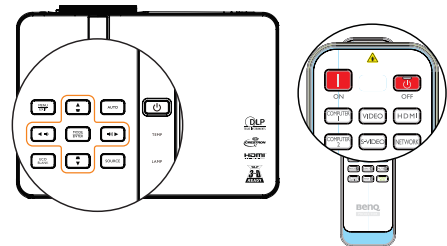

- **To protect the lamp, the projector will not respond to any commands during the cooling process.**
- **To shorten the cooling time, you can also activate the Quick Cooling function. See "Quick Cooling" on page 80 for details.**

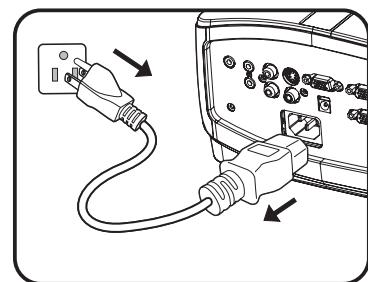

3. Once the cooling process finishes, the **POWER indicator light** is a steady orange and fans stop.
4. Disconnect the power cord from the power outlet if the projector will not be used in an extended period of time.

- **If the projector is not properly shut down, to protect the lamp, when you attempt to re-start the projector, the fans will run for a few minutes to cool down. Press Power again to start the projector after the fans stop and the POWER indicator light turns orange.**
- **Actual lamp lives may vary due to different environmental conditions and usage.**

# Menu operation

## Menu system

Please note that the on-screen display (OSD) menus vary according to the signal type selected.

Main menu	Sub-menu	Options	
1. DISPLAY	<b>Wall Color</b>	<b>Off</b> /Light Yellow/Pink/Light Green/Blue/Blackboard	
	<b>Aspect Ratio</b>	<b>Auto</b> /Real/4:3/16:9/16:10	
	<b>Keystone</b>		
	<b>Position</b>		
	<b>Phase</b>		
	<b>H. Size</b>		
	<b>Digital Zoom</b>		
	<b>3D</b>	<b>3D mode</b>	<b>Auto</b> /Top Bottom/Frame sequential/Frame packing/Side by side/Off
		<b>3D Sync Invert</b>	<b>Disable</b> /Invert
	<b>Teaching Template</b>	<b>Blackboard</b>	<b>Off</b> /Letter Formation/Worksheet/Coordinate Chart
		<b>Whiteboard</b>	<b>Off</b> /Letter Formation/Worksheet/Coordinate Chart
	2. PICTURE	<b>Picture Mode</b>	Dynamic/ <b>Presentation</b> /sRGB/Cinema/3D/User 1/User 2
		<b>Reference Mode</b>	Dynamic/ <b>Presentation</b> /sRGB/Cinema/3D
		<b>Brightness</b>	
<b>Contrast</b>			
<b>Color</b>			
<b>Tint</b>			
<b>Sharpness</b>			
<b>Brilliant Color</b>		<b>On</b> /Off	
<b>Color Temperature</b>		Cool/ <b>Normal</b> /Warm	
<b>Color Temperature Fine Tuning</b>		R Gain/G Gain/B Gain/R Offset/G Offset/B Offset	
<b>3D Color Management</b>		<b>Primary Color</b>	<b>R/G/B/C/M/Y</b>
		<b>Hue</b>	
		<b>Saturation</b>	
		<b>Gain</b>	
<b>Reset picture setting</b>	Current/All/ <b>Cancel</b>		
3. SOURCE	<b>Quick Auto Search</b>	<b>On</b> /Off	
	<b>Color Space Conversion</b>	<b>Auto</b> /RGB/YUV	

<b>Presentation Timer</b>	<b>Timer Period</b>	1~240 minutes
	<b>Timer Display</b>	<b>Always</b> /3 min/2 min/1 min/Never
	<b>Timer Position</b>	<b>Top-Left</b> /Bottom-Left/Top-Right/ Bottom-Right
	<b>Timer Counting Direction</b>	<b>Count Down</b> /Count Up
	<b>Sound Reminder</b>	<b>On/Off</b>
	<b>On/Off</b>	<b>Yes/No</b>
<b>Language</b>	English / Français / Deutsch Italiano / Español / Русский 繁體中文 / 简体中文 / 日本語 / 한국어 / Svenska / Nederlands / Türkçe / Čeština / Português / తెలుగు / Polski Magyar / Български / Hrvatski / Română / Suomi / Norsk / Dansk / Indonesian / Ελληνικά / العربية / हिन्दी	
<b>Projector Installation</b>	<b>Front Table</b> /Rear Table/Rear Ceiling/Front Ceiling	
<b>Menu Settings</b>	<b>Menu display time</b>	5 secs/10 secs/ <b>20 secs</b> /30 secs/ Always
	<b>Menu position</b>	<b>Center</b> /Top-left/Top-right/Bottom- right/Bottom-left
	<b>Reminder Message</b>	<b>On/Off</b>
<b>Operation Settings</b>	<b>Direct Power On</b>	<b>On/Off</b>
	<b>Signal Power On</b>	<b>On/Off</b>
	<b>Auto Power Off</b>	Disable/3 mins/10 mins/15 mins/20 mins/25 mins/ <b>30 mins</b>
	<b>Quick Cooling</b>	<b>On/Off</b>
	<b>Instant Restart</b>	<b>On/Off</b>
	<b>Blank Timer</b>	<b>Disable</b> /5 mins/10 mins/15 mins/20 mins/25 mins/30 mins
	<b>Sleep Timer</b>	<b>Disable</b> /30 mins/1 hr/2 hrs/3 hrs/4 hrs/8 hrs/12 hrs
	<b>Fan Speed</b>	<b>Normal</b> /High
<b>Remote Receiver</b>	<b>Front+Rear</b> /Front/Rear	
<b>Panel Key Lock</b>	<b>On/Off</b>	<b>Yes/No</b>
<b>Background Color</b>	<b>BenQ</b> /Black/Blue/Purple	
<b>Splash Screen</b>	<b>BenQ</b> /Black/Blue	
<b>PointDraw™ (MX822ST)</b>	<b>Off</b> /Single Pen/Dual Pen	



5. SYSTEM SETUP: Advanced	<b>High Altitude Mode</b>	On/Off	Yes/No	
	<b>Audio Settings</b>	<b>Mute</b>		On/Off
		<b>Volume</b>		0~10
		<b>Microphone Volume</b>		0~10
		<b>Power on/off Ring Tone</b>	On/Off	
	<b>Lamp Settings</b>	<b>Lamp Mode</b>		Normal/Economic/SmartEco
		<b>Reset lamp timer</b>		Reset/Cancel
		<b>Equivalent lamp</b>		
	<b>Security Settings</b>	<b>Change password</b>		
		<b>Change Security</b>		Power on Lock Web Control Lock
	<b>Baud Rate</b>			2400/4800/9600/14400/19200/ 38400/57600/115200
	<b>Test Pattern</b>			On/Off
	<b>Closed Caption</b>	<b>Closed Caption Enable</b>		On/Off
		<b>Caption Version</b>		CC1/CC2/CC3/CC4
	<b>Standby Settings</b>	<b>Network</b>		On/Off
		<b>Microphone</b>		On/Off
<b>Monitor Out</b>			On/Off	
<b>Audio Pass Through</b>			Off /Computer 1/Computer 2/ Video, Svideo/HDMI	

<b>5. SYSTEM SETUP: Advanced</b>	<b>Network Settings</b>	<b>Wired LAN</b>	Status
			DHCP
			IP Address
			Subnet Mask
			Default Gateway
			DNS Server
			Apply
		<b>Wireless LAN</b>	Status
			SSID
			IP Address
			Connection Mode
		<b>Remote Desktop</b>	Account
			Password
			Connect
		<b>Projection Log in code</b>	On/Off
		<b>Broadcasting</b>	Broadcasting
			Channel
IP Address			
<b>AMX Device Discovery</b>	On/Off		
<b>Mac Address</b>			
<b>Reset All Settings</b>	Reset /Cancel		
<b>6. INFORMATION</b>	<b>Current System Status</b>	<b>Source</b>	
		<b>Picture Mode</b>	
		<b>Resolution</b>	
		<b>Lamp Mode</b>	
		<b>3D Format</b>	
		<b>Color System</b>	
		<b>Equivalent Lamp</b>	
		<b>Firmware Version</b>	

Note that the menu items are available when the projector detects at least one valid signal. If there is no equipment connected to the projector or no signal detected, limited menu items are accessible.









# Description of each menu



- ☞ • The default values listed in this manual, especially on pages **75-85**, are for reference only. They may vary between the projectors due to the continuous improvement to the products.

FUNCTION	DESCRIPTION
<b>Wall Color</b>	Corrects the projected picture's color when the projection surface is not white. See <a href="#">"Using Wall Color" on page 40</a> for details.
<b>Aspect Ratio</b>	There are four options to set the image's aspect ratio depending on your input signal source. See <a href="#">"Selecting the aspect ratio" on page 38</a> for details.
<b>Auto Keystone</b>	Auto corrects any keystone of the image.
<b>Keystone</b>	Corrects any keystone of the image. See <a href="#">"Correcting keystone" on page 32</a> for details.
<b>I. DISPLAY menu</b>	<p>Displays the position adjacent page. To move the projected image, use the directional arrow keys. The values shown on the lower position of the page change with every key press you made until they reach their maximum or minimum.</p> <p>☞ <b>This function is only available when a PC signal (analog RGB) is selected.</b></p>
	<p>Adjusts the clock phase to reduce image distortion.</p>  <p>☞ <b>This function is only available when a PC signal (analog RGB) is selected.</b></p>
<b>H. Size</b>	<p>Adjusts the horizontal width of the image.</p> <p>☞ <b>This function is only available when a PC signal (analog RGB) is selected.</b></p>
<b>Digital Zoom</b>	Magnifies or reduces the projected image. See <a href="#">"Magnifying and searching for details" on page 37</a> for details.

FUNCTION	DESCRIPTION
<b>I. DISPLAY menu</b>  <b>3D</b>	<p>This projector features a 3D function which enables you to enjoy the 3D movies, videos, and sporting events in a more realistic way by presenting the depth of the images. You need to wear a pair of 3D glasses to view the 3D images.</p> <p><b>3D Mode</b> The default setting is <b>Auto</b> and the projector automatically chooses an appropriate 3D format when detecting 3D contents. If the projector cannot recognize the 3D format, press ◀ / ▶ to choose a 3D mode.</p> <p><b>3D Sync Invert</b> When you discover the inversion of the image depth, enable this function to correct the problem.</p>
<b>Teaching Template</b>	<p>Provides some templates as teaching aids. Teachers can use them for teaching. See "<a href="#">Use Teaching Template</a>" on page 48 for details.</p>

## 2. PICTURE menu

FUNCTION	DESCRIPTION
<b>Picture Mode</b>	Pre-defined picture modes are provided so you can optimize your projector image set-up to suit your program type. See <a href="#">"Selecting a picture mode" on page 39</a> for details.
<b>Reference Mode</b>	<p>Selects a picture mode that best suits your need for the image quality and further fine-tune the image based on the selections listed on the same page below. See <a href="#">"Setting the User 1/User 2 mode" on page 40</a> for details.</p> <p> <b>This function is only available when User 1 or User 2 is selected.</b></p>
<b>Brightness</b>	<p>Adjusts the brightness of the image. See <a href="#">"Adjusting Brightness" on page 40</a> for details.</p> <p> <b>This function is only available when User 1 or User 2 is selected.</b></p>
<b>Contrast</b>	<p>Adjusts the degree of difference between dark and light in the image. See <a href="#">"Adjusting Contrast" on page 40</a> for details.</p> <p> <b>This function is only available when User 1 or User 2 is selected.</b></p>
<b>Color</b>	<p>Adjusts the color saturation level -- the amount of each color in a video image. See <a href="#">"Adjusting Color" on page 40</a> for details.</p> <p> <b>This function is only available when User 1 or User 2 is selected.</b></p> <p> <b>This function is only available when a Video or S-Video signal is selected and the system format is NTSC or PAL.</b></p>
<b>Tint</b>	<p>Adjusts the red and green color tones of the image. See <a href="#">"Adjusting Tint" on page 41</a> for details.</p> <p> <b>This function is only available when User 1 or User 2 is selected.</b></p> <p> <b>This function is only available when a Video or S-Video signal is selected and the system format is NTSC or PAL.</b></p>
<b>Sharpness</b>	<p>Adjusts the image to make it look sharper or softer. See <a href="#">"Adjusting Sharpness" on page 41</a> for details.</p> <p> <b>This function is only available when User 1 or User 2 is selected.</b></p>

		FUNCTION	DESCRIPTION
2. PICTURE menu		Brilliant Color	Adjusts white peaking while maintaining correct color presentation. See <a href="#">"Adjusting Brilliant Color" on page 41</a> for details.  This function is only available when User 1/2 is selected.
		Color Temperature	See <a href="#">"Selecting a Color Temperature" on page 41</a> for details.  This function is only available when User 1/2 is selected.
		Color Temperature Fine Tuning	See <a href="#">"Setting a preferred color temperature" on page 41</a> for details.
		3D Color Management	See <a href="#">"3D Color Management" on page 41</a> for details.  This function is only available when User 1/2 is selected.
		Reset Picture Setting	See <a href="#">"Resetting current or all picture modes" on page 42</a> for details. When Picture Mode is under Dynamic, choosing "Current" will only reset the Dynamic to default value, however, choosing "All" will reset all the Picture Mode settings to default values.
3. SOURCE menu		Quick Auto Search	See <a href="#">"Switching input signal" on page 36</a> for details.
		Color Space Conversion	See <a href="#">"Changing Color Space" on page 36</a> for details.

FUNCTION	DESCRIPTION
<b>4. SYSTEM SETUP: Basic menu</b> <b>Presentation Timer</b>	<p>Reminds the presenter to finish the presentation within a certain time frame. See <a href="#">"Setting the presentation timer" on page 43</a> for details.</p> <p><b>Timer Period</b> Sets a preferred length of time for presentation.</p> <p><b>Timer Display</b> Sets whether to display the timer on screen.</p> <p><b>Timer Position</b> Sets the position where the timer displays on screen.</p> <p><b>Timer Counting Direction</b> Sets the timer counting direction.</p> <p><b>Sound Reminder</b> Sets a sound reminder if timer is up.</p>
<b>Language</b>	<p>Sets the language for the On-Screen Display (OSD) menus. See <a href="#">"Using the menus" on page 33</a> for details.</p>
<b>Projector Installation</b>	<p>The projector can be installed on a ceiling or behind a screen, or with one or more mirrors. See <a href="#">"Choosing a location" on page 17</a> for details.</p>
<b>Menu Settings</b>	<p><b>Menu display time</b> Sets the length of time the OSD will remain active after your last key press. The range is from 5 to 30 seconds in 5-second increments.</p> <p><b>Menu position</b> Sets the On-Screen Display (OSD) menu position.</p> <p><b>Reminder Message</b> Sets whether to display the reminder message.</p>

**Direct Power On**

Selecting On enables the function. See ["Starting up the projector" on page 29](#) for details.

**Signal Power On**

Selecting **On** the projector will turn on automatically when VGA signal is detected. Selecting **Off** the projector has to be turned on manually (by keypad or remote). See ["Starting up the projector" on page 29](#) for details.

**Auto Power Off**

Allows the projector to turn off automatically if no input signal is detected after a set period of time. See ["Setting Auto Power Off" on page 87](#) for details.

**Quick Cooling**

Selecting On enables the function and the projector cooling time will be shortened to a few seconds.



**If you attempt to restart the projector right after the quick cooling process, it may not be turned on successfully and will rerun its cooling fans.**

**Instant Restart**

When instant restart is on, users can restart projector immediately within 90 secs after turning off projector.

**Blank Timer**

Sets the image blank time when the Blank feature is activated, once elapsed the image will return to the screen. See ["Hiding the image" on page 44](#) for details.

**Sleep Timer**

Sets the auto-shutdown timer. The timer can be set to a value between 30 minutes and 12 hours.

**Fan Speed**



This function is only available when a dust filter is installed. Selecting **High** enables the function.



FUNCTION		DESCRIPTION	
<b>4. SYSTEM SETUP: Basic menu</b>	<b>Remote Receiver</b>	Sets which IR remote sensor of the projector will receive the signal from the remote control.	
	<b>Panel Key Lock</b>	Disables or enables all panel key functions except Power on the projector and keys on the remote control.	
	<b>Background Color</b>	Allows you to select which background color will display when no signal is input into the projector. Four options are available: BenQ logo, Black, Blue, or Purple.	
	<b>Splash Screen</b>	Allows you to select which logo screen will display during projector start-up. Four options are available: BenQ logo, MyScreen, Black, or Blue.	
	<b>PointDraw™</b>	See " <a href="#">PointDraw™ Pen</a> " on page 70 for details.	

FUNCTION	DESCRIPTION
<b>High Altitude Mode</b>	A mode for operation in high altitude areas. See <a href="#">"Operating in a high altitude environment" on page 45</a> for details.
<b>Audio Settings</b>	<p>Allows you to enter the audio setting menu. See <a href="#">"Adjusting the sound" on page 45</a> for details.</p> <p><b>Mute</b> Sets the mute function.</p> <p><b>Volume</b> Adjusts the audio volume level.</p> <p><b>Microphone volume</b> Adjusts the microphone sound level.</p> <p><b>Power on/off Ring Tone</b> Sets the power on/off ring tone.</p>
<b>Lamp Settings</b>	<p><b>Lamp Mode</b> See <a href="#">"Setting Lamp Mode eco function as Economic or SmartEco mode" on page 87</a> for details</p> <p><b>Reset lamp timer</b> See <a href="#">"Resetting the lamp timer" on page 92</a> for details.</p> <p><b>Equivalent lamp</b> See <a href="#">"Getting to know the lamp hour" on page 87</a> for details on how the total lamp hour is calculated.</p>
<b>Security Settings</b>	<p><b>Change password</b> You will be asked to enter the current password before changing to a new one.</p> <p><b>Change Security</b></p> <p><b>Power on Lock</b> See <a href="#">"Securing the projector" on page 34</a> for details.</p> <p><b>Web Control Lock</b> See <a href="#">"Using the Web Control Lock" on page 63</a> for details.</p>
<b>Baud Rate</b>	Selects a baud rate that is identical with your computer's so that you can connect the projector using a suitable RS-232 cable. This function is intended for qualified service personnel.

FUNCTION	DESCRIPTION
<b>5. SYSTEM SETUP: Advanced menu</b>	<p>Selecting On enables the function and the projector displays the grid test pattern. It helps you adjust the image size and focus and check that the projected image is free from distortion. See <a href="#">"Using build-in test pattern" on page 31</a> for details.</p>
	<p><b>Closed Caption Enable</b>  Activates the function by selecting On when the selected input signal carries closed captions.</p> <ul style="list-style-type: none"> <li>• Captions: An on-screen display of the dialogue, narration, and sound effects of TV programs and videos that are closed captioned (usually marked as "CC" in TV listings).</li> </ul> <p> <b>Set your screen aspect ratio to 4:3. This function is not available when the aspect ratio is "16:9", "16:10" or "Real".</b></p> <p><b>Caption Version</b>  Selects a preferred closed captioning mode. To view captions, select CC1, CC2, CC3, or CC4 (CC1 displays captions in the primary language in your area).</p>

FUNCTION	DESCRIPTION
Standby Settings	<p><b>Network</b> Selecting On enables the function, and the projector can be monitored or controlled over a network when it is in standby mode.</p> <p><b>Microphone</b> Selecting On enables the function, and the microphone can be used even in standby mode</p> <p><b>Monitor Out</b> Selecting On enables the function. The projector can output a VGA signal when it is in standby mode and the <b>COMPUTER I</b> and <b>MONITOR OUT</b> jacks are correctly connected to devices. See "Connecting a monitor" on page 24 for how to make the connection.</p> <p> Enabling this function slightly increases the standby power consumption.</p> <p> The Monitor Out only works when an appropriate D-Sub input is made to the <b>COMPUTER I</b> jack.</p> <p><b>Audio Pass Through</b> The projector can play sound when it is in standby mode and the corresponding jacks are correctly connected to devices. Press ◀ / ▶ to choose the source that you wish to use. See "Connection" on page 21 for how to make the connection.</p> <p> Enabling this function slightly increases the standby power consumption.</p>
Network Settings	<p><b>Wired LAN</b> See "Controlling the projector through a LAN environment" on page 49 for details.</p> <p><b>Wireless LAN</b> See "Controlling the projector through a LAN environment" on page 49 for details.</p> <p><b>Remote Desktop</b> See "Displaying image through Q Presenter" on page 59 for details.</p> <p><b>Projection Log in code</b> See "Using the Projection Login Code" on page 63 for details.</p> <p><b>Broadcasting</b> See "Using the broadcasting function" on page 64 for details.</p>

FUNCTION	DESCRIPTION
<b>5. SYSTEM SETUP: Advanced menu</b>	<p><b>AMX Device Discovery</b>  Selecting <b>On</b> the projector can be detected by AMX controller.</p> <p><b>Mac Address</b>  Show Mac address.</p>
	<p>Returns all settings to the factory preset values.</p> <p> <b>The following settings will still remain: Position, Phase, H. Size, User 1, User 2, Language, Projector Position, High Altitude Mode, Security Settings, Baud Rate.</b></p>
<b>6. INFORMATION menu</b>	<p><b>Source</b>  Shows the current signal source.</p> <p><b>Picture Mode</b>  Shows the selected mode in the <b>PICTURE</b> menu.</p> <p><b>Resolution</b>  Shows the native resolution of the input signal.</p> <p><b>Lamp Mode</b>  Shows the current lamp mode.</p> <p><b>3D Format</b>  Shows the current 3D mode.</p> <p><b>Color System</b>  Shows input system format, NTSC, PAL, SECAM, or RGB.</p> <p><b>Equivalent Lamp</b>  Displays the number of hours the lamp has been used.</p> <p><b>Firmware Version</b>  Shows firmware version.</p>

# Maintenance

## Care of the projector

Your projector needs little maintenance. The only thing you need to do on a regular basis is to keep the lens and case clean.

Never remove any parts of the projector except the lamp. Contact your dealer if other parts need replacing.

## Cleaning the lens

Clean the lens whenever you notice dirt or dust on the surface.

- Use a canister of compressed air to remove dust.
- If there is dirt or smears, use lens-cleaning paper or moisten a soft cloth with lens cleaner and gently wipe the lens surface.
- Never use any type of abrasive pad, alkaline/acid cleaner, scouring powder, or volatile solvent, such as alcohol, benzene, thinner or insecticide. Using such materials or maintaining prolonged contact with rubber or vinyl materials may result in damage to the projector surface and cabinet material.

 **Never rub the lens with abrasive materials.**

## Cleaning the projector case

Before you clean the case, turn the projector off using the proper shutdown procedure as described in "[Shutting down the projector](#)" on [page 70](#) and unplug the power cord.

- To remove dirt or dust, wipe the case with a soft, lint-free cloth.
- To remove stubborn dirt or stains, moisten a soft cloth with water and a neutral pH detergent. Then wipe the case.

 **Never use wax, alcohol, benzene, thinner or other chemical detergents. These can damage the case.**

## Storing the projector

If you need to store the projector for an extended time, please follow the instructions below:

- Make sure the temperature and humidity of the storage area are within the recommended range for the projector. Please refer to "[Specifications](#)" on [page 96](#) or consult your dealer about the range.
- Retract the adjuster feet.
- Remove the battery from the remote control.
- Pack the projector in its original packing or equivalent.

## Transporting the projector

It is recommended that you ship the projector with its original packing or equivalent.

# Lamp information

## Getting to know the lamp hour

When the projector is in operation, the duration (in hours) of lamp usage is automatically calculated by the built-in timer. The method of calculating the equivalent lamp hour is as follows:

Total (equivalent) lamp hour  
= 1 (hours used in Economic mode) + 4/3 (hours used in normal mode)

☞ See "**Setting Lamp Mode eco function as Economic or SmartEco mode**" below for more information on Economic mode.

The lamp hour in **Economic** mode is calculated as 3/4 of that in **Normal** mode. That is, using the projector in **Economic** mode helps to extend the lamp hour by 1/3.

To obtain the lamp hour information:

1. Press **MENU/EXIT** and then press ◀/▶ until the **SYSTEM SETUP: Advanced** menu is highlighted.
2. Press ▼ to highlight **Lamp Settings** and press **MODE/ENTER**. The **Lamp Settings** page displays.
3. You will see the **Equivalent lamp** information displaying on the menu.
4. To leave the menu, press **MENU/EXIT**.

You can also get the lamp hour information on the **INFORMATION** menu.

## Extending lamp life

The projection lamp is a consumable item. To keep the lamp life as long as possible, you can do the following settings via the OSD menu or remote control.

### Setting Lamp Mode eco function as Economic or SmartEco mode

Using **Economic /SmartEco** mode will reduce system noise and power consumption. If the **Economic/SmartEco** mode is selected, the light output will be reduced and result in darker projected pictures, the projector protected for longer working life.

Setting the projector in **Economic/SmartEco** mode also extends the lamp operation life. To set **Economic/SmartEco** mode, go into the **SYSTEM SETUP: Advanced > Lamp Settings > Lamp Mode** menu and press ◀/▶ . .

The lamp modes are defined as the chart below.

Lamp Mode	Description
Normal	100% lamp brightness.
Economic	Saves 20% lamp power consumption.
SmartEco	Saves up to 70% lamp power consumption depending on the content brightness level.

### Setting Auto Power Off

This function allows the projector to turn off automatically if no input source is detected after a set period of time to prevent unnecessary waste of lamp life.

To set **Auto Power Off**, go into the **SYSTEM SETUP: Basic > Operation Settings > Auto Power Off** menu and press ◀/▶ . The time period can be set from 5 to 30 minutes in 5-minute increments. If the preset time lengths are not suitable for your

presentation, select **Disable**. The projector will not automatically shut down in a certain time period.





# Timing of replacing the lamp

When the Lamp indicator lights up red or a message appears suggesting it is time to replace the lamp, please install a new lamp or consult your dealer. An old lamp may cause a malfunction in the projector and in some instances the lamp may explode.

 **The Lamp indicator light and Temperature warning light will light up if the lamp becomes too hot. See "Indicators" on page 96 for details.**

The following lamp warning displays will remind you to change the lamp.

 **The warning messages below are for reference only. Please follow the actual on-screen instructions to prepare and replace the lamp.**

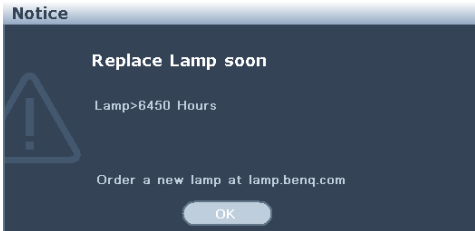
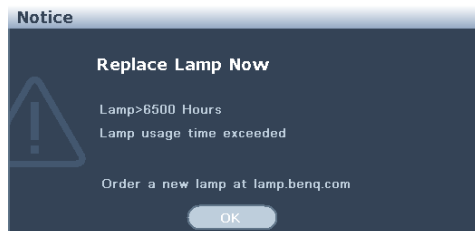
Status	Message
<p>Install a new lamp for optimal performance. If the projector is normally run with <b>Economic</b> selected (see "<a href="#">Setting Lamp Mode eco function as Economic or SmartEco mode</a>" on page 87), you may continue to operate the projector until the next lamp warning appears.</p> <p>Press <b>ENTER</b> to dismiss the message.</p>	 <p>The screenshot shows a dark blue notification box with a white exclamation mark icon on the left. The text inside reads: 'Notice', 'Order Replacement Lamp', 'Lamp&gt;6000 Hours', and 'Order a new lamp at lamp.benq.com'. At the bottom right is a white 'OK' button.</p>
<p>It is strongly recommended that you replace the lamp at this stage. The lamp is a consumable item. The lamp brightness diminishes with use. This is a normal lamp behavior. You can replace the lamp whenever you notice that the brightness level has significantly diminished.</p> <p>Press <b>ENTER</b> to dismiss the message.</p>	 <p>The screenshot shows a dark blue notification box with a white exclamation mark icon on the left. The text inside reads: 'Notice', 'Replace Lamp soon', 'Lamp&gt;6450 Hours', and 'Order a new lamp at lamp.benq.com'. At the bottom right is a white 'OK' button.</p>
<p>The lamp <b>MUST</b> be replaced before the projector will operate normally.</p> <p>Press <b>ENTER</b> to dismiss the message.</p>	 <p>The screenshot shows a dark blue notification box with a white exclamation mark icon on the left. The text inside reads: 'Notice', 'Replace Lamp Now', 'Lamp&gt;6500 Hours', 'Lamp usage time exceeded', and 'Order a new lamp at lamp.benq.com'. At the bottom right is a white 'OK' button.</p>

# Replacing the lamp



- **Hg - Lamp contains mercury. Manage in accordance with local disposal laws. See [www.lamprecycle.org](http://www.lamprecycle.org).**
  - **If lamp replacement is performed while the projector is suspended upside-down from the ceiling, make sure that no one is underneath the lamp socket to avoid any possible injury or damage to the human eyes caused by fractured lamp.**
  - **To reduce the risk of electrical shock, always turn the projector off and disconnect the power cord before changing the lamp.**
  - **To reduce the risk of severe burns, allow the projector to cool for at least 45 minutes before replacing the lamp.**
  - **To reduce the risk of injuries to fingers and damage to internal components, use caution when removing lamp glass that has shattered into sharp pieces.**
  - **To reduce the risk of injuries to fingers and/or compromising image quality by touching the lens, do not touch the empty lamp compartment when the lamp is removed.**
  - **This lamp contains mercury. Consult your local hazardous waste regulations to dispose of this lamp in a proper manner.**
  - **To assure optimal performance from the projector, it is recommended that you purchase a BenQ projector lamp for lamp replacement.**
1. Turn the power off and disconnect the projector from the power outlet. If the lamp is hot, avoid burns by waiting for approximately 45 minutes until the lamp has cooled.
  2. Loosen the screw on the lamp cover.

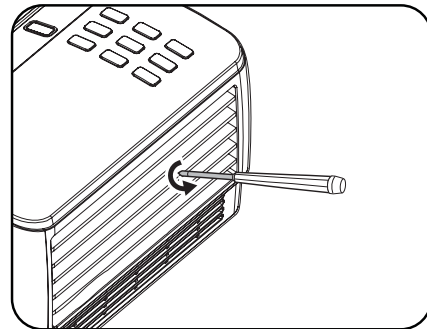

3. Remove the lamp cover by (a) sliding the cover toward the side of the projector and (b) lifting it off.



- Do not turn the power on with the lamp cover removed.
- Do not insert your fingers between the lamp and the projector. The sharp edges inside the projector may cause injuries.

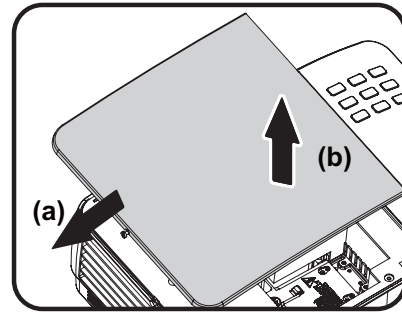

4. Loosen the screws that secure the lamp.

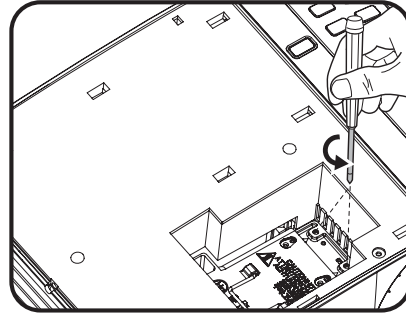

5. Lift the handle so that it stands up. Use the handle to slowly pull the lamp out of the projector.



- Pulling it too quickly may cause the lamp to break and scatter broken glass in the projector.
- Do not place the lamp in locations where water might splash on it, children can reach it, or near flammable materials.
- Do not insert your hands into the projector after the lamp is removed. If you touch the optical components inside, it could cause color unevenness and distortion of the projected images.

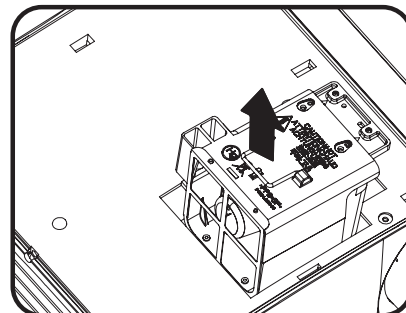

6. Insert the new lamp into the lamp compartment and make sure it fits in the projector.

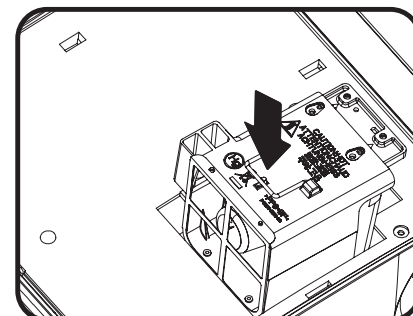

7. Tighten the screws that secure the lamp.

⚠ • **Loose screw may cause a bad connection, which could result in malfunction.**

• **Do not over tighten the screws.**

8. Ensure the handle is fully laid flat and locked in place.

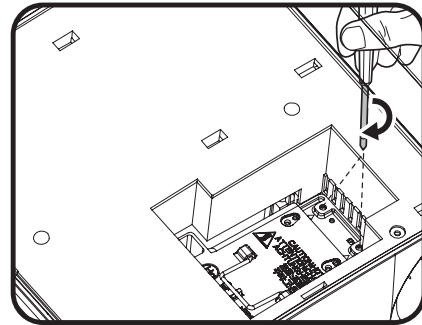

9. Replace the lamp cover by sliding it into place.

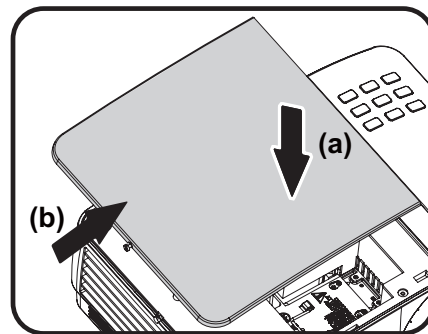

10. Tighten the screw that secures the lamp cover.

⚠ • **Loose screw may cause a bad connection, which could result in malfunction.**

• **Do not over tighten the screw.**

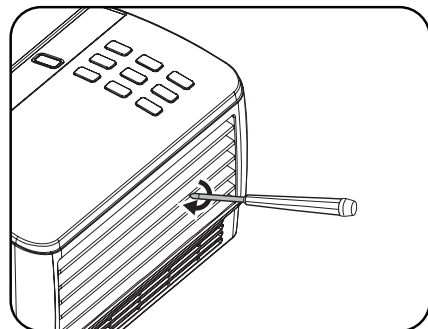

11. Restart the projector.

⚠ **Do not turn the power on with the lamp cover removed.**

### Resetting the lamp timer

12. After the startup logo, open the On-Screen Display (OSD) menu. Go to the **SYSTEM SETUP: Advanced > Lamp Settings** menu. Press **MODE/ENTER**. The **Lamp Settings** page displays. Press **▼** to highlight **Reset lamp timer** and press **MODE/ENTER**. A warning message displays asking if you want to reset the lamp timer. Highlight **Reset** and press **MODE/ENTER**. The lamp time will be reset to '0'.

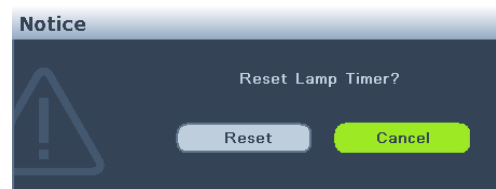

⚠ **Do not reset if the lamp is not new or replaced as this could cause damage.**

# Indicators

Light			Status & Description
POWER	TEMP	LAMP	
<b>Power events</b>			
Orange	Off	Off	Stand-by mode
Green Flashing	Off	Off	Powering up
Green	Off	Off	Normal operation
Orange Flashing	Off	Off	Normal power-down cooling
Red	Off	Off	Download
Green	Off	Red	CW start fail
Red Flashing	Off	Off	Scaler shutdown fail (data abort)
Red	Off	Red	Scaler reset fail (video projector only)
Off	Red	Off	LAN download fail
Off	Green	Off	LAN download processing
<b>Burn-in message</b>			
Green	Off	Off	Burn-in ON
Green	Green	Green	Burn-in OFF
<b>Lamp events</b>			
Off	Off	Red	Lamp I error in normal operation
Off	Off	Red Flashing	Lamp is not lit up
<b>Thermal events</b>			
Red	Red	Off	Fan 1 error (the actual fan speed is $\pm 25\%$ outside the desired speed)
Red	Red Flashing	Off	Fan 2 error (the actual fan speed is $\pm 25\%$ outside the desired speed)
Red	Green	Off	Fan 3 error (the actual fan speed is $\pm 25\%$ outside the desired speed)
Red Flashing	Red Flashing	Off	Temperature 1 error (over limited temperature)
Green	Red Flashing	Off	Thermal Sensor 1 open error
Green	Green	Off	Thermal Sensor 1 short error
Green	Green Flashing	Off	Thermal IC #1 I2C Connection error
Green Flashing	Red	Off	Temperature 2 error (over limited temperature)

<b>Green Flashing</b>	<b>Red Flashing</b>	<b>Off</b>	Thermal Sensor 2 open error
<b>Green Flashing</b>	<b>Green</b>	<b>Off</b>	Thermal Sensor 2 short error
<b>Green Flashing</b>	<b>Green Flashing</b>	<b>Off</b>	Thermal IC #2 I2C Connection error

# Troubleshooting

## ① The projector does not turn on.

Cause	Remedy
There is no power from the power cable.	Plug the power cord into the AC inlet on the projector, and plug the power cord into the power outlet. If the power outlet has a switch, make sure that it is switched on.
Attempting to turn the projector on again during the cooling process.	Wait until the cooling down process has completed.

## ① No picture

Cause	Remedy
The video source is not turned on or connected correctly.	Turn the video source on and check that the signal cable is connected correctly.
The projector is not correctly connected to the input signal device.	Check the connection.
The input signal has not been correctly selected.	Select the correct input signal with the <b>SOURCE</b> key on the projector or remote control.
The lens cover is still closed.	Open the lens cover.

## ① Blurred image

Cause	Remedy
The projection lens is not correctly focused.	Adjust the focus of the lens using the focus ring.
The projector and the screen are not aligned properly.	Adjust the projection angle and direction as well as the height of the unit if necessary.
The lens cover is still closed.	Open the lens cover.

## ① Remote control does not work

Cause	Remedy
The battery is out of power.	Replace the battery with new one.
There is an obstacle between the remote control and the projector.	Remove the obstacle.
You are too far away from the projector.	Stand within 8 meters (26 feet) of the projector.

## ① The password is incorrect

Cause	Remedy
You do not remember the password.	Please see <a href="#">"Entering the password recall procedure"</a> on page 35 for details.

# Specifications

 All specifications are subject to change without notice

## Optical

Resolution  
(MX766/MX822ST)  
1024 x 768 XGA  
(MW767)  
1280 x 800 WXGA  
Display system  
I-CHIP DMD  
Lens F/Number  
(MX766/MW767)  
F= 2.42~2.98  
f= 20.77mm~31.13mm  
(MX822ST)  
F = 2.8  
f = 7.26 mm  
Offset  
(MX766/MX822ST): 130%  
(MW767): 125%  
Zoom ratio  
(MX766/MW767): 1.5X  
(MX822ST): Fixed  
Lamp  
310 W lamp

## Electrical

Power supply  
AC100~240V, 4.20 A,  
50-60 Hz (Automatic)  
Power consumption  
420 W (Max.)

## Mechanical

Weight  
3.9 kg (8.6 lbs.)

## Output terminals

RGB output  
D-Sub 15-pin (female) x 1  
Speaker  
(Stereo) 20 watt x 1  
Audio signal output  
PC audio jack x 1

## Control

LAN control  
Wire (RJ45)  
Wireless (USB A type)  
Firmware upgrade (USB B type)

## Input terminals

Computer input  
RGB input  
D-Sub 15-pin (female) x 2  
Video signal input  
S-VIDEO  
Mini DIN 4-pin port x 1  
VIDEO  
RCA jack x 1  
SD/HDTV signal input  
Analog - Component RCA jack x 3  
(through RGB input)  
Digital-HDMI x 1  
Audio signal input  
Audio in  
PC audio jack x 1  
RCA audio jack (L/R) x 2  
Remote desktop /USB reader /document camera  
supported (USB A type)  
USB display (USB mini B type)  
PD pen compatibility (PD dongle in Jack only for  
MX822ST)

## Environmental Requirements

Operating temperature  
0°C-40°C at sea level  
Operating relative humidity  
10%-90% (without condensation)  
Operating altitude  
0-1499 m at 0°C-35°C  
1500-3000\* m at 0°C-30°C (with High  
Altitude Mode on)  
\* China region only applies to an altitude of  
2000m.

 Lamp life results will vary depending on environmental conditions and usage.



# Dimensions

MX766/MW767

329 mm (W) x 137.2 mm (H) x 256.2 mm (D)

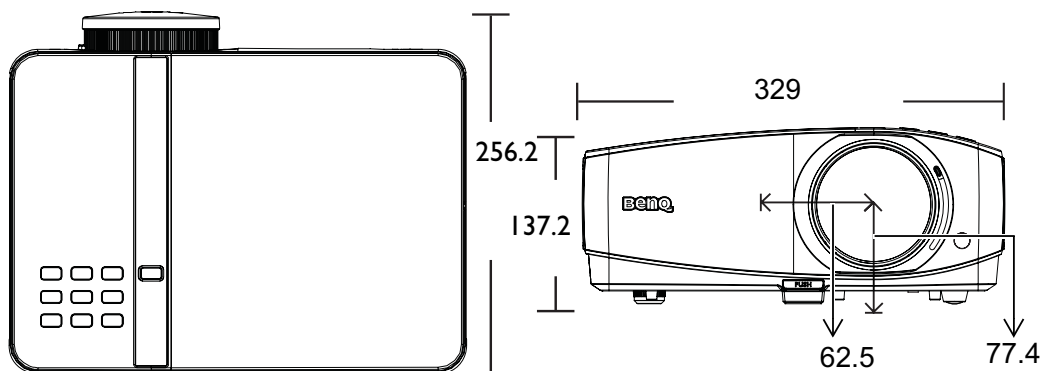

MX822ST

329 mm (W) x 137.2 mm (H) x 246.5 mm (D)

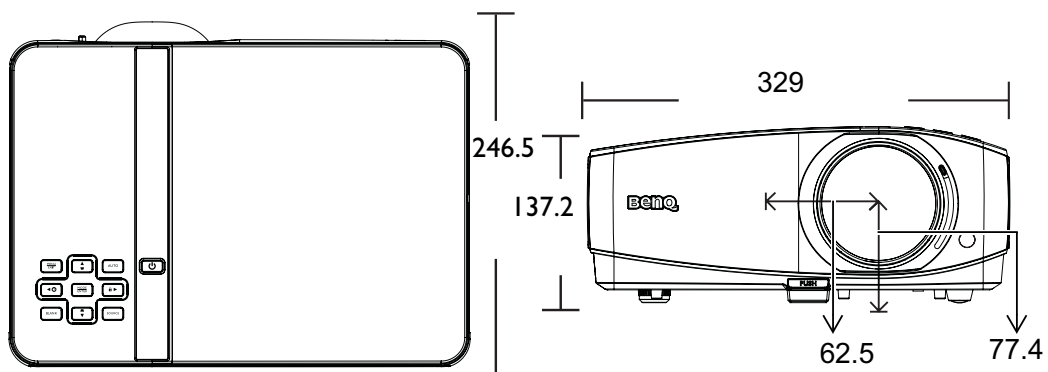

# Ceiling mount installation

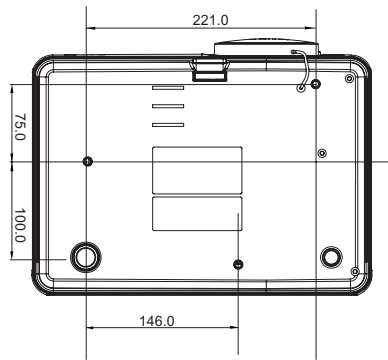

**Ceiling mount screw: M4**  
**(Max L = 25 mm; Min L = 20 mm)**

**Unit: mm**

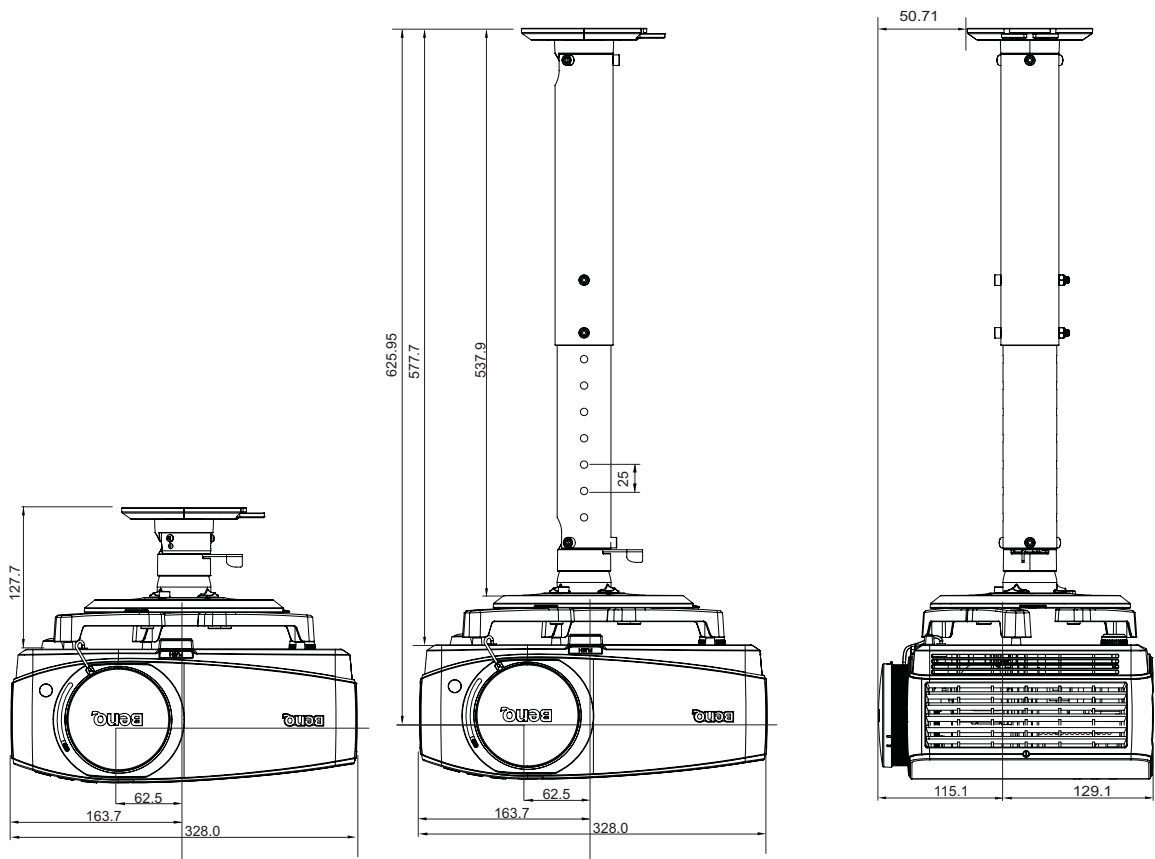

# Wall mount installation

## Minimum installation requirements

MX822ST

Computer Resolution: XGA Image Resolution: XGA	Diagram Reference	SMART Board 660	SMART Board 680	Promethean ActivBoard 164	Promethean ActivBoard 178	RM CkassBiard2 77.5	Hitachi StarBoard FX-63	StarBoard FX-77
Image Diagonal (inches)	D	64	77	64	78	78	63	77
Image Height (mm)	H	975	1173	975	1188	1188	960	1173
Image Width (mm)	W	1301	1565	1301	1585	1585	1280	1565
Distance from floor to bottom of image (mm)	f	900	900	900	900	900	900	900
Distance from screen surface to projector front case (mm)	a	815	980	815	993	993	802	980
Distance from top case to the top of image(mm)	b	146	176	146	178	178	144	176
Distance from top of wall mount to ceiling (mm)	c	50	50	50	50	50	50	50
Minimum Ceiling Height (mm)	e	2393.2	2621.2	2393.2	2638.2	2638.2	2376.2	2621.2

## Minimum Ceiling Height (mm) = $f + H + b + 60 + 262.2 + c$

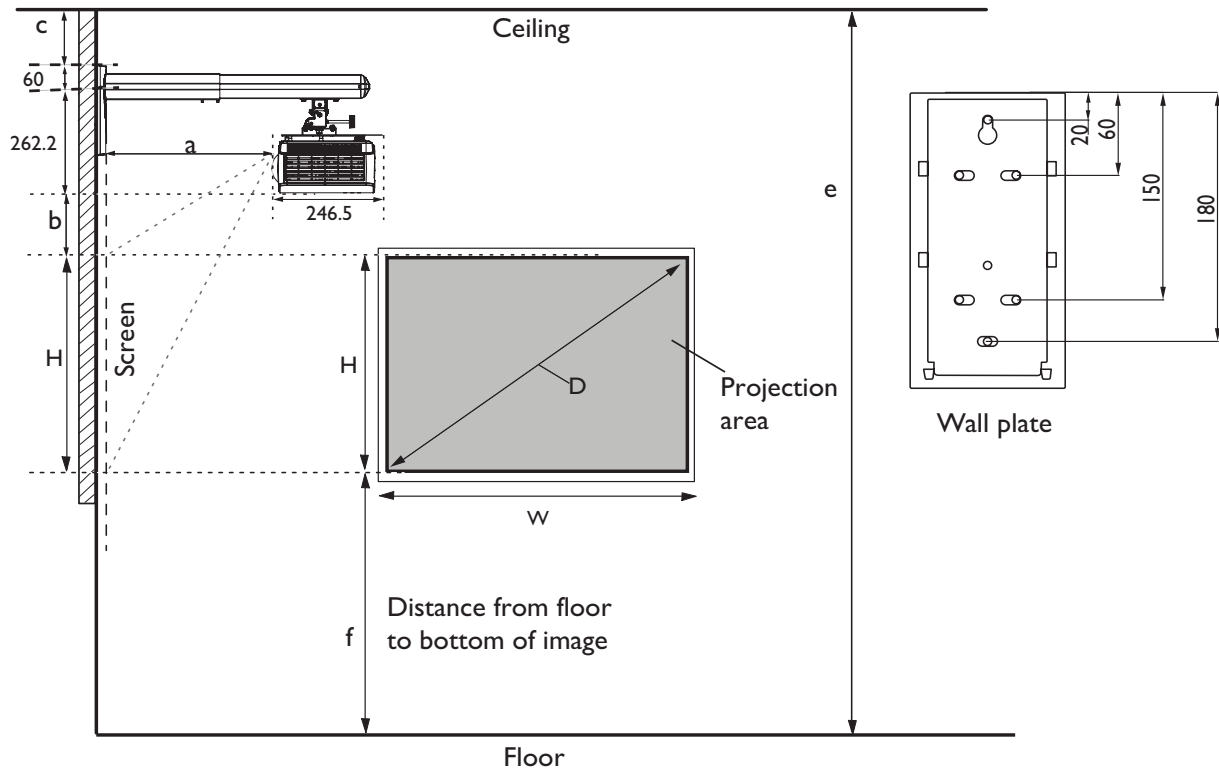

- ☞ The dimensions are based on the BenQ wall mount (P/N: 5J.J4R10.001).
- All measurements are approximate and may vary from the actual sizes. BenQ recommends that if you intend to permanently install the projector, you should physically test the projection size and distance using the actual projector in situ before you permanently install it, so as to make allowance for this projector's optical characteristics. This will help you determine the exact mounting position so that it best suits your installation location.
- The dimensions supplied are offered as a guide only and may differ depending on several factors relating to any specific installation.
- The dimensions are based on the projector being configured with zero keystone correction.
- The dimensions assume that the wall mount arm is positioned 90° from the bottom case of projector and screen surface.

# Timing chart

## Supported timing for PC input

Resolution	Horizontal Frequency (kHz)	Vertical Frequency (Hz)	Pixel Frequency (MHz)	Mode
720 x 400	31.469	70.087	28.322	720 x 400_70
640 x 480	31.469	59.940	25.175	VGA_60
	37.861	72.809	31.500	VGA_72
	37.500	75.000	31.500	VGA_75
	43.269	85.008	36.000	VGA_85
800 x 600	37.879	60.317	40.000	SVGA_60
	48.077	72.188	50.000	SVGA_72
	46.875	75.000	49.500	SVGA_75
	53.674	85.061	56.250	SVGA_85
	77.425	119.854	83.000	SVGA_120 (Reduce Blanking)
1024 x 768	48.363	60.004	65.000	XGA_60
	56.476	70.069	75.000	XGA_70
	60.023	75.029	78.750	XGA_75
	68.677	84.997	94.500	XGA_85
	97.551	119.989	115.500	XGA_120 (Reduce Blanking)
1152 x 864	67.500	75.00	108.000	1152 x 864_75
1024 x 576	35.820	60.0	46.996	Netbook_1
1024 x 600	41.467	64.995	51.419	Netbook_2
1280 x 720	45.000	60.000	74.250	1280 x 720_60
1280 x 768	47.776	59.870	79.500	1280 x 768_60
1280 x 800	49.702	59.810	83.500	WXGA_60
	62.795	74.934	106.500	WXGA_75
	71.554	84.880	122.500	WXGA_85
	101.563	119.909	146.25	WXGA_120 (Reduce Blanking)
1280 x 1024	63.981	60.020	108.000	SXGA_60
	79.976	75.025	135.000	SXGA_75
	91.146	85.024	157.500	SXGA_85
1280 x 960	60.000	60.000	108	1280 x 960_60
	85.938	85.002	148.500	1280 x 960_85
1360 x 768	47.712	60.015	85.500	1360 x 768_60
1440 x 900	55.935	59.887	106.500	WXGA+_60
1400 x 1050	65.317	59.978	121.750	SXGA+_60
1600 x 1200	75.000	60.000	162.000	UXGA
1680 x 1050	65.290	59.954	146.250	1680 x 1050_60
640 x 480@67Hz	35.000	66.667	30.240	MAC13
832 x 624@75Hz	49.722	74.546	57.280	MAC16
1024 x 768@75Hz	60.241	75.020	80.000	MAC19
1152 x 870@75Hz	68.680	75.060	100.000	MAC21
1920 x 1080(VESA)	67.158	59.963	173.000	1920 x 1080_60

 \*Supported timing for 3D function.

## Supported timing for HDMI input

Resolution	Horizontal Frequency (kHz)	Vertical Frequency (Hz)	Pixel Frequency (MHz)	Mode
640 x 480	31.469	59.940	25.175	VGA_60
	37.861	72.809	31.500	VGA_72
	37.500	75.000	31.500	VGA_75
	43.269	85.008	36.000	VGA_85
720 x 400	31.469	70.087	28.322	720 x 400_70
800 x 600	37.879	60.317	40.000	SVGA_60
	48.077	72.188	50.000	SVGA_72
	46.875	75.000	49.500	SVGA_75
	53.674	85.061	56.250	SVGA_85
	77.425	119.854	83.000	SVGA_120 (Reduce Blanking)
1024 x 768	48.363	60.004	65.000	XGA_60
	56.476	70.069	75.000	XGA_70
	60.023	75.029	78.750	XGA_75
	68.677	84.997	94.500	XGA_85
	97.551	119.989	115.500	XGA_120 (Reduce Blanking)
1152 x 864	67.500	75.00	108.000	1152 x 864_75
1024 x 576	35.820	60.0	46.996	Netbook_1
1024 x 600	41.467	64.995	51.419	Netbook_2
1280 x 720	45.000	60.000	74.250	1280 x 720_60
1280 x 768	47.776	59.870	79.500	1280 x 768_60
1280 x 800	49.702	59.810	83.500	WXGA_60
	62.795	74.934	106.500	WXGA_75
	71.554	84.880	122.500	WXGA_85
	101.563	119.909	146.25	WXGA_120 (Reduce Blanking)
1280 x 1024	63.981	60.020	108.000	SXGA_60
	79.976	75.025	135.000	SXGA_75
	91.146	85.024	157.500	SXGA_85
1280 x 960	60.000	60.000	108	1280 x 960_60
	85.938	85.002	148.500	1280 x 960_85
1440 x 900	55.935	59.887	106.500	WXGA+_60
1400 x 1050	65.317	59.978	121.750	SXGA+_60
1600 x 1200	75.000	60.000	162.000	UXGA
1680 x 1050	65.290	59.954	146.250	1680 x 1050_60
640 x 480@67Hz	35.000	66.667	30.240	MAC13
832 x 624@75Hz	49.722	74.546	57.280	MAC16
1024 x 768@75Hz	60.241	75.020	80.000	MAC19
1152 x 870@75Hz	68.680	75.060	100.000	MAC21

 Displaying a 1080i(1125i)@60Hz or 1080i(1125i)@50Hz signal may result in slight image vibration.

## Supported timing for Component-YPbPr input

Signal Format	Horizontal Frequency (kHz)	Vertical Frequency (Hz)
480i(525i)@60Hz	15.73	59.94
480p(525p)@60Hz	31.47	59.94
576i(625i)@50Hz	15.63	50.00
576p(625p)@50Hz	31.25	50.00
720p(750p)@60Hz	45.00	60.00
720p(750p)@50Hz	37.50	50.00
1080i(1125i)@60Hz	33.75	60.00
1080i(1125i)@50Hz	28.13	50.00
1080p@60Hz	67.5	60.00
1080p@50Hz	56.25	50.00

 Displaying a 1080i@60Hz or 1080i@50Hz signal may result in slight image vibration.

## Supported timing for Video and S-Video inputs

Video mode	Horizontal Frequency (kHz)	Vertical Frequency (Hz)	Color sub-carrier Frequency (MHz)
NTSC*	15.73	60	3.58
PAL	15.63	50	4.43
SECAM	15.63	50	4.25 or 4.41
PAL-M	15.73	60	3.58
PAL-N	15.63	50	3.58
PAL-60	15.73	60	4.43
NTSC4.43	15.73	60	4.43

 \*Supported timing for 3D function.

## Supported 3D signal for HDMI (HDCP) input

### Video timing

Resolution	Timing	Horizontal frequency (KHz)	Vertical frequency (Hz)	3D Field Sequential	3D frame packing	3D top bottom	3D side by side
720 (1440) x 480	480i	15.73	59.94	⊙			
720 x 480	480p	31.47	59.94				
720 (1440) x 576	576i	15.63	50				
720 x 576	576p	31.25	50				
1280 x 720	720/50p	37.5	50		⊙	⊙	
1280 x 720	720/60p	45	60		⊙	⊙	
1920 x 1080	1080/24P	27	24		⊙	⊙	
1920 x 1080	1080/25P	28.13	25				
1920 x 1080	1080/30P	33.75	30				
1920 x 1080	1080/50i	28.13	50				⊙
1920 x 1080	1080/60i	33.75	60				⊙
1920 x 1080	1080/50P	56.25	50				
1920 x 1080	1080/60P	67.5	60				

### PC timing

Resolution	Timing	Horizontal frequency (KHz)	Vertical frequency (Hz)	3D Field Sequential	3D top bottom	3D side by side
640 x 480	VGA_60	59.94	31.469	⊙	⊙	⊙
	VGA_72	72.809	37.861			
	VGA_75	75	37.5			
	VGA_85	85.008	43.269			
720 x 400	720x400_70	70.087	31.469			
800 x 600	SVGA_60	60.317	37.879	⊙	⊙	⊙
	SVGA_72	72.188	48.077			
	SGVA_75	75	46.875			
	SVGA_85	85.061	53.674			
	SVGA_120 (Reduce Blanking)	119.854	77.425	⊙		
1024 x 768	XGA_60	60.004	48.363	⊙	⊙	⊙
	XGA_70	70.069	56.476			
	XGA_75	75.029	60.023			
	XGA_85	84.997	68.667			
	XGA_120 (Reduce Blanking)	119.989	97.551	⊙		
1152 x 864	1152 x 864_75	75	67.5			
1024 x 576	BenQ Notebook Timing	60	35.82			
1024 x 600	BenQ Notebook Timing	64.995	41.467			
1280 x 720	1280 x 720_60	60	45	⊙	⊙	⊙
	1280 x 720_120	120	90	⊙		
1280 x 768	1280 x 768_60 (Reduce Blanking)	60	47.396	⊙	⊙	⊙
	1280 x 768_60	59.87	47.776	⊙	⊙	⊙



1280 x 800	WXGA_60	59.81	49.702	⊙	⊙	⊙
	WXGA_75	74.934	62.795			
	WXGA_85	84.88	71.554			
	WXGA_120 (Reduce Blanking)	119.909	101.563	⊙		
1280 x 1024	SXGA_60	60.02	63.981		⊙	⊙
	SXGA_75	75.025	79.976			
	SXGA_85	85.024	91.146			
1280 x 960	1280 x 960_60	60	60		⊙	⊙
	1280 x 960_85	85.002	85.938			
1360 x 768	1360 x 768_60	60.015	47.712		⊙	⊙
1440 x 900	WXGA+_60 (Reduce Blanking)	60	55.469		⊙	⊙
	WXGA+_60	59.887	55.935		⊙	⊙
1400 x 1050	SXGA+_60	59.978	65.317		⊙	⊙
1600 x 1200	UXGA	60	75		⊙	⊙
1680 x 1050	1680 x 1050_60 (Reduce Blanking)	59.883	64.674		⊙	⊙
	1680 x 1080_60	59.954	65.29		⊙	⊙
1920 x 1200	1920 x 1200_60 (Reduce Blanking)	59.95	74.038		⊙	⊙
640 x 480@67Hz	MAC13	66.667	35			
832 x 624@75Hz	MAC16	74.546	49.722			
1024 x 768@75Hz	MAC19	75.02	60.241			
1152 x 870@75Hz	MAC21	75.06	68.68			
1920 x 1080 (VESA)	1920 x 1080_60 (for Auditorium model)	59.963	67.158			

## Supported 3D signal for D-SUB input

### PC timing

Resolution	Timing	Horizontal frequency (KHz)	Vertical frequency (Hz)	3D Field Sequential	3D top bottom	3D side by side
640 x 480	VGA_60	59.94	31.469	⊙	⊙	⊙
	VGA_72	72.809	37.861			
	VGA_75	75	37.5			
	VGA_85	85.008	43.269			
720 x 400	720 x 400_70	70.087	31.469			
800 x 600	SVGA_60	60.317	37.879	⊙	⊙	⊙
	SVGA_72	72.188	48.077			
	SVGA_75	75	46.875			
	SVGA_85	85.061	53.674			
	SVGA_120 (Reduce Blanking)	119.854	77.425	⊙		
1024 x 768	XGA_60	60.004	48.363	⊙	⊙	⊙
	XGA_70	70.069	56.476			
	XGA_75	75.029	60.023			
	XGA_85	84.997	68.667			
	XGA_120 (Reduce Blanking)	119.989	97.551	⊙		
1152 x 864	1152 x 864_75	75	67.5			

1024 x 576	BenQ Notebook Timing	60	35.82			
1024 x 600	BenQ Notebook Timing	64.995	41.467			
1280 x 720	1280 x 720_60	60	45	⊙	⊙	⊙
	1280 x 720_120	120	90	⊙		
1280 x 768	1280 x 768_60 (Reduce Blanking)	60	47.396	⊙	⊙	⊙
	1280 x 768_60	59.87	47.776	⊙	⊙	⊙
1280 x 800	WXGA_60	59.81	49.702	⊙	⊙	⊙
	WXGA_75	74.934	62.795			
	WXGA_85	84.88	71.554			
	WXGA_120 (Reduce Blanking)	119.909	101.563	⊙		
1280 x 1024	SXGA_60	60.02	63.981		⊙	⊙
	SXGA_75	75.025	79.976			
	SXGA_85	85.024	91.146			
1280 x 960	1280 x 960_60	60	60		⊙	⊙
	1280 x 960_85	85.002	85.938			
1360 x 768	1360 x 768_60	60.015	47.712		⊙	⊙
1440 x 900	WXGA+_60 (Reduce Blanking)	60	55.469		⊙	⊙
	WXGA+_60	59.887	55.935		⊙	⊙
1400 x 1050	SXGA+_60	59.978	65.317		⊙	⊙
1600 x 1200	UXGA	60	75		⊙	⊙
1680 x 1050	1680 x 1050_60 (Reduce Blanking)	59.883	64.674		⊙	⊙
	1680 x 1050_60	59.954	65.29		⊙	⊙
1920 x 1200	1920 x 1200_60 (Reduce Blanking)	59.95	74.038		⊙	⊙
640 x 480@67Hz	MAC13	66.667	35			
832 x 624@75Hz	MAC16	74.546	49.722			
1024 x 768@75Hz	MAC19	75.02	60.241			
1152 x 870@75Hz	MAC21	75.06	68.68			
1920 x 1080(VESA)	1920 x 1080_60 (Auditorium model)	59.963	67.158			

## Supported 3D signal for Video and S-Video input

Video mode	Horizontal Frequency (kHz)	Vertical Frequency (Hz)	3D Field Sequential
NTSC	15.73	60	⊙
PAL	15.63	50	
SECAM	15.63	50	
PAL-M	15.73	60	
PAL-N	15.63	50	
PAL-60	15.73	60	
NTSC4.43	15.73	60	

# Warranty and Copyright information

## Patents

This BenQ projector is covered by the following patents:

U.S. patents 6,837,608; 7,275,834; 7,181,318; TW patents 202690; 205470; I228635; I259932; China Patents ( 中国发明专利 ) ZL01143168.7; ZL03119907.0; ZL200510051609.2

## Limited warranty

BenQ warrants this product against any defects in material and workmanship, under normal usage and storage.

Proof of purchase date will be required with any warranty claim. In the event this product is found to be defective within the warranty period, BenQ's only obligation and your exclusive remedy shall be replacement of any defective parts (labor included). To obtain warranty service, immediately notify the dealer from which you purchased the product of any defects.

Important: The above warranty shall be void if the customer fails to operate the product in accordance with BenQ's written instructions, especially the ambient humidity must be in-between 10% and 90%, temperature in-between 0°C and 35°C, altitude lower than 4920 feet, and avoiding to operate the projector in a dusty environment. This warranty gives you specific legal rights, and you may have other rights which vary from country to country.

For other information, please visit [www.BenQ.com](http://www.BenQ.com).

## Copyright

Copyright 2012 by BenQ Corporation. All rights reserved. No part of this publication may be reproduced, transmitted, transcribed, stored in a retrieval system or translated into any language or computer language, in any form or by any means, electronic, mechanical, magnetic, optical, chemical, manual or otherwise, without the prior written permission of BenQ Corporation.

## Disclaimer

BenQ Corporation makes no representations or warranties, either expressed or implied, with respect to the contents hereof and specifically disclaims any warranties, merchantability or fitness for any particular purpose. Further, BenQ Corporation reserves the right to revise this publication and to make changes from time to time in the contents hereof without obligation to notify any person of such revision or changes.

\*DLP, Digital Micromirror Device and DMD are trademarks of Texas Instruments. Others are copyrights of their respective companies or organizations.

## Free Manuals Download Website

<http://myh66.com>

<http://usermanuals.us>

<http://www.somanuals.com>

<http://www.4manuals.cc>

<http://www.manual-lib.com>

<http://www.404manual.com>

<http://www.luxmanual.com>

<http://aubethermostatmanual.com>

Golf course search by state

<http://golfingnear.com>

Email search by domain

<http://emailbydomain.com>

Auto manuals search

<http://auto.somanuals.com>

TV manuals search

<http://tv.somanuals.com>