

ASUS[®]

**VE247/VE248/VE249
Series**

LED Monitor

User Guide

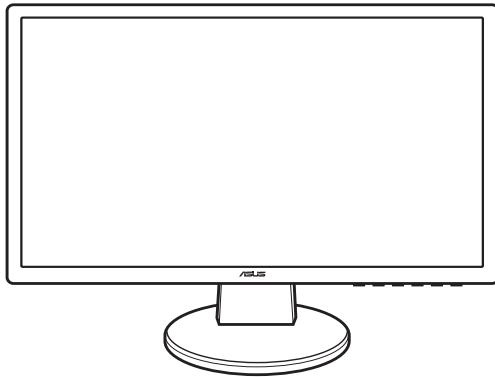

Contents

Notices	iii
Safety information	iv
Care & Cleaning	v
1.1 Welcome!	1-1
1.2 Package contents	1-1
1.3 Monitor introduction	1-2
1.3.1 Front view	1-2
1.3.2 Back view.....	1-3
2.1 Assembling the monitor base	2-1
2.2 Adjusting the monitor	2-1
2.3 Detaching the arm/base (for VESA wall mount)	2-2
2.4 Connecting the cables	2-3
2.5 Turning on the monitor	2-4
3.1 OSD (On-Screen Display) menu	3-1
3.1.1 How to reconfigure.....	3-1
3.1.2 OSD Function Introduction.....	3-1
3.2 Specifications summary (VE249H)	3-4
3.3 Troubleshooting (FAQ)	3-15
3.4 Supported operating modes	3-16

Notices

Federal Communications Commission Statement

This device complies with Part 15 of the FCC Rules. Operation is subject to the following two conditions:

- This device may not cause harmful interference, and
- This device must accept any interference received including interference that may cause undesired operation.

This equipment has been tested and found to comply with the limits for a Class B digital device, pursuant to Part 15 of the FCC Rules. These limits are designed to provide reasonable protection against harmful interference in a residential installation. This equipment generates, uses and can radiate radio frequency energy and, if not installed and used in accordance with manufacturer's instructions, may cause harmful interference to radio communications. However, there is no guarantee that interference will not occur in a particular installation. If this equipment does cause harmful interference to radio or television reception, which can be determined by turning the equipment off and on, the user is encouraged to try to correct the interference by one or more of the following measures:

- Reorient or relocate the receiving antenna.
- Increase the separation between the equipment and receiver.
- Connect the equipment to an outlet on a circuit different from that to which the receiver is connected.
- Consult the dealer or an experienced radio/TV technician for help.



The use of shielded cables for connection of the monitor to the graphics card is required to assure compliance with FCC regulations. Changes or modifications to this unit not expressly approved by the party responsible for compliance could void the user's authority to operate this equipment.



As an Energy Star® Partner, our company has determined that this product meets the Energy Star® guidelines for energy efficiency.

Canadian Department of Communications Statement

This digital apparatus does not exceed the Class B limits for radio noise emissions from digital apparatus set out in the Radio Interference Regulations of the Canadian Department of Communications.

This class B digital apparatus complies with Canadian ICES-003.

This Class B digital apparatus meets all requirements of the Canadian Interference - Causing Equipment Regulations.

Cet appareil numérique de la classe B respecte toutes les exigences du Règlement sur le matériel brouiller du Canada.

Safety information

- Before setting up the monitor, carefully read all the documentation that came with the package.
- To prevent fire or shock hazard, never expose the monitor to rain or moisture.
- Never try to open the monitor cabinet. The dangerous high voltages inside the monitor may result in serious physical injury.
- If the power supply is broken, do not try to fix it by yourself. Contact a qualified service technician or your retailer.
- Before using the product, make sure all cables are correctly connected and the power cables are not damaged. If you detect any damage, contact your dealer immediately.
- Slots and openings on the back or top of the cabinet are provided for ventilation. Do not block these slots. Never place this product near or over a radiator or heat source unless proper ventilation is provided.
- The monitor should be operated only from the type of power source indicated on the label. If you are not sure of the type of power supply to your home, consult your dealer or local power company.
- Use the appropriate power plug which complies with your local power standard.
- Do not overload power strips and extension cords. Overloading can result in fire or electric shock.
- Avoid dust, humidity, and temperature extremes. Do not place the monitor in any area where it may become wet. Place the monitor on a stable surface.
- Unplug the unit during a lightning storm or if it will not be used for a long period of time. This will protect the monitor from damage due to power surges.
- Never push objects or spill liquid of any kind into the slots on the monitor cabinet.
- To ensure satisfactory operation, use the monitor only with UL listed computers which have appropriate configured receptacles marked between 100-240V AC.
- If you encounter technical problems with the monitor, contact a qualified service technician or your retailer.



This symbol of the crossed out wheeled bin indicates that the product (electrical, electronic equipment, and mercury-containing button cell battery) should not be placed in municipal waste. Please check local regulations for disposal of electronic products.

Care & Cleaning

- Before you lift or reposition your monitor, it is better to disconnect the cables and power cord. Follow the correct lifting techniques when positioning the monitor. When lifting or carrying the monitor, grasp the edges of the monitor. Do not lift the display by the stand or the cord.
- Cleaning. Turn your monitor off and unplug the power cord. Clean the monitor surface with a lint-free, non-abrasive cloth. Stubborn stains may be removed with a cloth dampened with mild cleaner.
- Avoid using a cleaner containing alcohol or acetone. Use a cleaner intended for use with the monitor. Never spray cleaner directly on the screen, as it may drip inside the monitor and cause an electric shock.

The following symptoms are normal with the monitor:

- The screen may flicker during the initial use due to the nature of the fluorescent light. Turn off the Power Switch and turn it on again to make sure that the flicker disappears.
- You may find slightly uneven brightness on the screen depending on the desktop pattern you use.
- When the same image is displayed for hours, an afterimage of the previous screen may remain after switching the image. The screen will recover slowly or you can turn off the Power Switch for hours.
- When the screen becomes black or flashes, or cannot work anymore, contact your dealer or service center to fix it. Do not repair the screen by yourself!

Conventions used in this guide



WARNING: Information to prevent injury to yourself when trying to complete a task.



CAUTION: Information to prevent damage to the components when trying to complete a task.



IMPORTANT: Information that you **MUST** follow to complete a task.



NOTE: Tips and additional information to aid in completing a task.

Where to find more information

Refer to the following sources for additional information and for product and software updates.

1. ASUS websites

The ASUS websites worldwide provide updated information on ASUS hardware and software products. Refer to <http://www.asus.com>

2. Optional documentation

Your product package may include optional documentation that may have been added by your dealer. These documents are not part of the standard package.

1.1 Welcome!

Thank you for purchasing the ASUS® LED monitor!

The latest widescreen LED monitor from ASUS provides a crisper, broader, and brighter display, plus a host of features that enhance your viewing experience.

With these features, you can enjoy the convenience and delightful visual experience that the monitor brings you!

1.2 Package contents

Check your package for the following items:

- ✓ LED monitor
- ✓ Monitor base and screw
- ✓ Warranty card
- ✓ Quick start guide
- ✓ 1 x Power cord
- ✓ 1 x VGA cable
- ✓ 1 x DVI cable
- ✓ 1 x Audio cable



If any of the above items is damaged or missing, contact your retailer immediately.

1.3 Monitor introduction

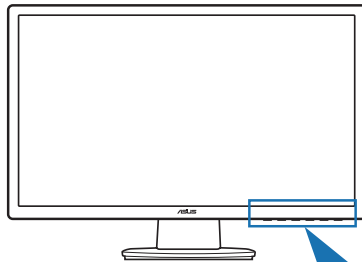

1.3.1 Front view



VE247H/ VE248H/ VE249H	S/A	Volume/Down	MENU Menu	Brightness/Up	Input Select	Power Key
VE247T/ VE247S/ VE248T/ VE248S	S	Volume/Down	MENU Menu	Brightness/Up	A	Power Key
VE247N/ VE247D/ VE248N/ VE248D	S	Contrast/Down	MENU Menu	Brightness/Up	A	Power Key

1 2 3 4 5 1 6

- Button:**
 - Use this hotkey to switch from five video preset modes (Standard Mode, Theater Mode, Game Mode, Night View Mode, Scenery Mode) with SPLENDID™ Video Enhancement Technology. ()
 - Exit the OSD menu or go back to the previous menu as the OSD menu is active. ()
 - Automatically adjust the image to its optimized position, clock, and phase by pressing this button for 2-4 seconds (for VGA mode only.) ()
- Button:**
 - Press this button to decrease the value of the function selected or move left/down to the previous function.
 - This is also a hotkey for Volume adjustment. ()
 - This is also a hotkey for Contrast adjustment. ()
- MENU Button:**
 - Turns on the OSD menu.

- Press this button to enter/select the icon (function) highlighted while the OSD is activated.
4.  Button:
 - Press this button to increase the value of the function selected or move right/up to the next function.
 - This is also a hotkey for Brightness adjustment.
 5.  Button:
 - Press this button to cycle through the available input sources.



Press  (Input Select button) to display HDMI signals after you connect HDMI cable with the monitor.

6.  Power button/power indicator
 - Press this button to turn the monitor on/off
 - The color definition of the power indicator is as the below table.

Status	Description
Blue	ON
Amber	Standby mode
OFF	OFF

1.3.2 Back view

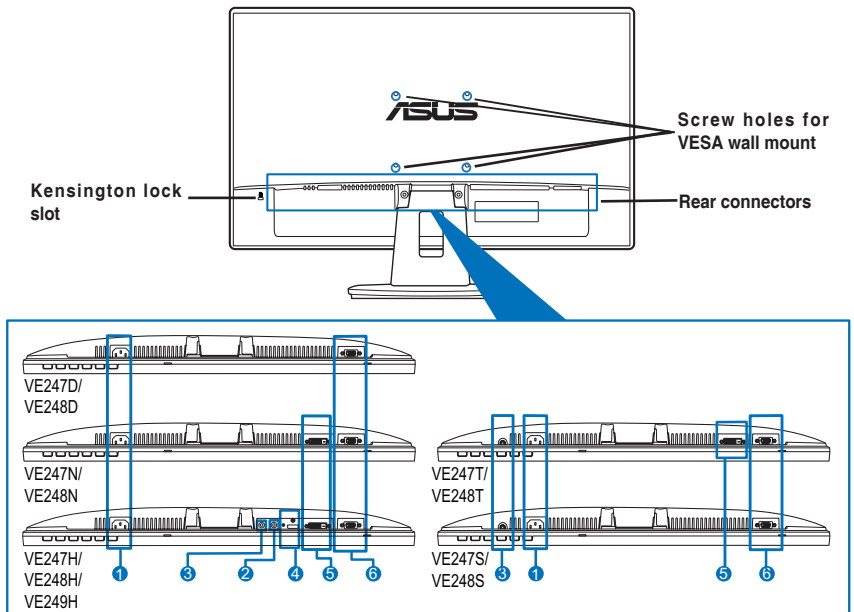

Rear connectors (Please refer to 3.2 Specifications summary for models)

1. **AC-IN port.** This port connects the power connector from the bundled power cord.
2. **Earphone jack**
3. **Audio-in port.** This port connects PC audio source by the bundled audio cable.
4. **HDMI port.** This port is for connection with an HDMI device.
5. **DVI port.** This 24-pin port is for PC (Personal Computer) DVI-D digital signal connection.
6. **VGA port.** This 15-pin port is for PC VGA connection.



The VESA wall mount kit (100 mm x 100 mm) is purchased separately.

2.1 Assembling the monitor base

To assemble the monitor base:

1. Have the front of the monitor face down on a table.
2. Assemble the base and the arm by aligning the arrow marks on the base and the arm.
3. Fix the base to the arm by fastening the bundled screw.



We recommend that you cover the table surface with soft cloth to prevent damage to the monitor.

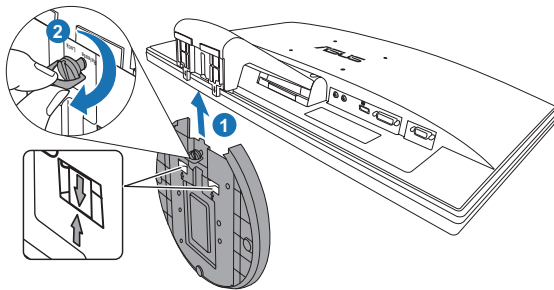

2.2 Adjusting the monitor

- For optimal viewing, we recommend that you look at the full face of the monitor, then adjust the monitor to the angle that is most comfortable for you.
- Hold the stand to prevent the monitor from falling when you change its angle.
- The recommended adjusting angle from -5° to 20° .

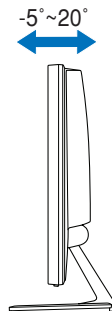

It is normal that the monitor slightly shakes while you adjust the the viewing angle.

2.3 Detaching the arm/base (for VESA wall mount)

The detachable arm/base of this LED monitor is specially designed for VESA wall mount.

To detach the arm/base:

1. Have the front of the monitor face down on a table.
2. Remove the rubbers in the four screw holes (Figure 1).
3. Use a screwdriver to remove the two screws on the arm (Figure 2), then slide out the arm/base to detach it from the monitor (Figure 2).

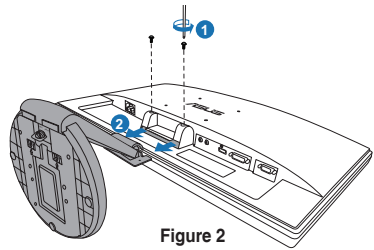
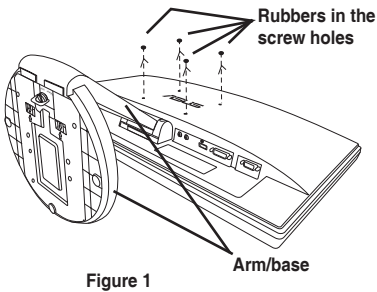

We recommend that you cover the table surface with soft cloth to prevent damage to the monitor.

2.4 Connecting the cables

1. Connect the cables as the following instructions:

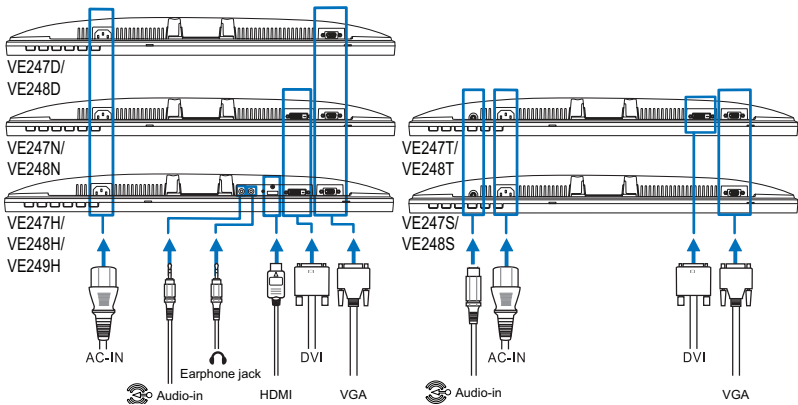

- **To connect the audio cable:** connect one end of the audio cable to the monitor's Audio-in port, the other end to the computer's audio-out port.
- **To connect the power cord:** connect one end of the power cord securely to the monitor's AC input port, the other end to a power outlet.
- **To connect the VGA/DVI/HDMI cable:**
 - a. Plug the VGA/DVI/HDMI connector to the LED monitor's VGA/DVI/HDMI port.
 - b. Connect the other end of the VGA/DVI/HDMI cable to your computer's VGA/DVI/HDMI.
 - c. Tighten the two screws to secure the VGA/DVI connector.
- **To use earphones:** connect the end with plug type to the monitor's earphone jack.



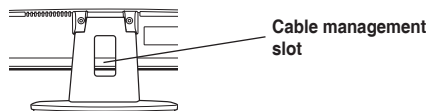

When these cables are connected, you can choose the desired signal from the Input Select item of the OSD functions.

2. Gather all the cables with the cable management slot.



2.5 Turning on the monitor

Gently press the power button . See page 1-3 for the location of the power button. The power indicator  lights up in blue to show that the monitor is ON.

3.1 OSD (On-Screen Display) menu

3.1.1 How to reconfigure

1. Press the MENU button to activate the OSD menu.



2. Press \leftarrow / \blacktriangledown (or \bullet / \blacktriangledown), and \star / \blacktriangle to navigate through the functions. Highlight and activate the desired function by pressing the MENU button. If the function selected has a sub-menu, press \leftarrow / \blacktriangledown (or \bullet / \blacktriangledown), and \star / \blacktriangle again to navigate through the sub-menu functions. Highlight and activate the desired sub-menu function by pressing the MENU button.
3. Press \leftarrow / \blacktriangledown (or \bullet / \blacktriangledown), and \star / \blacktriangle to change the settings of the selected function.
4. To exit the OSD menu, press the \mathbf{S} / \mathbf{A} or \mathbf{S} button. Repeat step 2 and step 3 to adjust any other function.

3.1.2 OSD Function Introduction

1. Splendid

This function contains five sub-functions you can select for your preference. Each mode has the Reset selection, allowing you to maintain your setting or return to the preset mode.



- **Scenery Mode:** best choice for scenery photo display with SPLENDID™ Video Enhancement.
- **Standard Mode:** best choice for document editing with SPLENDID™ Video Enhancement.
- **Theater Mode:** best choice for movie with SPLENDID™ Video Enhancement.
- **Game Mode:** best choice for game playing with SPLENDID™ Video Enhancement.
- **Night View Mode:** best choice for dark-scene game or movie with SPLENDID™ Video Enhancement.



- In the Standard Mode, the Saturation and Sharpness functions are not user-configurable.
- In the other modes, the sRGB function is not user-configurable.

2. Image

You can adjust brightness, contrast, sharpness, saturation, position (VGA only), and focus (VGA only) from this menu.



- **Brightness:** the adjusting range is from 0 to 100. ✧ / ▲ is a hotkey to activate this function.
- **Contrast:** the adjusting range is from 0 to 100.
- **ASCR:** turns on/off the ASCR (ASUS Smart Contrast Ratio) function.
- **Sharpness:** the adjusting range is from 0 to 100.
- **Saturation:** the adjusting range is from 0 to 100.
- **Position:** adjusts the horizontal position (H-Position) and the vertical position (V-Position) of the image. The adjusting range is from 0 to 100.
- **Focus:** reduces Horizontal-line noise and Vertical-line noise of the image by adjusting (Phase) and (Clock) separately. The adjusting range is from 0 to 100.



- Phase adjusts the phase of the pixel clock signal. With a wrong phase adjustment, the screen shows horizontal disturbances.
- Clock (pixel frequency) controls the number of pixels scanned by one horizontal sweep. If the frequency is not correct, the screen shows vertical stripes and the image is not proportional.

3. Color

Select the image color you like from this function.

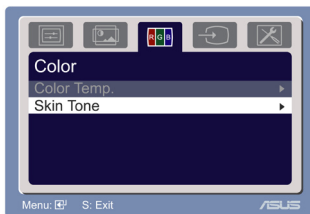

- **Color Temp.:** contains five color modes including Cool, Normal, Warm, sRGB, and User mode.
- **Skin Tone:** contains three color modes including Reddish, Natural, and Yellowish.



In the User mode, colors of R (Red), G (Green), and B (Blue) are user-configurable; the adjusting range is from 0-100.

4. Input Select

In this function, you can select your desired input source.

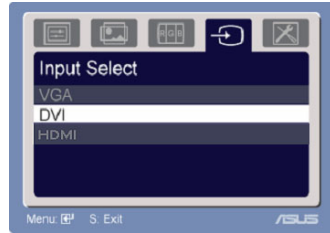

5. System Setup

Allow you to adjust the system.

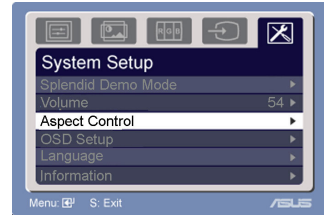

- **Splendid Demo Mode:** turns on/off ASUS Splendid Demo function.
- **Volume:** the adjusting range is from 0 to 100. ◀▶/▼ is a hotkey to activate this function.
- **Aspect Control:** adjusts the aspect ratio to full or 4:3.
- **OSD Setup:**
 - * Adjusts the horizontal position (H-Position)/the vertical position (V-Position) of the OSD from 0 to 100.
 - * Adjusts the OSD timeout from 10 to 120.
 - * Enables or disables the DDC/CI function.
- **Language:** there are 11 languages for your selection, including English, German, Italian, French, Dutch, Spanish, Russian, Traditional Chinese, Simplified Chinese, Japanese, and Korean.
- **Information:** shows the monitor information.
- **All Reset:** "Yes" allows you to restore the default setting.

3.2 Specifications summary (VE249H)

Panel Type	TFT LCD
Panel size	24" (61 cm, 16:9) wide screen
Max. Resolution	1920 x 1080
Pixel pitch	0.27675 mm
Brightness (Typ.)	250 cd/m ²
Contrast Ratio (Typ.)	1000:1
Contrast Ratio (Max.)	10,000,000:1 (with ASCR on)
Viewing angle(H/V) CR>10	170°/160°
Display colors	16.7 M
Response time	5 ms
SPLENDID™ Video Enhancement	Yes
SPLENDID™ selection	5 video preset modes (by hotkey)
Auto adjustment	Yes (by hotkey)
Color temperature selection	5 color temperatures
Skin-Tone selection	3 skin-tones
Digital input	DVI-D with HDCP; HDMI v1.3
Analog input	D-Sub
Audio-in port	3.5 mm Mini-jack
Earphone jack	Yes
Colors	Black
Speaker (Built-in)	1 W x 2 Stereo, RMS
Power LED	Blue (On)/ Amber (Standby)
VESA wall mount	100 x 100 mm
Tilt	-5°~+20°
Kensington lock	Yes
Voltage rating	AC: 100~240V
Power consumption	Power On : < 35 W, Standby: < 1 W, Power Off: <1 W
Temperature (Operating)	0°C~40°C
Temperature (Non-operating)	-20°C~+60°C
Dimension (W x H x D)	569.4 mm x 408.2 mm x 201 mm (machine) 640 mm x 484 mm x 157 mm (package)
Weight (Esti.)	4.4 kg (Net) ; 7.1 kg (Gross)
Multi-languages	11 languages (English, German, Italian, French, Dutch, Spanish, Russian, Traditional Chinese, Simplified Chinese, Japanese, Korean)
Accessories	VGA cable, DVI cable, audio cable, power cord, quick start guide, warranty card
Regulation approvals	Energy Star®, CB, CE, Gost-R, CCC, UL/cUL, FCC, C-Tick, BSMI, VCCI, RoHS, WEEE, PSB, J-MOSS, EuP, Windows Vista, Windows 7 WHQL

*Specifications are subject to change without notice.

Specifications summary (VE248H)

Panel Type	TFT LCD
Panel size	24" (61 cm, 16:9) wide screen
Max. Resolution	1920 x 1080
Pixel pitch	0.27675 mm
Brightness (Typ.)	250 cd/m ²
Contrast Ratio (Typ.)	1000:1
Contrast Ratio (Max.)	10,000,000:1 (with ASCR on)
Viewing angle(H/V) CR>10	170°/160°
Display colors	16.7 M
Response time	2 ms
SPLENDID™ Video Enhancement	Yes
SPLENDID™ selection	5 video preset modes (by hotkey)
Auto adjustment	Yes (by hotkey)
Color temperature selection	5 color temperatures
Skin-Tone selection	3 skin-tones
Digital input	DVI-D with HDCP; HDMI v1.3
Analog input	D-Sub
Audio-in port	3.5 mm Mini-jack
Earphone jack	Yes
Colors	Black
Speaker (Built-in)	1 W x 2 Stereo, RMS
Power LED	Blue (On)/ Amber (Standby)
VESA wall mount	100 x 100 mm
Tilt	-5°~+20°
Kensington lock	Yes
Voltage rating	AC: 100~240V
Power consumption	Power On : < 35 W, Standby: < 1 W, Power Off: <1 W
Temperature (Operating)	0°C~40°C
Temperature (Non-operating)	-20°C~+60°C
Dimension (W x H x D)	569.4 mm x 408.2 mm x 201 mm (machine) 640 mm x 484 mm x 157 mm (package)
Weight (Esti.)	4.4 kg (Net) ; 7.1 kg (Gross)
Multi-languages	11 languages (English, German, Italian, French, Dutch, Spanish, Russian, Traditional Chinese, Simplified Chinese, Japanese, Korean)
Accessories	VGA cable, DVI cable, audio cable, power cord, quick start guide, warranty card
Regulation approvals	Energy Star®, CB, CE, Gost-R, CCC, UL/cUL, FCC, C-Tick, BSMI, VCCI, RoHS, WEEE, PSB, J-MOSS, EuP, Windows Vista, Windows 7 WHQL

*Specifications are subject to change without notice.

Specifications summary (VE248T)

Panel Type	TFT LCD
Panel size	24" (61 cm, 16:9) wide screen
Max. Resolution	1920 x 1080
Pixel pitch	0.27675 mm
Brightness (Typ.)	250 cd/m ²
Contrast Ratio (Typ.)	1000:1
Contrast Ratio (Max.)	10,000,000:1 (with ASCR on)
Viewing angle(H/V) CR>10	170°/160°
Display colors	16.7 M
Response time	2 ms
SPLENDID™ Video Enhancement	Yes
SPLENDID™ selection	5 video preset modes (by hotkey)
Auto adjustment	Yes (by hotkey)
Color temperature selection	5 color temperatures
Skin-Tone selection	3 skin-tones
Digital input	DVI-D with HDCP
Analog input	D-Sub
Audio-in port	3.5 mm Mini-jack
Earphone jack	No
Colors	Black
Speaker (Built-in)	1 W x 2 Stereo, RMS
Power LED	Blue (On)/ Amber (Standby)
VESA wall mount	100 x 100 mm
Tilt	-5°~+20°
Kensington lock	Yes
Voltage rating	AC: 100~240V
Power consumption	Power On : < 35 W, Standby: < 1 W, Power Off: <1 W
Temperature (Operating)	0°C~40°C
Temperature (Non-operating)	-20°C~+60°C
Dimension (W x H x D)	569.4 mm x 408.2 mm x 201 mm (machine) 640 mm x 484 mm x 157 mm (package)
Weight (Esti.)	4.4 kg (Net) ; 7.1 kg (Gross)
Multi-languages	11 languages (English, German, Italian, French, Dutch, Spanish, Russian, Traditional Chinese, Simplified Chinese, Japanese, Korean)
Accessories	VGA cable, DVI cable, audio cable, power cord, quick start guide, warranty card
Regulation approvals	Energy Star®, CB, CE, Gost-R, CCC, UL/cUL, FCC, C-Tick, BSMI, VCCI, RoHS, WEEE, PSB, J-MOSS, EuP, Windows Vista, Windows 7 WHQL

*Specifications are subject to change without notice.

Specifications summary (VE248N)

Panel Type	TFT LCD
Panel size	24" (61 cm, 16:9) wide screen
Max. Resolution	1920 x 1080
Pixel pitch	0.27675 mm
Brightness (Typ.)	250 cd/m ²
Contrast Ratio (Typ.)	1000:1
Contrast Ratio (Max.)	10,000,000:1 (with ASCR on)
Viewing angle(H/V) CR>10	170°/160°
Display colors	16.7 M
Response time	2 ms
SPLENDID™ Video Enhancement	Yes
SPLENDID™ selection	5 video preset modes (by hotkey)
Auto adjustment	Yes (by hotkey)
Color temperature selection	5 color temperatures
Skin-Tone selection	3 skin-tones
Digital input	DVI-D with HDCP
Analog input	D-Sub
Earphone jack	No
Colors	Black
Power LED	Blue (On)/ Amber (Standby)
VESA wall mount	100 x 100 mm
Tilt	-5°~+20°
Kensington lock	Yes
Voltage rating	AC: 100~240V
Power consumption	Power On : < 35 W, Standby: < 1 W, Power Off: <1 W
Temperature (Operating)	0°C~40°C
Temperature (Non-operating)	-20°C~+60°C
Dimension (W x H x D)	569.4 mm x 408.2 mm x 201 mm (machine) 640 mm x 484 mm x 157 mm (package)
Weight (Esti.)	4.4 kg (Net) ; 7.1 kg (Gross)
Multi-languages	11 languages (English, German, Italian, French, Dutch, Spanish, Russian, Traditional Chinese, Simplified Chinese, Japanese, Korean)
Accessories	VGA cable, DVI cable, power cord, quick start guide, warranty card
Regulation approvals	Energy Star®, CB, CE, Gost-R, CCC, UL/cUL, FCC, C-Tick, BSMI, VCCI, RoHS, WEEE, PSB, J-MOSS, EuP, Windows Vista, Windows 7 WHQL

*Specifications are subject to change without notice.

Specifications summary (VE248S)

Panel Type	TFT LCD
Panel size	24" (61 cm, 16:9) wide screen
Max. Resolution	1920 x 1080
Pixel pitch	0.27675 mm
Brightness (Typ.)	250 cd/m ²
Contrast Ratio (Typ.)	1000:1
Contrast Ratio (Max.)	10,000,000:1 (with ASCR on)
Viewing angle(H/V) CR>10	170°/160°
Display colors	16.7 M
Response time	2 ms
SPLENDID™ Video Enhancement	Yes
SPLENDID™ selection	5 video preset modes (by hotkey)
Auto adjustment	Yes (by hotkey)
Color temperature selection	5 color temperatures
Skin-Tone selection	3 skin-tones
Analog input	D-Sub
Audio-in port	3.5 mm Mini-jack
Earphone jack	No
Colors	Black
Speaker (Built-in)	1 W x 2 Stereo, RMS
Power LED	Blue (On)/ Amber (Standby)
VESA wall mount	100 x 100 mm
Tilt	-5°~+20°
Kensington lock	Yes
Voltage rating	AC: 100~240V
Power consumption	Power On : < 35 W, Standby: < 1 W, Power Off: <1 W
Temperature (Operating)	0°C~40°C
Temperature (Non-operating)	-20°C~+60°C
Dimension (W x H x D)	569.4 mm x 408.2 mm x 201 mm (machine) 640 mm x 484 mm x 157 mm (package)
Weight (Esti.)	4.4 kg (Net) ; 7.1 kg (Gross)
Multi-languages	11 languages (English, German, Italian, French, Dutch, Spanish, Russian, Traditional Chinese, Simplified Chinese, Japanese, Korean)
Accessories	VGA cable, audio cable, power cord, quick start guide, warranty card
Regulation approvals	Energy Star®, CB, CE, Gost-R, CCC, UL/cUL, FCC, C-Tick, BSMI, VCCI, RoHS, WEEE, PSB, J-MOSS, EuP, Windows Vista, Windows 7 WHQL

*Specifications are subject to change without notice.

Specifications summary (VE248D)

Panel Type	TFT LCD
Panel size	24" (61 cm, 16:9) wide screen
Max. Resolution	1920 x 1080
Pixel pitch	0.27675 mm
Brightness (Typ.)	250 cd/m ²
Contrast Ratio (Typ.)	1000:1
Contrast Ratio (Max.)	10,000,000:1 (with ASCR on)
Viewing angle(H/V) CR>10	170°/160°
Display colors	16.7 M
Response time	2 ms
SPLENDID™ Video Enhancement	Yes
SPLENDID™ selection	5 video preset modes (by hotkey)
Auto adjustment	Yes (by hotkey)
Color temperature selection	5 color temperatures
Skin-Tone selection	3 skin-tones
Analog input	D-Sub
Earphone jack	No
Colors	Black
Power LED	Blue (On)/ Amber (Standby)
VESA wall mount	100 x 100 mm
Tilt	-5°~+20°
Kensington lock	Yes
Voltage rating	AC: 100~240V
Power consumption	Power On : < 35 W, Standby: < 1 W, Power Off: <1 W
Temperature (Operating)	0°C~40°C
Temperature (Non-operating)	-20°C~+60°C
Dimension (W x H x D)	569.4 mm x 408.2 mm x 201 mm (machine) 640 mm x 484 mm x 157 mm (package)
Weight (Esti.)	4.4 kg (Net) ; 7.1 kg (Gross)
Multi-languages	11 languages (English, German, Italian, French, Dutch, Spanish, Russian, Traditional Chinese, Simplified Chinese, Japanese, Korean)
Accessories	VGA cable, power cord, quick start guide, warranty card
Regulation approvals	Energy Star®, CB, CE, Gost-R, CCC, UL/cUL, FCC, C-Tick, BSMI, VCCI, RoHS, WEEE, PSB, J-MOSS, EuP, Windows Vista, Windows 7 WHQL

*Specifications are subject to change without notice.

Specifications summary (VE247H)

Panel Type	TFT LCD
Panel size	23.6" (59.9 cm, 16:9) wide screen
Max. Resolution	1920 x 1080
Pixel pitch	0.2715 mm
Brightness (Typ.)	300 cd/m ²
Contrast Ratio (Typ.)	1000:1
Contrast Ratio (Max.)	10,000,000:1 (with ASCR on)
Viewing angle(H/V) CR>10	170°/160°
Display colors	16.7 M
Response time	2 ms
SPLENDID™ Video Enhancement	Yes
SPLENDID™ selection	5 video preset modes (by hotkey)
Auto adjustment	Yes (by hotkey)
Color temperature selection	5 color temperatures
Skin-Tone selection	3 skin-tones
Digital input	DVI-D with HDCP; HDMI v1.3
Analog input	D-Sub
Audio-in port	3.5 mm Mini-jack
Earphone jack	Yes
Colors	Black
Speaker (Built-in)	1 W x 2 Stereo, RMS
Power LED	Blue (On)/ Amber (Standby)
VESA wall mount	100 x 100 mm
Tilt	-5°~+20°
Kensington lock	Yes
Voltage rating	AC: 100~240V
Power consumption	Power On : < 35 W, Standby: < 1 W, Power Off: < 1 W
Temperature (Operating)	0°C~40°C
Temperature (Non-operating)	-20°C~+60°C
Dimension (W x H x D)	569.4 mm x 408.2 mm x 201 mm (machine) 640 mm x 484 mm x 157 mm (package)
Weight (Esti.)	4.4 kg (Net) ; 7.1 kg (Gross)
Multi-languages	11 languages (English, German, Italian, French, Dutch, Spanish, Russian, Traditional Chinese, Simplified Chinese, Japanese, Korean)
Accessories	VGA cable, DVI cable, audio cable, power cord, quick start guide, warranty card
Regulation approvals	Energy Star®, CB, CE, Gost-R, CCC, UL/cUL, FCC, C-Tick, BSMI, VCCI, RoHS, WEEE, PSB, J-MOSS, EuP, Windows Vista, Windows 7 WHQL

*Specifications are subject to change without notice.

Specifications summary (VE247T)

Panel Type	TFT LCD
Panel size	23.6" (59.9 cm, 16:9) wide screen
Max. Resolution	1920 x 1080
Pixel pitch	0.2715 mm
Brightness (Typ.)	300 cd/m ²
Contrast Ratio (Typ.)	1000:1
Contrast Ratio (Max.)	10,000,000:1 (with ASCR on)
Viewing angle(H/V) CR>10	170°/160°
Display colors	16.7 M
Response time	2 ms
SPLENDID™ Video Enhancement	Yes
SPLENDID™ selection	5 video preset modes (by hotkey)
Auto adjustment	Yes (by hotkey)
Color temperature selection	5 color temperatures
Skin-Tone selection	3 skin-tones
Digital input	DVI-D with HDCP
Analog input	D-Sub
Audio-in port	3.5 mm Mini-jack
Earphone jack	No
Colors	Black
Speaker (Built-in)	1 W x 2 Stereo, RMS
Power LED	Blue (On)/ Amber (Standby)
VESA wall mount	100 x 100 mm
Tilt	-5°~+20°
Kensington lock	Yes
Voltage rating	AC: 100~240V
Power consumption	Power On : < 35 W, Standby: < 1 W, Power Off: <1 W
Temperature (Operating)	0°C~40°C
Temperature (Non-operating)	-20°C~+60°C
Dimension (W x H x D)	569.4 mm x 408.2 mm x 201 mm (machine) 640 mm x 484 mm x 157 mm (package)
Weight (Esti.)	4.4 kg (Net) ; 7.1 kg (Gross)
Multi-languages	11 languages (English, German, Italian, French, Dutch, Spanish, Russian, Traditional Chinese, Simplified Chinese, Japanese, Korean)
Accessories	VGA cable, DVI cable, audio cable, power cord, quick start guide, warranty card
Regulation approvals	Energy Star®, CB, CE, Gost-R, CCC, UL/cUL, FCC, C-Tick, BSMI, VCCI, RoHS, WEEE, PSB, J-MOSS, EuP, Windows Vista, Windows 7 WHQL

*Specifications are subject to change without notice.

Specifications summary (VE247N)

Panel Type	TFT LCD
Panel size	23.6" (59.9 cm, 16:9) wide screen
Max. Resolution	1920 x 1080
Pixel pitch	0.2715 mm
Brightness (Typ.)	300 cd/m ²
Contrast Ratio (Typ.)	1000:1
Contrast Ratio (Max.)	10,000,000:1 (with ASCR on)
Viewing angle(H/V) CR>10	170°/160°
Display colors	16.7 M
Response time	2 ms
SPLendid™ Video Enhancement	Yes
SPLendid™ selection	5 video preset modes (by hotkey)
Auto adjustment	Yes (by hotkey)
Color temperature selection	5 color temperatures
Skin-Tone selection	3 skin-tones
Digital input	DVI-D with HDCP
Analog input	D-Sub
Earphone jack	No
Colors	Black
Power LED	Blue (On)/ Amber (Standby)
VESA wall mount	100 x 100 mm
Tilt	-5°~+20°
Kensington lock	Yes
Voltage rating	AC: 100~240V
Power consumption	Power On : < 35 W, Standby: < 1 W, Power Off: <1 W
Temperature (Operating)	0°C~40°C
Temperature (Non-operating)	-20°C~+60°C
Dimension (W x H x D)	569.4 mm x 408.2 mm x 201 mm (machine) 640 mm x 484 mm x 157 mm (package)
Weight (Esti.)	4.4 kg (Net) ; 7.1 kg (Gross)
Multi-languages	11 languages (English, German, Italian, French, Dutch, Spanish, Russian, Traditional Chinese, Simplified Chinese, Japanese, Korean)
Accessories	VGA cable, DVI cable, power cord, quick start guide, warranty card
Regulation approvals	Energy Star®, CB, CE, Gost-R, CCC, UL/cUL, FCC, C-Tick, BSMI, VCCI, RoHS, WEEE, PSB, J-MOSS, EuP, Windows Vista, Windows 7 WHQL

*Specifications are subject to change without notice.

Specifications summary (VE247S)

Panel Type	TFT LCD
Panel size	23.6" (59.9 cm, 16:9) wide screen
Max. Resolution	1920 x 1080
Pixel pitch	0.2715 mm
Brightness (Typ.)	300 cd/m ²
Contrast Ratio (Typ.)	1000:1
Contrast Ratio (Max.)	10,000,000:1 (with ASCR on)
Viewing angle(H/V) CR>10	170°/160°
Display colors	16.7 M
Response time	2 ms
SPLENDID™ Video Enhancement	Yes
SPLENDID™ selection	5 video preset modes (by hotkey)
Auto adjustment	Yes (by hotkey)
Color temperature selection	5 color temperatures
Skin-Tone selection	3 skin-tones
Analog input	D-Sub
Audio-in port	3.5 mm Mini-jack
Earphone jack	No
Colors	Black
Speaker (Built-in)	1 W x 2 Stereo, RMS
Power LED	Blue (On)/ Amber (Standby)
VESA wall mount	100 x 100 mm
Tilt	-5°~+20°
Kensington lock	Yes
Voltage rating	AC: 100~240V
Power consumption	Power On : < 35 W, Standby: < 1 W, Power Off: <1 W
Temperature (Operating)	0°C~40°C
Temperature (Non-operating)	-20°C~+60°C
Dimension (W x H x D)	569.4 mm x 408.2 mm x 201 mm (machine) 640 mm x 484 mm x 157 mm (package)
Weight (Esti.)	4.4 kg (Net) ; 7.1 kg (Gross)
Multi-languages	11 languages (English, German, Italian, French, Dutch, Spanish, Russian, Traditional Chinese, Simplified Chinese, Japanese, Korean)
Accessories	VGA cable, audio cable, power cord, quick start guide, warranty card
Regulation approvals	Energy Star®, CB, CE, Gost-R, CCC, UL/cUL, FCC, C-Tick, BSMI, VCCI, RoHS, WEEE, PSB, J-MOSS, EuP, Windows Vista, Windows 7 WHQL







*Specifications are subject to change without notice.

Specifications summary (VE247D)

Panel Type	TFT LCD
Panel size	23.6" (59.9 cm, 16:9) wide screen
Max. Resolution	1920 x 1080
Pixel pitch	0.2715 mm
Brightness (Typ.)	300 cd/m ²
Contrast Ratio (Typ.)	1000:1
Contrast Ratio (Max.)	10,000,000:1 (with ASCR on)
Viewing angle(H/V) CR>10	170°/160°
Display colors	16.7 M
Response time	2 ms
SPLENDID™ Video Enhancement	Yes
SPLENDID™ selection	5 video preset modes (by hotkey)
Auto adjustment	Yes (by hotkey)
Color temperature selection	5 color temperatures
Skin-Tone selection	3 skin-tones
Analog input	D-Sub
Earphone jack	No
Colors	Black
Power LED	Blue (On)/ Amber (Standby)
VESA wall mount	100 x 100 mm
Tilt	-5°~+20°
Kensington lock	Yes
Voltage rating	AC: 100~240V
Power consumption	Power On : < 35 W, Standby: < 1 W, Power Off: <1 W
Temperature (Operating)	0°C~40°C
Temperature (Non-operating)	-20°C~+60°C
Dimension (W x H x D)	569.4 mm x 408.2 mm x 201 mm (machine) 640 mm x 484 mm x 157 mm (package)
Weight (Esti.)	4.4 kg (Net) ; 7.1 kg (Gross)
Multi-languages	11 languages (English, German, Italian, French, Dutch, Spanish, Russian, Traditional Chinese, Simplified Chinese, Japanese, Korean)
Accessories	VGA cable, power cord, quick start guide, warranty card
Regulation approvals	Energy Star®, CB, CE, Gost-R, CCC, UL/cUL, FCC, C-Tick, BSMI, VCCI, RoHS, WEEE, PSB, J-MOSS, EuP, Windows Vista, Windows 7 WHQL

*Specifications are subject to change without notice.

3.3 Troubleshooting (FAQ)

Problem	Possible Solution
Power LED is not ON	<ul style="list-style-type: none"> • Press the  button to check if the monitor is in the ON mode. • Check if the power cord is properly connected to the monitor and the power outlet.
The power LED lights amber and there is no screen image	<ul style="list-style-type: none"> • Check if the monitor and the computer are in the ON mode. • Make sure the signal cable is properly connected the monitor and the computer. • Inspect the signal cable and make sure none of the pins are bent. • Connect the computer with another available monitor to check if the computer is properly working.
Screen image is too light or dark	<ul style="list-style-type: none"> • Adjust the Contrast and Brightness settings via OSD.
Screen image is not centered or sized properly	<ul style="list-style-type: none"> • Press the  /  or  button for two seconds to automatically adjust the image. (for VGA mode only) • Adjust the H-Position or V-Position settings via OSD.
Screen image bounces or a wave pattern is present in the image	<ul style="list-style-type: none"> • Make sure the signal cable is properly connected to the monitor and the computer. • Move electrical devices that may cause electrical interference.
Screen image has color defects (white does not look white)	<ul style="list-style-type: none"> • Inspect the signal cable and make sure that none of the pins are bent. • Perform Reset via OSD. • Adjust the R/G/B color settings or select the Color Temperature via OSD.
Screen image is blurry or fuzzy	<ul style="list-style-type: none"> • Press the  /  or  button for two seconds to automatically adjust the image (for VGA mode only). • Adjust the Phase and Clock settings via OSD.
No sound or sound is low	<ul style="list-style-type: none"> • Ensure that the audio cable is properly connected to the monitor and the computer. • Adjust the volume settings of both your monitor and computer. • Ensure that the computer sound card driver is properly installed and activated.

3.4 Supported operating modes

Resolution Frequency	Horizontal Frequency (KHz)	Vertical Frequency (Hz)	Pixel (MHz)
640x480	31.47(N)	59.94(N)	25.18
640x480	35.00(N)	66.66(N)	30.24
640x480	37.87(N)	72.82(N)	31.5
640x480	37.5(N)	75.00(N)	31.5
720x400	31.47(N)	70.08(P)	28.32
800x600	35.16(P)	56.25(P)	36.00
800x600	37.88(P)	60.32(P)	40.00
800x600	48.08(P)	72.12(P)	50.00
800x600	46.86(P)	75.00(P)	49.50
832x624	49.72(P/N)	74.55(P/N)	57.28
1024x768	48.36(N)	60.00(N)	65.00
1024x768	56.476(N)	70.069(N)	75.00
1024x768	60.02(N)	75.00(N)	78.75
1152x864	67.5(P/N)	75.00(P/N)	108.00
1280x960	60.00(P)	60.00(N)	108.00
1280x1024	63.98(P)	60.02(P)	108.00
1280x1024	79.98(P)	75.02(P)	135.00
1366x768	47.712(P)	59.79(P)	85.50
1440x900	55.94(N)	59.89(P)	106.50
1600x1200	75.00(P)	60.00(P)	162.00
1680x1050	65.29(N)	60.00(P)	146.25
1920x1080 (Primary)	67.5(P)	60.00(P)	148.5

* Modes not listed in the table may not be supported. For optimal resolution, we recommend that you choose a mode listed in the table above.

* This monitor supports full HD (480p, 576p, 720p, 1080i/p) video content from game consoles, DVD players and other consumer video devices via HDMI.

Free Manuals Download Website

<http://myh66.com>

<http://usermanuals.us>

<http://www.somanuals.com>

<http://www.4manuals.cc>

<http://www.manual-lib.com>

<http://www.404manual.com>

<http://www.luxmanual.com>

<http://aubethermostatmanual.com>

Golf course search by state

<http://golfingnear.com>

Email search by domain

<http://emailbydomain.com>

Auto manuals search

<http://auto.somanuals.com>

TV manuals search

<http://tv.somanuals.com>