

MAXIMUS VI EXTREME

ASUS[®]

Motherboard

Copyright © 2013 ASUSTeK COMPUTER INC. All Rights Reserved.

No part of this manual, including the products and software described in it, may be reproduced, transmitted, transcribed, stored in a retrieval system, or translated into any language in any form or by any means, except documentation kept by the purchaser for backup purposes, without the express written permission of ASUSTeK COMPUTER INC. ("ASUS").

Product warranty or service will not be extended if: (1) the product is repaired, modified or altered, unless such repair, modification of alteration is authorized in writing by ASUS; or (2) the serial number of the product is defaced or missing.

ASUS PROVIDES THIS MANUAL "AS IS" WITHOUT WARRANTY OF ANY KIND, EITHER EXPRESS OR IMPLIED, INCLUDING BUT NOT LIMITED TO THE IMPLIED WARRANTIES OR CONDITIONS OF MERCHANTABILITY OR FITNESS FOR A PARTICULAR PURPOSE. IN NO EVENT SHALL ASUS, ITS DIRECTORS, OFFICERS, EMPLOYEES OR AGENTS BE LIABLE FOR ANY INDIRECT, SPECIAL, INCIDENTAL, OR CONSEQUENTIAL DAMAGES (INCLUDING DAMAGES FOR LOSS OF PROFITS, LOSS OF BUSINESS, LOSS OF USE OR DATA, INTERRUPTION OF BUSINESS AND THE LIKE), EVEN IF ASUS HAS BEEN ADVISED OF THE POSSIBILITY OF SUCH DAMAGES ARISING FROM ANY DEFECT OR ERROR IN THIS MANUAL OR PRODUCT.

SPECIFICATIONS AND INFORMATION CONTAINED IN THIS MANUAL ARE FURNISHED FOR INFORMATIONAL USE ONLY, AND ARE SUBJECT TO CHANGE AT ANY TIME WITHOUT NOTICE, AND SHOULD NOT BE CONSTRUED AS A COMMITMENT BY ASUS. ASUS ASSUMES NO RESPONSIBILITY OR LIABILITY FOR ANY ERRORS OR INACCURACIES THAT MAY APPEAR IN THIS MANUAL, INCLUDING THE PRODUCTS AND SOFTWARE DESCRIBED IN IT.

Products and corporate names appearing in this manual may or may not be registered trademarks or copyrights of their respective companies, and are used only for identification or explanation and to the owners' benefit, without intent to infringe.

Offer to Provide Source Code of Certain Software

This product contains copyrighted software that is licensed under the General Public License ("GPL"), under the Lesser General Public License Version ("LGPL") and/or other Free Open Source Software Licenses. Such software in this product is distributed without any warranty to the extent permitted by the applicable law. Copies of these licenses are included in this product.

Where the applicable license entitles you to the source code of such software and/or other additional data, you may obtain it for a period of three years after our last shipment of the product, either

(1) for free by downloading it from <http://support.asus.com/download>

or

(2) for the cost of reproduction and shipment, which is dependent on the preferred carrier and the location where you want to have it shipped to, by sending a request to:

ASUSTeK Computer Inc.
Legal Compliance Dept.
15 Li Te Rd.,
Beitou, Taipei 112
Taiwan

In your request please provide the name, model number and version, as stated in the About Box of the product for which you wish to obtain the corresponding source code and your contact details so that we can coordinate the terms and cost of shipment with you.

The source code will be distributed WITHOUT ANY WARRANTY and licensed under the same license as the corresponding binary/object code.

This offer is valid to anyone in receipt of this information.

ASUSTeK is eager to duly provide complete source code as required under various Free Open Source Software licenses. If however you encounter any problems in obtaining the full corresponding source code we would be much obliged if you give us a notification to the email address gpl@asus.com, stating the product and describing the problem (please DO NOT send large attachments such as source code archives, etc. to this email address).

Contents

Safety information.....	vi
About this guide.....	vii
MAXIMUS VI EXTREME specifications summary	ix
OC Panel specifications summary	xiv
Package contents.....	xv
Installation tools and components.....	xvi

Chapter 1: Product Introduction

1.1 Special features.....	1-1
1.1.1 Product highlights.....	1-1
1.1.2 ROG Intelligent Performance & Overclocking features.....	1-2
1.1.3 ASUS special features	1-4
1.1.4 ROG rich-bundled software.....	1-4
1.2 Motherboard overview.....	1-6
1.2.1 Before you proceed.....	1-6
1.2.2 Motherboard layout	1-7
1.2.3 Central Processing Unit (CPU)	1-9
1.2.4 System memory	1-10
1.2.5 Expansion slots.....	1-19
1.2.6 Onboard buttons and switches.....	1-22
1.2.7 Jumpers	1-27
1.2.8 Onboard LEDs	1-28
1.2.9 Internal connectors.....	1-37
1.2.10 Probelt.....	1-48

Chapter 2: Basic Installation

2.1 Building your PC system.....	2-1
2.1.1 Motherboard installation.....	2-1
2.1.2 CPU installation.....	2-3
2.1.3 CPU heatsink and fan assembly installation	2-4
2.1.4 DIMM installation.....	2-6
2.1.5 ATX Power connection.....	2-7
2.1.6 SATA device connection.....	2-8
2.1.7 Front I/O Connector	2-9
2.1.8 Expansion Card installation.....	2-10
2.1.9 mPCIe Combo II installation.....	2-11
2.2 BIOS update utility	2-15
2.3 Motherboard rear and audio connections	2-16
2.3.1 Rear I/O connection	2-16
2.3.2 Audio I/O connections.....	2-17

2.4	OC Panel	2-21
2.4.1	OC Panel Overview	2-21
2.4.2	Setting up your OC Panel in Normal Mode	2-23
2.4.3	Setting up your OC Panel in Extreme Mode	2-25
2.5	Starting up for the first time	2-26
2.6	Turning off the computer	2-26

Chapter 3: BIOS setup

3.1	Knowing BIOS	3-1
3.2	BIOS setup program	3-2
3.2.1	EZ Mode	3-3
3.2.2	Advanced Mode	3-4
3.3	My Favorites	3-6
3.4	Extreme Tweaker menu	3-7
3.5	Main menu	3-22
3.6	Advanced menu	3-25
3.6.1	CPU Configuration	3-26
3.6.2	PCH Configuration	3-29
3.6.3	SATA Configuration	3-31
3.6.4	System Agent Configuration	3-32
3.6.5	USB Configuration	3-34
3.6.6	Platform Misc Configuration	3-35
3.6.7	Onboard Devices Configuration	3-36
3.6.8	APM	3-38
3.6.9	Network Stack Configuration	3-39
3.6.10	ROG Effects	3-39
3.7	Monitor menu	3-40
3.8	Boot menu	3-44
3.9	Tools menu	3-48
3.9.1	ASUS EZ Flash 2 Utility	3-48
3.9.2	ASUS O.C. Profile	3-48
3.9.3	ASUS SPD Information	3-49
3.9.4	BIOS Flashback	3-50
3.10	Exit menu	3-51
3.11	Updating BIOS	3-52
3.11.1	ASUS EZ Flash 2	3-53
3.11.2	ASUS CrashFree BIOS 3	3-54
3.11.3	ASUS BIOS Updater	3-55
3.12	ROG SSD Secure Erase	3-58

Chapter 4: Software support

4.1	Installing an operating system	4-1
4.2	Support DVD information	4-1
4.2.1	Running the support DVD	4-1
4.2.2	Obtaining the software manuals	4-2
4.3	Software information	4-4
4.4	AI Suite 3	4-4
4.4.1	Dual Intelligent Processors 4 with 4-Way Optimization	4-7
4.4.2	Ai Charger+	4-17
4.4.3	USB Charger+	4-18
4.4.4	Wi-Fi Engine	4-19
4.4.5	USB 3.0 Boost	4-21
4.4.6	USB BIOS Flashback	4-22
4.4.7	Wi-Fi GO!	4-24
4.4.8	EZ Update	4-40
4.4.9	System Information	4-41
4.5	Audio configurations	4-43
4.6	ROG Connect	4-44
4.7	MemTweakIt	4-46
4.8	ROG RAMDisk	4-49

Chapter 5: RAID support

5.1	RAID configurations	5-1
5.1.1	RAID definitions	5-1
5.1.2	Installing Serial ATA hard disks	5-2
5.1.3	Setting the RAID item in BIOS	5-2
5.1.4	Intel® Rapid Storage Technology Option ROM utility	5-3
5.2	Creating a RAID driver disk	5-8
5.2.1	Creating a RAID driver disk without entering the OS	5-8
5.2.2	Creating a RAID driver disk in Windows®	5-8
5.2.3	Installing the RAID driver during Windows® OS installation	5-9

Appendices

Notices	A-1
ASUS contact information	A-5

Safety information

Electrical safety

- To prevent electrical shock hazard, disconnect the power cable from the electrical outlet before relocating the system.
- When adding or removing devices to or from the system, ensure that the power cables for the devices are unplugged before the signal cables are connected. If possible, disconnect all power cables from the existing system before you add a device.
- Before connecting or removing signal cables from the motherboard, ensure that all power cables are unplugged.
- Seek professional assistance before using an adapter or extension cord. These devices could interrupt the grounding circuit.
- Ensure that your power supply is set to the correct voltage in your area. If you are not sure about the voltage of the electrical outlet you are using, contact your local power company.
- If the power supply is broken, do not try to fix it by yourself. Contact a qualified service technician or your retailer.

Operation safety

- Before installing the motherboard and adding devices on it, carefully read all the manuals that came with the package.
- Before using the product, ensure all cables are correctly connected and the power cables are not damaged. If you detect any damage, contact your dealer immediately.
- To avoid short circuits, keep paper clips, screws, and staples away from connectors, slots, sockets and circuitry.
- Avoid dust, humidity, and temperature extremes. Do not place the product in any area where it may become wet.
- Place the product on a stable surface.
- If you encounter technical problems with the product, contact a qualified service technician or your retailer.

About this guide

This user guide contains the information you need when installing and configuring the motherboard.

How this guide is organized

This guide contains the following parts:

1. Chapter 1: Product introduction

This chapter describes the features of the motherboard and the new technology it supports. It includes description of the switches, jumpers, and connectors on the motherboard.

2. Chapter 2: Basic Installation

This chapter lists the hardware setup procedures that you have to perform when installing system components.

3. Chapter 3: BIOS setup

This chapter tells how to change system settings through the BIOS Setup menus. Detailed descriptions of the BIOS parameters are also provided.

4. Chapter 4: Software support

This chapter describes the contents of the support DVD that comes with the motherboard package and the software.

5. Chapter 5: RAID support

This chapter describes the RAID configurations.

Where to find more information

Refer to the following sources for additional information and for product and software updates.

1. ASUS websites

The ASUS website (www.asus.com) provides updated information on ASUS hardware and software products.

2. Optional documentation

Your product package may include optional documentation, such as warranty flyers, that may have been added by your dealer. These documents are not part of the standard package.

Conventions used in this guide

To ensure that you perform certain tasks properly, take note of the following symbols used throughout this manual.



DANGER/WARNING: Information to prevent injury to yourself when trying to complete a task.



CAUTION: Information to prevent damage to the components when trying to complete a task.



IMPORTANT: Instructions that you **MUST** follow to complete a task.



NOTE: Tips and additional information to help you complete a task.

Typography

Bold text

Indicates a menu or an item to select.

Italics

Used to emphasize a word or a phrase.

<Key>

Keys enclosed in the less-than and greater-than sign means that you must press the enclosed key.

Example: <Enter> means that you must press the Enter or Return key.

<Key1> + <Key2> + <Key3>

If you must press two or more keys simultaneously, the key names are linked with a plus sign (+).

MAXIMUS VI EXTREME specifications summary

CPU	<p>LGA1150 socket for 4th Generation Intel® Core™ i7 / Intel® Core™ i5 / Intel® Core™ i3, Pentium®, Celeron® Processors Supports 22nm CPU Supports Intel® Turbo Boost Technology 2.0*</p> <p>* The Intel® Turbo Boost Technology 2.0 support depends on the CPU type. ** Refer to http://support.asus.com/cpu.aspx for Intel CPU support list.</p>
Chipset	<p>Intel® Z87 Express Chipset</p>
Memory	<p>Dual channel memory architecture 4 x DIMM, max. 32GB, DDR3 3000(O.C.) / 2933(O.C.) / 2800(O.C.) / 2666(O.C.) / 2600(O.C.) / 2500 (O.C.) / 2400 (O.C.) / 2200(O.C.) / 2133(O.C.) / 2000(O.C.) / 1866(O.C.) / 1800(O.C.) / 1600 / 1333 MHz, non-ECC, un-buffered memory Supports Intel® Extreme Memory Profile (XMP)</p> <p>* Hyper DIMM support is subject to the physical characteristics of individual CPUs. ** Please refer to Memory QVL (Qualified Vendors List) for details.</p>
Expansion slots	<p>5 x PCI Express 3.0*/2.0 x16 slots (single at native x16, dual at x8/x8**, triple at x8/x16/x8, quad at x8/x16/x8/x8) 1 x PCI Express 2.0 x4 slot 1 x mini-PCI Express 2.0 x1 slot*** on mPCIe Combo II expansion card</p> <p>* PCIe 3.0 speed is supported by 4th generation Intel® Core™ Processors. ** Native x8/x8 mode is available only when PCIE_x16/x8_1 and PCIE_x8_B2 slots are in use. *** The mini-PCIe slot is pre-installed with a Wi-Fi/Bluetooth module.</p>
VGA	<p>Integrated Intel® HD Graphics Processor Multi-VGA output support: DisplayPort/HDMI port DisplayPort 1.2* with max. resolution of 4096 x 2160 @ 24 Hz / 3840 x 2160 at 60Hz HDMI with max. resolution of 4096 x 2160 at 24Hz / 2560 x 1600 at 60Hz Intel® InTru™ 3D/ Intel® Quick Sync Video/ Intel® Clear Video HD Technology/ Intel® Insider™</p> <p>* DP 1.2 Multi-Stream Transport, supports DP 1.2 monitor daisy chain up to 3 displays.</p>
Multi-GPU support	<p>NVIDIA® 4-Way/3-Way/Quad-GPU SLI® Technology AMD CrossFireX™ Technology</p>

(continued on the next page)

Storage	<p>Intel® Z87 Express Chipset: 6 x SATA 6.0 Gb/s ports* - Intel® Rapid Storage 12 supports RAID 0, 1, 5, and 10 - Intel® Smart Response Technology, Intel® Rapid Start Technology, and Intel® Smart Connect Technology** 1 x M.2 (NGFF) SSD socket 2 on mPCIe Combo II expansion card - Supports PCI Express 2.0 x1 and SATA 6Gb/s standard - Supports M.2 (NGFF) Type 2242 (22mm x 42mm) SSD card</p> <p>ASMedia® SATA 6Gb/s controller: - 4 x SATA 6.0 Gb/s ports***</p> <p>* SATA 6Gb/s port 5 will be disabled when M.2 (NGFF) slot on mPCIe Combo II is in use.</p> <p>** The functions supported depends on the CPU types.</p> <p>*** These SATA ports are for data hard drives only. ATAPI devices are not supported.</p>
LAN	1 x Intel® I217-V Gigabit LAN Controller
Wireless Data Network	Wi-Fi 802.11 a/b/g/n/ac supports dual frequency band 2.4/5 GHz * The module is pre-installed on the mPCIe Combo II expansion card.
Bluetooth	Bluetooth v4.0/3.0+HS * The module is pre-installed on the mPCIe Combo II expansion card.
Audio	<p>Realtek® ALC1150 8-Channel High Definition Audio CODEC</p> <ul style="list-style-type: none"> - Supports jack-detection, multi-streaming, front panel jack-retasking - Content Protection for Full Rate lossless DVD Audio, Blu-ray DVD, and HD-DVD audio content playback - Optical S/PDIF output port at back panel
USB	<p>Intel® Z87 Express Chipset</p> <ul style="list-style-type: none"> - 4 x USB 3.0 ports (2 ports at mid-board [red], 2 ports at back panel [blue] with ASUS USB 3.0 Boost support*) - 8 x USB 2.0 ports (2 ports at back panel, 1 port reserved for ROG Connect; 6 ports at mid-board**) <p>ASMedia® USB 3.0 SuperSpeed USB HUB controller</p> <ul style="list-style-type: none"> - 4 x USB 3.0 ports (4 ports at back panel [blue]) <p>* The UASP standard for Intel® native USB 3.0 is only supported under Windows 8® OS.</p> <p>** 2 x USB2.0 ports at mid-board shares with ROG extension (ROG_EXT) port.</p>

(continued on the next page)

<p style="text-align: center;">ROG Exclusive Features</p>	<p>ROG Extreme OC Kit</p> <ul style="list-style-type: none"> - EZ Plug - LN2 Mode - Slow Mode - PCIe x16 Lane switch <p>ROG Connect</p> <ul style="list-style-type: none"> - RC Diagram - RC Remote - RC Poster <p>ROG Extreme Engine Digi+ III</p> <ul style="list-style-type: none"> - Full digital 8+2 phase CPU/DRAM power - NexFET™ Power Block MOSFET - 60A BlackWing Chokes - 10K Black Metallic Capacitors <p>mPCIe Combo II (mPCIe/M.2 (NGFF) combo card)</p> <p>UEFI BIOS features</p> <ul style="list-style-type: none"> - ROG BIOS Print - GPU.DIMM Post - Extreme Tweaker - Tweaker's Paradise - ROG SSD Secure Erase - O.C. Profile - ROG Pulse <p>CPU Level Up</p> <p>Probelt</p> <p>ROG RAMDisk</p>
	<p style="text-align: center;">Special Features</p>

(continued on the next page)

<p>Special Features</p>	<p>ASUS EZ DIY</p> <ul style="list-style-type: none"> - ASUS BIOS Flashback - ASUS CrashFree BIOS 3 - ASUS EZ Flash 2 - ASUS C.P.R. (CPU Parameter Recall) <p>ASUS Q-Design</p> <ul style="list-style-type: none"> - ASUS Q-Code - ASUS Q-Shield - ASUS Q-Connector - ASUS Q-LED (CPU, DRAM, VGA, Boot Device LED) - ASUS Q-Slot - ASUS Q-DIMM
<p>Back I/O Ports</p>	<p>1 x Clear CMOS button 1 x ROG Connect button 2 x USB 2.0 ports (1 port can be switched to ROG Connect) 6 x USB 3.0 ports [blue] 1 x LAN (RJ45) port 1 x Optical S/PDIF out 1 x HDMI port 1 x DisplayPort 1 x PS/2 keyboard/mouse combo port 6 x Audio jacks</p>
<p>Internal Connectors</p>	<p>1 x USB 3.0 connector (supports additional two USB 3.0 ports) 3 x USB 2.0 connectors (support additional six USB 2.0 ports, one connector via ROG_EXT header) 10 x SATA 6.0 Gb/s connectors 1 x ROG Extension (ROG_EXT) header 1 x 4-pin CPU fan connector 1 x 4-pin CPU optional fan connector 3 x 4-pin Chassis fan connector 3 x 4-pin Optional fan connector 3 x Thermal sensor connectors 1 x 24-pin EATX Power connector 1 x 8-pin EATX 12V Power connector 1 x 4-pin EATX 12V Power connector 1 x 6-pin EZ Plug connector (in black for PCIe slots) 1 x 4-pin EZ Plug connector (in white for back I/O and PCIe slots) 10 x ProbelT Measurement Points 1 x LN2 Mode jumper 1 x Slow mode switch 1 x Power-on button 1 x Reset button 1 x MemOK! button 1 x BIOS Switch button 1 x S/PDIF out header</p>

(continued on the next page)

Internal Connectors	<ul style="list-style-type: none"> 1 x Front panel audio connector (AAFP) 1 x System panel connector 1 x mPCIe Combo II connector 1 x Directkey button 1 x DRCT (DirectKey) header 1 x FastBoot switch
Accessory	<ul style="list-style-type: none"> 1 x User's manual 1 x I/O Shield OC Panel Kit <ul style="list-style-type: none"> - 1 x OC Panel - 1 x OC Panel 5.25-inch drive bay metal case - 1 x OC Panel cable - Set of screws (1 x 6 pcs) 1 x mPCIe Combo II card with dual-band WiFi 802.11 a/b/g/n/ac + Bluetooth v4.0/3.0+HS module 1 x 2T2R dual-band Wi-Fi moving antenna 5 x 2-in-1 SATA 6Gb/s signal cables 1 x 4-Way SLI® bridge 1 x 3-Way SLI® bridge 1 x SLI® cable 1 x CrossFire™ cable 1 x ROG Connect cable 1 x 2-in-1 ASUS Q-Connector Kit 1 x 12-in-1 ROG Cable Label 1 x ROG Magnet
Manageability	WfM2.0, DMI2.0, WOL by PME, PXE
BIOS Features	64 Mb UEFI AMI BIOS, PnP, DMI 2.0, WfM 2.0, SM BIOS 2.5, ACPI 2.0a, Multi-language BIOS
Manageability	WfM2.0, DMI2.0, WOL by PME, PXE
Support DVD contents	<ul style="list-style-type: none"> Drivers ROG RAMDisk ROG CPU-Z ROG Mem Tweakt Kaspersky® Anti-Virus DAEMON Tools Pro Standard ASUS WebStorage ASUS Utilities
Form Factor	ATX Form Factor, 12" x 9.6" (30.5cm x 24.4cm)



Specifications are subject to change without notice.

OC Panel specifications summary

Display	2.6-inch LCM
Features	<p>Pure hardware-based overclocking support Boot debug POST code</p> <p>Intuitive tuning in two OC modes</p> <ul style="list-style-type: none"> - EXTREME Mode for subzero OC benching - NORMAL Mode for in-chassis usage <p>Seamless integration with CPU Level Up at one-click OC button Real-time control and display CPU fan speed, temperature, BCLK and RATIO</p> <p>Adjustable system voltages, frequencies on-the-fly Stylish design with 90 plus-degree-tilt movable faceplate (EXTREME Mode)</p> <p>FanSpeed Control button</p> <ul style="list-style-type: none"> - Standard/Silent/Turbo mode <p>Four (4) additional 4-pin fan headers LCM backlight on/off</p> <p>ROG exclusive features</p> <ul style="list-style-type: none"> - VGA Hotwire - Subzero Sense - Slow Mode - Pause Switch - VGA SMB header - Probelit
I/O Ports	<p>POWER : 1 x SATA power connector ROG_EXT port : 1 x 18-1 pin data connection port FAN : 4 x 4-pin extra Fan connectors</p>
Power	<p>Voltage : +12V, +5V, +5VSB Power consumption : 5A</p>
Installation Requirements	<p>1 x 5.25-inch drive bay required for NORMAL Mode installation 1 x SATA power cable from system power supply</p>
Compatibility	<p>Maximus VI Series and other motherboards with ROG_EXT port</p> <p>*Visit the ASUS website at www.asus.com for the latest motherboard support/compatibility lists.</p> <p>**Please install the latest utility/firmware (ROG Connect Plus) for better compatibility.</p> <p>***Update the motherboard BIOS to the latest version for better compatibility with OC Panel.</p>

Package contents



Check your motherboard package for the following items.

Motherboard	ROG MAXIMUS VI EXTREME
Cables	1 x ROG Connect cable 5 x 2-in-1 SATA 6.0 Gb/s signal cables 1 x 4-WAY SLI® bridge 1 x 3-WAY SLI® bridge 1 x SLI® cable 1 x CrossFire™ cable 1 x ROG_EXT cable (for OC Panel)
Accessories	1 x I/O Shield 1 x OC Panel 1 x OC Panel 5.25-inch drive bay metal case 1 x mPCIe Combo II card with dual band Wi-Fi / Bluetooth module 1 x dual band Wi-Fi Moving Antenna 1 x 12-in-1 ROG cable label 1 x 2-in-1 ASUS Q-Connector kit 1 x ROG Magnet
Application DVD	ROG motherboard support DVD
Documentation	User guide

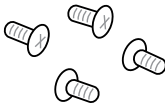

If any of the above items is damaged or missing, contact your retailer.

Installation tools and components

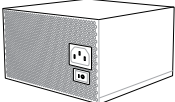
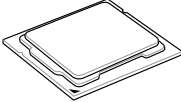
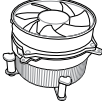
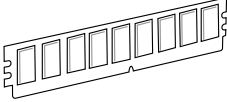
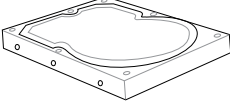
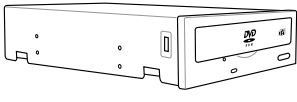
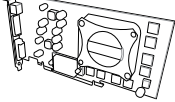
	
<p>1 bag of screws</p>	<p>Phillips (cross) screwdriver</p>
	
<p>PC chassis</p>	<p>Power supply unit</p>
	
<p>Intel LGA 1150 CPU</p>	<p>Intel LGA 1150 compatible CPU Fan</p>
	
<p>DDR3 DIMM</p>	<p>SATA hard disk drive</p>
	
<p>SATA optical disc drive (optional)</p>	<p>Graphics card (optional)</p>



The tools and components in the table above are not included in the motherboard package.

Product introduction

1

1.1 Special features

1.1.1 Product highlights

Republic of Gamers

The Republic of Gamers offers you the best of the best. We offer the best hardware engineering, the fastest performance, the most innovative ideas, and we welcome the best gamers to join in. In the Republic of Gamers, mercy rules are only for the weak, and bragging rights means everything. We believe in making statements and we excel in competitions. If your character matches our trait, then join the elite Republic of Gamers and make your presence felt.

LGA1150 socket for 4th Generation Intel® Core™ i7 / Intel® Core™ i5 / Intel® Core™ i3, Pentium® and Celeron® Processors

This motherboard supports 4th generation Intel® Core™ i7/ Intel® Core™ i5/ Intel® Core™ i3, Pentium® and Celeron® processors in the LGA1150 package. It provides great graphics and system performance with its GPU, dual-channel DDR3 memory slots, and PCI Express 2.0/3.0 expansion slots.

Intel® Z87 Express Chipset

Intel® Z87 Express Chipset is a single-chipset that supports the LGA1150 socket 4th generation Intel® Core™ i7/ Intel® Core™ i5/ Intel® Core™ i3, Pentium® and Celeron® processors. It utilizes the serial point-to-point links, which increases bandwidth and enhances the system's performance. It natively supports up to six USB 3.0 ports for up to ten times faster transfer rate than USB 2.0, and enables the iGPU function for Intel® integrated graphics performance.

PCI Express® 3.0

PCI Express® 3.0 (PCIe 3.0) is the PCI Express bus standard that provides twice the performance and speed of PCIe 2.0. It provides an optimal graphics performance, unprecedented data speed, and seamless transition with its complete backward compatibility to PCIe 1.0/2.0 devices.

SLI®/CrossFire™ On-Demand

This motherboard features a unique PCIe 3.0 bridge chip to support multi-GPU SLI®/ CrossFireX™ graphics cards for an unrivaled gaming performance. With the Intel® Z87 platform to optimize the PCIe allocation of multiple GPUs, it supports up to 4-WAY GPU SLI® or CrossFireX™ configuration.

1.1.2 ROG Intelligent Performance & Overclocking features

mPCIe Combo II

ROG mPCIe Combo II offers expandability solutions with the latest connectivity standards via the proprietary connector onboard. It provides your system with the fastest Wi-Fi 802.11ac and Bluetooth 4.0 connection. It also features the M.2 (NGFF) slot for an optimal system performance.

ROG Connect

ROG Connect allows you to monitor the status of your desktop PC and tweak its parameters in real-time via a notebook. ROG Connect links your main system to a notebook through a USB cable, allowing you to view real-time POST code and hardware status readouts on your notebook, as well as make on-the-fly parameter adjustments at a purely hardware level.

Extreme Engine Digi+ III

The Extreme Engine Digi+ III offers the best CPU/Memory design on the Z87[®] motherboard. It is equipped with NexFET™ Power Block MOSFET that offers great durability and provides up to 90% efficiency under normal operation. The BlackWing Chokes handles pressures with ease. The Black Metallic solid capacitor lasts five times longer than the generic capacitors with better low temperature tolerance. Altogether making it the perfect motherboard for overclocking.

iROG

The iROG is a special IC that fully maximizes ROG's unique functions, providing you with full control of your motherboard at any stage. It greatly increases your overclocking enjoyment, and offers you with advanced system control and management features purely at a hardware level.

CPU Level Up

With ROG's CPU Level Up, overclocking has never been so easy, or cost-free. Simply select the processor that you want to overclock to, and the motherboard will do the rest.

USB BIOS FlashBack

USB BIOS Flashback offers a hassle-free updating solution for your ultimate convenience. Simply install a USB storage device containing the BIOS file, press the BIOS Flashback button for three seconds, and the UEFI BIOS is automatically updated even without entering the existing the BIOS or operating system. It also allows you to regularly check for UEFI BIOS updates, and download the latest BIOS automatically.

GPU.DIMM Post

GPU.DIMM Post enables you to catch potential problems even before you enter the OS, saving you valuable time in detecting component failure under extreme conditions. With GPU.DIMM Post, quickly and easily check your graphic cards, memory modules' statuses in the BIOS, and overclocking settings.

BIOS Print

ROG offers a whole new UEFI BIOS feature to handle the demands of an overclocking experience. The motherboard features ROG BIOS Print that allows you to easily share your BIOS settings to others with the press of a button.

ProbelT

This motherboard consists of ten (10) ProbelT measurement points that helps you detect your system's current voltage. With the use of a multimeter device, these points can help measure your system's Vcore, PCH, IO (Digital/Analog), DRAM, iGPU, System agent and other critical voltages.

Extreme Tweaker

Extreme Tweaker is the one stop shop to fine-tune your system to optimal performance. With Extreme Tweaker, you can adjust the system settings such as frequency, over-voltage, memory timing, and more.

Loadline Calibration

Maintaining ample voltage support for the CPU is critical during overclocking. The Loadline Calibration ensures stable and optimal CPU voltage under heavy loading. It helps overclockers enjoy the motherboard's ultimate OC capabilities and benchmark scores.

BIOS Flashback

BIOS Flashback gives you the ability to save two versions of BIOS simultaneously: one saved BIOS for the tweaked overclocking setting, and one saved BIOS from the previous version.

OC Panel

Overclocking made easier than ever! No more messing with the BIOS, OS, or software utilities. OC Panel is the next step in dedicated direct tweaking. It works inside the case or as an external console, and features normal mode with info covering CPU temp, ratio, base clock, and CPU fan speed. With one press of the CPU Level Up button you can instantly apply custom profiles designed by the world's leading overclockers, while FanSpeed Control modifies blower RPMs. In extreme mode, some of the most commonly used voltage tuning settings are offered, along with Subzero Sense and VGA Hotwire, giving you field access to super-cool liquid thermal temp readings and streamlined hardware-level GPU overvolting.

1.1.3 ASUS special features

Wi-Fi GO!

ASUS Wi-Fi GO! leads the way to a more enjoyable home entertainment. With ASUS Wi-Fi GO!, you can wirelessly stream media files to HDTV devices, remotely control and access your computer using your mobile device, and easily transfer files between your computer and mobile device.

Conveniently use and enjoy these ASUS Wi-Fi GO! functions:

- **Cloud GO!:** Allows you to control files and sync them all across cloud services in a few clicks.
- **Media Streaming Hub:** Allows you to stream media files to an HDTV device.
- **Remote Desktop:** Allows you to view your computer's desktop and remotely operate your computer in real-time from your mobile device.
- **Remote Keyboard and Mouse:** Allows you to use your mobile device's touch panel as a remote keyboard and mouse for your computer.
- **Smart Motion Control:** Allows you to remotely control your computer using your mobile device's customized gestures.
- **File Transfer:** Allows you to transfer files between your computer and mobile device.
- **Capture and Send:** Allows you to take screenshots and send them to a mobile device.

1.1.4 ROG rich-bundled software

Kaspersky® Anti-Virus

Kaspersky® Anti-Virus Personal offers premium antivirus protection for individual users and home offices. It is based on advanced antivirus technologies. The product incorporates the Kaspersky® Anti-Virus engine, which is renowned for malicious program detection rates that are among the industry's highest.

DAEMON Tools Pro Standard

DAEMON Tools Pro offers essential functionality to backup CD, DVD and Blu-ray discs. It converts optical media into virtual discs and emulates devices to work with the virtual copies. DAEMON Tools Pro organizes data, music, video, and photo collections on a PC, notebook, or netbook.

ROG CPU-Z

ROG CPU-Z, authorized by Intel's CPU Identification (CPUID), is a customized ROG utility that allows you to gather information about your system's main components. It gives you the current information and status of your CPU, motherboard, memory, and other main components. Get that ROG look of reporting your system's current information with ROG CPU-Z.

MemTweakIt

MemTweakIt is a DRAM efficiency tool that allows you to fine-tune your DRAM in real time and allows you to post and share your DRAM configuration scores to the ROG website.

ROG RAMDisk

RAMDisk reserves part of system memory and turns it into actual storage, so you can place favorite app and game cache files in it to enjoy high-speed RAM performance while accessing them. Plus, this extends SSD lifespan and keeps your main storage optimized for really important tasks, and you get auto data backup and restore.

1.2 Motherboard overview

1.2.1 Before you proceed

Take note of the following precautions before you install motherboard components or change any motherboard settings.



-
- Unplug the power cord from the wall socket before touching any component.
 - Before handling components, use a grounded wrist strap or touch a safely grounded object or a metal object, such as the power supply case, to avoid damaging them due to static electricity.
 - Hold components by the edges to avoid touching the ICs on them.
 - Whenever you uninstall any component, place it on a grounded antistatic pad or in the bag that came with the component.
 - Before you install or remove any component, ensure that the ATX power supply is switched off or the power cord is detached from the power supply. Failure to do so may cause severe damage to the motherboard, peripherals, or components.
-

1.2.2 Motherboard layout

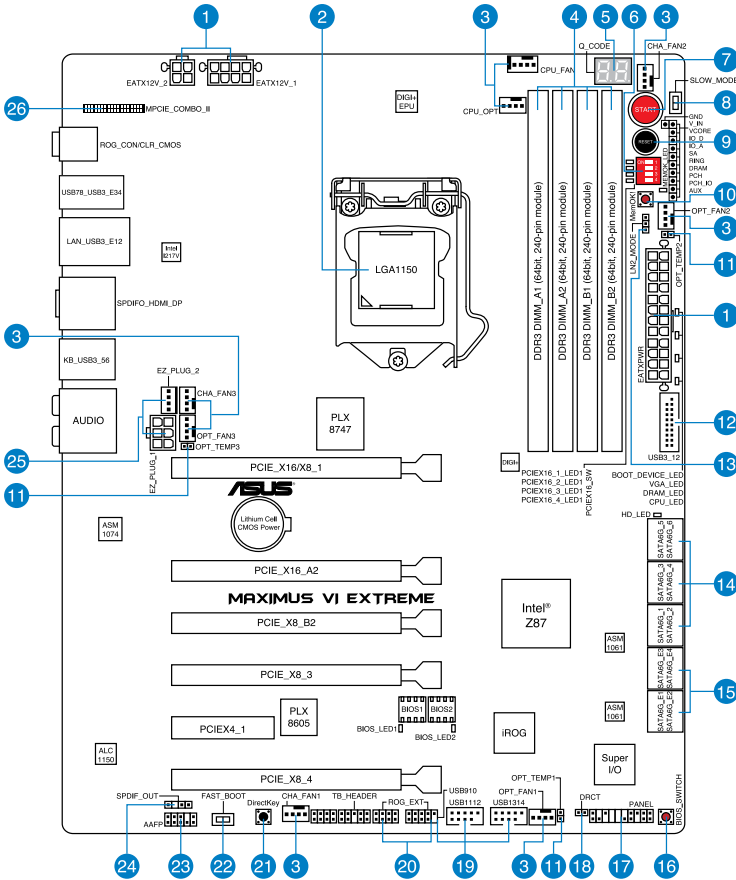

Refer to 1.2.9 Internal connectors and 2.3.1 Rear I/O connection for more information about rear panel connectors and internal connectors.

Layout contents

Connectors/Jumpers/Buttons and switches/Slots	Page
1. Power connectors (24-pin EATXPWR, 8-pin EATX12V, 4-pin EATX12V)	1-43
2. LGA1150 CPU Socket	1-9
3. CPU, chassis, and optional fan connectors (4-pin CPU_FAN, 4-pin CPU_OPT, 4-pin OPT_FAN1-3, 4-pin CHA_FAN1-3)	1-41
4. DDR3 DIMM slots	1-10
5. Q_Code LEDs	1-30
6. PCIe x16 Lane switch	1-25
7. START (Power-on) button	1-22
8. Slow Mode switch	1-24
9. RESET button	1-22
10. MemOK! button	1-23
11. Thermal sensor cable connectors (2-pin OPT_TEMP1-3)	1-45
12. USB 3.0 connectors (20-1 pin USB3_12)	1-38
13. LN2 Mode header	1-27
14. Intel® Z87 Serial ATA 6.0 Gb/s connectors (7-pin SATA6G_1-6 [red])	1-37
15. ASMedia® Serial ATA 6.0 Gb/s connectors (7-pin SATA6G_E12/E34 [red])	1-38
16. BIOS Switch button	1-24
17. System panel connector (20-8 pin PANEL)	1-44
18. DRCT connector	1-46
19. USB 2.0 connectors (10-1 pin USB910; USB1112; USB1314)	1-40
20. ROG Extension connector (18-1 pin ROG_EXT)	1-47
21. DirectKey button	1-26
22. Fast Boot switch	1-25
23. Front panel audio connector (10-1 pin AAFP)	1-42
24. Digital audio connector (4-1 pin SPDIF_OUT)	1-39
25. EZ Plug connectors (6-pin EZ_PLUG_1; 4-pin EZ_PLUG_2)	1-45
26. mPCIe Combo II slot (MPCIE_COMBO_II)	1-46

1.2.3 Central Processing Unit (CPU)

The motherboard comes with a surface mount LGA1150 socket designed for the 4th Generation Intel® Core™ i7 / Intel® Core™ i5 / Intel® Core™ i3, Pentium®, and Celeron® processors.

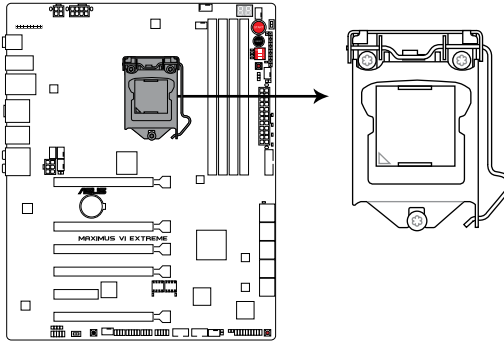

MAXIMUS VI EXTREME CPU LGA1150



- Ensure that all power cables are unplugged before installing the CPU.
- Ensure that you install the correct CPU designed for LGA1150 only. DO NOT install a CPU designed for LGA1155 and LGA1156 sockets on the LGA1150 socket.
- Upon purchase of the motherboard, ensure that the PnP cap is on the socket and the socket contacts are not bent. Contact your retailer immediately if the PnP cap is missing, or if you see any damage to the PnP cap/socket contacts/motherboard components. ASUS will shoulder the cost of repair only if the damage is shipment/transit-related.
- Keep the cap after installing the motherboard. ASUS will process Return Merchandise Authorization (RMA) requests only if the motherboard comes with the cap on the LGA1150 socket.
- The product warranty does not cover damage to the socket contacts resulting from incorrect CPU installation/removal, or misplacement/loss/incorrect removal of the PnP cap.

1.2.4 System memory

The motherboard comes with four Double Data Rate 3 (DDR3) Dual Inline Memory Modules (DIMM) slots.



A DDR3 module is notched differently from a DDR or DDR2 module. DO NOT install a DDR or DDR2 memory module to the DDR3 slot.

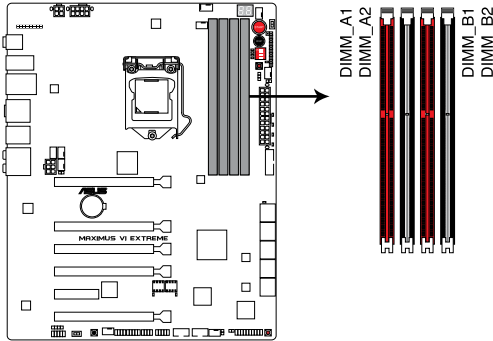

MAXIMUS VI EXTREME 240-pin DDR3 DIMM sockets

Recommended memory configurations

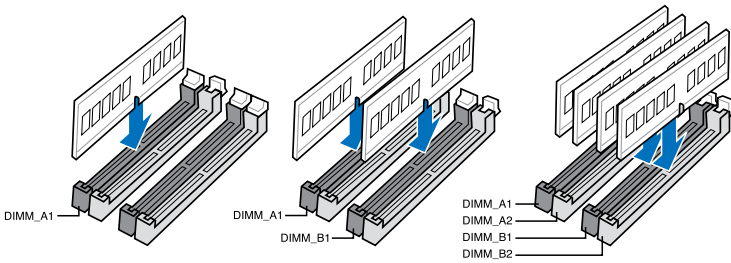

Memory configurations

You may install 1GB, 2GB, 4GB and 8GB unbuffered and non-ECC DDR3 DIMMs into the DIMM sockets.



-
- Memory module with memory frequency higher than 2133 MHz and its corresponding timing or the loaded XMP profile is not the JEDEC memory standard. The stability and compatibility of these memory modules depend on the CPU's capabilities and other installed devices.
 - You may install varying memory sizes in Channel A and Channel B. The system maps the total size of the lower-sized channel for the dual-channel configuration. Any excess memory from the higher-sized channel is then mapped for single-channel operation.
 - According to Intel CPU spec, DIMM voltage below 1.65V is recommended to protect the CPU.
 - Always install DIMMs with the same CAS latency. For optimal compatibility, we recommend that you install memory modules of the same version or date code (D/C) from the same vendor. Check with the retailer to get the correct memory modules.
 - Due to the memory address limitation on 32-bit Windows OS, when you install 4GB or more memory on the motherboard, the actual usable memory for the OS can be about 3GB or less. For effective use of memory, we recommend that you do any of the following:
 - a) Use a maximum of 3GB system memory if you are using a 32-bit Windows OS.
 - b) Install a 64-bit Windows OS when you want to install 4GB or more on the motherboard.
 - c) For more details, refer to the Microsoft® support site at <http://support.microsoft.com/kb/929605/en-us>.
 - This motherboard does not support DIMMs made up of 512Mb (64MB) chips or less (Memory chip capacity counts in Megabit, 8 Megabit/Mb = 1 Megabyte/MB).



-
- The default memory operation frequency is dependent on its Serial Presence Detect (SPD), which is the standard way of accessing information from a memory module. Under the default state, some memory modules for overclocking may operate at a lower frequency than the vendor-marked value. To operate at the vendor-marked or at a higher frequency, refer to section **3.4 Extreme Tweaker menu** for manual memory frequency adjustment.
 - For system stability, use a more efficient memory cooling system to support a full memory load (4 DIMMs) or overclocking condition.
-

MAXIMUS VI EXTREME Motherboard Qualified Vendors Lists (QVL)

DDR3 3000 MHz capability

Vendors	Part No.	Size	SS/DS	Chip Brand	Chip NO.	Timing	Voltage	DIMM socket support (Optional)	
								2	4
G.SKILL	F3-3000C12Q-16GTXDG	16GB (4x4GB)	SS	-	-	12-14-14-35	1.65V	•	•
CORSAIR	CML8GX3M2A3000C12R	8GB (2x4GB)	SS	-	-	12-14-14-36	1.65V	•	•

DDR3 2800 MHz capability

Vendors	Part No.	Size	SS/DS	Chip Brand	Chip NO.	Timing	Voltage	DIMM socket support (Optional)	
								2	4
AVEXIR	AVD3U28001204G-4CI	16GB (4x4GB)	DS	-	-	12-14-14-35	1.65V	•	•
CORSAIR	CMD16GX3M4A2800C11	16GB (4x4GB)	DS	-	-	11-14-14-35	1.65V	•	•
CORSAIR	CMD16GX3M4A2800C12	16GB (4x4GB)	DS	-	-	12-14-14-36	1.65V	•	•
G.SKILL	F3-2800C11D-8GTXD	8GB (2x4GB)	DS	-	-	11-13-13-35	1.65V	•	•
G.SKILL	F3-2800C11Q-16GTXD	16GB (4x4GB)	DS	-	-	11-13-13-35	1.65V	•	•
G.SKILL	F3-2800C11D-8GTXDG	8GB (2x4GB)	DS	-	-	11-14-14-35	1.65V	•	•
G.SKILL	F3-2800C11Q-16GTXDG	16GB (4x4GB)	DS	-	-	11-13-13-35	1.65V	•	•
G.SKILL	F3-2800C12Q-32GTXG	32GB (4x8GB)	DS	-	-	12-13-13-35	1.65V	•	•
G.SKILL	F3-2800C10D-8GBTXD	8GB (2x4GB)	DS	-	-	10-13-13-35	1.65V	•	•

DDR3 2666 MHz capability

Vendors	Part No.	Size	SS/DS	Chip	Chip NO.	Timing	Voltage	DIMM socket support (Optional)	
								2	4
Apacer	78.BAGFR.AFD0C(XMP)	8GB (2x 4GB)	DS	-	-	12-13-13-35	-	•	•
Apacer	78.CAGFF.AFD0C(XMP)	16GB (2x 8GB)	DS	-	-	12-13-13-35	-	•	•
G.SKILL	F3-2666CL10Q-16GBZHD(XMP)	16GB (4x 4GB)	DS	-	-	10-12-12-31	1.65	•	
GEIL	GOC332GB2666C11QC(XMP)	32GB (4x 8GB)	DS	-	-	11-13-13-32	1.65	•	•
Team	TXD34G2666HC11CBK(XMP)	8GB (2x 4GB)	SS	-	-	11-13-13-35	1.65	•	•
Team	TXD38G2666HC11CBK(XMP)	16GB (2x 8GB)	DS	-	-	11-13-13-35	1.65	•	

DDR3 2400 MHz capability

Vendors	Part No.	Size	SS/DS	Chip Brand	Chip NO.	Timing	Voltage	DIMM socket support (Optional)	
								2	4
CORSAIR	CMGTX8(XMP)	8GB (4x2GB)	SS	-	-	10-12-10-30	1.65	•	•
CORSAIR	CMZ16GX3M2A2400C10 (Ver4.21)	16GB (2x8GB)	DS	-	-	10-12-12-31	1.65	•	•
GEIL	GOC316GB2400C10QC(XMP)	16GB (4x4GB)	DS	-	-	10-11-11-30	1.65	•	•
GEIL	GOC316GB2400C11QC(XMP)	16GB (4x4GB)	DS	-	-	11-11-11-30	1.65	•	•
KINGSTON	KHX24C11K4/16X(XMP)	16GB (4x4GB)	DS	-	-	11-13-13-30	1.65	•	•
KINGSTON	KHX24C11T2K2/8X(XMP)	8GB (2x4GB)	DS	-	-	-	1.65	•	•
Patriot	PXD38G2400C11K(XMP)	8GB (2x4GB)	DS	-	-	2400 11-11-11-30	1.65	•	•

DDR3 2200 MHz capability

Vendors	Part No.	Size	SS/DS	Chip Brand	Chip NO.	Timing	Voltage	DIMM socket support (Optional)	
								2	4
G.SKILL	F3-17600CL7D-4GBFLS(XMP)	4G (2x2GB)	DS	-	-	7-10-10-28	1.65	•	•

DDR3 2133 MHz capability

Vendors	Part No.	Size	SS/DS	Chip Brand	Chip NO.	Timing	Voltage	DIMM socket support (Optional)	
								2	4
A-DATA	AX3U2133XC4G10(XMP)	4GB	DS	-	-	10-11-11-30	1.65	•	•
A-DATA	AX3U2133XW8G10(XMP)	16GB (2x 8GB)	DS	-	-	10-11-11-30	1.65	•	•
Apacer	78.BAGE4.AFD0C(XMP)	8GB (2x 4GB)	DS	-	-	9-9-9-24	-	•	•
Apacer	AHU04GFB33CAQ3R(XMP)	4GB	DS	-	-	11-13-13-31	-	•	•
CORSAIR	CMD8GX3M2A2133C9 (Ver1.5)(XMP)	8GB (2x 4GB)	DS	-	-	9-11-10-27	1.5	•	•
CORSAIR	CMT4GX3M2B2133C9(Ver 7.1)(XMP)	4GB (2x 2GB)	DS	-	-	9-10-9-27	1.5	•	•
G.SKILL	F3-17000CL11Q2-64GBZLD(XMP)	64GB (8x 8GB)	DS	-	-	11-11-11-30	1.5	•	•
G.SKILL	F3-2133C11Q-32GZL(XMP)	32GB (4x 8GB)	DS	-	-	11-11-11-31	1.5	•	•
KINGSTON	KHX2133C11D3K4/16GX(XMP)	16GB (4x 4GB)	DS	-	-	11-12-11-30	1.65	•	•
KINGSTON	KHX21C11T3FK8/64X(XMP)	64GB (8x 8GB)	DS	-	-	9-9-9-24	1.5	•	•
Patriot	PXD38G2133C11K(XMP)	8GB (2x 4GB)	DS	-	-	2133 11-11-11-27	1.5	•	•
Team	TLD38G2133HC11ABK(XMP)	8GB	DS	-	-	11-11-11-31	1.65	•	•
Team	TXD34096M2133HC11A-V(XMP)	4GB	DS	-	-	11-11-11-31	1.65	•	•

DDR3 2000 MHz capability

Vendors	Part No.	Size	SS/DS	Chip Brand	Chip NO.	Timing	Voltage	DIMM socket support (Optional)	
								2	4
Patriot	PV736G2000ELK(XMP)	6GB (3x2GB)	DS	-	-	7-7-7-20	1.65	•	•
Silicon Power	SP002GBLYU200S02(XMP)	2GB	DS	-	-	-	-	•	•
Team	TXD32048M2000C9(XMP)	2GB	DS	Team	T3D1288RT-20	9-9-9-24	1.5	•	•
Team	TXD32048M2000C9-L(XMP)	2GB	DS	Team	T3D1288RT-20	9-9-9-24	1.6	•	•

DDR3 1866 MHz capability

Vendors	Part No.	Size	SS/DS	Chip Brand	Chip NO.	Timing	Voltage	DIMM socket support (Optional)	
								2	4
A-DATA	AX3U1866XW8G10(XMP)	16GB (2x8GB)	DS	-	-	10-11-10-30	1.5	•	•
CORSAIR	CMD16GX3M4A1866C9 (Ver4.13)(XMP)	16GB (4x4GB)	DS	-	-	9-10-9-27	1.5	•	•
G.SKILL	F3-14900CL9Q-16GBXL(XMP)	16GB (4x4GB)	DS	-	-	9-10-9-28	1.5	•	•
G.SKILL	F3-14900CL9Q-16GBZL(XMP)	16GB (4x4GB)	DS	-	-	9-10-9-28	1.5	•	•
Patriot	PXD34G1866ELK(XMP)	4GB (2x2GB)	SS	-	-	9-9-9-24	1.65	•	
Patriot	PXD38G1866ELK(XMP)	8GB (2x4GB)	DS	-	-	9-11-9-27	1.65	•	•
Team	TLD34G1866HC9KBK(XMP)	4GB	DS	-	-	9-11-9-27	1.5	•	
Team	TLD38G1866HC10SBK(XMP)	8GB	DS	-	-	10-11-10-30	1.5	•	

DDR3 1800 MHz capability

Vendors	Part No.	Size	SS/DS	Chip Brand	Chip NO.	Timing	Voltage	DIMM socket support (Optional)	
								2	4
G.SKILL	F3-14400CL9D-4GBRL(XMP)	4GB (2x2GB)	DS	-	-	9-9-9-24	1.6	•	•

DDR3 1600 MHz capability

Vendors	Part No.	Size	SS/DS	Chip Brand	Chip NO.	Timing	Voltage	DIMM socket support (Optional)	
								2	4
A-DATA	AD3U1600C4G11	4GB	DS	MICRON	D9PFJ	11-11-11-28	-	•	•
A-DATA	AD3U1600W4G11	4GB	SS	A-DATA	3WCD-1211A	11-11-11-28	-	•	•
A-DATA	AD3U1600W8G11	8GB	DS	A-DATA	3WCD-1211A	11-11-11-28	-	•	•
A-DATA	AX3U1600W8G11	16GB (2x8GB)	DS	-	-	9-11-9-27	1.5	•	•
A-DATA	AXDU1600GW8G9B(XMP)	16GB (2x8GB)	DS	-	-	9-11-9-27	1.65	•	•
AMD	AE32G1609U1-U	2GB	SS	AMD	23EY4587M86H	-	1.5	•	•
Apacer	78.B1GET.9K00C	4GB	SS	Apacer	AM5D6008BQQSCK	11-11-11-28	-	•	•
Apacer	78.C1GET.9K10C	8GB	DS	Apacer	AM5D6008BQQSCK	11-11-11-31	-	•	•
Apacer	AHU08GFA60CB T3R(XMP)	8GB	DS	-	-	9-9-9-24	-	•	•
Asint	SLA302G08-EGJ1C(XMP)	4GB	DS	Asint	302G08-GJ1C	9-9-9-27	-	•	•
Asint	SLA304G08-ENG1B	4GB	SS	Asint	304G08-GN1B	9-11-11-28	-	•	•
Asint	SLZ302G08-EGN1C	2GB	SS	ASint	302G08-GN1C	-	-	•	•
ATP	AQ12M64B8BK0S	4GB	DS	SAMSUNG	K4B2G08460	-	NO	•	•
CORSAIR	CMG4GX3M2A1600C6	4GB (2x2GB)	DS	-	-	6-6-6-18	1.65	•	•
Crucial	BL12864BN1608.8FF(XMP)	2GB (2x1GB)	SS	-	-	8-8-8-24	1.65	•	•
Crucial	BLT4G3D1608DT1 TX0.16FM(XMP)	4GB	DS	-	-	8-8-8-24	1.5	•	•
EK Memory	EKM324L28BP8-116(XMP)	4GB (2x2GB)	DS	-	-	9	-	•	•
EK Memory	EKM324L28BP8-116(XMP)	4GB (2x2GB)	DS	-	-	9	-	•	•
Elixir	M2X2G64CB88G7N-DG(XMP)	2GB	SS	Elixir	N2CB2G80GN-DG	9-9-9-28	-	•	•
Elixir	M2X4G64CB88G5N-DG(XMP)	4GB	DS	Elixir	N2CB2G80GN-DG	9-9-9-28	-	•	•
G.SKILL	F3-12800CL9D-8GBRL(XMP)	8GB (2x4GB)	DS	-	-	9-9-9-24	1.5	•	•
G.SKILL	F3-12800CL9D-8GBSR2(XMP)	8GB (2x4GB)	DS	-	-	9-9-9-24	1.25	•	•
G.SKILL	F3-12800CL9Q-16GBXL(XMP)	16GB (4x4GB)	DS	-	-	9-9-9-24	1.5	•	•
G.SKILL	F3-1600C9Q-32GX(XMP)	32GB (4x8GB)	DS	-	-	-	1.5	•	•
GEIL	GET316GB1600C9QC(XMP)	16GB (4x4GB)	DS	-	-	9-9-9-28	1.6	•	•
GEIL	GUP34GB1600C7DC(XMP)	4GB (2x2GB)	DS	-	-	7-7-7-24	1.6	•	•
GoodRam	GR1600D364L9/2G	2GB	DS	GoodRam	GF1008KC-JN	-	-	•	•
KINGSTON	KHX1600C9D3K3/12GX(XMP)	12GB (3x4GB)	DS	-	-	9	1.65	•	•

(continued on the next page)

DDR3 1600 MHz capability

Vendors	Part No.	Size	SS/DS	Chip Brand	Chip NO.	Timing	Voltage	DIMM socket support (Optional)	
								2	4
KINGSTON	KHX1600C9D3K3/6GX(XMP)	6GB (3x2GB)	DS	-	-	9	1.65	•	•
KINGSTON	KHX1600C9D3P1K2/8G	8GB (2x4GB)	DS	-	-	9	1.5	•	•
KINGTIGER	KTG2G1600PG3(XMP)	2GB	DS	-	-	-	-	•	•
MICRON	MT16JTF1G64AZ-1G6D1	8GB	DS	MICRON	D9PBC	-	1.5	•	•
MICRON	MT8KTF25664AZ-1G6M1	2GB	SS	MICRON	D9PFJ	-	-	•	•
Mushkin	996805(XMP)	4GB (2x2GB)	DS	-	-	6-8-6-24	1.65	•	•
Mushkin	998805(XMP)	6GB (3x2GB)	DS	-	-	6-8-6-24	1.65	•	•
Patriot	PX7312G1600LLK(XMP)	12GB (3x4GB)	DS	-	-	8-9-8-24	1.65	•	
PSC	AL9F8L93B-GN2E	4GB	SS	PSC	A3P4GF3BLF	-	-	•	•
PSC	ALAF8L93B-GN2E	8GB	DS	PSC	A3P4GF3BLF	-	-	•	•
SanMax	SMD-4G68HP-16KZ	4GB	DS	Hynix	H5TQ2G83BFRPBC	-	1.5	•	•
SanMax	SMD-4G68NG-16KK	4GB	DS	ELPIDA	J2108BDBG-GN-F	-	-	•	•
Silicon Power	SP002GBLTU160V02(XMP)	2GB	SS	S-POWER	20YT5NG	9-11-11-28	1.5	•	•
Silicon Power	SP004GBLTU160V02(XMP)	4GB	DS	S-POWER	20YT5NG	9-9-9-24	1.5	•	
Team	TXD34096M1600HC9-D(XMP)	4GB	DS	Hynix	H5TC2G83BFRH9A	9-9-9-24	1.5	•	•
Transcend	JM1600KLH-8G(626633)	8GB	DS	Transcend	TK963EBF3	-	-	•	•
Transcend	TS1GLK64V6H(620945)	8GB	DS	SAMSUNG	K4B4G0846B	-	-	•	•

DDR3 1333 MHz capability

Vendors	Part No.	Size	SS/ DS	Chip Brand	Chip NO.	Timing	Voltage	DIMM socket support (Optional)	
								2	4
ACTICA	ACT4GHU64B8H1333H	4GB	DS	Hynix	H5TQ2G83AFR	-	-	•	•
ACTICA	ACT4GHU72D8H1333H	4GB	DS	Hynix	H5TQ2G83AFR(ECC)	-	-	•	•
AMD	AE32G1339U1-U	2GB	SS	AMD	23EY4587MB3H	-	1.5	•	•
AMD	AE34G1339U2-U	4GB	DS	AMD	23EY4587MB3H	-	1.5	•	•
Apacer	78.A1GC6.9L1	2GB	DS	Apacer	AM5D5808FEQSBG	9	-	•	•
Apacer	78.B1GDE.9L10C	4GB	DS	Apacer	AM5D5908CEHSBG	9	-	•	•
Asint	SLA304G08-EDJ1B	4GB	SS	Asint	304G08-DJ1B	9-10-10-26	-	•	•
Asint	SLB304G08-EDJ1B	8GB	DS	Asint	304G08-DJ1B	9-9-9-24	-	•	•
ATP	AQ12M72E8BKH9S	4GB	DS	SAMSUNG	K4B2G0846C(ECC)	-	-	•	•
BUFFALO	D3U1333-2G	2GB	DS	Elpida	J1108BFBG-DJ-F	-	-	•	•
BUFFALO	D3U1333-4G	4GB	DS	NANYA	NT5CB256M8BN-CG	-	-	•	•
CORSAIR	CMV8GX3M2A1333C9	8GB (2x 4GB)	DS	-	N/A	9-9-9-24	-	•	•
EK Memory	EKM324L28BP8-113	4GB (2x 2GB)	DS	-	-	9	-	•	•
G.SKILL	F3-10600CL9D-4GBNT	4GB (2x 2GB)	DS	G.SKILL	D3 128M8CE9 2GB	9-9-9-24	1.5	•	•
G.SKILL	F3-10666CL9D-8GBXL	8GB (2x 4GB)	DS	-	-	9-9-9-24	1.5	•	•
GEIL	GVP34GB1333C9DC	4GB (2x 2GB)	DS	-	-	9-9-9-24	1.5	•	•
GEIL	GVP38GB1333C9DC	8GB (2x 4GB)	DS	-	-	9-9-9-24	1.5	•	•
GoodRam	GR1333D364L9/2G	2GB	DS	Qimonda	IDS1H1G-03A1F1C-13H	-	-	•	•
Hynix	HMT125U6TFR8A-H9	2GB	DS	Hynix	H5TC1G83TFR	-	-	•	•
INNODISK	M3UN-2GHJBC09	2GB	SS	Hynix	H5TQ2G83CFRH9C	9-9-9-24	-	•	•
INNODISK	M3UN-4GHJAC09	4GB	DS	Hynix	H5TQ2G83CFRH9C	9-9-9-24	-	•	•
KINGMAX	FLFE85F-C8KL9	2GB	SS	KINGMAX	KFC8FNLXF-DXX-15A	-	-	•	•
KINGMAX	FLFF65F-C8KL9	4GB	DS	KINGMAX	KFC8FNLXF-DXX-15A	-	-	•	•
KINGSTON	KVR1333D3N9H/4G	4GB	DS	ELPIDA	J2108BDBG-GN-F	-	1.5	•	•
KINGSTON	KVR13N9S8H/4	4GB	SS	ELPIDA	J4208BBBG-GN-F	-	1.5	•	•
KINGTIGER	F10DA2T1680	2GB	DS	KINGTIGER	KTG1333PS1208NST-C9	-	-	•	•
KINGTIGER	KTG2G1333PG3	2GB	DS	-	-	-	-	•	•

(continued on the next page)

Vendors	Part No.	Size	SS/ DS	Chip Brand	Chip NO.	Timing	Voltage	DIMM socket support (Optional)	
								2	4
Mach Xtreme	MXD3U133316GQ	16GB (4x 4GB)	DS	-	-	-	-	•	•
Mach Xtreme	MXD3V13332GS	2GB	SS	Mach Xtreme	C2S46D30-D313	-	-	•	•
MICRON	MT&JTF25664AZ-1G4M1	2GB	SS	MICRON	D9PFJ	-	-	•	•
OCZ	OCZ3G1333LV4GK	4GB (2x 2GB)	DS	-	-	9-9-9	1.65	•	
OCZ	OCZ3G1333LV8GK	8GB (2x 4GB)	DS	-	-	9-9-9	1.65	•	
Patriot	PG38G1333EL(XMP)	8GB	DS	-	-	-	1.5	•	•
Patriot	PGD316G1333ELK(XMP)	16GB (2x 8GB)	DS	-	-	9-9-9-24	1.5	•	•
RiDATA	C304627CB1AG22Fe	2GB	DS	RiDATA	C304627CB1AG22Fe	9	-	•	•
RiDATA	E304459CB1AG32Cf	4GB	DS	RiDATA	E304459CB1AG32Cf	9	-	•	•
SAMSUNG	M378B5273CH0-CH9	4GB	DS	SAMSUNG	K4B2G0846C	-	-	•	•
Silicon Power	SP002GBLTU133V02	2GB	SS	S-POWER	20YT3NG	9-9-9-24	-	•	•
Silicon Power	SP004GBLTU133V02	4GB	DS	S-POWER	20YT3NG	9-9-9-24	-	•	•
Team	TED34096M1333HC9	4GB	DS	Team	T3D2568LT-13	-	-	•	•
Transcend	JM1333KLH-8G(623654)	8GB	DS	Transcend	TK963EBF3	-	-	•	•
Transcend	TS1GLK64V3H(620053)	8GB	DS	MICRON	D9QBJ	-	-	•	•



- Side(s): SS - Single-sided DS - Double-sided DIMMs

- DIMM socket support:

- 1 Supports one (1) module inserted into any slot as Single-channel memory configuration. We suggest that you install the module into A1 slot.
- 2 Supports two (2) modules inserted into either the red slots or the black slots as one pair of Dual-channel memory configuration. We suggest that you install the modules into slots A1 and B1 for better compatibility.
- 4 Supports four (4) modules inserted into both the red and black slots as two pairs of Dual-channel memory configuration.



- ASUS exclusively provides hyper DIMM support function.
- Hyper DIMM support is subject to the physical characteristics of individual CPUs. Load the X.M.P. settings in the BIOS for the hyper DIMM support.
- Visit the ASUS website for the latest QVL.

1.2.5 Expansion slots



Unplug the power cord before adding or removing expansion cards. Failure to do so may cause you physical injury and damage motherboard components.

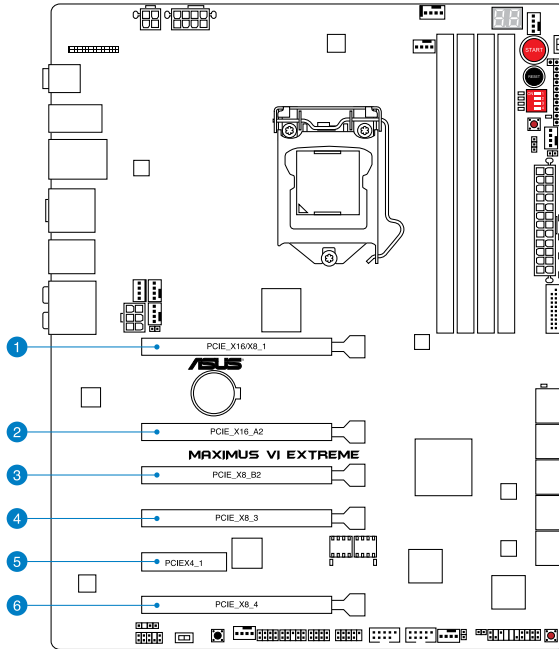

Slot No.	Slot Description
1	PCIe 3.0/2.0 x16/x8_1 slot
2	PCIe 3.0/2.0 x16_A2 slot
3	PCIe 3.0/2.0 x8_B2 slot
4	PCIe 3.0/2.0 x8_3 slot
5	PCIe 2.0/1.1 x4_1 slot
6	PCIe 3.0/2.0 x8_4 slot

VGA Configuration	PCIe 3.0 operating mode			
	Single VGA	SLI/ CrossFireX	3-WAY SLI/ CrossFireX	4-WAY SLI/ CrossfireX
PCIe 3.0/2.0_x16/x8_1	x16 (Native)	x8 (Native)	x8 (Native)	x8 (Native)
PCIe 3.0/2.0_x16_A2	–	–	x16	x16
PCIe 3.0/2.0_x8_B2	–	x8 (Native)	–	–
PCIe 3.0/2.0_x8_3	–	–	x8	x8
PCIe 3.0/2.0_x8_4	–	–	–	x8



- We recommend that you provide sufficient power when running CrossFireX™ or SLI® mode.
- Connect a chassis fan to the motherboard connector labeled CHA_FAN1-3 when using multiple graphics cards for better thermal environment.
- 4th generation Intel® Core™ processors support PCIe 3.0 speed rate.



- When the system is running with four VGA cards, ensure to connect the EZ PLUG_1/2 for extra PCIe power supply.
- PCIe 3.0/2.0_x16/x8_1 slot switches to x8 mode when other PCIe 3.0/2.0 slots are occupied.
- PCIe 3.0/2.0_x8_B2 slot will be disabled when PCIe 3.0/2.0_x16_A2, PCIe 3.0/2.0_x8_3, PCIe 3.0/2.0_x8_4 slots are occupied.

IRQ assignments for this motherboard

	A	B	C	D	E	F	G	H
PCIE_x16/x8_1	shared	-	-	-	-	-	-	-
PCIE_x8_B2	-	shared	-	-	-	-	-	-
PCIE_x4_1	shared	-	-	-	-	-	-	-
I.G.F.X.	shared	-	-	-	-	-	-	-
Intel LAN Controller	-	-	-	-	shared	-	-	-
SATA #0	-	-	-	shared	-	-	-	-
SATA #1	-	-	-	shared	-	-	-	-
High Definition Audio	-	-	-	-	-	-	shared	-
EHCI# 0 (USB 2.0)	-	-	-	-	-	-	-	shared
EHCI# 1 (USB 2.0)	-	-	-	-	shared	-	-	-
XHCI (USB 3.0)	-	-	-	-	-	shared	-	-

1.2.6 Onboard buttons and switches

Onboard switches and buttons allow you to fine-tune performance when working on a bare or open-case system. This is ideal for overclockers and gamers who continually change settings to enhance system performance.

1. Power-on button

The motherboard comes with a power-on button that allows you to power up or wake up the system. The button also lights up when the system is plugged to a power source indicating that you should shut down the system and unplug the power cable before removing or installing any motherboard component.

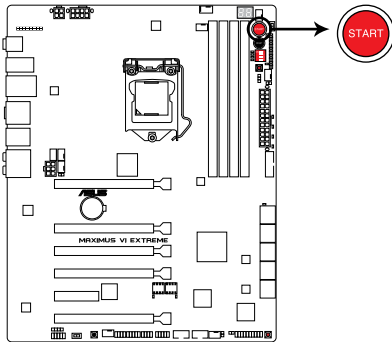

MAXIMUS VI EXTREME Power on button

2. Reset button

Press the reset button to reboot the system.

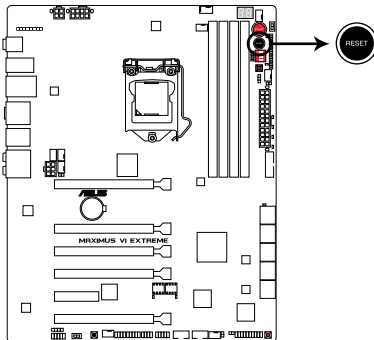

MAXIMUS VI EXTREME Reset button

3. MemOK! button

Installing DIMMs that are not compatible with the motherboard may cause system boot failure, and the DRAM_LED lights continuously. Press and hold the MemOK! button until the MEMOK_LED starts blinking to begin automatic memory compatibility tuning for successful boot.

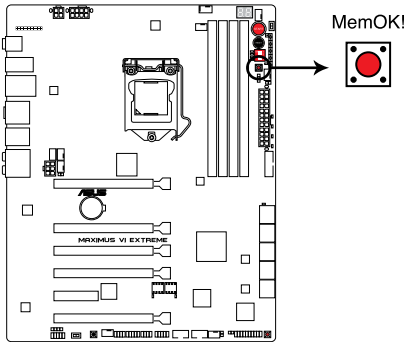

MAXIMUS VI EXTREME MemOK! button



- Refer to section **1.2.8 Onboard LEDs** for the exact location of the MEMOK_LED and DRAM_LED.
- The DRAM_LED also lights up when the DIMM is not properly installed. Turn off the system and reinstall the DIMM before using the MemOK! function.
- The MemOK! switch does not function under Windows® OS environment.
- During the tuning process, the system loads and tests failsafe memory settings. It takes about 30 seconds for the system to test one set of failsafe settings. If the test fails, the system reboots and test the next set of failsafe settings. The blinking speed of the MEMOK_LED increases, indicating different test processes.
- Due to memory tuning requirement, the system automatically reboots when each timing set is tested. If the installed DIMMs still fail to boot after the whole tuning process, the DRAM_LED lights continuously. Replace the DIMMs with ones recommended in the Memory QVL (Qualified Vendors Lists) in this user manual or on the ASUS website at www.asus.com.
- If you turn off the computer and replace DIMMs during the tuning process, the system continues memory tuning after turning on the computer. To stop memory tuning, turn off the computer and unplug the power cord for about 5–10 seconds.
- If your system fails to boot up due to BIOS overlocking, press the MemOK! switch to boot and load the BIOS default settings. A message will appear during POST reminding you that the BIOS has been restored to its default settings.
- We recommend that you download and update to the latest BIOS version from the ASUS website at www.asus.com after using the MemOK! function.

4. BIOS Switch button

The motherboard comes with two BIOS. Press the BIOS button to switch BIOS and load different BIOS settings. The nearby BIOS LEDs indicate the BIOS you are using.

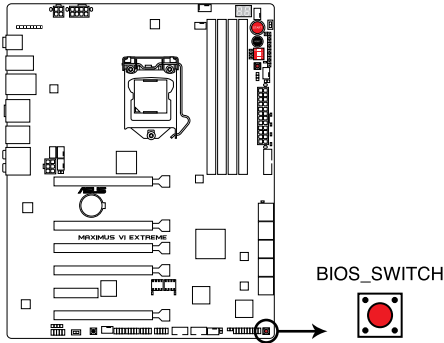

MAXIMUS VI EXTREME BIOS Switch button

5. Slow Mode switch

Slow Mode switch allows your system to provide better overclocking margins when using the LN2 cooling system. When enabled, the Slow Mode switch prevents the system from crashing, slows down the CPU, and the system's tuner will make the adjustments.

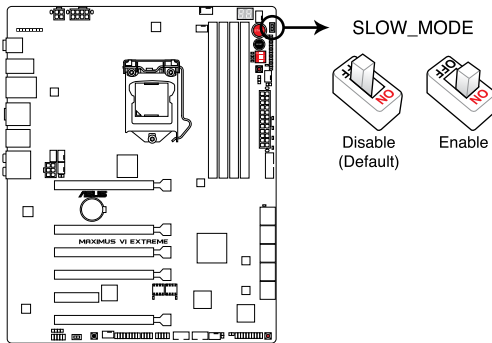

MAXIMUS VI EXTREME Slow Mode switch



Ensure to set the LN2 Mode jumper to [Enable] before using the Slow Mode Switch.

6. PCIe x16 Lane switch

This DIP switch allows you to enable and disable the corresponding PCIe x16 slots. When one of the installed PCIe x16 cards is out of order, you can slide the switch to find out the faulty one without removing the cards.

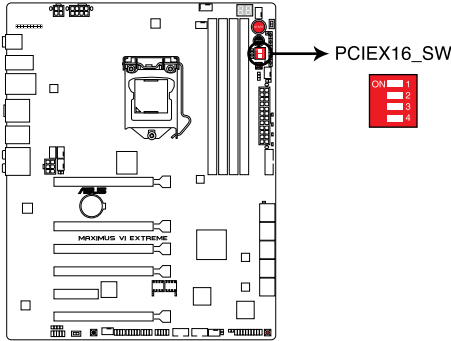

MAXIMUS VI EXTREME PCIe x16 Lane switch

7. Fast Boot switch

This switch allows you to enable or disable the Fast Boot feature. When enabled, the system boot speed is accelerated.

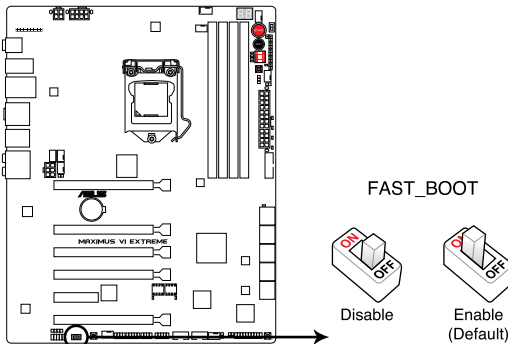

MAXIMUS VI EXTREME FAST_BOOT switch

8. DirectKey button

This feature allows your system to go to the BIOS Setup program with the press of a button. With DirectKey, you can enter the BIOS anytime without having to press the key during POST. It also allows you to turn on or turn off your system and conveniently enter the BIOS during boot-up.

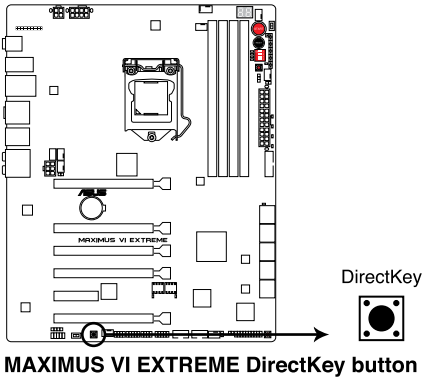

Ensure to save your data before using the DirectKey button.

- When the system is on and you press the DirectKey button, your system will shut down. Press the DirectKey button again or the Power-on button to reboot and enter the BIOS directly.
 - Turn off your system using the power-on button to allow your system to go through POST (without entering the BIOS) when you reboot your system.
 - Refer to section **3.8 Boot Menu** for details about setting the DirectKey default function.
-

1.2.7 Jumpers

1. LN2 Mode jumper (3-pin LN2_MODE)

When enabled, the LN2 Mode jumper allows your system to eliminate the cold bug* in the processor during POST. It allows the processor to run at an extremely low temperature and helps the system boot fast.

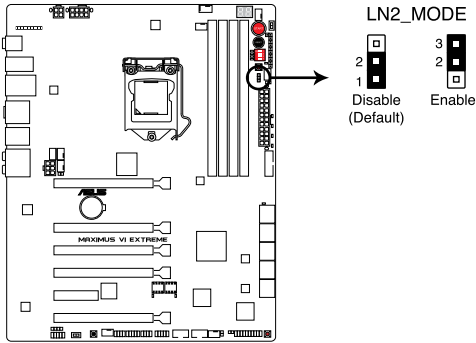

MAXIMUS VI EXTREME LN2_MODE



* The cold bug is an issue with CPUs that causes to fail to boot at low (usually sub zero) temperatures.

1.2.8 Onboard LEDs

1. Hard Disk LED

The hard disk LED is designed to indicate the hard disk activity. It blinks when data is being written into or read from the hard disk drive. The LED does not light up when there is no hard disk drive connected to the motherboard or when the hard disk drive does not function.

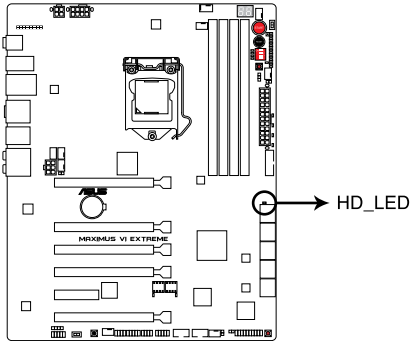

MAXIMUS VI EXTREME Hard Disk LED

2. MemOK! LED

Blinking: Indicates that MemOK! is enabled before POST.

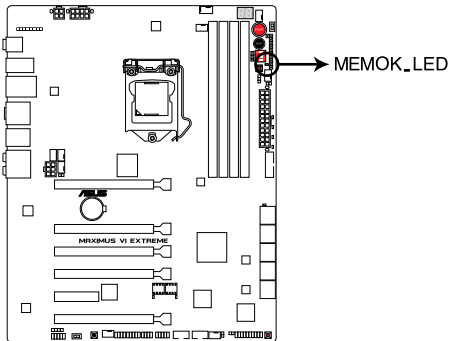

MAXIMUS VI EXTREME MemOK! LED

3. Q LED

Q LEDs check key components (CPU, DRAM, VGA card, and booting devices) in sequence during motherboard booting process. If an error is found, the corresponding LED will continue lighting until the problem is solved. This user-friendly design provides an intuitive way to locate the root problem within seconds.

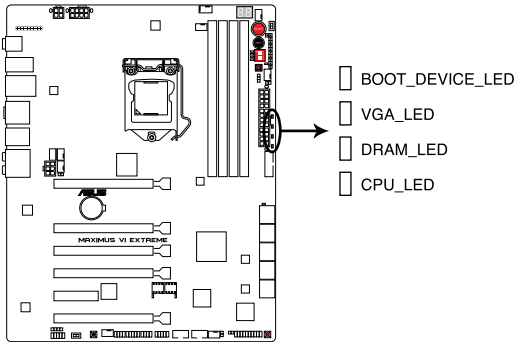

**MAXIMUS VI EXTREME CPU/ DRAM/
VGA/ BOOT_DEVICE LED**

4. Power LED

The motherboard comes with a power-on button that lights up to indicate that the system is ON, in sleep mode, or in soft-off mode. This is a reminder that you should shut down the system and unplug the power cable before removing or plugging in any motherboard component. The illustration below shows the location of the onboard power-on button.

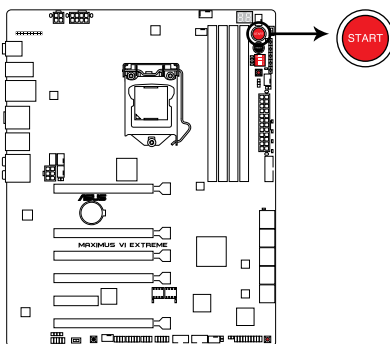

MAXIMUS VI EXTREME Power on button

5. BIOS LED

The BIOS LEDs help indicate the BIOS activity. Press the BIOS button to switch between BIOS1 and BIOS2 and the LED lights up when the corresponding BIOS is in use.

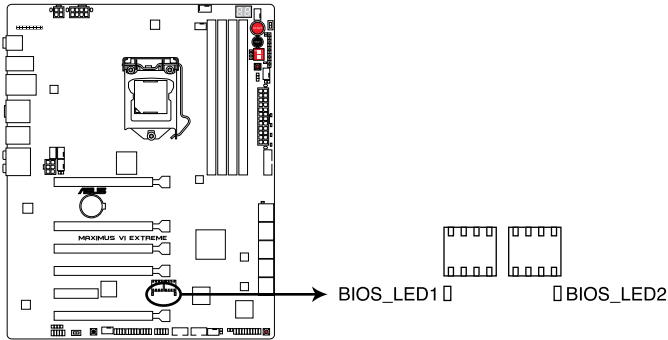

MAXIMUS VI EXTREME BIOS_LED

6. Q-Code LEDs

The Q-Code LED design provides you with a 2-digit error code that displays the system status. Refer to the Q-Code table on the next page for details.

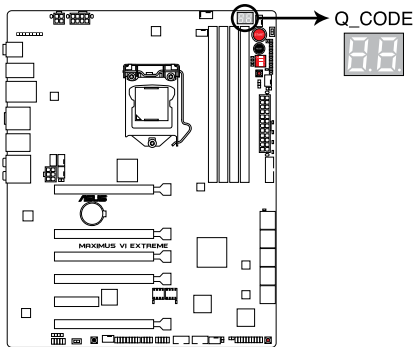

MAXIMUS VI EXTREME Q-Code LED

Q-Code table

Code	Description
00	Not used
01	Power on. Reset type detection (soft/hard).
02	AP initialization before microcode loading
03	System Agent initialization before microcode loading
04	PCH initialization before microcode loading
06	Microcode loading
07	AP initialization after microcode loading
08	System Agent initialization after microcode loading
09	PCH initialization after microcode loading
0B	Cache initialization
0C – 0D	Reserved for future AMI SEC error codes
0E	Microcode not found
0F	Microcode not loaded
10	PEI Core is started
11 – 14	Pre-memory CPU initialization is started
15 – 18	Pre-memory System Agent initialization is started
19 – 1C	Pre-memory PCH initialization is started
2B – 2F	Memory initialization
30	Reserved for ASL (see ASL Status Codes section below)
31	Memory Installed
32 – 36	CPU post-memory initialization
37 – 3A	Post-Memory System Agent initialization is started
3B – 3E	Post-Memory PCH initialization is started
4F	DXE IPL is started

(continued on the next page)

Q-Code table

Code	Description
50 – 53	Memory initialization error. Invalid memory type or incompatible memory speed
54	Unspecified memory initialization error
55	Memory not installed
56	Invalid CPU type or Speed
57	CPU mismatch
58	CPU self test failed or possible CPU cache error
59	CPU micro-code is not found or micro-code update is failed
00	Not used
01	Power on. Reset type detection (soft/hard).
02	AP initialization before microcode loading
03	System Agent initialization before microcode loading
04	PCH initialization before microcode loading
06	Microcode loading
07	AP initialization after microcode loading
08	System Agent initialization after microcode loading
09	PCH initialization after microcode loading
0B	Cache initialization
0C – 0D	Reserved for future AMI SEC error codes
0E	Microcode not found
0F	Microcode not loaded
10	PEI Core is started
11 – 14	Pre-memory CPU initialization is started
15 – 18	Pre-memory System Agent initialization is started
19 – 1C	Pre-memory PCH initialization is started
2B – 2F	Memory initialization
30	Reserved for ASL (see ASL Status Codes section below)
31	Memory Installed
32 – 36	CPU post-memory initialization
37 – 3A	Post-Memory System Agent initialization is started

(continued on the next page)

Q-Code table

Code	Description
3B – 3E	Post-Memory PCH initialization is started
4F	DXE IPL is started
50 – 53	Memory initialization error. Invalid memory type or incompatible memory speed
54	Unspecified memory initialization error
55	Memory not installed
56	Invalid CPU type or Speed
57	CPU mismatch
58	CPU self test failed or possible CPU cache error
59	CPU micro-code is not found or micro-code update is failed
5A	Internal CPU error
5B	Reset PPI is not available
5C – 5F	Reserved for future AMI error codes
E0	S3 Resume is started (S3 Resume PPI is called by the DXE IPL)
E1	S3 Boot Script execution
E2	Video repost
E3	OS S3 wake vector call
E4 – E7	Reserved for future AMI progress codes
E8	S3 Resume Failed
E9	S3 Resume PPI not Found
EA	S3 Resume Boot Script Error
EB	S3 OS Wake Error
EC – EF	Reserved for future AMI error codes
F0	Recovery condition triggered by firmware (Auto recovery)
F1	Recovery condition triggered by user (Forced recovery)
F2	Recovery process started
F3	Recovery firmware image is found
F4	Recovery firmware image is loaded
F5 – F7	Reserved for future AMI progress codes
F8	Recovery PPI is not available

(continued on the next page)

Q-Code table

Code	Description
F9	Recovery capsule is not found
FA	Invalid recovery capsule
FB – FF	Reserved for future AML error codes
60	DXE Core is started
61	NVRAM initialization
62	Installation of the PCH Runtime Services
63 – 67	CPU DXE initialization is started
68	PCI host bridge initialization
69	System Agent DXE initialization is started
6A	System Agent DXE SMM initialization is started
6B – 6F	System Agent DXE initialization (System Agent module specific)
70	PCH DXE initialization is started
71	PCH DXE SMM initialization is started
72	PCH devices initialization
73 – 77	PCH DXE Initialization (PCH module specific)
78	ACPI module initialization
79	CSM initialization
7A – 7F	Reserved for future AMI DXE codes
90	Boot Device Selection (BDS) phase is started
91	Driver connecting is started
92	PCI Bus initialization is started
93	PCI Bus Hot Plug Controller Initialization
94	PCI Bus Enumeration
95	PCI Bus Request Resources
96	PCI Bus Assign Resources
97	Console Output devices connect
98	Console input devices connect
99	Super IO Initialization
9A	USB initialization is started
9B	USB Reset

(continued on the next page)

Q-Code table

Code	Description
9C	USB Detect
9D	USB Enable
9E – 9F	Reserved for future AMI codes
A0	IDE initialization is started
A1	IDE Reset
A2	IDE Detect
A3	IDE Enable
A4	SCSI initialization is started
A5	SCSI Reset
A6	SCSI Detect
A7	SCSI Enable
A8	Setup Verifying Password
A9	Start of Setup
AA	Reserved for ASL (see ASL Status Codes section below)
AB	Setup Input Wait
AC	Reserved for ASL (see ASL Status Codes section below)
AD	Ready To Boot event
AE	Legacy Boot event
AF	Exit Boot Services event
B0	Runtime Set Virtual Address MAP Begin
B1	Runtime Set Virtual Address MAP End
B2	Legacy Option ROM Initialization
B3	System Reset
B4	USB hot plug
B5	PCI bus hot plug
B6	Clean-up of NVRAM
B7	Configuration Reset (reset of NVRAM settings)
B8– BF	Reserved for future AMI codes
D0	CPU initialization error
D1	System Agent initialization error

(continued on the next page)

Q-Code table

Code	Description
D2	PCH initialization error
D3	Some of the Architectural Protocols are not available
D4	PCI resource allocation error. Out of Resources
D5	No Space for Legacy Option ROM
D6	No Console Output Devices are found
D7	No Console Input Devices are found
D8	Invalid password
D9	Error loading Boot Option (LoadImage returned error)
DA	Boot Option is failed (StartImage returned error)
DB	Flash update is failed
DC	Reset protocol is not available

ACPI/ASL Checkpoints

Code	Description
0x01	System is entering S1 sleep state
0x02	System is entering S2 sleep state
0x03	System is entering S3 sleep state
0x04	System is entering S4 sleep state
0x05	System is entering S5 sleep state
0x10	System is waking up from the S1 sleep state
0x20	System is waking up from the S2 sleep state
0x30	System is waking up from the S3 sleep state
0x40	System is waking up from the S4 sleep state
0xAC	System has transitioned into ACPI mode. Interrupt controller is in PIC mode.
0xAA	System has transitioned into ACPI mode. Interrupt controller is in APIC mode.

1.2.9 Internal connectors

1. Intel® Z87 Serial ATA 6.0 Gb/s connectors (7-pin SATA6G_1-6 [red])

These connectors connect to Serial ATA 6.0 Gb/s hard disk drives via Serial ATA 6.0 Gb/s signal cables.

If you installed Serial ATA hard disk drives, you can create a RAID 0, 1, 5, and 10 configuration with the Intel® Rapid Storage Technology through the onboard Intel® Z87 chipset.

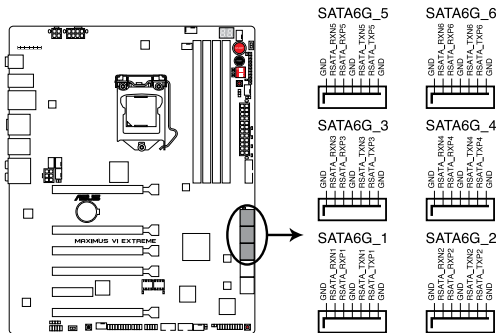

MAXIMUS VI EXTREME Intel® SATA 6.0 Gb/s connectors

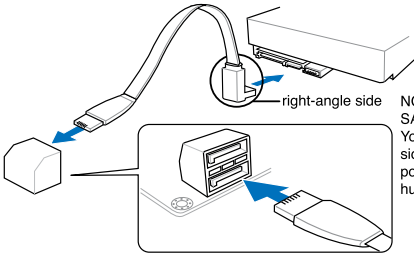

NOTE: Connect the right-angle side of SATA signal cable to SATA device. You may also connect the right-angle side of SATA cable to the onboard SATA port to avoid mechanical conflict with huge graphics cards.



- These connectors are set to **[AHCI Mode]** by default. If you intend to create a Serial ATA RAID set using these connectors, set the SATA Mode item in the BIOS to **[RAID Mode]**. Refer to section **3.6.3 SATA Configuration** for details.
- Before creating a RAID set, refer to section **5.1 RAID configurations** or the manual bundled in the motherboard support DVD.
- Native Command Queuing (NCQ) is a protocol allowing hard disk drives to internally optimize the order in which received read and write commands are executed.
- When using NCQ, set the SATA Mode in the BIOS to **[AHCI Mode]**. Refer to section **3.6.3 SATA Configuration** for details.

3. ASMedia® Serial ATA 6.0 Gb/s connectors (7-pin SATA6G_E12/E34 [red])

These connectors connect to Serial ATA 6.0 Gb/s hard disk drives via Serial ATA 6.0 Gb/s signal cables.

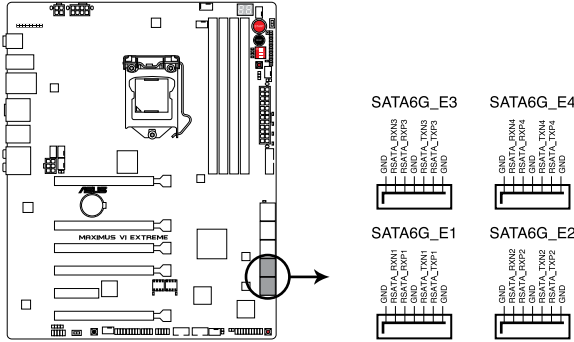

MAXIMUS VI EXTREME ASMedia® SATA 6.0 Gb/s connectors

4. USB 3.0 connector (20-1 pin USB3_12)

This connector allows you to connect a USB 3.0 module for additional USB 3.0 front or rear panel ports. With an installed USB 3.0 module, you can enjoy all the benefits of USB 3.0 including faster data transfer speeds of up to 5Gbps, faster charging time for USB-chargable devices, optimized power efficiency, and backward compatibility with USB 2.0.

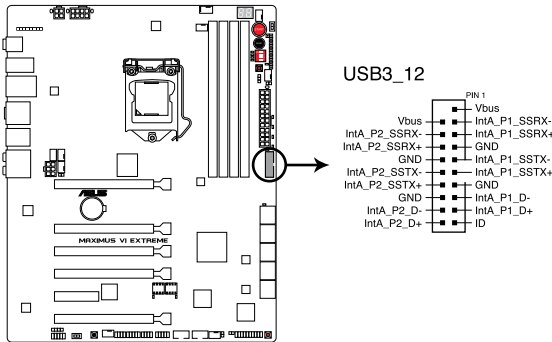

MAXIMUS VI EXTREME USB3.0 connector



- The USB 3.0 module is purchased separately.
- These connectors are based on xHCI specification. We recommend you to install the related driver to fully use the USB 3.0 ports under Windows® 7.

5. Digital audio connector (4-1 pin SPDIF_OUT)

This connector is for an additional Sony/Philips Digital Interface (S/PDIF) port. Connect the S/PDIF Out module cable to this connector, then install the module to a slot opening at the back of the system chassis.

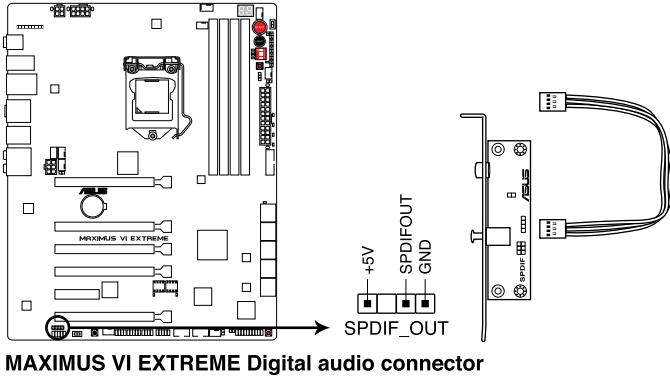

The S/PDIF module is purchased separately.

6. USB 2.0 connectors (10-1 pin USB910; USB1112; USB1314)

These connectors are for USB 2.0 ports. Connect the USB module cable to any of these connectors, then install the module to a slot opening at the back of the system chassis. These USB connectors comply with USB 2.0 specification that supports up to 48 MBps connection speed.

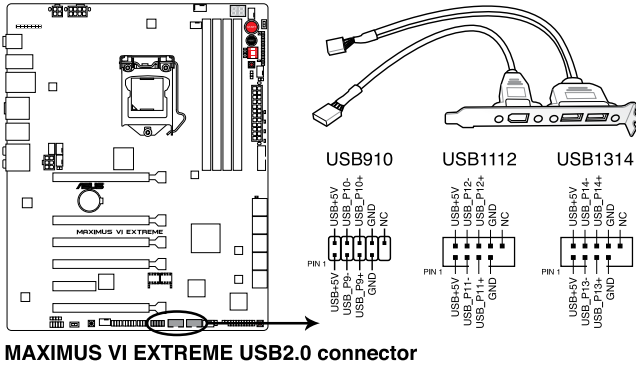

Never connect a 1394 cable to the USB connectors. Doing so will damage the motherboard!



You can connect the front panel USB cable to the ASUS Q-Connector (USB) first, and then install the Q-Connector (USB) to the USB connector onboard if your chassis supports front panel USB ports.

7. CPU, chassis, and optional fan connectors

(4-pin CPU_FAN; 4-pin CPU_OPT; 4-pin CHA_FAN1-3; 4-pin OPT_FAN1-3)

Connect the fan cables to the fan connectors on the motherboard, ensuring that the black wire of each cable matches the ground pin of the connector.

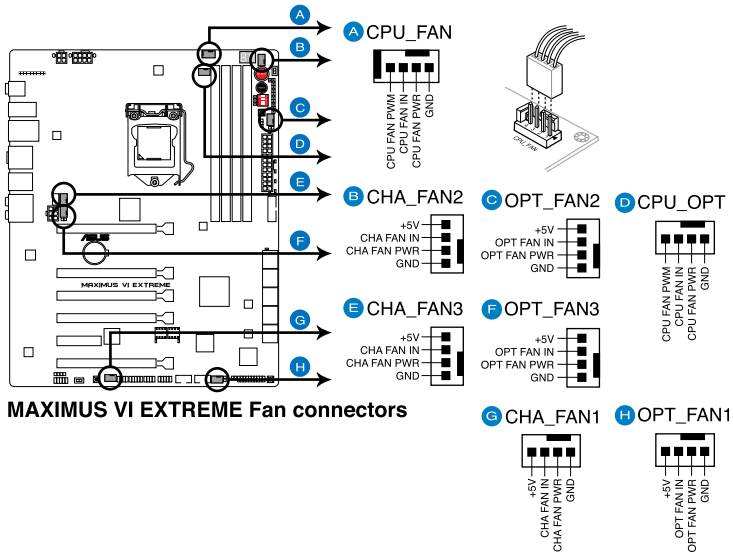

- DO NOT forget to connect the fan cables to the fan connectors. Insufficient air flow inside the system may damage the motherboard components. These are not jumpers! Do not place jumper caps on the fan connectors!
- Ensure to fully insert the 4-pin CPU fan cable to the CPU fan connector.



- The CPU_FAN connector supports the CPU fan of maximum 1A (12 W) fan power.
- The CPU_FAN connector and CHA_FAN connectors support the ASUS FAN Xpert 2 feature.

8. Front panel audio connector (10-1 pin AAFP)

This connector is for a chassis-mounted front panel audio I/O module that supports either HD Audio or legacy AC '97 audio standard. Connect one end of the front panel audio I/O module cable to this connector.

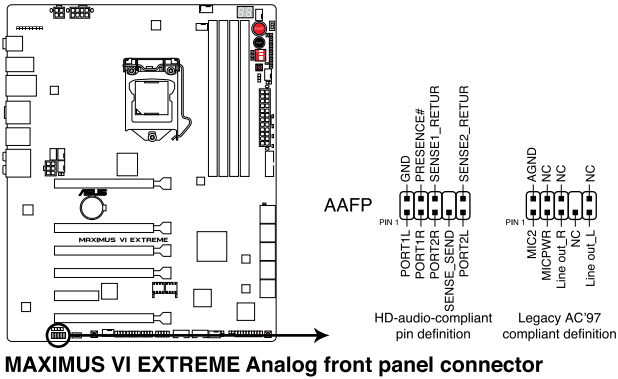

- We recommend that you connect a high-definition front panel audio module to this connector to avail of the motherboard's high-definition audio capability.
- If you want to connect a high-definition or an AC'97 front panel audio module to this connector, set the **Front Panel Type** item in the BIOS setup to **[HD]** or **[AC97]**.

9. **ATX power connectors (24-pin EATXPWR; 8-pin EATX12V_1; 4-pin EATX12V_2)**

These connectors are for ATX power supply plugs. The power supply plugs are designed to fit these connectors in only one orientation. Find the proper orientation and push down firmly until the connectors completely fit.

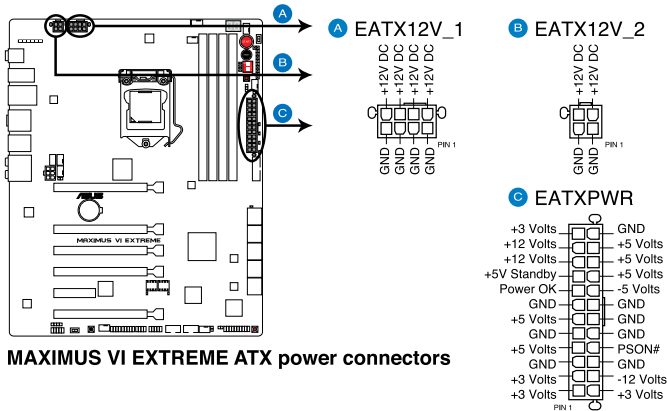

MAXIMUS VI EXTREME ATX power connectors



- For a fully configured system, we recommend that you use a power supply unit (PSU) that complies with ATX 12 V Specification 2.0 (or later version) and provides a minimum power of 350 W.
- Do not forget to connect the 4-pin/8-pin EATX12 V power plug. Otherwise, the system will not boot.
- We recommend that you use a PSU with a higher power output when configuring a system with more power-consuming devices. The system may become unstable or may not boot up if the power is inadequate.
- If you want to use two or more high-end PCI Express x16 cards, use a PSU with 1000W power or above to ensure the system stability.
- If you are uncertain about the minimum power supply requirement for your system, refer to the Recommended Power Supply Wattage Calculator at <http://support.asus.com/PowerSupplyCalculator/PSCalculator.aspx?SLanguage=en-us> for details.

10. System panel connector (20-8 pin PANEL)

This connector supports several chassis-mounted functions.

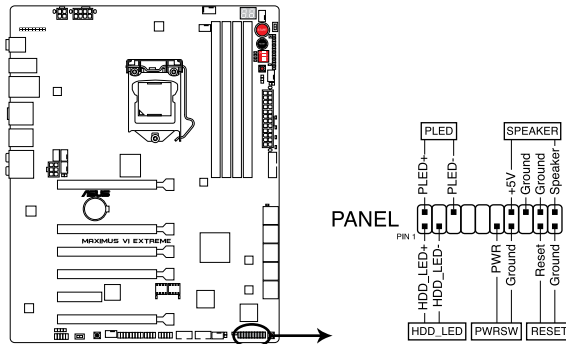

MAXIMUS VI EXTREME System panel connector

- **System power LED (2-pin PLED)**

This 2-pin connector is for the system power LED. Connect the chassis power LED cable to this connector. The system power LED lights up when you turn on the system power, and blinks when the system is in sleep mode.

- **Hard disk drive activity LED (2-pin HDD_LED)**

This 2-pin connector is for the HDD Activity LED. Connect the HDD Activity LED cable to this connector. The HDD LED lights up or flashes when data is read from or written to the HDD.

- **System warning speaker (4-pin SPEAKER)**

This 4-pin connector is for the chassis-mounted system warning speaker. The speaker allows you to hear system beeps and warnings.

- **ATX power button/soft-off button (2-pin PWR SW)**

This connector is for the system power button. Pressing the power button turns the system on or puts the system in sleep or soft-off mode depending on the BIOS settings. Pressing the power switch for more than four seconds while the system is ON turns the system OFF.

- **Reset button (2-pin RESET)**

This 2-pin connector is for the chassis-mounted reset button for system reboot without turning off the system power.

11. EZ Plug connectors (6-pin EZ_PLUG_1; 4-pin EZ_PLUG_2)

These connectors provide additional power to PCIe_x16 slots and back IO ports. Connect a 6-pin power cable to EZ_PLUG_1 when installing multiple display cards to provide sufficient power supply. Connect a 4-pin power cable to EZ_PLUG_2 to provide a stable power supply to the back IO ports.

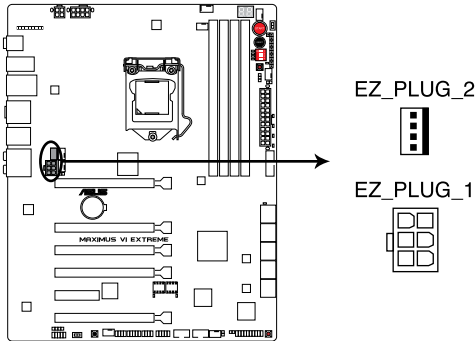

MAXIMUS VI EXTREME EZ Plug connectors

12. Thermal sensor cable connectors (2-pin OPT_TEMP1/2/3)

These connectors are for temperature monitoring. Connect the thermal sensor cables to these connectors and place the other ends to the devices which you want to monitor the temperature. The optional fan 1/2/3 (OPT_FAN1/2/3) can work with the temperature sensors for a better cooling effect.

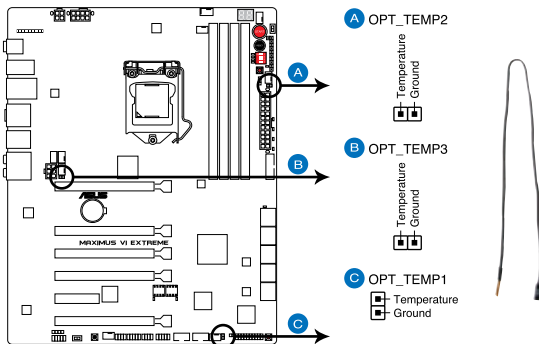

MAXIMUS VI EXTREME Thermal sensor cable connectors



The thermal sensor cables are purchased separately.

13. DirectKey connector (2-pin DRCT)

This connector is for the chassis-mounted button that supports the DirectKey function. Connect the button cable that supports DirectKey, from the chassis to this connector on the motherboard.

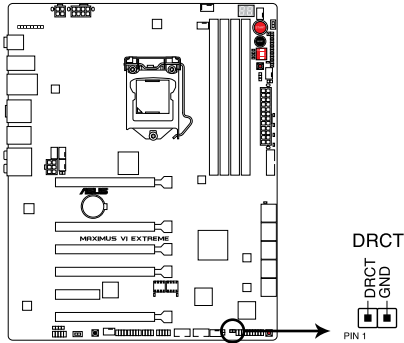

MAXIMUS VI EXTREME DRCT connector



Ensure that your chassis comes with the extra button cable that supports the DirectKey feature. Refer to the technical documentation that came with the chassis for details.

14. mPCIe Combo II connector (36-2 pin MPCIE_COMBO_II)

This connector is for the mPCIe Combo II card offers expandability solutions that also features the M.2 (NGFF) slot for optimal system performance.

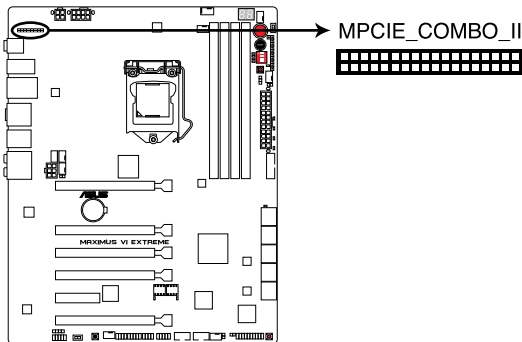

MAXIMUS VI EXTREME MPCIE_COMBO_II connector

15. ROG Extension - OC Panel connector (18-1 pin ROG_EXT)

This connector is for the OC Panel. The OC Panel allows you to perform overclocking without going to the BIOS settings, loading the OS, or using overclocking software utilities.

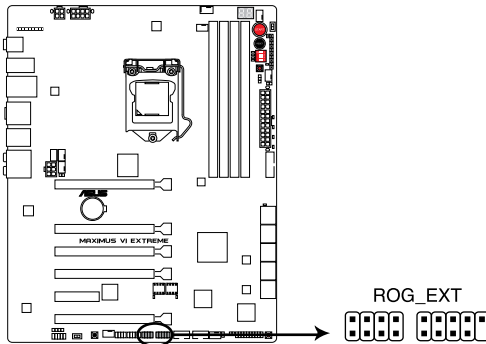

MAXIMUS VI EXTREME OC PANEL connector

1.2.10 Probelt

The ROG Probelt allows you to detect your system's current voltage and OC settings. Use a multimeter to measure the Probelt points even during overclocking.

See the illustration below to locate the respective Probelt points.

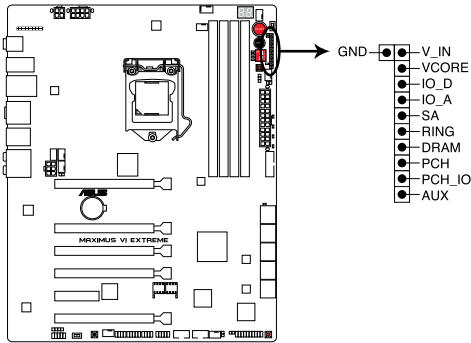

MAXIMUS VI EXTREME Probelt

Using Probelt

You may connect the multimeter to the motherboard as shown on the following figure.

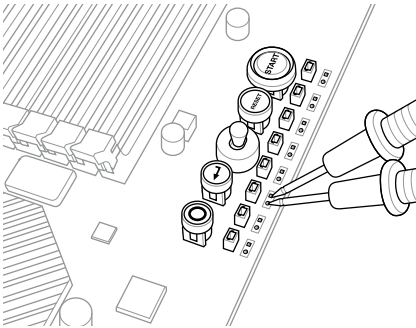

The photos above are for reference only, the actual motherboard layout and measure points location may differ by models.

Basic Installation

2

2.1 Building your PC system

2.1.1 Motherboard installation



The diagrams in this section are for reference only. The motherboard layout may vary with models, but the installation steps are the same for all models.

1. Install the ASUS Q-Shield to the chassis rear I/O panel.

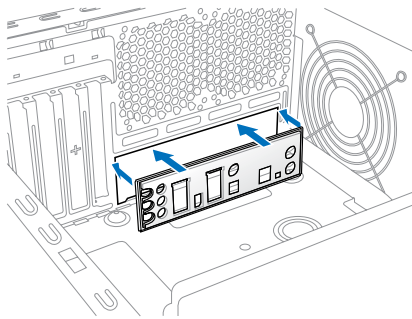

2. Place the motherboard into the chassis, ensuring that its rear I/O ports are aligned to the chassis' rear I/O panel.

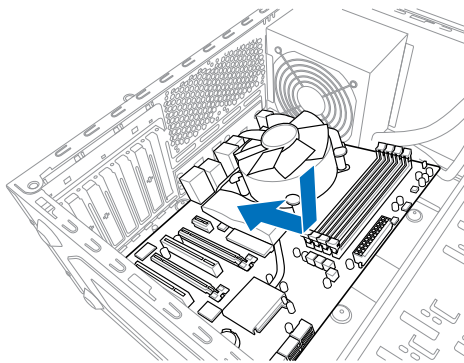

3. Place nine screws into the holes indicated by circles to secure the motherboard to the chassis.

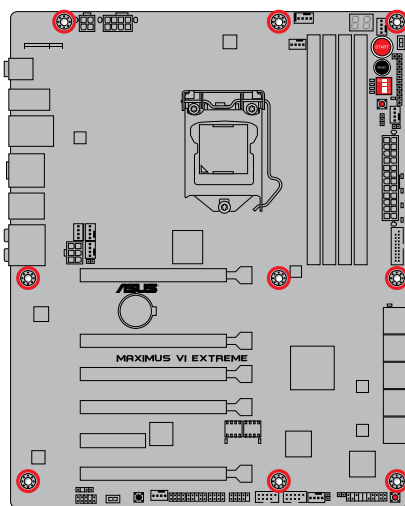
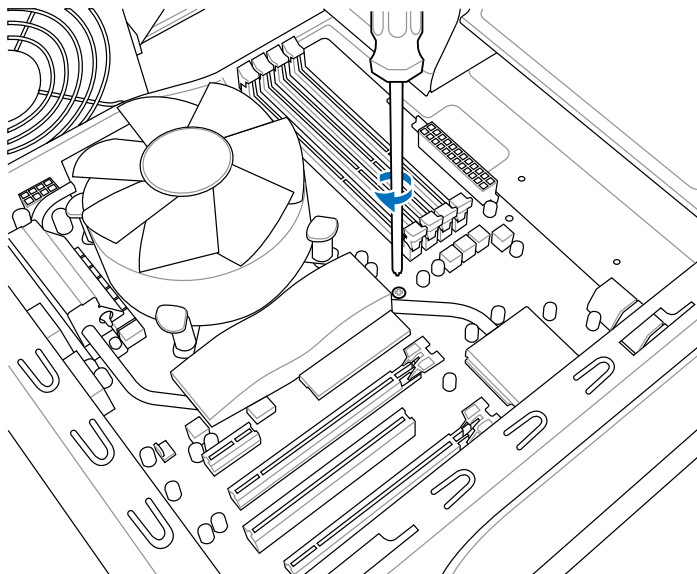

DO NOT overtighten the screws! Doing so can damage the motherboard.

2.1.2 CPU installation



Ensure that you install the correct CPU designed for LGA1150 socket only. DO NOT install a CPU designed for LGA1155 and LGA1156 sockets on the LGA1150 socket.

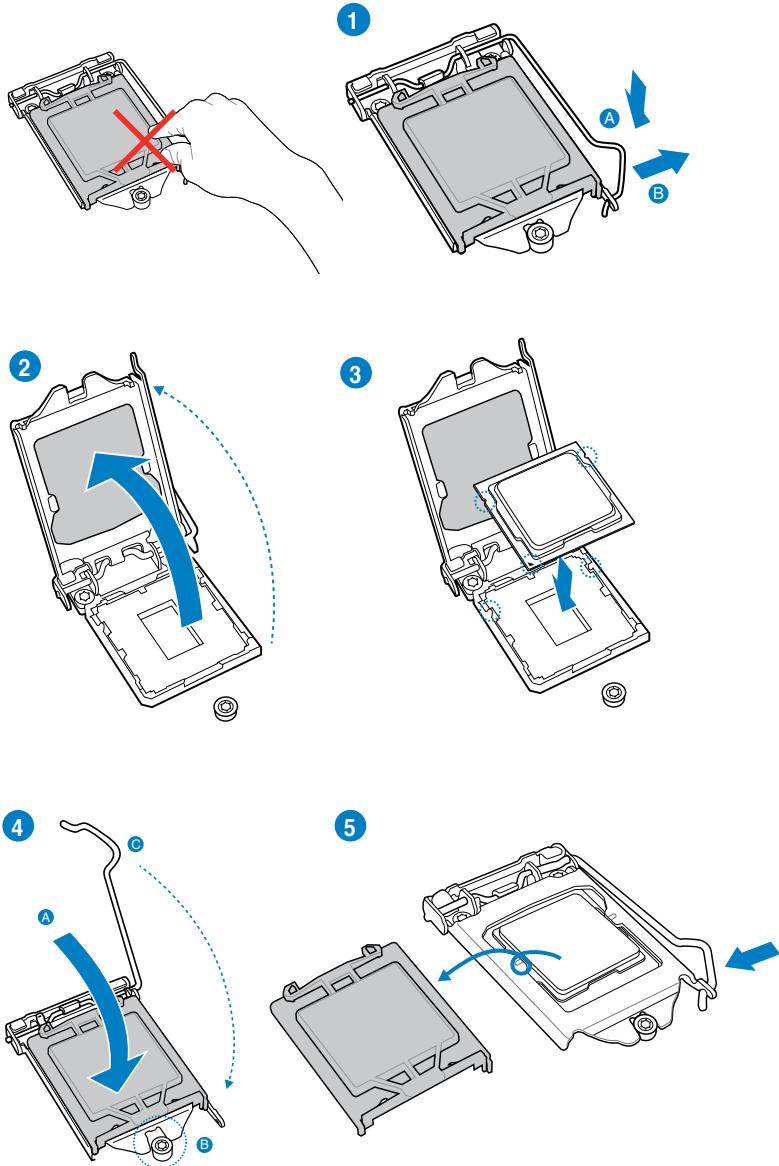

2.1.3 CPU heatsink and fan assembly installation

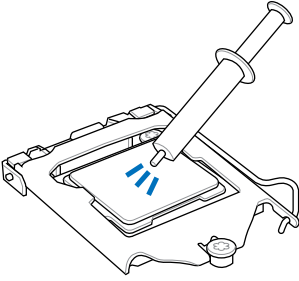

Apply the Thermal Interface Material to the CPU heatsink and CPU before you install the heatsink and fan if necessary.

To install the CPU heatsink and fan assembly

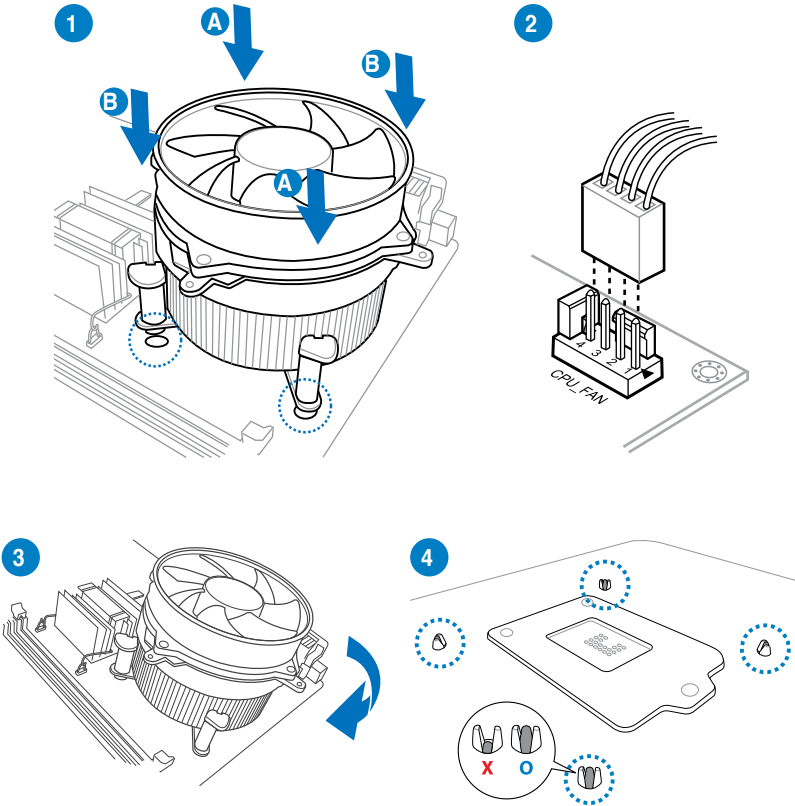

To uninstall the CPU heatsink and fan assembly

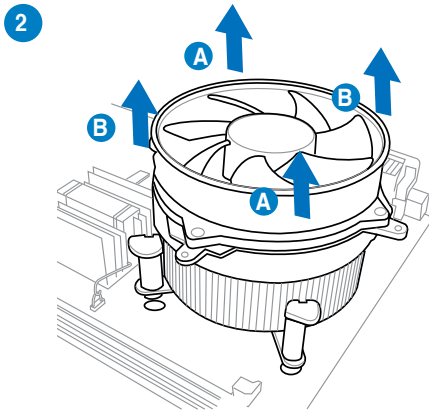
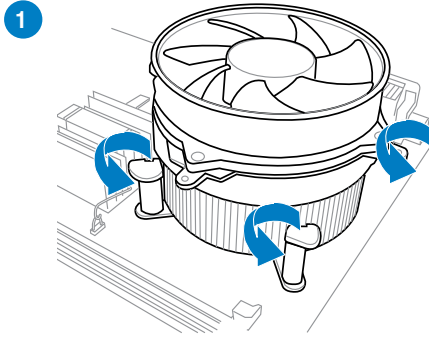

2.1.4 DIMM installation

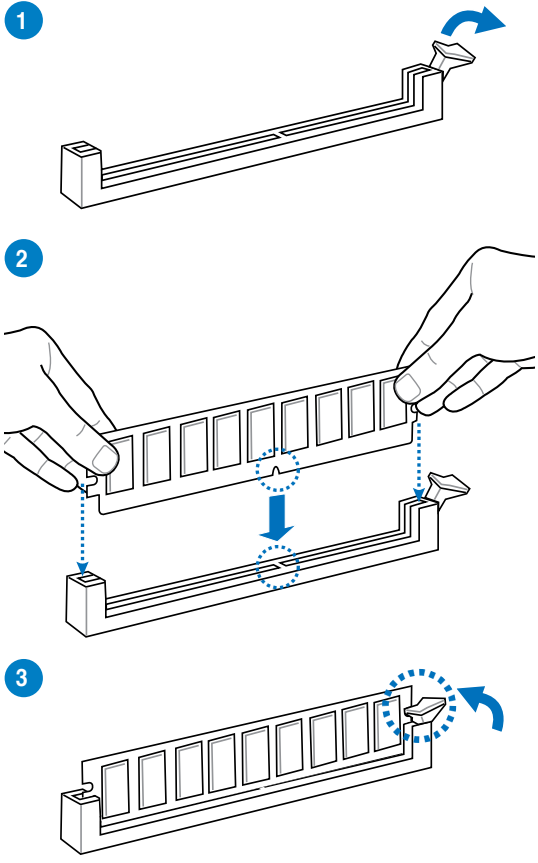

To remove a DIMM

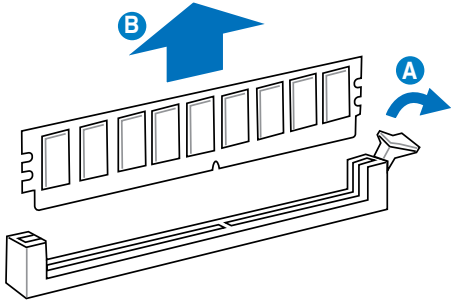

2.1.5 ATX Power connection

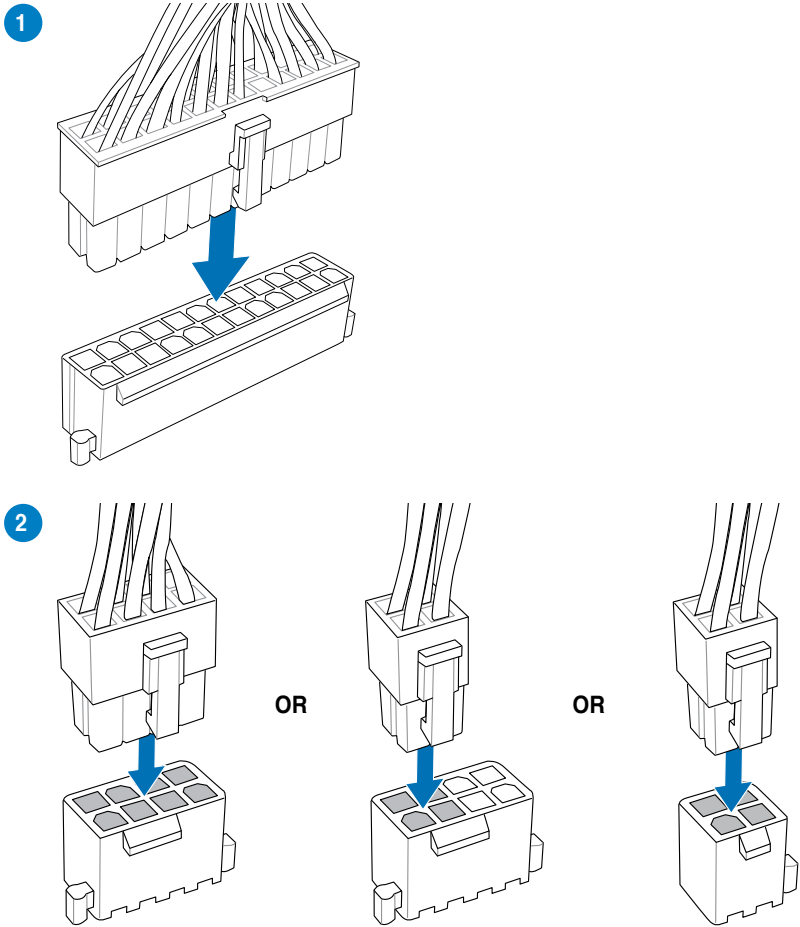

2.1.6 SATA device connection

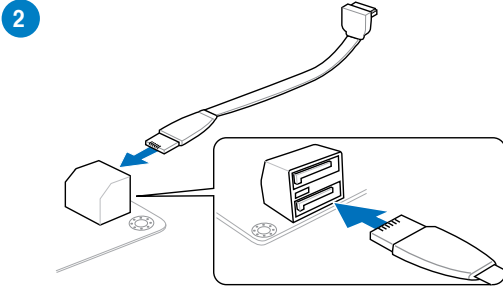
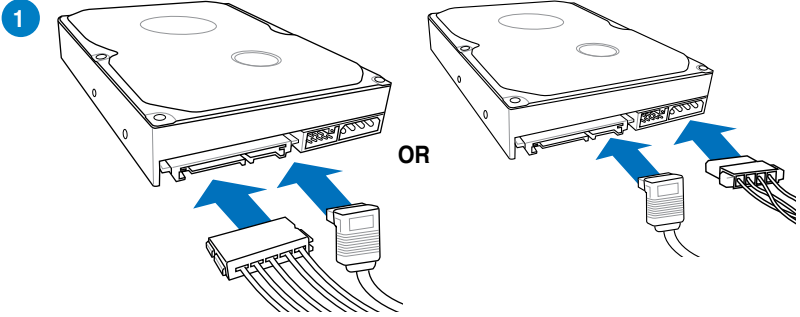

2.1.7 Front I/O Connector

To install ASUS Q-Connector

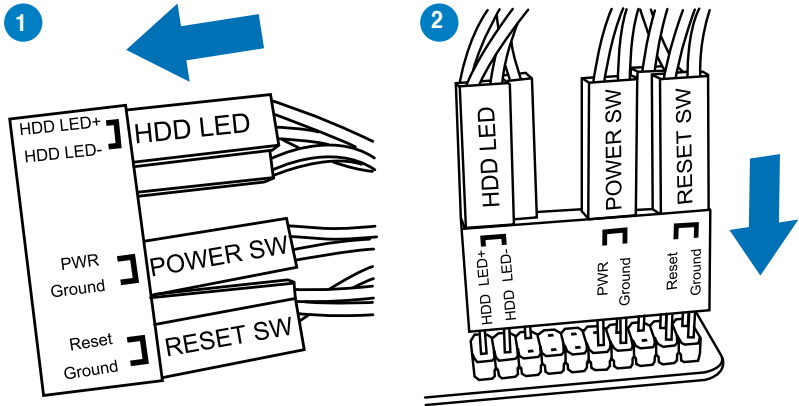

To install USB 2.0 connector

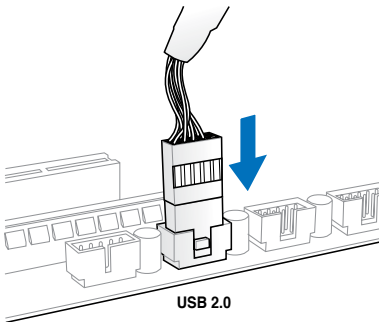

To install front panel audio connector

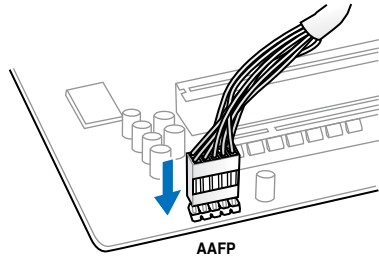

To install USB 3.0 connector

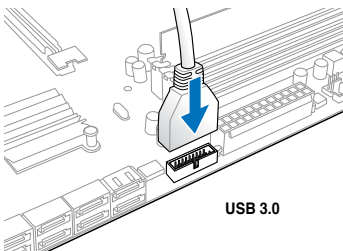

2.1.8 Expansion Card installation

To install PCIe x16 cards

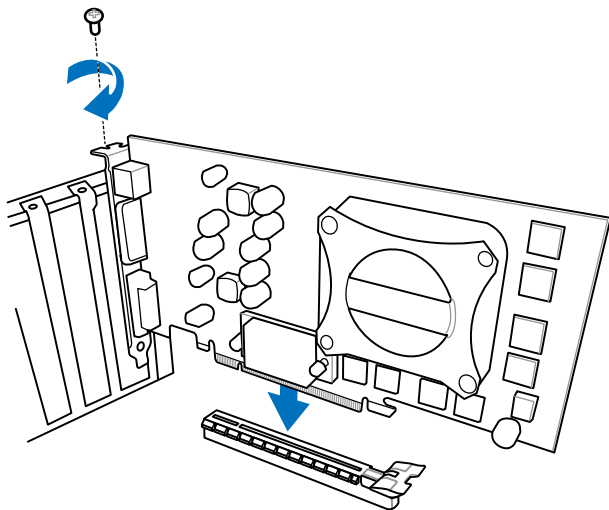

2.1.9 mPCIe Combo II installation

ROG mPCIe Combo II offers expandability solutions with the latest connectivity standards via the proprietary connector onboard. It provides your system with the fastest Wi-Fi 802.11ac and Bluetooth 4.0 connection. It also features the M.2 (NGFF) slot for installing smaller SSDs.



- The mPCIe Combo II card supports 26.8mm x 30mm half-sized mPCIe module on one side and M.2 (NGFF) Type 2242 SSD card (22mm x 42mm) SSD on the other side.
- The M.2 (NGFF) SSD modules are purchased separately.

Installing the M.2 (NGFF) SSD module

To install M.2 (NGFF) SSD module:

1. Remove the two short screws at the back of the mPCIe Combo II card metal cover.

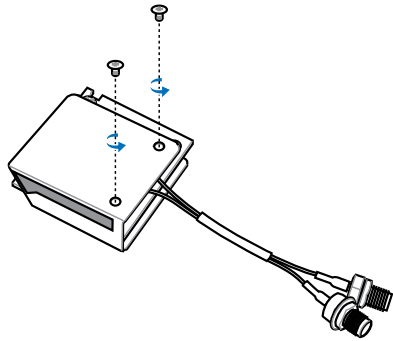

2. Remove the long screw at the front, then remove the metal cover.

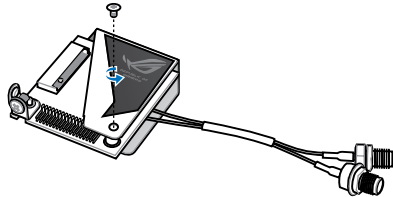

3. Align and insert the M.2 (NGFF) SSD module into the M.2 slot.

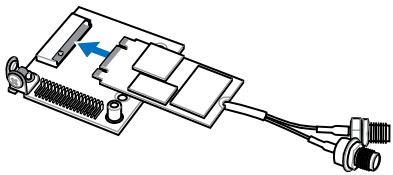

The M.2 (NGFF) SSD module fits in one orientation only. If it does not fit, try reversing it.

4. Replace the metal cover and secure the back of the metal cover with the two short screws that you removed in step 1.

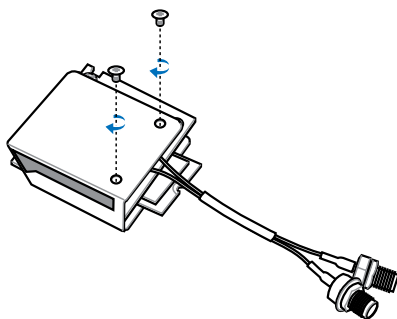

5. Secure the front of the metal cover with the long screw that you removed in step 2.

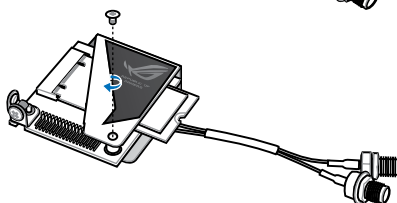

Installing the mPCIe Combo II card

To install the mPCIe Combo II card to your motherboard:

1. Remove the black screw near the 36-2 pin connector.

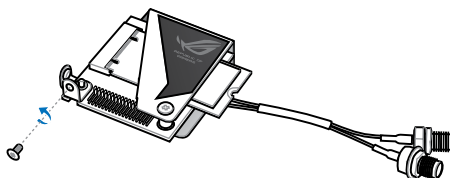

2. Locate the MPCIE_COMBO_II connector on the motherboard then align and insert the mPCIe Combo II card to the MPCIE_COMBO_II connector.

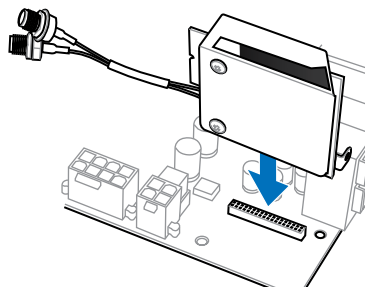

The mPCIe Combo II fits in one orientation only.



Insert the mPCIe Combo II carefully to prevent damage to the card, connector pins, or to the motherboard.

3. Secure the mPCIe Combo II card either to the motherboard or the rear I/O shield using the black screw removed in step 1.

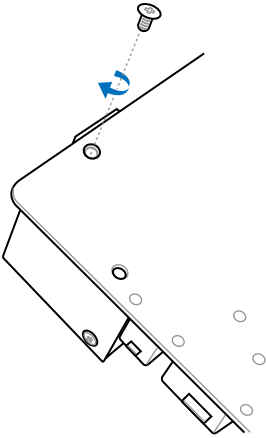

OR

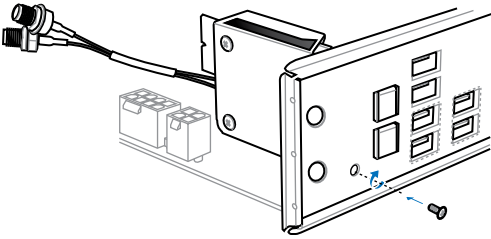

Installing the Wi-Fi antenna connector

If you installed a Wi-Fi module on the mPCIe Combo II, you would need to install the Wi-Fi antenna connector.

To install the Wi-Fi antenna connector:

1. Remove the bolt from the Wi-Fi antenna connector but leave the washer on the connector.

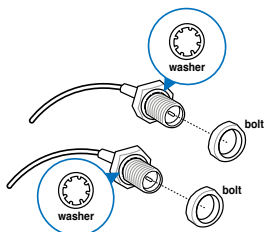

2. Insert the connector into the I/O shield's Wi-Fi port hole.

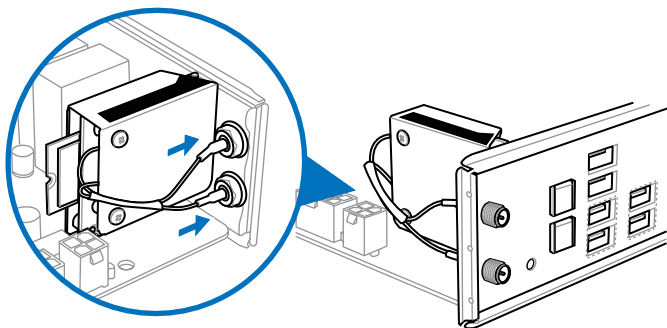

3. Replace the bolt on the connector to secure the antenna connector and the I/O shield in place.

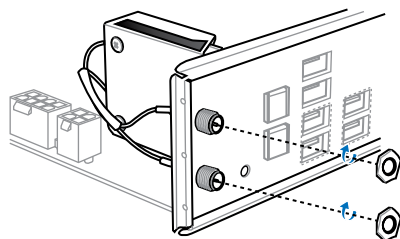

2.2 BIOS update utility

USB BIOS Flashback

USB BIOS Flashback allows you to easily update the BIOS without entering the existing BIOS or operating system. Simply insert a USB storage device to the USB port, press the ROG Connect button for three seconds, and the BIOS is updated automatically.

To use USB BIOS Flashback:

1. Download the latest BIOS file from the ASUS website
2. Extract and rename the BIOS image file to **M6E.CAP**.
3. Copy **M6E.CAP** to the root directory of the USB flash disk drive.
4. Turn off the system and insert the USB storage device to the ROG Connect port.
5. Press the ROG Connect button and release when a flashing light appears, which indicates that the BIOS Flashback function is enabled.
6. Wait until the light goes out, indicating that the BIOS updating process is completed.

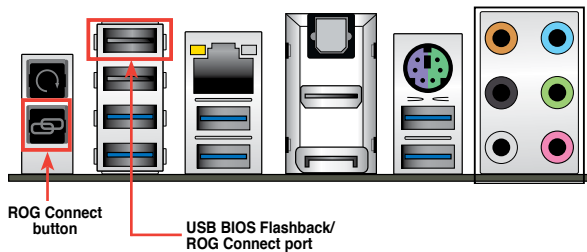

For more BIOS update utilities in BIOS setup, refer to the section **Updating BIOS** in Chapter 3.



- DO NOT unplug portable disk, power system, or press the CLR_CMOS button while BIOS update is ongoing, otherwise update will be interrupted. In case of interruption, please follow the steps again.
- Updating BIOS may have risks. If the BIOS program is damaged during the process and results to the system's failure to boot up, please contact your local ASUS Service Center.

2.3 Motherboard rear and audio connections

2.3.1 Rear I/O connection

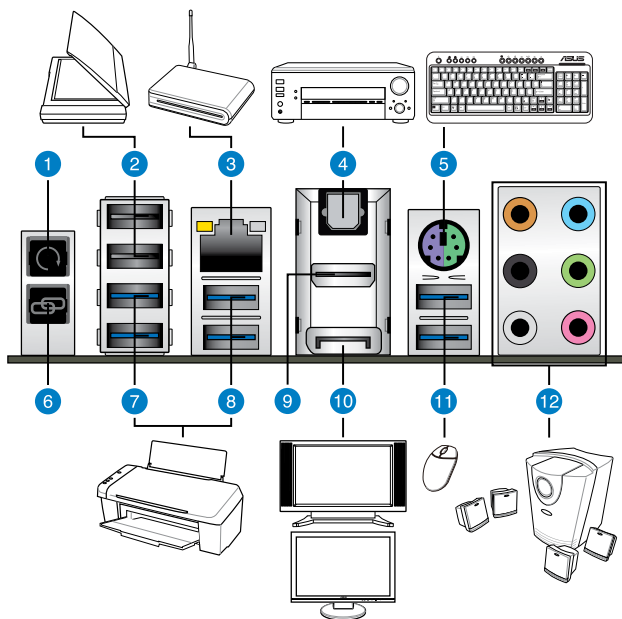

Rear panel connectors

1. Clear CMOS button
2. USB 2.0 port 7 and 8. The ROG Connect port is the port on top. It supports USB BIOS Flashback and USB Charger+
3. LAN (RJ-45) port*
4. Optical S/PDIF OUT port
5. PS/2 Keyboard/Mouse combo port
6. ROG Connect button
7. ASMedia USB 3.0 port E3 and E4, support ASUS USB 3.0 Boost Turbo Mode
8. ASMedia USB 3.0 port E1 and E2 , support ASUS USB 3.0 Boost Turbo Mode
9. HDMI port
10. DisplayPort
11. Intel USB 3.0 port 5 and 6, support ASUS USB 3.0 Boost Turbo Mode
12. Audio I/O ports**

* and ** : Refer to the tables on the next page for LAN port LEDs, and audio port definitions.



- Due to USB 3.0 controller limitation, USB 3.0 devices can only be used under Windows® OS environment and after the USB 3.0 driver installation.
- USB 3.0 devices can only be used as data storage only.
- We strongly recommend that you connect USB 3.0 devices to USB 3.0 ports for faster and better performance for your USB 3.0 devices.
- Due to the design of the Intel® 8 series chipset, all USB devices connected to the USB 2.0 and USB 3.0 ports are controlled by the xHCI controller. Some legacy USB devices must update their firmware for better compatibility.
- Multi-VGA output supports up to three displays under Windows® OS environment, two displays under BIOS, and one display under DOS.

* LAN ports LED indications

Activity Link LED		Speed LED	
Status	Description	Status	Description
Off	No link	Off	10 Mbps connection
Orange	Linked	Orange	100 Mbps connection
Orange (Blinking)	Data activity	Green	1 Gbps connection
Orange (Blinking then steady)	Ready to wake up from S5 mode		

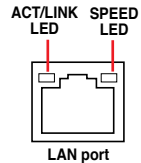

** Audio 2, 4, 6 or 8-channel configuration

Port	Headset 2-channel	4-channel	6-channel	8-channel
Light Blue	Line In	Line In	Line In	Line In
Lime	Line Out	Front Speaker Out	Front Speaker Out	Front Speaker Out
Pink	Mic In	Mic In	Mic In	Mic In
Orange	—	—	Center/Subwoofer	Center/Subwoofer
Black	—	Rear Speaker Out	Rear Speaker Out	Rear Speaker Out
Gray	—	—	—	Side Speaker Out

2.3.2 Audio I/O connections

Audio I/O ports

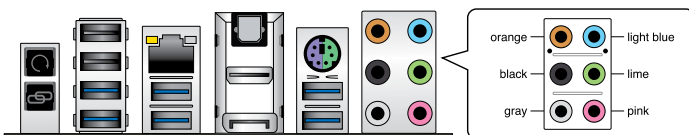

Connect to Headphone and Mic

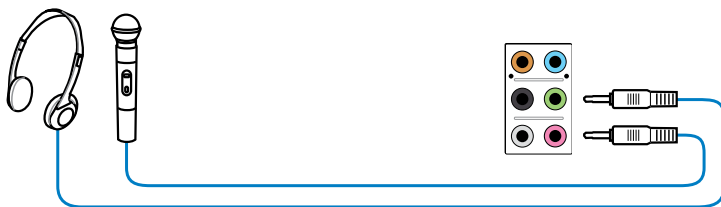

Connect to Stereo Speakers

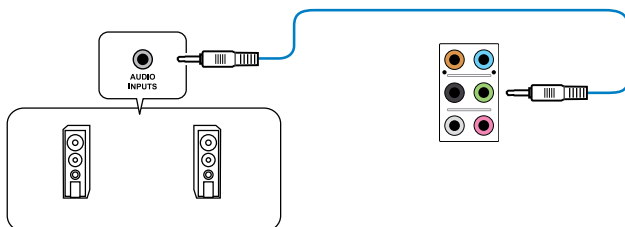

Connect to 2.1 channel Speakers

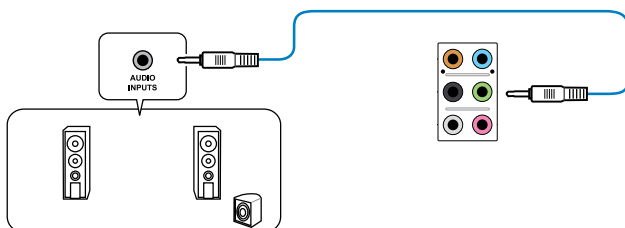

Connect to 4.1 channel Speakers

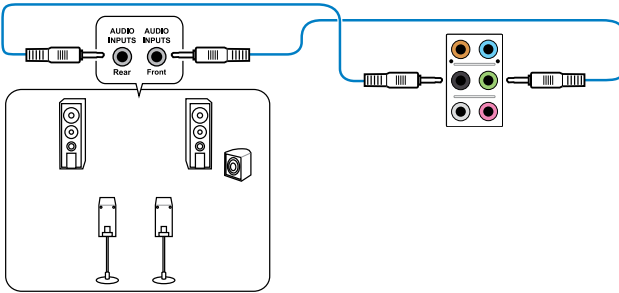

Connect to 5.1 channel Speakers

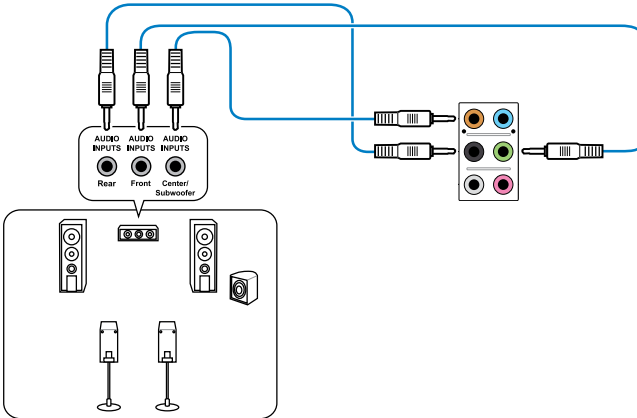

Connect to 7.1 channel Speakers

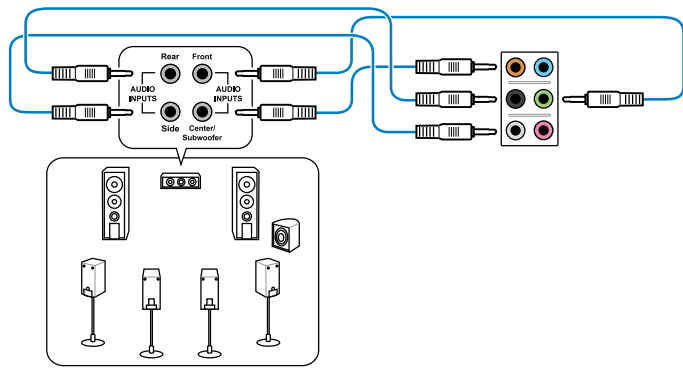

2.4 OC Panel

The OC Panel is a device that allows you to perform overclocking without the need to go to the BIOS settings or use software utilities. You can setup the OC Panel in an available 5.25-inch drive bay on your computer chassis (Normal Mode) or as an external handheld console on an "open-air" OC test bench (Extreme Mode.)

These modes are further explained in the succeeding subsections.



- Ensure that your system has adequate cooling designed for overclocking before using the OC Panel.
- When updating the OC Panel firmware, you have to disable the USB xHCI function in BIOS. To do this, click **Advanced > USB Configuration > Intel xHCI Mode** then set Intel xHCI Mode to **[Disabled]**.

2.4.1 OC Panel Overview

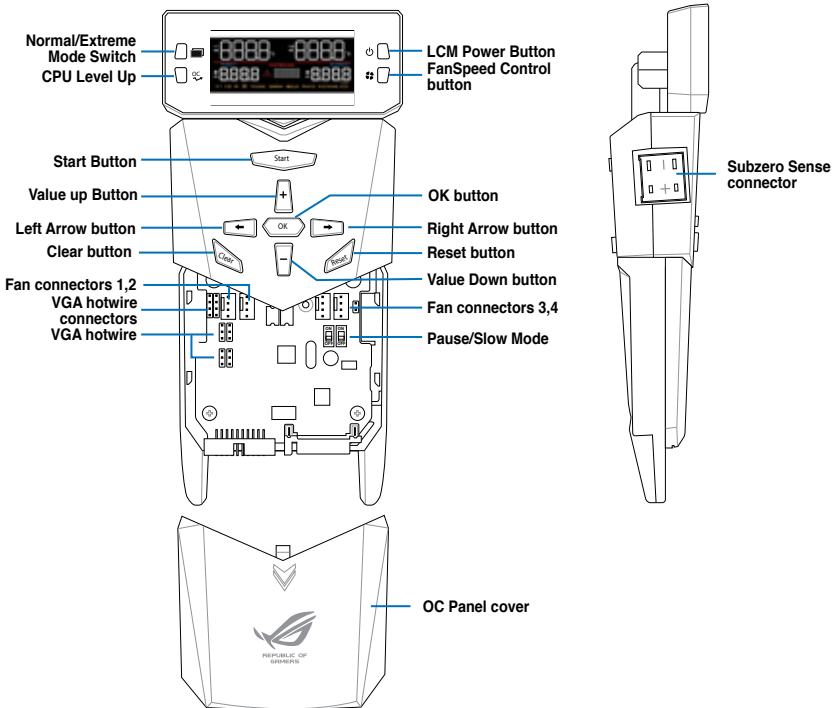

OC Panel LCM Display in Normal Mode

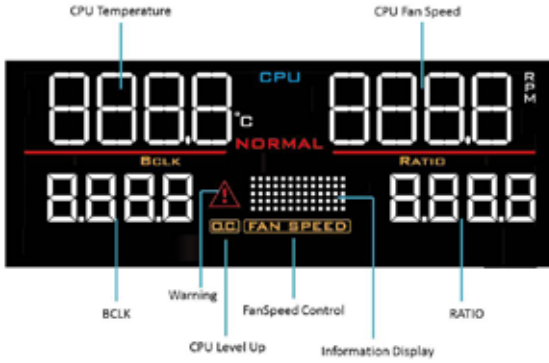

OC Panel LCM Display in Extreme Mode

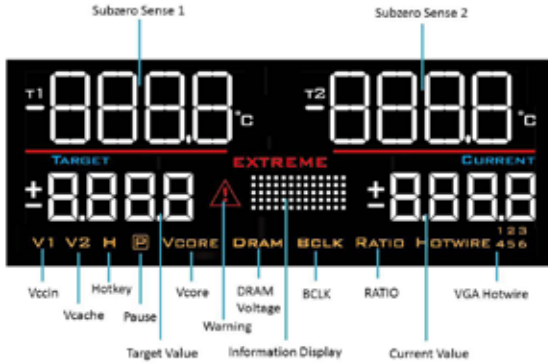

2.4.2 Setting up your OC Panel in Normal Mode

The OC Panel in Normal Mode mainly provides easy access buttons for increasing your CPU's frequency level, adjusting fan speeds and customizing overclocking profiles. It also displays vital information about your computer's CPU temperature, ratio, base clock, CPU fan speed (RPM).

To set up your OC Panel in Normal Mode:

1. Tilt the OC Panel LCM display until it is perpendicular to the body of OC Panel.

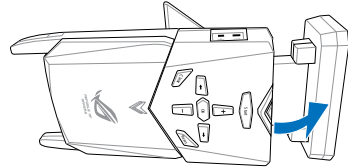

2. Get the bundled OC Panel 5.25-inch drive bay metal case and set of two (2) screws.
3. Align and insert the OC Panel into the OC Panel 5.25-inch drive bay metal case.



The OC Panel fits in one orientation only. If it does not fit, try reversing it.

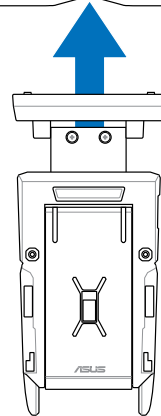
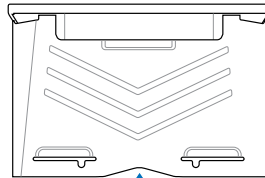

- Secure the OC Panel to the OC Panel 5.25-inch drive bay metal case with the two (2) screws.

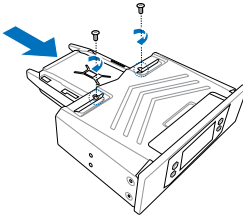

Ensure that the OC Panel fits snugly into the OC Panel 5.25-inch drive bay metal case.

- Shut down your computer.
- Open your computer chassis and remove the front cover of an available 5.25-inch drive bay.
- Align and insert the OC Panel and the OC Panel 5.25-inch drive bay metal case assembly into the drive bay.
- Secure the OC Panel and the OC Panel 5.25-inch drive bay metal case into the drive bay with four (4) screws.
- Connect the OC Panel data cable (A) and a SATA Power cable (B) to the OC Panel.

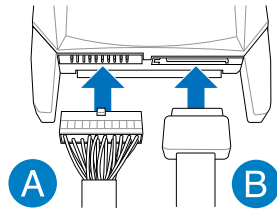
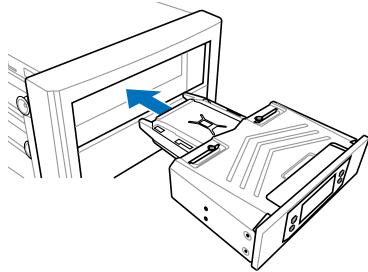

- Locate the ROG_EXT connector on the motherboard and connect the OC Panel cable.

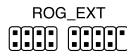
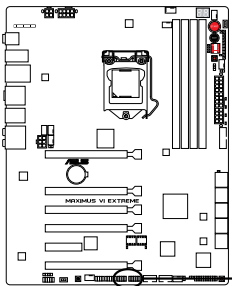

MAXIMUS VI EXTREME OC PANEL connector

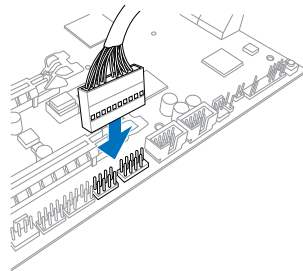

- Boot your computer.
- Press the OC Panel LCM Power button to turn on the OC Panel LCM display.

2.4.3 Setting up your OC Panel in Extreme Mode

The OC Panel in Extreme Mode is setup with an open chassis system or “open-air” OC test bed assembly and enjoyed as a handheld console to perform overclocking and voltage tuning.

When in Extreme Mode, you can enjoy more features including Subzero Sense and VGA Hotwire. It also comes with some of the most commonly used voltage tuning presets that are preconfigured for your convenience and optimum overclocking experience.

To setup the OC Panel in Extreme Mode:

1. Shut down your computer.
2. Connect the OC Panel cable (A) and a SATA Power cable (B) to the OC Panel.

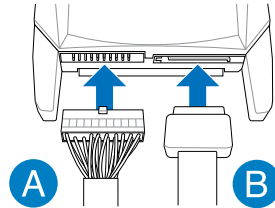

3. Locate the ROG_EXT connector on the motherboard and connect the OC Panel cable.

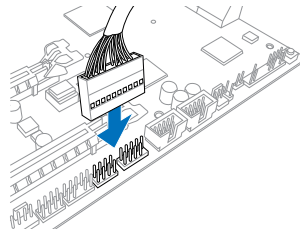
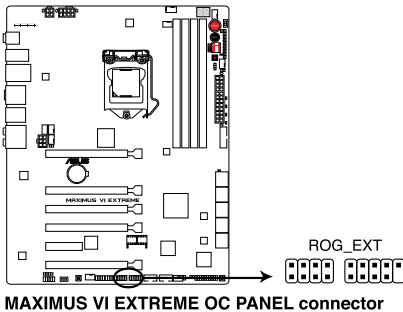

4. Boot your computer.
5. Press the OC Panel power button to turn on the OC Panel LCM display.

2.5 Starting up for the first time

1. After making all the connections, replace the system case cover.
2. Ensure that all switches are off.
3. Connect the power cord to the power connector at the back of the system chassis.
4. Connect the power cord to a power outlet that is equipped with a surge protector.
5. Turn on the devices in the following order:
 - a. Monitor
 - b. External SCSI devices (starting with the last device on the chain)
 - c. System power
6. After applying power, the system power LED on the system front panel case lights up. For systems with ATX power supplies, the system LED lights up when you press the ATX power button. If your monitor complies with the “green” standards or if it has a “power standby” feature, the monitor LED may light up or change from orange to green after the system LED turns on.

The system then runs the power-on self tests (POST). While the tests are running, the BIOS beeps (refer to the BIOS beep codes table) or additional messages appear on the screen. If you do not see anything within 30 seconds from the time you turned on the power, the system may have failed a power-on test. Check the jumper settings and connections or call your retailer for assistance.

BIOS Beep	Description
One short beep	VGA detected Quick boot set to disabled No keyboard detected
One continuous beep followed by two short beeps then a pause (repeated)	No memory detected
One continuous beep followed by three short beeps	No VGA detected
One continuous beep followed by four short beeps	Hardware component failure

7. At power on, hold down the <Delete> key to enter the BIOS Setup. Follow the instructions in Chapter 3.

2.6 Turning off the computer

While the system is ON, press the power button for less than four seconds to put the system on sleep mode or soft-off mode, depending on the BIOS setting. Press the power switch for more than four seconds to let the system enter the soft-off mode regardless of the BIOS setting.

BIOS setup

3

3.1 Knowing BIOS



The new ASUS UEFI BIOS is a Unified Extensible Interface that complies with UEFI architecture, offering a user-friendly interface that goes beyond the traditional keyboard-only BIOS controls to enable a more flexible and convenient mouse input. You can easily navigate the new UEFI BIOS with the same smoothness as your operating system. The term "BIOS" in this user manual refers to "UEFI BIOS" unless otherwise specified.

BIOS (Basic Input and Output System) stores system hardware settings such as storage device configuration, overclocking settings, advanced power management, and boot device configuration that are needed for system startup in the motherboard CMOS. In normal circumstances, the default BIOS settings apply to most conditions to ensure optimal performance. **DO NOT change the default BIOS settings** except in the following circumstances:

- An error message appears on the screen during the system bootup and requests you to run the BIOS Setup.
- You have installed a new system component that requires further BIOS settings or update.



Inappropriate BIOS settings may result in instability or boot failure. **We strongly recommend that you change the BIOS settings only with the help of a trained service personnel.**



When downloading or updating the BIOS file, rename it as **M6E.CAP** for this motherboard.

3.2 BIOS setup program

Use the BIOS Setup to update the BIOS or configure its parameters. The BIOS screen include navigation keys and brief onscreen help to guide you in using the BIOS Setup program.

Entering BIOS at startup

To enter BIOS Setup at startup, press <Delete> during the Power-On Self Test (POST). If you do not press <Delete>, POST continues with its routines.

Entering BIOS Setup after POST

To enter BIOS Setup after POST:

- Press <Ctrl>+<Alt>+<Delete> simultaneously.
- Press the reset button on the system chassis.
- Press the DirectKey button on the motherboard. You can perform this option if the DirectKey item is enabled in BIOS Setup. See section **3.8 Boot Menu** for more information in enabling the DirectKey function in BIOS.
- Press the power button to turn the system off then back on. Do this option only if you failed to enter BIOS Setup using the previous options.



-
- The BIOS setup screens shown in this section are for reference purposes only, and may not exactly match what you see on your screen.
 - Ensure that a USB mouse is connected to your motherboard if you want to use the mouse to control the BIOS setup program.
 - If the system becomes unstable after changing any BIOS setting, load the default settings to ensure system compatibility and stability. Select the **Load Optimized Defaults** item under the **Exit** menu or press hotkey <F5>. See section **3.10 Exit Menu** for details.
 - If the system fails to boot after changing any BIOS setting, try to clear the CMOS and reset the motherboard to the default value. See section **2.3.1 Rear I/O Connection** for information on how to erase the RTC RAM via the Clear CMOS button.
 - The BIOS setup program does not support bluetooth devices.
-

BIOS menu screen

The BIOS Setup program can be used under two modes: **EZ Mode** and **Advanced Mode**. You can change modes from the **Exit** menu or from the **Exit/Advanced Mode** screen.

3.2.1 EZ Mode

The EZ Mode provides you an overview of the basic system information, and allows you to select the display language, system performance mode and boot device priority. To access the Advanced Mode, click **Exit/Advanced Mode**, then select **Advanced Mode** or press <F7> hot key for the advanced BIOS settings.



The default screen for entering the BIOS setup program can be changed. Refer to the **Setup Mode** item in section 3.8 **Boot menu** for details.

The screenshot shows the ASUS UEFI BIOS Utility - EZ Mode interface. The interface is dark-themed and displays various system information and settings. Red boxes highlight specific areas, and red lines connect these boxes to text labels explaining their functions.

- Displays the CPU temperature and CPU voltage output:** Points to the CPU Information section showing temperature (Temp. +145.0°F/+60.0°C) and voltage (Voltage 0.896V).
- Displays the installed DIMMs:** Points to the DIMM Information section showing DIMM_A1, DIMM_B1, and DIMM_C2.
- Selects the display language of the BIOS setup program:** Points to the language dropdown menu (English).
- Click to display all fan speeds if available:** Points to the Fan section showing CPU_FAN, CPU_OPT_FAN, and CHA_FAN2.
- Exits the BIOS setup program without saving the changes, saves the changes and resets the system, or enters the Advanced Mode:** Points to the Exit/Advanced Mode button.
- Power Saving mode:** Points to the Power Saving mode button.
- Normal mode:** Points to the Normal mode button.
- ASUS Optimal mode:** Points to the ASUS Optimal mode button.
- Boot Priority:** Points to the Boot Priority section.
- Displays the shortcut items:** Points to the Shortcut(F2) button.
- Displays the Advanced mode menus:** Points to the Advanced Mode(F7) button.
- SATA Information:** Points to the SATA Information button.
- Boot Menu:** Points to the Boot Menu(F8) button.
- Loads optimized default settings:** Points to the Default(F5) button.
- Displays the system properties of the selected mode:** Points to the Performance, Quiet, and Energy Saving mode buttons.
- Selects the boot device priority:** Points to the Boot Priority section.



- The boot device options vary depending on the devices you installed to the system.
- The **Boot Menu** (F8) button is available only when the boot device is installed to the system.

3.2.2 Advanced Mode

The Advanced Mode provides advanced options for experienced end-users to configure the BIOS settings. The figure below shows an example of the Advanced Mode. Refer to the following sections for the detailed configurations.



To access the Advanced Mode, click **Exit**, then select **Advanced Mode** or press **F7** hotkey.

Menu bar

The menu bar on top of the screen has the following main items:

My Favorites	For saving the frequently-used system settings and configuration
Extreme Tweaker	For changing the overclocking settings
Main	For changing the basic system configuration
Advanced	For changing the advanced system settings
Monitor	For displaying the system temperature, power status, and changing the fan settings
Boot	For changing the system boot configuration
Tool	For configuring options for special functions
Exit	For selecting the exit options and loading default settings

Menu items

The highlighted item on the menu bar displays the specific items for that menu. For example, selecting **Main** shows the Main menu items.

The other items (My Favorites, Extreme Tweaker, Advanced, Monitor, Boot, Tool, and Exit) on the menu bar have their respective menu items.

Back button

This button appears when entering a submenu. Press <Esc> or use the USB mouse to click this button to return to the previous menu screen.

Submenu items

A greater than sign (>) before each item on any menu screen means that the item has a submenu. To display the submenu, select the item and press <Enter>.

Pop-up window

Select a menu item and press <Enter> to display a pop-up window with the configuration options for that item.

Scroll bar

A scroll bar appears on the right side of a menu screen when there are items that do not fit on the screen. Press the Up/Down arrow keys or <Page Up> / <Page Down> keys to display the other items on the screen.

Navigation keys

At the bottom right corner of the menu screen are the navigation keys for the BIOS setup program. Use the navigation keys to select items in the menu and change the settings.



If you delete all shortcut items from the F3: Shortcut list, the default shortcut items will reappear after your next startup.

General help

At the top right corner of the menu screen is a brief description of the selected item. Use <F12> key to capture the BIOS screen and save it to the removable storage device.

Configuration fields

These fields show the values for the menu items. If an item is user-configurable, you can change the value of the field opposite the item. You cannot select an item that is not user-configurable.

A configurable field is highlighted when selected. To change the value of a field, select it and press <Enter> to display a list of options.

Quick Note button

This button allows you to enter notes of the activities that you have done in BIOS.



- The Quick Note function does not support the following keyboard functions: delete, cut, copy and paste.
 - You can only use the alphanumeric characters to enter your notes.
-

Last Modified button

This button shows the items that you last modified and saved in BIOS Setup.

3.3 My Favorites

MyFavorites is your personal space where you can easily save and access your favorite BIOS items.



Adding items to My Favorites

To add frequently-used BIOS items to My Favorites:

1. Use the arrow keys to select an item that you want to add. When using a mouse, hover the pointer to the item.
2. Press <F4> on your keyboard or right-click on your mouse to add the item to My Favorites page.



You cannot add the following items to My Favorites:

- Items with submenu options
- User-configurable items such as language and boot device order
- Configuration items such as Memory SPD Information, system time and date

3.4 Extreme Tweaker menu

The Extreme Tweaker menu items allow you to configure overclocking-related items.



Be cautious when changing the settings of the Extreme Tweaker menu items. Incorrect field values can cause the system to malfunction.



The configuration options for this section vary depending on the CPU and DIMM model you installed on the motherboard.

Scroll down to display other BIOS items.



Ai Overclock Tuner [Auto]

Allows you to select the CPU overclocking options to achieve the desired CPU internal frequency. Select any of these preset overclocking configuration options:

- [Auto] Loads the optimal settings for the system.
- [Manual] Allows you to individually set overclocking parameters.
- [X.M.P.] If you install memory modules supporting the eXtreme Memory Profile (X.M.P.) Technology, choose this item to set the profiles supported by your memory modules for optimizing the system performance.



The [X.M.P.] configuration option appears only when you install memory modules supporting the eXtreme Memory Profile (X.M.P.) Technology.

ASUS MultiCore Enhancement [Enabled]

- [Auto] Default is set to **[Auto]** for maximum performance under XMP/Manual/ User-defined memory frequency mode.
- [Disabled] Allows you to set to default core ratio settings.

CPU Core Ratio [Auto]

Allows you to set the CPU ratio and sync automatically, per core or all cores.

Configuration options: [Auto] [Sync All Cores] [Per Core]



When the CPU Core Ratio is set to **[Auto]**, the following item appears:

Min CPU Cache Ratio [Auto]

Allows you to set the uncore ratio of the processor to its possible minimum value.

Configuration options: [Auto] [1] - [80]

Max CPU Cache Ratio [Auto]

Allows you to set the uncore ratio of the processor to its possible maximum value.

Configuration options: [Auto] [1] - [80]



When the CPU Core Ratio is set to **[Sync All Cores]**, the following item appears.

1-Core Ratio Limit [Auto]

Allows you to set the 1-Core Ratio Limit.

[Auto] Select to apply the CPU default Turbo Ratio setting.

[Manual] Select to manually assign a value for the 1-Core Ratio limit. The values of 2-core, 3-core, and 4-core ratio limits will be automatically set to be lower than or equal to the value of the 1-core Ratio limit.

Min CPU Cache Ratio [Auto]

Allows you to set the uncore ratio of the processor to its possible minimum value. Configuration options: [Auto] [1] - [80]

Max CPU Cache Ratio [Auto]

Allows you to set the uncore ratio of the processor to its possible maximum value. Configuration options: [Auto] [1] - [80]



When the CPU Core Ratio is set to **[Per Core]**, the following item appears:

1-Core Ratio Limit [Auto]

Allows you to set the 1-Core Ratio Limit.

[Auto] Select to apply the CPU default Turbo Ratio setting.

[Manual] Select to manually assign a 1-Core Ratio Limit value that is higher than or equal to the 2-Core Ratio Limit.

2-Core Ratio Limit [Auto]

Allows you to set the 2-Core Ratio Limit.

[Auto] Select to apply the CPU default Turbo Ratio setting.

[Manual] Select to manually assign a 2-Core Ratio Limit value that is higher than or equal to the 3-Core Ratio Limit. 1-Core Limit must not be set to [Auto].

3-Core Ratio Limit [Auto]

Allows you to set the 3-Core Ratio Limit.

[Auto] Select to apply the CPU default Turbo Ratio setting.

[Manual] Select to manually assign a 3-Core Ratio Limit value that is higher than or equal to the 4-Core Ratio Limit. 1-Core/2-Core Ratio Limit must not be set to [Auto].

4-Core Ratio Limit [Auto]

Allows you to set the 4 Core Ratio Limit

[Auto] Select to apply the CPU default Turbo Ratio setting

[Manual] Select to manually assign a 4-Core Ratio Limit value that is higher than or equal to the 3-Core Ratio Limit. 1-Core/2-Core/3-Core Limit must not be set to [Auto].

Min CPU Cache Ratio [Auto]

Allows you to set the uncore ratio of the processor to its possible minimum value. Configuration options: [Auto] [1] - [80]

Max CPU Cache Ratio [Auto]

Allows you to set the uncore ratio of the processor to its possible maximum value. Configuration options: [Auto] [1] - [80]

Internal PLL Overvoltage [Auto]

Allows you to enable the internal PLL voltage for K-SKU CPUs to get the extreme overclocking capability.

Configuration options: [Auto] [Enabled] [Disabled]

BCLK Frequency : DRAM Frequency Ratio [Auto]

Allows you to set the BCLK Frequency to DRAM Frequency ratio.

[Auto] The ratio will be set to the optimized settings.

[100:100] The BCLK Frequency to DRAM Frequency ratio will be set to 100:100.

[100:133] The BCLK Frequency to DRAM Frequency ratio will be set to 100:133.

DRAM Frequency [Auto]

Allows you to set the memory operating frequency. The configuration options vary with the BCLK/CPU Strap Frequency item settings.

Xtreme Tweaking [Disabled]

Allows you to enable or disable Xtreme Tweaking.

Configuration options: [Enabled] [Disabled]

CPU Level Up [Auto]

This item allows you to select the CPU Level depending on the CPU frequency.

EPU Power Saving Mode [Disabled]

Allows you to enable or disable the EPU power saving function.

Configuration options: [Disabled] [Enabled]

DRAM Timing Control

The subitems in this menu allow you to set the DRAM timing control features. Use the <+> and <-> keys to adjust the value. To restore the default setting, type [auto] using the keyboard and press the <Enter> key.

Memory Presets

This item allows you to select and load a memory preset or timing profile from a predefined list. The configurations of the memory presets are provided by the ROG OC expert team. Users can load the profiles before performing overclocking or DRAM tweaking.

Maximus Tweak [Auto]

This item allows you to choose the mode that is supported by Maximus Tweak when you want to fine tune the DRAM of the system. Mode 1 helps you with the DRAM performance. Mode 2 helps you in overclocking and system performance.

[Auto] Automatically selects the mode.

[Mode 1] Memory compatibility.

[Mode 2] Overclocking and performance.



Changing the values in this menu may cause the system to become unstable! If this happens, revert to the default settings.

Primary Timings

DRAM CAS# Latency [Auto]

Configuration options: [Auto] [1] – [31]

DRAM RAS# to CAS# Delay [Auto]

Configuration options: [Auto] [1] – [31]

DRAM RAS# PRE Time [Auto]

Configuration options: [Auto] [1] – [31]

DRAM RAS# ACT Time [Auto]

Configuration options: [Auto] [1] – [63]

DRAM COMMAND Rate [Auto]

Configuration options: [Auto] [1] – [3]

Latency Boundary A [Auto]

Configuration options: [Auto] [1] – [27]

Latency Boundary B [Auto]

Configuration options: [Auto] [1] – [14]

Latency Compensator [Auto]

This item allows can help improve performance overclocking if enabled.

Configuration Options: [Auto] [Enabled] [Disabled]

Secondary Timings

DRAM RAS# to RAS# Delay [Auto]

Configuration options: [Auto] [1] – [15]

DRAM REF Cycle Time [Auto]

Configuration options: [Auto] [1] – [511]

DRAM Refresh Interval [Auto]

Configuration options: [Auto] [1] – [65535]

DRAM WRITE Recovery Time [Auto]

Configuration options: [Auto] [1] – [16]

DRAM READ to PRE Time [Auto]

Configuration options: [Auto] [1] – [15]

DRAM FOUR ACT WIN Time [Auto]

Configuration options: [Auto] [1] – [255]

DRAM WRITE to READ Delay [Auto]

Configuration options: [Auto] [1] – [15]

DRAM CKE Minimum pulse width [Auto]

Configuration options: [Auto] [1] – [15]

DRAM CAS# Write Latency [Auto]

Configuration options: [Auto] [1] – [31]

RTL IOL control

DRAM RTL Initial Value [Auto]

Configuration options: [Auto] [1] - [63]

DRAM RTL (CHA_R0D0) [Auto]

Configuration options: [Auto] [1] - [63]

DRAM RTL (CHA_R0D1) [Auto]

Configuration options: [Auto] [1] - [63]

DRAM RTL (CHA_R1D0) [Auto]

Configuration options: [Auto] [1] - [63]

DRAM RTL (CHA_R1D1) [Auto]

Configuration options: [Auto] [1] - [63]

DRAM RTL (CHB_R0D0) [Auto]

Configuration options: [Auto] [1] - [63]

DRAM RTL (CHB_R0D1) [Auto]

Configuration options: [Auto] [1] - [63]

DRAM RTL (CHB_R1D0) [Auto]

Configuration options: [Auto] [1] - [63]

DRAM RTL (CHB_R1D1) [Auto]

Configuration options: [Auto] [1] - [63]

DRAM IO-L (CHA_R0D0) [Auto]

Configuration options: [Auto] [1] - [15]

DRAM IO-L (CHA_R0D1) [Auto]

Configuration options: [Auto] [1] - [15]

DRAM IO-L (CHA_R1D0) [Auto]

Configuration options: [Auto] [1] - [15]

DRAM IO-L (CHA_R1D1) [Auto]

Configuration options: [Auto] [1] - [15]

DRAM IO-L (CHB_R0D0) [Auto]

Configuration options: [Auto] [1] - [15]

DRAM IO-L (CHB_R0D1) [Auto]

Configuration options: [Auto] [1] - [15]

DRAM IO-L (CHB_R1D0) [Auto]

Configuration options: [Auto] [1] - [15]

DRAM IO-L (CHB_R1D1) [Auto]

Configuration options: [Auto] [1] - [15]

Third Timings

tRDRD [Auto]

Configuration options: [Auto] [1] – [7]

tRDRD_dr [Auto]

Configuration options: [Auto] [1] – [15]

tRDRD_dd [Auto]

Configuration options: [Auto] [1] – [15]

tWRRD [Auto]

Configuration options: [Auto] [1] – [63]

tWRRD_dr [Auto]

Configuration options: [Auto] [1] – [15]

tWRRD_dd [Auto]

Configuration options: [Auto] [1] – [15]

tWRWR [Auto]

Configuration options: [Auto] [1] – [7]

tWRWR_dr [Auto]

Configuration options: [Auto] [1] – [15]

tWRWR_dd [Auto]

Configuration options: [Auto] [1] – [15]

Dec_WRD [Auto]

Configuration options: [Auto] [0] [1]

tRDWR [Auto]

Configuration options: [Auto] [1] – [31]

tRDWR_dr [Auto]

Configuration options: [Auto] [1] – [31]

tRDWR_dd [Auto]

Configuration options: [Auto] [1] – [31]

MISC

MRC Fast Boot [Auto]

Allows you to enable, disable or automatically set the MRC fast boot.

Configuration options: [Auto] [Enabled] [Disabled]

DRAM CLK Period [Auto]

Configuration options: [Auto] [1] – [14]

Channel A DIMM Control [Enable Bot...]

Allows you to enable or disable the Channel A DIMM slots with the following configuration options: [Enable Both DIMMS] [Disable DIMM0] [Disable DIMM1] [Disable Both DIMMS]

Channel B DIMM Control [Enable Bot...]

Allows you to enable or disable the Channel B DIMM slots with the following configuration options: [Enable Both DIMMS] [Disable DIMM0] [Disable DIMM1] [Disable Both DIMMS]

Scrambler Setting [Optimized ...]

Set this item to [Optimized (ASUS)] to enhance system stability.

Configuration options: [Optimized (ASUS)] [Default (MRC)]

MCH Full Check [Auto]

- [Auto] Select to automatically choose the mode.
[Enabled] Select this item to enhance system stability.
[Disabled] Selecting this item may enhance the DRAM overclocking capability.

DQ Sense Amplifier [Auto]

Reducing usually helps overclocking and over-voltage.
Configuration options: [Auto] [+16] – [-29]

DQS Sense Amplifier [Auto]

Reducing usually helps overclocking and over-voltage.
Configuration options: [Auto] [+16] – [-29]

CMD Sense Amplifier [Auto]

Reducing usually helps overclocking and over-voltage.
Configuration options: [Auto] [+16] – [-29]

DRAM Swizzling Bit 0 [Auto]

Enabling usually helps overclocking.
Configuration options: [Auto] [Enabled] [Disabled]

DRAM Swizzling Bit 1 [Auto]

Enabling usually helps overclocking.
Configuration options: [Auto] [Trained] [Enabled] [Disabled]

DRAM Swizzling Bit 2 [Auto]

Enabling usually helps overclocking.
Configuration options: [Auto] [Trained] [Enabled] [Disabled]

DRAM Swizzling Bit 3 [Auto]

Enabling usually helps overclocking.
Configuration options: [Auto] [Trained] [Enabled] [Disabled]

DRAM Swizzling Bit 4 [Auto]

Enabling usually helps overclocking.
Configuration options: [Auto] [Trained] [Enabled] [Disabled]

RAW MHz Aid [Auto]

Enabling usually helps overclocking at the expense of performance. Configuration options: [Auto] [Enabled] [Disabled]

IC Optimizer [Auto]

Enabling may help overclocking when using the particular IC DIMMs. Configuration options: [Auto] [4GB Samsung] [4GB New Hynix] [4GB OLD Hynix]

GPU.DIMM Post

Automatically detects and displays the information about the devices or memory installed on the PCIe and DIMM slots. The field shows N/A if there are no devices installed on the slots.

DIGI+ Power Control

CPU Load-Line Calibration [Auto]

Load-line is defined by Intel® VRM specification and affects CPU power voltage. The CPU working voltage will decrease proportionally to CPU loading. Higher load-line calibration could get higher voltage and good overclocking performance but increases the CPU and VRM thermal conditions.

Select from Level 1 to Level 8 to adjust CPU power voltage from 0% to 100%.



- The actual performance boost may vary depending on your CPU specification.
- DO NOT remove the thermal module. The thermal conditions must be monitored.

CPU Voltage Frequency [Auto]

Switching frequency affects the VRM transient response and the thermal component conditions. Higher frequency gets quicker transient response.

Configuration options: [Auto] [Manual]



DO NOT remove the thermal module when setting this item to **[Manual]**. The thermal conditions should be monitored.



The following items appear only when you set the CPU Voltage Frequency to **[Auto]**.

VRM Spread Spectrum [Disabled]

Enable the VRM Spread Spectrum to enhance system stability.

Configuration options: [Disabled] [Enabled]

Active Frequency Mode [Disabled]

Enable the Active Frequency Mode for an enhanced power saving condition.

Configuration options: [Disabled] [Enabled]



The following item appears only when you set the CPU Voltage Frequency to **[Manual]**.

CPU Fixed Frequency [XXXX]

This item allows you to set a fixed CPU frequency. The configuration options range from 300kHz to 1000kHz. Use the <+> or <-> keys to adjust the interval.

VCCIN MOS Volt Control [Auto]

The VCCIN MOS Volt Control is the driving voltage for the MOSFETs on the VCCIN rail. Increasing to a higher level can help

- [Auto] Select to automatically choose between Manual and Active VGD.
- [Manual] Select to manually adjust VGD.
- [Active GD] Select to enable the VCCIN MOS Volt Control option to be dynamically adjusted based on the load that the CPU FIVR drains from the Extreme Engine DIGI+ III.



The following item appears only when you set the VCCIN MOS Volt Control to [Manual].

Manual VGD [6.5V]

Allows you to select the VGD voltage. Configuration options: [5V] [5.5V] [6.5V] [7V]

CPU Power Phase Control [Auto]

Allows you to set the power phase control of the CPU.

- [Standard] Set the phase control based on the CPU command.
- [Optimized] Set the ASUS optimized phase tuning profile.
- [Extreme] Set the full phase mode
- [Manual Adjustment] Set manually to a faster phase response to increase system performance or to slower phase response to increase DRAM power efficiency.



DO NOT remove the thermal module when setting this item to **[Extreme]** and **[Manual Adjustment]**. The thermal conditions should be monitored.



The following item appears only when you set the CPU Power Phase Control to **[Manual Adjustment]**.

Manual Adjustment [Fast]

Allows you to set a response for the CPU power phase control.
Configuration options: [Ultra Fast] [Fast] [Medium] [Regular]

CPU Power Duty Control [T.Probe]

DIGI + VRM Duty Control adjusts the current of every VRM phase and the thermal conditions of every phase component.

- [T. Probe] Select to maintain the VRM thermal balance.
- [Extreme] Select to maintain the current VRM balance.



DO NOT remove the thermal module. The thermal conditions should be monitored.

CPU Current Capability [Auto]

DIGI + VRM CPU Current Capability provides wider total power range for overclocking. A higher value setting gets higher VRM power consumption delivery and extends the overclocking frequency range simultaneously.

Configuration options: [Auto] [100%] [110%] [120%] [130%] [140%]



Choose a higher value when overclocking or under a high CPU loading for extra power support.

CPU Power Thermal Control [130]

A higher temperature brings a wider CPU power thermal range and extends the overclocking tolerance to enlarge the O.C. potential. Use the <+> and <-> keys to adjust the value. The values range from 130 to 151.



DO NOT remove the thermal module. The thermal conditions should be monitored.

CPU Input Boot Voltage [Auto]

VCCIN for the CPU right at boot. Configuration options: [Auto] [0.800] – [2.440V]

DRAM Current Capability [100%]

A higher value brings a wider total power range and extends the overclocking range simultaneously.

Configuration options: [100%] [110%] [120%] [130%]

DRAM Voltage Frequency [Auto]

Allows you to adjust the DRAM switching frequency. Assign a fixed high DRAM frequency to increase the overclocking range or a low DRAM frequency for a better system stability.

Configuration options: [Auto] [Manual]



The following item appears only when you set the DRAM Frequency Mode item to [Manual].

DRAM Fixed Frequency Mode [300]

Allows you to set a fixed DRAM frequency. Use the <+> or <-> keys to adjust the value. The values range from 300kHz to 500kHz with a 10kHz interval.

DRAM Power Phase Control [Auto]

Allows you to set the power phase control of the DRAM.

- | | |
|-------------|--|
| [Auto] | Allows you to set the Auto mode. |
| [Optimized] | Allows you to set the ASUS optimized phase tuning profile. |
| [Extreme] | Allows you to set the full phase mode. |

Tweakers' Paradise

The subitems in this menu allow you to set the CPU ratio and features.

VCCIN Shadow Voltage [Auto]

Pseudo Voltage for VCCIN. Configuration options: [Auto] [0.800] – [2.440V]

Termination Anti-Aliasing [Auto]

Termination Anti-Aliasing. Configuration options: [Auto] [Disabled] [Enabled]

Initial PLL Termination Voltage [Auto]

Initial Voltage at which CPU BCLKs are terminated. Maintaining a level close to CPU Input Voltage will help BCLK Overclock.

Configuration options: [Auto] [0.0000] - [3.0000]

PLL Termination Reset Voltage [Auto]

PLL Termination Reset Voltage. Configuration options: [Auto] [0.0000] - [3.0000]

Eventual PLL Termination Voltage [Auto]

Eventual PLL Termination Voltage. Configuration options: [Auto] [0.0000] - [3.0000]

X-Talk Cancellation Voltage [Auto]

X-Talk Cancellation Voltage. Configuration options: [Auto] [Auto] [0.500] - [1.650]

Cancellation Drive Strength [Auto]

Drive Strength for Xtalk Cancellation Voltage. Configuration options: [Auto] [+4] - [-4]

PCH ICC Voltage [Auto]

Power Supply for the Integrated Clock Controller. Lower may be better. Configuration options: [Auto] [0.6000] -[-2.2000]

ICC Ringback Canceller [Auto]

Allows you to control the noise level at the Integrated Clock Controller.

[Auto] Automatically selects the DMI Frequency O.C.

[Disable] Select to allow better low DMI Frequency O.C.

[Enable] Select to allow better high DMI Frequency O.C.

Clock Crossing VBoot [Auto]

The instantaneous voltage value when the rising edge of BCLK DN is equal to the falling edge of the BCLK DP. Configuration options: [Auto] [0.1000] - [1.9000]

Clock Crossing Reset Voltage [Auto]

The instantaneous voltage value when the rising edge of BCLK DN is equal to the falling edge of the BCLK DP. Configuration options: [Auto] [0.1000] - [1.9000]

Clock Crossing Voltage [Auto]

The instantaneous voltage value when the rising edge of BCLK DN is equal to the falling edge of the BCLK DP. Configuration options: [Auto] [0.1000] - [1.9000]

PECI Voltage [Auto]

Power Supply for the Platform Environment Control Interface. Try to maintain 100mV to close to PCH 1.05V Configuration options: [Auto] [0.3000] - [1.8000]

BCLK Amplitude [Auto]

Allows you to adjust the magnitude of the BCLK.

Configuration options: [Auto] [+5] - [-5]

DMI Gen 2 [Auto]

Allows you to enable or disable DMI Gen 2. Auto means Enabled. Configuration options: [Auto] [Enabled] [Disabled]

DMI De-emphasis Control [-6 dB]

Configure De-emphasis control on DMI. Configuration options: [-6 dB] [-3.5 dB]

SATA Drive Strength [Auto]

SATA Drive Strength. Configuration options: [Auto] [+10] - [-10]

CPU PCIE Controller [Enabled]

CPU PCIE Controller. Configuration options: [Disabled] [Enabled]

Gen3 Preset [Auto]

Selecting the presets improves the stability of PCIE Gen 3.0.

Configuration options: [Auto] [Preset1] [Preset2] [Preset3]

PLX +0.9V Core Voltage [Auto]

This is the Core Voltage for PLX Gen 3.0 Bridge Chip. Default value is 0.90V. Voltage is disabled if no cards are present on it's allocated slots.

Configuration options: [Auto] [0.600] - [1.110]

PLX +1.8V AUX Voltage [Auto]

AUX Voltage for PLX Gen 3.0 Bridge Chip. Default value is 1.80V. Voltage is disabled if no cards are present on it's allocated slots.

Configuration options: [Auto] [1.200] - [2.500]

PCIE Clock Amplitude [Auto]

Adjust the magnitude of the PCIE Clocks. Higher may be better.

Configuration options: [Auto] [+5] - [-4]

Internal Graphics [Auto]

Keep IGD enabled based on setup options.

Configuration options: [Auto] [Disabled] [Enabled]

CPU Power Management

The subitems in this menu allow you to set the CPU ratio and features.

Enhanced Intel SpeedStep Technology [Enabled]

Allows the operating system to dynamically adjust the processor voltage and cores frequency to decrease the average power consumption and decrease average heat production.

Configuration options: [Enabled] [Disabled]

Turbo Mode [Enabled]

Allows you to enable your processor cores to run faster than the base operating frequency when it is below power, current and specification limit.

Configuration options: [Disabled] [Enabled]



The following items appear only when you set the Turbo Mode to **[Enabled]**.

Turbo Mode Parameters

Long Duration Package Power Limit [Auto]

Allows you to limit the Turbo Ratio's time duration that exceeds the TDP (Thermal Design Power) for maximum performance. Use the <+> and <-> keys to adjust the value. The values range from 1W to 4096W.

Package Power Time Window [Auto]

Also known as Power Limit 1, and allows you to maintain the time window for Turbo Ratio over TDP (Thermal Design Power). Use the <+> and <-> keys to adjust the value. The values range from 1 second to 127 seconds.

Short Duration Package Power Limit [Auto]

Also known as Power Limit 2, and allows you to provide rapid protection when the package power exceeds the Power Limit 1. Use the <+> and <-> keys to adjust the value. The values range from 1W to 4096W.

CPU Integrated VR Current Limit [Auto]

Allows you to set a higher current limit to prevent frequency and power throttling when overclocking. Use the <+> and <-> keys to adjust the value. The values range from 0.125 to 1023.875 with a 0.125 interval.

CPU Internal Power Switching Frequency

Frequency Tuning Mode [Auto]

Allows you to increase or decrease the switching frequency of the internal regulator. Decrease to help consume less power or increase to help voltage stability. When this item is set to **[+]** or **[-]**, the Frequency Tuning Offset appears and allows you to set its value from 0% to 6%.

CPU Internal Power Fault Control

Thermal Feedback [Auto]

Allows the CPU to take precautionary actions when the thermal conditions of the external regulator exceeds the threshold.

Configuration options: [Auto] [Disabled] [Enabled]

CPU Integrated VR Fault Management [Auto]

Allows you to prevent tripping the Fully Integrated Voltage Regulator when doing over-voltage. Configuration options: [Auto] [Disabled] [Enabled]



We recommend to set this item to [Disable] when overclocking.

CPU Internal Power Configuration

CPU Integrated VR Efficiency Management [Auto]

Allows you to improve power saving when the processor is in low power state. Disable this item to make the Fully Integrated Voltage Regulator work in high performance at all times.

Configuration options: [Auto] [High Performance] [Balanced]

Power Decay Mode [Auto]

Allows you to enable this item to improve the power saving on the Fully Integrated Voltage Regulator as the processor goes into low current state.

Configuration options: [Auto] [Disabled] [Enabled]

Idle Power-in Response [Auto]

Allows you to set the slew rate for the Fully Integrated Voltage Regulator as it enters manual override mode.

Configuration options: [Auto] [Regular] [Fast]

Idle Power-out Response [Auto]

Allows you to set the slew rate for the Fully Integrated Voltage Regulator as it exits manual override mode.

Configuration options: [Auto] [Regular] [Fast]

Power Current Slope [Auto]

Allows you to adjust the gradient of the high-speed active phase current balance during load transients to eliminate current imbalance, resulting from a load current oscillating near the switching frequency.

Configuration options: [Auto] [LEVEL -4] - [LEVEL 4]

Power Current Offset [Auto]

Allows you to increase or decrease the output current sensed by the CPU. It finds the balance between optimal regulating while staying below the current threshold.

Configuration options: [Auto] [100%] [87.5%] [75.0%] [62.5%] [50.0%] [37.5%] [25.0%] [12.5%] [0%] [-12.5%] [-25.0%] [-37.5%] [-50.0%] [-62.5%] [-75.0%] [-87.5%] [-100%]

Power Fast Ramp Response [Auto]

Allows you to increase to enhance the response of the voltage regulator during the load transient.

Configuration options: [Auto] [0.00] - [1.50]

CPU Internal Power Saving Control

Power Saving Level 1-3 Threshold [Auto]

Allows you to set the power saving threshold for overclocking. A low value provides enough power for overclocking. A high value provides a better power saving condition. The value ranges from:

Level 1 0 - 80A

Level 2 0 - 50A

Level 3 0 - 30A

3.5 Main menu

The Main menu screen appears when you enter the Advanced Mode of the BIOS Setup program. The Main menu provides you an overview of the basic system information, and allows you to set the system date, time, language, and security settings.



Security

The Security menu items allow you to change the system security settings.

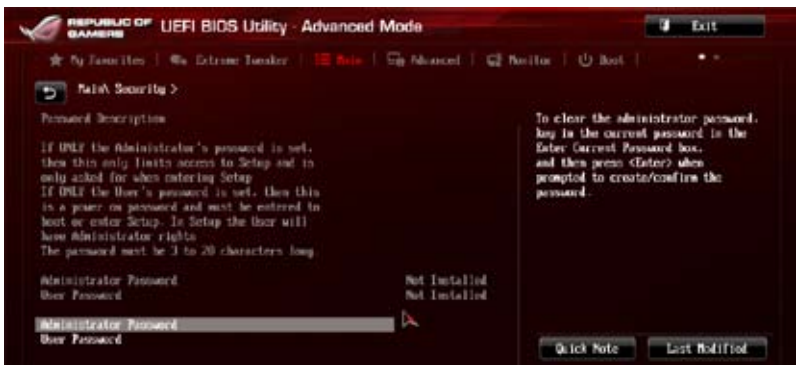

- If you have forgotten your BIOS password, erase the CMOS Real Time Clock (RTC) RAM to clear the BIOS password. See section 2.3.1 **Rear I/O Connection** for information on how to erase the RTC RAM via the Clear CMOS button.
- The Administrator or User Password items on top of the screen show the default [Not Installed]. After you set a password, these items show [Installed].

Administrator Password

If you have set an administrator password, we recommend that you enter the administrator password for accessing the system. Otherwise, you might be able to see or change only selected fields in the BIOS setup program.

To set an administrator password:

1. Select the **Administrator Password** item and press <Enter>.
2. From the **Create New Password** box, key in a password, then press <Enter>.
3. Confirm the password when prompted.

To change an administrator password:

1. Select the **Administrator Password** item and press <Enter>.
2. From the **Enter Current Password** box, key in the current password, then press <Enter>.
3. From the **Create New Password** box, key in a new password, then press <Enter>.
4. Confirm the password when prompted.

To clear the administrator password, follow the same steps as in changing an administrator password, but press <Enter> when prompted to create/confirm the password. After you clear the password, the **Administrator Password** item on top of the screen shows **Not Installed**.

User Password

If you have set a user password, you must enter the user password for accessing the system. The User Password item on top of the screen shows the default Not Installed. After you set a password, this item shows Installed.

To set a user password:

1. Select the **User Password** item and press <Enter>.
2. From the **Create New Password** box, key in a password, then press <Enter>.
3. Confirm the password when prompted.

To change a user password:

1. Select the **User Password** item and press <Enter>.
2. From the **Enter Current Password** box, key in the current password, then press <Enter>.
3. From the **Create New Password** box, key in a new password, then press <Enter>.
4. Confirm the password when prompted.

To clear the user password, follow the same steps as in changing a user password, but press <Enter> when prompted to create/confirm the password. After you clear the password, the **User Password** item on top of the screen shows **Not Installed**.

3.6 Advanced menu

The Advanced menu items allow you to change the settings for the CPU and other system devices.



Be cautious when changing the settings of the Advanced menu items. Incorrect field values can cause the system to malfunction.



3.6.1 CPU Configuration

The items in this menu show the CPU-related information that the BIOS automatically detects.



The items in this menu may vary based on the CPU installed.



Intel Adaptive Thermal Monitor [Enabled]

- [Enabled] Enables the overheated CPU to throttle its clock speed to cool down.
- [Disabled] Disables the CPU thermal monitor function.

Hyper-threading [Enabled]

Allows a hyper-threading processor to appear as two logical processors, allowing the operating system to schedule two threads or processes simultaneously.

- [Enabled] Two threads per activated core.
- [Disabled] One thread per activated core.

Active Processor Cores [All]

Allows you to choose the number of CPU cores to activate in each processor package. Configuration options: [All] [1] [2] [3]

Limit CPUID Maximum [Disabled]

- [Enabled] Allows legacy operating systems to boot even without support for CPUs with extended CPUID functions.
- [Disabled] Disables this function.

Execute Disable Bit [Enabled]

[Enabled] Enables the No-Execution Page Protection Technology.

[Disabled] Forces the XD feature flag to always return to zero (0).

Intel® Virtualization Technology [Disabled]

[Enabled] Allows a hardware platform to run multiple operating systems separately and simultaneously, enabling one system to virtually function as several systems.

[Disabled] Disables this function.

Hardware Prefetcher [Enabled]

[Enabled] Allows a hardware platform to automatically analyze the requirements and prefetch data and codes for the CPU.

[Disabled] Disables this function.

Adjacent Cache Line Prefetch [Enabled]

[Enabled] Allows a hardware platform to perform adjacent cache line prefetching.

[Disabled] Disables this function.

Boot Performance Mode [Max Non-Tu...]

Allows you to select the performance state that the BIOS will set before OS handoff.

Configuration options: [Max Non-Turbo Performance] [Max Battery] [Turbo Performance]

Dynamic Storage Accelerator [Disabled]

Allows you to enable or disable the Dynamic Storage Accelerator for C state configuration.

Configuration options: [Enabled] [Disabled]

CPU Power Management Configuration

The subitems in this menu allows you to manage and configure the CPU's power.

EIST [Enabled]

Allows you to enable or disable the Enhanced Intel® SpeedStep Technology (EIST).

[Disabled] The CPU runs at its default speed.

[Enabled] The operating system controls the CPU speed.

Turbo Mode [Enabled]

Allows you to set the processor cores to run faster than the marked frequency in a specific condition. Configuration options: [Enabled] [Disabled]

CPU C States [Auto]

Allows you to enable or disable the CPU C states.

Configuration options: [Auto] [Enabled] [Disabled]



The following items appear only when you set the CPU C States to **[Enabled]**.

Enhanced C1 state [Enabled]

Allows your processor to reduce power when the system is in idle mode.

Configuration options: [Enabled] [Disabled]

CPU C3 Report [Enabled]

Allows you to disable or enable the CPU C3 report to the operating system.

Configuration options: [Enabled] [Disabled]

CPU C6 Report [Enabled]

Allows you to disable or enable the CPU C6 report to the operating system.

Configuration options: [Enabled] [Disabled]

C6 Latency [Short]

Allows you to configure the Short/Long latency for C6.

Configuration options: [Short] [Long]

CPU C7 Report [CPU C7]

Allows you to disable or enable the CPU C7 report to the operating system.

Configuration options: [Disabled] [CPU C7] [CPU C7s]

C7 Latency [Long]

Allows you to configure the Short/Long latency for C7.

Configuration options: [Short] [Long]

Package C State Support [Auto]

Allows you to set the C-state according to the following configuration options: [Auto] [Enabled] [C0/C1] [C2] [C3] [C6] [CPU C7] [CPU C7s]

3.6.2 PCH Configuration

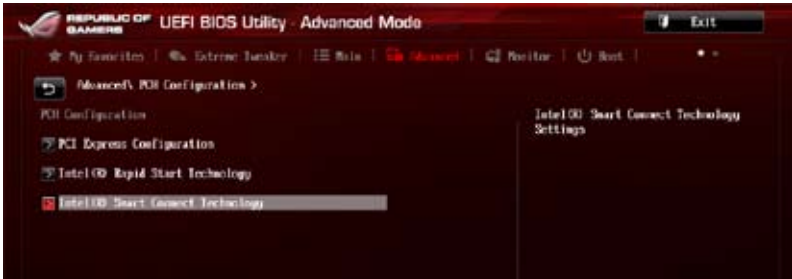

PCI Express Configuration

Allows you to configure the PCI Express slots.

DMI Link ASPM Control [Auto]

Allows you to control the ASPM (Active State Power Management) on both Northbridge side and Southbridge side of the DMI Link.

Configuration options: [Auto] [Disabled] [Enabled]

ASPM Support [Disabled]

Allows you to set the ASPM level.

Configuration options: [Disabled] [Auto] [L0s] [L1] [L0sL1]

PCIe Speed [Auto]

Allows you to select the PCI Express port speed.

Configuration options: [Auto] [Gen1] [Gen2]

Intel® Rapid Start Technology [Disabled]

Allows you to enable or disable Intel Rapid Start Technology.



The following items appear only when you set the Intel® Rapid Start Technology to **[Enabled]**.

Entry on S3 RTC Wake [Enabled]

The system automatically wakes up and set to Rapid Start Technology S4 mode.

Configuration options: [Enabled] [Disabled]

Entry After [0]

This item appears only when you set the **Entry on S3 RTC Wake to [Enabled]**. This item allows you to enable the RTC wake timer at S3 entry. The value ranges from 0 (Immediately) to 120 minutes

Active Page Threshold Support [Enabled]

Allows you to enable or disable the IRST with additional partition size.

Configuration options: [Enabled] [Disabled]



Ensure that the caching partition size is larger than the total memory size.

Active Memory Threshold [0]

This item appears only when you set the **Active Page Threshold Support to [Enabled]**. This item allows you to allocate a partition size for Active Page Threshold.

Hybrid Hard Disk Support [Disabled]

Allows you to enable or disable Hybrid Hard Disk support.

Configuration options: [Enabled] [Disabled]

Intel (R) Smart Connect Technology

Allow you to enable or disable Intel Smart Connect Technology.

ISCT Configuration [Disabled]

Allows you to enable or disable ISCT Configuration.

Configuration options: [Enabled] [Disabled]

3.6.3 SATA Configuration

While entering Setup, the BIOS automatically detects the presence of SATA devices. The SATA Port items show **Empty** if no SATA device is installed to the corresponding SATA port. Scroll down to display the other BIOS items.



SATA Mode Selection [AHCI]

Allows you to set the SATA configuration.

[Disabled] Disables the SATA function.

[IDE] Set to [IDE] when you want to use the Serial ATA hard disk drives as Parallel ATA physical storage devices.

[AHCI] Set to [AHCI] when you want the SATA hard disk drives to use the AHCI (Advanced Host Controller Interface). The AHCI allows the onboard storage driver to enable advanced Serial ATA features that increases storage performance on random workloads by allowing the drive to internally optimize the order of commands.

[RAID] Set to [RAID] when you want to create a RAID configuration from the SATA hard disk drives.

Aggressive LPM Support [Auto]

Allows you to enable the PCH to aggressively enter link power state.

Configuration options: [Auto] [Disabled] [Enabled]

S.M.A.R.T. Status Check [Enabled]

S.M.A.R.T. (Self-Monitoring, Analysis and Reporting Technology) is a monitor system. When read/write of your hard disk errors occur, this feature allows the hard disk to report warning messages during the POST. Configuration options: [Enabled] [Disabled]

Hot Plug [Disabled] (SATA6G_1 - SATA6G_6 [Red])

These items appear only when you set the SATA Mode Selection item to [AHCI] or [RAID], and allow you to enable/disable SATA Hot Plug Support.

Configuration options: [Disabled] [Enabled]

3.6.4 System Agent Configuration



VT-d [Disabled]

Allows you to enable the virtualization technology function on the memory control hub (MCH).

[Enabled] Enables the function.

[Disabled] Disables this function.

CPU Audio Devices [Enabled]

Allows you to enable or disable CPU SA Audio devices.

Configuration options: [Enabled] [Disabled]

Graphics Configuration

Allows you to select a primary display from iGPU, and PCIe graphical devices.

Primary Display [Auto]

Allows you to select the primary display from iGPU, PCIE and PCI Graphics devices.

Configuration options: [Auto] [iGPU] [PCIE]

iGPU Memory [Auto]

Allows you to select the amount of system memory allocated to DVMT 5.0 by the iGPU.

Configuration options: [Auto] [32M] [64M] [96M] [128M] [160M] [192M] [224M] [256M] [288M] [320M] [352M] [384M] [416M] [448M] [480M] [512M] [1024M]

Render Standby [Auto]

Allows you to enable the Intel® Graphics Render Standby support to reduce iGPU power use when the system is idle.

Configuration options: [Auto] [Disabled] [Enabled]

iGPU Multi-Monitor [Disabled]

Allows you to enable both integrated and discrete graphics for multi-monitor output. The iGPU shared system memory size will be fixed at 64MB.

Configuration options: [Disabled] [Enabled]

NB PCIe Configuration

Allows you to configure the NB PCI Express settings.

PCIEX16/X8_1 / X16_A2 / X8_B2 / X8_3 / X8_4 Link Speed [Auto]

Allows you to configure the PCIEX16/X8.

Configuration options: [Auto] [Gen1] [Gen2] [Gen3]

PCIEX16_1 Full x16 Bandwidth [Disabled]

Allows you to enable or disable full PCIe x16 bandwidth to PCIEX16_1 slot. When enabled, all the other PCIe x16 slots are disabled.

Configuration options: [Enabled] [Disabled]

DMI Link ASPM Control [Auto]

Allows you to enable or disable the control of Active State Power Management on SA side of the DMI Link.

Configuration options: [Auto] [Disabled] [L0s] [L1] [L0sL1]

PEG - ASPM [Disabled]

Allows you to control ASPM support for the PEG device.

Configuration options: [Disabled] [Auto] [ASPM L0s] [ASPM L1] [ASPM L0sL1]

Memory Configuration

Allows you to configure the memory configuration parameters.

Memory Remap [Enabled]

Allows you to enable remapping the memory above 4GB.

Configuration options: [Enabled] [Disabled]

3.6.5 USB Configuration

The items in this menu allow you to change the USB-related features.



The **USB Devices** item shows the auto-detected values. If no USB device is detected, the item shows **None**.

Legacy USB Support [Enabled]

- [Enabled] Enables the support for USB devices on legacy operating systems (OS).
- [Disabled] The USB devices can be used only for the BIOS setup program. It cannot be recognized in boot devices list.
- [Auto] Allows the system to detect the presence of USB devices at startup. If detected, the USB controller legacy mode is enabled. If no USB device is detected, the legacy USB support is disabled.

Intel xHCI Mode [Auto]

- [Auto] Keeps the last operation of xHCI controller in OS during bootup.
- [Smart Auto] Enables the operation of xHCI controller.
- [Enabled] Enables the xHCI controller.
- [Disabled] Disables the xHCI controller.

EHCI Hand-off [Disabled]

- [Enabled] Enables the support for operating systems without an EHCI hand-off feature.
- [Disabled] Disables the EHCI Hand-off support.

USB Single Port Control

Allows you to enable or disable the individual USB port.



Refer to section **1.2.2 Motherboard layout** for the location of the USB ports.

3.6.6 Platform Misc Configuration

The items in this menu allow you to configure the platform-related features.



PCI Express Native Power Management [Disabled]

Allows you to enhance the power saving feature of PCI Express and perform ASPM operations in the operating system.

Configuration options: [Disabled] [Enabled]



The following item appears only when you set the PCI Express Native Power Management to **[Enabled]**.

Native ASPM [Disabled]

- [Enabled] Vista controls the ASPM support for the device.
- [Disabled] BIOS controls the ASPM support for the device.

3.6.7 Onboard Devices Configuration

Scroll down to view the other BIOS items.



HD Audio Controller [Enabled]

[Enabled] Enables the High Definition Audio Controller.

[Disabled] Disables the controller.



The following items appear only when you set the HD Audio Controller to **[Enabled]**.

Front Panel Type [HD]

Allows you to set the front panel audio connector (AAFP) mode to legacy AC'97 or high-definition audio depending on the audio standard that the front panel audio module supports.

[HD Audio] Sets the front panel audio connector (AAFP) mode to high definition audio.

[AC97] Sets the front panel audio connector (AAFP) mode to legacy AC'97

SPDIF Out Type [SPDIF]

[SPDIF] Sets to an SPDIF audio output.

[HDMI] Sets to an HDMI audio output.

Bluetooth Controller [Enabled]

Allows you to enable or disable the Bluetooth controller.

Configuration options: [Enabled] [Disabled]

Wi-Fi Controller [Enabled]

Allows you to enable or disable the Wi-Fi controller.

Configuration options: [Enabled] [Disabled]

ASM1061 Storage Controller SATA6G_E12/E34 [Enabled]

Allows you to select the ASM1061 storage controller operating mode.

[Disabled] Disables the controller.

[Enabled] Enables the controller.

Hot-plug [Disabled]

[Disabled] Disables the hot-plug support.

[Enabled] Enables the hot-plug support.

Intel LAN Controller [Enabled]

[Enabled] Enables the GbE controller.

[Disabled] Disables the controller.

Intel PXE OPROM [Disabled]

This item appears only when you set the previous item to [Enabled]. It allows you to enable or disable the PXE OptionRom of the Intel® I217-V LAN controller.

Configuration options: [Enabled] [Disabled]

3.6.8 APM



ErP Ready [Disabled]

Allows you to switch off some power at S4+S5 or S5 to get the system ready for ErP requirement. When set to **[Enabled]**, all other PME options will be switched off.

Configuration options: [Disabled] [Enabled (S4+S5)] [Enabled (S5)]

Restore AC Power Loss [Power Off]

[Power On] The system goes into ON state after an AC power loss.

[Power Off] The system goes into OFF state after an AC power loss.

[Last State] The system goes into either OFF or ON state, whatever the system state was before the AC power loss.

Power On By PS/2 Keyboard [Disabled]

Allows you to disable or specify the keys in the PS/2 keyboard that you can use to activate Power On.

Configuration options: [Disabled] [Space Bar] [Ctrl-Esc] [Power Key]

Power On By PCIE/PCI [Disabled]

[Disabled] Disables the PCIE/PCI devices to generate a wake-on-LAN feature of the Intel®/Realtek LAN device or other installed PCIE LAN devices.

[Enabled] Enables the PCIE/PCI devices to generate a wake-on-LAN feature of the PCIE LAN devices.

Power On By RTC [Disabled]

[Disabled] Disables RTC to generate a wake event.

[Enabled] When set to **[Enabled]**, the items **RTC Alarm Date (Days)** and **Hour/Minute/Second** will become user-configurable with set values.

3.6.9 Network Stack Configuration



Network Stack [Disabled]

This item allows you to disable or enable the UEFI network stack.

Configuration options: [Disabled] [Enable]



The following items appear only when you set the Network Stack to [Enabled].

Ipv4/Ipv6 PXE Support [Enabled]

Allows you to enable or disable the Ipv4/Ipv6 PXE boot option.

Configuration options: [Disabled] [Enabled]

3.6.10 ROG Effects



ROG Pulse [Enabled]

This item allows ROG animation on the upper left corner of the UEFI BIOS Utility screen when enabled.

Configuration options: [Disabled] [Enabled]

Onboard LED [Enabled]

This item allows you to enable or disable all the onboard LEDs.

Configuration options: [Enabled] [Disabled]

3.7 Monitor menu

The Monitor menu displays the system temperature/power status, and allows you to change the fan settings.



Anti Surge Support [Enabled]

This item allows you to enable or disable the Anti Surge function.

Configuration options: [Disabled] [Enabled]

Voltage Monitor

CPU Core 0-3 Voltage; CPU Cache Voltage; CPU System Agent Voltage; CPU Analog I/O Voltage; CPU Digital I/O Voltage; CPU Input Voltage; DRAM Voltage; PCH Voltage; 3.3V Voltage; 5V Voltage; 12V Voltage

The onboard hardware monitor automatically detects the voltage output through the onboard voltage regulators. Press <Enter> and select [Ignore] if you do not wish to display the detected temperatures.

Temperature Monitor

CPU Temperature; MB Temperature; PLX Temperature; OPT1-3 Temperature;

[xxx°C/xxx°F]

The onboard hardware monitor automatically detects and displays the CPU, and motherboard. Press <Enter> and select [Ignore] if you do not wish to display the detected temperatures.

PLX Temperature Protection [105]

Shutdown when PLX Bridge Chip reaches this temperature. Minimum is 90 degrees and maximum is 110 degrees.

Fan Speed Monitor

CPU FAN Speed; CPU OPT Speed; Chassis FAN1/2/3 Speed; Opt1/2/3 Fan Speed [xxxxRPM] or [Ignored] / [N/A]

The onboard hardware monitor automatically detects and displays the CPU fan, chassis fan, and optional fan speed in rotations per minute (RPM). If any of the fans is not connected to the motherboard, the field shows [N/A]. These items are not user-configurable. Press <Enter> and select [Ignore] if you do not wish to display the detected temperatures.

Fan Speed Control

CPU Q-Fan Control [Auto]

Allows you to set the CPU Q-Fan operating mode.

[Disabled] Disables the CPU Q-Fan control feature.

[Advance Mode] Detect the type of CPU fan installed and automatically switches the mode control. When a 3-pin CPU fan is installed, select this mode for the DC mode Q-Fan control.

[Auto] Enables the CPU Q-Fan control feature in PWM mode for 4-pin CPU fan.

CPU Fan Speed Low Limit [600 RPM]

Allows you to disable or set the CPU fan warning speed.

Configuration options: [Ignore] [200 RPM] [300 RPM] [400 RPM] [500 RPM] [600 RPM]

CPU Fan Profile [Standard]

Allows you to set the appropriate performance level of the CPU fan.

[Standard] Set to make the CPU fan adjust automatically depending on the CPU temperature.

[Silent] Set to minimize the fan speed for quiet CPU fan operation.

[Turbo] Set to achieve maximum CPU fan speed.

[Manual] Set to assign the detailed fan speed control parameters.



The following items appear only when you set the CPU Fan Profile to **[Manual]**.

CPU Upper Temperature [70]

Use the <+> and <-> keys to adjust the upper limit of the CPU temperature. The values range from 20°C to 75°C.

CPU Fan Max. Duty Cycle(%) [100]

Use the <+> and <-> keys to adjust the maximum CPU fan duty cycle. The values range from 40% to 100%. When the CPU temperature reaches the upper limit, the CPU fan will operate at the maximum duty cycle.

CPU Lower Temperature [20]

Displays the lower limit of the CPU temperature.

CPU Fan Min. Duty Cycle(%) [40]

Use the <+> and <-> keys to adjust the minimum CPU fan duty cycle. The values range from 40% to 100%. When the CPU temperature is under its CPU lower temperature setting, the CPU fan will operate at the minimum duty cycle.

Chassis Q-Fan Control 1-3 [Disabled]

[Disabled] Disables the Chassis Q-Fan control feature.

[Enabled] Enables the Chassis Q-Fan control feature.

Chassis Fan Speed Low Limit 1-3 [600 RPM]

This item appears only when you enable the **Chassis Q-Fan Control** feature and allows you to disable or set the chassis fan warning speed.

Configuration options: [Ignore] [200 RPM] [300 RPM] [400 RPM] [500 RPM] [600 RPM]

Chassis Fan Profile [Standard]

This item appears only when you enable the **Chassis Q-Fan Control** feature and allows you to set the appropriate performance level of the chassis fan.

[Standard] Sets to [Standard] to make the chassis fan automatically adjust depending on the chassis temperature.

[Silent] Sets to [Silent] to minimize the fan speed for quiet chassis fan operation.

[Turbo] Sets to [Turbo] to achieve maximum chassis fan speed.

[Manual] Sets to [Manual] to assign detailed fan speed control parameters.



The following four items appear only when you set **Chassis Fan Profile** to **[Manual]**.

Chassis Upper Temperature [70]

Use the <+> and <-> keys to adjust the upper limit of the chassis temperature. The values range from 40°C to 75°C.

Chassis Fan Max. Duty Cycle(%) [100]

Use the <+> and <-> keys to adjust the maximum chassis fan duty cycle. The values range from 60% to 100%. When the chassis temperature reaches the upper limit, the chassis fan will operate at the maximum duty cycle.

Chassis Lower Temperature [40]

Displays the lower limit of the chassis temperature.

Chassis Fan Min. Duty Cycle(%) [60]

Use the <+> and <-> keys to adjust the minimum chassis fan duty cycle. The values range from 60% to 100%. When the chassis temperature is under 40°C, the chassis fan will operate at the minimum duty cycle.

OPTFAN 1-3 Control [Disabled]

Allows you to disable or set the optional fans' warning speeds.

Configuration options: [Disabled] [Duty Mode] [Profile Mode] [User Mode]



The following items appear only when you set **OPTFAN 1-3** to **[Duty Mode]**.

OPTFAN 1-3 Duty

Allows you to set the optional fans' speed duty percentagea.

Configuration options: [50%] [60%] [70%] [80%] [90%]

Profile Mode

Allows you to set the optional fans' profiles.

Configuration options: [Performance] [Optional] [Silent]



The following four items appear only when you set OPTFAN 1/2/3 to **[Profile Model]**.

OPT Fan 1/2/3 Profile

Allows you to set the optional fans' profiles.

Configuration options: [Performance] [Optional] [Silent]

User Mode

Allows you to set the optional fan's speed temperature.

OPT1-3 Low Speed Temp [25%]

Allows you to set the optional fans' low speed temperature.

Configuration options: [25%] [30%] [35%] [40%]

OPT1-3 Full Speed Temp [60%]

Allows you to set the optional fans' full speed temperature.

Configuration options: [60%] [70%] [80%] [90%]

3.8 Boot menu

The Boot menu items allow you to change the system boot options. Scroll down to display the other BIOS items.



Boot Configuration

Fast Boot [Disabled]

[Disabled] Allows your system to go back to its normal boot speed.

[Enabled] Allows your system to accelerate the boot speed.



The following items appear only when you set the Fast Boot to **[Enabled]**.

USB Support [Partial In...]

[Disabled] All USB devices will not be available until OS boot up for a fastest POST time.

[Full Initialization] All USB devices will be available during POST. This process will extend the POST time.

[Partial Initialization] For a faster POST time, only USB ports with keyboard and mouse connections will be detected.

P/2 Keyboard and Mouse Support [Auto]

Allows you to disable or have full system control of the PS/2 devices' availability during POST.

Configuration options: [Disabled] [Full Initialization] [Auto]

Network Stack Driver Support [Disabled]

- [Disabled] Select to skip the network stack driver from loading during POST.
- [Enabled] Select to load the network stack driver during POST.

Next Boot after AC Power Loss [Normal Boot]

- [Normal Boot] Returns to normal boot on the next boot after an AC power loss.
- [Fast Boot] Accelerates the boot speed on the next boot after an AC power loss.

Hardware Fast Boot [Disabled]

Allows the system to enable or disable the HW Fast Boot.

Configuration options: [Disabled] [Enabled]

DirectKey [Enabled]

- [Disabled] Disables the DirectKey button. The system will only power on or off when you press the DirectKey button.
- [Enabled] Allows the system to power on and go to the BIOS Setup directly when you press the DirectKey button.

Boot Logo Display [Auto]

- [Auto] Auto adjusts the Boot Logo size for Windows requirements.
- [Full Screen] Maximizes the Boot Logo size.
- [Disabled] Hides the boot logo during POST.



The following items appears only when you set the Boot Logo Display item to **[Auto]** or **[Full Screen]**.

POST Delay Time [3 sec]

This item allows you to select a desired additional POST waiting time to easily enter the BIOS Setup. You can only execute the POST delay time during normal boot. The values range from 0 to 10 seconds. This feature will only work when set under normal boot.



The following items appears only when you set the Boot Logo Display item to **[Disabled]**.

POST Report [5 sec]

This item allows you to select a desired POST report waiting time.
Configuration options: [1 sec] - [2 sec] [Until Press ESC]

Bootup NumLock State [On]

- [On] Set the power-on state of the NumLock to **[On]**.
- [Off] Set the power-on state of the NumLock to **[Off]**.

Wait For 'F1' If Error [Enabled]

- [Disabled] Disables the function.
- [Enabled] The system waits for the <F1> key to be pressed when error occurs.

Option ROM Messages [Force BIOS]

- [Force BIOS] The third-party ROM messages will be forced to display during the boot sequence.
- [Keep Current] The third-party ROM messages will be displayed only if the third-party manufacturer had set the add-on device to do so.

Interrupt 19 Capture [Enabled]

When set to [Enabled], allows the option ROMs to trap Interrupt 19.

Configuration options: [Enabled] [Disabled]

Setup Mode [Advanced Mode]

- [Advanced Mode] Sets Advanced Mode as the default screen for entering the BIOS setup program.
- [EZ Mode] Sets EZ Mode as the default screen for entering the BIOS setup program.

CSM (Compatibility Support Module)

Allows you to configure the CSM (Compatibility Support Module) items to fully support the various VGA, bootable devices and add-on devices for better compatibility.

Launch CSM [Auto]

- [Auto] The system automatically detects the bootable devices and the add-on devices.
- [Enabled] For better compatibility, enable the CSM to fully support the non-UEFI driver add-on devices or the Windows® UEFI mode.
- [Disabled] Disable the CSM to fully support the non-UEFI driver add-on devices or the Windows® UEFI mode.



The following items appear when you set the Launch CSM to **[Enabled]**.

Boot Device Control [UEFI and L...]

Allows you to select the type of devices that you want to boot.

Configuration options: [UEFI and Legacy OPROM] [Legacy OPROM only] [UEFI only]

Boot from Network Devices [Legacy OPR...]

Allows you to select the type of network devices that you want to launch.

Configuration options: [Legacy OPROM first] [UEFI driver first] [Ignore]

Boot from Storage Devices [Legacy OPR...]

Allows you to select the type of storage devices that you want to launch.

Configuration options: [Both, Legacy OPROM first] [Both, UEFI first] [Legacy OPROM first] [UEFI driver first] [Ignore]

Boot from PCIe/PCI Expansion Devices [Legacy OPR...]

Allows you to select the type of PCIe/PCI expansion devices that you want to launch.

Configuration options: [Legacy OPROM first] [UEFI driver first]

Secure Boot

Allows you to configure the Windows® Secure Boot settings and manage its keys to protect the system from unauthorized access and malwares during POST.

OS Type [Windows UEFI mode]

[Windows UEFI Mode]	Allows you to select your installed operating system. Execute the Microsoft® Secure Boot check. Only select this option when booting on Windows® UEFI mode or other Microsoft® Secure Boot compliant OS.
[Other OS]	Get the optimized function when booting on Windows® non-UEFI mode, Windows® Vista/ Windows® XP, or other Microsoft® Secure Boot non compliant OS. Microsoft® Secure Boot only supports Windows® UEFI mode.

Key Management

This item appears only when you set Secure Boot Mode to [Windows UEFI mode]. It allows you to manage the Secure Boot keys.

Clear Secure Boot keys

Allows you to all the Secure Boot keys, Platform key (PK), Key-exchange Key (KEK), Signature database (db), and Revoked Signatures (dbx) previously applied. All the Secure Boot keys' state will change from Loaded mode to Unloaded mode. The settings are applied after the reboot or at the next reboot.

Save Secure Boot Keys

Allows you to save the PK (Platform Keys) to a USB storage device.

Boot Option Priorities

These items specify the boot device priority sequence from the available devices. The number of device items that appears on the screen depends on the number of devices installed in the system.



- To access Windows® OS in Safe Mode, do any of the following:
 - Press <F5> when ASUS Logo appears.
 - Press <F8> after POST.
- To select the boot device during system startup, press <F8> when ASUS Logo appears.

Boot Override

These items displays the available devices. The number of device items that appears on the screen depends on the number of devices installed in the system. Click an item to start booting from the selected device.

3.9 Tools menu

The Tools menu items allow you to configure options for special functions. Select an item then press <Enter> to display the submenu.

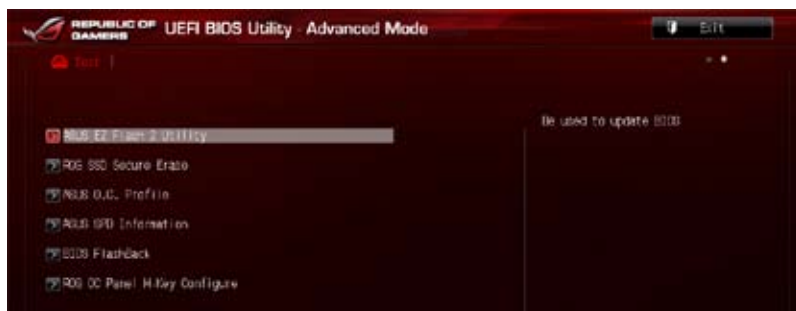

3.9.1 ASUS EZ Flash 2 Utility

Allows you to run ASUS EZ Flash 2. When you press <Enter>, a confirmation message appears. Use the left/right arrow key to select between [Yes] or [No], then press <Enter> to confirm your choice.



For more details, refer to section 3.11.1 ASUS EZ Flash 2 utility.

3.9.2 ASUS O.C. Profile

This item allows you to store or load multiple BIOS settings.

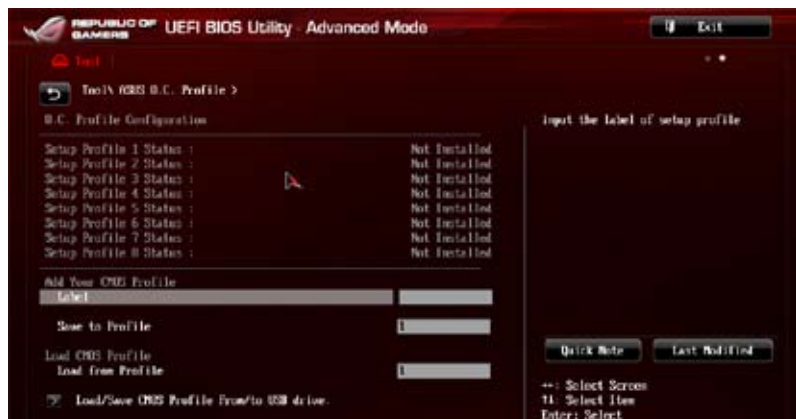

The **O.C. Profile Configuration** items show **Not Installed** if no profile is created.

Label

Allows you to input the label of the setup profiles.

Save to Profile

Allows you to save the current BIOS settings to the BIOS Flash, and create a profile. Key in a profile number from one to eight, press <Enter>, and then select **Yes**.

Load from Profile

Allows you to load the previous BIOS settings saved in the BIOS Flash. Key in the profile number that saved your BIOS settings, press <Enter>, and then select **Yes**.



- DO NOT shut down or reset the system while updating the BIOS to prevent the system boot failure!
- We recommend that you update the BIOS file only coming from the same memory/ CPU configuration and BIOS version.

3.9.3 ASUS SPD Information

Allows you to view the DRAM SPD information.

The screenshot shows the UEFI BIOS Utility in Advanced Mode. The main menu is 'Tool IV SPD Information'. Under 'DIMM Slot #', 'Slot 2' is selected. The SPD information for Slot 2 is displayed as follows:

JEDEC ID	JEDEC
Frequency (MHz)	1866
Voltage (V)	1.500
COSL Latency (tCL)	7
RCSL to COSL (tRCSL)	7
RCSL Precharge (tRP)	7
SRSL	16
SRCL	27

Additional SPD information for Slot 2:

Parameter	Value
Manufacturer	OCZ
Module Size	2048 Mbytes
Maximum Bandwidth	1866 MHz
Part Number	OCZCPH06A10G
Serial Number	
Product Week/Year	
SPD Ext.	

Navigation and Help information:

- ←: Select Screen
- ↑↓: Select Item
- Enter: Select
- ←/→: Change Opt.
- F1: General Help
- F2: Previous Values
- F3: Shortcut
- F4: Add to ShortCut and My Favorites
- F5: Optimized Defaults
- F10: Save ESC: Exit
- F12: Print Screen

Buttons: Quick Note, List Modified

Version 2.10-1286 Copyright (C) 2013 American Megatrends, Inc.

3.9.4 BIOS Flashback

Allows you select copy and boot from either BIOS1 or BIOS2.



Force BIOS2 Boot

Select [Yes] to force the boot using BIOS2.

COPY BIOS1 to BIOS2

Select [Yes] to copy the content of BIOS1 to BIOS2.

3.10 Exit menu

The Exit menu items allow you to load the optimal default values for the BIOS items, and save or discard your changes to the BIOS items. You can access the EZ Mode from the Exit menu.



Load Optimized Defaults

This option allows you to load the default values for each of the parameters on the Setup menus. When you select this option or if you press <F5>, a confirmation window appears. Select **Yes** to load the default values.

Save Changes & Reset

Once you are finished making your selections, choose this option from the Exit menu to ensure the values you selected are saved. When you select this option or if you press <F10>, a confirmation window appears. Select **Yes** to save changes and exit.

Discard Changes & Exit

This option allows you to exit the Setup program without saving your changes. When you select this option or if you press <Esc>, a confirmation window appears. Select **Yes** to discard changes and exit.

ASUS EZ Mode

This option allows you to enter the EZ Mode screen.

Launch EFI Shell from filesystem device

This option allows you to attempt to launch the EFI Shell application (shellx64.efi) from one of the available filesystem devices.

3.11 Updating BIOS

The ASUS website publishes the latest BIOS versions to provide enhancements on system stability, compatibility, or performance. However, BIOS updating is potentially risky. If there is no problem using the current version of BIOS, DO NOT manually update the BIOS. Inappropriate BIOS updating may result in the system's failure to boot. Carefully follow the instructions of this chapter to update your BIOS if necessary.



Visit the ASUS website at www.asus.com to download the latest BIOS file for this motherboard.

The following utilities allow you to manage and update the motherboard BIOS setup program.

1. EZ Update: Updates the BIOS in Windows® environment.
2. ASUS EZ Flash 2: Updates the BIOS using a USB flash drive.
3. ASUS CrashFree BIOS 3: Restores the BIOS using the motherboard support DVD or a USB flash drive when the BIOS file fails or gets corrupted.
4. ASUS BIOS Updater: Updates and back ups the BIOS in DOS environment using the motherboard support DVD and a USB flash disk drive.

3.11.1 ASUS EZ Flash 2

ASUS EZ Flash 2 allows you to update the BIOS without having to use a bootable floppy disk or an OS-based utility.



Before you start using this utility, download the latest BIOS from the ASUS website at www.asus.com.

To update the BIOS using EZ Flash 2:

1. Insert the USB flash disk that contains the latest BIOS file to the USB port.
2. Enter the Advanced Mode of the BIOS setup program. Go to the Tool menu to select ASUS EZ Flash Utility and press <Enter> to enable it.



3. Press <Tab> to switch to the Drive field.
4. Press the Up/Down arrow keys to find the USB flash disk that contains the latest BIOS, and then press <Enter>.
5. Press <Tab> to switch to the Folder Info field.
6. Press the Up/Down arrow keys to find the BIOS file, and then press <Enter> to perform the BIOS update process. Reboot the system when the update process is done.



-
- This function can support devices such as a USB flash disk with FAT 32/16 format and single partition only.
 - DO NOT shut down or reset the system while updating the BIOS to prevent system boot failure!
-



Ensure to load the BIOS default settings to ensure system compatibility and stability. Select the Load Optimized Defaults item under the Exit menu. See section **3.9 Exit Menu** for details.

3.11.2 ASUS CrashFree BIOS 3

The ASUS CrashFree BIOS 3 utility is an auto recovery tool that allows you to restore the BIOS file when it fails or gets corrupted during the updating process. You can restore a corrupted BIOS file using the motherboard support DVD or a USB flash drive that contains the BIOS file.



The BIOS file in the motherboard support DVD may be older than the BIOS file published on the ASUS official website. If you want to use the newer BIOS file, download the file at support.asus.com and save it to a USB flash drive.

Recovering the BIOS

To recover the BIOS:

1. Turn on the system.
2. Insert the motherboard support DVD to the optical drive, or the USB flash drive containing the BIOS file to the USB port.
3. The utility automatically checks the devices for the BIOS file. When found, the utility reads the BIOS file and enters ASUS EZ Flash 2 automatically.
4. The system requires you to enter BIOS Setup to recover the BIOS setting. To ensure system compatibility and stability, we recommend that you press <F5> to load default BIOS values.



DO NOT shut down or reset the system while updating the BIOS! Doing so can cause system boot failure!

3.11.3 ASUS BIOS Updater

The ASUS BIOS Updater allows you to update the BIOS in DOS environment. This utility also allows you to copy the current BIOS file that you can use as a backup when the BIOS fails or gets corrupted during the updating process.



The succeeding utility screens are for reference only. The actual utility screen displays may not be same as shown.

Before updating BIOS

1. Prepare the motherboard support DVD and a USB flash drive in FAT32/16 format and single partition.
2. Download the latest BIOS file and BIOS Updater from the ASUS website at <http://support.asus.com> and save them on the USB flash drive.



- NTFS is not supported under DOS environment. Do not save the BIOS file and BIOS Updater to a hard disk drive or USB flash drive in NTFS format.
 - Do not save the BIOS file to a floppy disk due to low disk capacity.
-

3. Turn off the computer and disconnect all SATA hard disk drives (optional).

Booting the system in DOS environment

1. Insert the USB flash drive with the latest BIOS file and BIOS Updater to the USB port.
2. Boot your computer. When the ASUS Logo appears, press <F8> to show the BIOS Boot Device Select Menu. Insert the support DVD into the optical drive and select the optical drive as the boot device.

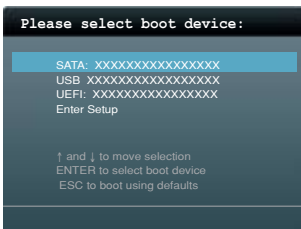

- When the Make Disk menu appears, select the FreeDOS command prompt item by pressing the item number.
- At the FreeDOS prompt, type d: and press <Enter> to switch the disk from Drive C (optical drive) to Drive D (USB flash drive).

```

Welcome to FreeDOS (http://www.freedos.org)!
C:\>d:
D:\>

```

Updating the BIOS file

To update the BIOS file using BIOS Updater:

- At the FreeDOS prompt, type bupdater /pc /g and press <Enter>.

```
D:\>bupdater /pc /g
```

- The BIOS Updater screen appears as below.

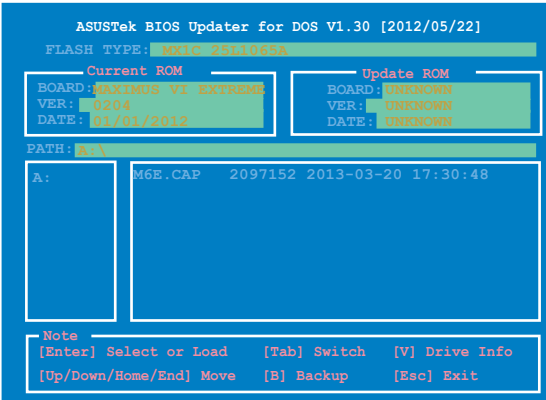

- Press <Tab> to switch between screen fields and use the <Up/Down/Home/End> keys to select the BIOS file and press <Enter>. BIOS Updater checks the selected BIOS file and prompts you to confirm BIOS update.



4. Select Yes and press <Enter>. When BIOS update is done, press <ESC> to exit BIOS Updater. Restart your computer.



DO NOT shut down or reset the system while updating the BIOS to prevent system boot failure!



- For BIOS Updater version 1.04 or later, the utility automatically exits to the DOS prompt after updating BIOS.
 - Ensure to load the BIOS default settings to ensure system compatibility and stability. Select the **Load Optimized Defaults** item under the **Exit** BIOS menu. See Chapter 3 of your motherboard user manual for details.
 - Ensure to connect all SATA hard disk drives after updating the BIOS file if you have disconnected them.
-

Software support

4

4.1 Installing an operating system



- This motherboard supports Windows® 8 32/64-bit and Windows® 7 32/64-bit operating systems (OS).
- Motherboard settings and hardware options vary. Use the setup procedures presented in this chapter for reference only. Refer to your OS documentation for detailed information.

4.2 Support DVD information



The contents of the support DVD are subject to change at any time without notice. Visit the ASUS website at www.asus.com for updates.

4.2.1 Running the support DVD



Ensure that you have an Administrator account before running the support DVD in Windows® 7 or Windows® 8 OS.

To run the support DVD:

1. Place the Support DVD into the optical drive.
2. In the **AutoPlay** dialog box, click **Run ASSETUP.exe**.



If the **AutoPlay** dialog box does not appear, browse the contents of the support DVD and double-click or tap `\\bin\ASSETUP.EXE` to launch the **ASUS motherboard support DVD** main menu.

Support DVD main menu

The Drivers menu shows the available device drivers if the system detects installed devices. Install the necessary drivers to use the devices.

The Manual menu contains the list of supplementary user manuals. Click an item to open the folder of the user manual.

The Video menu contains ROG related videos.

The Utilities menu shows the applications and other software that the motherboard supports.

Click an item to install

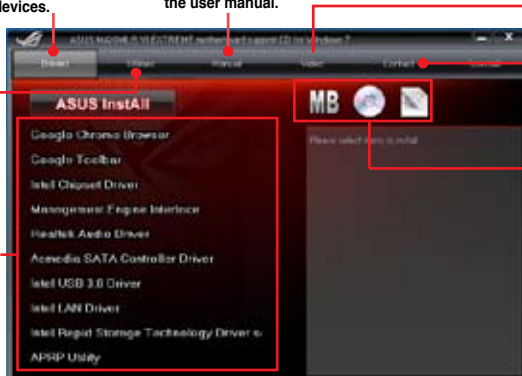

Click the Contact tab to display the ASUS contact information.

Click an icon to display DVD/motherboard information

4.2.2 Obtaining the software manuals

The software manuals are included in the support DVD. Follow the instructions below to get the necessary software manuals.



The software manual files are in Portable Document Format (PDF). Install the Adobe® Acrobat® Reader from the **Utilities** tab before opening the files.

To read about your motherboard's utility guide:

1. Click **Manual** tab > **ASUS Motherboard Utility Guide**.



- From the **Manual** folder, open the folder of the software manual that you wish to read.

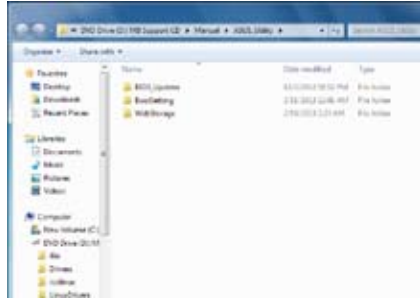

- Some software manuals are provided in different languages. Open the language's folder to view the software manual.

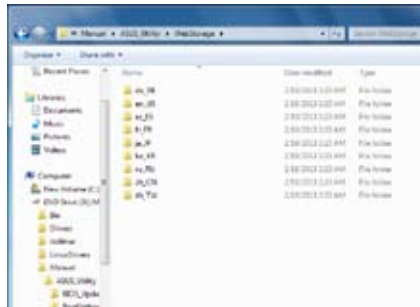

The screenshots in this section are for reference only. The actual software manuals containing in the support DVD vary by models.

4.3 Software information

Most of the applications in the support DVD have wizards that will conveniently guide you through the installation. View the online help or readme file that came with the software application for more information.

4.4 AI Suite 3

AI Suite 3 is an all-in-one interface that integrates several ASUS utilities and allows you to launch and operate these utilities simultaneously.

Installing AI Suite 3



- Ensure that you have an Administrator account before installing AI Suite 3 in Windows® 7 or Windows® 8 OS.
- To install the Wi-Fi-enabled features of AI Suite 3, ensure that you install the Wi-Fi module driver from the bundled support DVD. To do this, go to **Drivers** tab > **ASUS Bluetooth 4.0 Wi-Fi Driver** and follow the succeeding onscreen instructions.

To install AI Suite 3 on your computer:

Windows® 7 OS

1. Place the Support DVD into the optical drive.
2. In the **AutoPlay** dialog box, click **Run ASSETUP.exe** then select the **Utilities** tab.



3. From the **Utilities** tab, click **AI Suite 3** then follow the succeeding onscreen instructions.

Windows® 8 OS

1. Place the Support DVD into the optical drive then follow the onscreen instructions.
2. From the **ASUS motherboard support DVD** main menu, select the **Utilities** tab and click or tap **AI Suite 3**.
3. Follow the succeeding onscreen instructions.
If the **ASUS motherboard support DVD** main menu does not appear, try the following steps:
 - a. Go to the Start screen then click or tap the **Desktop** app.
 - b. From the taskbar, click or tap **File Explorer**  then select your DVD drive and double-click or tap the **Setup** application.

Launching AI Suite 3

Windows® 7 OS

From the Desktop, click **Start > All Programs > ASUS > AI Suite 3 > AI Suite 3**.

You can also launch AI Suite 3 in Windows® 7 by clicking  on the Notification area.

Windows® 8 OS

To launch AI Suite 3 in Windows® 8, tap the **AI Suite 3** app on the Start screen (or if you're using a mouse, click the **AI Suite 3** app on the Start screen).



AI Suite 3 Main menu

The AI Suite 3 main menu gives you easy-access controls and insight to what's going on with your computer - allowing you to optimize performance settings while at the same time ensuring system stability.

Included in the AI Suite 3 main menu is a quick-access menu bar that allows you to swiftly launch any of the integrated ASUS utilities. Click or tap the  on the top-edge of menu to launch the menu bar.



The AI Suite 3 screenshots in this section are for reference only and can vary depending on motherboard model.

AI Suite 3 main menu bar

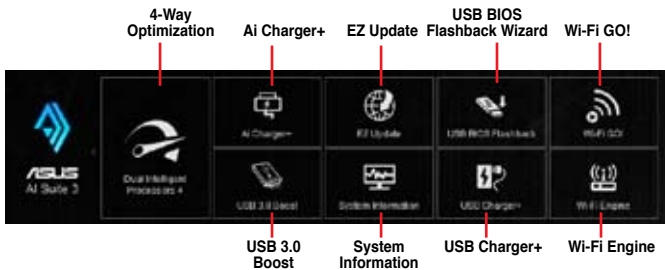

- Some functions in the AI Suite 3 main menu in this user manual may vary depending on the motherboard model.
- Refer to the software manual in the support DVD or visit the ASUS website at www.asus.com for detailed software configuration.

4.4.1 Dual Intelligent Processors 4 with 4-Way Optimization

Dual Intelligent Processors 4 with 4-Way Optimization comes with these five utilities in one interface: 4-Way Optimization, TurboV Processing Unit (TPU), Energy Processing Unit (EPU), DIGI+ Power Control, and Fan Xpert 2.

4-Way Optimization

The 4-Way Optimization utility allows you to automatically tweak the TPU, EPU, DIGI + Power Control and Fan Xpert 2 to their optimal settings.

4-Way Optimization screen

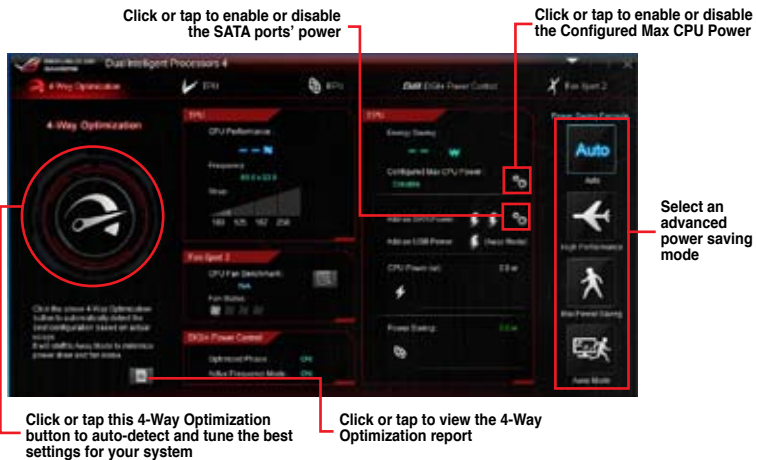

DO NOT remove your fan during the tuning process.

Using 4-Way Optimization

Click or tap the 4-Way Optimization button then click or tap **Start** to auto-detect the best settings based on actual usage.



Click or tap to view more settings

Click or tap to go back to the 4-Way Optimization main screen

Click or tap to start auto-tuning



- The system may reboot two or three times during the auto-tuning process.
- For Windows® 8 OS, click or tap **Desktop** app to monitor the auto-tuning process after every system reboot.

TurboV Processing Unit (TPU)

TPU allows you to manually adjust the CPU frequency, CPU cache, core frequencies, DRAM frequency, and related voltages for an enhanced system stability and a performance boost.



Refer to the CPU documentation before adjusting CPU voltage settings. Setting a high voltage may damage the CPU permanently and setting a low voltage may lead to an unstable system.



For system stability, the TPU settings are not saved in the BIOS and are not loaded during system bootup. Save your overclocking settings as a TPU profile and manually load this profile after system bootup.

Using TPU

CPU Frequency

Tick to enable Group Tuning

Click or tap ◀ or ▶ to adjust the Base Clock Frequency, CPU Ratio, and CPU Cache Ratio

Click or tap ◀ or ▶ to select the number of cores to adjust

Scroll down then adjust the CPU voltages and DRAM voltages

Click or tap to load the saved profile

Click or tap to save the adjustment into a profile

Click or tap to undo the adjustments

Click or tap to apply the adjustments



- Set the CPU Core Ratio item in BIOS to **[Auto]** before using the CPU Frequency in TPU. Refer to section **Extreme Tweaker menu** in the BIOS chapter of your motherboard user manual for details.
- The CPU Frequency bars show the status of the CPU cores, which vary with your CPU model.

GPU Boost

Click to load the saved profile

Click to save the adjustment into a profile

Click to apply the adjustments

Click to undo the adjustments

Click ◀ or ▶ adjust the GPU Graphics voltage

Click ◀ or ▶ to adjust the CPU graphics frequency



- The overclocking result varies with the CPU model and the system configuration.
- We recommend that you set up a better thermal environment to prevent overheating from damaging the motherboard.

CPU Strap

Click to load the saved profile

Click to save the adjustment into a profile

Drag the slider to adjust the CPU Strap's BCLK (base clock) frequency

Click to apply CPU Strap settings

Click to cancel the CPU Strap settings

Click to apply the adjustments

Click to undo the adjustments

Energy Processing Unit (EPU)

EPU is an energy-processing utility that allows you to adjust the CPU, GPU, and Fan Control settings to their power-saving conditions.

Using EPU

Auto

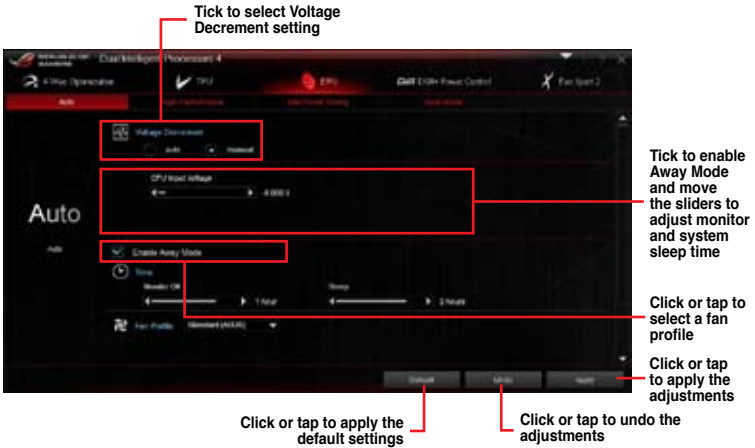

High Performance

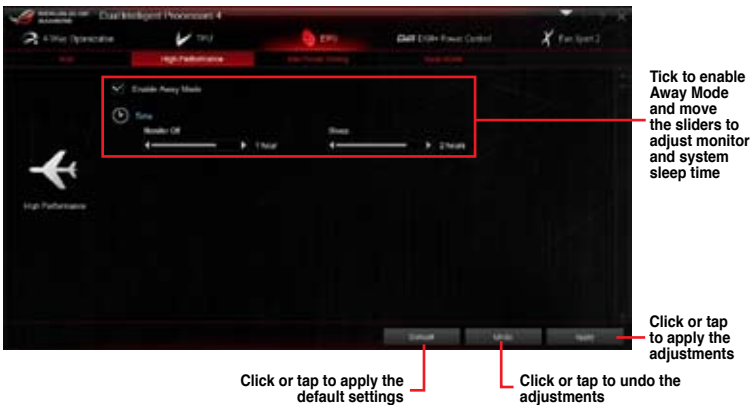

Max Power Saving

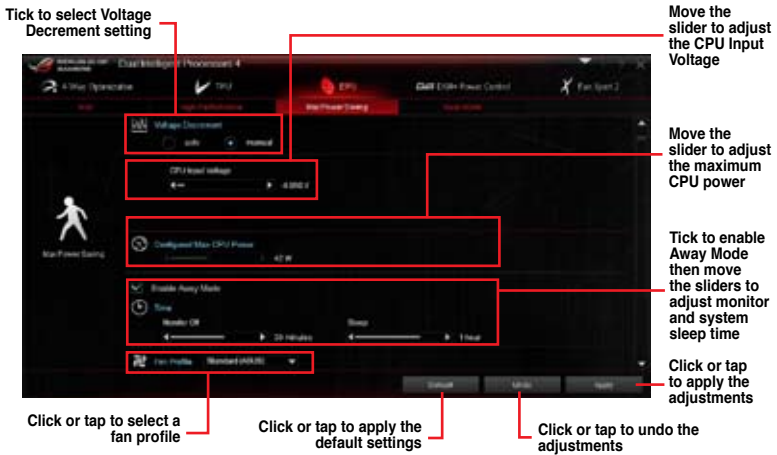

- When you enable the Configured Max CPU Power to boost the energy saving condition, the CPU frequency is displayed at 800 MHz in the Windows® OS information of your computer. However, the actual CPU frequency varies depending on the wattage that you manually set. You can adjust the CPU wattage from the lowest point to your preferred value.
- Configured Max CPU Power may decrease the total power delivery to the CPU and affects the CPU performance under a heavy system. To restore your system to its default settings, reboot your computer.

Away Mode

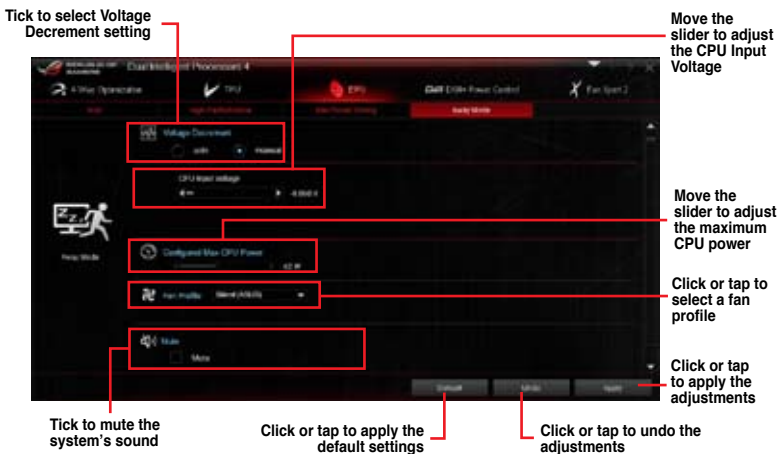

DIGI+ Power Control

DIGI+ Power Control utility allows you to adjust the CPU and DRAM power settings for optimal system efficiency, and overall system stability and performance.

Adjusting the CPU Power

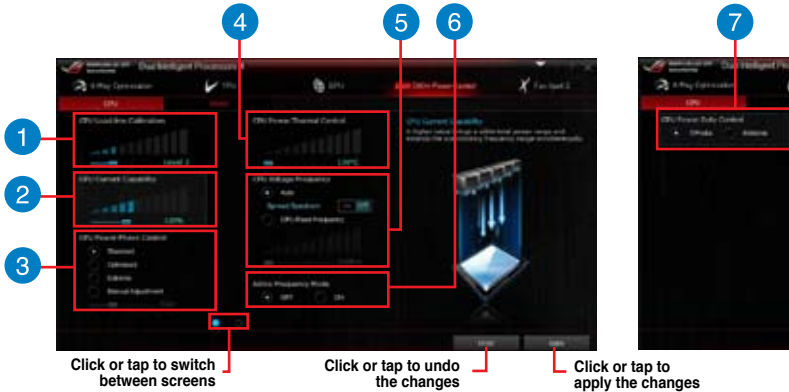

1

CPU Load-line Calibration

It allows you to adjust the voltage range to control the CPU Load-line. Adjust to a high value for system performance or to a low value for power efficiency.

2

CPU Current Capability

CPU Current Capability provides a wider total power range for overclocking. A higher value brings a wider total power range and extends the overclocking frequency range simultaneously.

3

CPU Power Phase Control

Increase the phase number under a heavy system load to get more transient and better thermal performance. Reduce the phase number under a light system load to increase the VRM efficiency.

* The system automatically sets the default to [Extreme] when using the Intel® iGPU.

4

CPU Power Thermal Control

A higher temperature brings a wider CPU power thermal range and extends the overclocking tolerance to enlarge the overclocking potential.

-
- 5 **CPU Voltage Frequency**
CPU Voltage Frequency affects the VRM transient response and thermal conditions. Higher VRM frequency gets a quicker transient response.

 - 6 **Active Frequency Mode**
Active Frequency Mode allows you to enhance the power saving condition of the CPU. Tick **ON** to get a quicker transient response while saving the CPU power.

 - 7 **CPU Power Duty Control**
CPU Power Duty Control adjusts the current of every VRM phase and the thermal conditions of every phase component.
-

Adjusting the DRAM Power

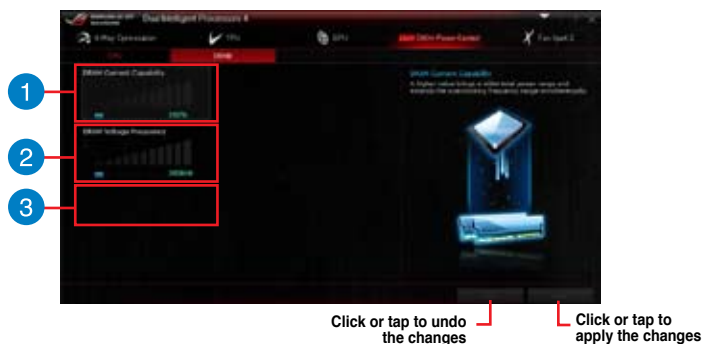

-
- 1 **DRAM Current Capability**
A higher value brings a wider total power range and extends the overclocking frequency range simultaneously.

 - 2 **DRAM Voltage Frequency**
Allows you to adjust the DRAM switching frequency to stabilize the system or to increase the overclocking range.

 - 3 **DRAM Power Phase Control**
Select **Extreme** for full phase mode to increase system performance or select **Optimized** for ASUS optimized phase tuning profile to increase the DRAM power efficiency.
-



- The actual performance boost may vary depending on your CPU specification.
 - Ensure that the cooling modules are properly installed in your motherboard to monitor the thermal conditions.
-

Fan Xpert 2

Fan Xpert 2 automatically detects and tweaks the fan speeds and provides you with optimized fan settings based on the fans' specifications and positions.

Using Fan Xpert 2

Click or tap to set the fan's speed to silent mode

Select a screen to select the type of fan that you want to customize

Click or tap to increase the fan's speed for a high cooling capability

Click or tap to maximize the fan speed

Click or tap to auto-tune the fans to their best settings

Click or tap to set the balanced configuration between the fan's noise level and speed

Click or tap to switch between fan screens

Click or tap to load a profile

Click or tap to save the settings into a profile



DO NOT remove your fan during the Fan Auto Tuning process.

Customizing the fan settings

Smart Mode

Smart Mode allows you to customize the fans' rotation speeds and responses based on your system's temperature.

Click and drag to set the fan's rotation speed

Click and drag the sliders to adjust the fan's response

Click or tap to go back to the previous screen

Click or tap to switch between the CPU and chassis fan screens

Click or tap to undo the changes

Click or tap to apply the changes

RPM Mode

RPM Mode allows you to set the fan speed at its fixed value when the CPU temperature drops 75°C and below.

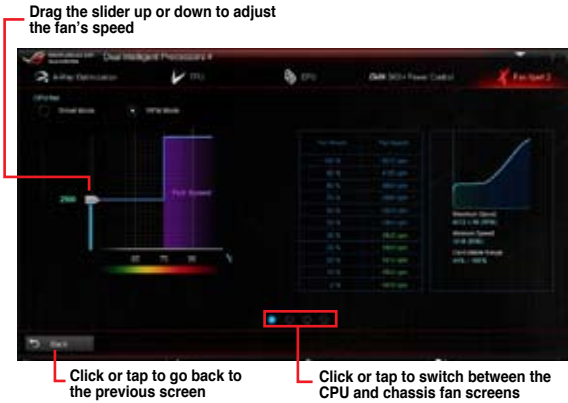

- When the CPU temperature reaches 75° C, the fan automatically runs at full speed to protect the CPU.
- Fan Xpert 2 may not be able to detect the fan speed if you install the fan with an external control kit for rotation speed.
- Fan Xpert 2 only supports fans with 4-pin and 3-pin connectors. If you install a 2-pin fan, it can only run at its full speed.
- If you change the CPU or chassis fans, you must repeat the Fan Auto Tuning process.

4.4.2 Ai Charger+

Ai Charger+ allows you to fast-charge your portable BC 1.1* mobile devices on your computer's USB port three times faster than the standard USB devices**.

Launching Ai Charger+

To launch Ai Charger+, click or tap ▼ on the top-right corner of the AI Suite 3 main menu, then select **Ai Charger+**.

Ai Charger+ screen



Tick to enable or disable Ai Charger+

Click or tap to apply the selection



- * Check the manufacturer if your USB device is a Battery Charging Specification 1.1 (BC 1.1) compliant or compatible device.
- ** Actual charging speeds may vary depending on the charging rate and specifications of your USB device.
- To ensure normal charging function, disconnect and reconnect your USB device every time you enable or disable Ai Charger+.
- Ai Charger+ does not support USB hubs, USB extension cables, and generic USB cables.

4.4.3 USB Charger+

USB Charger+ allows you to quick-charge your portable USB devices even if your computer is off, in sleep mode or hibernate mode.



Before using USB Charger+, ensure to disable the ErP Ready item in the BIOS. To do this, go to **Advanced > APM > ErP Ready** in the Advanced mode then set this item to [Disabled].



USB Charger+ is available only in selected motherboard models.

Launching USB Charger+

To launch USB Charger+, click or tap  on the top-right corner of the AI Suite 3 main menu, then select **USB Charger+**.

Using USB Charger+



The screenshot shows the USB Charger+ utility interface. It features a dark background with the ASUS logo and 'Others' text. There are several callouts with red lines pointing to specific elements:

- Click or tap to detect the connected USB device**: Points to the top-left corner of the utility window.
- Click or tap to fast-charge your USB device**: Points to a button with a lightning bolt icon.
- Click or tap to stop charging your USB device**: Points to a button with a power icon.
- Click or tap to apply the settings**: Points to the 'Apply' button at the bottom.
- Click or tap to disregard the settings**: Points to the 'Disregard' button at the bottom.
- Indicates that the connected USB device is in charging mode**: Points to the 'ASUS' text in the bottom-left corner.
- Click or tap to select the type of USB device that you wish to charge when the system is off**: Points to the 'Kindle', 'Apple', and 'Others' categories.



Ensure to connect your USB device into the USB port that supports this utility. Refer to section **Rear I/O connection** of your user manual for more details.



- USB Charger+ does not support USB hubs, USB extension cables, and generic USB cables.
- USB Charger+ may not recognize some ASUS devices due to varying design.

4.4.4 Wi-Fi Engine

Wi-Fi Engine allows you to connect to a wireless network and set up your computer as an access point for Internet connection sharing among Wi-Fi enabled devices.

To use Wi-Fi Engine, click or tap  on the right edge of the AI Suite 3 main menu, then select **Wi-Fi Engine**.

Using Wi-Fi Engine



Using the Client Mode

The Client mode allows you to connect your system to a wireless network.

To use the client mode:

1. Click or tap **Client Mode** to launch Network Connections.
2. From the Network Connections window, select a network adapter.



- From the list of available networks, select a network that you want to connect to.



Some networks may require you to key in a password.

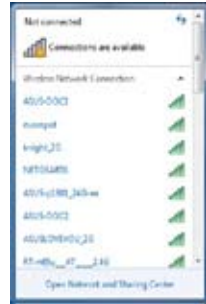

Using the AP Mode

The AP mode allows you to set your system as an access point for other wireless-enabled devices.

To use AP mode, click or tap **AP Mode** on the Wi-Fi Engine menu.

Click or tap to go back to previous screen

Click or tap to select a network

Key in a network name

Key in your password

Key in your password for confirmation

Click or tap to disable AP mode

Click or tap to enable AP mode



- In this mode, the Internet Connection Sharing may depend on the Bluetooth/Internet device's driver support.
- Due to Windows® 8 limitation, it may take one to two minutes to set up the AP mode for the first time.

4.4.5 USB 3.0 Boost

USB 3.0 Boost technology supports UASP (USB Attached SCSI Protocol) that automatically speeds up the transfer rates of your USB storage devices.

Launching USB 3.0 Boost

To launch USB 3.0 Boost, click or tap ▼ on the top-right corner of the AI Suite 3 main menu, then select **USB 3.0 Boost**.

Using the USB 3.0 Boost

1. Connect your USB 3.0 device to the USB 3.0 port.
2. From the USB 3.0 Boost screen, select a USB device.
3. To enable UASP on your USB device, click UASP. To revert to its normal transfer rate, click Normal.

USB 3.0 Boost



Ensure to connect your USB 3.0 device to the USB 3.0 ports that support USB 3.0 Boost. Refer to section **Rear I/O connection** of your user manual for more details.



- USB 3.0 Boost automatically detects the USB 3.0 devices that support UASP. For a list of UASP-supported USB 3.0 devices, visit the ASUS website at www.asus.com.
- The data transfer speed varies with USB devices. For a higher data transfer performance, use a USB 3.0 device.

4.4.6 USB BIOS Flashback

USB BIOS Flashback allows you to check and save the latest BIOS version to a USB storage device. Use this utility to quickly check for the latest available BIOS and set the BIOS download schedule.

Launching USB BIOS Flashback

To launch USB BIOS Flashback, click or tap  on the top-right corner of the AI Suite 3 main menu, then select **USB BIOS Flashback**.



USB BIOS Flashback is available only in selected motherboard models.

Using USB BIOS Flashback

Set a schedule for the BIOS Update download



Click or tap to check for a new BIOS update available for download

Click or tap to cancel the download schedule setting

Click or tap to apply the download schedule setting

Scheduling the BIOS download

1. In the Download Setting field, tick **Schedule (days)** then select the number of days for the BIOS download schedule.
2. Click or tap **Apply** to save the BIOS download schedule. Click or tap **Cancel** to cancel the download schedule.

Downloading the latest BIOS



Before you start downloading, ensure that you have installed the USB storage device to your computer's USB port that supports USB BIOS Flashback. Refer to section **Rear I/O connection** of your user manual for more details.

To download the updated BIOS:

1. From the USB BIOS Flashback screen, click or tap **Check for New BIOS Update**.

Wait for the system to check the latest BIOS version.

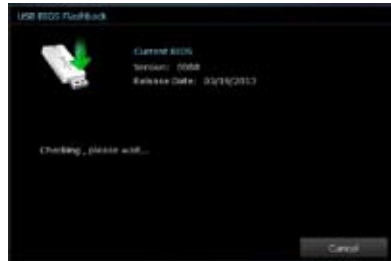

2. After the utility detects a new BIOS, click or tap **Save to:** from the **Save to:** field, select the USB flash drive, then click or tap **Download**.



3. After the download is complete, click or tap **OK**.



4.4.7 Wi-Fi GO!

Wi-Fi GO! is ASUS-exclusive Wi-Fi utility that allows you to wirelessly stream your media files to HDTV device/display, control your computer using your smart device, transfer files to your smart device, and provides access to your files stored in your cloud storage.

System requirements

System requirements	PC	Smart device
OS	Windows® 7/Windows® 8	Android 2.3 or later versions iOS5 or later versions
Utilities	ASUS AI Suite 3	ASUS Wi-Fi GO! & NFC Remote



- Install the mPCIe Combo II card with Wi-Fi module driver and AI Suite 3 utility from your ASUS motherboard's bundled support DVD.
- For your Android smart device, download the ASUS Wi-Fi GO! & NFC Remote from Google Play. For your iOS smart device, download the ASUS Wi-Fi GO! & NFC Remote from App store.
- The screenshots used in this section are for reference only and can appear different from the actual software you are using. Refer to the ASUS support site (<http://support.asus.com>) for updated documentations on this motherboard.
- For your Android smart device, download the ASUS Wi-Fi GO! & NFC Remote from Google Play. For your iOS smart device, download the ASUS Wi-Fi GO! & NFC Remote from App store.



- Ensure that all Wi-Fi enabled devices using the Wi-Fi GO! utility must be in the same local area network (LAN).
- The user interface of your smart device may vary with the operating system and the screen resolution.

Smart device supported screen resolutions

Wi-Fi GO! & NFC Remote supports the following screen resolutions of your smart devices:

Screen type	Low Density (120, ldpi)	Medium Density (160, mdpi)	High Density (240, hdpi)	Extra high density (320, xhdpi)
Screen Resolution	1024 x 600	WXGA (1280x800)	1536 x 1152	2048 x 1536
		1024 x 768	1920 x 1152	2560 x 1536
		1280 x 768	1920 x 1200	2560 x 1600

Launching Wi-Fi GO!

To launch Wi-Fi GO!, click or tap the ▼ on the top-right corner of the AI Suite 3 main menu, then select **Wi-Fi GO!**





- To access the Wi-Fi GO! features in your smart device, refer to section **Wi-Fi GO! & NFC Remote** of this user manual for more details.
- To protect your Wi-Fi utility from other smart devices, click or tap  to set your password.
- Ensure that the ASUS AI Suite 3 utility is active when using Wi-Fi GO!.

Wi-Fi GO! & NFC Remote

Wi-Fi GO! & NFC Remote allows you to remotely control your computer using your smart device.

Smart device supported screen resolutions

Wi-Fi GO! & NFC Remote supports the following screen resolutions of smart devices:

Screen type	Low density (120 ldpi)	Medium density (160 mdpi)	High density (240 hdpi)	Extra high density (320 xhdpi)
Screen Resolution	1024 x 600	WXGA (1280 x 800)	1536 x 1152	2048 x 1536
		1024 x 768	1920 x 1152	2560 x 1536
		1280 x 768	1920 x 1200	2560 x 1600

Using Wi-Fi GO! & NFC Remote

To use the Wi-Fi GO! & NFC Remote:

1. Connect your smart device to the same Wi-Fi network as your computer.



For details in connecting your smart device to a Wi-Fi network, refer to the user manual of your smart device.

2. Tap  then tap **Enter**.
3. Tap the computer that you want to connect with your smart device.

When done, the Wi-Fi GO & NFC Remote interface appears on your smart device.



Wi-Fi GO! & NFC Remote interface

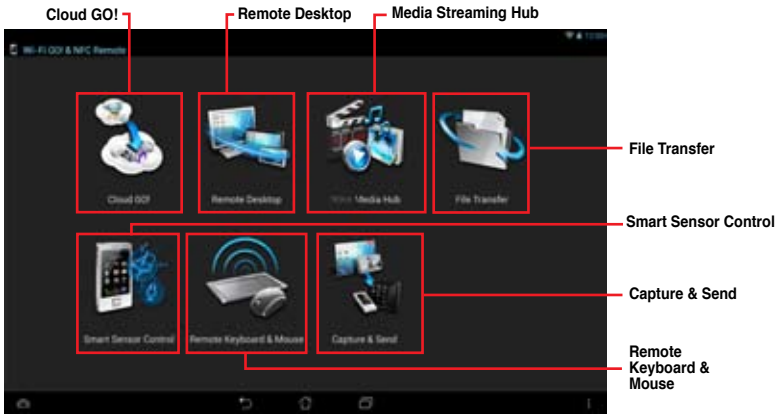

The screenshots are for reference only and vary with the type of smart device.

Cloud GO!

Cloud GO! allows you to control and sync your files across multiple cloud services such as ASUS WebStorage, GoogleDrive™, and DropBox®.



Ensure to set the correct system date and time of your computer and smart device when using Cloud GO!

Using Cloud GO! in your computer

To use Cloud GO! in your computer:

1. Click or tap **Cloud GO! > Enter**.
2. Log in to your cloud accounts, then click or tap **Sign In**.



- To log in to your ASUS Webstorage account, key in your user name and password.
- To log in to your Google Drive™ or Dropbox® accounts, click or tap **Sign in**. Cloud GO! directs you to the Google Drive or Dropbox website to log in to your account.

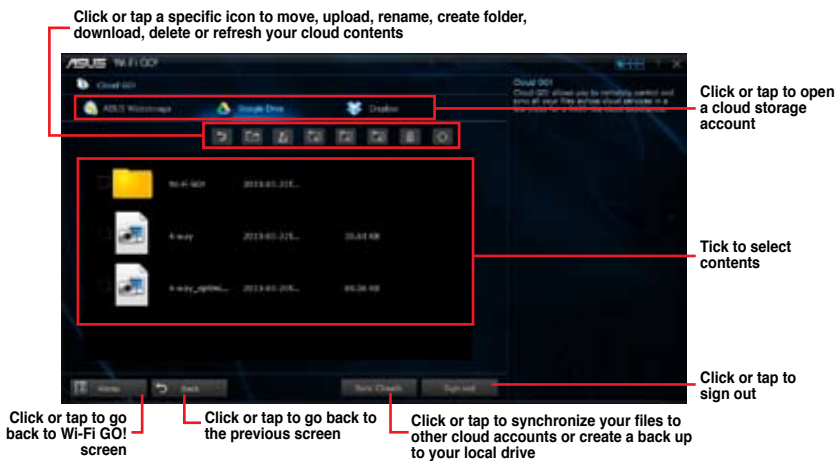

Synchronizing cloud contents

To synchronize contents:

1. Tick the contents that you want to synchronize, then click or tap **Sync Clouds**.
2. Tick the cloud storage account then click or tap **OK**.



- Tick **Backup** if you want to save a backup in your computer.
- All synced files are stored in the Wi-Fi GO! folder.



Using Cloud GO! in your smart device

To use Cloud GO! in your smart device, tap **Cloud GO! > Enter**.



You must log in to your computer first and tick **Remember me** to authorize access in your smart device.

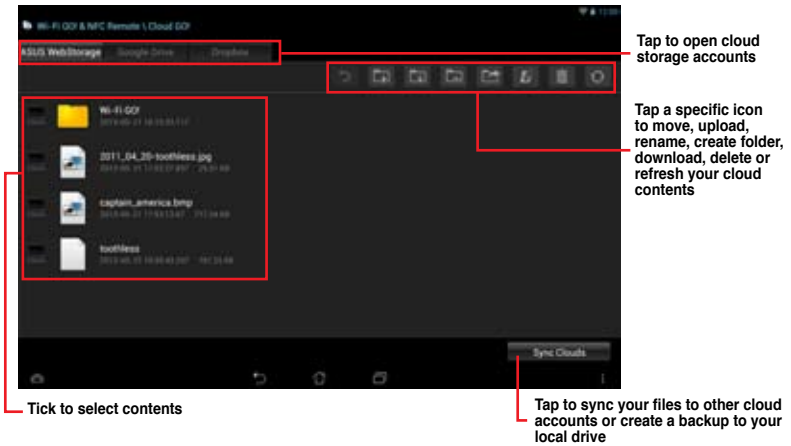

Synchronizing cloud contents

To synchronize contents:

1. Tick the contents that you want to synchronize, then tap **Sync Clouds**.
2. Tick the cloud storage account then tap **OK**.



- Tick **Backup to PC under (C:\MyFavorite)** if you want to save a backup in your computer.
- Open the Wi-Fi GO! folder to view all synced files.



Remote Desktop

Remote Desktop allows you to remotely control your desktop in real-time using your smart device.

Using Remote Desktop

To use Remote Desktop:

1. On your smart device, tap **Remote Desktop > Enter**.
2. Wait for the smart device to connect with your computer.



To operate Remote Desktop in Windows® 7, you can select **Extended Mode** or **Main Screen Mode** in your smart device.

Remote Desktop interface for Windows® 8



Remote Desktop interface for Windows® 7



Media Streaming Hub

Media Streaming Hub allows you to stream media files to an HDTV device/display and remotely control playback using your smart device.



- When using your computer as a receiver, ensure to launch the Windows Media Player, then enable the remote control settings of the Windows Media Player. To do this, click or tap **Stream** then tick the items **Allow remote control of my Player...** and **Automatically allow devices to play my media...**
- When using your HDTV display as a receiver, ensure to enable the Media Streaming setting.

Using Media Streaming Hub in your computer

To use Media Streaming Hub in your computer, click or tap **Media Streaming Hub > Enter**.

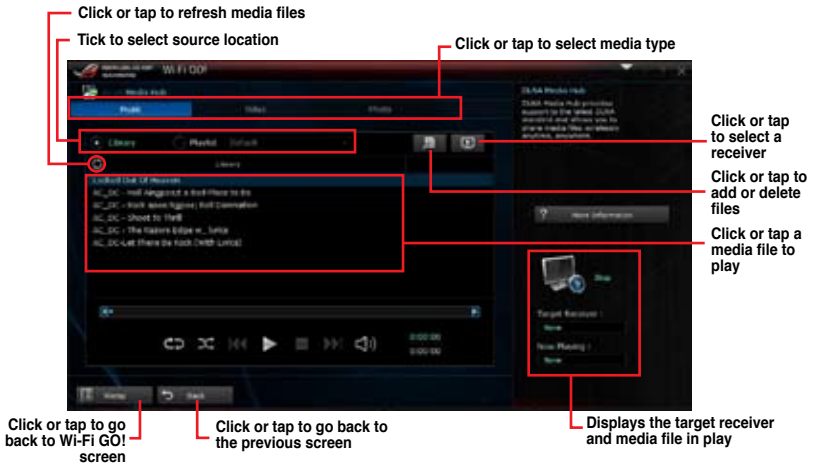

Selecting a receiver

To select a receiver:

1. Click or tap .
2. Tick to select a receiver, then click or tap **OK**.



Adding media files

To add media files:

1. From the **Music** , **Video**, or **Photo** screen, click or tap .
2. Click or tap **Add** then search the files that you want to add.
3. Click or tap **OK**.



Deleting media files

To delete media files:

1. From the **Music**, **Video**, or **Photo** screen, click or tap .
2. Tick the files that you want to delete, then click or tap **Delete**.
3. Click or tap **OK**.



Using Media Streaming Hub in your smart device

To use Media Streaming Hub in your smart device, tap **Media Streaming Hub** > **Enter**.

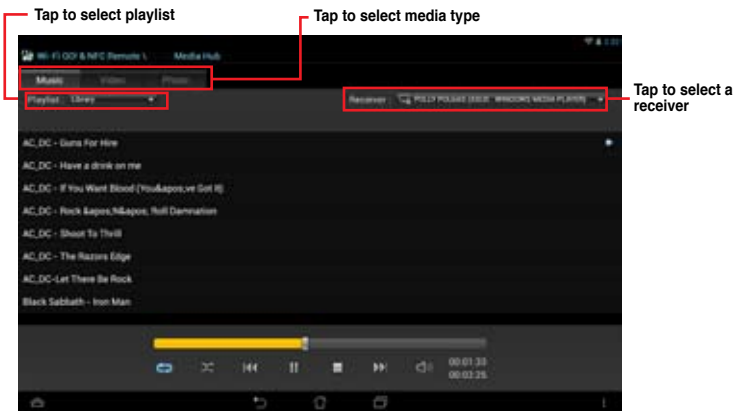

File Transfer

File Transfer allows you to transfer files between your computer and your smart device.



- iOS smart devices can only send files.
- Android smart devices can send and receive files.



To send files between your computer and smart device, ensure to enable the File Transfer function in your smart device.

Transferring files from computer to smart device

To transfer files from computer to smart device:

1. Click or tap **File Transfer > Enter**.
2. Click or tap **Setting** to select the destination for your transferred files.



Click or tap to go back to Wi-Fi GO!/Remote GO! screen

Click or tap to go back to the previous screen

Click or tap to apply the changes

Click or tap browse to select the destination

3. Right-click or long tap the file then select **Send to > [Device Name]**.
4. After the file transfer is complete, click or tap **OK**.

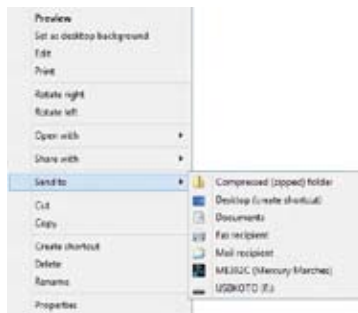

- If you are using an iOS smart device, you can only receive files in PNG, BMP, JPG, GIF, and TIFF formats.
- To receive files on your iOS device, go to **Settings > Privacy > Photos** then turn on the **Wi-Fi GO! & NFC Remote**.

Transferring files from smart device to computer

To transfer files from smart device to computer:

1. Tap **File Transfer > Enter**.
2. Tick the files that you want to send to your computer, then tap **Send**.



Smart Sensor Control

Smart Sensor Control allows you to remotely control your desktop by using your smart device's built-in sensors.



- The functions of Smart Sensor Control varies with your computer's operating system.
- For Windows® 7 OS, ensure to enable the Smart Sensor Control feature in your smart device. To do this, tap **Smart Sensor Control > Enable**.

Using Smart Sensor Control in Windows® 8

In your computer, click or tap **Smart Sensor Control > Camera**.

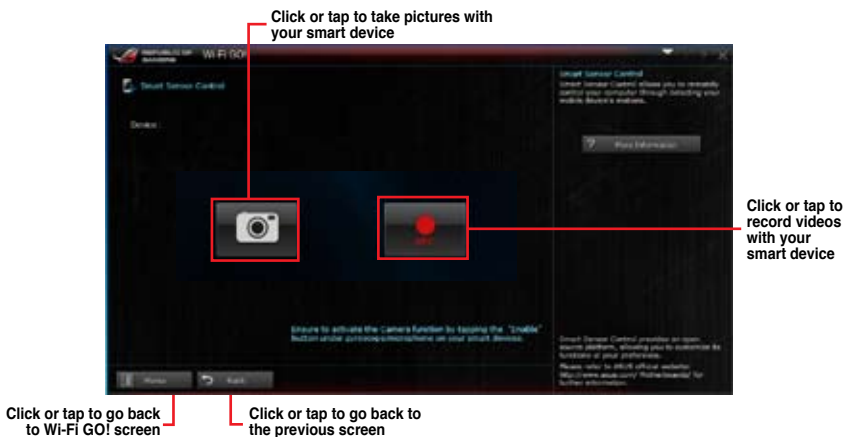

- Your smart device must have a camera to support this feature.
- Ensure to enable the gyroscope or microphone feature in your smart device to enable the camera and video recorder features in your computer. To do this, tap **Smart Sensor Control** then tap **Enable** on either the gyroscope or microphone function.
- This feature is also supported in Windows® 7.

The Smart Sensor Control in Windows® 8 environment features the microphone function for voice chat and recording. It also has the gyroscope function that allows you to use your smart device as a remote control for gyroscope-enabled apps.

In your smart device, tap **Smart Sensor Control > Enable** on the virtual microphone or gyroscope functions.



Tap to select voice quality

Tap to enable virtual microphone function

Tap to enable the gyroscope function

Using Smart Sensor Control in Windows® 7

To use Smart Sensor Control:

1. Click or tap **Smart Sensor Control > Setting**.
2. In the **Movement** tab, select an action from ↑, ↓, →, and ← dropdown fields.
3. To save the actions as a profile, click or tap **Apply & Save**. To apply the actions without saving as a profile, click or tap **Apply**.



You can also set the smart device's motion sensor sensitivity for a quicker response in your computer. To do this, tap **Smart Sensor Control > Setting** and set a sensitivity option.



Select actions for each movement gesture

Click or tap to apply and save the settings as a profile

Click or tap to go back to Wi-Fi GO! screen

Click or tap to go back to the previous screen

Click or tap to apply the settings

4. In the **Proximity** tab, select an action from the **Action:** field.
5. To save the action as a profile, click or tap **Apply & Save**. To apply the action without saving as a profile, click or tap **Apply**.



Your smart device must have a proximity sensor function to support this feature.

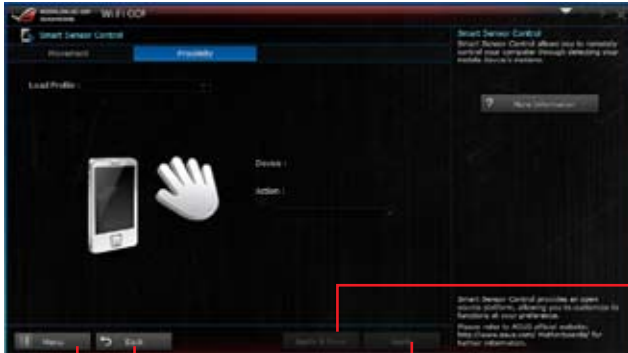

Click or tap to go back to Wi-Fi GO! screen

Click or tap to go back to the previous screen

Click or tap to apply the settings

Click or tap to apply and save the settings as a profile

Remote Keyboard & Mouse

Remote Keyboard & Mouse allows you to use your smart device's touch panel as a remote keyboard and mouse for your computer.

Using Remote Keyboard & Mouse

To use Keyboard & Mouse, tap **Keyboard & Mouse** in your smart device then tap **Enter**.

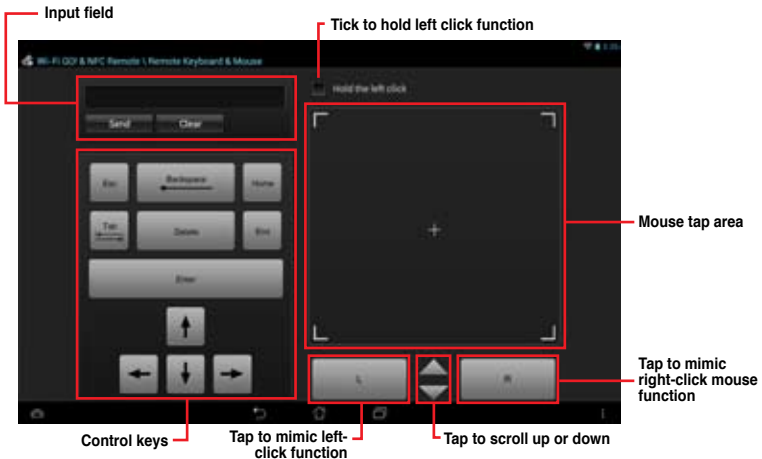

Capture & Send

Capture & Send allows you to take screenshots on your computer and send them to your smart device.

Using Capture & Send

To use Capture & Send:

1. On your computer, click or tap **Capture & Send > Setting**.
2. Assign a hot key and the capture range, then click or tap **Apply**.

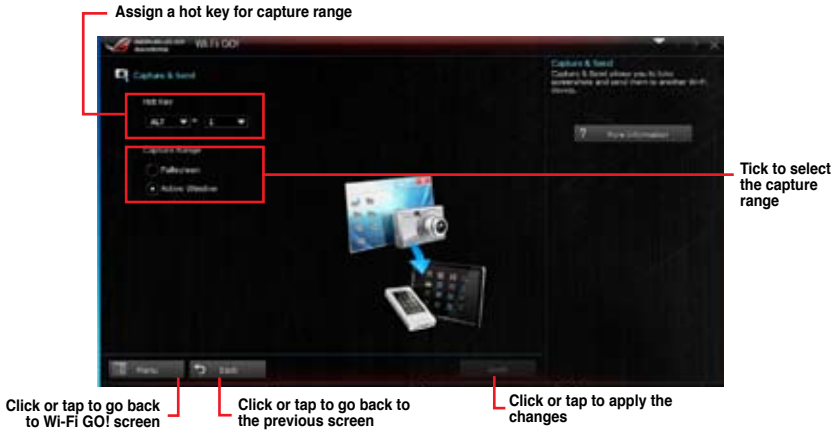

3. Capture the screenshot using the configured hot key, then tap **OK**.



Ensure to enable the Capture & Send feature in your smart device. To do this, tap **Capture & Send** then tap **Enable**.

4. In your smart device, tap **Capture & Send** then tap **Enter**.
5. Tap the file then select an app that you want to open the file with.



4.4.8 EZ Update

EZ Update is a utility that allows you to automatically update your motherboard's software, drivers and BIOS easily.

With this utility, you can also manually update the BIOS and select the boot logo that displays during POST.

Launching EZ Update

To launch EZ Update, click or tap  on the top-right corner of the AI Suite 3 main menu, then select **EZ Update**.

Using EZ Update

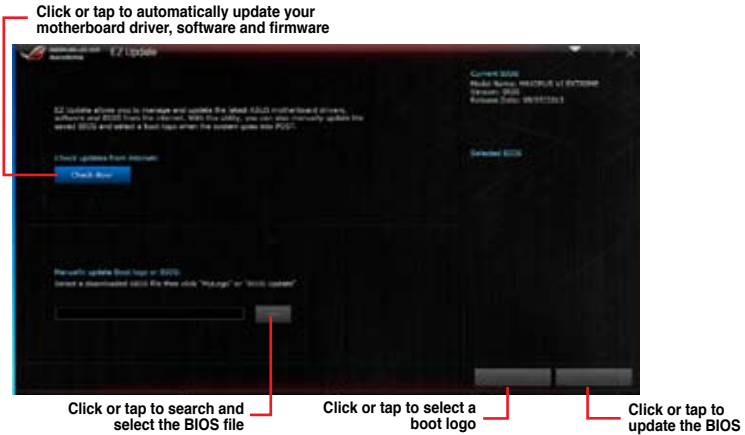

Manually update the BIOS and selecting a boot logo

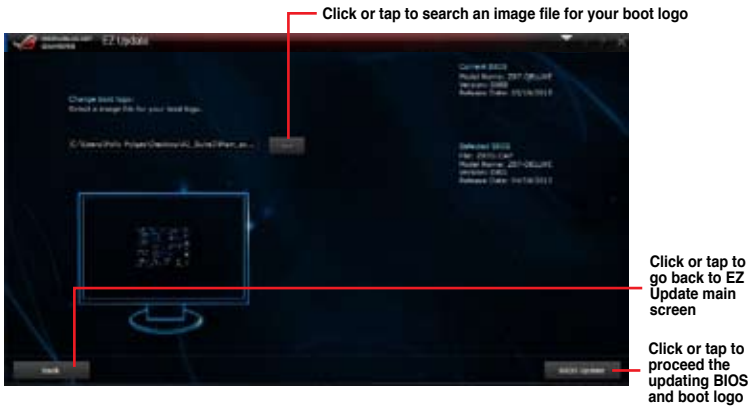

After you click or tap **BIOS Update** button, click or tap **Flash** to update the BIOS and upload the boot logo in your system.

4.4.9 System Information

This utility allows you get the detailed information of the motherboard, CPU, and memory settings.

Launching the System Information

To launch System Information, click or tap  on the top-right corner of the AI Suite 3 main menu, then select **System Information**.

Viewing the motherboard information

Click or tap the **MB** tab to view the motherboard's information.



Viewing the CPU information

Click or tap the **CPU** tab to view the processor's information.



Viewing the SPD information

Click or tap the **SPD** tab to view the memory's information.



4.5 Audio configurations

The Realtek® audio CODEC provides 8-channel audio capability to deliver the ultimate audio experience on your computer. The software provides Jack-Sensing function, S/PDIF Out support, and interrupt capability. The CODEC also includes the Realtek® proprietary UAJ® (Universal Audio Jack) technology for all audio ports, eliminating cable connection errors, and giving users plug and play convenience.

Follow the installation wizard to install the Realtek® Audio Driver from the support DVD that came with the motherboard package.

If the Realtek® audio software is correctly installed, you will find the Realtek® HD Audio Manager icon on the taskbar. Double-click on the icon to display the Realtek® HD Audio Manager.



Realtek® HD Audio Manager

Realtek® HD Audio Manager for Windows® 8 / Windows® 7



4.6 ROG Connect

ROG Connect allows you to monitor and adjust the local PC through your remote PC.

Setting up USB connection between your local and remote PC



- Install ROG Connect on the remote PC from the provided Support DVD before using ROG Connect.
- ROG Connect must work with ROG Connect software to avail full function. Ensure that you install ROG Connect on your local PC from the provided Support DVD before using ROG Connect.

1. Connect the provided ROG Connect cable to the local PC and the remote PC.
2. Press the ROG Connect Button and it will light up into a stable glow.
3. Double-click the RC TweakIt shortcut on the remote PC to activate the function

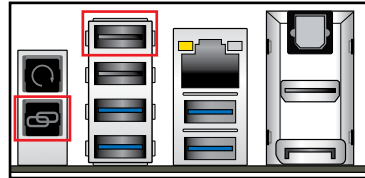

Using RC TweakIt

To use the RC TweakIt

1. Use the sliders and buttons to monitor or adjust your local PC.



2. Click Function to display more options.



RC Poster

RC Poster shows the status of the local system during the POST. You can switch the display mode between String and Code.



RC Remote

RC Remote allows you to operate your local system through the ROG Connect cable.



RC Diagram

RC Diagram allows you to monitor and record your local system status.



4.7 MemTweakIt

MemTweakIt allows you to adjust the timing of your installed memory. It also allows you to save, validate and post your configuration on the ROG website depending on your DRAM Efficiency Score.

To use MemTweakIt:

1. Double-click  on the desktop.
2. Click the dropdown lists of your selected timings and select a timing value.
3. Click **Apply** to save and apply your configuration. Your **DRAM Efficiency Score** will be shown in **General** section.



A wrong configuration of the DRAM timings may result to an unstable system. Restart your system if needed.

- Click **About** tab and click **REPUBLIC OF GAMERS** to access ROG official website.



Click **About** tab and click **REPUBLIC OF GAMERS** to access ROG official website.

Click **OK** to exit MemTweakIt.

- Click **OK** to exit MemTweakIt.

Validating and saving your MemTweakIt settings

To validate and save your configuration online:

- Launch MemTweakIt and click **Validate**.
- In **Online Mode**, key in your ASUS account ID and password, and click **Submit**.



Your configuration will be displayed in MemTweakIt webpage.

- Click **OK** to close the **Validation** window.



To validate and save your configuration manually:

1. Launch MemTweakIt and click **Validate**.
2. In **Manual Mode**, click **Save Configuration File**.



3. Key in a file name for your configuration file and click **Save**.
4. Click **validation webpage**.
5. In **MemTweakIt - Validation File Upload** window, key in your ASUS account ID and password.
6. Click **Browse**, locate the saved .cvf file, and click **Open**.
7. Click **Submit**.

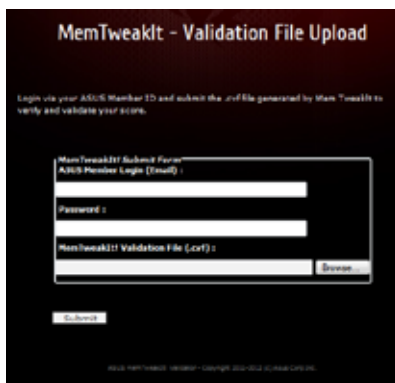

Your configuration will be displayed in MemTweakIt webpage.

4.8 ROG RAMDisk

RAMDisk is a data-storage software that reserves a part of your system's memory and turns it into a high-speed virtual drive where you can store cache files and game apps for instant access. The ROG RAMDisk also allows you to automatically backup, update, and restore files.



RAMDisk only supports 64-bit OS.



The following folders are not suitable for RAMDisk optimization. Moving them into the RAMDisk might negatively affectm the performance of your system.

- **Swap file/Page file:** The swap file is a permanent storage space used as the virtual memory expansion of the system memory. Moving the swap file into the RAM Disk simply defeats the whole purpose of having it and may affect your system's performance.
- **Startup folders:** Since RAMDisk loads during boot up together with the contents of the Junction folders, changing the location of the startup folders may cause system error and disable loading your RAMDisk.



To launch RAMDisk, click

Creating/Deleting a RAMDisk drive

Your RAMDisk drive allows you to place your favorite applications and files into RAM so you can utilize your RAM speed for better read/write performance. The files that are stored inside the RAMDisk are automatically backed up every time your PC is turned off.



The startup time may take a while, depending on the size of your RAMDisk drive.

To create RAMDisk drives:

The screenshot shows the ROG RAMDisk application window. The interface includes a 'Check' button at the top, a 'Disk' section with a drop-down menu, a 'Size' section with a slider, and an 'Add' button at the bottom right. Annotations with red boxes and arrows point to these elements:

- Click to create RAMDisk drives:** Points to the 'Check' button.
- Click the drop-down arrow to choose a drive name for your RAMDisk:** Points to the 'Disk' drop-down menu.
- Move the slider to the right to set the size allocation:** Points to the 'Size' slider.
- Click Add to finish creating the RAMDisk drive:** Points to the 'Add' button.

To delete an existing RAMDisk drive:

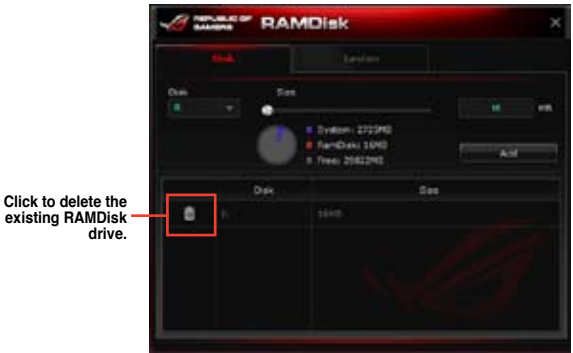

Click to delete the existing RAMDisk drive.

Creating/Deleting a Junction Point

A junction point creates a link that remaps the original contents into the RAMDisk, enabling access to the desired application or data to be done purely within the original file location.

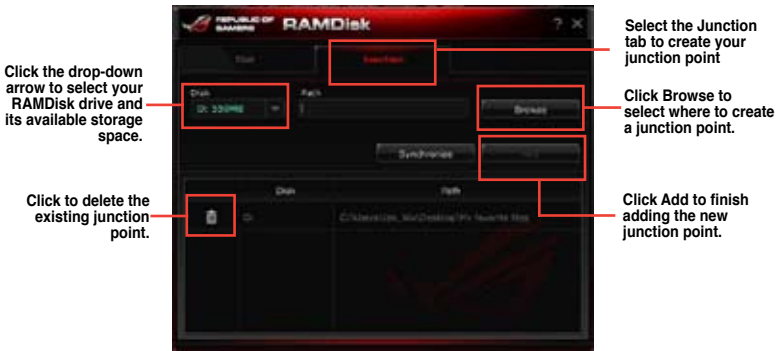

Click the drop-down arrow to select your RAMDisk drive and its available storage space.

Select the Junction tab to create your junction point

Click Browse to select where to create a junction point.

Click to delete the existing junction point.

Click Add to finish adding the new junction point.

Synchronizing backup files

After creating a junction point, RAMDisk automatically creates a backup folder in the file's original location. Use RAMDisk to manually synchronize updates with these backup files.



Click Synchronize to update your files

RAID support

5

5.1 RAID configurations

The motherboard comes with the Intel® Rapid Storage Technology that supports RAID 0, RAID 1, RAID 10 and RAID 5 configuration.



If you want to install a Windows® operating system to a hard disk drive included in a RAID set, you have to create a RAID driver disk and load the RAID driver during OS installation. Refer to section 5.2 **Creating a RAID driver disk** for details.

5.1.1 RAID definitions

RAID 0 (Data striping) optimizes two identical hard disk drives to read and write data in parallel, interleaved stacks. Two hard disks perform the same work as a single drive but at a sustained data transfer rate, double that of a single disk alone, thus improving data access and storage. Use of two new identical hard disk drives is required for this setup.

RAID 1 (Data mirroring) copies and maintains an identical image of data from one drive to a second drive. If one drive fails, the disk array management software directs all applications to the surviving drive as it contains a complete copy of the data in the other drive. This RAID configuration provides data protection and increases fault tolerance to the entire system. Use two new drives or use an existing drive and a new drive for this setup. The new drive must be of the same size or larger than the existing drive.

RAID 5 stripes both data and parity information across three or more hard disk drives. Among the advantages of RAID 5 configuration include better HDD performance, fault tolerance, and higher storage capacity. The RAID 5 configuration is best suited for transaction processing, relational database applications, enterprise resource planning, and other business systems. Use a minimum of three identical hard disk drives for this setup.

RAID 10 is data striping and data mirroring combined without parity (redundancy data) having to be calculated and written. With the RAID 10 configuration you get all the benefits of both RAID 0 and RAID 1 configurations. Use four new hard disk drives or use an existing drive and three new drives for this setup.

5.1.2 Installing Serial ATA hard disks

The motherboard supports Serial ATA hard disk drives. For optimal performance, install identical drives of the same model and capacity when creating a disk array.

To install the SATA hard disks for a RAID configuration:

1. Install the SATA hard disks into the drive bays.
2. Connect the SATA signal cables.
3. Connect a SATA power cable to the power connector on each drive.

5.1.3 Setting the RAID item in BIOS

You must enable the RAID function in the BIOS Setup before creating RAID sets using SATA HDDs. To do this:

1. Enter the BIOS Setup during POST.
2. Go to the **Advanced** menu > **SATA Configuration**, and then press <Enter>.
3. Set the SATA Mode item to [RAID Mode].
4. Save your changes, and then exit the BIOS Setup.



Refer to Chapter 3 for details on entering and navigating through the BIOS Setup



Due to chipset limitation, when SATA ports are set to RAID mode, all SATA ports run at RAID mode together.

5.1.4 Intel® Rapid Storage Technology Option ROM utility

To enter the Intel® Rapid Storage Technology Option ROM utility:

1. Turn on the system.
2. During POST, press <Ctrl> + <I> to display the utility main menu.

```
Intel(R) Rapid Storage Technology - Option ROM - v10.5.1.1070
Copyright(C) 2003-10 Intel Corporation. All Rights Reserved.

[ MAIN MENU ]
1. Create RAID Volume      4. Recovery Volume Options
2. Delete RAID Volume     5. Acceleration Options
3. Reset Disks to Non-RAID 6. Exit

[ DISK/VOLUME INFORMATION ]

RAID Volumes:
None defined.

Physical Devices:
Port Device Model      Serial #      Size  Type/Status (Vol ID)
0  ST3160812AS         9LS0HJA4    149.0GB Non-RAID Disk
1  ST3160812AS         9LS0F4HL    149.0GB Non-RAID Disk
2  ST3160812AS         3LS0JYL8    149.0GB Non-RAID Disk
3  ST3160812AS         9LS0B75H    149.0GB Non-RAID Disk

[↑↓]-Select      [ESC]-Exit      [ENTER]-Select Menu
```

The navigation keys at the bottom of the screen allow you to move through the menus and select the menu options.



The RAID BIOS setup screens shown in this section are for reference only and may not exactly match the items on your screen.



The utility supports maximum four hard disk drives for RAID configuration.

Creating a RAID set

To create a RAID set:

1. From the utility main menu, select **1. Create RAID Volume** and press <Enter>. The following screen appears:

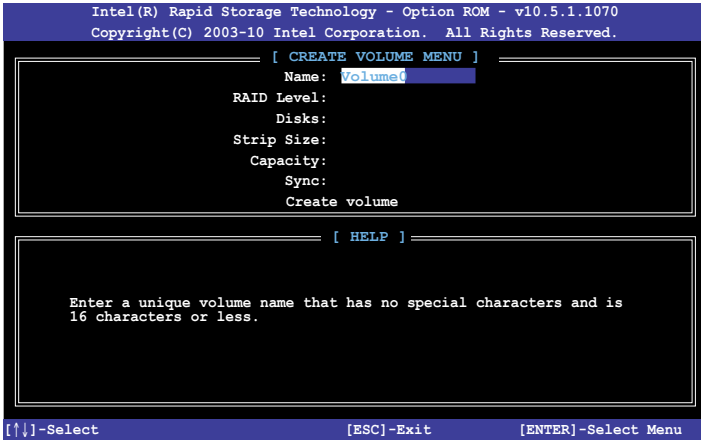

2. Enter a name for the RAID set and press <Enter>.
3. When the RAID Level item is selected, press the up/down arrow key to select a RAID level to create, and then press <Enter>.
4. When the Disks item is selected, press <Enter> to select the hard disk drives you want to include in the RAID set. The SELECT DISKS screen appears:

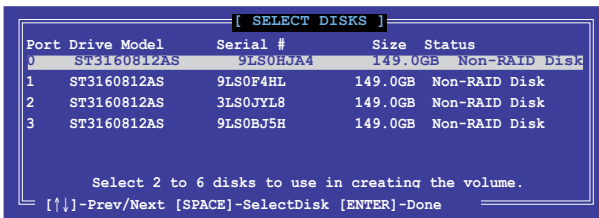

5. Use the up/down arrow key to select a drive, and then press <Space> to select. A small triangle marks the selected drive. Press <Enter> after completing your selection.
6. Use the up/down arrow key to select the stripe size for the RAID array (for RAID 0, 10 and 5 only), and then press <Enter>. The available stripe size values range from 4KB to 128KB. The following are typical values:
 - RAID 0: 128KB
 - RAID 10: 64KB
 - RAID 5: 64KB



We recommend a lower stripe size for server systems, and a higher stripe size for multimedia computer systems used mainly for audio and video editing.

7. When the **Capacity** item is selected, enter the RAID volume capacity that you want and press <Enter>. The default value indicates the maximum allowed capacity.
8. When the **Create Volume** item is selected, press <Enter>. The following warning message appears:

WARNING: ALL DATA ON SELECTED DISKS WILL BE LOST.
Are you sure you want to create this volume? (Y/N):

9. Press <Y> to create the RAID volume and return to the main menu, or <N> to go back to the CREATE VOLUME menu.

Deleting a RAID set



Be cautious when deleting a RAID set. You will lose all data on the hard disk drives when you delete a RAID set.

To delete a RAID set:

1. From the utility main menu, select **2. Delete RAID Volume** and press <Enter>. The following screen appears:

```
[ DELETE VOLUME MENU ]
Name      Level      Drives  Capacity  Status  Bootable
Volume0   RAID0 (Stripe)  2       298.0GB  Normal  Yes

[ HELP ]

Deleting a volume will reset the disks to non-RAID.

WARNING: ALL DISK DATA WILL BE DELETED.
        (This does not apply to Recovery volumes)

[↑]-Select      [ESC]-Previous Menu  [DEL]-Delete Volume
```

2. Use the up/down arrow key to select the RAID set you want to delete, and then press . The following warning message appears:

```
[ DELETE VOLUME VERIFICATION ]

ALL DATA IN THE VOLUME WILL BE LOST!
(This does not apply to Recovery volumes)

Are you sure you want to delete volume "Volume0"? (Y/N):
```

3. Press <Y> to delete the RAID set and return to the utility main menu, or press <N> to return to the DELETE VOLUME menu.

Exiting the Intel® Rapid Storage Technology Option ROM utility

To exit the utility:

1. From the utility main menu, select **5. Exit**, and then press <Enter>. The following warning message appears:



5.2 Creating a RAID driver disk

A floppy disk with the RAID driver is required when installing a Windows® operating system on a hard disk drive that is included in a RAID set.



The motherboard does not provide a floppy drive connector. You have to use a USB floppy disk drive when creating a SATA RAID driver disk.

5.2.1 Creating a RAID driver disk without entering the OS

To create a RAID driver disk without entering the OS:

1. Boot your computer.
2. Press during POST to enter the BIOS setup utility.
3. Set the optical drive as the primary boot device.
4. Insert the support DVD into the optical drive.
5. Save changes and exit BIOS.
6. When the Make Disk menu appears, press <1> to create a RAID driver disk.
7. Insert a formatted floppy disk into the USB floppy disk drive, then press <Enter>.
8. Follow the succeeding screen instructions to complete the process.

5.2.2 Creating a RAID driver disk in Windows®

To create a RAID driver disk in Windows®:

1. Start Windows®.
2. Plug the USB floppy disk drive and insert a floppy disk.
3. Place the motherboard support DVD into the optical drive.
4. Go to the **Make Disk** menu, and then click **Intel AHC/RAID Driver Disk** to create a RAID driver disk.
5. Select **USB floppy disk drive** as the destination disk.
6. Follow the succeeding screen instructions to complete the process.



Write-protect the floppy disk to avoid a computer virus infection.

5.2.3 Installing the RAID driver during Windows® OS installation

To install the RAID driver for Windows® 7 or later OS:

1. During the OS installation, click **Load Driver** to allow you to select the installation media containing the RAID driver.
2. Insert the USB flash drive with RAID driver into the USB port or the support DVD into the optical drive, and then click **Browse**.
3. Click the name of the device you've inserted, go to **Drivers > RAID**, and then select the RAID driver for the corresponding OS version. Click **OK**.
4. Follow the succeeding screen instructions to complete the installation.



Before loading the RAID driver from a USB flash drive, you have to use another computer to copy the RAID driver from the support DVD to the USB flash drive.

Appendices

Notices

Federal Communications Commission Statement

This device complies with Part 15 of the FCC Rules. Operation is subject to the following two conditions:

- This device may not cause harmful interference.
- This device must accept any interference received including interference that may cause undesired operation.

This equipment has been tested and found to comply with the limits for a Class B digital device, pursuant to Part 15 of the FCC Rules. These limits are designed to provide reasonable protection against harmful interference in a residential installation. This equipment generates, uses and can radiate radio frequency energy and, if not installed and used in accordance with manufacturer's instructions, may cause harmful interference to radio communications. However, there is no guarantee that interference will not occur in a particular installation. If this equipment does cause harmful interference to radio or television reception, which can be determined by turning the equipment off and on, the user is encouraged to try to correct the interference by one or more of the following measures:

- Reorient or relocate the receiving antenna.
- Increase the separation between the equipment and receiver.
- Connect the equipment to an outlet on a circuit different from that to which the receiver is connected.
- Consult the dealer or an experienced radio/TV technician for help.



The use of shielded cables for connection of the monitor to the graphics card is required to assure compliance with FCC regulations. Changes or modifications to this unit not expressly approved by the party responsible for compliance could void the user's authority to operate this equipment.

IC: Canadian Compliance Statement

Complies with the Canadian ICES-003 Class B specifications. This device complies with RSS 210 of Industry Canada. This Class B device meets all the requirements of the Canadian interference-causing equipment regulations.

This device complies with Industry Canada license exempt RSS standard(s). Operation is subject to the following two conditions: (1) this device may not cause interference, and (2) this device must accept any interference, including interference that may cause undesired operation of the device.

Cet appareil numérique de la Classe B est conforme à la norme NMB-003 du Canada. Cet appareil numérique de la Classe B respecte toutes les exigences du Règlement sur le matériel brouilleur du Canada.

Cet appareil est conforme aux normes CNR exemptes de licence d'Industrie Canada. Le fonctionnement est soumis aux deux conditions suivantes :

- (1) cet appareil ne doit pas provoquer d'interférences et
- (2) cet appareil doit accepter toute interférence, y compris celles susceptibles de provoquer un fonctionnement non souhaité de l'appareil.

Canadian Department of Communications Statement

This digital apparatus does not exceed the Class B limits for radio noise emissions from digital apparatus set out in the Radio Interference Regulations of the Canadian Department of Communications.

This class B digital apparatus complies with Canadian ICES-003.

VCCI: Japan Compliance Statement

VCCI Class B Statement

情報処理装置等電波障害自主規制について

この装置は、情報処理装置等電波障害自主規制協議会（VCCI）の基準に基づくクラスB情報技術装置です。この装置は家庭環境で使用することを目的としていますが、この装置がラジオやテレビジョン受信機に近接して使用されると、受信障害を引き起こすことがあります。

取扱説明書に従って正しい取り扱いをして下さい。

KC: Korea Warning Statement

B급 기기 (가정용 방송통신기자재)

이 기기는 가정용(B급) 전자파적합기기로서 주로 가정에서 사용하는 것을 목적으로 하며, 모든 지역에서 사용할 수 있습니다.

*당해 무선설비는 전파통신 가능성이 있으므로 인명안전과 관련된 서비스는 할 수 없습니다.

REACH

Complying with the REACH (Registration, Evaluation, Authorisation, and Restriction of Chemicals) regulatory framework, we published the chemical substances in our products at ASUS REACH website at <http://csr.asus.com/english/REACH.htm>.



DO NOT throw the motherboard in municipal waste. This product has been designed to enable proper reuse of parts and recycling. This symbol of the crossed out wheeled bin indicates that the product (electrical and electronic equipment) should not be placed in municipal waste. Check local regulations for disposal of electronic products.



DO NOT throw the mercury-containing button cell battery in municipal waste. This symbol of the crossed out wheeled bin indicates that the battery should not be placed in municipal waste.

ASUS Recycling/Takeback Services

ASUS recycling and takeback programs come from our commitment to the highest standards for protecting our environment. We believe in providing solutions for you to be able to responsibly recycle our products, batteries, other components as well as the packaging materials. Please go to <http://csr.asus.com/english/Takeback.htm> for detailed recycling information in different regions.

RF Equipment Notices

CE: European Community Compliance Statement

The equipment complies with the RF Exposure Requirement 1999/519/EC, Council Recommendation of 12 July 1999 on the limitation of exposure of the general public to electromagnetic fields (0–300 GHz). This wireless device complies with the R&TTE Directive.

Wireless Radio Use

This device is restricted to indoor use when operating in the 5.15 to 5.25 GHz frequency band.

Exposure to Radio Frequency Energy

The radiated output power of the Wi-Fi technology is below the FCC radio frequency exposure limits. Nevertheless, it is advised to use the wireless equipment in such a manner that the potential for human contact during normal operation is minimized.

FCC Bluetooth Wireless Compliance

The antenna used with this transmitter must not be colocated or operated in conjunction with any other antenna or transmitter subject to the conditions of the FCC Grant.

Bluetooth Industry Canada Statement

This Class B device meets all requirements of the Canadian interference-causing equipment regulations.

Cet appareil numérique de la Class B respecte toutes les exigences du Règlement sur le matériel brouilleur du Canada.

NCC: Taiwan Wireless Statement

無線設備的警告聲明

經型式認證合格之低功率射頻電機，非經許可，公司、商號或使用者均不得擅自變更射頻、加大功率或變更原設計之特性及功能。低功率射頻電機之使用不得影響飛航安全及干擾合法通信；經發現有干擾現象時，應立即停用，並改善至無干擾時方得繼續使用。前項合法通信指依電信法規定作業之無線通信。低功率射頻電機須忍受合法通信或工業、科學及醫療用電波輻射性電機設備之干擾。

於 5.25GHz 至 5.35GHz 區域內操作之
無線設備的警告聲明

工作頻率 5.250 ~ 5.350GHz 該頻段限於室內使用。

Japan RF Equipment Statement

この製品は、周波数帯域5.15~5.35GHzで動作しているときは、屋内においてのみ使用可能です。

KC (RF Equipment)

대한민국 규정 및 준수

방통위고시에 따른 고지사항

해당 무선설비는 운용 중 전파혼신 가능성이 있음.

이 기기는 인명안전과 관련된 서비스에 사용할 수 없습니다.

ASUS contact information

ASUSTeK COMPUTER INC.

Address 15 Li-Te Road, Peitou, Taipei, Taiwan 11259
Telephone +886-2-2894-3447
Fax +886-2-2890-7798
E-mail info@asus.com.tw
Web site www.asus.com.tw

Technical Support

Telephone +86-21-38429911
Online support support.asus.com

ASUS COMPUTER INTERNATIONAL (America)

Address 800 Corporate Way, Fremont, CA 94539, USA
Telephone +1-812-282-3777
Fax +1-510-608-4555
Web site usa.asus.com

Technical Support

Telephone +1-812-282-2787
Support fax +1-812-284-0883
Online support support.asus.com

ASUS COMPUTER GmbH (Germany and Austria)

Address Harkort Str. 21-23, D-40880 Ratingen, Germany
Fax +49-2102-959911
Web site www.asus.de
Online contact www.asus.de/sales

Technical Support

Telephone +49-1805-010923*
Support Fax +49-2102-9599-11
Online support support.asus.com

* EUR 0.14/minute from a German fixed landline; EUR 0.42/minute from a mobile phone.

DECLARATION OF CONFORMITY

Per FCC Part 2 Section 2.1077(c)



Responsible Party Name: **Asus Computer International**

Address: **800 Corporate Way, Fremont, CA 94539.**

Phone/Fax No: **(510)739-3777/(510)608-4555**

hereby declares that the product

Product Name : Motherboard OC accessory

Model Number : OC Panel

Conforms to the following specifications:

FCC Part 15, Subpart B, Unintentional Radiators

Supplementary Information:

This device complies with part 15 of the FCC Rules. Operation is subject to the following two conditions: (1) This device may not cause harmful interference, and (2) this device must accept any interference received, including interference that may cause undesired operation.

Representative Person's Name : **Steve Chang / President**

Signature :  _____
Date : **APR. 16, 2013** _____

Ver: 120901

EC Declaration of Conformity



We, the undersigned,

Manufacturer: **ASUS TEK COMPUTER INC.**
Address: **4F, NO. 55, LITE RD., PEITOU, TAIPEI 112, TAIWAN**
Country: **TAIWAN**
Authorized representative in Europe: **ASUS COMPUTER GmbH**
Address: **HARKORT STR. 21-23, 40880 RATTLINGEN**
Country: **GERMANY**

declare the following apparatus:

Product name : _____ **Motherboard OC accessory**

Model name : _____ **OC Panel**

conform with the essential requirements of the following directives:

2004/108/EC-EMC Directive
 EN 55022:2010
 EN 61000-3-2:2006/A2:2009
 EN 61000-3-3:2008
 EN 55013:2001/A2:12003/A2:2008
 EN 55020:2007/A1:2011

1999/5/EC-R&TTE Directive

EN 300 440-1 V1.6.1 (2010-08)
 EN 300 440-2 V1.4.1 (2010-08)
 EN 300 440-3 V1.4.1 (2010-08)
 EN 301 908-1 V5.2 (2011-05)
 EN 301 908-2 V5.2 (2011-07)
 EN 303 684 V1.6 (2010-11)
 EN 303 684 V1.1 (2009-01)
 EN 50360:2001
 EN 300 357-2 V1.4 (2008-11)
 EN 50385:2002
 EN 62311:2008

2006/95/EC-LVD Directive

EN 60950-1/A12:2011
 EN 60066:2002 / A2:2011

2009/128/EC-EPF Directive

Regulation (EC) No. 1275/2008
 Regulation (EC) No. 642/2009

2011/65/EU-ROHS Directive

Regulation (EC) No. 642/2009

CE marking



(EC conformity marking)

Position : **CEO**
Name : **Jerry Shen**

Signature : _____

Declaration Date: **16/04/2013**
Year to begin affixing CE marking: **2013**

Ver: 130208

Free Manuals Download Website

<http://myh66.com>

<http://usermanuals.us>

<http://www.somanuals.com>

<http://www.4manuals.cc>

<http://www.manual-lib.com>

<http://www.404manual.com>

<http://www.luxmanual.com>

<http://aubethermostatmanual.com>

Golf course search by state

<http://golfingnear.com>

Email search by domain

<http://emailbydomain.com>

Auto manuals search

<http://auto.somanuals.com>

TV manuals search

<http://tv.somanuals.com>