

**A8V-E**

*Deluxe*

**ASUS**<sup>®</sup>

**Motherboard**

**E1781**

**First Edition  
December 2004**

**Copyright © 2004 ASUSTeK COMPUTER INC. All Rights Reserved.**

No part of this manual, including the products and software described in it, may be reproduced, transmitted, transcribed, stored in a retrieval system, or translated into any language in any form or by any means, except documentation kept by the purchaser for backup purposes, without the express written permission of ASUSTeK COMPUTER INC. ("ASUS").

Product warranty or service will not be extended if: (1) the product is repaired, modified or altered, unless such repair, modification or alteration is authorized in writing by ASUS; or (2) the serial number of the product is defaced or missing.

ASUS PROVIDES THIS MANUAL "AS IS" WITHOUT WARRANTY OF ANY KIND, EITHER EXPRESS OR IMPLIED, INCLUDING BUT NOT LIMITED TO THE IMPLIED WARRANTIES OR CONDITIONS OF MERCHANTABILITY OR FITNESS FOR A PARTICULAR PURPOSE. IN NO EVENT SHALL ASUS, ITS DIRECTORS, OFFICERS, EMPLOYEES OR AGENTS BE LIABLE FOR ANY INDIRECT, SPECIAL, INCIDENTAL, OR CONSEQUENTIAL DAMAGES (INCLUDING DAMAGES FOR LOSS OF PROFITS, LOSS OF BUSINESS, LOSS OF USE OR DATA, INTERRUPTION OF BUSINESS AND THE LIKE), EVEN IF ASUS HAS BEEN ADVISED OF THE POSSIBILITY OF SUCH DAMAGES ARISING FROM ANY DEFECT OR ERROR IN THIS MANUAL OR PRODUCT.

SPECIFICATIONS AND INFORMATION CONTAINED IN THIS MANUAL ARE FURNISHED FOR INFORMATIONAL USE ONLY, AND ARE SUBJECT TO CHANGE AT ANY TIME WITHOUT NOTICE, AND SHOULD NOT BE CONSTRUED AS A COMMITMENT BY ASUS. ASUS ASSUMES NO RESPONSIBILITY OR LIABILITY FOR ANY ERRORS OR INACCURACIES THAT MAY APPEAR IN THIS MANUAL, INCLUDING THE PRODUCTS AND SOFTWARE DESCRIBED IN IT.

Products and corporate names appearing in this manual may or may not be registered trademarks or copyrights of their respective companies, and are used only for identification or explanation and to the owners' benefit, without intent to infringe.

# Contents

Notices .....	vii
Safety information .....	viii
About this guide .....	ix
How this guide is organized .....	ix
Where to find more information .....	ix
Conventions used in this guide .....	x
Typography .....	x
A8V-E Deluxe specifications summary .....	xi

## Chapter 1: Product introduction

1.1	Welcome! .....	1-1
1.2	Package contents .....	1-1
1.3	Special features .....	1-2
1.3.1	Product highlights .....	1-2
1.3.2	ASUS Proactive features .....	1-4
1.3.3	Innovative ASUS features .....	1-5

## Chapter 2: Hardware information

2.1	Before you proceed .....	2-1
2.2	Motherboard overview .....	2-2
2.2.1	Placement direction .....	2-2
2.2.2	Screw holes .....	2-2
2.2.3	Motherboard layout .....	2-3
2.2.4	Layout Contents .....	2-4
2.3	Central Processing Unit (CPU) .....	2-6
2.3.1	Overview .....	2-6
2.3.2	Installing the CPU .....	2-6
2.3.3	Installing the heatsink and fan .....	2-8
2.4	System memory .....	2-10
2.4.1	Overview .....	2-10
2.4.2	Memory Configurations .....	2-11
2.4.3	Installing a DIMM .....	2-13
2.4.4	Removing a DIMM .....	2-13
2.5	Expansion slots .....	2-14
2.5.1	Installing an expansion card .....	2-14
2.5.2	Configuring an expansion card .....	2-14

# Contents

2.5.3	Interrupt assignments .....	2-17
2.5.4	PCI slots .....	2-18
2.5.5	PCI Express x16 slot .....	2-18
2.5.6	PCI Express x1 slot .....	2-18
2.6	Jumpers .....	2-19
2.7	Connectors .....	2-22
2.7.1	Rear panel connectors .....	2-22
2.7.2	Internal connectors .....	2-24

## Chapter 3: Powering up

3.1	Starting up for the first time .....	3-1
3.2	Powering off the computer .....	3-2
3.2.1	Using the OS shut down function .....	3-2
3.2.2	Using the dual function power switch .....	3-2
3.3	ASUS POST Reporter™ .....	3-3
3.3.1	Vocal POST messages .....	3-3
3.3.2	Winbond Voice Editor .....	3-5

## Chapter 4: BIOS setup

4.1	Managing and updating your BIOS .....	4-1
4.1.1	Creating a bootable floppy disk .....	4-1
4.1.2	Updating the BIOS .....	4-2
4.1.3	Saving the current BIOS file .....	4-4
4.1.4	ASUS CrashFree BIOS 2 utility .....	4-5
4.1.5	ASUS EZ Flash utility .....	4-7
4.1.6	ASUS Update utility .....	4-8
4.2	BIOS setup program .....	4-11
4.2.1	BIOS menu screen .....	4-12
4.2.2	Menu bar .....	4-12
4.2.3	Legend bar .....	4-13
4.2.4	Menu items .....	4-13
4.2.5	Sub-menu items .....	4-13
4.2.6	Configuration fields .....	4-13
4.2.8	General help .....	4-14
4.2.7	Pop-up window .....	4-14

# Contents

4.3	Main menu .....	4-15
4.3.1	System Time .....	4-15
4.3.2	System Date .....	4-15
4.3.3	Language .....	4-15
4.3.4	Legacy Diskette A .....	4-15
4.3.5	Primary and Secondary IDE Master/Slave .....	4-16
4.3.6	Installed Memory .....	4-17
4.4	Advanced menu .....	4-18
4.4.1	CPU Configuration .....	4-18
4.4.2	Chipset .....	4-19
4.4.3	PCI PnP .....	4-21
4.4.4	Onboard Devices Configuration .....	4-23
4.4.5	USB Configuration .....	4-25
4.4.6	JumperFree Configuration .....	4-26
4.4.7	LAN Cable Status .....	4-30
4.4.8	PEG Link Mode .....	4-30
4.4.9	Speech Configuration .....	4-31
4.4.10	Instant Music .....	4-32
4.5	Power menu .....	4-33
4.5.1	ACPI Suspend Type .....	4-33
4.5.2	ACPI APIC Support .....	4-33
4.5.3	APM Configuration .....	4-34
4.5.4	Hardware Monitor .....	4-36
4.6	Boot menu .....	4-37
4.6.1	Boot Device Priority .....	4-38
4.6.2	Removable Drives .....	4-38
4.6.3	Hard Disk Drives .....	4-39
4.6.4	CDROM Drives .....	4-39
4.6.5	Boot Settings Configuration .....	4-40
4.6.6	Security .....	4-42
4.7	Exit menu .....	4-44

## Chapter 5: Software support

5.1	Installing an operating system .....	5-1
5.2	Support CD information .....	5-1

# Contents

5.2.1	Running the support CD .....	5-1
5.2.2	Drivers menu .....	5-2
5.2.3	Utilities menu .....	5-4
5.2.4	ASUS Contact information .....	5-6
5.2.5	Other information .....	5-6
5.3	Software information .....	5-9
5.3.1	ASUS MyLogo2™ .....	5-9
5.3.2	AI NET 2 .....	5-11
	Using the Virtual Cable Tester™ .....	5-11
5.3.3	Audio configurations .....	5-12
5.4	RAID configurations .....	5-18
5.4.1	Installing hard disks .....	5-18
5.4.2	VIA RAID configurations .....	5-19
5.5	Creating a RAID driver disk .....	5-26
5.6	Cool 'n' Quiet!™ Technology .....	5-27
5.6.1	Enabling Cool 'n' Quiet!™ Technology .....	5-27
5.6.2	Launching the Cool 'n' Quiet!™ software .....	5-28

# Notices

## Federal Communications Commission Statement

This device complies with Part 15 of the FCC Rules. Operation is subject to the following two conditions:

- This device may not cause harmful interference, and
- This device must accept any interference received including interference that may cause undesired operation.

This equipment has been tested and found to comply with the limits for a Class B digital device, pursuant to Part 15 of the FCC Rules. These limits are designed to provide reasonable protection against harmful interference in a residential installation. This equipment generates, uses and can radiate radio frequency energy and, if not installed and used in accordance with manufacturer's instructions, may cause harmful interference to radio communications. However, there is no guarantee that interference will not occur in a particular installation. If this equipment does cause harmful interference to radio or television reception, which can be determined by turning the equipment off and on, the user is encouraged to try to correct the interference by one or more of the following measures:

- Reorient or relocate the receiving antenna.
- Increase the separation between the equipment and receiver.
- Connect the equipment to an outlet on a circuit different from that to which the receiver is connected.
- Consult the dealer or an experienced radio/TV technician for help.



---

The use of shielded cables for connection of the monitor to the graphics card is required to assure compliance with FCC regulations. Changes or modifications to this unit not expressly approved by the party responsible for compliance could void the user's authority to operate this equipment.

---

## Canadian Department of Communications Statement

This digital apparatus does not exceed the Class B limits for radio noise emissions from digital apparatus set out in the Radio Interference Regulations of the Canadian Department of Communications.

**This class B digital apparatus complies with Canadian ICES-003.**

# Safety information

## Electrical safety

- To prevent electrical shock hazard, disconnect the power cable from the electrical outlet before relocating the system.
- When adding or removing devices to or from the system, ensure that the power cables for the devices are unplugged before the signal cables are connected. If possible, disconnect all power cables from the existing system before you add a device.
- Before connecting or removing signal cables from the motherboard, ensure that all power cables are unplugged.
- Seek professional assistance before using an adapter or extension cord. These devices could interrupt the grounding circuit.
- Make sure that your power supply is set to the correct voltage in your area. If you are not sure about the voltage of the electrical outlet you are using, contact your local power company.
- If the power supply is broken, do not try to fix it by yourself. Contact a qualified service technician or your retailer.

## Operation safety

- Before installing the motherboard and adding devices on it, carefully read all the manuals that came with the package.
- Before using the product, make sure all cables are correctly connected and the power cables are not damaged. If you detect any damage, contact your dealer immediately.
- To avoid short circuits, keep paper clips, screws, and staples away from connectors, slots, sockets and circuitry.
- Avoid dust, humidity, and temperature extremes. Do not place the product in any area where it may become wet.
- Place the product on a stable surface.
- If you encounter technical problems with the product, contact a qualified service technician or your retailer.



# About this guide

This user guide contains the information you need when installing and configuring the motherboard.

## How this guide is organized

This manual contains the following parts:

- **Chapter 1: Product introduction**  
This chapter describes the features of the motherboard and the new technology it supports.
- **Chapter 2: Hardware information**  
This chapter lists the hardware setup procedures that you have to perform when installing system components. It includes description of the switches, jumpers, and connectors on the motherboard.
- **Chapter 3: Powering up**  
This chapter describes the power up sequence, the vocal POST messages, and ways of shutting down the system.
- **Chapter 4: BIOS setup**  
This chapter tells how to change system settings through the BIOS Setup menus. Detailed descriptions of the BIOS parameters are also provided.
- **Chapter 5: Software support**  
This chapter describes the contents of the support CD that comes with the motherboard package.

## Where to find more information

Refer to the following sources for additional information and for product and software updates.

### 1. ASUS websites

The ASUS website provides updated information on ASUS hardware and software products. Refer to the ASUS contact information.

### 2. Optional documentation

Your product package may include optional documentation, such as warranty flyers, that may have been added by your dealer. These documents are not part of the standard package.

## Conventions used in this guide

To make sure that you perform certain tasks properly, take note of the following symbols used throughout this manual.



**DANGER/WARNING:** Information to prevent injury to yourself when trying to complete a task.



**CAUTION:** Information to prevent damage to the components when trying to complete a task.



**IMPORTANT:** Instructions that you **MUST** follow to complete a task.



**NOTE:** Tips and additional information to help you complete a task.

## Typography

**Bold text**

Indicates a menu or an item to select

*Italics*

Used to emphasize a word or a phrase

<Key>

Keys enclosed in the less-than and greater-than sign means that you must press the enclosed key

Example: <Enter> means that you must press the Enter or Return key

<Key1+Key2+Key3>

If you must press two or more keys simultaneously, the key names are linked with a plus sign (+)

Example: <Ctrl+Alt+D>

**Command**

Means that you must type the command exactly as shown, then supply the required item or value enclosed in brackets

Example: At the DOS prompt, type the command line:

**afudos /i[filename]**

**afudos /iA8V-E.ROM**

## A8V-E Deluxe specifications summary

<b>CPU</b>	Socket 939 for AMD Athlon™ 64FX/AMD Athlon™ 64 processor Supports AMD 64 architecture that enables simultaneous 32-bit and 64-bit architecture Supports AMD Cool 'n' Quiet! Technology
<b>Chipset</b>	Northbridge: VIA® K8T890 Southbridge: VIA® VT8237R
<b>System Bus</b>	2000 MT/s
<b>Memory</b>	Dual-channel memory architecture 4 x 184-pin DIMM sockets support ECC/non-ECC unbuffered 400/333/266 MHz DDR memory modules Supports up to 4 GB system memory
<b>Expansion slots</b>	1 x PCI Express x16 slot for discrete graphics card 2 x PCI Express x1 slots 3 x PCI slots
<b>Storage</b>	VIA® VT8237R Southbridge supports: <ul style="list-style-type: none"> <li>- 2 x Ultra DMA 133/100/66/33</li> <li>- 2 x Serial ATA with RAID 0 and RAID 1</li> </ul>
<b>AI Audio</b>	Realtek® ALC850 8-channel CODEC 1 x Coaxial S/PDIF out port 1 x Optical S/PDIF out port Supports Audio Sensing and Enumeration Technology
<b>Wireless LAN</b>	WiFi-g™ wireless solution provides: <ul style="list-style-type: none"> <li>- support for IEEE 802.11g/b standard</li> <li>- up to 54Mbps wireless data transmission</li> <li>- Software Access Point (Soft AP) feature on Windows® XP and 2003 Server</li> </ul>
<b>LAN</b>	Marvell® 88E8053 PCI Express™ Gigabit LAN controller Supports Marvell® Virtual Cable Tester technology Supports POST Network-diagnostic program
<b>IEEE 1394</b>	T1 TSB43AB22A 1394a controller supports: <ul style="list-style-type: none"> <li>- 1 x IEEE 1394 internal connector</li> <li>- 1 x IEEE 1394 port</li> </ul>
<b>USB</b>	Supports up to 8 USB 2.0 ports

*(continued on the next page)*

## A8V-E Deluxe specifications summary

<b>AI Overclocking</b>	ASUS AI Overclocking (Intelligent CPU frequency tuner) ASUS C.P.R. (CPU Parameter Recall) ASUS JumperFree CPU, Memory, and chipset voltage adjustable Stepless Frequency Selection(SFS) from 200 MHz up to 400 MHz at 1 MHz increment
<b>Special features</b>	ASUS Wi-Fi@HOME ASUS Post Reporter™ ASUS Q-Fan2 ASUS CrashFree BIOS 2 ASUS Multi-language BIOS ASUS MyLogo2 ASUS Instant Music
<b>BIOS features</b>	4 MB Flash ROM, Phoenix-Award BIOS, PnP, DMI2.0, WfM2.0, SM BIOS 2.3
<b>Rear panel</b>	1 x Parallel port 1 x IEEE 1394 port 1 x LAN (RJ-45) port 1 x WiFi-g™ antenna port 1 x Wireless LAN LED 4 x USB 2.0 ports 1 x Optical S/PDIF out port 1 x Coaxial S/PDIF out port 1 x PS/2 keyboard port 1 x PS/2 mouse port 8-channel audio port
<b>Internal connectors</b>	1 x Floppy disk drive connector 2 x IDE connectors 2 x Serial ATA connectors 1 x CPU fan connector 1 x Power fan connector 2 x Chassis fan connector 1 x Serial port connector (COM port) 1 x 24-pin ATX power connector 1 x 4-pin ATX 12 V power connector 2 x USB 2.0 connectors for 4 additional USB 2.0 ports 1 x Internal audio connectors 1 x IEEE 1394 connector 1 x GAME/MIDI connector 1 x Chassis intrusion connector 1 x Front panel audio connector System panel connector

*(continued on the next page)*

## A8V-E Deluxe specifications summary

<b>Power Requirement</b>	ATX power supply (with 24-pin and 4-pin 12 V plugs) ATX 12 V 2.0 compliant
<b>Form Factor</b>	ATX form factor: 12 in x 9.6 in (30.5 cm x 24.4 cm)
<b>Support CD contents</b>	Device drivers ASUS PC Probe ASUS Live Update Utility Antivirus software (OEM version) WiFi-g™ One-touch wizard

*\*Specifications are subject to change without notice.*



This chapter describes the motherboard features and the new technologies it supports.

# Product introduction



## Chapter summary

1.1	Welcome! .....	1-1
1.2	Package contents .....	1-1
1.3	Special features .....	1-2



## 1.1 Welcome!

Thank you for buying an ASUS® A8V-E Deluxe motherboard!

The motherboard delivers a host of new features and latest technologies, making it another standout in the long line of ASUS quality motherboards!

Before you start installing the motherboard, and hardware devices on it, check the items in your package with the list below.

## 1.2 Package contents

Check your motherboard package for the following items.

<b>Motherboard</b>	ASUS A8V-E Deluxe motherboard
<b>I/O modules</b>	IEEE1394 (1 port) module Serial port module (COM port) USB 2.0 (2 ports) and GAME (1 port) module
<b>Cables</b>	2 x Serial ATA signal cables 1 x Serial ATA power cables (dual plugs) 2 x Ultra DMA/133 cables 40-conductor IDE cable Floppy disk drive cable
<b>Accessories</b>	Dipolar wireless LAN antenna I/O shield
<b>Application CDs</b>	ASUS motherboard support CD InterVideo® WinDVD Suite®
<b>Documentation</b>	User guide



If any of the above items is damaged or missing, contact your retailer.

## 1.3 Special features

### 1.3.1 Product highlights

#### Latest processor technology



The AMD Athlon™ 64FX and Athlon™ 64 desktop processors are based on AMD's 64-bit and 32-bit architecture, which represents the landmark introduction of the industry's first x86-64 technology. These processors provide a dramatic leap forward in compatibility, performance, investment protection, and reduced total cost of ownership and development. See page 2-6.

#### HyperTransport™ Technology



HyperTransport™ Technology is a high-speed, low latency, point-to-point link designed to increase the communication speed between integrated circuits in computers, networking and telecommunications equipment up to 48 times faster than other existing technologies.

#### AMD Cool 'n' Quiet!™ Technology



The motherboard supports the AMD Cool 'n' Quiet!™ Technology that dynamically and automatically changes the CPU speed, voltage and amount of power depending on the task the CPU performs. See pages 4-18 and 5-27 for details.

#### Dual Channel DDR memory support



Employing the Double Data Rate (DDR) memory technology, the motherboard supports up to 4GB of system memory using DDR400/333/266 DIMMs. The ultra-fast 400MHz memory bus delivers the required bandwidth for the latest 3D graphics, multimedia, and Internet applications. See page 2-10.

#### Serial ATA technology with RAID 0/1 support



The motherboard supports the Serial ATA technology through the Serial ATA interfaces. The SATA specification allows for thinner, more flexible cables with lower pin count, reduced voltage requirement, and up to 150 MB/s data transfer rate. With the VIA VT8237R RAID controller onboard, the motherboard supports RAID 0 and RAID 1 configuration using Serial ATA hard disk drives. See pages 2-25 and 5-18 for details.

## PCI Express™ interface

The motherboard fully supports PCI Express, the latest I/O interconnect technology that speeds up the PCI bus. PCI Express features point-to-point serial interconnections between devices and allows higher clockspeeds by carrying data in packets. This high speed interface is software compatible with existing PCI specifications. See page 2-18 for details.

## AI Audio technology

The motherboard supports 8-channel audio through the onboard ALC850 CODEC with 16-bit DAC, a stereo 16-bit ADC, and an AC97 2.3 compatible multi-channel audio designed for PC multimedia systems. It also provides Jack-Sensing function, S/PDIF out support, interrupt capability and includes the Realtek® proprietary UAJ® (Universal Audio Jack) technology. See pages 2-22, 2-23 and 5-12 for details.

## S/PDIF digital sound ready

The motherboard supports the S/PDIF In/Out function through the S/PDIF interfaces on the rear panel and at midboard. The S/PDIF technology turns your computer into a high-end entertainment system with digital connectivity to powerful audio and speaker systems. See page 2-23 for details.

## IEEE 1394a support

The IEEE 1394a interface provides high-speed and flexible PC connectivity to a wide range of peripherals and devices compliant to the IEEE 1394a standard. The IEEE 1394a interface allows up to 400 Mbps transfer rates through simple, low-cost, high-bandwidth asynchronous (real-time) data interfacing between computers, peripherals, and consumer electronic devices such as camcorders, VCRs, printers, TVs, and digital cameras. See pages 2-22 and 2-30 for details.

## USB 2.0 technology

The motherboard implements the Universal Serial Bus (USB) 2.0 specification, dramatically increasing the connection speed from the 12 Mbps bandwidth on USB 1.1 to a fast 480 Mbps on USB 2.0. USB 2.0 is backward compatible with USB 1.1. See pages 2-23, 2-27 and 4-25 for details.

## Temperature, fan, and voltage monitoring

The CPU temperature is monitored by the ASIC (integrated in the Winbond Super I/O) to prevent overheating and damage. The system fan rotations per minute (RPM) is monitored for timely failure detection. The ASIC monitors the voltage levels to ensure stable supply of current for critical components. See section “4.5.4 Hardware Monitor” on page 4-36.

### 1.3.2 ASUS Proactive features



#### ASUS WiFi-g™



ASUS WiFi-g™ is an IEEE 802.11g-compliant wireless LAN adapter that allows data transmission of up to 54 Mbps using the 2.4 GHz frequency band. ASUS provides full software application support and a user-friendly wizard to help you set up your wireless local area network effortlessly. The ASUS WiFi-g™ is backward compatible with IEEE 802.11b devices. See page 2-23.

#### AI NOS™ (Non-Delay Overclocking System)



ASUS Non-delay Overclocking System™ (NOS) is a technology that auto-detects the CPU loading and dynamically overclocks the CPU speed only when needed. See page 4-26 for details.

#### AI NET 2



AI NET 2 is a BIOS-based diagnostic tool that detects and reports Ethernet cable faults and shorts. With this utility, you can easily monitor the condition of the Ethernet cable(s) connected to the LAN (RJ-45) port(s). During the bootup process, AI NET 2 immediately diagnoses the LAN cable(s) and reports shorts and faults up to 100 meters at 1 meter accuracy. See pages 4-30 and 5-11 for details.

## 1.3.3 Innovative ASUS features

### Precision Tweaker

Designed for overclocking aficionados, this feature allows you to gradually increase the CPU and memory voltage to achieve maximum system performance.

### PEG Link mode

This feature allows you to adjust the PCI Express graphics frequency according to your system configuration for optimized graphics performance.

### CrashFree BIOS 2

This feature allows you to restore the original BIOS data from the support CD in case when the BIOS codes and data are corrupted. This protection eliminates the need to buy a replacement ROM chip. See details on page 4-5.

### ASUS Q-Fan 2 technology

The ASUS Q-Fan 2 technology smartly adjusts the fan speeds according to the system loading to ensure quiet, cool, and efficient operation. See page 4-36 for details.

### ASUS POST Reporter™

The motherboard offers a new exciting feature called the ASUS POST Reporter™ to provide friendly voice messages and alerts during the Power-On Self-Tests (POST) informing you of the system boot status and causes of boot errors, if any. The bundled Winbond Voice Editor software lets you to customize the voice messages in different languages. See page 3-3 for details.

### ASUS Multi-language BIOS

The multi-language BIOS allows you to select the language of your choice from the available options. The localized BIOS menus allow you to configure easier and faster. See page 4-15 for details.

## ASUS MyLogo2™

This new feature present in the motherboard allows you to personalize and add style to your system with customizable boot logos. See page 5-9 for details.

## ASUS Instant Music

This unique feature allows you to playback audio files even without booting the system to Windows™. Just press the ASUS Instant Music special function keys and enjoy the music! See page 4-32 for details.

This chapter lists the hardware setup procedures that you have to perform when installing system components. It includes description of the jumpers and connectors on the motherboard.

# Hardware information



## Chapter summary

2.1	Before you proceed .....	2-1
2.2	Motherboard overview .....	2-2
2.3	Central Processing Unit (CPU) .....	2-6
2.4	System memory .....	2-10
2.5	Expansion slots .....	2-14
2.6	Jumpers .....	2-19
2.7	Connectors .....	2-22



## 2.1 Before you proceed

Take note of the following precautions before you install motherboard components or change any motherboard settings.



- Unplug the power cord from the wall socket before touching any component.
- Use a grounded wrist strap or touch a safely grounded object or to a metal object, such as the power supply case, before handling components to avoid damaging them due to static electricity
- Hold components by the edges to avoid touching the ICs on them.
- Whenever you uninstall any component, place it on a grounded antistatic pad or in the bag that came with the component.
- **Before you install or remove any component, ensure that the ATX power supply is switched off or the power cord is detached from the power supply.** Failure to do so may cause severe damage to the motherboard, peripherals, and/or components.

### Onboard LED

The motherboard comes with a standby power LED that lights up to indicate that the system is ON, in sleep mode, or in soft-off mode. This is a reminder that you should shut down the system and unplug the power cable before removing or plugging in any motherboard component. The illustration below shows the location of the onboard LED.

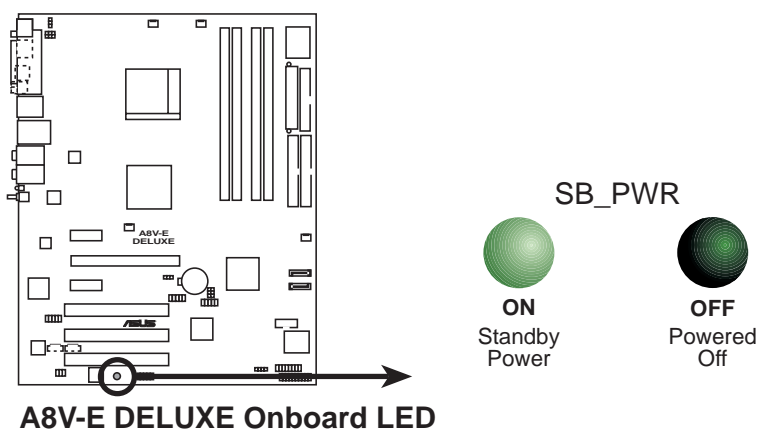

## 2.2 Motherboard overview

Before you install the motherboard, study the configuration of your chassis to ensure that the motherboard fits into it.



Make sure to unplug the power cord before installing or removing the motherboard. Failure to do so can cause you physical injury and damage motherboard components.

### 2.2.1 Placement direction

When installing the motherboard, make sure that you place it into the chassis in the correct orientation. The edge with external ports goes to the rear part of the chassis as indicated in the image below.

### 2.2.2 Screw holes

Place nine (9) screws into the holes indicated by circles to secure the motherboard to the chassis.



Do not overtighten the screws! Doing so can damage the motherboard.

Place this side towards  
the rear of the chassis

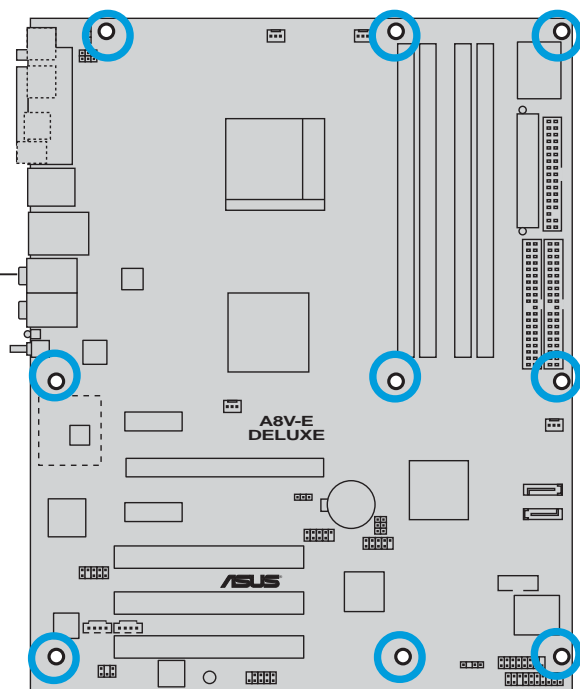

## 2.2.3 Motherboard layout

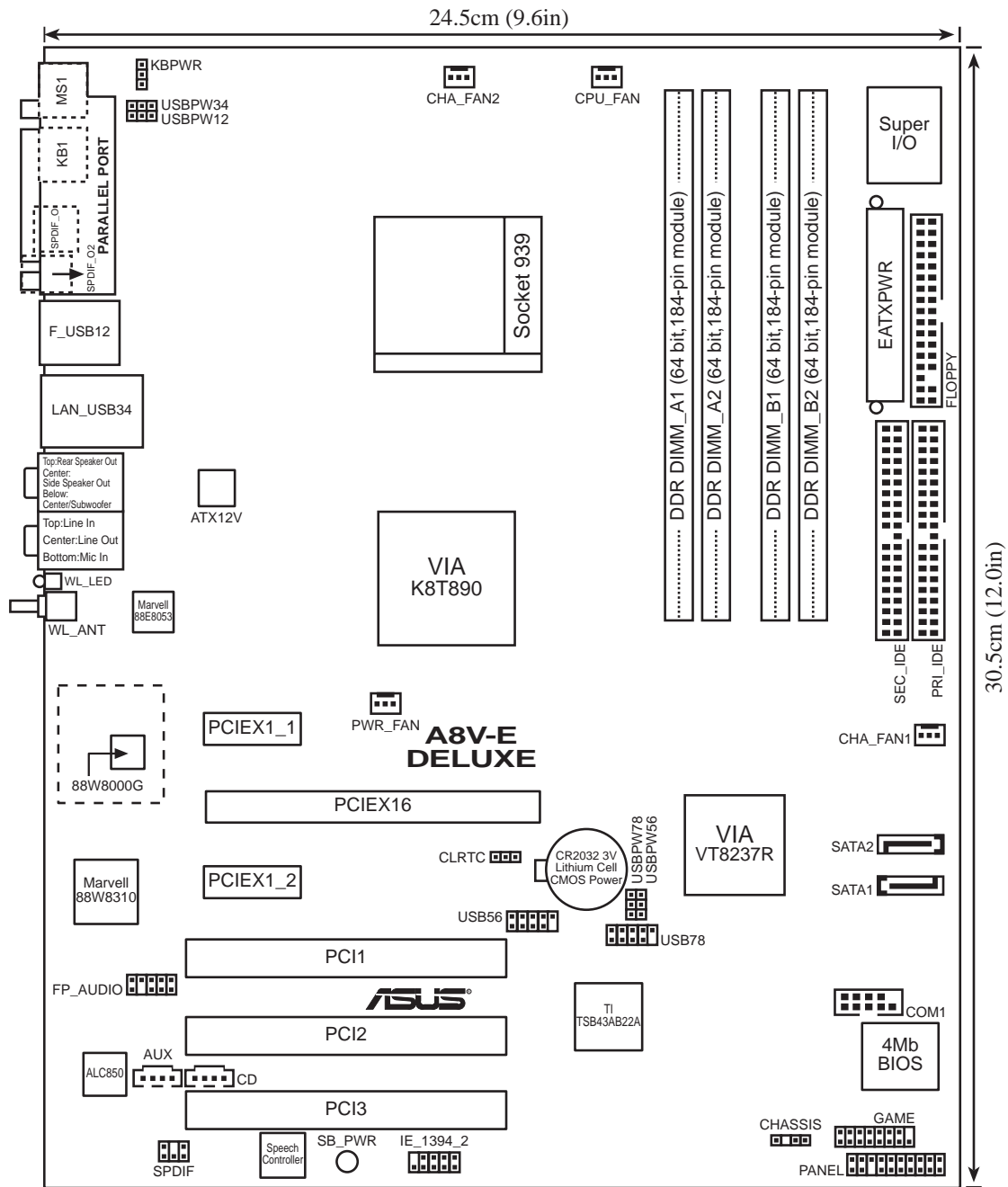

## 2.2.4 Layout Contents

Slots	Page
1. DDR DIMM slots	2-11
2. PCI slots	2-18
3. PCI Express x16 slot	2-18
4. PCI Express x1 slot	2-18

Jumpers	Page
1. Clear RTC RAM (3-pin CLRTC)	2-19
2. USB Device wake-up (3-pin USBPW12, USBPW34, USBPW56, USBPW78)	2-19
3. Keyboard power (3-pin KBPWR)	2-19

Rear panel connectors	Page
1. Parallel port	2-22
2. IEEE 1394 port	2-22
3. RJ-45 port	2-22
4. Rear Speaker Out port (gray)	2-22
5. Side Speaker Out port (black)	2-22
6. Line In port (light blue)	2-22
7. Line Out port (lime)	2-22
8. WiFi-g™ antenna port	2-23
9. Wireless LAN data transmission LED	2-23
10. Microphone port (pink)	2-23
11. Center/Subwoofer port (yellow orange)	2-23
12. USB 2.0 ports 3 and 4	2-23
13. USB 2.0 ports 1 and 2	2-23
14. Optical S/PDIF out port	2-23
15. Coaxial S/PDIF out port	2-23
16. PS/2 keyboard port (purple)	2-23
17. PS/2 mouse port (green)	2-23

Internal connectors	Page
1. Floppy disk drive connector (34-1 pin FLOPPY)	2-24
2. Primary IDE connector (40-1 pin PRI_IDE)	2-24
3. Secondary IDE connector (40-1 pin SEC_IDE)	2-24
4. Serial ATA connectors (7-pin SATA1, SATA2)	2-25
5. CPU fan connector (4-pin CPU_FAN)	2-26
6. Power fan connector (3-pin CHIP_FAN)	2-26
7. Chassis fan connector (3-pin CHA_FAN1)	2-26
8. Chassis fan 2 connector (3-pin CHA_FAN2)	2-26
9. Serial port connector (10-1 pin COM1)	2-27
10. USB headers (10-1 USB56, USB78)	2-27
11. ATX power connector (24-pin EATXPWR)	2-28
12. ATX 12V power connector (4-pin ATX12V)	2-28
13. Internal audio connector (4-pin CD, AUX)	2-29
14. GAME/MIDI connector (16-1 pin GAME)	2-29
15. Chassis intrusion connector (4-1 pin CHASSIS)	2-30
16. IEEE 1394 connector (10-1 pin IE1394_2)	2-30
17. Front panel audio connector (10-1 pin F_PANEL)	2-31
18. Digital audio connector (4-pin SPDIF)	2-31
19. System panel connectors (20-1 pin PANEL)	2-32
- System Power LED (Green 3-pin PLED)	
- Hard Disk activity (Red 2-pin IDE_LED)	
- System warning speaker (Orange 4-pin SPEAKER)	
- Power/Soft-off button (Yellow 2-pin PWR)	
- Reset switch (Blue 2-pin RESET)	

## 2.3 Central Processing Unit (CPU)

### 2.3.1 Overview

The motherboard comes with a surface mount 939-pin Zero Insertion Force (ZIF) socket designed for the AMD Athlon™ 64FX or AMD Athlon 64™ processor.

The 128-bit-wide data paths of these processors can run applications faster than processors with only 32-bit or 64-bit wide data paths.

Take note of the marked corner (with gold triangle) on the CPU. This mark should match a specific corner on the socket to ensure correct installation.

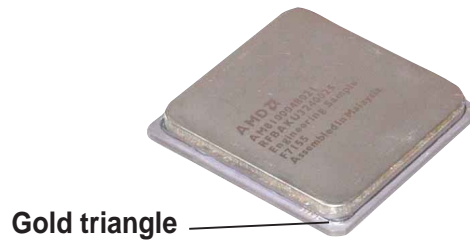

### 2.3.2 Installing the CPU

To install a CPU:

1. Locate the CPU socket on the motherboard.

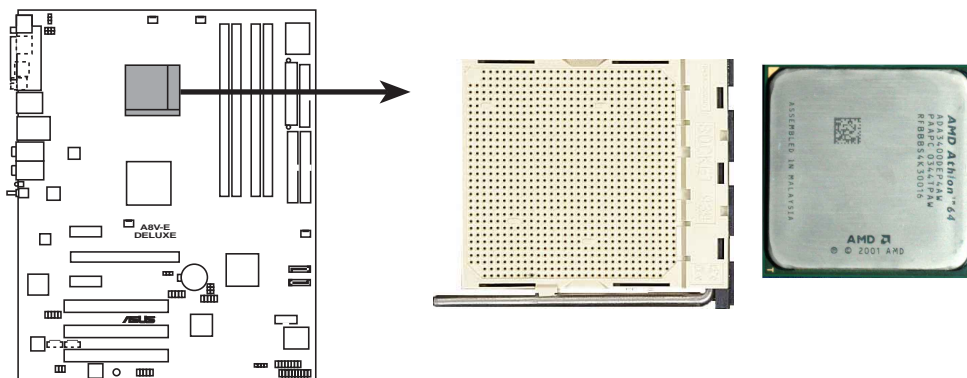

**A8V-E DELUXE CPU Socket 939**



Before installing the CPU, make sure that the socket box is facing towards you and the load lever is on your left.

2. Unlock the socket by pressing the lever sideways, then lift it up to a 90°-100° angle.

Socket Lever



---

Make sure that the socket lever is lifted up to 90°-100° angle, otherwise the CPU does not fit in completely.

---

3. Position the CPU above the socket such that the CPU corner with the gold triangle matches the socket corner with a small triangle.

4. Carefully insert the CPU into the socket until it fits in place.

Gold triangle

Small triangle



---

The CPU fits only in one correct orientation. DO NOT force the CPU into the socket to prevent bending the pins and damaging the CPU!

---

5. When the CPU is in place, push down the socket lever to secure the CPU. The lever clicks on the side tab to indicate that it is locked.

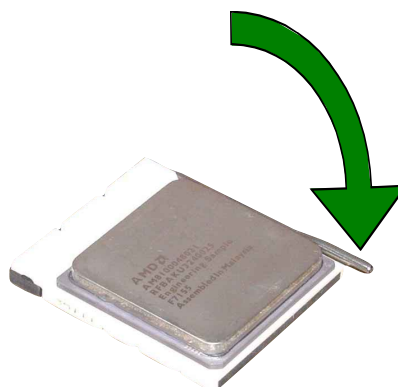

### 2.3.3 Installing the heatsink and fan

The AMD Athlon™ 64FX or AMD Athlon 64™ processor require a specially designed heatsink and fan assembly to ensure optimum thermal condition and performance.

Follow these steps to install the CPU heatsink and fan.

1. Place the heatsink on top of the installed CPU, making sure that the heatsink fits properly on the retention module base.



- The retention module base is already installed on the motherboard upon purchase.
- You do not have to remove the retention module base when installing the CPU or installing other motherboard components.
- If you purchased a separate CPU heatsink and fan assembly, make sure that a Thermal Interface Material is properly applied to the CPU heatsink or CPU before you install the heatsink and fan assembly.

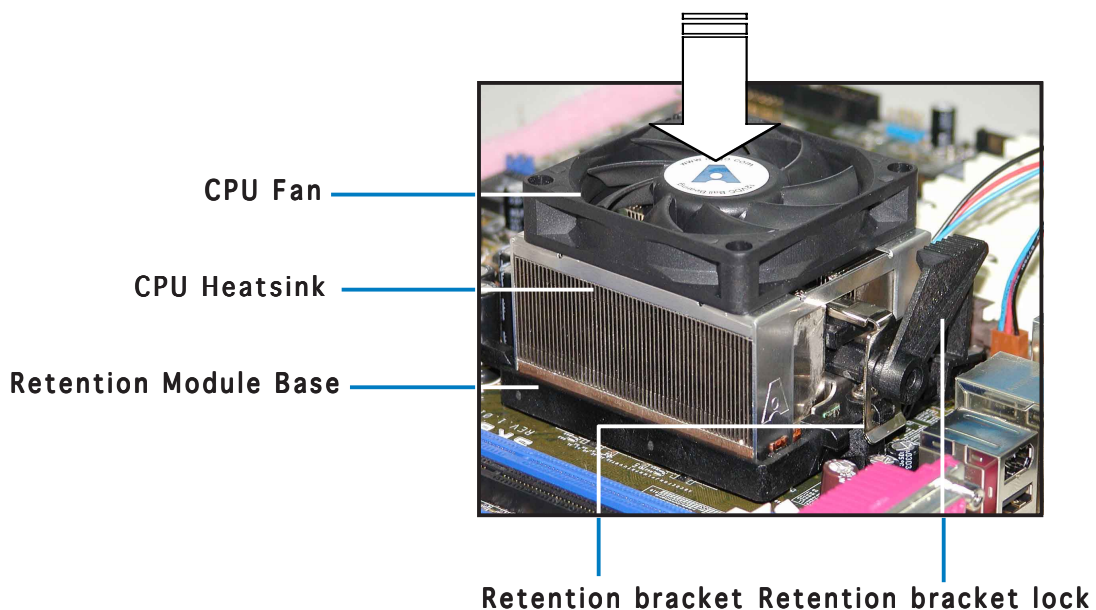

Your boxed CPU heatsink and fan assembly should come with installation instructions for the CPU, heatsink, and the retention mechanism. If the instructions in this section do not match the CPU documentation, follow the latter.



2. Attach one end of the retention bracket to the retention module base.

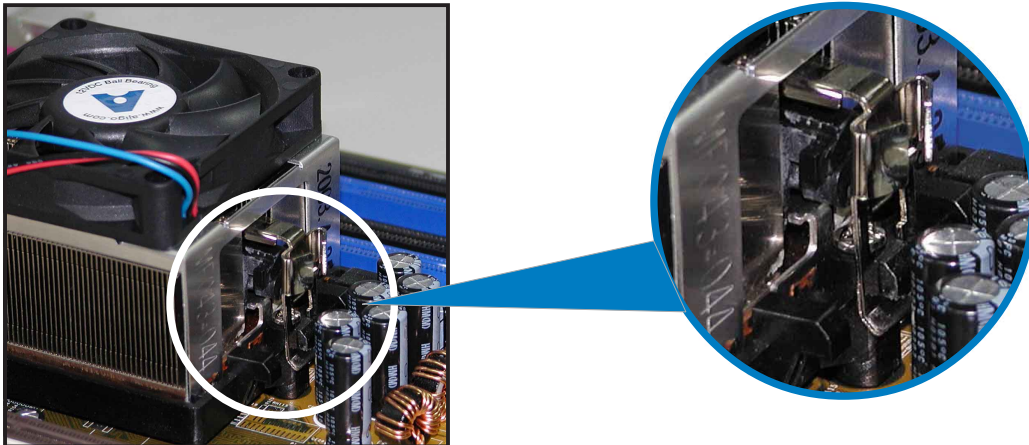

3. Align the other end of the retention bracket (near the retention bracket lock) to the retention module base. A clicking sound denotes that the retention bracket is in place.



---

Make sure that the fan and heatsink assembly perfectly fits the retention mechanism module base, otherwise you cannot snap the retention bracket in place.

---

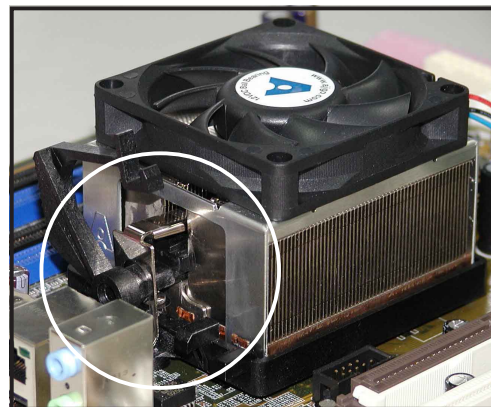

4. Push down the retention bracket lock on the retention mechanism to secure the heatsink and fan to the module base.

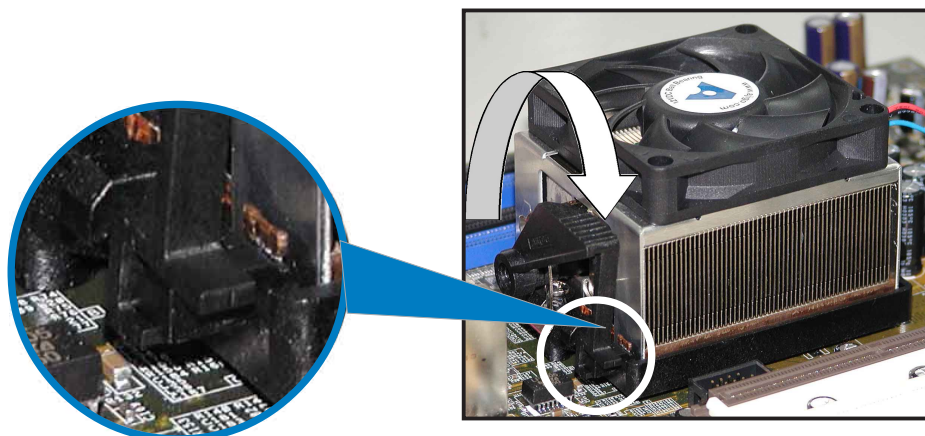

- When the fan and heatsink assembly is in place, connect the CPU fan cable to the connector on the motherboard labeled CPU\_FAN.

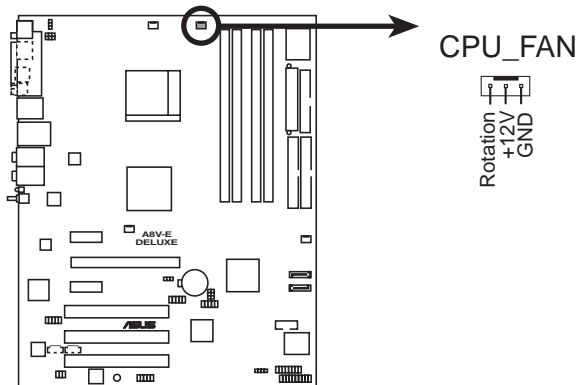

**A8V-E DELUXE CPU\_Fan connector**



Do not forget to connect the CPU fan connector! Hardware monitoring errors can occur if you fail to plug this connector.

## 2.4 System memory

### 2.4.1 Overview

The motherboard comes with four 184-pin Double Data Rate (DDR) Dual Inline Memory Modules (DIMM) sockets.

The following figure illustrates the location of the sockets:

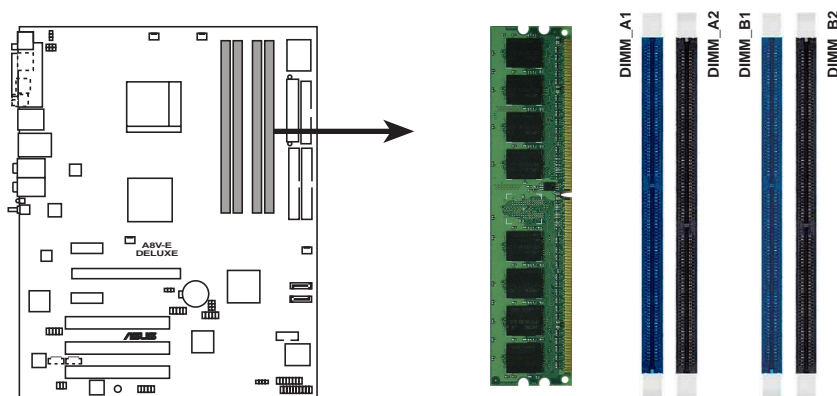

**A8V-E DELUXE 184-pin DDR DIMM sockets**

Channel	Sockets
Channel A	DIMM_A1 and DIMM_A2
Channel B	DIMM_B1 and DIMM_B2

## 2.4.2 Memory Configurations

You may install 256 MB, 512 MB and 1 GB unbuffered ECC or non-ECC DDR DIMMs into the DIMM sockets using the memory configurations in this section.



- For dual-channel configuration, the total size of memory module(s) installed per channel must be the same for better performance (DIMM\_A1+DIMM\_A2=DIMM\_B1+DIMM\_B2).
- Always install DIMMs with the same CAS latency. For optimum compatibility, it is recommended that you obtain memory modules from the same vendor. Refer to the DDR400 Qualified Vendors List on the next page for details.
- Due to chipset resource allocation, the system may detect less than 4 GB of system memory when you installed four 1 GB DDR memory modules.
- Due to chipset limitation, DIMM modules with 128 Mb memory chips or double-sided x16 memory chips are not supported in this motherboard.
- Due to CPU limitation, install on Channel B slots for a single-channel memory configuration.

## DDR400 Qualified Vendors List

Size	Vendor	Model	Brand	Side(s)	Component	DIMM support		
						A	B	C
256MB	KINGSTON	KVR400X64C3A/256	Hynix	SS	HY5DU56822BT-D43	•	•	•
512MB	KINGSTON	KVR400X64C3A/512	Hynix	DS	HY5DU56822BT-D43	•	•	
256MB	KINGSTON	KVR400X72C3A/256	Mosel	SS	V58C2256804SAT5(ECC)			
512MB	KINGSTON	KVR400X72C3A/512	Mosel	DS	V58C2256804SAT5(ECC)	•	•	
256MB	KINGSTON	KVR400X64C3A/256	Infineon	SS	HYB25D256800BT-5B	•	•	•
512MB	KINGSTON	KVR400X64C3A/512	Infineon	DS	HYB25D256809BT-5B	•		
256MB	KINGSTON	KVR400X64C3A/256	KINGSTON	SS	D3208DL2T-5	•	•	•
512MB	KINGSTON	KVR400X64C3A/512	KINGSTON	DS	D328DJB-50	•		
1024MB	KINGSTON	HYB25D512800BE-5B	N/A	DS	KVR400X64C3A/1G	•		
256MB	SAMSUNG	M381L3223ETM-CCC	SAMSUNG	SS	K4H560838E-TCCC(ECC)	•	•	•
512MB	SAMSUNG	M381L6423ETM-CCC	SAMSUNG	DS	K4H560838E-TCCC(ECC)	•	•	•
256MB	SAMSUNG	M368L3223ETM-CCC	SAMSUNG	SS	K4H560838E-TCCC	•	•	•
256MB	SAMSUNG	M368L3223FTN-CCC	SAMSUNG	SS	K4H560838F-TCCC	•	•	•
512MB	SAMSUNG	M368L6423FTN-CCC	SAMSUNG	DS	K4H560838F-TCCC	•	•	
512MB	SAMSUNG	M368L6523BTM-CCC	SAMSUNG	SS	K4H510838B-TCCC	•	•	•
256MB	MICRON	MT8VDDT3264AG-40BCB	MICRON	SS	MT46V32M8TG-5BC	•	•	•
512MB	MICRON	MT16VDDT6464AG-40BCB	MICRON	DS	MT46V32M8TG-5BC	•	•	
256MB	Infineon	HYS64D32300HU-5-C	Infineon	SS	HYB25D256800CE-5C	•	•	•
512MB	Infineon	HYS64D64320HU-5-C	Infineon	DS	HYB25D256800CE-5C	•		
256MB	CORSAIR	CMX256A-3200C2PT	Winbond	SS	W942508BH-5	•		
512MB	CORSAIR	V512MB400	VALUE seLecT	DS	VS32M8-5	•		
1024MB	CORSAIR	TWINX2048-3200C2	N/A	DS	N/A	•		
256MB	Hynix	HYMD232645D8J-D43	Hynix	SS	HY5DU56822DT-D43	•	•	•
512MB	Hynix	HYMD264646D8J-D43	Hynix	DS	HY5DU56822DT-D43	•	•	
256MB	GEIL	GE2563200B	GEIL	SS	GL3LC32G88TG-5A	•	•	•
256MB	GEIL	GD3200-256V	GEIL	SS	GLIL DDR 32M8	•		
512MB	GEIL	GD3200-512V	GEIL	DS	GLIL DDR 32M8	•		

(continued on the next page)

Size	Vendor	Model	Brand	Side(s)	Component	DIMM support		
						A	B	C
256MB	TwinMOS	M2G9I08AIATT9F081AADT	TwinMOS	SS	TMD7608F8E50D	•	•	•
256MB	TwinMOS	M2G9I08A8ATT9F081AADT	TwinMOS	SS	TMD7608F8E50D	•		•
512MB	TwinMOS	M2G9J16A8ATT9F081AADT	TwinMOS	DS	TMD7608F8E50D	•		
256MB	Transcend	TS32MLD64V4F3	SAMSUNG	SS	K4H560838F-TCCC	•	•	•
512MB	Transcend	TS64MLD64V4F3	SAMSUNG	DS	K4H560838F-TCCC	•		
1024MB	Transcend	TS128MLD64V4J	SAMSUNG	DS	K4H510838B-TCCC	•		
512MB	Transcend	TS64MLD64V4F3	Mosel	DS	V58C2256804SAT5B	•		
256MB	Transcend	TS32MLD64V4F3	SAMSUNG	SS	K4H560838E-TCCC	•	•	•
256MB	Apacer	77.10636.33G	Infineon	SS	HYB25D256800CE-5C	•		•
512MB	Apacer	77.10736.33G	Infineon	DS	HYB25D256800CE-5C	•		
256MB	Apacer	77.10639.60G	ProMOS	SS	V58C2256804SCT5B	•		•
512MB	Apacer	77.10739.60G	ProMOS	DS	V58C2256804SCT5B	•		
512MB	A DATA	MDOSS6F3H41Y0N1E0Z	SAMSUNG	DS	K4H560838F-TCCC	•		
256MB	A DATA	MDOHY6F3G31Y0N1E0Z	Hynix	SS	HY5DU56822CT-D43	•	•	•
256MB	A DATA	MDOAD5F3G31Y0D1E02	N/A	SS	ADD8608A8A-5B		•	•
512MB	A DATA	MDOAD5F3H41Y0D1E02	N/A	DS	ADD8608A8A-5B	•		
256MB	Winbond	W9425GCDB-5	Winbond	SS	W942508CH-5			•
512MB	Winbond	W9451GCDB-5	Winbond	DS	W942508CH-5	•		
256MB	KINGMAX	MPXB62D-38KT3R	N/A	SS	KDL388P4LA-50	•		•
512MB	KINGMAX	MPXC22D-38KT3R	N/A	DS	KDL388P4LA-50	•		
512MB	ATP	AG64L64T8SQC4S	SAMSUNG	DS	K4H560838D-TCC4	•		
1024MB	ATP	AG28L64T8SMC4M	MICRON	DS	MT46V64M4TG-5BC	•		
256MB	NANYA	NT256D64S88C0G-5T	N/A	SS	NT5DS32M8CT-5T	•	•	•
512MB	NANYA	NT512D64S88C0G-5T	N/A	DS	NT5DS32M8CT-5T	•		
256MB	BRAIN POWER	B6U808-256M-SAM-400	SAMSUNG	SS	K4H560838D-TCC4	•		
256MB	ProMOS	V826632K24SCTG-D0	N/A	SS	V58C2256804SCT5B	•		•
512MB	ProMOS	V826664K24SCTG-D0	N/A	DS	V58C2256804SCT5B	•		
256MB	Deutron	A8C53T-5B1T	PSC	SS	A2S56D30CTP	•	•	•
512MB	Deutron	AL6D8C53T-5B1T	PSC	DS	A2S56D30CTP	•		
256MB	Novax	96M425653CE-40TB6	CEON	SS	C2S56D30TP-5			•
512MB	Novax	96M451253CE-40TB6	CEON	DS	C2S56D30TP-5	•		

**Side(s):** SS - Single Sided

DS - Double Sided

### DIMM Support:

- A** - supports one module inserted into either slot, in a Single-channel memory configuration.
- B** - supports on pair of modules inserted into either the yellow slots or the black slots as one pair of Dual-channel memory configuration.
- C** - support for 4 modules inserted into the yellow and black slots as two pairs of Dual-channel memory configuration.



Visit the ASUS website ([www.asus.com](http://www.asus.com)) for the latest DDR400 Qualified Vendors List.

## 2.4.3 Installing a DIMM



Make sure to unplug the power supply before adding or removing DIMMs or other system components. Failure to do so may cause severe damage to both the motherboard and the components.

1. Unlock a DIMM socket by pressing the retaining clips outward.
2. Align a DIMM on the socket such that the notch on the DIMM matches the break on the socket.

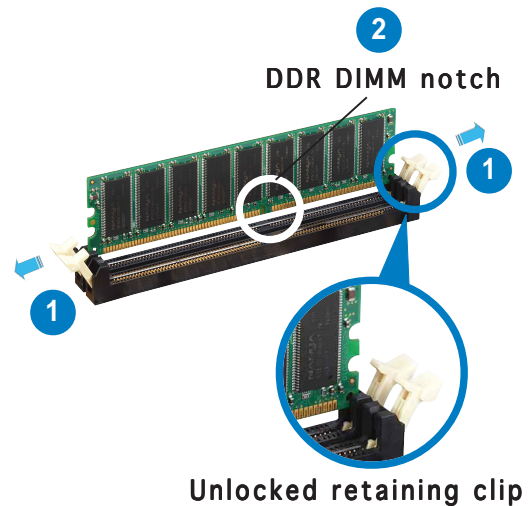

A DDR DIMM is keyed with a notch so that it fits in only one direction. DO NOT force a DIMM into a socket to avoid damaging the DIMM.

3. Firmly insert the DIMM into the socket until the retaining clips snap back in place and the DIMM is properly seated.

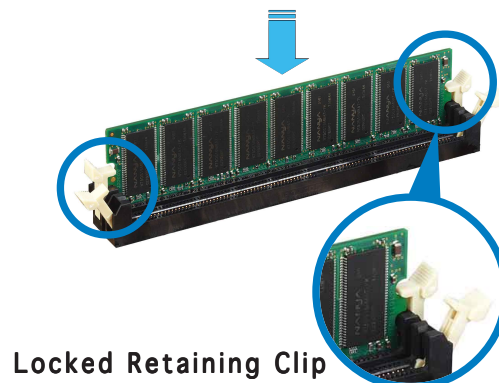

## 2.4.4 Removing a DIMM

Follow these steps to remove a DIMM.

1. Simultaneously press the retaining clips outward to unlock the DIMM.

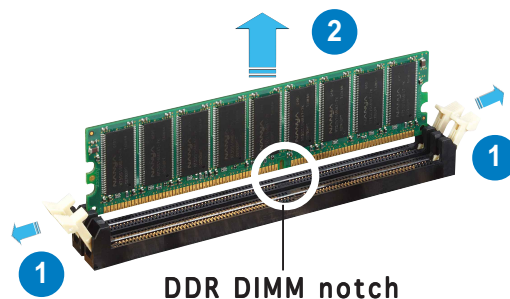

Support the DIMM lightly with your fingers when pressing the retaining clips. The DIMM might get damaged when it flips out with extra force.

2. Remove the DIMM from the socket.

## 2.5 Expansion slots

In the future, you may need to install expansion cards. The following sub-sections describe the slots and the expansion cards that they support.



---

Make sure to unplug the power cord before adding or removing expansion cards. Failure to do so may cause you physical injury and damage motherboard components.

---

### 2.5.1 Installing an expansion card

To install an expansion card:

1. Before installing the expansion card, read the documentation that came with it and make the necessary hardware settings for the card.
2. Remove the system unit cover (if your motherboard is already installed in a chassis).
3. Remove the bracket opposite the slot that you intend to use. Keep the screw for later use.
4. Align the card connector with the slot and press firmly until the card is completely seated on the slot.
5. Secure the card to the chassis with the screw you removed earlier.
6. Replace the system cover.

### 2.5.2 Configuring an expansion card

After installing the expansion card, configure the it by adjusting the software settings.

1. Turn on the system and change the necessary BIOS settings, if any. See Chapter 4 for information on BIOS setup.
2. Assign an IRQ to the card. Refer to the tables on the next page.
3. Install the software drivers for the expansion card.



## 2.5.3 Interrupt assignments

### Standard interrupt assignments

IRQ	Priority	Standard Function
0	1	System Timer
1	2	Keyboard Controller
2	-	Re-direct to IRQ#9
3	11	Communications Port (COM2)*
4	12	Communications Port (COM1)*
5	13	IRQ holder for PCI steering*
6	14	Floppy Disk Controller
7	15	Printer Port (LPT1)*
8	3	System CMOS/Real Time Clock
9	4	IRQ holder for PCI steering*
10	5	IRQ holder for PCI steering*
11	6	IRQ holder for PCI steering*
12	7	PS/2 Compatible Mouse Port*
13	8	Numeric Data Processor
14	9	Primary IDE Channel
15	10	Secondary IDE Channel

\* These IRQs are usually available for ISA or PCI devices.

### IRQ assignments for this motherboard

	A	B	C	D	E	F	G	H
PCI slot 1	shared	—	—	—	—	—	—	—
PCI slot 2	—	shared	—	—	—	—	—	—
PCI slot 3	—	—	shared	—	—	—	—	—
PCI E x1 slot 1	shared	—	—	—	—	—	—	—
PCI E x1 slot 2	shared	—	—	—	—	—	—	—
PCI E x16 slot	shared	—	—	—	—	—	—	—
Onboard USB controller 1	shared	—	—	—	—	—	—	—
Onboard USB controller 2	shared	—	—	—	—	—	—	—
Onboard USB controller 3	—	shared	—	—	—	—	—	—
Onboard USB controller 4	—	shared	—	—	—	—	—	—
Onboard USB 2.0 controller	—	—	shared	—	—	—	—	—
Onboard LAN	shared	—	—	—	—	—	—	—
Onboard wireless LAN	—	shared	—	—	—	—	—	—
Onboard 1394a	shared	—	—	—	—	—	—	—



When using PCI cards on shared slots, ensure that the drivers support “Share IRQ” or that the cards do not need IRQ assignments. Otherwise, conflicts will arise between the two PCI groups, making the system unstable and the card inoperable.

## 2.5.4 PCI slots

The PCI slots support cards such as a LAN card, SCSI card, USB card, and other cards that comply with PCI specifications. The figure shows a LAN card installed on a PCI slot.

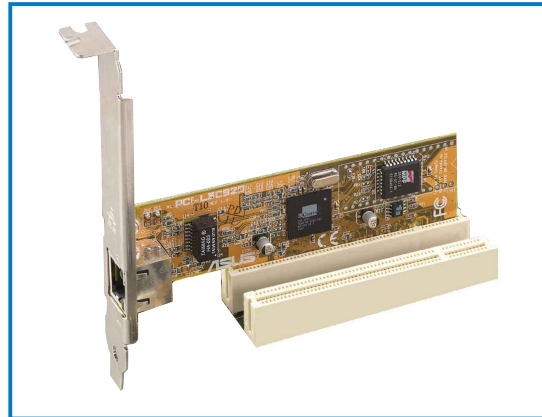

## 2.5.5 PCI Express x16 slot

This motherboard supports PCI Express x16 graphic cards that comply with the PCI Express specifications. The figure shows a graphics card installed on the PCI Express x16 slot.

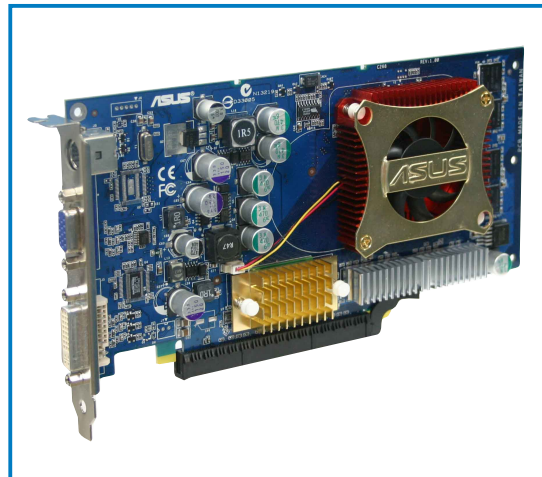

## 2.5.6 PCI Express x1 slot

This motherboard supports PCI Express x1 network cards, SCSI cards and other cards that comply with the PCI Express specifications. The figure shows a network card installed on the PCI Express x1 slot.

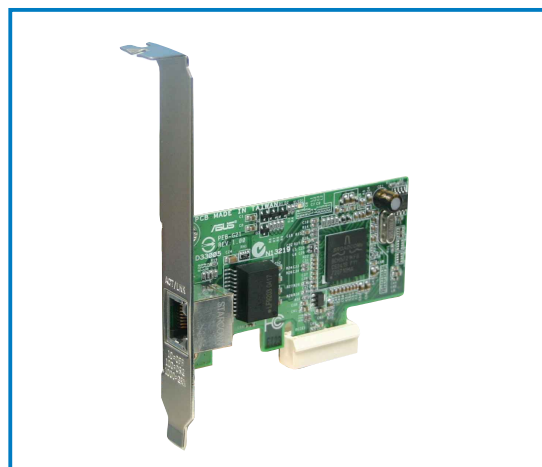



## 2.6 Jumpers

### 1. Clear RTC RAM (CLRTC)

This jumper allows you to clear the Real Time Clock (RTC) RAM in CMOS. You can clear the CMOS memory of date, time, and system setup parameters by erasing the CMOS RTC RAM data. The onboard button cell battery powers the RAM data in CMOS, which include system setup information such as system passwords.

To erase the RTC RAM:

1. Turn OFF the computer and unplug the power cord.
2. Remove the onboard battery.
3. Move the jumper cap from pins 1-2 (default) to pins 2-3. Keep the cap on pins 2-3 for about 5~10 seconds, then move the cap back to pins 1-2.
4. Re-install the battery.
5. Plug the power cord and turn ON the computer.
6. Hold down the <Del> key during the boot process and enter BIOS setup to re-enter data.



Except when clearing the RTC RAM, never remove the cap on CLRTC jumper default position. Removing the cap will cause system boot failure!

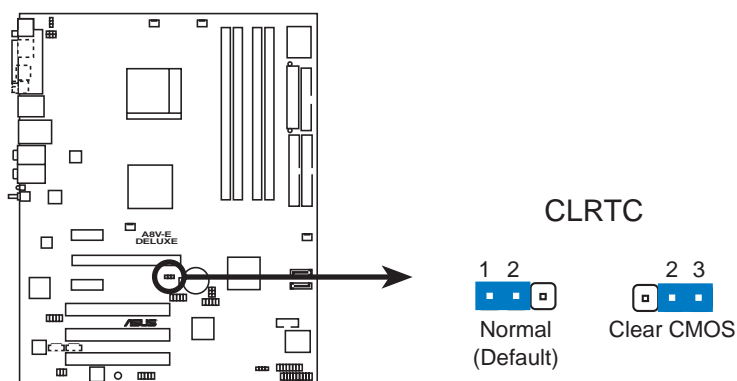

**ASUS A8V-E DELUXE Clear RTC RAM**



You do not need to clear the RTC when the system hangs due to overclocking. For system failure due to overclocking, use the C.P.R. (CPU Parameter Recall) feature. Shut down and reboot the system so the BIOS can automatically reset parameter settings to default values.

## 2. USB device wake-up (3-pin USBPW12, USBPW34, USBPW56, USBPW78)

Set these jumpers to +5V to wake up the computer from S1 sleep mode (CPU stopped, DRAM refreshed, system running in low power mode) using the connected USB devices. Set to +5VSB to wake up from S3 and S4 sleep modes (no power to CPU, DRAM in slow refresh, power supply in reduced power mode).

The USBPWR12 and USBPWR34 jumpers are for the rear USB ports. The USBPWR56 and USBPWR78 jumper is for the internal USB connectors that you can connect to additional USB ports.

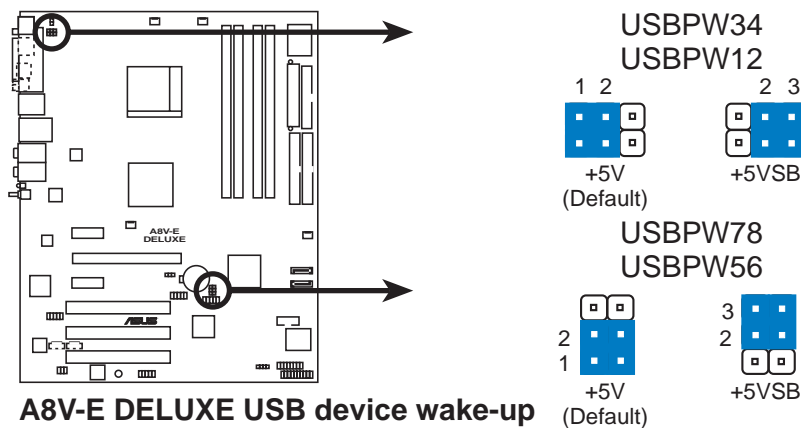

**A8V-E DELUXE USB device wake-up**



- The USB device wake-up feature requires a power supply that can provide 500mA on the +5VSB lead for each USB port; otherwise, the system would not power up.
- The total current consumed must NOT exceed the power supply capability (+5VSB) whether under normal condition or in sleep mode.

### 3. Keyboard power (3-pin KBPWR)

This jumper allows you to enable or disable the keyboard wake-up feature. Set this jumper to pins 2-3 (+5VSB) if you wish to wake up the computer when you press a key on the keyboard (the default is the Space Bar). This feature requires an ATX power supply that can supply at least 1A on the +5VSB lead, and a corresponding setting in the BIOS.

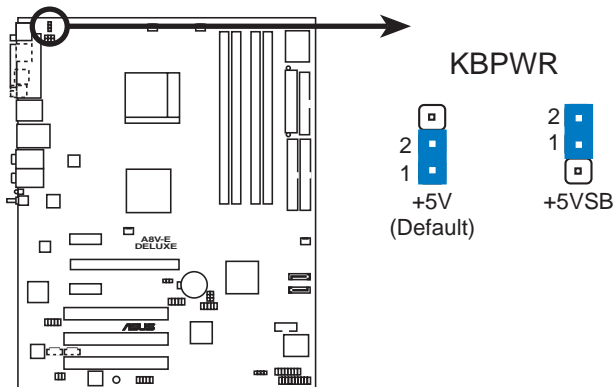

**A8V-E DELUXE Keyboard power setting**

## 2.7 Connectors

### 2.7.1 Rear panel connectors

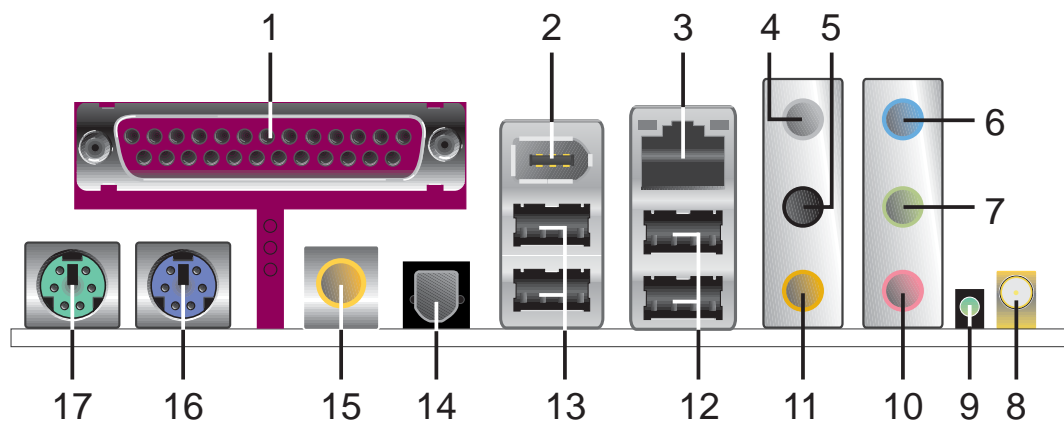

1. **Parallel port.** This 25-pin port connects a parallel printer, a scanner, or other devices.
2. **IEEE 1394a port.** This 6-pin IEEE 1394 port provides high-speed connectivity for audio/video devices, storage peripherals, PCs, or portable devices.
3. **LAN RJ-45 port.** This port allows Gigabit connection to a Local Area Network (LAN) through a network hub. Refer to the table below for the LAN port LED indications.

#### LAN port LED indications

ACT/LINK LED		SPEED LED	
Status	Description	Status	Description
OFF	No link	OFF	10 Mbps connection
GREEN	Linked	ORANGE	100 Mbps connection
BLINKING	Data activity	GREEN	1 Gbps connection

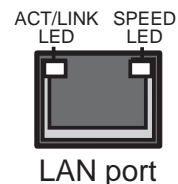

4. **Rear Speaker Out port (gray).** This port connects the rear speakers on a 4-channel, 6-channel, or 8-channel audio configuration.
5. **Side Speaker Out port (black).** This port connects the side speakers in an 8-channel audio configuration.
6. **Line In port (light blue).** This port connects the tape, CD, DVD player, or other audio sources.
7. **Line Out port (lime).** This port connects a headphone or a speaker. In 4-channel, 6-channel, and 8-channel configuration, the function of this port becomes Front Speaker Out.



Refer to the audio configuration table on the next page for the function of the audio ports in 2, 4, 6, or 8-channel configuration.

8. **WiFi-g™ antenna port.** This port connects to the optional dipolar antenna for the onboard ASUS WiFi-g™ solution. (*Wireless Edition only*)
9. **Wireless LAN data transmission LED.** This green **AIR LED** indicates the data transmission status of the onboard wireless LAN adapter. Refer to the table below for the LED indications.

### Wireless LAN LED indications

Status	Indication
<b>On</b>	The onboard WiFi-g™ is on but has no data activity.
<b>Off</b>	The onboard WiFi-g™ card is off.
<b>Flashing</b>	The onboard WiFi-g™ card is transmitting and/or receiving data.

10. **Microphone port (pink).** This port connects a microphone.
11. **Center/Subwoofer port (yellow orange).** This port connects the center/subwoofer speakers.

### Audio 2, 4, 6, or 8-channel configuration

Port	Headset 2-channel	4-channel	6-channel	8-channel
Light Blue	Line In	Line In	Line In	Line In
Lime	Line Out	Front Speaker Out	Front Speaker Out	Front Speaker Out
Pink	Mic In	Mic In	Mic In	Mic In
Gray	•	Rear Speaker Out	Rear Speaker Out	Rear Speaker Out
Black	•	•	•	Side Speaker Out
Yellow Orange	•	•	Center/Subwoofer	Center/Subwoofer

12. **USB 2.0 ports 3 and 4.** These two 4-pin Universal Serial Bus (USB) ports are available for connecting USB 2.0 devices.
13. **USB 2.0 ports 1 and 2.** These two 4-pin Universal Serial Bus (USB) ports are available for connecting USB 2.0 devices.
14. **Optical S/PDIF Out port.** This port connects an external audio output device via an optical S/PDIF cable.
15. **Coaxial S/PDIF Out port.** This port connects an external audio output device via a coaxial S/PDIF cable.
16. **PS/2 keyboard port (purple).** This port is for a PS/2 keyboard.
17. **PS/2 mouse port (green).** This port is for a PS/2 mouse.

## 2.7.2 Internal connectors

### 1. Floppy disk drive connector (34-1 pin FLOPPY)

This connector is for the provided floppy disk drive (FDD) signal cable. Insert one end of the cable to this connector, then connect the other end to the signal connector at the back of the floppy disk drive.



The Pin 5 on the connector is removed to prevent incorrect cable connection when using an FDD cable with a covered Pin 5.

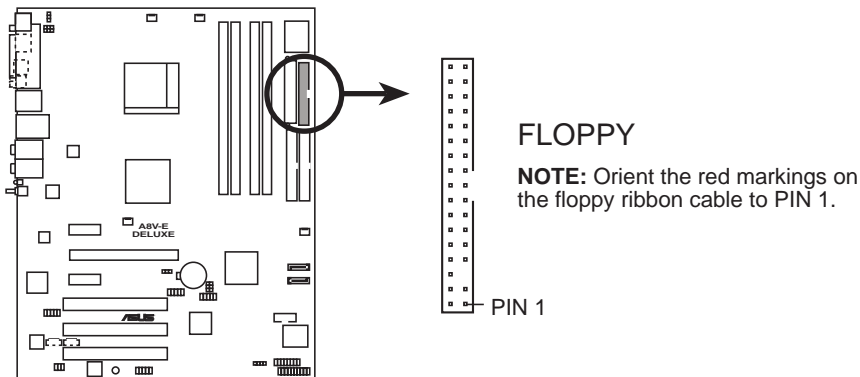

**A8V-E DELUXE Floppy disk drive connector**

### 2. IDE connectors (40-1 pin PRI\_IDE, SEC\_IDE)

These connectors are for Ultra DMA 133/100/66 signal cables. The Ultra DMA 133/100/66 signal cable has three connectors: a blue connector for the primary IDE connector on the motherboard, a black connector for an Ultra DMA 133/100/66 IDE slave device (optical drive/hard disk drive), and a gray connector for an Ultra DMA 133/100/66 IDE master device (hard disk drive). If you install two hard disk drives, you must configure the second drive as a slave device by setting its jumper accordingly. Refer to the hard disk documentation for the jumper settings.



- The Pin 20 on the IDE connector is removed to match the covered hole on the Ultra DMA cable connector. This prevents incorrect insertion when you connect the IDE cable.
- Use the 80-conductor IDE cable for Ultra DMA 100/66 IDE devices.

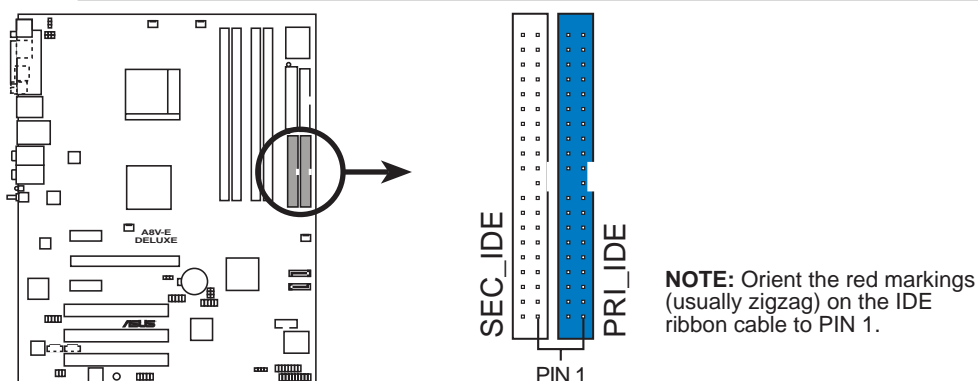

**A8V-E DELUXE IDE connectors**

### 3. Serial ATA connectors (7-pin SATA1, SATA2)

These connectors are for the Serial ATA signal cables for Serial ATA hard disk drives.

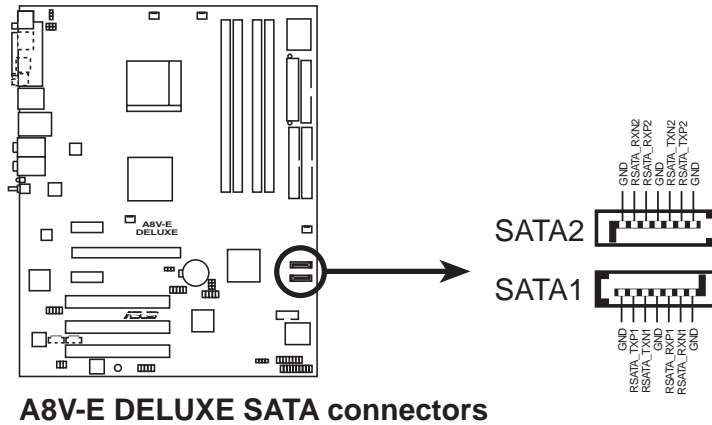

---

#### Important notes on Serial ATA

- The Serial ATA RAID feature (RAID 0, RAID 1) is available only if you are using Windows® 2000/XP.
  - Install the Windows® 2000 Service Pack 4 or the Windows® XP Service Pack1 when using Serial ATA.
-

#### 4. CPU, Chassis, and Power fan connectors (3-pin CPU\_FAN, 3-pin CHA\_FAN1, 3-pin CHIP\_FAN, CHA\_FAN2)

The fan connectors support cooling fans of 350mA~2000mA (24 W max.) or a total of 1A~3.48A (41.76 W max.) at +12V. Connect the fan cables to the fan connectors on the motherboard, making sure that the black wire of each cable matches the ground pin of the connector.



- Do not forget to connect the fan cables to the fan connectors. Lack of sufficient air flow inside the system may damage the motherboard components. These are not jumpers! DO NOT place jumper caps on the fan connectors!
- The ASUS Q-Fan2 function is supported using the CPU Fan (CPU\_FAN) and Chassis Fan 1 (CHA\_FAN1) connectors only.

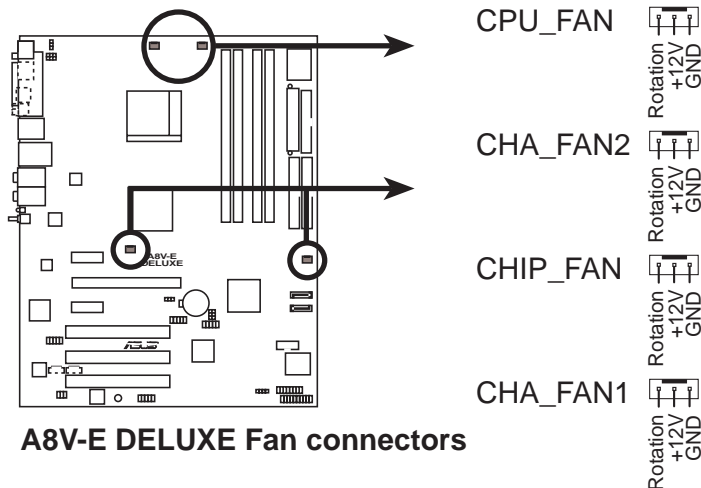



## 5. Serial port connector (10-1 pin COM1)

This connector is for a serial (COM) port. Connect the serial port module cable to this connector, then install the module to a slot opening at the back of the system chassis.

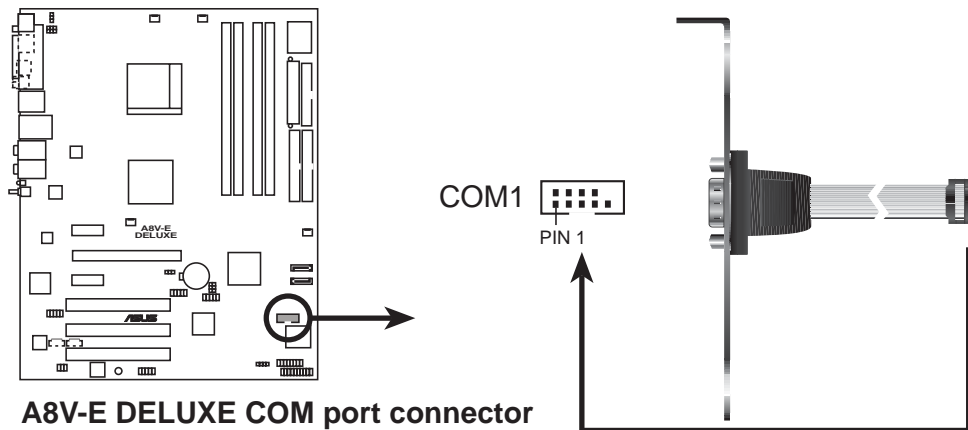

## 6. USB connectors (10-1 pin USB56, USB78)

These connectors are for USB 2.0 ports. Connect the USB/GAME module cable to any of these connectors, then install the module to a slot opening at the back of the system chassis. These USB connectors comply with USB 2.0 specification that supports up to 480 Mbps connection speed.

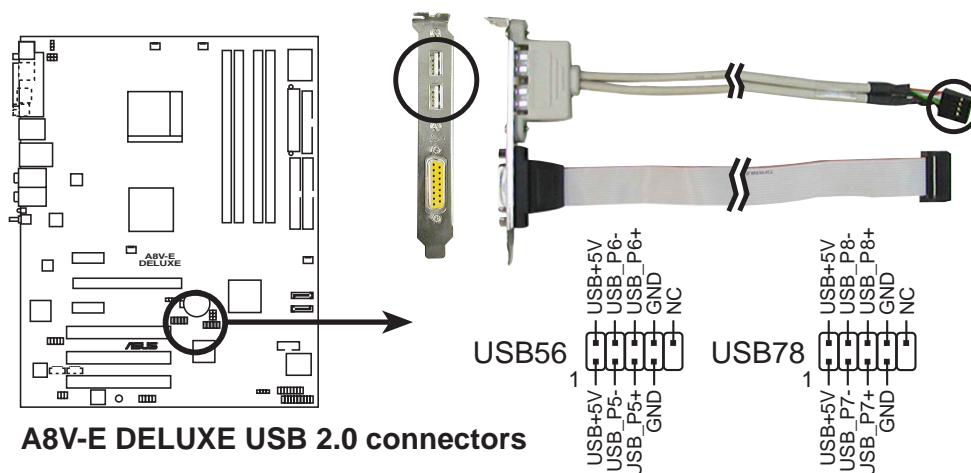

Never connect a **1394 cable** to the USB connectors. Doing so will damage the motherboard!

## 7. ATX power connectors (24-pin EATXPWR, 4-pin ATX12V)

These connectors are for an ATX power supply plugs. The power supply plugs are designed to fit these connectors in only one orientation. Find the proper orientation and push down firmly until the connectors completely fit.



- Use of an ATX 12 V Specification 2.0-compliant power supply unit (PSU) that provides a minimum power of 350 W is recommended for a fully-configured system.
- Do not forget to connect the 4-pin ATX +12 V power plug; otherwise, the system will not boot up.
- Use of a PSU with a higher power output is recommended when configuring a system with more power-consuming devices. The system may become unstable or may not boot up if the power is inadequate.
- You must install a PSU with a higher power rating if you intend to install additional devices.

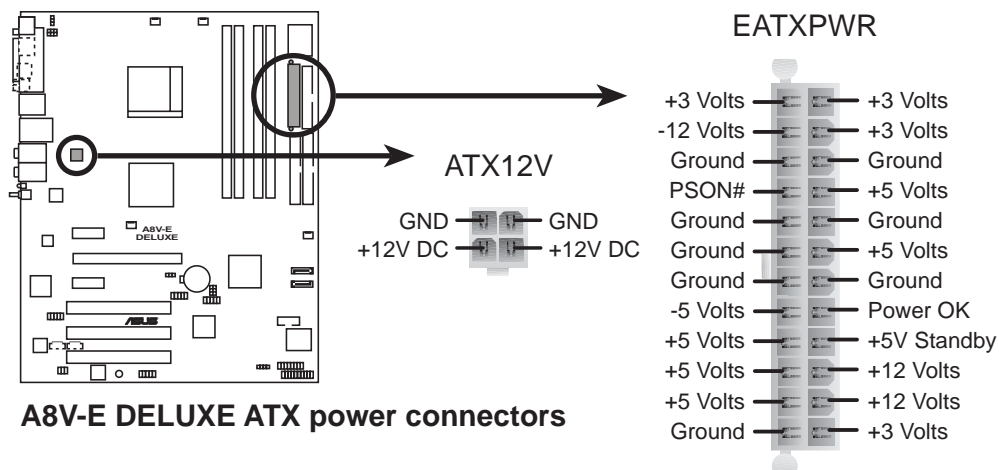

## 8. Internal audio connectors (4-pin CD, AUX)

These connectors allow you to receive stereo audio input from sound sources such as a CD-ROM, TV-tuner, or MPEG card.

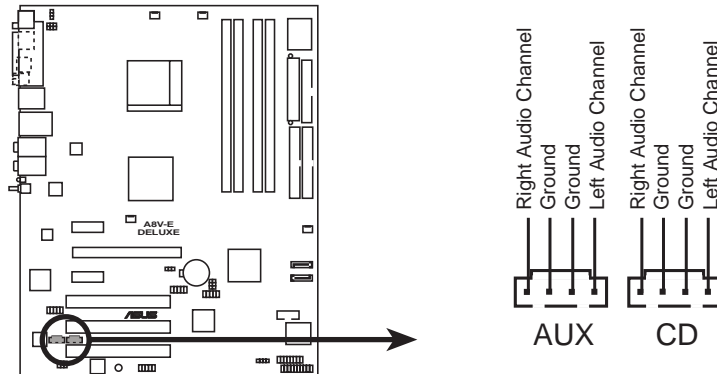

**A8V-E DELUXE Internal audio connectors**

## 9. GAME/MIDI port connector (16-1 pin GAME)

This connector is for a GAME/MIDI port. Connect the USB/GAME module cable to this connector, then install the module to a slot opening at the back of the system chassis. The GAME/MIDI port connects a joystick or game pad for playing games, and MIDI devices for playing or editing audio files.

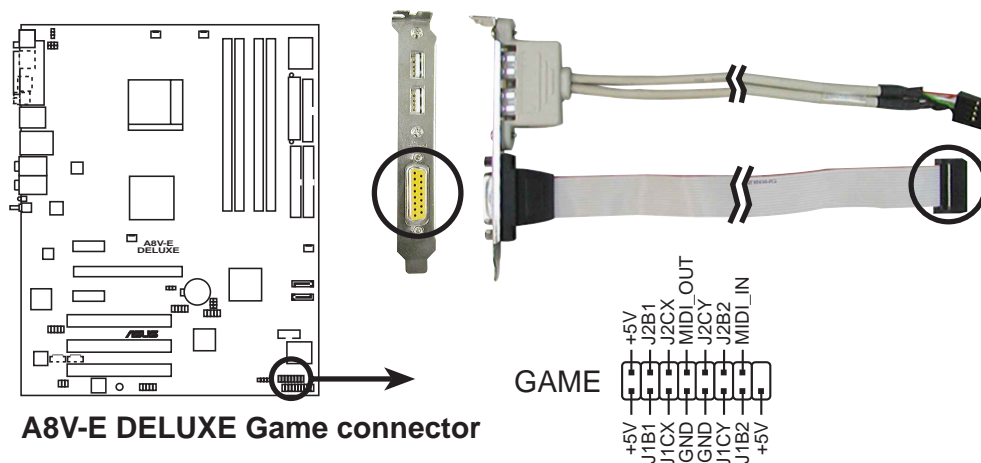

**A8V-E DELUXE Game connector**

## 10. Chassis intrusion connector (4-1 pin CHASSIS)

This connector is for a chassis-mounted intrusion detection sensor or switch. Connect one end of the chassis intrusion sensor or switch cable to this connector. The chassis intrusion sensor or switch sends a high-level signal to this connector when a chassis component is removed or replaced. The signal is then generated as a chassis intrusion event.

By default, the pins labeled “Chassis Signal” and “Ground” are shorted with a jumper cap. Remove the jumper caps only when you intend to use the chassis intrusion detection feature.

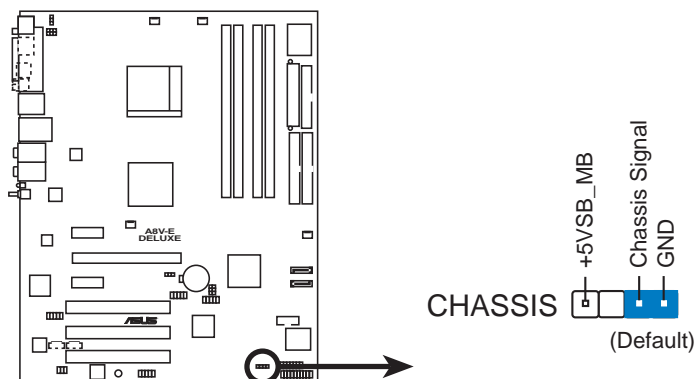

**A8V-E DELUXE Chassis alarm lead**

## 11. IEEE 1394 connector (10-1 pin IE1394\_2)

These connectors are for IEEE 1394a ports. Connect the IEEE 1394 module cable to this connector, then install the module to a slot opening at the back of the system chassis.

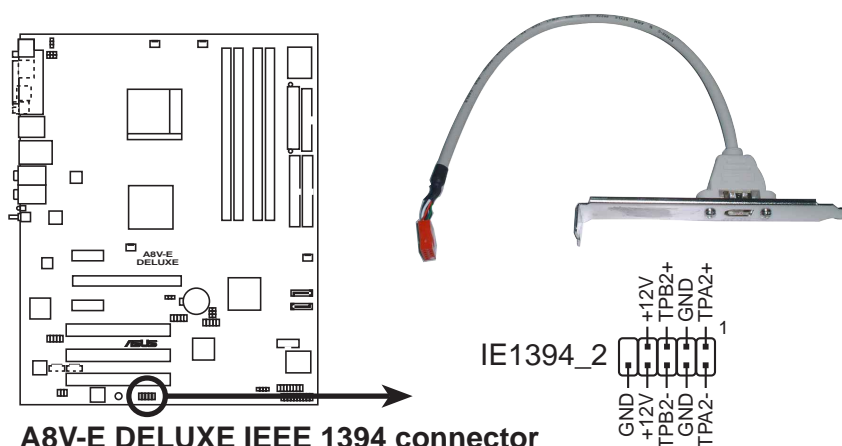

**A8V-E DELUXE IEEE 1394 connector**



Never connect a **USB cable** to the IEEE 1394a connectors. Doing so will damage the motherboard!

## 12. Front panel audio connector (10-1 pin FP\_AUDIO)

This connector is for a chassis-mounted front panel audio I/O module that supports legacy AC '97 audio standard. Connect one end of the front panel audio I/O module cable to this connector.

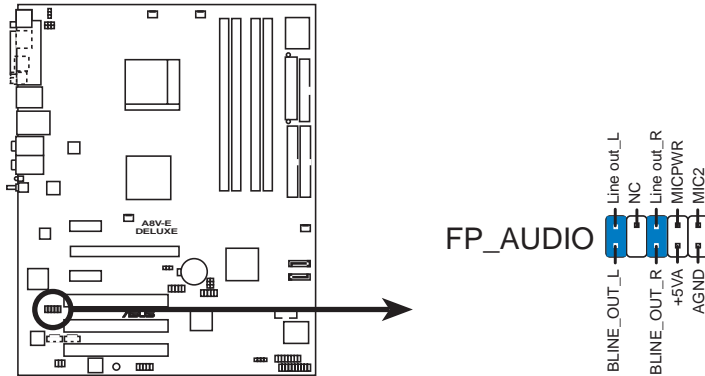

**A8V-E DELUXE Front panel audio connector**

## 13. Digital audio connector (4-1 pin SPDIF)

This connector is for an additional Sony/Philips Digital Interface (S/PDIF) port(s). Connect the S/PDIF module cable to this connector, then install the module to a slot opening at the back of the system chassis.

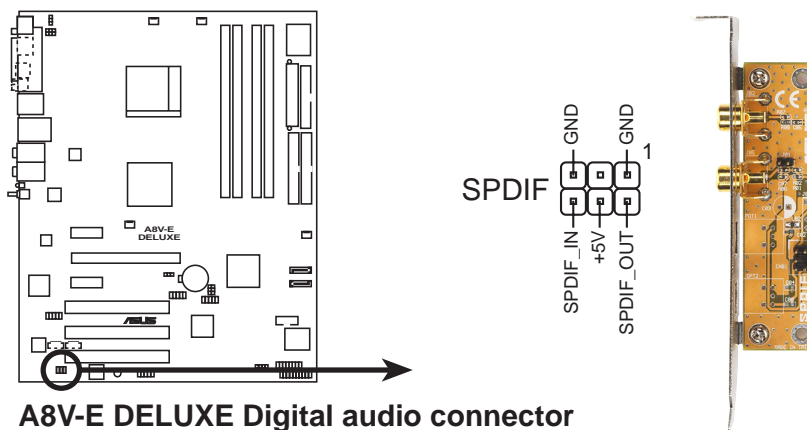

**A8V-E DELUXE Digital audio connector**



The S/PDIF module is purchased separately.

## 14. System panel connector (20-pin PANEL)

This connector supports several chassis-mounted functions.

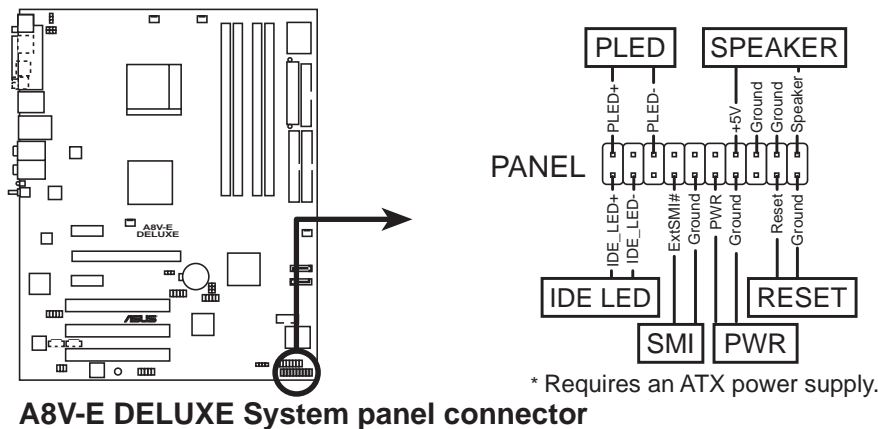

The system panel connector is color-coded for easy connection. Refer to the connector description below for details.

- **System power LED (Green 3-pin PLED)**  
This 3-pin connector is for the system power LED. Connect the chassis power LED cable to this connector. The system power LED lights up when you turn on the system power, and blinks when the system is in sleep mode.
- **System warning speaker (Orange 4-pin SPEAKER)**  
This 4-pin connector is for the chassis-mounted system warning speaker. The speaker allows you to hear system beeps and warnings.
- **Hard disk drive activity (Red 2-pin IDE\_LED)**  
This 2-pin connector is for the HDD Activity LED. Connect the HDD Activity LED cable to this connector. The IDE LED lights up or flashes when data is read from or written to the HDD.
- **Power/Soft-off button (Yellow 2-pin PWR)**  
This connector is for the system power button. Pressing the power button turns the system ON or puts the system in SLEEP or SOFT-OFF mode depending on the BIOS settings. Pressing the power switch for more than four seconds while the system is ON turns the system OFF.
- **Reset button (Blue 2-pin RESET)**  
This 2-pin connector is for the chassis-mounted reset button for system reboot without turning off the system power.

This chapter describes the power up sequence, the vocal POST messages, and ways of shutting down the system.

# Powering up

## Chapter summary

3.1	Starting up for the first time .....	3-1
3.2	Powering off the computer .....	3-2
3.3	ASUS POST Reporter™ .....	3-3



## 3.1 Starting up for the first time

1. After making all the connections, replace the system case cover.
2. Be sure that all switches are off.
3. Connect the power cord to the power connector at the back of the system chassis.
4. Connect the power cord to a power outlet that is equipped with a surge protector.
5. Turn on the devices in the following order:
  - a. Monitor
  - b. External SCSI devices (starting with the last device on the chain)
  - c. System power
6. After applying power, the system power LED on the system front panel case lights up. For systems with ATX power supplies, the system LED lights up when you press the ATX power button. If your monitor complies with “green” standards or if it has a “power standby” feature, the monitor LED may light up or switch between orange and green after the system LED turns on.

The system then runs the power-on self tests or POST. While the tests are running, the BIOS beeps (see BIOS beep codes table below) or additional messages appear on the screen. If you do not see anything within 30 seconds from the time you turned on the power, the system may have failed a power-on test. Check the jumper settings and connections or call your retailer for assistance.
7. At power on, hold down the <Delete> key to enter the BIOS Setup. Follow the instructions in Chapter 4.

## 3.2 Powering off the computer

### 3.2.1 Using the OS shut down function

If you are using Windows® 2000:

1. Click the **Start** button then click **Shut Down...**
2. Make sure that the **Shut Down** option button is selected, then click the **OK** button to shut down the computer.
3. The power supply should turn off after Windows® shuts down.

If you are using Windows® XP:

1. Click the **Start** button then select **Turn Off Computer.**
2. Click the **Turn Off** button to shut down the computer.
3. The power supply should turn off after Windows® shuts down.

### 3.2.2 Using the dual function power switch

While the system is ON, pressing the power switch for less than four seconds puts the system to sleep mode or to soft-off mode, depending on the BIOS setting. Pressing the power switch for more than four seconds lets the system enter the soft-off mode regardless of the BIOS setting. Refer to section “4.5 Power Menu” in Chapter 4 for details.

## 3.3 ASUS POST Reporter™

This motherboard includes the Winbond speech controller to support a special feature called the ASUS POST Reporter™. This feature lets you hear vocal messages during POST that alerts you of system events and boot status. In case of a boot failure, you will hear the specific cause of the problem.

These POST messages are customizable using the Winbond Voice Editor software that came with your package. You can record your own messages to replace the default messages.

### 3.3.1 Vocal POST messages

Following is a list of the default POST messages and the corresponding actions you can take:

POST Message	Action
No CPU installed	<ul style="list-style-type: none"><li>• Install a supported processor to the CPU socket. See section “2.3 Central Processing Unit (CPU)” for details.</li></ul>
System failed CPU test	<ul style="list-style-type: none"><li>• Check the CPU if properly installed.</li><li>• Call ASUS technical support for assistance. See the ASUS contact information on the inside front cover of this user guide.</li></ul>
System failed memory test	<ul style="list-style-type: none"><li>• Install supported DDR2 DIMMs into the memory sockets.</li><li>• Check if the DIMMs on the DIMM sockets are properly installed.</li><li>• Make sure that your DIMMs are not defective.</li><li>• Refer to section “2.4 System memory” for instructions on installing a DIMM.</li></ul>
System failed VGA test	<ul style="list-style-type: none"><li>• Install a PCI graphics card into one of the PCI slots, or a PCI Express AGP card into the PCI Express x16 slot.</li><li>• Make sure that your graphics card is not defective.</li></ul>
System failed due to CPU	<ul style="list-style-type: none"><li>• Check your CPU overclocking settings in the BIOS setup and restore the default CPU parameters.</li></ul>
No keyboard detected	<ul style="list-style-type: none"><li>• Check if your keyboard is properly connected to the purple PS/2 connector on the rear panel.</li><li>• See section “2.7.1 Rear panel connectors” for the location of the connector.</li></ul>
No IDE hard disk detected	<ul style="list-style-type: none"><li>• Make sure you have connected an IDE hard disk drive to one of the IDE connectors on the motherboard.</li></ul>

POST Message	Action
CPU temperature too high	<ul style="list-style-type: none"> <li>• Check if the CPU fan is working properly.</li> </ul>
CPU fan failed	<ul style="list-style-type: none"> <li>• Check the CPU fan and make sure it turns on after you apply power to the system.</li> <li>• Make sure that your CPU fan supports the fan speed detection function.</li> </ul>
CPU voltage out of range	<ul style="list-style-type: none"> <li>• Check your power supply and make sure it is not defective.</li> <li>• Call ASUS technical support for assistance. See the “ASUS contact information” on the inside front cover of this user guide.</li> </ul>
Computer now booting from operating system	<ul style="list-style-type: none"> <li>• No action required</li> </ul>



You can enable or disable the ASUS POST Reporter™ in the **Speech Configuration** option in the BIOS setup. See section 4.4.9 for details.

### 3.3.2 Winbond Voice Editor

The Winbond Voice Editor software allows you to customize the vocal POST messages. You can install this application from the support CD.



To avoid conflicts, do not run the Winbond Voice Editor while running the ASUS PC Probe application.

#### Launching the Voice Editor

You can launch the program from the Windows® desktop by clicking **Start > All Programs > Winbond Voice Editor > Voice Editor**.

The Winbond Voice Editor screen appears.

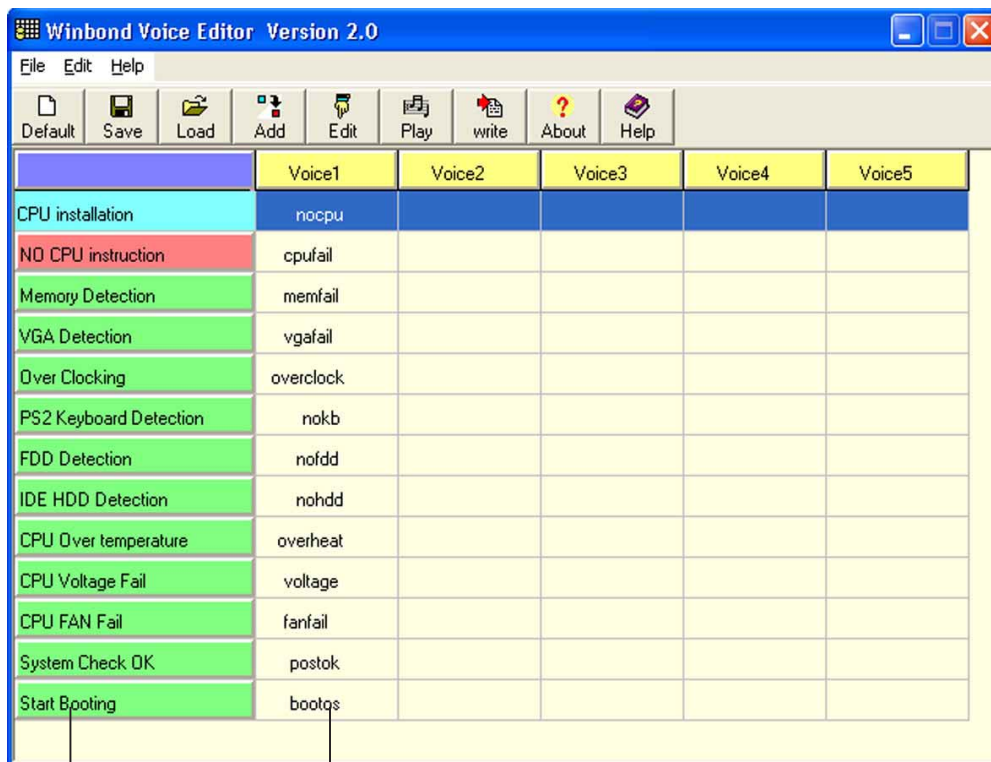

**POST Events    Default Messages**

#### Playing the default wave files

To play the default wave files, simply click on a POST event on the left side of the screen, then click the Play button.



The default language setting is English.

## Changing the default language

To change the default language:

1. Click the **Load** button from the Voice Editor main window. A window with the available languages appears.

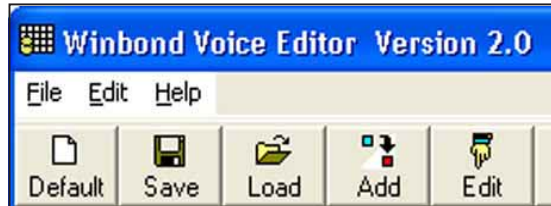

2. Select your desired language, then click **Open**.

The event messages for the language you selected appear on the Voice Editor main window.

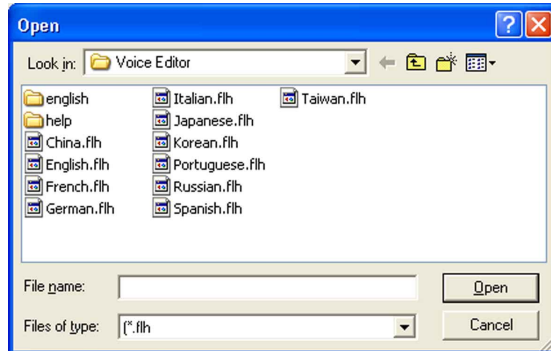

Not all events on some languages have a corresponding message due to file size constraints.

3. Click the **Write** button from the Voice Editor main window to update the EEPROM.
4. Click **Yes** to confirm.

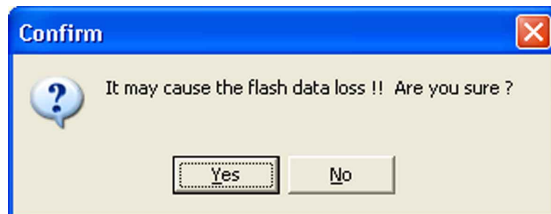

The next time you boot your computer, the ASUS Post Reporter announces the messages in the selected language.

## Customizing your POST messages

The Voice Editor application allows you to record your own POST messages if your language is not supported or if you wish to replace the pre-installed wave files.

To customize your POST messages.

1. Launch the Voice Editor application and note the list of POST events on the leftmost column of the screen.
2. Prepare your message for each event.
3. Use a recording software (e.g. Windows® Recorder) to record your messages, then save the messages as wave files (.WAV).



- The total compressed size for all the wave files must not exceed 1Mbit, so keep your messages as short as possible.
- To keep file sizes small, save your files at a low quality. For example, use 8-bit, mono quality at 22Khz sampling rate.
- Create a separate folder for your wave files so you can locate them easily.

4. From the Voice Editor screen, click the **Add** button to display the **Add Wave File** window.
5. Copy the wave files that you recorded to the database, then close the window when done.

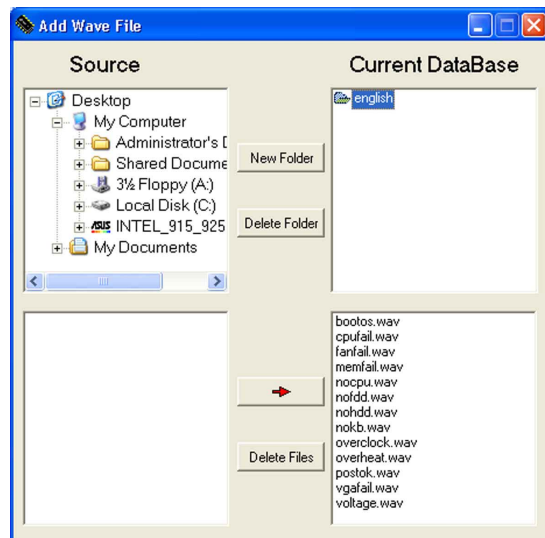

6. Select a POST event on the Voice Editor main window, then click the **Edit** button. The **Event Sound Editor** window appears.
7. Locate and select your wave file for the event, then click on the arrow opposite Voice1. The file you select appears on the space next to it.
8. Click **OK** to return to the Voice Editor main window.
9. Do steps 6 to 8 for the other events.

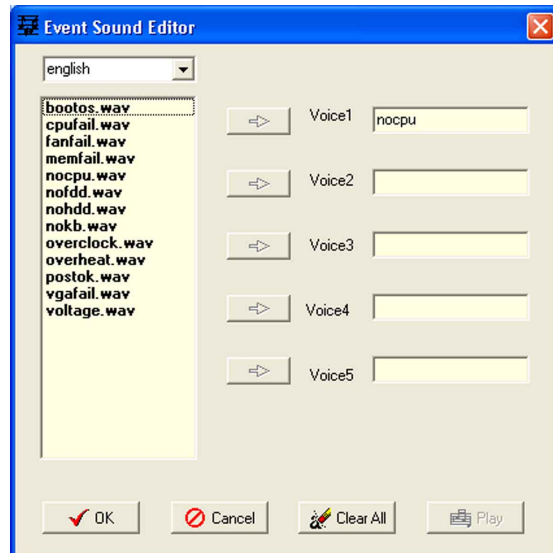

10. When done, click **Save**. A window appears prompting you to save your configuration.
11. Type a file name with an **.flh** extension, then click Save.

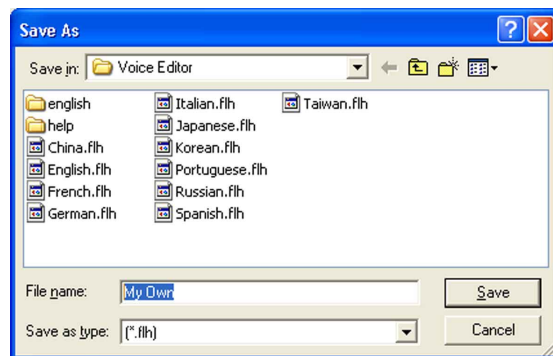

12. Click the **Write** button to compress the file and copy into the EEPROM.
13. Click **Yes** on the confirmation window that appears.

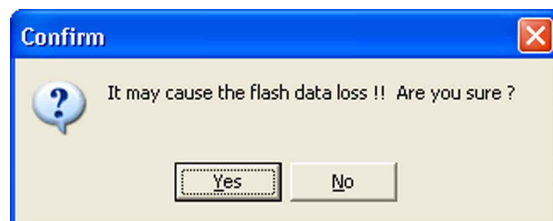

If you receive an error message telling you that the files exceed the total allowable size, do any or all of the following:

- Shorten your messages.
- Save the wave files at a lower quality
- Do not include seldom-used events like FDD Detection, IDE HDD Detection, etc.



This chapter tells how to change the system settings through the BIOS Setup menus. Detailed descriptions of the BIOS parameters are also provided.

# BIOS setup

## Chapter summary

4.1	Managing and updating your BIOS .....	4-1
4.2	BIOS setup program .....	4-11
4.3	Main menu .....	4-15
4.4	Advanced menu .....	4-18
4.5	Power menu .....	4-33
4.6	Boot menu .....	4-37
4.7	Exit menu .....	4-44

## 4.1 Managing and updating your BIOS

The following utilities allow you to manage and update the motherboard Basic Input/Output System (BIOS) setup.

1. **AwardBIOS Flash Utility** (Updates the BIOS in DOS mode using a bootable floppy disk.)
2. **ASUS CrashFree BIOS 2** (Updates the BIOS using a bootable floppy disk or the motherboard support CD when the BIOS file fails or gets corrupted.)
3. **ASUS EZ Flash** (Updates the BIOS in DOS using a floppy disk or the motherboard support CD.)
4. **ASUS Update** (Updates the BIOS in Windows® environment.)

Refer to the corresponding sections for details on these utilities.



---

Save a copy of the original motherboard BIOS file to a bootable floppy disk in case you need to restore the BIOS in the future. Copy the original motherboard BIOS using the ASUS Update or AwardBIOS Flash utilities.

---

### 4.1.1 Creating a bootable floppy disk

1. Do either one of the following to create a bootable floppy disk.

#### DOS environment

- a. Insert a 1.44MB floppy disk into the drive.
- b. At the DOS prompt, type `format A:/S` then press <Enter>.

#### Windows® XP environment

- a. Insert a 1.44 MB floppy disk to the floppy disk drive.
- b. Click **Start** from the Windows® desktop, then select **My Computer**.
- c. Select the 3 1/2 Floppy Drive icon.
- d. Click **File** from the menu, then select **Format**. A **Format 3 1/2 Floppy Disk** window appears.
- e. Select **Create an MS-DOS startup disk** from the format options field, then click **Start**.

#### Windows® 2000 environment

To create a set of boot disks for Windows® 2000:

- a. Insert a formatted, high density 1.44 MB floppy disk into the drive.
- b. Insert the Windows® 2000 CD to the optical drive.

- c. Click **Start**, then select **Run**.
  - d. From the Open field, type  
`D:\bootdisk\makeboot a:`  
assuming that D: is your optical drive.
  - e. Press <Enter>, then follow screen instructions to continue.
2. Copy the original or the latest motherboard BIOS file to the bootable floppy disk.

## 4.1.2 Updating the BIOS

The Basic Input/Output System (BIOS) can be updated using the AwardBIOS Flash Utility. Follow these instructions to update the BIOS using this utility.

1. Download the latest BIOS file from the ASUS web site. Rename the file to **A8V-E.BIN** and save it to a floppy disk.



---

Save only the updated BIOS file in the floppy disk to avoid loading the wrong BIOS file.

---

2. Copy the AwardBIOS Flash Utility (awdfash.exe) from the Software folder of the support CD to the floppy disk with the latest BIOS file.
3. Boot the system in DOS mode using the bootable floppy disk you created earlier.
4. When the **A:>** appears, replace the bootable floppy disk with the floppy disk containing the new BIOS file and the Award BIOS Flash Utility.
5. At the prompt, type **awdfash** then press <Enter>. The Award BIOS Flash Utility screen appears.

```
AwardBIOS Flash Utility for ASUS V1.01
(C) Phoenix Technologies Ltd. All Rights Reserved

For K8T890-8237-A8V-E-00      DATE: 09/10/2004
Flash Type - PMC Pm49FL004T LPC/FWH

File Name to Program: 

Message: Please input File Name!
```



### 4.1.3 Saving the current BIOS file

You can use the AwardBIOS Flash Utility to save the current BIOS file. You can load the current BIOS file when the BIOS file gets corrupted during the flashing process.

To save the current BIOS file using the AwardBIOS Flash Utility:

1. Follow steps 1 to 6 of the previous section.

2. Press <Y> when the utility prompts you to save the current BIOS file. The following screen appears.

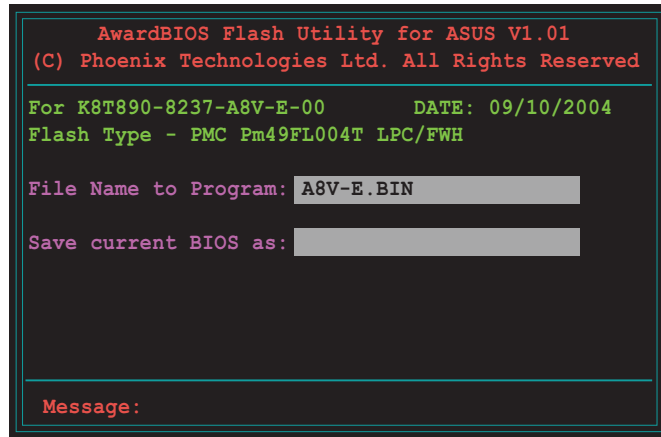

```
AwardBIOS Flash Utility for ASUS V1.01
(C) Phoenix Technologies Ltd. All Rights Reserved

For K8T890-8237-A8V-E-00      DATE: 09/10/2004
Flash Type - PMC Pm49FL004T LPC/FWH

File Name to Program: A8V-E.BIN
Save current BIOS as:

Message:
```

3. Type a filename for the current BIOS file in the **Save current BIOS as** field, then press <Enter>.

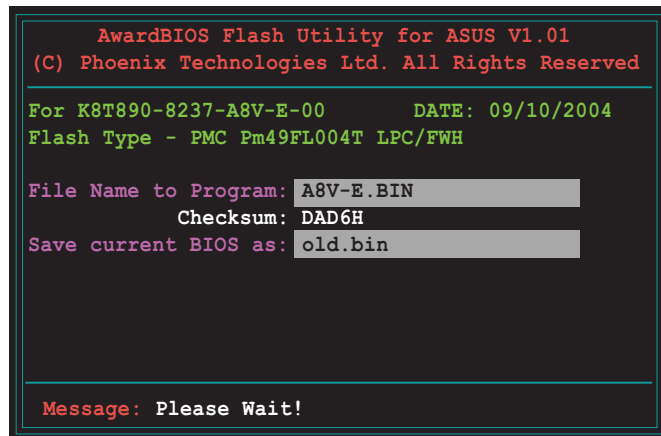

```
AwardBIOS Flash Utility for ASUS V1.01
(C) Phoenix Technologies Ltd. All Rights Reserved

For K8T890-8237-A8V-E-00      DATE: 09/10/2004
Flash Type - PMC Pm49FL004T LPC/FWH

File Name to Program: A8V-E.BIN
Checksum: DAD6H
Save current BIOS as: old.bin

Message: Please Wait!
```

4. The utility saves the current BIOS file to the floppy disk, then returns to the BIOS flashing process.

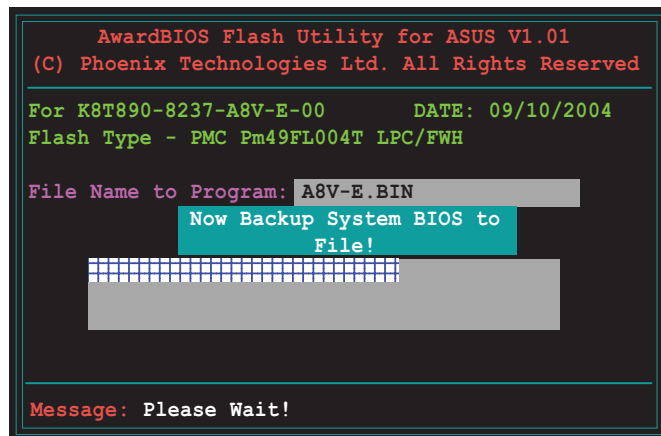

```
AwardBIOS Flash Utility for ASUS V1.01
(C) Phoenix Technologies Ltd. All Rights Reserved

For K8T890-8237-A8V-E-00      DATE: 09/10/2004
Flash Type - PMC Pm49FL004T LPC/FWH

File Name to Program: A8V-E.BIN
Now Backup System BIOS to
File!
Message: Please Wait!
```

## 4.1.4 ASUS CrashFree BIOS 2 utility

The ASUS CrashFree BIOS 2 is an auto recovery tool that allows you to restore the BIOS file when it fails or gets corrupted during the updating process. You can update a corrupted BIOS file using the motherboard support CD or the floppy disk that contains the updated BIOS file.



---

Prepare the motherboard support CD or the floppy disk containing the updated motherboard BIOS before using this utility.

---

### Recovering the BIOS from the support CD

To recover the BIOS from the support CD:

1. Turn on the system.
2. Insert the motherboard support CD to the optical drive.
3. The utility displays the following message and automatically checks the CD for the BIOS file.

```
Award BootBlock BIOS v1.0
Copyright (c) 2000, Award Software, Inc.

BIOS ROM checksum error
Detecting IDE ATAPI device...
```

When found, the utility reads the BIOS file and starts flashing the corrupted BIOS file.

```
Award BootBlock BIOS v1.0
Copyright (c) 2000, Award Software, Inc.

BIOS ROM checksum error
Detecting IDE ATAPI device...
Found CDROM, try to Boot from it... Pass
```



---

**DO NOT** shut down or reset the system while updating the BIOS! Doing so can cause system boot failure!

---

4. Restart the system after the utility completes the updating process.

## Recovering the BIOS from a floppy disk

To recover the BIOS from the support CD:

1. Remove any CD from the optical drive, then turn on the system.
2. Insert the floppy disk with the original or updated BIOS file to the floppy disk drive.
3. The utility displays the following message and automatically checks the floppy disk for the original or updated BIOS file.

```
Award BootBlock BIOS v1.0
Copyright (c) 2000, Award Software, Inc.

BIOS ROM checksum error
Detecting IDE ATAPI device...
```

When no CD is found, the utility automatically checks the floppy drive for the original or updated BIOS file. The utility then updates the corrupted BIOS file.

```
Award BootBlock BIOS v1.0
Copyright (c) 2000, Award Software, Inc.

BIOS ROM checksum error
Detecting IDE ATAPI device...
  Found CDROM, try to Boot from it... Fail

Detecting floppy drive A media...
```



---

DO NOT shut down or reset the system while updating the BIOS! Doing so can cause system boot failure!

---

4. Restart the system after the utility completes the updating process.



---

The recovered BIOS may not be the latest BIOS version for this motherboard. Visit the ASUS website ([www.asus.com](http://www.asus.com)) to download the latest BIOS file.

---



## 4.1.5 ASUS EZ Flash utility

The ASUS EZ Flash feature allows you to update the BIOS without having to go through the long process of booting from a floppy disk and using a DOS-based utility. The EZ Flash utility is built-in the BIOS chip so it is accessible by pressing <Alt> + <F2> during the Power-On Self Tests (POST).

To update the BIOS using EZ Flash:

1. Visit the ASUS website ([www.asus.com](http://www.asus.com)) to download the latest BIOS file for the motherboard.
2. Save the BIOS file to a floppy disk, then restart the system.
3. Press <Alt> + <F2> during POST to display the following.

Insert Disk then press Enter or ESC to continue POST

4. Insert the floppy disk that contains the BIOS file to the floppy disk drive then press <Enter>. The following screen appears.

```
AwardBIOS Flash Utility for ASUS V1.01
(C) Phoenix Technologies Ltd. All Rights Reserved

For NF-KC804-A8N-SLI-00      DATE: 11/18/2004
Flash Type - SST 49LF004A/B /3.3V

File Name to Program: 

Message: Please wait...
```

5. When the correct BIOS file is found, EZ Flash performs the BIOS update process and automatically reboots the system when done.



Do not shutdown or reset the system while updating the BIOS to prevent system boot failure!

## 4.1.6 ASUS Update utility

The ASUS Update is a utility that allows you to manage, save, and update the motherboard BIOS in Windows® environment. The ASUS Update utility allows you to:

- Save the current BIOS file
- Download the latest BIOS file from the Internet
- Update the BIOS from an updated BIOS file
- Update the BIOS directly from the Internet, and
- View the BIOS version information.

This utility is available in the support CD that comes with the motherboard package.



---

ASUS Update requires an Internet connection either through a network or an Internet Service Provider (ISP).

---

## Installing ASUS Update

To install ASUS Update:

1. Place the support CD in the optical drive. The **Drivers** menu appears.
2. Click the **Utilities** tab, then click **Install ASUS Update VX.XX.XX**. See page 5-3 for the **Utilities** screen menu.
3. The ASUS Update utility is copied to your system.



---

Quit all Windows® applications before you update the BIOS using this utility.

---

## Updating the BIOS through the Internet

To update the BIOS through the Internet:

1. Launch the ASUS Update utility from the Windows® desktop by clicking **Start > Programs > ASUS > ASUSUpdate > ASUSUpdate**. The ASUS Update main window appears.

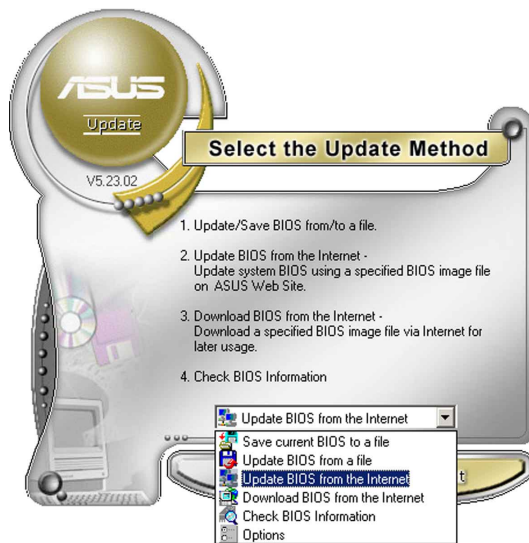
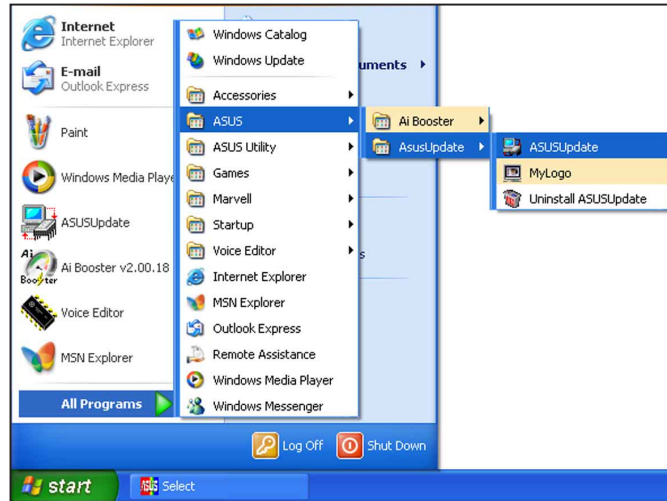

2. Select **Update BIOS from the Internet** option from the drop-down menu, then click **Next**.



3. Select the ASUS FTP site nearest you to avoid network traffic, or click **Auto Select**. Click **Next**.

- From the FTP site, select the BIOS version that you wish to download. Click Next.
- Follow the screen instructions to complete the update process.



The ASUS Update utility is capable of updating itself through the Internet. Always update the utility to avail all its features.



## Updating the BIOS through a BIOS file

To update the BIOS through a BIOS file:

- Launch the ASUS Update utility from the Windows® desktop by clicking **Start > Programs > ASUS > ASUSUpdate > ASUSUpdate**. The ASUS Update main window appears.
- Select **Update BIOS from a file** option from the drop-down menu, then click **Next**.

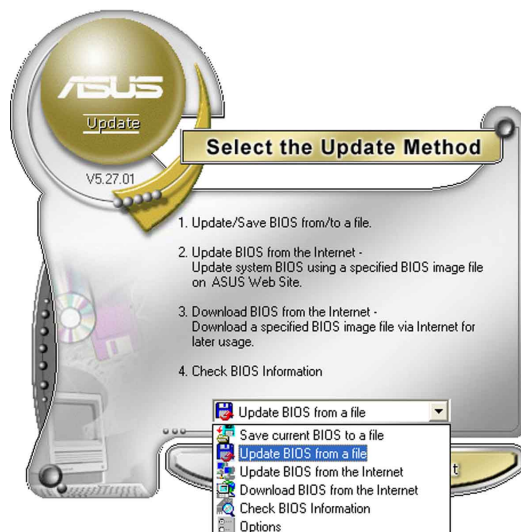

- Locate the BIOS file from the **Open** window, then click **Save**.
- Follow the screen instructions to complete the update process.

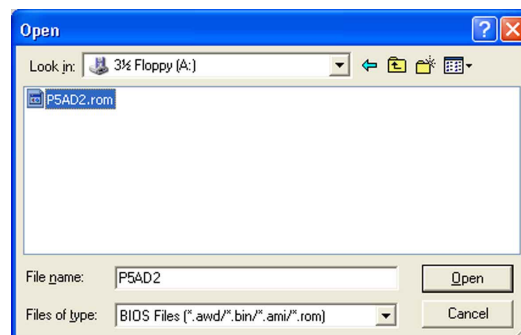

## 4.2 BIOS setup program

This motherboard supports a programmable Low-Pin Count (LPC) chip that you can update using the provided utility described in section “4.1 Managing and updating your BIOS.”

Use the BIOS Setup program when you are installing a motherboard, reconfiguring your system, or prompted to “Run Setup”. This section explains how to configure your system using this utility.

Even if you are not prompted to use the Setup program, you can change the configuration of your computer in the future. For example, you can enable the security password feature or change the power management settings. This requires you to reconfigure your system using the BIOS Setup program so that the computer can recognize these changes and record them in the CMOS RAM of the LPC chip.

The LPC chip on the motherboard stores the Setup utility. When you start up the computer, the system provides you with the opportunity to run this program. Press <Del> during the Power-On Self-Test (POST) to enter the Setup utility; otherwise, POST continues with its test routines.

If you wish to enter Setup after POST, restart the system by pressing <Ctrl+Alt+Delete>, or by pressing the reset button on the system chassis. You can also restart by turning the system off and then back on. Do this last option only if the first two failed.

The Setup program is designed to make it as easy to use as possible. Being a menu-driven program, it lets you scroll through the various sub-menus and make your selections from the available options using the navigation keys.



- 
- The default BIOS settings for this motherboard apply for most conditions to ensure optimum performance. If the system becomes unstable after changing any BIOS settings, load the default settings to ensure system compatibility and stability. Select the **Load Default Settings** item under the Exit Menu. See section “4.7 Exit Menu.”
  - The BIOS setup screens shown in this section are for reference purposes only, and may not exactly match what you see on your screen.
  - Visit the ASUS website ([www.asus.com](http://www.asus.com)) to download the latest BIOS file for this motherboard and .
-

## 4.2.1 BIOS menu screen

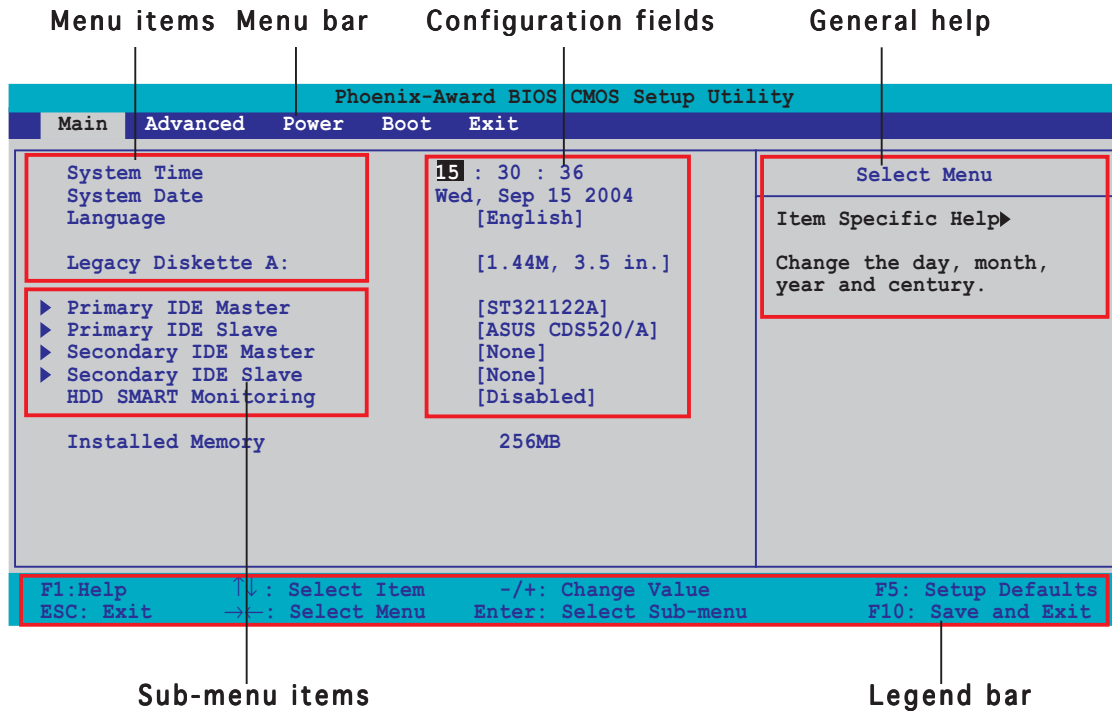

## 4.2.2 Menu bar

The menu bar on top of the screen has the following main items:

- |                 |  |
|-----------------|--|
| <b>Main</b>     | For changing the basic system configuration                    |
| <b>Advanced</b> | For changing the advanced system settings                      |
| <b>Power</b>    | For changing the advanced power management (APM) configuration |
| <b>Boot</b>     | For changing the system boot configuration                     |
| <b>Exit</b>     | For selecting the exit options and loading default settings    |

To select an item on the menu bar, press the right or left arrow key on the keyboard until the desired item is highlighted.



- The BIOS setup screens shown in this chapter are for reference purposes only, and may not exactly match what you see on your screen.
- Visit the ASUS website ([www.asus.com](http://www.asus.com)) to download the latest BIOS information.

### 4.2.3 Legend bar

At the bottom of the Setup screen is a legend bar. The keys in the legend bar allow you to navigate through the various setup menus. The following table lists the keys found in the legend bar with their corresponding functions.

Navigation Key	Function
<F1>	Displays the General Help screen
<F5>	Loads setup default values
<Esc>	Exits the BIOS setup or returns to the main menu from a sub-menu
Left or Right arrow	Selects the menu item to the left or right
Up or Down arrow	Moves the highlight up or down between fields
Page Down or - (minus)	Scrolls backward through the values for the highlighted field
Page Up or + (plus)	Scrolls forward through the values for the highlighted field
<Enter>	Brings up a selection menu for the highlighted field
<F10>	Saves changes and exit

### 4.2.4 Menu items

The highlighted item on the menu bar displays the specific items for that menu. For example, selecting **Main** shows the Main menu items.

The other items (Advanced, Power, Boot, and Exit) on the menu bar have their respective menu items.

### 4.2.5 Sub-menu items

A solid triangle before each item on any menu screen means that the item has a sub-menu. To display the sub-menu, select the item and press <Enter>.

### 4.2.6 Configuration fields

These fields show the values for the menu items. If an item is user-configurable, you can change the value of the field opposite the item. You cannot select an item that is not user-configurable.

A configurable field is enclosed in brackets, and is highlighted when selected. To change the value of a field, select it then press <Enter> to display a list of options. Refer to “4.2.7 Pop-up window.”

## 4.2.7 Pop-up window

Select a menu item then press <Enter> to display a pop-up window with the configuration options for that item.

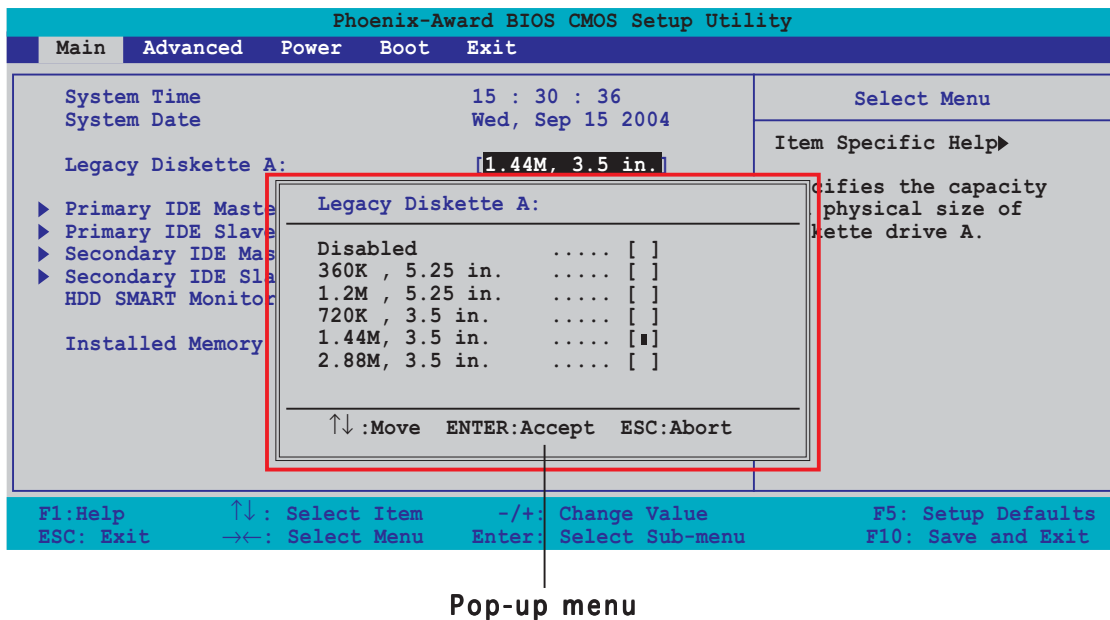

## 4.2.8 General help

At the top right corner of the menu screen is a brief description of the selected item.



## 4.3 Main menu

When you enter the BIOS Setup program, the Main menu screen appears, giving you an overview of the basic system information.



Refer to section “4.2.1 BIOS menu screen” for information on the menu screen items and how to navigate through them.

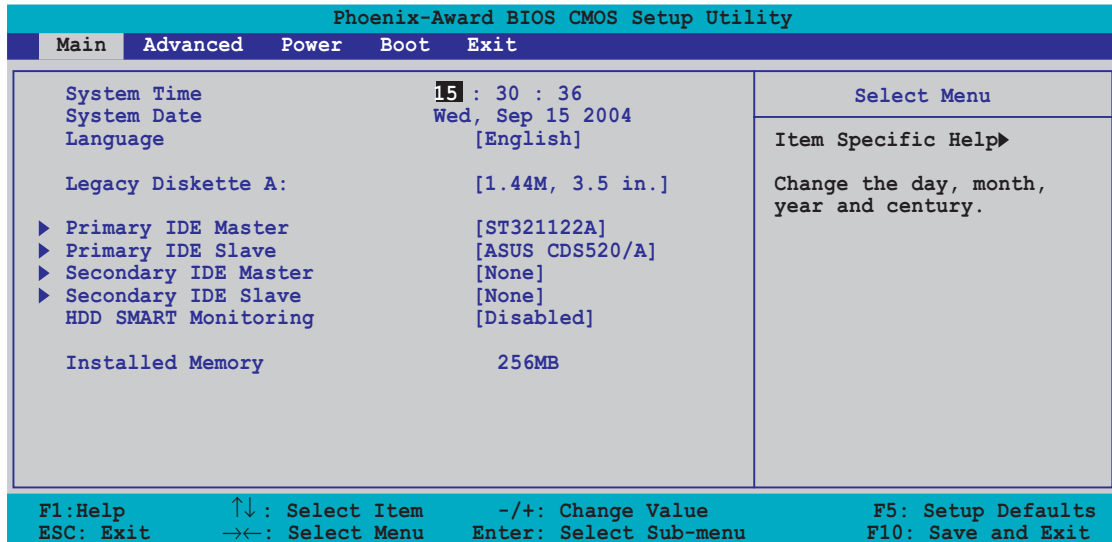

### 4.3.1 System Time [xx:xx:xxxx]

Allows you to set the system time.

### 4.3.2 System Date [Day xx/xx/xxxx]

Allows you to set the system date.

### 4.3.3 Language [English]

Allows you to choose the BIOS language version from the options.

Configuration options: [English] [French] [German]

### 4.3.4 Legacy Diskette A [1.44M, 3.5 in.]

Sets the type of floppy drive installed. Configuration options: [Disabled]

[360K, 5.25 in.] [1.2M, 5.25 in.] [720K, 3.5 in.] [1.44M, 3.5 in.]

[2.88M, 3.5 in.]

### 4.3.5 Primary and Secondary IDE Master/Slave

While entering Setup, the BIOS automatically detects the presence of IDE devices. There is a separate sub-menu for each IDE device. Select a device item then press <Enter> to display the IDE device information.

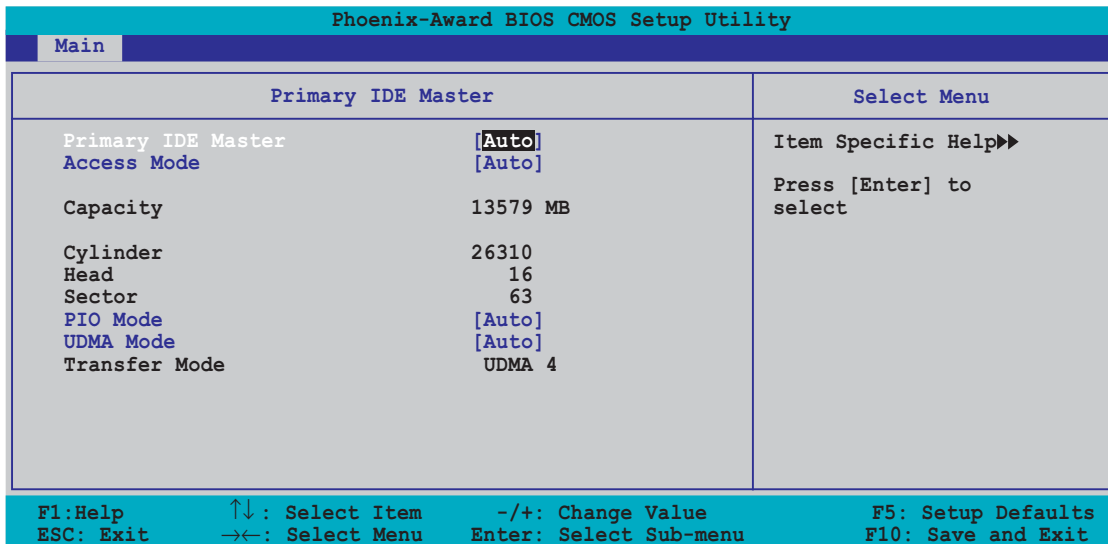

The BIOS automatically detects the values opposite the dimmed items (Capacity, Cylinder, Head, Sector and Transfer Mode). These values are not user-configurable. These items show N/A if no IDE device is installed in the system.

#### Primary/Secondary IDE Master/Slave [Auto]

Select [Auto] to automatically detect an IDE hard disk drive. If automatic detection is successful, the BIOS automatically fills in the correct values for the remaining fields on this sub-menu. If the hard disk was already formatted on a previous system, the setup BIOS may detect incorrect parameters. Select [Manual] to manually enter the IDE hard disk drive parameters. If no drive is installed select [None].

Configuration options: [None] [Auto] [Manual]

#### Access Mode [Auto]

The default [Auto] allows automatic detection of an IDE hard disk drive. Select [CHS] for this item if you set the IDE Primary Master/Slave to [Manual]. Configuration options: [CHS] [LBA] [Large] [Auto]



Before attempting to configure a hard disk drive, make sure you have the correct configuration information supplied by the drive manufacturer. Incorrect settings may cause the system to fail to recognize the installed hard disk.

## Capacity

Displays the auto-detected hard disk capacity. This item is not configurable.

## Cylinder

Shows the number of the hard disk cylinders. This item is not configurable.

## Head

Shows the number of the hard disk read/write heads. This item is not configurable.

## Sector

Shows the number of sectors per track. This item is not configurable.

## PIO Mode

Sets the PIO mode for the IDE device.

Configuration options: [Auto] [Mode 0] [Mode 1] [Mode 2] [Mode 3] [Mode 4]

## UDMA Mode

Disables or sets the UDMA mode. Configuration options: [Disabled] [Auto]

## Transfer Mode

Shows the Transfer mode. This item is not configurable.



---

After entering the IDE hard disk drive information into BIOS, use a disk utility, such as FDISK, to partition and format new IDE hard disk drives. This is necessary so that you can write or read data from the hard disk. Make sure to set the partition of the Primary IDE hard disk drives to active.

---

## 4.3.6 HDD SMART Monitoring

Enables or disables the hard disk Self-Monitoring Analysis & Reporting Technology (SMART) feature. Configuration options: [Disabled] [Enabled]

## 4.3.7 Installed Memory

Shows the size of installed memory.

## 4.4 Advanced menu

The Advanced menu items allow you to change the settings for the CPU and other system devices.



Take caution when changing the settings of the Advanced menu items. Incorrect field values can cause the system to malfunction.

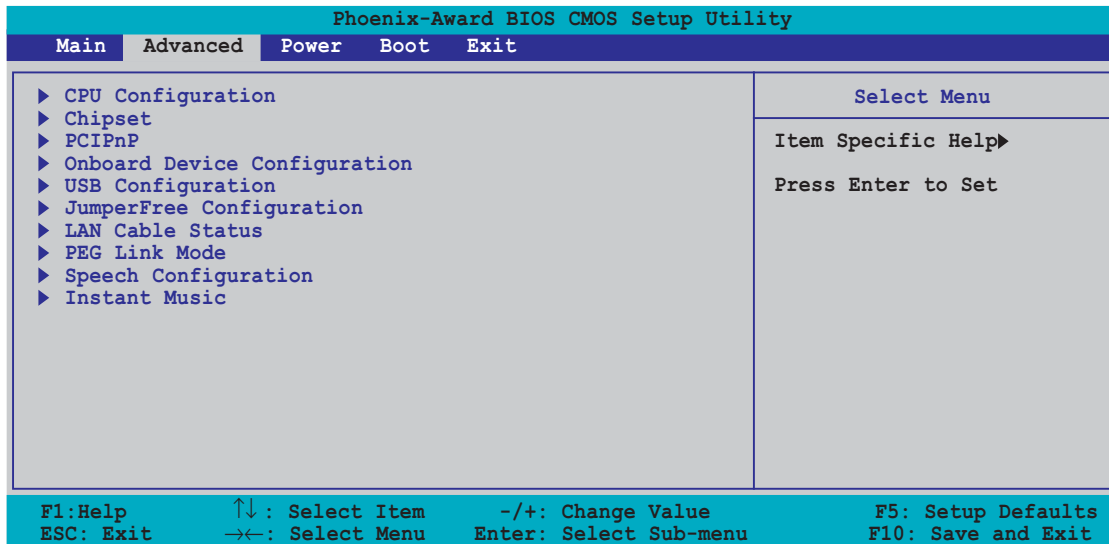

### 4.4.1 CPU Configuration

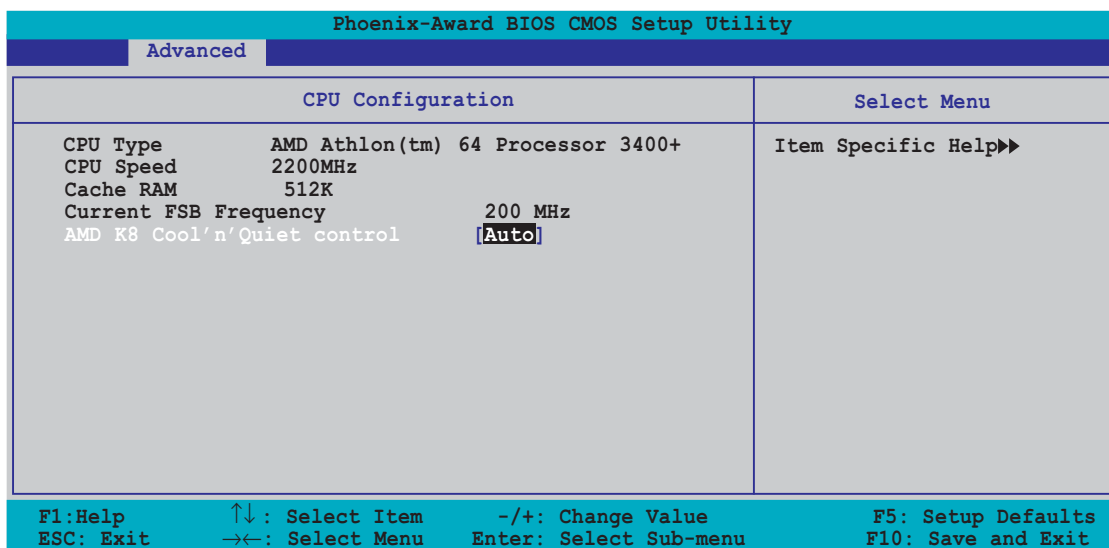

#### Cool N' Quiet [Auto]

Allows you to disable or set the AMD Cool 'n' Quiet!™ Technology feature. Configuration options: [Auto] [Disabled]



- Make sure that the above item is set to **Auto** if you want to use the AMD CPU Cool 'n' Quiet!™ Technology feature.
- This feature requires the AMD CPU heatsink and fan assembly with monitor chip. If you purchased a separate heatsink and fan package, use the ASUS Q-Fan Technology feature to automatically adjust the CPU fan speed according to your system loading.

## 4.4.2 Chipset

Phoenix-Award BIOS CMOS Setup Utility			
Advanced			
Chipset		Select Menu	
▶ DRAM Configuration		Item Specific Help▶▶▶	
Upstream LDT Bus Width	[16 bit]		
Downstream LDT Bus Width	[16 bit]		
LDT Bus Frequency	[Auto]		
VLink Mode Selection	[By Auto]		
PEG Data Scrambling	[Auto]		
PE0-PE3 Data Scrambling	[Enable]		
Init Display First	[PCI Slot]		
Chipset Vcore Adjustment	[+1.6 V]		
F1: Help	↑↓: Select Item	-/+ : Change Value	F5: Setup Defaults
ESC: Exit	→←: Select Menu	Enter: Select Sub-menu	F10: Save and Exit

## DRAM Configuration

The items in this sub-menu show the DRAM-related information auto-detected by the BIOS.

Phoenix-Award BIOS CMOS Setup Utility			
Advanced			
DRAM Configuration		Select Menu	
Current DRAM Frequency	166 MHz	Item Specific Help▶▶▶▶	
Max Memclock (MHz)	[Auto]		
CAS# latency (Tcl)	[Auto]		
RAS# to CAS# delay (Trcd)	[Auto]		
Min RAS# active time(Tras)	[Auto]		
Row precharge Time (Trp)	[Auto]		
Master ECC Enable	[Enabled]		
		Place an artificial memory clock limit on the system. Memory is prevented from running faster than this frequency.	
F1: Help	↑↓: Select Item	-/+ : Change Value	F5: Setup Defaults
ESC: Exit	→←: Select Menu	Enter: Select Sub-menu	F10: Save and Exit

### Current DRAM Frequency

Shows the Transfer mode. This item is not configurable.

### Max Memclock (MHz) [Auto]

Sets the maximum operating memory clock.

Configuration options: [Auto] [DDR200] [DDR266] [DDR333] [DDR400]

CAS# latency (Tcl) [Auto]

Controls the latency between the SDRAM read command and the time the data actually becomes available. Configuration options: [Auto] [2.0] [2.5] [3.0]

RAS# to CAS# delay (Trcd) [Auto]

Controls the latency between the DDR SDRAM active command and the read/write command. Configuration options: [Auto] [2] [3] [4] [5] [6] [7]

Min RAS# active time (Tras) [Auto]

Sets the minimum RAS# active time. Configuration options: [Auto] [5] [6] [7] [8] [9] [10] [11] [12] [13] [14] [15]

Row precharge Time (Trp) [Auto]

Sets the Row precharge time. Configuration options: [Auto] [2] [3] [4] [5] [6]

Master ECC Enable [Enabled]

Enables or disables the Master ECC feature.  
Configuration options: [Disabled] [Enabled]

**Upstream LDT Bus Width [16 bit]**

Sets the upstream Lightning Data Transport (LDT) Bus Width.  
Configuration options: [ 8 bit] [16 bit]

**Downstream LDT Bus Width [16 bit]**

Sets the downstream Lightning Data Transport (LDT) Bus Width.  
Configuration options: [ 8 bit] [16 bit]

**LDT Bus Frequency [Auto]**

Sets the Lightning Data Transport (LDT) Bus frequency.  
Configuration options: [Auto] [1 GHz] [800 MHz] [600 MHz] [400 MHz] [200 MHz]

**VLink Mode Selection [By Auto]**

Sets the VLink mode. Configuration options: [By Auto] [Mode 0] [Mode 1] [Mode 2] [Mode 3] [Mode 4]

**PEG Data Scrambling [Auto]**

Disables or enables the PCI Express™ graphics data scrambling.  
Configuration options: [Auto] [Disable] [Enable]

## PE0-PE3 Data Scrambling [Enable]

Disables or enables the PCI Express™ 0 to PCI Express™ 3 data scrambling.  
Configuration options: [Disable] [Enable]

## Init Display First [PCI Slot]

Allows you to select the graphics controller to use as the primary boot device. Configuration options: [PCI Slot] [PCIEx]

## Chipset Vcore Adjustment [+1.5 V]

Sets the chipset vcore adjustment voltage.  
Configuration options: [+1.5 V] [+1.6 V]

### 4.4.3 PCI PnP

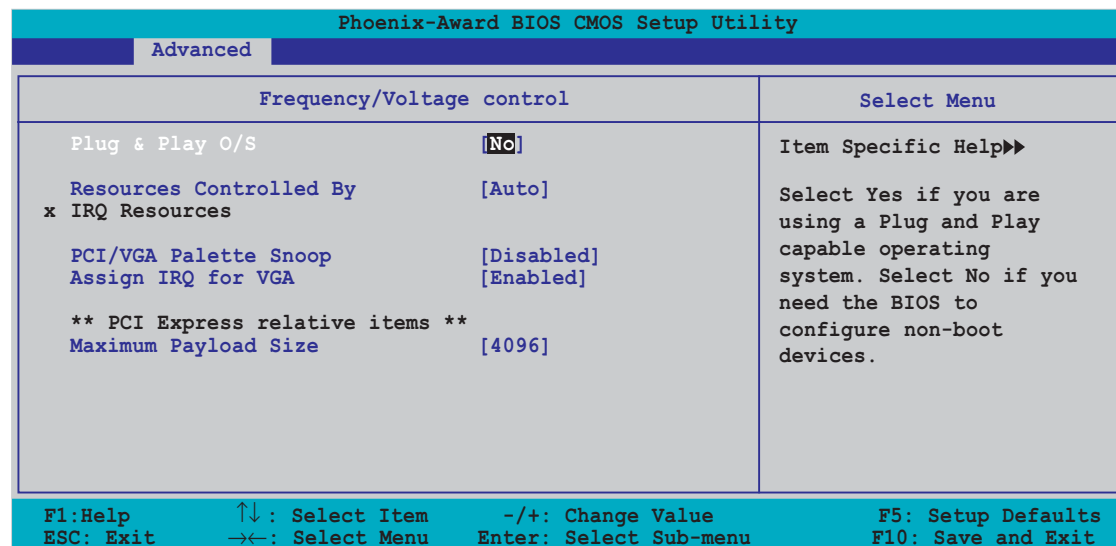

## Plug & Play O/S [No]

When set to [No], the BIOS configures all the devices in the system. When set to [Yes] and if you install a Plug and Play operating system, the operating system configures the Plug and Play devices not required for boot. Configuration options: [No] [Yes]

## Resources Controlled By [Auto]

When set to [Auto], the BIOS automatically configures all the boot and Plug and Play compatible devices. Set to [Manual] if you want to assign the IRQ DMA and memory base address fields.  
Configuration options: [Auto] [Manual]



When the item Resources Controlled By is set to [Auto], the item IRQ Resources is grayed out and not user-configurable. Refer to the section “IRQ Resources” for information on how to enable this item.

## IRQ Resources

This sub-menu is activated only when the **Resources Controlled By** item is set to Manual.

Phoenix-Award BIOS CMOS Setup Utility			
Advanced			
IRQ Resources		Select Menu	
IRQ-3 assigned to	[PCI Device]	Item Specific Help▶▶▶	
IRQ-4 assigned to	[PCI Device]	Legacy ISA for devices	
IRQ-5 assigned to	[PCI Device]	compliant with the	
IRQ-7 assigned to	[PCI Device]	original PC AT bus	
IRQ-9 assigned to	[PCI Device]	specification, PCI/ISA	
IRQ-10 assigned to	[PCI Device]	PnP for devices	
IRQ-11 assigned to	[PCI Device]	compliant with the	
IRQ-12 assigned to	[PCI Device]	Plug and Play standard	
IRQ-14 assigned to	[PCI Device]	whether designed for	
IRQ-15 assigned to	[PCI Device]	PCI or ISA bus	
		architecture	

F1: Help      ↑↓ : Select Item      -/+ : Change Value      F5: Setup Defaults  
ESC: Exit      →← : Select Menu      Enter: Select Sub-menu      F10: Save and Exit

### IRQ-xx assigned to

When set to [PCI Device], the specific IRQ is free for use of PCI/PnP devices. When set to [Reserved], the IRQ is reserved for legacy ISA devices. Configuration options: [PCI Device] [Reserved]

## PCI/VGA Palette Snoop [Disabled]

When set to [Enabled], the palette snooping feature informs the PCI devices that an ISA graphics device is installed in the system so that the latter can function correctly. Configuration options: [Disabled] [Enabled]

## Assign IRQ for VGA [Enabled]

When set to [Enabled], the BIOS assigns an IRQ to PCI VGA card if the card requests for an IRQ. When set to [Disabled], the BIOS does not assign an IRQ to the PCI VGA card even if requested. Configuration options: [Disabled] [Enabled]

## Maximum Payload Size [4096]

Sets the maximum payload size in bytes for PCI Express devices. Configuration options: [128] [256] [512] [1024] [2048] [4096]



## 4.4.4 Onboard Devices Configuration

Phoenix-Award BIOS CMOS Setup Utility		
Advanced		
Onboard Device Configuration	Select Menu	
Onboard 1394 Controller	<b>[Enabled]</b>	Item Specific Help▶▶
Onboard PCIE GbE LAN	[Enabled]	Enable/Disable Onboard
Onboard LAN Boot ROM	[Disabled]	1394 device support.
Onboard Wireless LAN	[Enabled]	
OnChip SATA	[Enabled]	
SATA Mode	[RAID]	
Onboard AC97 Audio	[Auto]	
Serial Port1 Address	[3F8/IRQ4]	
Parallel Port Address	[378/IRQ7]	
Parallel Port Mode	[ECP+EPP]	
EPP Mode Select	[EPP1.7]	
ECP Mode Use DMA	[3]	
Game Port Address	[201]	
Midi Port Address	[330]	
Midi Port IRQ	[10]	

F1:Help      ↑↓: Select Item      -/+ : Change Value      F5: Setup Defaults  
ESC: Exit      →←: Select Menu      Enter: Select Sub-menu      F10: Save and Exit

### Onboard 1394 Controller [Enabled]

Enables or disables the onboard 1394 controller.  
Configuration options: [Enabled] [Disabled]

### OnBoard PCIEX GbE LAN [Enabled]

Allows you to enable or disable the onboard PCI Express Gigabit LAN controller. Configuration options: [Disabled] [Enabled]

### OnBoard LAN Boot ROM [Disabled]

Allows you to enable or disable the onboard LAN boot ROM.  
Configuration options: [Disabled] [Enabled]

### OnBoard Wireless LAN [Enabled]

Allows you to enable or disable the onboard Wi-Fi controller.  
Configuration options: [Disabled] [Enabled]

### OnChip SATA [Enabled]

Allows you to enable or disable the onboard VIA Serial ATA controller.  
Configuration options: [Disabled] [Enabled]

### SATA Mode [RAID]

Allows you to set the onboard VIA SATA RAID controller mode.  
Configuration options: [IDE] [RAID]

### **Onboard AC97 Audio [Auto]**

Allows you to disable or set the onboard AC97 audio controller.

Configuration options: [Disabled] [Auto]

### **Serial Port1 Address [3F8/IRQ4]**

Allows you to select the Serial Port1 base address.

Configuration options: [Disabled] [3F8/IRQ4] [2F8/IRQ3] [3E8/IRQ4] [2E8/IRQ3] [Auto]

### **Parallel Port Address [378/IRQ7]**

Allows you to select the Parallel Port base addresses.

Configuration options: [Disabled] [378/IRQ7] [278/IRQ5] [3BC/IRQ7]

### **Parallel Port Mode [ECP+EPP]**

Allows you to select the Parallel Port mode.

Configuration options: [Normal] [SPP] [EPP] [ECP] [ECP+EPP] [Normal]

### **EPP Mode Select [EPP1.7]**

Allows selection of the Parallel Port EPP version.

Configuration options: [EPP1.9] [EPP1.7]

### **ECP Mode Use DMA [3]**

Allows selection of ECP Mode. Configuration options: [1] [3]

### **Game Port Address [201]**

Allows you to select the Game Port address or to disable the port.

Configuration options: [Disabled] [201] [209]

### **Midi Port Address [330]**

Allows you to select the Game Port address or to disable the port.

Configuration options: [Disabled] [330] [300] [290]

### **Midi Port IRQ [10]**

Allows you to set the Midi port IRQ address. Configuration options: [5] [10]

## 4.4.5 USB Configuration

The items in this menu allows you to change the USB-related features. Select an item then press <Enter> to display the configuration options.

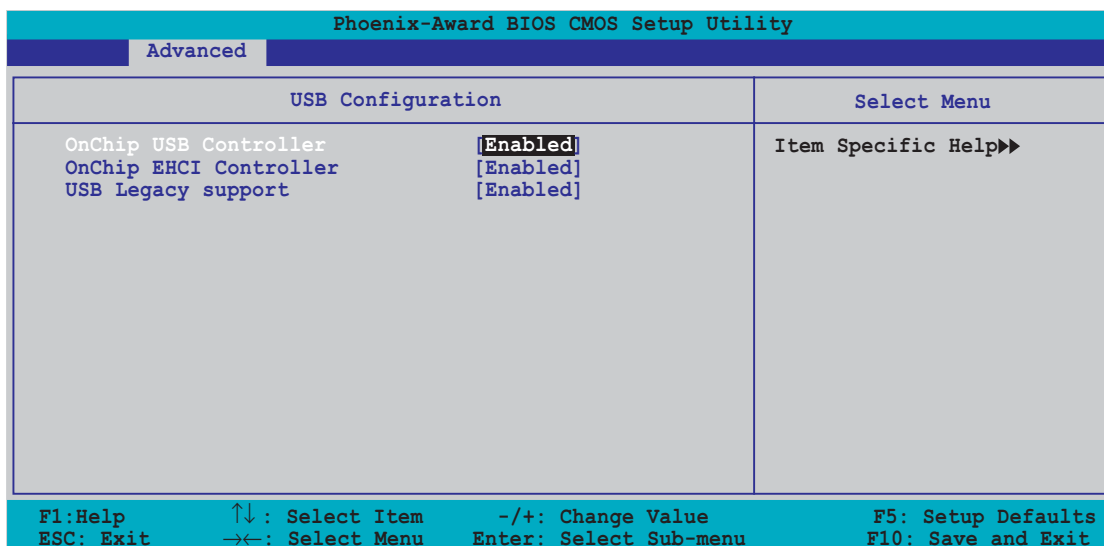

### OnChip USB Controller [Enabled]

Allows you to enable or disable the onchip USB controller. Configuration options: [Disabled] [Enabled]

### OnChip EHCI Controller [Enabled]

Allows you to enable or disable the onchip Enhanced Host Controller Interface (EHCI) controller. Configuration options: [Disabled] [Enabled]

### USB Legacy Support [Enabled]

Allows you to enable or disable support for USB devices on legacy operating systems (OS). Configuration options: [Disabled] [Enabled]

## 4.4.6 JumperFree Configuration

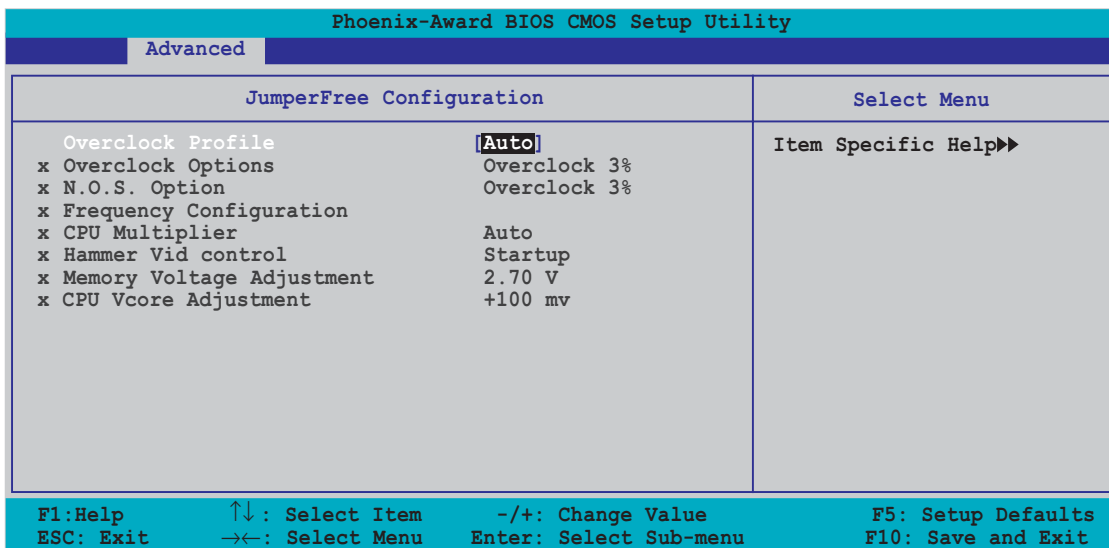

### Overclock Profile [Auto]

Allows selection of CPU overclocking options to achieve desired CPU internal frequency. Select either one of the preset overclocking configuration options:

<b>Manual</b>	Allows you to individually set overclocking parameters.
<b>Auto</b>	Loads the optimal settings for the system.
<b>Standard</b>	Loads the standard settings for the system.
<b>Overclock Profile</b>	Loads overclocking profiles with optimal parameters for stability when overclocking.
<b>AI N.O.S.</b>	The ASUS AI Non-delay Overclocking System feature intelligently determines the system load and automatically boost the performance for the most demanding tasks.



The following items are user-configurable only when the AI Overclocking item is set to [Manual].

Phoenix-Award BIOS CMOS Setup Utility			
Advanced			
JumperFree Configuration		Select Menu	
Overclock Profile	[Auto]	Item Specific Help▶▶	
x Overclock Options	Disabled		
x N.O.S. Option	Disabled		
▶ Frequency Configuration			
CPU Multiplier	[Auto]		
Hammer Vid control	[Startup]		
Memory Voltage Adjustment	[2.75 V]		
CPU Vcore Adjustment	[+100 mv]		
F1:Help      ↑↓ : Select Item      -/+ : Change Value      F5: Setup Defaults			
ESC: Exit    →← : Select Menu    Enter: Select Sub-menu    F10: Save and Exit			

## Frequency Configuration

The items in this sub-menu show the frequency information auto-detected by the BIOS.

Phoenix-Award BIOS CMOS Setup Utility		
Advanced		
Frequency Configuration		Select Menu
Spread Spectrum	[Auto]	Item Specific Help▶▶
PCIEx clock Sync. to CPU	[Enable]	
x PCIEx Clock	100MHz	
PCI clock Sync. to CPU	[Enabled]	
x PCI Clock	33.0 MHz	
CPU Clock	[200MHz]	
F1:Help      ↑↓ : Select Item      -/+ : Change Value      F5: Setup Defaults		
ESC: Exit    →← : Select Menu    Enter: Select Sub-menu    F10: Save and Exit		

### Spread Spectrum [Auto]

Enables or disables the clock generator spread spectrum.  
Configuration options: [Disabled] [Enabled] [Auto]

PCIEx clock Sync. to CPU [Enable]

Enables or disables the PCI Express™ synchronous clock to the CPU.  
Configuration options: [Disabled] [Enabled]

PCIEx Clock [XXX] (value is auto-detected)

Allows you to set the PCI Express clock frequency. This item is user-configurable only when the **PCIEx clock Sync. to CPU** item is set to Disabled. The BIOS detects the default value of this item. Press <Enter> then key-in desired PCI Express clock frequency within range.

PCI clock Sync. to CPU [Enable]

Enables or disables the PCI synchronous clock to the CPU.  
Configuration options: [Disabled] [Enabled]

PCI Clock [XXX] (value is auto-detected)

Allows you to set the PCI clock frequency. This item is user-configurable only when the **PCI clock Sync. to CPU** item is set to Disabled. The BIOS detects the default value of this item. Press <Enter> then key-in desired PCI clock frequency within range.

CPU Clock [XXX] (value is auto-detected)

Displays the frequency sent by the clock generator to the system bus and PCI bus. The default value of this item is auto-detected by the BIOS. Use the <+> and <-> keys to adjust the CPU frequency. Refer to the following table for the correct Front Side Bus and CPU External Frequency settings.



---

Selecting a very high CPU frequency may cause the system to become unstable! If this happens, revert to the default setting.

---

## CPU Multiplier [Auto]

Sets the CPU multiplier. Configuration options: [Auto] [x4] [x4.5] [x5] [x5.5] [x6] [x6.5] [x7] [x7.5] [x8] [x8.5] [x9] [x9.5] [x10] [x10.5] [x11] [x11.5] [x12] [x12.5] [x13] [x13.5] [x14] [x14.5] [x15] [x15.5] [x16] [x16.5] [x17] [x17.5] [x18] [x18.5] [x19] [x19.5] [x20]

## Hammer Vid control [Startup]

Sets the Hammer Voltage ID control. Configuration options: [Startup]  
[1.5625v] [1.550 v] [1.5375v] [1.525 v] [1.5125v] [1.500 v] [1.4875v]  
[1.475 v] [1.4625v] [1.450 v] [1.4375v] [1.425 v] [1.4125v] [1.400 v]  
[1.3875v] [1.375 v] [1.3625v] [1.350 v] [1.3375v] [1.325 v] [1.3125v]  
[1.300 v] [1.2875v] [1.275 v] [1.2625v] [1.250 v] [1.2375v] [1.225 v]  
[1.2125v] [1.200 v] [1.1875v] [1.175 v] [1.1625v] [1.150 v] [1.1375v]  
[1.125 v] [1.1125v] [1.100 v] [1.0875v] [1.075 v] [1.0625v] [1.050 v]  
[1.0375v] [1.025 v] [1.0125v] [1.000 v] [0.9875v] [0.975 v] [0.9625v]  
[0.950 v] [0.9375v] [0.925 v] [0.9125v] [0.900 v] [0.8875v] [0.875 v]  
[0.8625v] [0.850 v] [0.8375v] [0.825 v] [0.8125v] [0.800 v]

## Memory Voltage Adjustment [2.75 V]

Sets the memory adjustment voltage. Configuration options: [2.60 V]  
[2.65 V] [2.70 V] [2.75 V] [2.80 V] [2.85 V] [2.90 V] [2.95 V] [3.00 V]

## CPU VCore Offset [+100 mv]

Sets the CPU Vcore offset voltage.  
Configuration options: [+100 mv] [+200 mv]



---

The following item is user-configurable only when the AI Overclocking item is set to [AI Overclock].

---

## Overclock Options [Overclock 3%]

Allows you to set the overlocking options.  
Configuration options: [Overclock 3%] [Overclock 5%] [Overclock 8%]  
[Overclock 10%]



---

The following item is user-configurable only when the AI Overclocking item is set to [AI N.O.S.].

---

## N.O.S. Option [Disable]

Allows you to disable or set the Non-Delay Overclocking System mode.  
Configuration options: [Disable] [Overclock 3%] [Overclock 5%]  
[Overclock 8%] [Overclock 10%]

## 4.4.7 LAN Cable Status

The items in this menu displays the status of the Local Area Network (LAN) cable.

Phoenix-Award BIOS CMOS Setup Utility			
Advanced			
JumperFree Configuration		Select Menu	
POST Check LAN Cable		[Disabled]	
Pair	Status	Length	
1-2	Open	N/A	Item Specific Help▶▶
3-6	Open	N/A	Enable/Disable Speech
4-5	Open	N/A	IC Controller
7-8	Open	N/A	

F1:Help      ↑↓: Select Item      -/+: Change Value      F5: Setup Defaults  
ESC: Exit    →←: Select Menu      Enter: Select Sub-menu      F10: Save and Exit

### POST Check LAN cable [Disabled]

Enables or disables checking of the LAN cable during the Power-On Self-Test (POST). Configuration options: [Disabled] [Enabled]

## 4.4.8 PEG Link Mode

Phoenix-Award BIOS CMOS Setup Utility			
Advanced			
JumperFree Configuration		Select Menu	
PEG Link Mode		[Auto]	
		Item Specific Help▶▶	
		Enhance performance on NVidia 6x00 PCIE serial graphic card.	

F1:Help      ↑↓: Select Item      -/+: Change Value      F5: Setup Defaults  
ESC: Exit    →←: Select Menu      Enter: Select Sub-menu      F10: Save and Exit

### PEG Link Mode [Auto]

Allows you to enhance the performance of your PCI Express graphics card. Configuration options: [Auto] [Slow] [Normal] [Fast] [Faster]



## 4.4.9 Speech Configuration

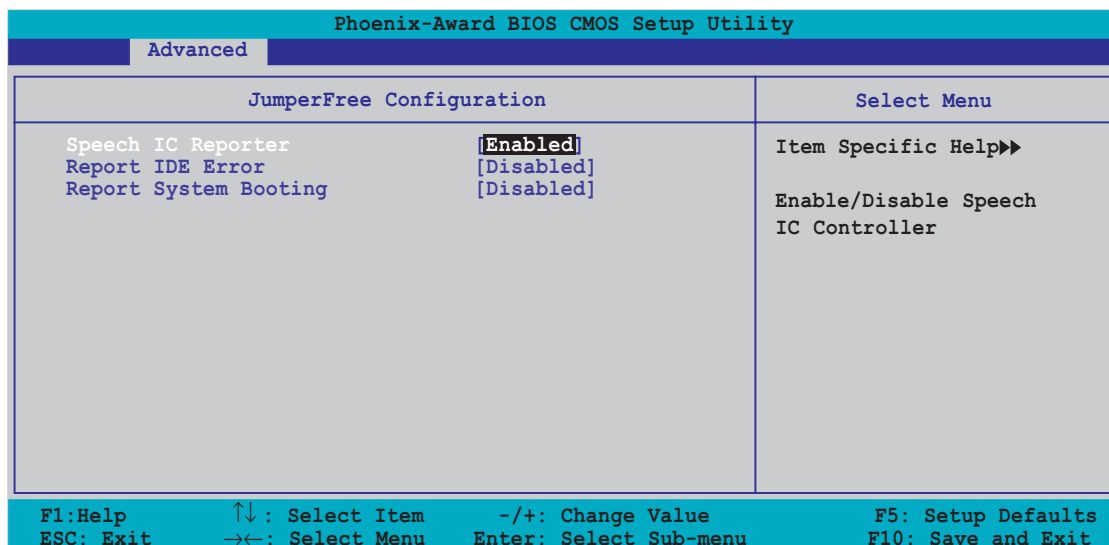

### Speech IC Reporter [Enabled]

Allows you to enable or disable the ASUS Speech POST Reporter™ feature.  
Configuration options: [Disabled] [Enabled]



The following items appear only when Speech POST Reporter is set to Enabled.

### Report IDE Error [Disabled]

Enables or disables the report feature in the event of an IDE error.  
Configuration options: [Disabled] [Enabled]

### Report System Booting [Disabled]

Enables or disables the report after booting the system.  
Configuration options: [Disabled] [Enabled]

## 4.4.10 Instant Music

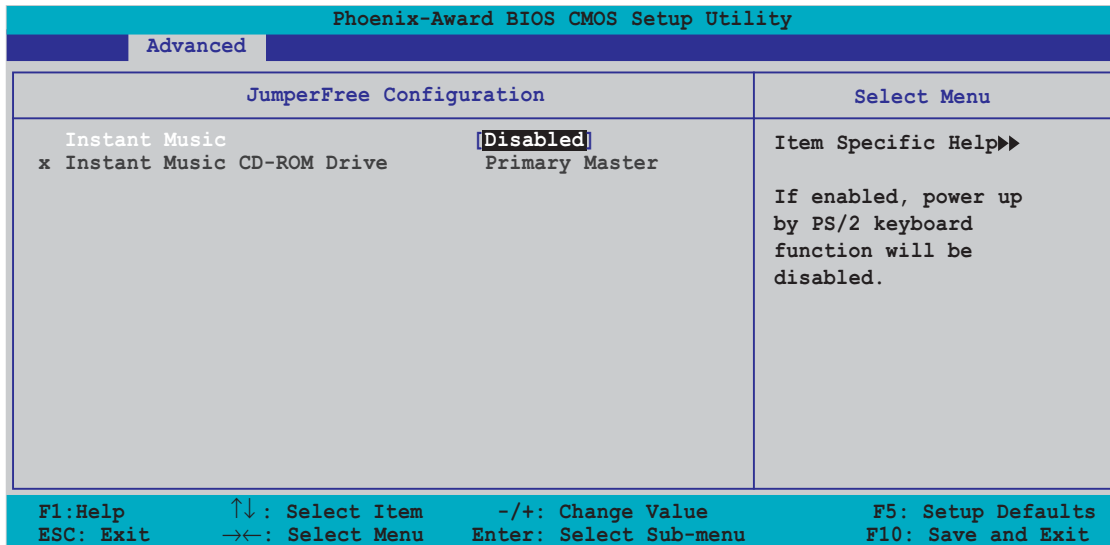

### Instant Music [Disabled]

Allows you to enable or disable the ASUS Instant Music feature.  
Configuration options: [Disabled] [Enabled]



Enabling Instant Music automatically disables the PS/2 keyboard power up feature.

### Instant Music CD-ROM Drive [Primary Master]

Allows you to select the CD-ROM drive that you wish to use for the Instant Music CD playback. Configuration options: [Primary Master] [Primary Slave] [Secondary Master] [Secondary Slave]

## 4.5 Power menu

The Power menu items allow you to change the settings for the Advanced Configuration and Power Interface (ACPI) and the Advanced Power Management (APM). Select an item then press <Enter> to display the configuration options.

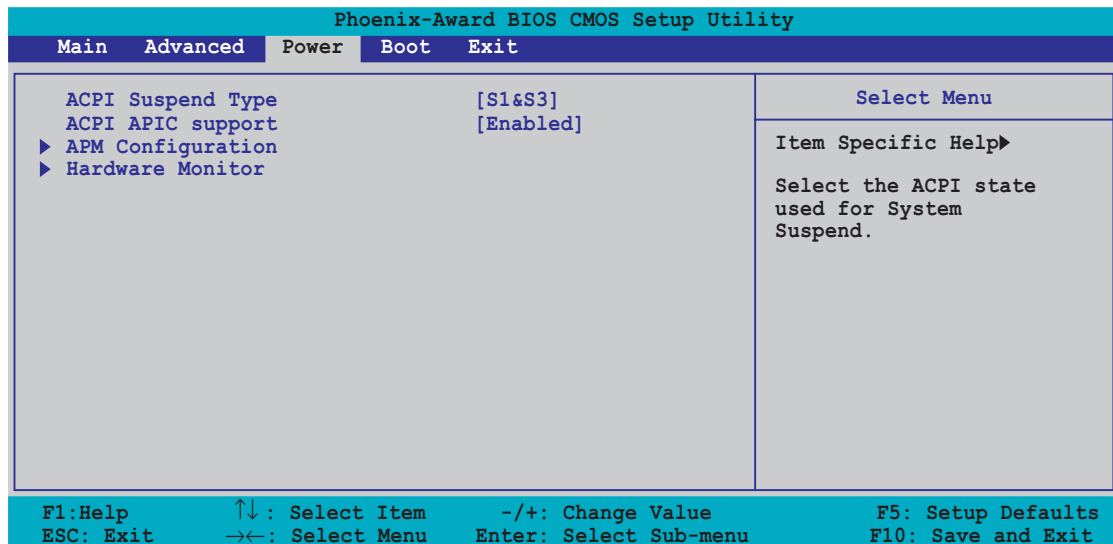

### 4.5.1 ACPI Suspend Type [S1&S3]

Allows you to select the Advanced Configuration and Power Interface (ACPI) state to be used for system suspend.

Configuration options: [S1 (POS)] [S3(STR)] [S1&S3]

### 4.5.2 ACPI APIC Support [Enabled]

Allows you to enable or disable the Advanced Configuration and Power Interface (ACPI) support in the Application-Specific Integrated Circuit (ASIC). When set to Enabled, the ACPI APIC table pointer is included in the RSDT pointer list. Configuration options: [Disabled] [Enabled]

## 4.5.3 APM Configuration

Phoenix-Award BIOS CMOS Setup Utility		
Power		
APM Configuration		Select Menu
PS2KB Wakeup from S5	[Disabled]	Item Specific Help▶▶
PS2MS Wakeup from S5	[Disabled]	
USB Resume from S3	[Disabled]	
Power Up On PCI Devices	[Disabled]	
Modem Ring Resume	[Disabled]	
Power On By RTC Alarm	[Disabled]	
x Date (of Month)	0	
x Resume Time (hh:mm:ss)	0 : 0 : 0	
Restore on AC Power Loss	[Power Off]	
PWR Button < 4 secs	[Instant Off]	

F1:Help      ↑↓: Select Item      -/+: Change Value      F5: Setup Defaults  
ESC: Exit    →←: Select Menu      Enter: Select Sub-menu      F10: Save and Exit

### PS2KB Wakeup from S5 [Disabled]

Allows you to disable the Power On by PS/2 keyboard function or set specific keys on the PS/2 keyboard to turn on the system. This feature requires an ATX power supply that provides at least 1A on the +5VSB lead. Configuration options: [Disabled] [Space Bar] [Ctrl+ESC] [Power Key]

### PS2MS Wakeup from S5 [Disabled]

When set to [Enabled], this parameter allows you to use the PS/2 mouse to turn on the system. This feature requires an ATX power supply that provides at least 1A on the +5VSB lead. Configuration options: [Disabled] [Enabled]

### Power Up On PCI Devices [Disabled]

When set to [Enabled], this parameter allows you to turn on the system through a PCI LAN or modem card. This feature requires an ATX power supply that provides at least 1A on the +5VSB lead. Configuration options: [Disabled] [Enabled]

### Modem Ring Resume [Disabled]

This allows either settings of [Enabled] or [Disabled] for powering up the computer when the external modem receives a call while the computer is in Soft-off mode. Configuration options: [Disabled] [Enabled]

## **Power On By RTC Alarm [Disabled]**

Allows you to enable or disable RTC to generate a wake event. When this item is set to Enabled, the items Date (of Month) and Resume Time (hh:mm:ss) become configurable with set values.

Configuration options: [Disabled] [Enabled]

## **Date (of Month) [0]**

To set the date of alarm, highlight this item and press <Enter> to display the Day of Month Alarm pop-up menu. Key-in a value within the specified range then press <Enter>. Configuration options: [Min=0] [Max=31]

## **Resume Time (hh:mm:ss) 0 : 0 : 0**

To set the time of alarm:

1. Highlight this item and press <Enter> to display a pop-up menu for the hour field.
2. Key-in a value (Min=0, Max=23), then press <Enter>.
3. Press <TAB> to move to the minutes field then press <Enter>.
4. Key-in a minute value (Min=0, Max=59), then press <Enter>.
5. Press <TAB> to move to the seconds field then press <Enter>.
6. Key-in a value (Min=0, Max=59), then press <Enter>.

## **Restore on AC Power Loss [Power Off]**

When set to Power Off, the system goes into off state after an AC power loss. When set to Power On, the system goes on after an AC power loss.

When set to Last State, the system goes into either off or on state, whatever the system state was before the AC power loss.

Configuration options: [Power Off] [Power On] [Last State]

## **PWR Button < 4 secs [Instant-Off]**

Allows you to set the event after the power button is pressed for more than 4 seconds. Configuration options: [Suspend] [Instant-Off]

## 4.5.4 Hardware Monitor

The items in this sub-menu displays the hardware monitor values automatically detected by the BIOS. It also allows you to change CPU Q-Fan feature-related parameters. Select an item then press <Enter> to display the configuration options.

Phoenix-Award BIOS CMOS Setup Utility		
Power		
Hardware Monitor		Select Menu
M/B Temperature	34°C/ 93°F	Item Specific Help▶▶
Current CPU1 Temperature	47°C/118°F	
Chassis Fan speed	0 RPM	
CPU Fan speed	4265 RPM	
Chipset Fan speed	7500 RPM	
Chassis Fan2 speed	6367 RPM	
VCORE Voltage	1.64V	
+12V Voltage	11.35V	
+3.3V Voltage	3.36V	
+5VCC Voltage	5.22V	
Q-FAN Function	[Disabled]	
x CPU Target Temperature	45°C/113°F	
x Temperature Tolerance	3°C	
x Minimum FAN Duty Cycle	11/16	
x FAN Step Time	0.1 sec	

F1: Help      ↑↓: Select Item      -/+ : Change Value      F5: Setup Defaults  
ESC: Exit      →←: Select Menu      Enter: Select Sub-menu      F10: Save and Exit

### M/B Temperature Current CPU1 Temperature

The onboard hardware monitor automatically detects and displays the motherboard and CPU temperatures. These items are not user-configurable.

### Chassis Fan Speed CPU Fan Speed Chipset Fan Speed Chassis Fan2 Speed

The onboard hardware monitor automatically detects and displays the Chassis, CPU, and Power fan speeds in rotations per minute (RPM). If the fan is not connected to the motherboard, the field shows 0. These items are not user-configurable.

### VCORE Voltage, +12V Voltage, 3.3V Voltage, 5VCC Voltage

The onboard hardware monitor automatically detects the voltage output through the onboard voltage regulators. These items are not user-configurable.

### Q-FAN Function [Disabled]

Allows you to disable or enable the ASUS Q-Fan function.  
Configuration options: [Disabled] [Enabled]

## CPU Target Temperature [xxx°C/xxx°F]

Allows you to set the CPU Q-Fan temperature threshold when the CPU fan speed is increased to lower the CPU temperature.

Configuration options: [10°C/50°F] [15°C/59°F] [20°C/68°F] [25°C/77°F] [30°C/86°F] [35°C/95°F] [40°C/104°F] [45°C/113°F] [50°C/122°F] [55°C/131°F] [60°C/140°F] [65°C/149°F] [70°C/158°F] [75°C/167°F] [80°C/176°F] [85°C/185°F]

## Temperature Tolerance [3°C]

Allows you to set the CPU temperature tolerance value.

Configuration options: [0°C] [1°C] [2°C] [3°C] [4°C] [5°C] [6°C] [7°C]

## Minimum FAN Duty Cycle [11/16]

Allows you to set the minimum fan duty cycle.

Configuration options: [11/16] [12/16] [13/16] [14/16] [15/16]

## FAN Step Time [0.1 sec]

Allows you to select the fan speed time interval. Configuration options:

[0.1 sec] [0.2 sec] [0.3 sec] [0.4 sec] [0.5 sec] [0.6 sec] [0.7 sec] [0.8 sec] [0.9 sec] [1.0 sec] [1.1 sec] [1.2 sec] [1.3 sec] [1.4 sec] [1.5 sec] [1.6 sec]

## 4.6 Boot menu

The Boot menu items allow you to change the system boot options. Select an item then press <Enter> to display the sub-menu.

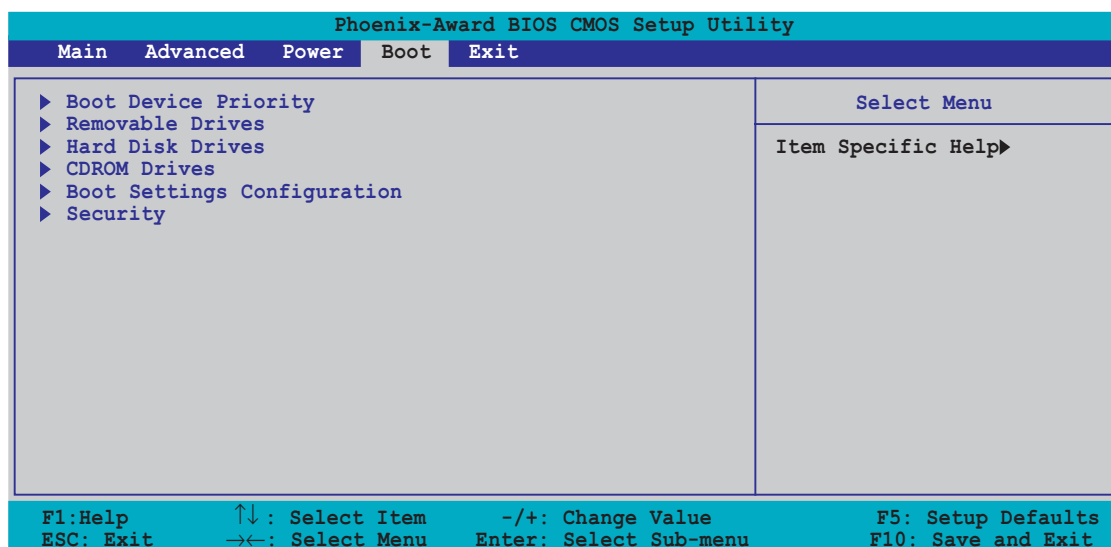

## 4.6.1 Boot Device Priority

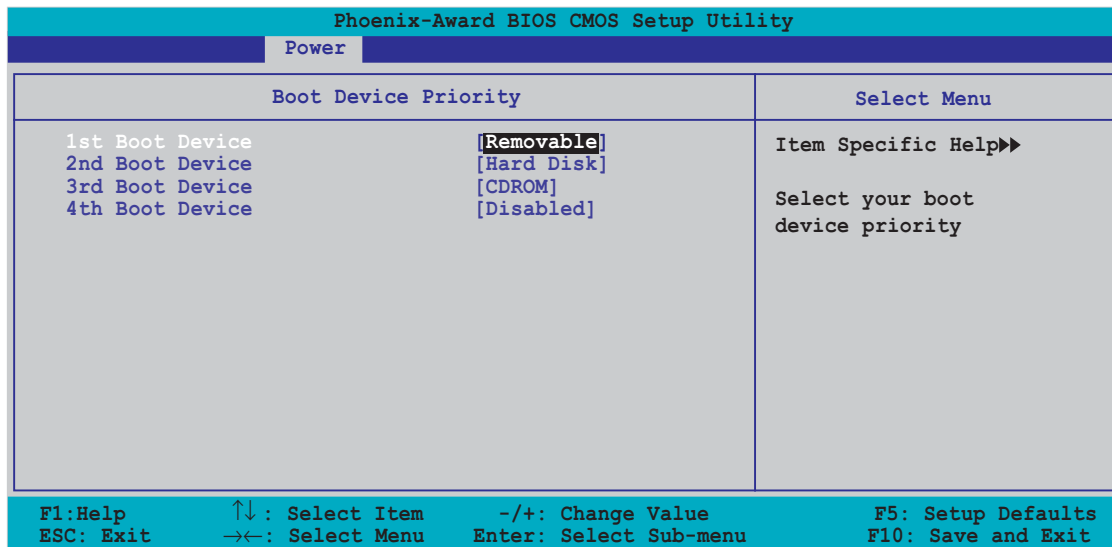

### 1st ~ xxth Boot Device [Removable]

These items specify the boot device priority sequence from the available devices. The number of device items that appears on the screen depends on the number of devices installed in the system.

Configuration options: [xxxxx Drive] [Disabled]

## 4.6.2 Removable Drives

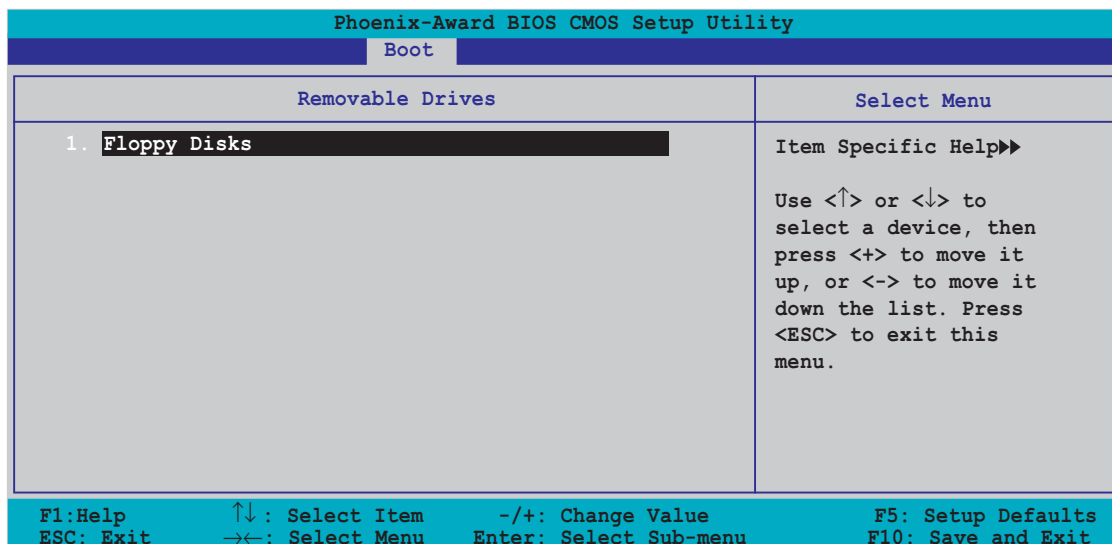

### 1. Floppy Disks

Allows you to assign a removable drive attached to the system.



## 4.6.3 Hard Disk Drives

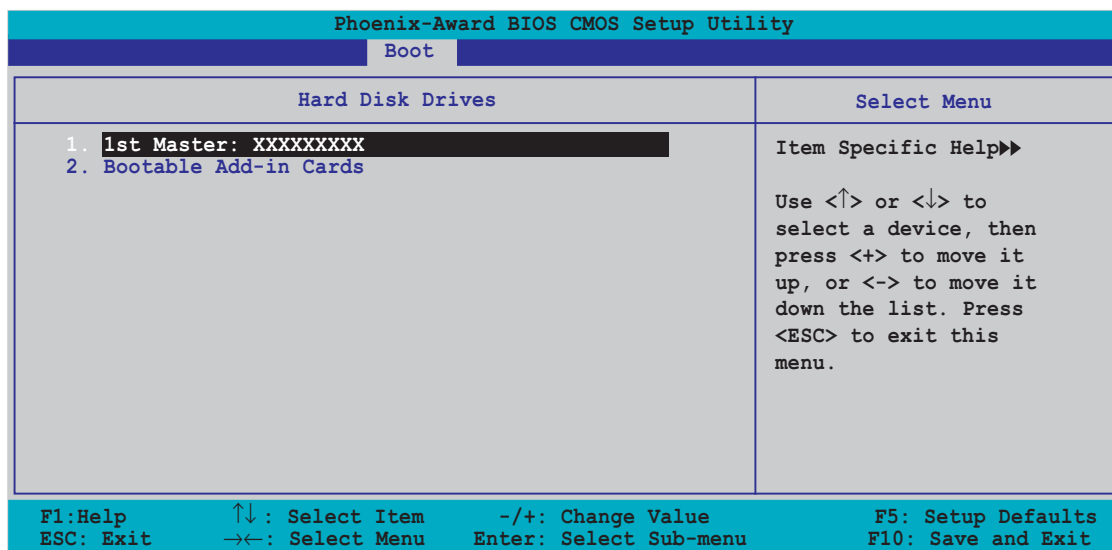

### 1. 1st Master: XXXXXXXXX

Allows you to assign hard disk drives attached to the system.

## 4.6.4 CDROM Drives

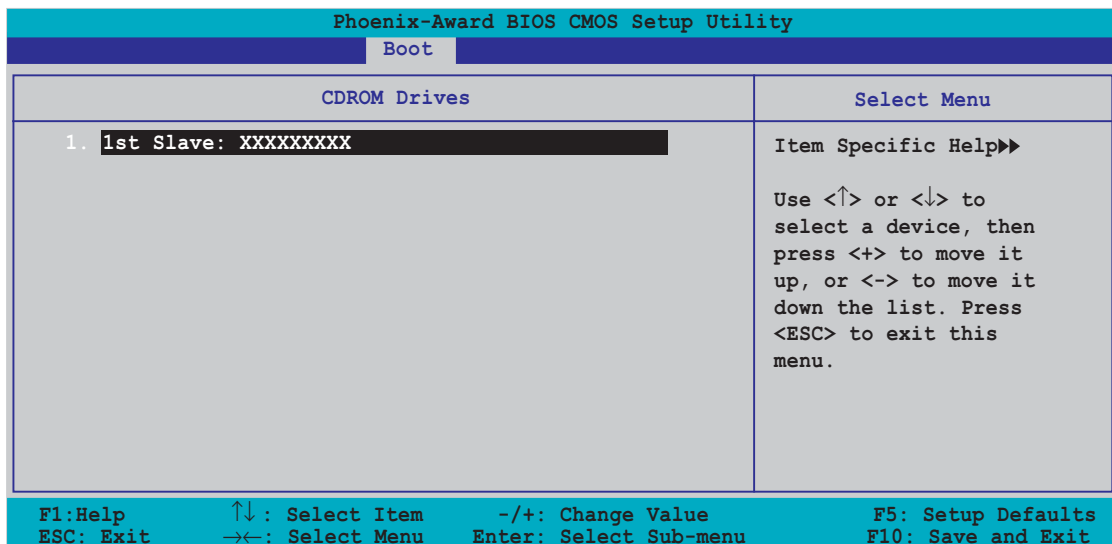

### 1. 1st Slave: XXXXXXXXX

Allows you to assign optical drives attached to the system.

## 4.6.5 Boot Settings Configuration

Phoenix-Award BIOS CMOS Setup Utility		
Boot		
Boot Settings Configuration		Select Menu
Case Open Warning	[Enabled]	Item Specific Help▶▶  Press [Enter] to enable or disable.
Quick Boot	[Enabled]	
Boot Up Floppy Seek	[Enabled]	
Bootup Num-Lock	[On]	
Typematic Rate Setting	[Disabled]	
x Typematic Rate (Chars/Sec)	6	
x Typematic Delay (Msec)	250	
OS Select For DRAM > 64MB	[Non-OS2]	
Full Screen LOGO	[Enabled]	
Halt On	[All, But Keyboard]	

F1: Help      ↑↓: Select Item      -/+ : Change Value      F5: Setup Defaults  
ESC: Exit      →←: Select Menu      Enter: Select Sub-menu      F10: Save and Exit

### Case Open Warning [Enabled]

Enables or disables the chassis open status feature. Setting to Enabled, clears the chassis open status. Configuration options: [Disabled] [Enabled]

### Quick Boot [Enabled]

Enables or disables the quick boot feature. When Enabled, the system skips certain tests while booting. Configuration options: [Disabled] [Enabled]

### Boot Up Floppy Seek [Enabled]

Enables or disables the chassis open status feature. Setting to Enabled, clears the chassis open status. Configuration options: [Disabled] [Enabled]

### Bootup Num-Lock [On]

Allows you to select the power-on state for the NumLock. Configuration options: [Off] [On]

### Typematic Rate Setting [Disabled]

Allows you to set the keystroke rate. Enable this item to configure the **Typematic Rate (Chars/Sec)** and the **Typematic Delay (Msec)**. Configuration options: [Disabled] [Enabled]



The items **Typematic Rate (Chars/Sec)** and **Typematic Delay (Msec)** becomes user-configurable only when the item Typematic Rate Setting is enabled.

### **Typematic Rate (Chars/Sec) [6]**

Allows you to select the rate at which a character repeats when you hold a key. Configuration options: [6] [8] [10] [12] [15] [20] [24] [30]

### **Typematic Delay (Msec) [250]**

Allows you to set the delay before keystrokes begin to repeat. Configuration options: [250] [500] [750] [1000]

### **OS Select for DRAM > 64MB [Non-OS2]**

Set this item to OS2 only when you are running on an OS/2 operating system with an installed RAM of greater than 64 KB. Configuration options: [Non-OS2] [OS2]

### **Full Screen LOGO [Enabled]**

Allows you to enable or disable the full screen logo display feature. Configuration options: [Disabled] [Enabled]



---

Make sure that the above item is set to [Enabled] if you want to use the ASUS MyLogo2™ feature.

---

### **Halt On [All, But Keyboard]**

Allows you to error report type. Configuration options: [All Errors] [No Errors] [All, But Keyboard] [All, But Diskette] [All, But Disk/Key]

## 4.6.6 Security

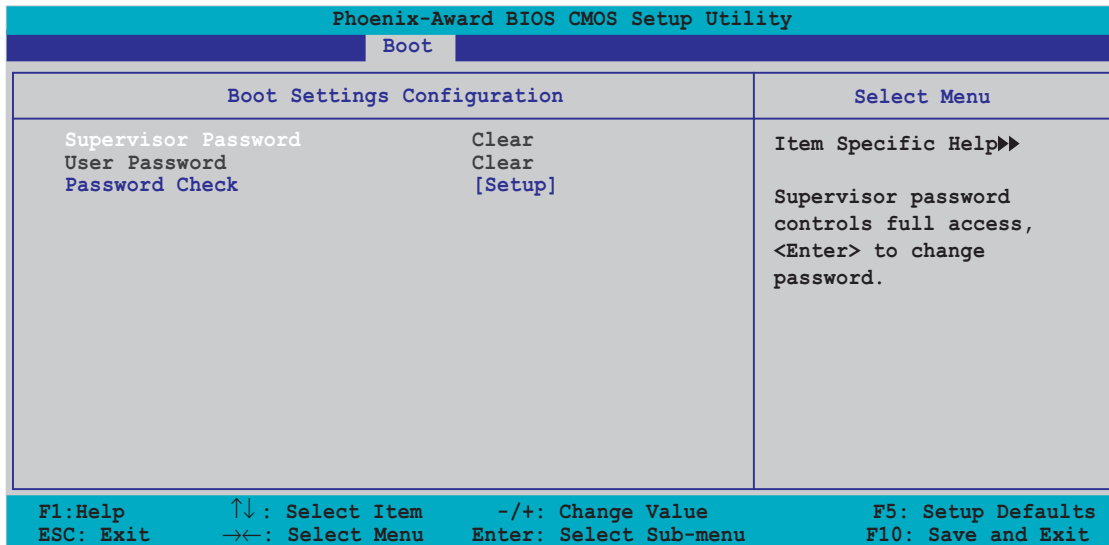

### Supervisor Password User Password

These fields allow you to set passwords:

To set a password:

1. Select an item then press <Enter>.
2. Type in a password using a combination of a maximum of eight (8) alpha-numeric characters, then press <Enter>.
3. When prompted, confirm the password by typing the exact characters again, then press <Enter>. The password field setting is changed to Set.

To clear the password:

1. Select the password field and press <Enter> twice. The following message appears:



2. Press any key to continue. The password field setting is changed to Clear.

## **A note about passwords**

The Supervisor password is required to enter the BIOS Setup program preventing unauthorized access. The User password is required to boot the system preventing unauthorized use.

## **Forgot your password?**

If you forget your password, you can clear it by erasing the CMOS Real Time Clock (RTC) RAM. The RAM data containing the password information is powered by the onboard button cell battery. If you need to erase the CMOS RAM, refer to section “2.6 Jumpers” for instructions.

## **Password Check**

This field requires you to enter the password before entering the BIOS setup or the system. Select [Setup] to require the password before entering the BIOS Setup. Select [System] to require the password before entering the system. Configuration options: [Setup] [System]

## 4.7 Exit menu

The Exit menu items allow you to load the optimal or failsafe default values for the BIOS items, and save or discard your changes to the BIOS items.

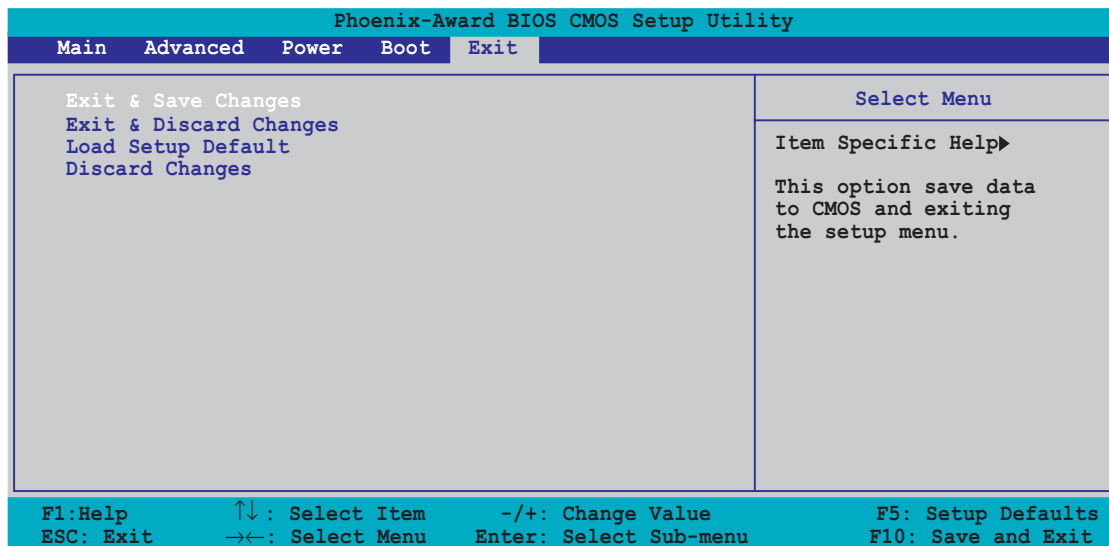

Pressing <Esc> does not immediately exit this menu. Select one of the options from this menu or <F10> from the legend bar to exit.

### Exit & Save Changes

Once you are finished making your selections, choose this option from the Exit menu to ensure the values you selected are saved to the CMOS RAM. An onboard backup battery sustains the CMOS RAM so it stays on even when the PC is turned off. When you select this option, a confirmation window appears. Select **Yes** to save changes and exit.



If you attempt to exit the Setup program without saving your changes, the program prompts you with a message asking if you want to save your changes before exiting. Press <Enter> to save the changes while exiting.

### Exit & Discard Changes

Select this option only if you do not want to save the changes that you made to the Setup program. If you made changes to fields other than System Date, System Time, and Password, the BIOS asks for a confirmation before exiting.

## Load Setup Defaults

This option allows you to load the default values for each of the parameters on the Setup menus. When you select this option or if you press <F5>, a confirmation window appears. Select **Yes** to load default values. Select **Exit & Save Changes** or make other changes before saving the values to the non-volatile RAM.

## Discard Changes

This option allows you to discard the selections you made and restore the previously saved values. After selecting this option, a confirmation appears. Select **Yes** to discard any changes and load the previously saved values.





This chapter describes the contents of the support CD that comes with the motherboard package.

# 5 Software support

## Chapter summary

5.1	Installing an operating system .....	5-1
5.2	Support CD information .....	5-1
5.3	Software information .....	5-9
5.4	RAID configurations .....	5-18
5.5	Creating a RAID driver disk .....	5-26
5.6	Cool 'n' Quiet!™ Technology .....	5-27

## 5.1 Installing an operating system

This motherboard supports Windows® 2000/2003 Server/XP operating systems (OS). Always install the latest OS version and corresponding updates to maximize the features of your hardware.



- Motherboard settings and hardware options vary. Use the setup procedures presented in this chapter for reference only. Refer to your OS documentation for detailed information.
- Make sure that you install Windows® 2000 Service Pack 4 or the Windows® XP Service Pack 1 or later versions before installing the drivers for better compatibility and system stability.

## 5.2 Support CD information

The support CD that came with the motherboard package contains the drivers, software applications, and utilities that you can install to avail all motherboard features.



The contents of the support CD are subject to change at any time without notice. Visit the ASUS website([www.asus.com](http://www.asus.com)) for updates.

### 5.2.1 Running the support CD

Place the support CD to the optical drive. The CD automatically displays the **Drivers** menu if Autorun is enabled in your computer.

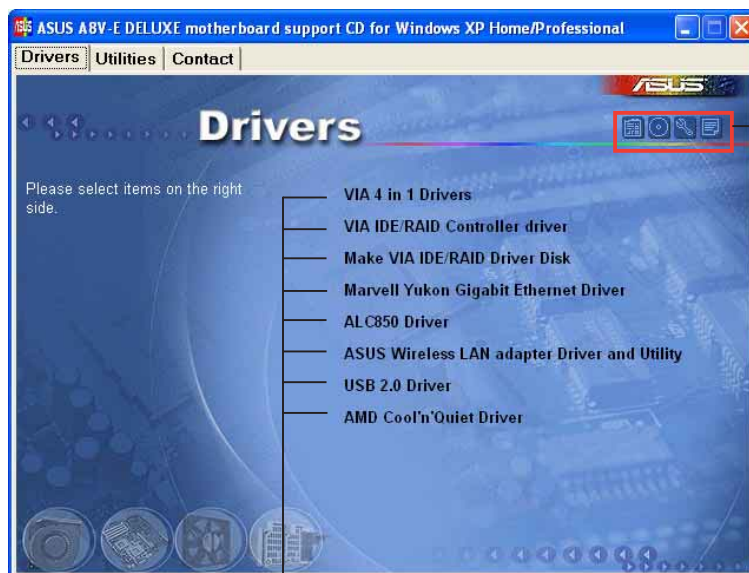

Click an icon to display support CD/motherboard information

Click an item to install



If **Autorun** is NOT enabled in your computer, browse the contents of the support CD to locate the file **ASSETUP.EXE** from the BIN folder. Double-click the **ASSETUP.EXE** to run the CD.

## 5.2.2 Drivers menu

The drivers menu shows the available device drivers if the system detects installed devices. Install the necessary drivers to activate the devices.

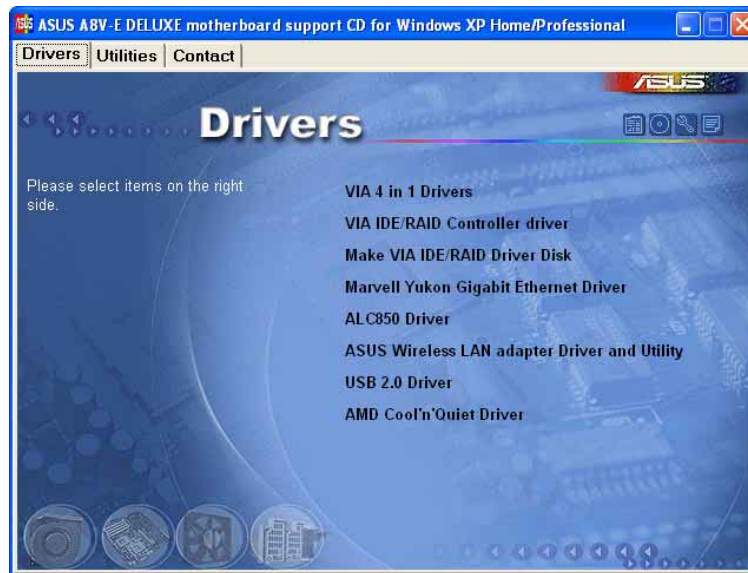

### VIA 4 in 1 drivers

This item installs the following drivers:

- VIA Registry (INF) driver
- VIA ATAPI vendor support driver
- VIA PCI IRQ Miniport driver.

### VIA IDE RAID Controller driver

Installs the VIA 6420 RAID controller driver and application.

### Make VIA 6420 Driver Disk

Allows you to create a RAID driver disk for the VIA 6420 RAID configuration.

### PCI Marvell Yukon Gigabit Ethernet Driver

Installs the Marvell® Yukon 88E8053 PCI Express™ Gigabit LAN driver that provides up to 1000 Mbps data transfer rates.

### ALC850 Audio Driver

Installs the Realtek® ALC850 audio controller and application.

## **ASUS Wireless LAN adapter Drivers and Utility**

Installs the driver, utilities, and setup wizard for the ASUS WiFi-g™ wireless solution. Refer to the WiFi-g™ documentation for details.

## **USB 2.0 Driver**

Installs the USB 2.0 driver.

## **AMD Cool 'n' Quiet Driver**

Launches the AMD Cool 'n' Quiet!™ Technology driver installation wizard.

## 5.2.3 Utilities menu

The Utilities menu shows the applications and other software that the motherboard supports.

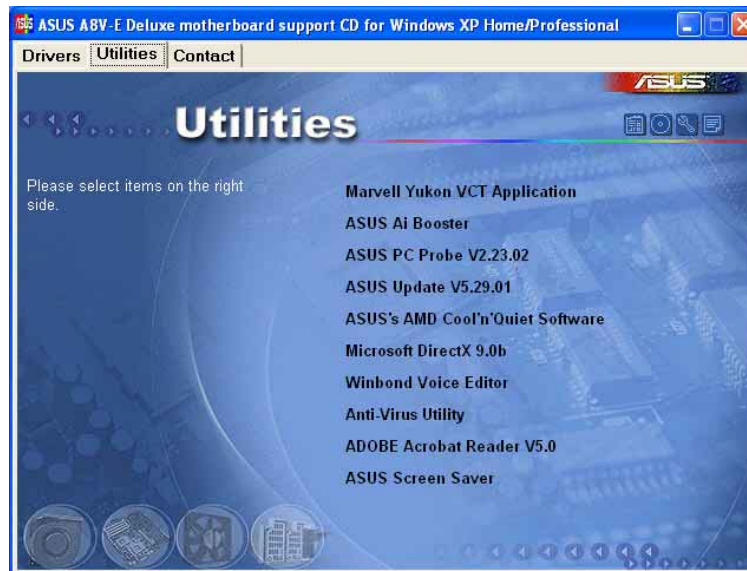

### Marvell Yukon VCT Application

Installs the Marvell® Yukon Virtual Cable Tester (VCT) application. The VCT is a cable diagnostic application that analyzes and reports LAN cable faults and shorts. See page 5-11 for details.

### AI Booster

The ASUS AI Booster application allows you to overclock the CPU speed in a Windows® environment.

### ASUS PC Probe

This smart utility monitors the fan speed, CPU temperature, and system voltages, and alerts you of any detected problems. This utility helps you keep your computer in healthy operating condition.

### ASUS Update

Allows you to download the latest version of the BIOS from the ASUS website.



---

Before using the ASUS Update, make sure that you have an Internet connection so you can connect to the ASUS website.

---

## **Microsoft DirectX**

Installs the Microsoft® DirectX 9.0 driver. The Microsoft DirectX® 9.0 is a multimedia technology that enhances computer graphics and sound. DirectX® improves the multimedia features of your computer so you can enjoy watching TV and movies, capturing videos, or playing games in your computer. Visit the Microsoft website ([www.microsoft.com](http://www.microsoft.com)) for updates.

## **Winbond Voice Editor**

This program is for recording and customizing wave files for the ASUS POST Reporter™. Use this program to change the default vocal POST messages. See section “3.3 Vocal POST Messages” for a list of the default messages.

## **Anti-virus Utility**

The anti-virus application detects and protects your computer from viruses that destroy data.

## **ADOBE Acrobat Reader**

Installs the Adobe® Acrobat® Reader that allows you to open, view, and print documents in Portable Document Format (PDF).

## **ASUS Screen Saver**

Bring life to your computer screen by installing the ASUS screen saver.

## 5.2.4 ASUS Contact information

Click the **Contact** tab to display the ASUS contact information. You can also find this information on the inside front cover of this user guide.

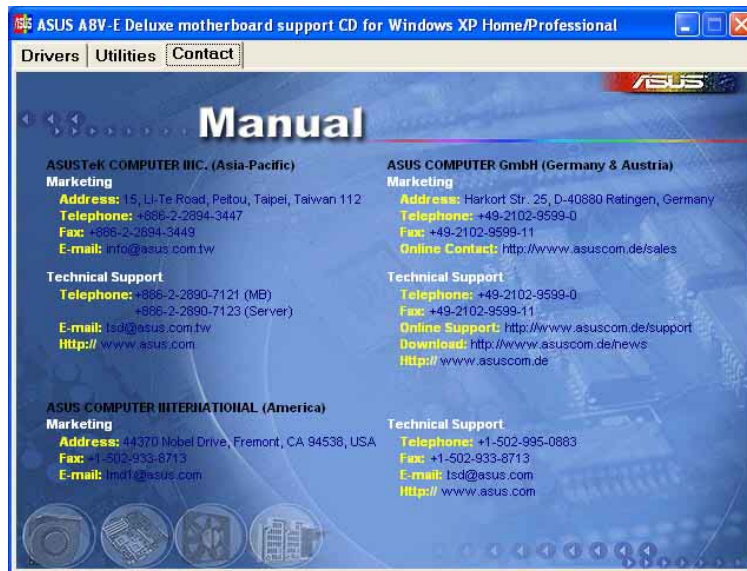

## 5.2.5 Other information

The icons on the top right corner of the screen give additional information on the motherboard and the contents of the support CD. Click an icon to display the specified information.

### Motherboard Info

Displays the general specifications of the motherboard.

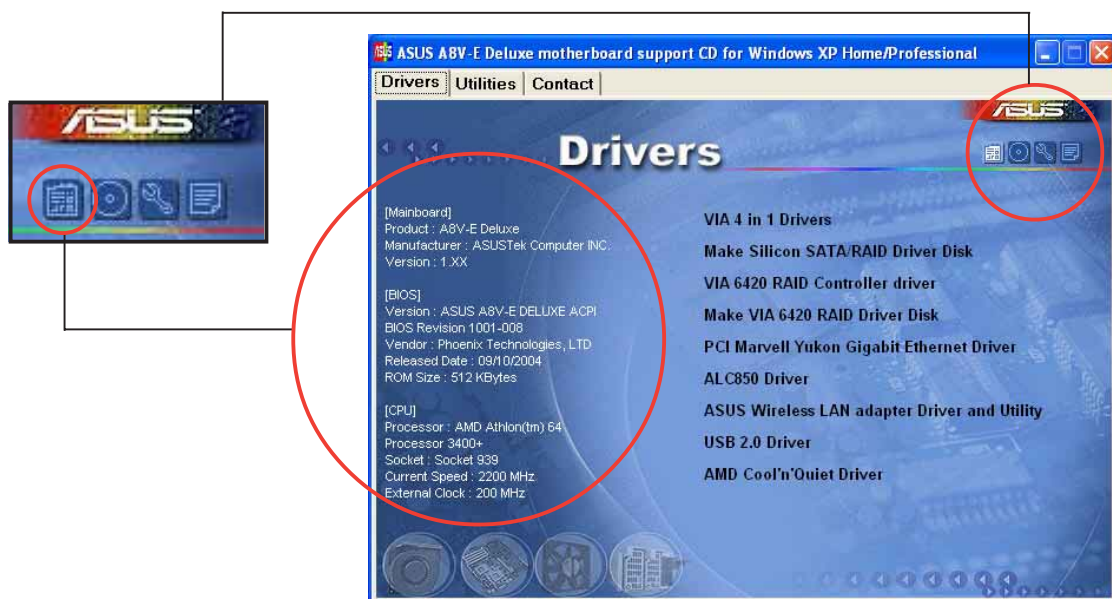



## Browse this CD

Displays the support CD contents in graphical format.

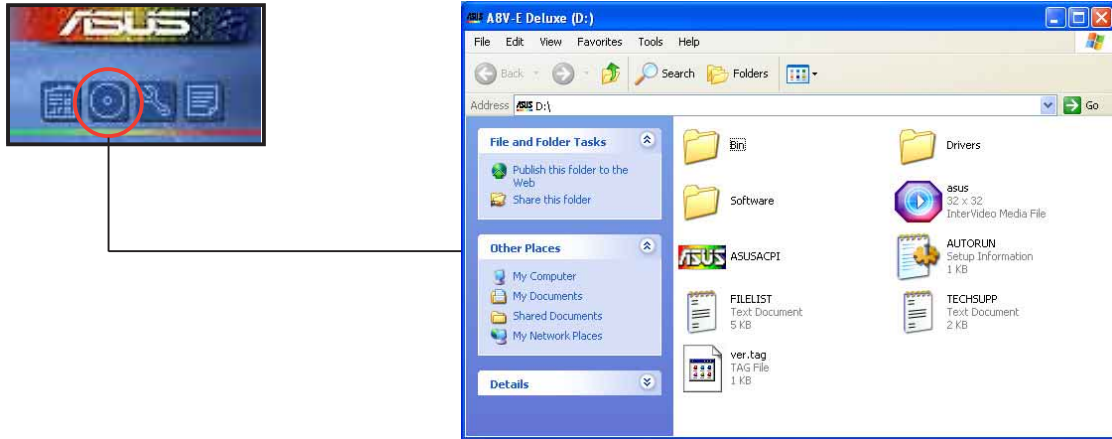

## Technical support Form

Displays the ASUS Technical Support Request Form that you have to fill out when requesting technical support.

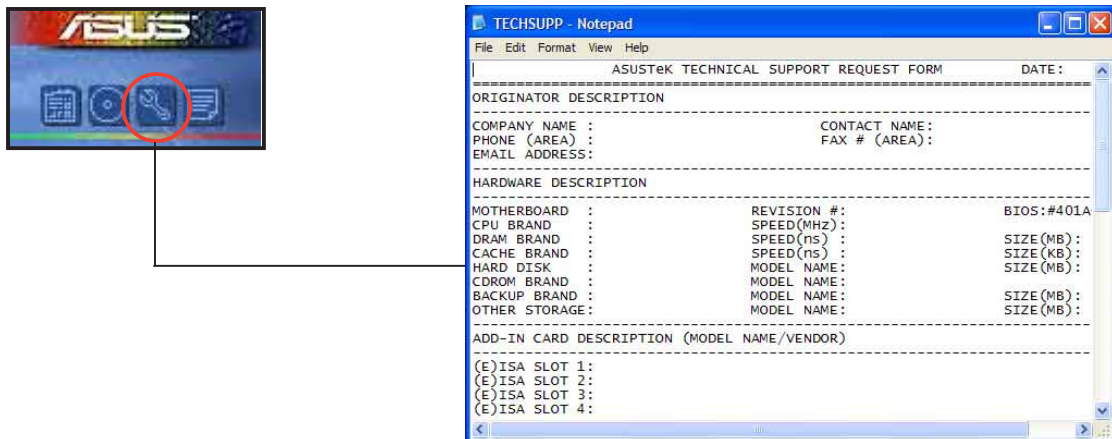

## Filelist

Displays the contents of the support CD and a brief description of each in text format.



```
FILELIST - Notepad
File Edit Format View Help
File list for the included support software for ASB-E Deluxe motherboard
-----
File Name      Description
-----
--Drivers
-AMD
-Cool'n'Quiet  -ASUS cool&quiet driver v1.0.1.7 for windows 98/ME/2000.
                -ASUS cool&quiet driver v1.1.0.14 for windows XP.
-Audio
-ALC850        -ALC850 Avance AC'97 driver and Applications AS.63 WHQL.C98/ME/2000/XP/
-LAN
-8053
-Windows      -Marvell Yukon Gigabit Ethernet v7.14.1.3 for windows 2000/XP/2003. (Wh
-VCT          -Marvell VCT package v2.0.1.3 for 2000/XP/2003.
-Linux        -Marvell Linux driver v7.04.
-UNDI         -Marvell UNDI driver for EF132 v2.02.
-Client_32    -Marvell Yukon client 32 driver v7.03.
-ODI          -Marvell DOS ODI driver v7.04.
-Netware      -Marvell Yukon Netware 4.0 driver v7.03.
                -Marvell Yukon Netware 5.1/6 driver v7.03.
-Unix         -Marvell SCO Unixware 7.1.x driver and openunix 8.0.
```

## 5.3 Software information

Most of the applications in the support CD have wizards that will conveniently guide you through the installation. View the online help or readme file that came with the software application for more information.

### 5.3.1 ASUS MyLogo2™

The ASUS MyLogo2™ utility lets you customize the boot logo. The boot logo is the image that appears on screen during the Power-On Self-Tests (POST). The ASUS MyLogo2™ is automatically installed when you install the **ASUS Update** utility from the support CD. See section “5.2.3 Utilities menu” for details.



- Before using the ASUS MyLogo2™, use the AWDFLASH utility to make a copy of your original BIOS file, or obtain the latest BIOS version from the ASUS website. See section “4.1.2 Updating the BIOS”.
- Make sure that the BIOS item **Full Screen Logo** is set to [Enabled] if you wish to use ASUS MyLogo2. See section “4.6.5 Boot Settings Configuration”.
- You can create your own boot logo image in GIF, JPG, or BMP file formats.

To launch the ASUS MyLogo2™:

1. Launch the ASUS Update utility. Refer to section “4.1.5 ASUS Update utility” for details.
2. Select **Options** from the drop down menu, then click **Next**.
3. Check the option **Launch MyLogo to replace system boot logo before flashing BIOS**, then click **Next**.
4. Select **Update BIOS from a file** from the drop down menu, then click **Next**.
5. When prompted, locate the new BIOS file, then click **Next**. The ASUS MyLogo2 window appears.
6. From the left window pane, select the folder that contains the image you intend to use as your boot logo.



7. When the logo images appear on the right window pane, select an image to enlarge by clicking on it.



8. Adjust the boot image to your desired size by selecting a value on the **Ratio** box.



9. When the screen returns to the ASUS Update utility, flash the original BIOS to load the new boot logo.
10. After flashing the BIOS, restart the computer to display the new boot logo during POST.

## 5.3.2 AI NET 2

The Marvell® Virtual Cable Tester™ (VCT) is a cable diagnostic utility that reports LAN cable faults and shorts using the Time Domain Reflectometry (TDR) technology. The VCT detects and reports open and shorted cables, impedance mismatches, pair swaps, pair polarity problems, and pair skew problems of up to 100 meters at one meter accuracy.

The VCT feature reduces networking and support costs through a highly manageable and controlled network system. This utility can be incorporated in the network systems software for ideal field support as well as development diagnostics.

### Using the Virtual Cable Tester™

To use the the Marvell® Virtual Cable Tester™ utility:

1. Launch the VCT utility from the Windows® desktop by clicking **Start > All Programs > Marvell > Virtual Cable Tester**.
2. Click **Virtual Cable Tester** from the menu to display the screen below.

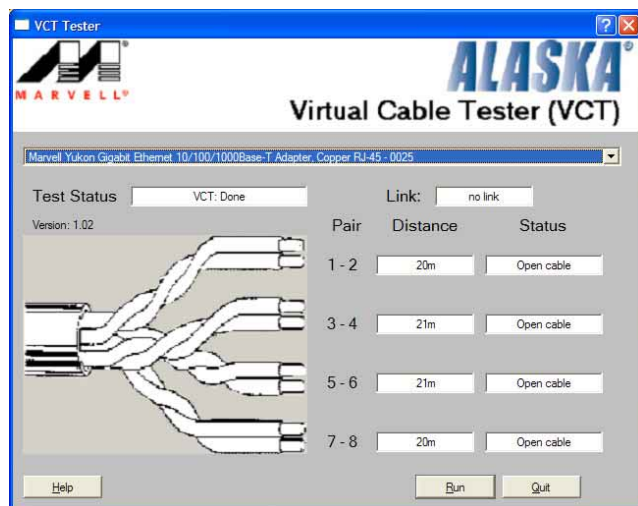

3. Click the **Run** button to perform a cable test.



- The VCT only runs on systems with Windows® XP or Windows® 2000 operating systems.
- The **Run** button on the Virtual Cable Tester™ main window is disabled if no problem is detected on the LAN cable(s) connected to the LAN port(s).
- If you want the system to check the LAN cable before entering the OS, enable the **POST Check LAN cable** item in the BIOS. See section “4.4.7 LAN Cable Status” for details.

### 5.3.3 Audio configurations

The Realtek® ALC850 AC '97 audio CODEC provides 8-channel audio capability to deliver the ultimate audio experience on your PC. The software provides Jack-Sensing function (Line-In, Line-Out, Mic-In), S/PDIF out support and interrupt capability. The ALC850 also includes the Realtek® proprietary UAJ® (Universal Audio Jack) technology for three ports (Line-In, Line-Out and Mic-In), eliminating cable connection errors and giving users plug and play convenience.

Follow the installation wizard to install the **Realtek ALC850 Audio Driver and Application** from the support CD that came with the motherboard package.

If the Realtek audio software is correctly installed, you will find the SoundEffect icon on the taskbar.

From the taskbar, double-click on the **SoundEffect** icon to display the **Realtek Audio Control Panel**.



Realtek SoundEffect icon



The Jack-sensing and UAJ® technology features are supported on the Line-In, Line-Out, and Mic jacks only.

#### Sound Effect options

The Realtek® ALC850 Audio CODEC allows you to set your listening environment, adjust the equalizer, set the karaoke, or select pre-programmed equalizer settings for your listening pleasure.



To set the sound effect options:

1. From the Realtek Audio Control Panel, click the **Sound Effect** button.
2. Click the shortcut buttons to change the acoustic environment, adjust the equalizer, or set the karaoke to your desired settings.
3. The audio settings take effect immediately after you click on the buttons.
4. Click the Exit (**X**) button on the upper-right hand corner of the window to exit.



## S/PDIF option

The Sony/Philips Digital Interface (S/PDIF) options allows you to change your S/PDIF output settings.

To set the S/PDIF options:

1. From the Realtek Audio Control Panel, click the **SPDIF** button.
2. Click the option buttons to change your S/PDIF out settings.
3. Click the Exit (**X**) button on the upper-right hand corner of the window to exit.



## Speaker Configuration

This option allows you to set your speaker configuration.

To set the speaker configuration:

1. From the Realtek Audio Control Panel, click the **Speaker Configuration** button.
2. Select from the combo list box your current speaker setup, then click **Auto Test** to test your settings.
3. Click the **UAJ Automatic** button to enable or disable the Universal Audio Jack(UAJ®) technology feature.
4. Click the Exit (X) button on the upper-right hand corner of the window to exit.





## AI Audio feature

The AI Audio feature works through the connector sensing option that allows you to check if your audio devices are connected properly.

To start the connector sensing:

1. From the Realtek Audio Control Panel, click the **Connector Sensing** button.
2. Click the **Bracket** button to display connected audio devices.
3. Click the **Option** button to change sensing options.
4. Click the **Start** button to start connection sensing. A progress bar displays current connector sensing status.



---

Make sure to exit all audio applications before starting this function.

---



5. When finished, the utility prompts the Realtek® EZ-connection dialog box showing your current audio connections. The text at the bottom of the box explains your audio connection status. An *X* mark denotes an incorrect connection.

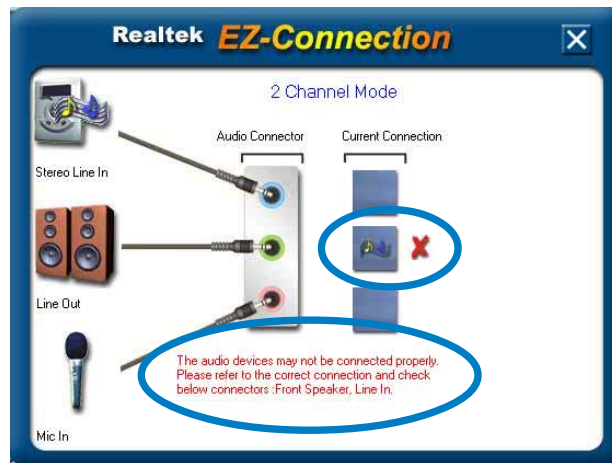

6. If there are detected problems, make sure that your audio cables are connected to the proper audio jack and repeat connector sensing.
7. Click the **X** button to exit EZ-connection dialog box.
8. Click the Exit (**X**) button on the upper-right hand corner of the window to exit audio control panel.

## HRTF Demo

This option shows a demo of the Head-Related Transfer Functions (HRTF).

To start the HRTF demo:

1. From the Realtek Audio Control Panel, click the **HRTF Demo** button.
2. Click the option buttons to change the sound, moving path or EAX settings.
3. Click the **Play** button to start or the **Stop** button to stop.
4. Click the Exit (**X**) button on the upper-right hand corner of the window to exit.



## General settings

This option shows the audio settings and allows you to change the language setting or toggle the SoundEffect icon display on the Windows taskbar.

To display the general settings:

1. From the Realtek Audio Control Panel, click the **General** button.
2. Click the option button to enable or disable the icon display on the Windows taskbar.
3. Click the **Language** combo list box to change language display.
4. Click the Exit (X) button on the upper-right hand corner of the window to exit.



## Rear panel audio ports function variation

The functions of the Line Out (lime), Line In (blue), Mic (pink), Rear Speaker Out (gray), Side Speaker Out (black), and Center/Subwoofer (yellow orange) ports on the rear panel change when you select the 4-channel, 6-channel or 8-channel audio configurations. See the 8, 6, 4 or 2-channel speaker configuration on page 2-23.

## 5.4 RAID configurations

The motherboard comes with the VIA VT8237R Southbridge RAID controller that allows you to configure Serial ATA hard disk drives as RAID sets. The motherboard supports the following RAID configurations.

**RAID 0** (*Data striping*) optimizes two identical hard disk drives to read and write data in parallel, interleaved stacks. Two hard disks perform the same work as a single drive but at a sustained data transfer rate, double that of a single disk alone, thus improving data access and storage. Use of two new identical hard disk drives is required for this setup.

**RAID 1** (*Data mirroring*) copies and maintains an identical image of data from one drive to a second drive. If one drive fails, the disk array management software directs all applications to the surviving drive as it contains a complete copy of the data in the other drive. This RAID configuration provides data protection and increases fault tolerance to the entire system. Use two new drives or use an existing drive and a new drive for this setup. The new drive must be of the same size or larger than the existing drive.



---

If you want to boot the system from a hard disk drive included in a RAID set, copy first the RAID driver from the support CD to a floppy disk before you install an operating system to a selected hard disk drive. Refer to section “5.5 Creating a RAID driver disk” for details.

---

### 5.4.1 Installing hard disks

The motherboard supports Serial ATA hard disk drives. For optimal performance, install identical drives of the same model and capacity when creating a disk array.

#### Installing Serial ATA (SATA) hard disks

To install the SATA hard disks for a RAID configuration:

1. Install the SATA hard disks into the drive bays.
2. Connect the SATA signal cables.
3. Connect a SATA power cable to the power connector on each drive.

## 5.4.2 VIA RAID configurations

The motherboard includes a high performance IDE RAID controller integrated in the VIA VT8237R southbridge chipset. It supports RAID 0 and RAID 1 with two independent Serial ATA channels.

### Entering VIA Tech RAID BIOS Utility

1. Boot-up your computer.
2. During POST, press <Tab> to enter VIA RAID configuration utility. The following menu options will appear.



The RAID BIOS information on the setup screen shown below is for reference only. What you see on your screen may not exactly match what is shown here.

```
VIA Tech. RAID BIOS Ver 1.xx

▶ Create Array
▶ Delete Array
▶ Create/Delete Spare
▶ Select Boot Array
▶ Serial Number View

Create a RAID array with
the hard disks attached to
VIA RAID controller

F1 : View Array/Disk Status
↑,↓ : Move to next item
Enter : Confirm the selection
ESC : Exit

Channel      Drive Name   Array Name Mode  Size(GB) Status
Serial_Ch0 Master XXXXXXXXXXXX  ARRAY 0  SATA  999.99  XXXXXXXX
Serial_Ch1 Master XXXXXXXXXXXX  ARRAY 0  SATA  999.99  XXXXXXXX
```

On the upper-right side of the screen is the message and legend box. The keys on the legend box allows you to navigate through the setup menu options. The message describes the function of each menu item. The following lists the keys found in the legend box with their corresponding functions.

<F1> : View Array/Disk Status  
↑, ↓ : Move to the next item  
<Enter> : Confirm the selection  
<ESC> : Exit

## Create Array

1. From the VIA RAID BIOS utility main menu, select **Create Array** then press **<Enter>**. The main menu items on the upper-left corner of the screen are replaced with create array menu options.

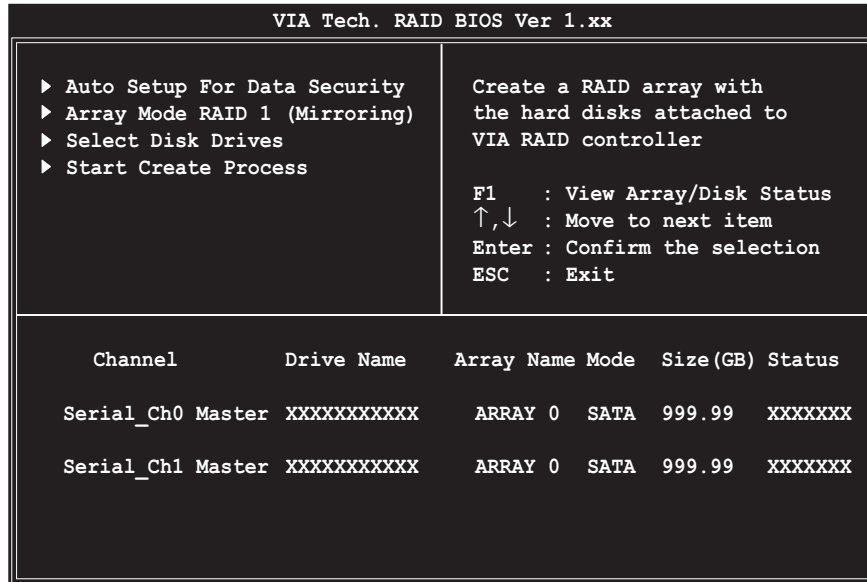

## RAID 0 for performance

1. From the create array menu, select **Array Mode**, then press **<Enter>**. The supported RAID configurations appear on a pop-up menu.

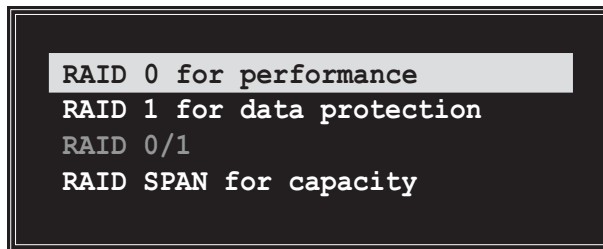

2. Select **RAID 0 for performance** then press **<Enter>**.  
From this point, you may choose to auto-configure the RAID array by selecting **Auto Setup for Performance** or manually configure the RAID array for striped sets. If you want to auto-configure, proceed to the next step, otherwise, skip to step 5.
3. Select **Auto Setup for Performance** and press **<Enter>**. The following confirmation message appears.

```
Auto create array will destroy all
data on disks, Continue? (Y/N)
```

4. Press <Y> to confirm or <N> to return to the configuration options. If you selected <Y>, proceed to step 9.
5. Select **Select Disk Drives**, then press <Enter>. Use arrow keys to select disk drive, then press <Enter> to mark selected drive. An asterisk appears before a selected drive.
6. Select **Block Size**, then press <Enter> to set array block size. A list of valid array block sizes are displayed on a pop-up menu.



**TIP:** For server systems, use of a lower array block size is recommended. For multimedia computer systems used mainly for audio and video editing, a higher array block size is recommended for optimum performance.

Use arrow keys to move selection bar on items and press <Enter> to select.

7. Select **Start Create Process** and press <Enter> to set up hard disk for RAID system. The following confirmation message appears:

The data on the selected disks will be destroyed. Continue? (Y/N)

8. Press <Y> to confirm or <N> to return to the configuration options.
9. Press <Esc> to go back to main menu.

### ***RAID 1 for data protection***

1. From the create array menu, select **Array Mode**, then press <Enter>. The supported RAID configurations appear on a pop-up menu.

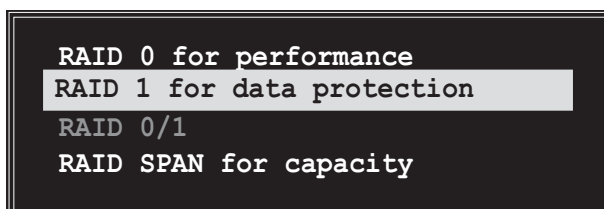

2. Select **RAID 1 for data protection** then press <Enter>.

3. From this point, you can auto-configure the RAID array by selecting **Auto Setup for Data Security** or manually configure the RAID array for mirrored sets. If you want to auto-configure, proceed to the next step, otherwise, skip to step 6.
4. Select **Auto Setup for Data Security** and press <Enter>. The following confirmation message appears.

```
Auto create array will destroy all
data on disks, Continue? (Y/N)
```

5. Press <Y> to confirm or <N> to return to the configuration options. If you selected <Y>, proceed to step 11.
6. Select **Select Disk Drives**, then press <Enter>. Use arrow keys to select disk drive/s, then press <Enter>. An asterisk appears before a selected drive.
7. Select **Start Create Process** and press <Enter> to setup hard disk for RAID system. The following inquiry appears:

```
Save the data on source disk to
mirror after creation? (Y/N)
```

8. If you select <Y> the utility will duplicate your data. Press <Y> anytime if you want to exit the duplication process.

```
Duplicating...
Press Yes(Y) to Escape
```

9. If you select <N>, the following confirmation message appears.

```
The data on the selected disks will
be destroyed. Continue? (Y/N)
```

10. Press <Y> to confirm or <N> to return to the configuration options.
11. Press <Esc> to go back to main menu.



## ***RAID Span for capacity***

1. From the create array menu, select **Array Mode**, then press <Enter>. The supported RAID configurations appear on a pop-up menu.

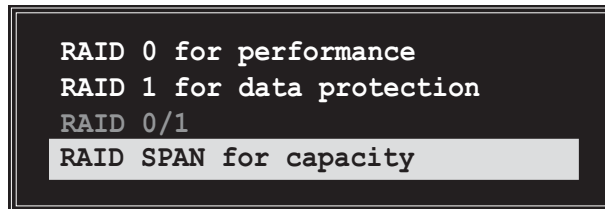

2. Select **RAID SPAN for capacity** then press <Enter>.
3. From this point, you can auto-configure the RAID array by selecting **Auto Setup for Capacity** or manually configure the RAID array for spanned sets. If you want to auto-configure, continue with next step; otherwise, proceed to step 6.
4. Select **Auto Setup for Capacity** and press <Enter>. The following confirmation message appears.

Auto create array will destroy all data on disks, Continue? (Y/N)

5. Press <Y> to confirm or <N> to return to the configuration options. If you selected <Y>, proceed to step 11.
6. Select **Select Disk Drives**, then press <Enter>. Use arrow keys to select disk drive/s, then press <Enter>. An asterisk appears before a selected drive.
7. Select **Start Create Process** and press <Enter> to start RAID system setup. The following inquiry appears:

Save the data on Span 0 disk after creation? (Y/N)

8. If you select <Y>, the utility will save your disk data on Span 0 disk then configure the RAID set. Proceed to step 11.
9. If you select <N>, the following confirmation message appears.

The data on the selected disks will be destroyed. Continue? (Y/N)

10. Press <Y> to confirm or <N> to return to the configuration options.
11. Press <Esc> to go back to main menu.

## Delete Array

1. From the VIA RAID BIOS utility main menu, select **Delete Array** then press <Enter>.

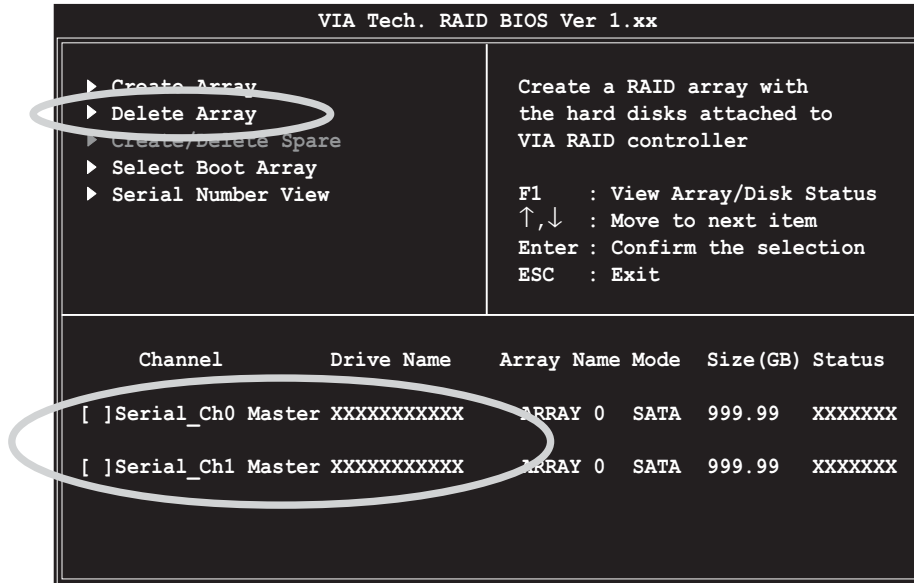

2. From the list of channel used for IDE RAID arrays, press <Enter> to select a RAID array to delete. The following confirmation message appears.

```
The selected array will be destroyed.
Are you sure? Continue? Press Y/N
```

3. Press <Y> to confirm or <N> to return to the configuration options.

## Select Boot Array

1. From the VIA RAID BIOS utility main menu, select **Select Boot Array** then press <Enter>.
2. From the list of channel used for IDE RAID arrays, press <Enter> to select a RAID array for boot. After selection, the **Status** of the selected array will change to Boot.
3. Press <ESC> to return to the menu items. Follow the same procedure to deselect the the boot array.

## Serial Number View

1. From the VIA RAID BIOS utility main menu, select **Serial Number View** then press <Enter>.
2. From the list of channel used for IDE RAID arrays, use the arrow keys to move the selection bar on each item. The serial number for the selected drive is displayed at the bottom of the screen.



---

This option is useful for identifying same model disks.

---

```
VIA Tech. RAID BIOS Ver 1.xx

▶ Create Array
▶ Delete Array
▶ Create/Delete Spare
▶ Select Root Array
▶ Serial Number View

Create a RAID array with
the hard disks attached to
VIA RAID controller

F1 : View Array/Disk Status
↑,↓ : Move to next item
Enter : Confirm the selection
ESC : Exit

Channel      Drive Name      Array Name Mode  Size(GB) Status
Serial_Ch0 Master XXXXXXXXXXXX  ARRAY 0  SATA  999.99  XXXXXXXX
Serial_Ch1 Master XXXXXXXXXXXX  ARRAY 0  SATA  999.99  XXXXXXXX

Serial Number: XXXXXXXX
```

## 5.5 Creating a RAID driver disk

A floppy disk with the RAID driver is required when installing Windows® 2000/XP operating system on a hard disk drive that is included in a RAID set.

To create a RAID driver disk:

1. Place the motherboard support CD into the CD-ROM drive.
2. When the **Drivers** menu appears, click **Make VIA 6420 RAID Driver Disk** to create a VIA RAID driver disk

Or

Browse the contents of the support CD to locate the driver disk utility and go to **\Drivers\VIARAID\6420RAID** for the VIA RAID driver disk utility



---

Refer to section “5.2.2 Drivers menu” for details.

---

3. Insert floppy disk to floppy disk drive.
5. Follow succeeding screen information to complete process.
6. Write-protect the floppy disk to avoid computer virus infection.

To install the RAID driver:

1. During the OS installation, the system prompts you to press the F6 key to install third-party SCSI or RAID driver.
2. Press <F6> then insert the floppy disk with RAID driver into the floppy disk drive.
3. Follow the succeeding screen instructions to complete the installation.

## 5.6 Cool 'n' Quiet!™ Technology

The motherboard supports the AMD Cool 'n' Quiet!™ Technology that dynamically and automatically change the CPU speed, voltage, and amount of power depending on the task the CPU performs.

### 5.6.1 Enabling Cool 'n' Quiet!™ Technology

To enable Cool 'n' Quiet!™ Technology:

1. Turn on the system and enter BIOS by pressing the <Del> key during the Power On Self-Tests (POST).
2. In the **Advanced > CPU Configuration > AMD CPU Cool & Quiet Configuration** menu, select the item **Cool N'Quiet** and set it to **Enabled**. See section "4.4 Advanced Menu" in the user guide.
3. In the **Power** menu, select the item **ACPI 2.0 Support** and set it to **Yes**. See section "4.5 Power Menu" in the user guide.
4. Save your changes and exit BIOS Setup.
5. Reboot your computer and set your Power Option Properties depending on your operating system.

### Windows® 2000/XP

1. From the Windows® 2000/XP operating system, click the **Start** button. Select **Settings**, then **Control Panel**.
2. Make sure the Control Panel is set to Classic View.
3. Double-click the **Display** icon in the Control Panel then select the **Screen Saver** tab.
4. Click the **Power...** button. The following dialog box appears.
5. From the **Power schemes** combo list box, select **Minimal Power Management**.
6. Click **OK** to effect settings.

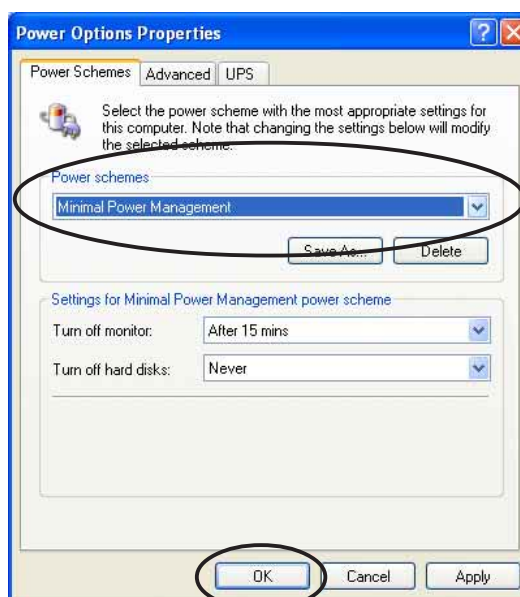

Make sure to install the Cool 'n' Quiet!™ driver and application before using this feature.

## 5.6.2 Launching the Cool 'n' Quiet!™ software

The motherboard support CD includes the Cool 'n' Quiet!™ software that enables you to view your system's real-time CPU Frequency and voltage.



Make sure to install the Cool 'n' Quiet!™ software from the motherboard support CD. Refer to section "5.2.3 Utilities menu", for details.

To launch the Cool 'n' Quiet!™ program:

1. If you are using Windows® 2000, click the **Start** button. Select **Programs > ASUS > Cool & Quiet > Cool & Quiet**.
2. If you are using Windows® XP, click the **Start** button. Select **All Programs > ASUS > Cool & Quiet > Cool & Quiet**.
3. The Cool 'n' Quiet!™ technology screen appears and displays the current CPU Frequency and CPU Voltage.

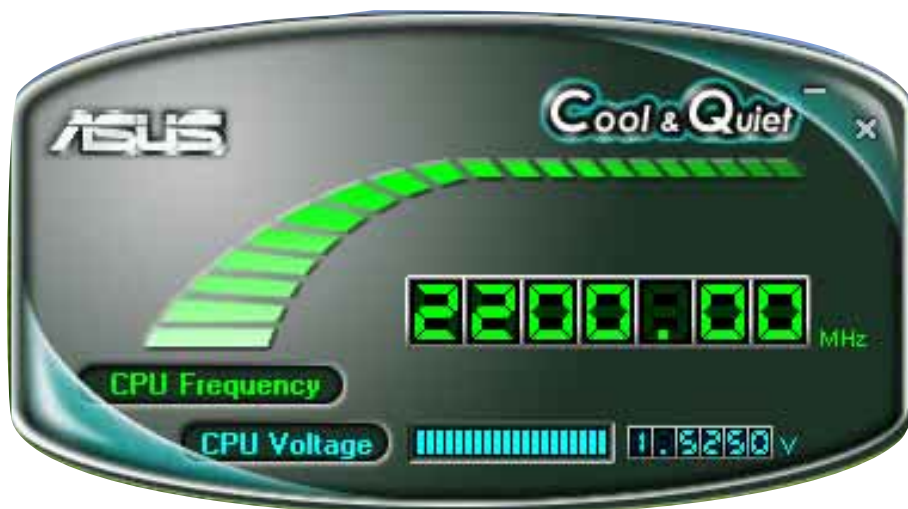

## Free Manuals Download Website

<http://myh66.com>

<http://usermanuals.us>

<http://www.somanuals.com>

<http://www.4manuals.cc>

<http://www.manual-lib.com>

<http://www.404manual.com>

<http://www.luxmanual.com>

<http://aubethermostatmanual.com>

Golf course search by state

<http://golfingnear.com>

Email search by domain

<http://emailbydomain.com>

Auto manuals search

<http://auto.somanuals.com>

TV manuals search

<http://tv.somanuals.com>