



P4S800D-X

User Guide

Motherboard

E1753

First Edition

September 2004

Copyright © 2004 ASUSTeK COMPUTER INC. All Rights Reserved.

No part of this manual, including the products and software described in it, may be reproduced, transmitted, transcribed, stored in a retrieval system, or translated into any language in any form or by any means, except documentation kept by the purchaser for backup purposes, without the express written permission of ASUSTeK COMPUTER INC. ("ASUS").

Product warranty or service will not be extended if: (1) the product is repaired, modified or altered, unless such repair, modification or alteration is authorized in writing by ASUS; or (2) the serial number of the product is defaced or missing.

ASUS PROVIDES THIS MANUAL "AS IS" WITHOUT WARRANTY OF ANY KIND, EITHER EXPRESS OR IMPLIED, INCLUDING BUT NOT LIMITED TO THE IMPLIED WARRANTIES OR CONDITIONS OF MERCHANTABILITY OR FITNESS FOR A PARTICULAR PURPOSE. IN NO EVENT SHALL ASUS, ITS DIRECTORS, OFFICERS, EMPLOYEES OR AGENTS BE LIABLE FOR ANY INDIRECT, SPECIAL, INCIDENTAL, OR CONSEQUENTIAL DAMAGES (INCLUDING DAMAGES FOR LOSS OF PROFITS, LOSS OF BUSINESS, LOSS OF USE OR DATA, INTERRUPTION OF BUSINESS AND THE LIKE), EVEN IF ASUS HAS BEEN ADVISED OF THE POSSIBILITY OF SUCH DAMAGES ARISING FROM ANY DEFECT OR ERROR IN THIS MANUAL OR PRODUCT.

SPECIFICATIONS AND INFORMATION CONTAINED IN THIS MANUAL ARE FURNISHED FOR INFORMATIONAL USE ONLY, AND ARE SUBJECT TO CHANGE AT ANY TIME WITHOUT NOTICE, AND SHOULD NOT BE CONSTRUED AS A COMMITMENT BY ASUS. ASUS ASSUMES NO RESPONSIBILITY OR LIABILITY FOR ANY ERRORS OR INACCURACIES THAT MAY APPEAR IN THIS MANUAL, INCLUDING THE PRODUCTS AND SOFTWARE DESCRIBED IN IT.

Products and corporate names appearing in this manual may or may not be registered trademarks or copyrights of their respective companies, and are used only for identification or explanation and to the owners' benefit, without intent to infringe.

Contents

Notices	v
Safety information	v
About this guide	vi
P4S800D-X specification summary	vii

Chapter 1: Product introduction

1.1	Welcome!	1-2
1.2	Package contents	1-2
1.3	Special features	1-2
1.4	Before you proceed	1-4
1.5	Motherboard overview	1-5
1.5.1	Motherboard layout	1-5
1.5.2	Placement direction	1-6
1.5.3	Screw holes	1-6
1.6	Central Processing Unit (CPU)	1-6
1.6.1	Overview	1-6
1.6.2	Installing the CPU	1-7
1.7	System memory	1-8
1.7.1	DIMM sockets location	1-8
1.7.2	Memory configurations	1-8
1.7.3	Installing a DIMM	1-9
1.8	Expansion slots	1-10
1.8.1	Standard interrupt assignments	1-10
1.8.2	IRQ assignments for this motherboard	1-10
1.8.3	PCI slots	1-11
1.8.4	AGP slot	1-11
1.9	Jumpers	1-12
1.10	Connectors	1-14
1.10.1	Rear panel connectors	1-14
1.10.2	Internal connectors	1-15

Chapter 2: BIOS information

2.1	Managing and updating your BIOS	2-2
2.1.1	Creating a bootable floppy disk	2-2
2.1.2	Using AFUDOS to copy the current BIOS	2-3
2.1.3	Using AFUDOS to update the BIOS	2-3
2.1.4	Using ASUS EZ Flash to update the BIOS	2-5
2.1.5	Recovering the BIOS with CrashFree BIOS 2	2-6
2.2	BIOS Setup program	2-8
2.2.1	BIOS menu screen	2-9
2.2.2	Menu bar	2-9
2.2.3	Navigation keys	2-9
2.2.4	Menu items	2-10

Contents

2.2.5	Sub-menu items	2-10
2.2.6	Configuration fields	2-10
2.2.7	Pop-up window	2-10
2.2.8	Scroll bar	2-10
2.2.9	General help	2-10
2.3	Main menu	2-11
2.3.1	System Time	2-11
2.3.2	System Date	2-11
2.3.3	Legacy Diskette A	2-11
2.3.4	Primary and Secondary IDE Master/Slave	2-12
2.3.5	OnChip SATA Controller	2-13
2.3.6	System Information	2-13
2.4	Advanced menu	2-14
2.4.1	JumperFree Configuration	2-14
2.4.2	CPU Configuration	2-15
2.4.3	Chipset	2-16
2.4.4	Onboard Devices Configuration	2-18
2.4.5	PCI PnP	2-19
2.4.6	USB Configuration	2-20
2.4.7	Instant Music Configuration	2-21
2.5	Power menu	2-22
2.5.1	Suspend Mode	2-22
2.5.2	Repost Video on S3 Resume	2-22
2.5.3	ACPI 2.0 Support	2-22
2.5.4	ACPI APIC Support	2-22
2.5.5	APM Configuration	2-23
2.5.6	Hardware Monitor	2-24
2.6	Boot menu	2-25
2.6.1	Boot Device Priority	2-25
2.6.3	Removable Drives	2-26
2.6.4	Boot Settings Configuration	2-26
2.6.2	Hard Disk Drives	2-26
2.6.5	Security	2-28
2.7	Exit menu	2-30

Chapter 3: Software support

3.1	Install an operating system	3-2
3.2	Support CD information	3-2
3.2.1	Running the support CD	3-2
3.2.2	Drivers menu	3-3
3.2.3	Utilities menu	3-3
3.2.4	ASUS Contact Information	3-4
3.3	ASUS Instant Music Lite	3-5

Notices

Federal Communications Commission Statement

This device complies with Part 15 of the FCC Rules. Operation is subject to the following two conditions:

- This device may not cause harmful interference, and
- This device must accept any interference received including interference that may cause undesired operation.



The use of shielded cables for connection of the monitor to the graphics card is required to assure compliance with FCC regulations. Changes or modifications to this unit not expressly approved by the party responsible for compliance could void the user's authority to operate this equipment.

Canadian Department of Communications Statement

This digital apparatus does not exceed the Class B limits for radio noise emissions from digital apparatus set out in the Radio Interference Regulations of the Canadian Department of Communications.

This class B digital apparatus complies with Canadian ICES-003.

Safety information

Electrical safety

- To prevent electrical shock hazard, disconnect the power cable from the electrical outlet before relocating the system.
- When adding or removing devices to or from the system, ensure that the power cables for the devices are unplugged before the signal cables are connected. If possible, disconnect all power cables from the existing system before you add a device.
- Before connecting or removing signal cables from the motherboard, ensure that all power cables are unplugged.
- Seek professional assistance before using an adapter or extension cord. These devices could interrupt the grounding circuit.
- Make sure that your power supply is set to the correct voltage in your area. If you are not sure about the voltage of the electrical outlet you are using, contact your local power company.
- If the power supply is broken, do not try to fix it by yourself. Contact a qualified service technician or your retailer.

Operation safety

- Before installing the motherboard and adding devices on it, carefully read all the manuals that came with the package.
- Before using the product, make sure all cables are correctly connected and the power cables are not damaged. If you detect any damage, contact your dealer immediately.
- To avoid short circuits, keep paper clips, screws, and staples away from connectors, slots, sockets and circuitry.
- Avoid dust, humidity, and temperature extremes. Do not place the product in any area where it may become wet.
- Place the product on a stable surface.
- If you encounter technical problems with the product, contact a qualified service technician or your retailer.

About this guide

Conventions used in this guide

To make sure that you perform certain tasks properly, take note of the following symbols used throughout this manual.



WARNING: Information to prevent injury to yourself when trying to complete a task.



CAUTION: Information to prevent damage to the components when trying to complete a task.



IMPORTANT: Information that you **MUST** follow to complete a task.



NOTE: Tips and additional information to aid in completing a task.

Where to find more information

Refer to the following sources for additional product information:

1. ASUS Websites

The ASUS websites provide updated information on ASUS hardware and software products. The ASUS websites are listed in the ASUS Contact Information on the inside front cover.

2. Optional Documentation

Your product package may include optional documentation, such as warranty flyers, that may have been added by your dealer. These documents are not part of the standard package.

P4S800D-X specification summary

CPU	Socket 478 for Intel® Pentium® 4 / Celeron processors Supports Intel® Hyper-Threading Technology
Chipset	SIS 655FX SIS 964
Front Side Bus (FSB)	800/533/400 MHz
Memory	4 x 184-pin DDR DIMM sockets for up to 4GB memory Supports PC3200/PC2700/PC2100/PC1600 unbuffered non-ECC DDR DIMMs Dual-channel memory architecture
Expansion slots	1 x AGP 8X/4X (1.5V only) 5 x PCI
Storage	2 x UltraDMA 133/100 2 x Serial ATA with RAID 0, 1 function
Audio	ADI AD1888 SoundMAX 6-channel audio CODEC S/PDIF out interface
LAN	Integrated 10/100 Ethernet controller with Realtek LAN PHY
Special features	ASUS EZ Flash ASUS CrashFree BIOS2 ASUS Instant Music Lite ASUS MyLogo2
Overclock Features	ASUS JumperFree ASUS C.P.R. (CPU Parameter Recall) CPU, Memory, and AGP voltage adjustable SFS (Stepless Frequency Selection) from 100MHz up to 300MHz at 1MHz increment Adjustable FSB/DDR ratio, fixed AGP/PCI frequencies
Rear panel I/O	1 x Parallel port 1 x Serial port 1 x PS/2 keyboard port 1 x PS/2 mouse port 1 x S/PDIF out port 1 x RJ-45 port 4 x USB 2.0/1.1 ports Line In/Line Out/Microphone ports

(continued on the next page)

P4S800D-X specification summary

Internal I/O connectors	CPU/Power/Chassis FAN connectors 20-pin ATX power connector 4-pin ATX 12V power connector Chassis Intrusion GAME/MIDI connector CD/AUX audio in Front panel audio connector 2 x USB 2.0 connector supports additional 4 USB 2.0 ports 2 x Serial ATA ports
BIOS features	4Mb Flash ROM, ASUS JumperFree, AMI BIOS, PnP, DMI2.0, WfM2.0, SM BIOS 2.3, ASUS EZ Flash, ASUS MyLogo2, ASUS CrashFree BIOS2, ASUS C.P.R., ASUS Instant Music Lite
Industry standard	PCI 2.2, USB 2.0/1.1
Manageability	WfM2.0, DMI2.0, WOR, WOL, Chassis intrusion
Form Factor	ATX form factor: 12 in x 9.6 in (30.5 cm x 24.5 cm)
Support CD contents	Device drivers ASUS PC Probe ASUS LiveUpdate Trend Micro™ PC-cillin 2004 anti-virus software

* Specifications are subject to change without notice.

Chapter 1

This chapter describes the features of the P4S800D-X motherboard. It includes brief descriptions of the motherboard components, and illustrations of the layout, jumper settings, and connectors.

Product introduction

1.1 Welcome!

Thank you for buying the ASUS® P4S800D-X motherboard!

The ASUS P4S800D-X motherboard, based on the SIS 655FX chipset, is the first SIS platform supporting 800MHz FSB and dual-channel DDR 400 that delivers a host of new features and latest technologies making it another standout in the long line of ASUS quality motherboards!

Before you start installing the motherboard, and hardware devices on it, check the items in your package with the list below.

1.2 Package contents

Check your P4S800D-X package for the following items.

- ✓ ASUS P4S800D-X motherboard
ATX form factor: 12 in x 9.6 in (30.5 cm x 24.5 cm)
- ✓ ASUS P4S800D-X series support CD
- ✓ 2 x Serial ATA cable
- ✓ 80-conductor UltraATA IDE cable
- ✓ Ribbon cable for a 3.5-inch floppy drive
- ✓ I/O shield
- ✓ Bag of extra jumper caps
- ✓ User Guide



If any of the above items is damaged or missing, contact your retailer.

1.3 Special features

Latest processor technology

The motherboard supports the latest Intel® Pentium® 4 Processor via a 478-pin surface mount ZIF socket. The Pentium 4 processor with 512KB L2 cache on 0.13 micron processor includes a 800/533/400 MHz system bus, Intel® Hyper-Threading Technology and the FMB2 power design that allows up to 3.2+ GHz core frequencies for up to 6.4GB/s data transfer rates. See page 1-6.

Dual Channel DDR memory support

Employing the Double Data Rate (DDR) memory technology, the P4S800D-X motherboard supports up to 4GB of system memory using PC3200/PC2700/PC2100/PC1600 DDR DIMMs. The ultra-fast 400MHz memory bus delivers the required bandwidth for the latest 3D graphics, multimedia, and Internet applications. See page 1-8.

SiS® HyperStreaming Architecture



The SiS® 655FX integrates the latest HyperStreaming Engine which greatly improves computer system performance. The HyperStreaming Engine smartly manages the data streaming to flow smoothly from the peripherals to the core logic chipsets between the North and South bridge to the Front Side Bus, memory and graphic interface.

Serial ATA solution with RAID 0, RAID 1 support



The motherboard supports two interfaces compliant to the Serial ATA (SATA) specification, an evolutionary replacement of the Parallel ATA storage interface. The Serial ATA specification allows for thinner, more flexible cables with lower pin count, reduced voltage requirement, up to 150 MB/s data transfer rate, and software compatibility with legacy Parallel ATA. With the integrated controller in the SIS 964 chipset, the motherboard supports RAID0, RAID1 configuration using SATA drives. See pages 1-19.

CrashFree BIOS 2

This feature allows you to restore the original BIOS data from a floppy disk or support CD in case when the BIOS codes and data are corrupted. This protection eliminates the need to buy a replacement ROM chip.

AGP 8X support

AGP 8X (AGP 3.0) is the next generation VGA interface specification that enables enhanced graphics performance with high bandwidth speeds up to 2.12 GB/s. With a bus of 533Mhz, AGP 8X is twice as fast as AGP 4X.

8 USB 2.0 ports

The motherboard implements the new Universal Serial Bus (USB) 2.0 specification, extending the connection speed from 12 Mbps on USB 1.1 to a fast 480 Mbps on USB 2.0. The higher bandwidth of USB 2.0 allows connection of devices such as high resolution video conferencing cameras, next generation scanners and printers, and fast storage units. USB 2.0 is backward compatible with USB 1.1. See page 1-17.

6-channel digital audio

The ADI AD1888 SoundMAX AC '97 audio CODEC is onboard to provide 6-channel audio playback for 5.1 surround sound, and over 90dB dynamic range.

ASUS MyLogo2™



This new feature present in the P4S800D-X motherboard allows you to personalize and add style to your system with customizable boot logos. See details on page 2-27.

S/PDIF out

The motherboard supports S/PDIF out function that turns your computer into a high-end entertainment system with digital connectivity to powerful sound systems.

C.P.R. (CPU Parameter Recall)

The C.P.R. feature of the motherboard BIOS allows automatic re-setting to the BIOS default settings in case the system hangs due to overclocking. When the system hangs due to overclocking, C.P.R. eliminates the need to open the system chassis and clear the RTC data. Simply shut down and reboot the system, and BIOS automatically restores the CPU's previous setting for each parameter.

ASUS EZ Flash BIOS

With the ASUS EZ Flash, you can easily update the system BIOS even before loading the operating system. No need to use a DOS-based utility or boot from a floppy disk. See page 2-5.

ASUS Instant Music Lite

This unique feature allows you to playback audio files even before entering the operating system. Just press the ASUS Instant Music special function keys and enjoy the music! See page 2-21.

1.4 Before you proceed

Take note of the following precautions before you install motherboard components or change any motherboard settings.



Before you install or remove any component, ensure that the ATX power supply is switched off or the power cord is detached from the power supply. Failure to do so may cause severe damage to the motherboard, peripherals, and/or components.

Onboard LED

The motherboard comes with a stand-by power LED. When lit, the green LED indicates that the system is ON, in sleep mode, or in soft-off mode, a reminder that you should shut down the system and unplug the power cable before removing or plugging in any motherboard component. The illustration below shows the location of the onboard LED.

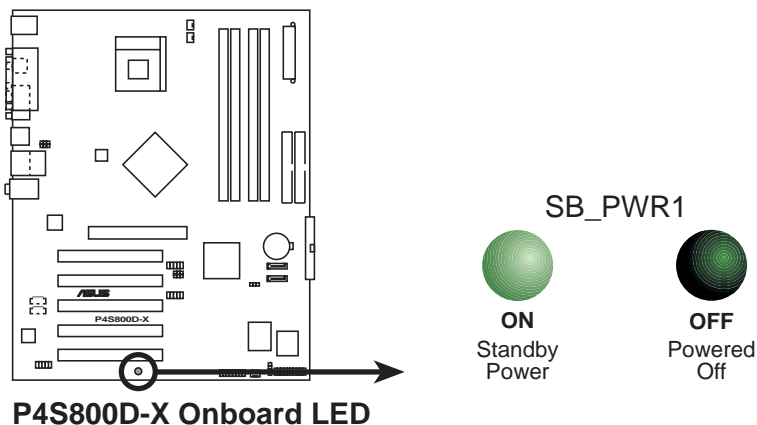

1.5 Motherboard overview

1.5.1 Motherboard layout

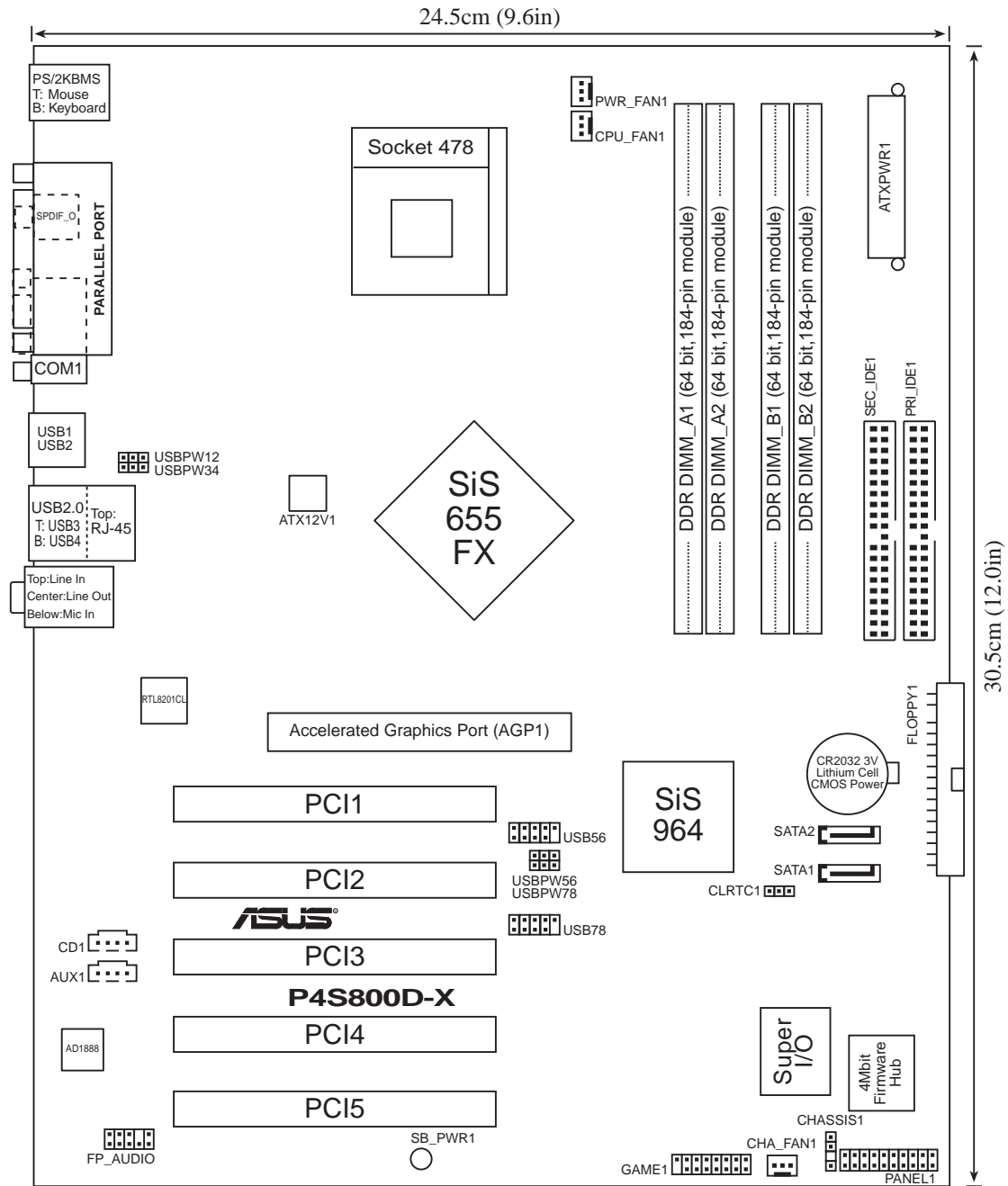

1.5.2 Placement direction

When installing the motherboard, make sure that you place it into the chassis in the correct orientation. The edge with external ports goes to the rear part of the chassis as indicated in the image below.

1.5.3 Screw holes

Place nine (9) screws into the holes indicated by circles to secure the motherboard to the chassis.



Do not overtighten the screws! Doing so may damage the motherboard.

Place this side towards the rear of the chassis

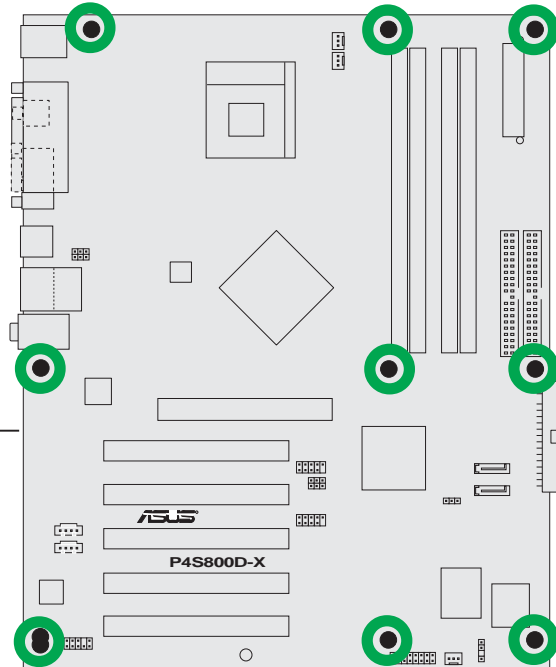

1.6 Central Processing Unit (CPU)

1.6.1 Overview

The Intel® Pentium® 4 processor has a gold triangular mark on one corner. This mark indicates the processor Pin 1 that should match a specific corner of the CPU socket.

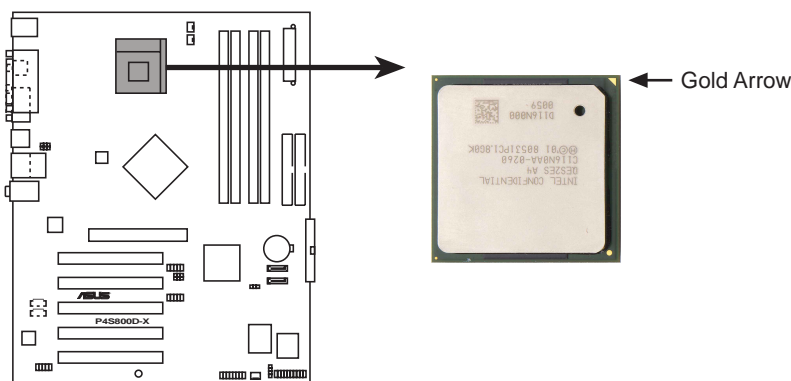

P4S800D-X CPU Socket 478



Incorrect installation of the CPU into the socket may bend the pins and severely damage the CPU!

1.6.2 Installing the CPU

Follow these steps to install a CPU.

1. Locate the 478-pin ZIF socket on the motherboard.
2. Unlock the socket by pressing the lever sideways, then lift it up to a 90°-100° angle.



Make sure that the socket lever is lifted up to 90°-100° angle, otherwise the CPU does not fit in completely.

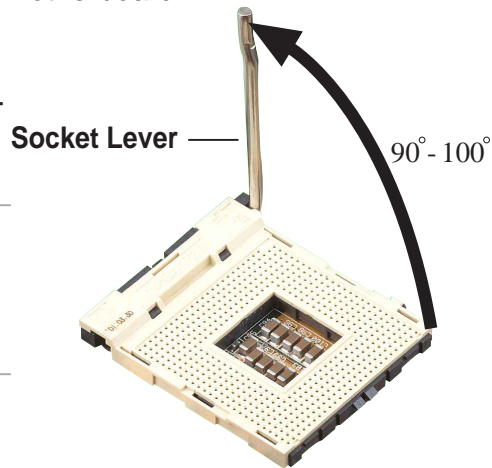

3. Position the CPU above the socket such that its marked corner matches the base of the socket lever.
4. Carefully insert the CPU into the socket until it fits in place.



The CPU fits only in one correct orientation. DO NOT force the CPU into the socket to prevent bending the pins and damaging the CPU!

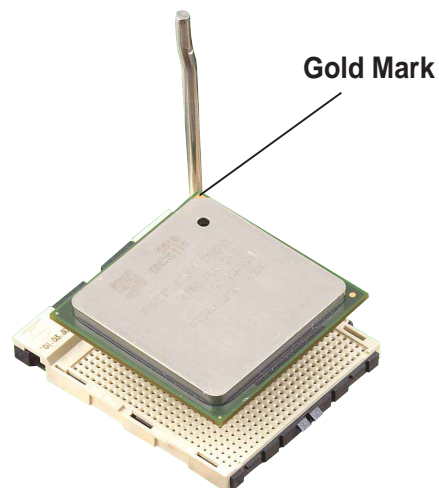

5. When the CPU is in place, push down the socket lever to secure the CPU. The lever clicks on the side tab to indicate that it is locked.
6. Install a CPU heatsink and fan following the instructions that came with the heatsink package.
7. Connect the CPU fan cable to the CPU fan connector on the motherboard.

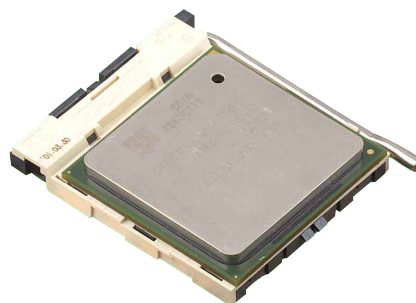

1.7 System memory

1.7.1 DIMM sockets location

The following figure illustrates the location of the DDR DIMM sockets.

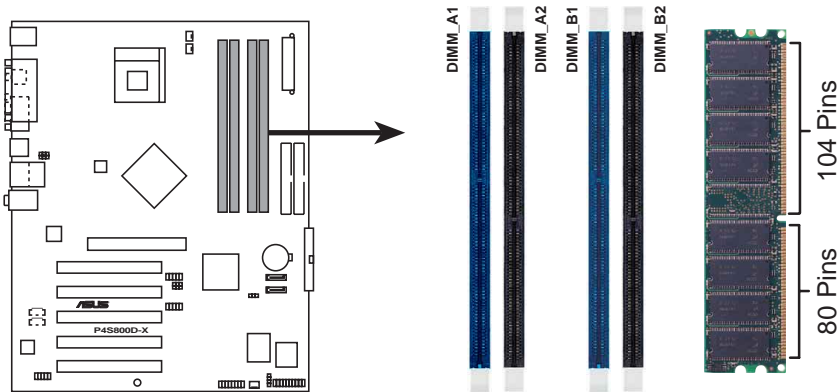

P4S800D-X 184-pin DDR DIMM sockets



1. It is recommended to use the blue DIMM slots first.
2. Make sure to unplug the power supply before adding or removing DIMMs or other system components. Failure to do so may cause severe damage to both the motherboard and the components.
3. When installing long AGP cards, it is recommended to install the memory modules first. Long AGP cards, when installed, may interfere with the memory sockets.

1.7.2 Memory configurations

You may install 64MB, 128MB, 256MB, 512MB, and 1GB DDR DIMMs into the DIMM sockets using the memory configurations in this section.

Important notes



1. Installing DDR DIMMs other than the recommended configurations may cause memory sizing error or system boot failure. Use any of the recommended configurations in Table 1.
2. In dual-channel configurations, always install an **identical** (the same type and size) DDR DIMM pair on sockets of the same color.
3. Always install DIMMs with the same CAS latency. For optimum compatibility, it is recommended that you obtain memory modules from the same vendor.
9. Obtain DDR DIMMs only from ASUS qualified vendors. Visit the ASUS website (www.asus.com) for the latest QVL.

Table 1 Recommended memory configurations

Mode/DIMM Type		Sockets			
		DIMM_A1 (blue)	DIMM_A2 (black)	DIMM_B1 (blue)	DIMM_B2 (black)
Single-channel (PC3200/PC2700/ PC2100/PC1600)	(1)	Populated	—	—	—
	(2)	—	Populated	—	—
	(3)	—	—	Populated	—
	(4)	—	—	—	Populated
Dual-channel (PC3200/PC2700/ PC2100/PC1600)	(1)	Populated	—	Populated	—
	(2)	—	Populated	—	Populated
	(3)*	Populated	Populated	Populated	Populated

* For dual-channel configuration (3), you may:

- install identical DIMMs in all four sockets or
- install identical DIMM pair in DIMM_A1 and DIMM_B1 (blue sockets) and identical DIMM pair in DIMM_A2 and DIMM_B2 (black sockets)

Table 2 DDR400 Qualified Vendors List

Size	Vendor	Part No.	Brand	Side(s)	Chip Number
256MB	KINGSTON	KVR400X64C3A/256	Hynix	SS	HY5DU56822BT-D43
512MB	KINGSTON	KVR400X64C3A/512	Hynix	DS	HY5DU56822BT-D43
256MB	KINGSTON	KVR400X64C3A/256	Infineon	SS	HYB25D256800BT-5B
512MB	KINGSTON	KVR400X64C3A/512	Infineon	DS	HYB25D256809BT-5B
256MB	KINGSTON	KVR400X64C3A/256	KINGSTON	SS	D3208DL2T-5
256MB	SAMSUNG	M368L3223ETM-CCC	SAMSUNG	SS	K4H560838E-TCCC
256MB	SAMSUNG	M368L3223FTN-CCC	SAMSUNG	SS	K4H560838F-TCCC
512MB	SAMSUNG	M368L6423FTN-CCC	SAMSUNG	DS	K4H560838F-TCCC
512MB	SAMSUNG	M368L6523BTM-CCC	SAMSUNG	SS	K4H510838B-TCCC
256MB	MICRON	MT8VDDT3264AG-40BCB	MICRON	SS	MT46V32M8TG-5BC
512MB	MICRON	MT16VDDT6464AG-40BCB	MICRON	DS	MT46V32M8TG-5BC
256MB	Infineon	HYS64D32300HU-5-C	Infineon	SS	HYB25D256800CE-5C
512MB	Infineon	HYS64D64320HU-5-C	Infineon	DS	HYB25D256800CE-5C
256MB	CORSAIR	CMX256A-3200C2PT	Winbond	SS	W942508BH-5
256MB	Hynix	HYMD232645D8J-D43	Hynix	SS	HY5DU56822DT-D43
512MB	Hynix	HYMD264646D8J-D43	Hynix	DS	HY5DU56822DT-D43

1.7.3 Installing a DIMM

Follow these steps to install a DIMM.

1. Unlock a DIMM socket by pressing the retaining clips outward.
2. Align a DIMM on the socket such that the notch on the DIMM matches the break on the socket.
3. Firmly insert the DIMM into the socket until the retaining clips snap back in place and the DIMM is properly seated.

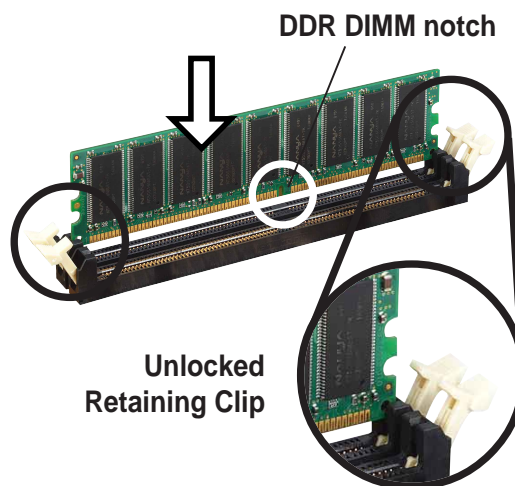

A DDR DIMM is keyed with a notch so that it fits in only one direction. DO NOT force a DIMM into a socket to avoid damaging the DIMM.

1.8 Expansion slots

To install and configure an expansion card:

1. Install an expansion card following the instructions that came with the chassis.
2. Turn on the system and change the necessary BIOS settings, if any. See Chapter 2 for BIOS information.
3. Assign an IRQ to the card. Refer to the tables next page.
4. Install the drivers and/or software applications for the expansion card according to the card documentation.

1.8.1 Standard interrupt assignments

IRQ	Priority	Standard Function
0	1	System Timer
1	2	Keyboard Controller
2	N/A	Programmable Interrupt
3*	11	Communications Port (COM2)
4*	12	Communications Port (COM1)
5*	13	IRQ holder for PCI steering
6	14	Floppy Disk Controller
7*	15	Printer Port (LPT1)
8	3	System CMOS/Real Time Clock
9*	4	IRQ holder for PCI steering
10*	5	Advance AC'97 CODEC
11*	6	Standard PCI Graphics Adapter (VGA)
12*	7	PS/2 Compatible Mouse Port
13	8	Numeric Data Processor
14*	9	Primary IDE Channel
15*	10	Secondary IDE Channel

* These IRQs are usually available for ISA or PCI devices.

1.8.2 IRQ assignments for this motherboard

	A	B	C	D	E	F	G	H
PCI slot 1	shared	—	—	—	—	—	—	—
PCI slot 2	—	shared	—	—	—	—	—	—
PCI slot 3	—	—	shared	—	—	—	—	—
PCI slot 4	—	—	—	shared	—	—	—	—
PCI slot 5	shared	—	—	—	—	—	—	—
AGP slot	shared	—	—	—	—	—	—	—
Onboard USB 1.1/2.0 controller	—	—	—	—	used	used	used	used
Onboard LAN	—	—	—	shared	—	—	—	—
Onboard RAID	—	—	shared	—	—	—	—	—
Onboard Audio	—	—	shared	—	—	—	—	—



When using PCI cards on shared slots, ensure that the drivers support “Share IRQ” or that the cards do not need IRQ assignments. Otherwise, conflicts will arise between the two PCI groups, making the system unstable and the card inoperable.

1.8.3 PCI slots

The PCI slots support PCI cards such as a LAN card, SCSI card, USB card, and other cards that comply with PCI specifications.

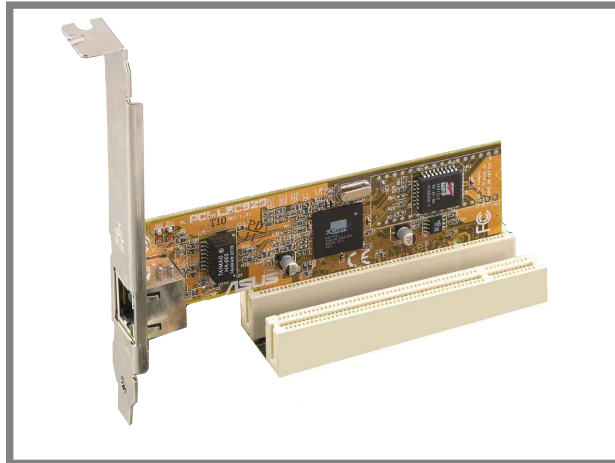

1.8.4 AGP slot

The Accelerated Graphics Port (AGP) slot that supports AGP 8X/4X (+1.5V) cards. When you buy an AGP card, make sure that you ask for one with +1.5V specification.

Note the notches on the card golden fingers to ensure that they fit the AGP slot on the motherboard.



Install only +1.5V AGP cards.

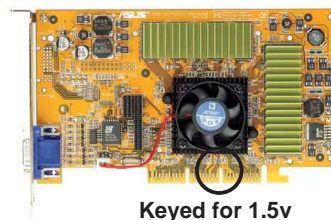
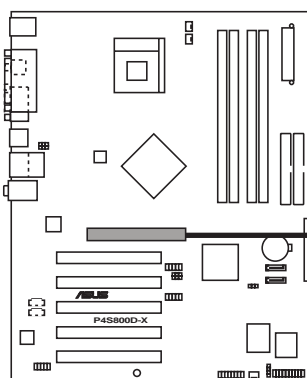

P4S800D-X Accelerated Graphics Port (AGP)

1.9 Jumpers

1. Clear RTC RAM (CLRTC1)

This jumper allows you to clear the Real Time Clock (RTC) RAM in CMOS. You can clear the CMOS memory of date, time, and system setup parameters by erasing the CMOS RTC RAM data. The RAM data in CMOS, that include system setup information such as system passwords, is powered by the onboard button cell battery.

To erase the RTC RAM:

1. Turn OFF the computer and unplug the power cord.
2. Move the jumper cap from pins 1-2 (default) to pins 2-3. Keep the cap on pins 2-3 for about 5~10 seconds, then move the cap back to pins 1-2.
3. Plug the power cord and turn ON the computer.
4. Hold down the key during the boot process and enter BIOS setup to re-enter data.



Except when clearing the RTC RAM, never remove the cap on CLRTC1 jumper default position. Removing the cap will cause system boot failure!

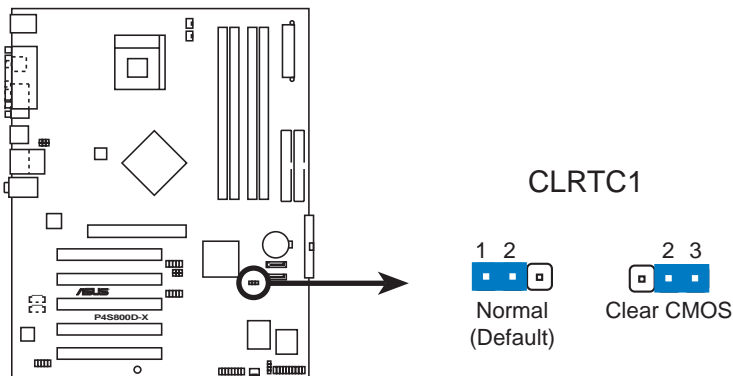

P4S800D-X Clear RTC RAM setting



You do not need to clear the RTC when the system hangs due to overclocking. For system failure due to overclocking, use the C.P.R. (CPU Parameter Recall) feature. Shut down and reboot the system so BIOS can automatically reset parameter settings to default values.

2. USB device wake-up (3-pin USBPW12, USBPW34, USBPW56, USBPW78)

Set these jumpers to +5V to wake up the computer from S1 sleep mode (CPU stopped, DRAM refreshed, system running in low power mode) using the connected USB devices. Set to +5VSB to wake up from S3 sleep mode (no power to CPU, DRAM in slow refresh, power supply in reduced power mode). Both jumpers are set to pins 1-2 (+5V) by default because not all computers have the appropriate power supply to support this feature.

The USBPW12 and USBPW34 jumpers are for the rear USB ports. The USBPW56 and USBPW78 jumpers are for the internal USB header that you can connect to the front USB ports.



1. This feature requires a power supply that can provide at least 1A on the +5VSB lead when these jumpers are set to +5VSB. Otherwise, the system would not power up.
2. The total current consumed must NOT exceed the power supply capability (+5VSB) whether under normal condition or in sleep mode.
3. The rear panel USB ports (Ports 1 to 4) do not support device wake-up from S4 sleep mode.

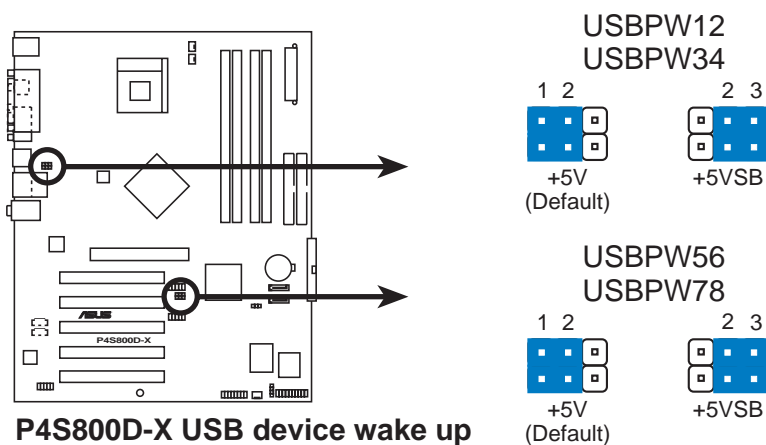

1.10 Connectors

This section describes and illustrates the motherboard rear panel and internal connectors.

1.10.1 Rear panel connectors

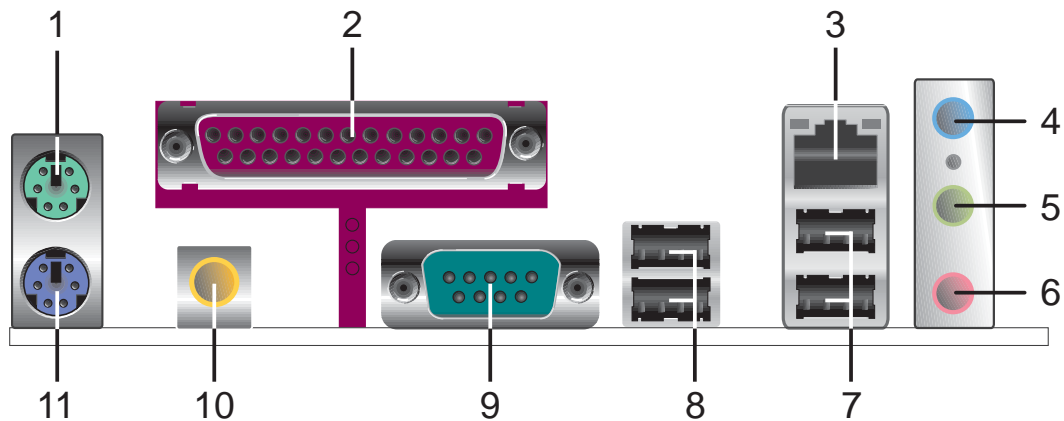

- 1. PS/2 mouse port.** This green 6-pin connector is for a PS/2 mouse.
- 2. Parallel port.** This 25-pin port connects a parallel printer, a scanner, or other devices.
- 3. RJ-45 port.** This port allows connection to a Local Area Network (LAN) through a network hub.
- 4. Line In jack.** This Line In (light blue) jack connects a tape player or other audio sources. In 6-channel mode, the function of this jack becomes Bass/Center.
- 5. Line Out jack.** This Line Out (lime) jack connects a headphone or a speaker. In 6-channel mode, the function of this jack becomes Front Speaker Out.
- 6. Microphone jack.** This Mic (pink) jack connects a microphone. In 6-channel mode, the function of this jack becomes Rear Speaker Out.



The functions of the Line Out, Line In, and Microphone jacks change when you select the 6-channel audio configuration as shown in the following table.

Audio 2, 4 or 6-channel configuration

	Headphone/ 2-Speaker	4-Speaker	6-Speaker
Light Blue	Line In	Line In	Bass/Center
Lime	Line Out	Front Speaker Out	Front Speaker Out
Pink	Mic In	Rear Speaker Out	Rear Speaker Out

- 7. USB 2.0 ports 1 and 2.** These two 4-pin Universal Serial Bus (USB) ports are available for connecting USB 2.0 devices.
- 8. USB 2.0 ports 3 and 4.** These two 4-pin Universal Serial Bus (USB) ports are available for connecting USB 2.0 devices.
- 9. Serial connector.** This 9-pin COM1 port is for serial devices.
- 10. S/PDIF out jack.** This jack connects to external audio output devices.
- 11. PS/2 keyboard port.** This purple connector is for a PS/2 keyboard.

1.10.2 Internal connectors

1. IDE connectors (40-pin PRI_IDE1, SEC_IDE1)

This connector supports the provided UltraATA133 IDE hard disk ribbon cable. Connect the cable's blue connector to the primary (recommended) or secondary IDE connector, then connect the gray connector to the UltraATA133 slave device (hard disk drive) and the black connector to the UltraATA133 master device.



1. Follow the hard disk drive documentation when setting the device in master or slave mode.
2. Pin 20 on each IDE connector is removed to match the covered hole on the UltraATA cable connector. This prevents incorrect orientation when you connect the cables.
3. The hole near the blue connector on the UltraATA cable is intentional.

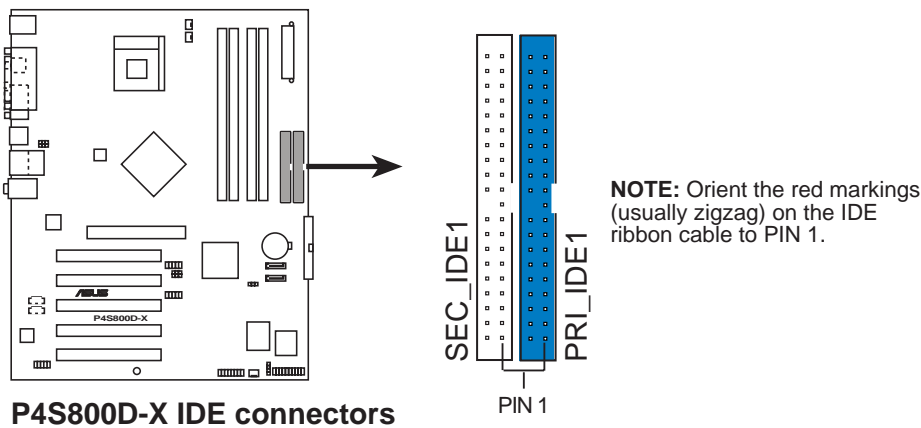

2. Floppy disk drive connector (34-pin FLOPPY1)

This connector supports the provided floppy drive ribbon cable. After connecting one end to the motherboard, connect the other end to the floppy drive. (Pin 5 is removed to prevent incorrect insertion when using ribbon cables with pin 5 plug).

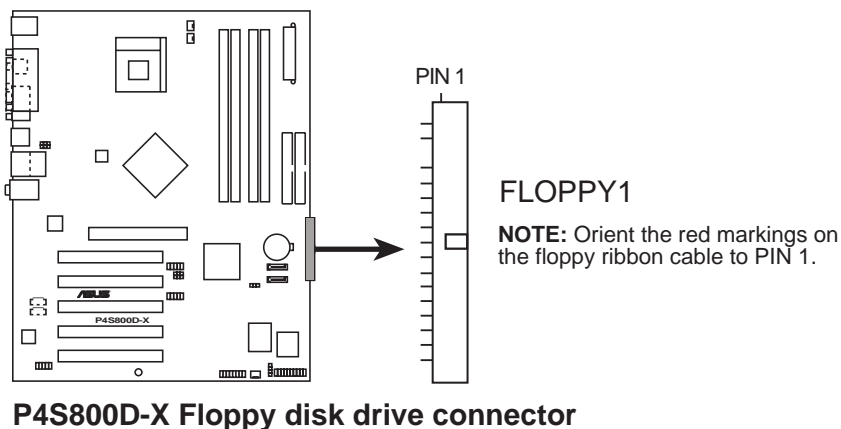

3. ATX power connectors (20-pin ATXPWR1, 4-pin ATX12V1)

These connectors connect to an ATX 12V power supply. The plugs from the power supply are designed to fit these connectors in only one orientation. Find the proper orientation and push down firmly until the connectors completely fit.

In addition to the 20-pin ATX power connector, this motherboard requires that you connect the 4-pin ATX +12V power plug to provide sufficient power to the CPU.



Make sure that your ATX 12V power supply can provide 8A on the +12V lead and at least 1A on the +5-volt standby lead (+5VSB). The minimum recommended wattage is 230W, or 300W for a fully configured system. The system may become unstable and may experience difficulty powering up if the power supply is inadequate.

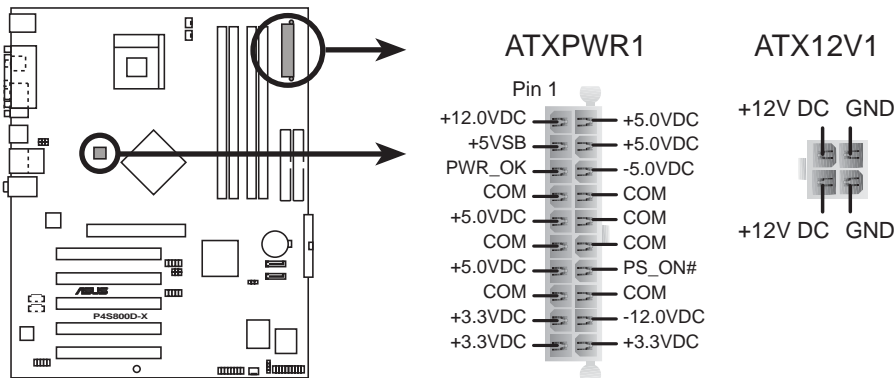

P4S800D-X ATX power connector

4. Internal audio connectors (4-pin CD1, AUX1)

These connectors allow you to receive stereo audio input from sound sources such as a CD-ROM, TV tuner, or MPEG card.

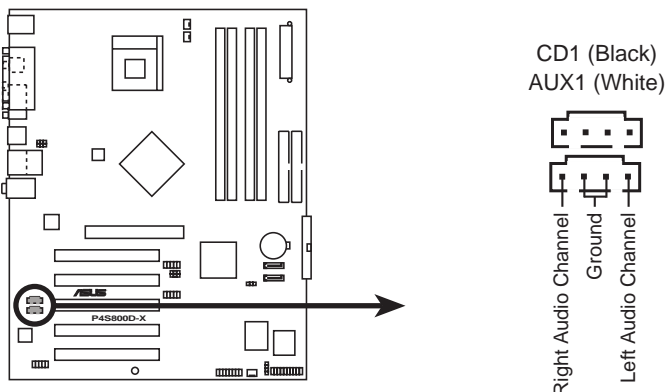

P4S800D-X Internal audio connectors

5. CPU, power and chassis fan connectors (3-pin CPU_FAN1, PWR_FAN1, CHA_FAN1)

The fan connectors support cooling fans of 350mA~740mA (8.88W max.) or a total of 1A~2.22A (26.64W max.) at +12V. Connect the fan cables to the fan connectors on the motherboard, making sure that the black wire of each cable matches the ground pin of the connector.



Do not forget to connect the fan cables to the fan connectors. Lack of sufficient air flow within the system may damage the motherboard components. These are not jumpers! DO NOT place jumper caps on the fan connectors!

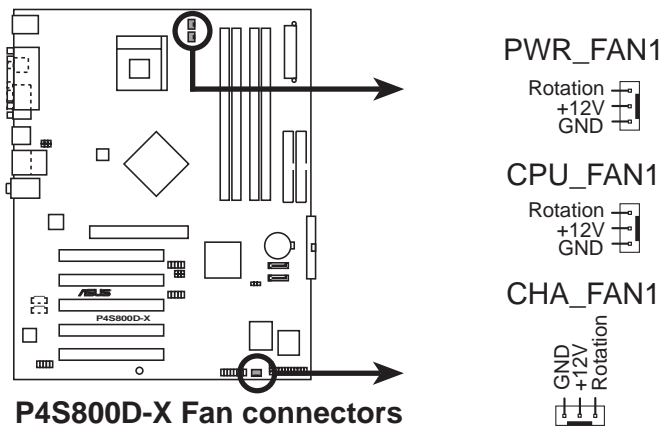

6. USB header (10-1 pin USB56, USB78)

If the USB ports on the rear panel are inadequate, a USB header is available for additional USB ports. Connect the USB cable of the USB 2.0 module to this header. You may install the USB module in the chassis front panel. The module has two USB 2.0 ports for connecting next generation USB peripherals such as high resolution cameras, scanners, and printers.

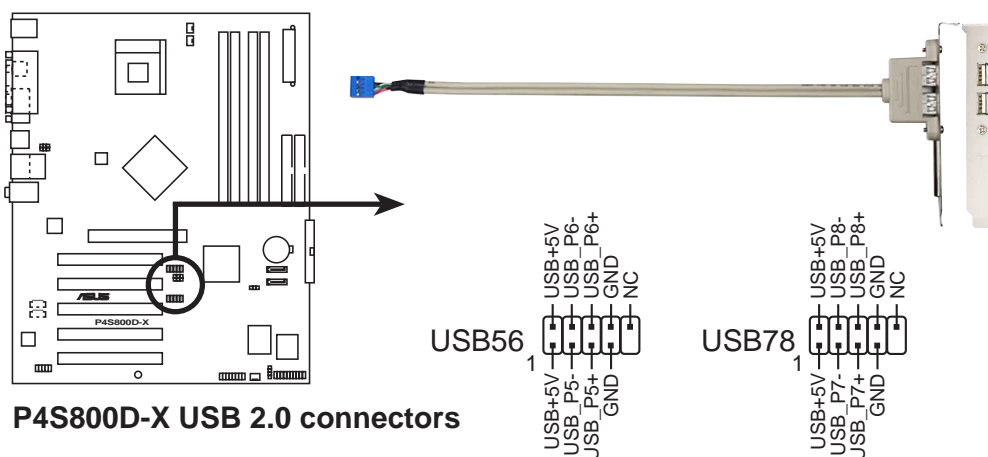

- NEVER connect a **1394 cable** to the connectors. Doing so will damage the motherboard!
- The USB 2.0 module is purchased separately.

7. Front panel audio connector (10-1 pin FP_AUDIO1)

This is an interface for the front panel cable that allows convenient connection and control of audio devices.

By default, the pins labeled LINE OUT_R/BLINE_OUT_R and the pins LINE OUT_L/BLINE_OUT_L are shorted with jumper caps. Remove the caps only when you are connecting the front panel audio cable.

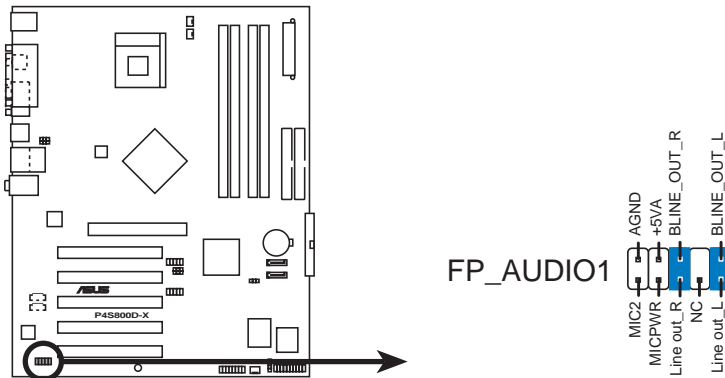

P4S800D-X Front panel audio connector

8. Chassis intrusion connector (4-1 pin CHASSIS1)

This lead is for a chassis designed with intrusion detection feature. This requires an external detection mechanism such as a chassis intrusion sensor or microswitch. When you remove any chassis component, the sensor triggers and sends a high-level signal to this lead to record a chassis intrusion event.

By default, the pins labeled "Chassis Signal" and "Ground" are shorted with a jumper cap. If you wish to use the chassis intrusion detection feature, remove the jumper cap from the pins.

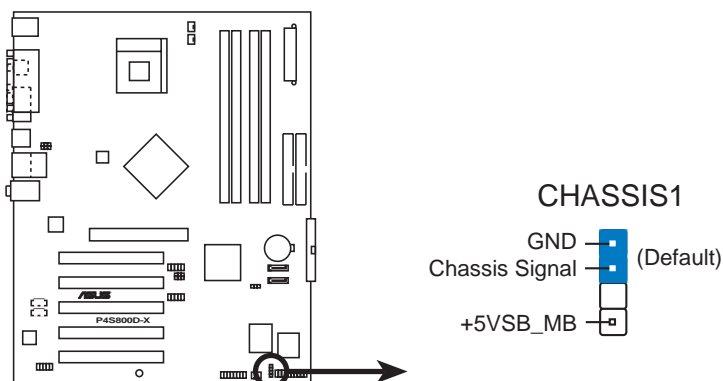

P4S800D-X Chassis intrusion connector

9. GAME/MIDI connector (16-1 pin GAME1)

This connector supports a GAME/MIDI module. If a GAME/MIDI module is available, connect the GAME/MIDI cable to this connector. The GAME/MIDI port on the module connects a joystick or a game pad for playing games, and MIDI devices for playing or editing audio files.

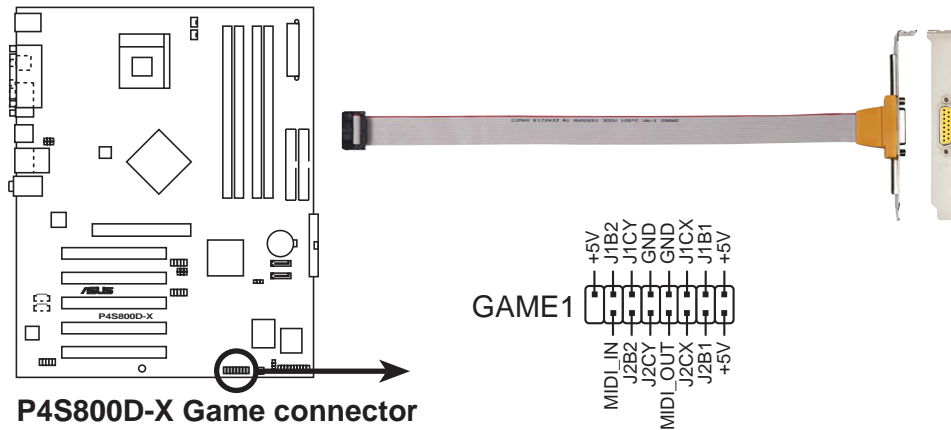

The GAME/MIDI module is purchased separately.

10. Serial ATA connectors (7-pin SATA1, SATA2)

These next generation connectors support the thin Serial ATA cables for primary internal storage devices. The current Serial ATA interface allows up to 150 MB/s data transfer rate, faster than the standard parallel ATA with 133 MB/s (Ultra ATA/133).

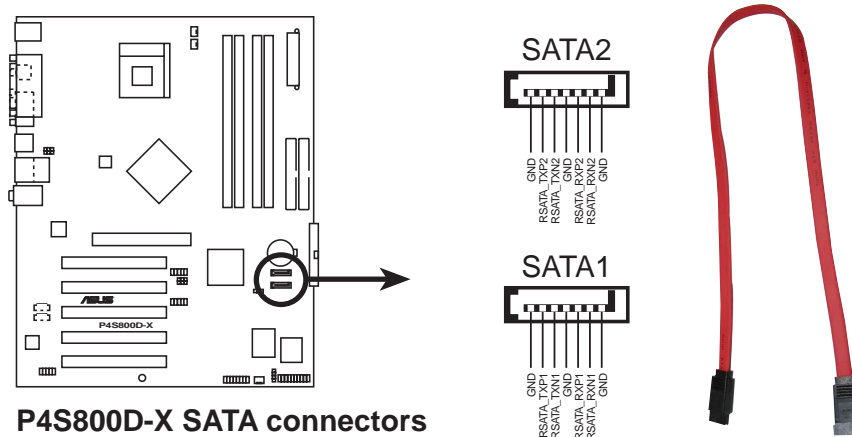

11. System panel connector (10-1 pin F_PANEL1)

This connector accommodates several system front panel functions.

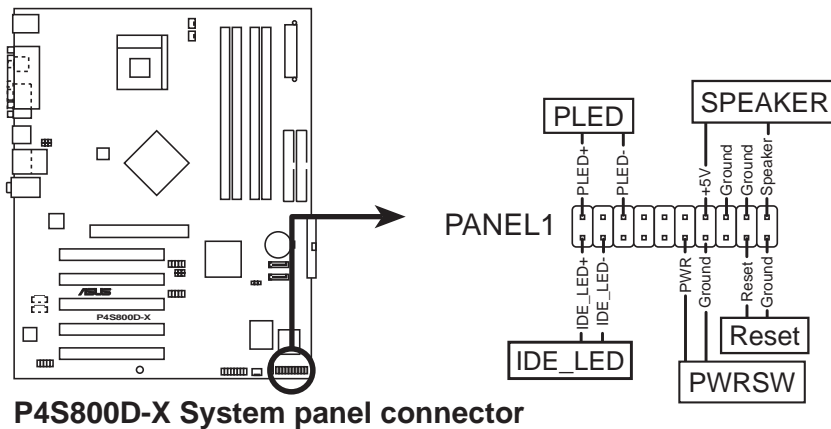

- **System Power LED Lead (Green 3-1 pin PLED)**
This 3-1 pin connector connects to the system power LED. The LED lights up when you turn on the system power, and blinks when the system is in sleep mode.
- **System Warning Speaker Lead (Orange 4-pin SPEAKER)**
This 4-pin connector connects to the case-mounted speaker and allows you to hear system beeps and warnings.
- **ATX Power Switch / Soft-Off Switch Lead (Yellow 2-pin PWRSW)**
This connector connects a switch that controls the system power. Pressing the power switch turns the system between ON and SLEEP, or ON and SOFT OFF, depending on the BIOS or OS settings. Pressing the power switch while in the ON mode for more than 4 seconds turns the system OFF.
- **Reset Switch Lead (Blue 2-pin RESET)**
This 2-pin connector connects to the case-mounted reset switch for rebooting the system without turning off the system power.
- **Hard disk activity LED (Red 2-pin IDE_LED)**
This connector supplies power to the hard disk activity LED. Any read or write activity of an IDE device cause this LED to light up.



The System Panel connector is color-coded for easy and foolproof connection. Take note of the specific connector colors as described.

Chapter 2

This chapter tells how to change system settings through the BIOS Setup menus. Detailed descriptions of the BIOS parameters are also provided.

BIOS information

2.1 Managing and updating your BIOS

The following utilities allow you to manage and update the motherboard Basic Input/Output System (BIOS) setup.

1. **AFUDOS** (Updates the BIOS in DOS mode using a bootable floppy disk.)
2. **ASUS EZ Flash** (Updates the BIOS using a floppy disk during POST.)
3. **CrashFree BIOS 2** (Updates the BIOS using a bootable floppy disk or the support CD when the BIOS gets corrupted.)
4. **ASUS Update** (Updates the BIOS in Windows® environment.)

Refer to the corresponding section for each utility.

Important notes



- It is recommended that you save a copy of the **original motherboard BIOS file** to a **bootable floppy disk** in case you need to restore the BIOS in the future. Copy the original motherboard BIOS using the AFUDOS or the ASUS Update utilities.
- A **working BIOS file** for this motherboard is in the support CD. Use this file only when you do not have a copy of the original motherboard BIOS file in a floppy disk.
- Visit the ASUS website and download the latest BIOS file for this motherboard using the ASUS Update utility.

2.1.1 Creating a bootable floppy disk

1. Do either one of the following to create a bootable floppy disk.

DOS environment

Insert a 1.44 MB floppy disk into the drive. At the DOS prompt, type:

format A:/S then press <Enter>.

Windows® XP environment

- a. Insert a 1.44 MB floppy disk to the floppy disk drive.
- b. Click **Start** from the Windows® desktop, then select **My Computer**.
- c. Select the 3 1/2 Floppy Drive icon.
- d. Click **File** from the menu, then select **Format**. A **Format 3 1/2 Floppy Disk** window appears.
- e. Select **Create an MS-DOS startup disk** from the format options field, then click **Start**.

Windows® 2000 environment

To create a set of boot disks for Windows® 2000:

- a. Insert a formatted, high density 1.44 MB floppy disk into the drive.
- b. Insert the Windows® 2000 CD to the optical drive.

- c. Click **Start**, then select **Run**.
 - d. From the Open field, type
D:\bootdisk\makeboot a:
assuming that D: is your optical drive.
 - e. Press <Enter>, then follow screen instructions to continue.
2. Copy the original or the latest motherboard BIOS file to the bootable floppy disk.

2.1.2 Using AFUDOS to copy the current BIOS

The AFUDOS.EXE utility can also be used to copy the current system BIOS settings to a floppy or hard disk. The copy can be used as a backup in case the system BIOS fails or gets corrupted.

1. At the DOS prompt, type the command line:

afudos /o<filename>

where “filename” can be any user provided filename of not more than eight (8) alpha-numeric characters for the main filename and three (3) alpha-numeric characters for the extension name.

Press the **Enter** key.



The BIOS information on the screen is for reference only. What you see on your screen may not be exactly the same as shown.

Main filename Extension name

```
A:\>afudos /oMYBIOS03.rom
AMI Firmware Update Utility - Version 1.10
Copyright (C) 2002 American Megatrends, Inc. All rights reserved.
Reading flash ..... 0x0008CC00 (9%)
```

2. The utility will copy the current system BIOS by default to the floppy disk. Make sure that the floppy disk is not write-protected and have enough space (at least 600KB) to store the file.

```
A:\>afudos /oMYBIOS03.rom
AMI Firmware Update Utility - Version 1.10
Copyright (C) 2002 American Megatrends, Inc. All rights reserved.
Reading flash ..... done
A:\>
```

When the BIOS copy process is complete, the utility returns to the DOS prompt.

2.1.3 Using AFUDOS to update the BIOS

The AFUDOS is a DOS-based application that lets you update the BIOS file using a bootable floppy diskette. AFUDOS also allows you to copy the original BIOS file to a floppy diskette.

To update the BIOS using the AFUDOS.EXE:

1. Visit the ASUS website (www.asus.com) to download the latest BIOS file for your motherboard. Save the BIOS file to a bootable floppy disk.



Write down the BIOS file name to a piece of paper. You need to type the **exact BIOS file name** at the prompt.

2. Copy the AFUDOS.EXE utility from the support CD to the bootable floppy disk that contains the BIOS file.
3. Boot the system from the floppy disk.
4. At the DOS prompt, type the command line: **afudos /i<filename.rom>** where “filename.rom” means the latest (or original) BIOS file that you copied to the bootable floppy disk.

The screen displays the status of the update process.



The BIOS information on the screen is for reference only. What you see on your screen may not be exactly the same as shown.

```
A:\>afudos /iP4S800DX.ROM
AMI Firmware Update Utility - Version 1.10
Copyright (C) 2002 American Megatrends, Inc. All rights reserved.
Reading file ..... done
Erasing flash .... done
Writing flash .... 0x0008CC00 (9%)
```



DO NOT shutdown or reset the system while updating the BIOS! Doing so may cause system boot failure!

When the BIOS update process is complete, the utility returns to the DOS prompt.

```
A:\>afudos /iP4S800DX.ROM
AMI Firmware Update Utility - Version 1.10
Copyright (C) 2002 American Megatrends, Inc. All rights reserved.
Reading file ..... done
Erasing flash .... done
Writing flash .... 0x0008CC00 (9%)
Verifying flash .. done

A:\>
```

5. Reboot the system from the hard disk.

2.1.4 Using ASUS EZ Flash to update the BIOS

The ASUS EZ Flash feature allows you to easily update the BIOS without having to go through the long process of booting from a floppy disk and using a DOS-based utility. The EZ Flash is built-in the BIOS LPC chip so it is accessible by simply pressing <Alt> + <F2> during the Power-On Self Tests (POST).

To update the BIOS using ASUS EZ Flash:

1. Visit the ASUS website (www.asus.com) to download the latest BIOS file for your motherboard and rename it to **P4S800DX.ROM**. Save the BIOS file to a floppy disk.
2. Reboot the system.
3. To launch EZ Flash, press <Alt> + <F2> during POST to display the following.

```
User recovery requested. Starting BIOS recovery...
Checking for floppy...
```



If there is no floppy disk found in the drive, the error message “**Floppy not found!**” appears.

If the correct BIOS file is not found in the floppy disk, the error message “**P4S800DX.ROM not found!**”

4. Insert the floppy disk that contains the BIOS file. If the **P4S800DX.ROM** file is found in the floppy disk, EZ Flash performs the BIOS update process and automatically reboots the system when done.



DO NOT shutdown or reset the system while updating the BIOS! Doing so may cause system boot failure!

```
User recovery requested. Starting BIOS recovery...
Checking for floppy...
Floppy found!
Reading file "P4S800DX.ROM". Completed.
Start flashing...
Flashed successfully. Rebooting.
```

2.1.5 Recovering the BIOS with CrashFree BIOS 2

The CrashFree BIOS 2 auto recovery tool allows you to restore BIOS from the motherboard support CD, or from a floppy disk that contains the BIOS file, in case the current BIOS on the motherboard fails or gets corrupted.



1. Prepare the **support CD** that came with the motherboard or a **floppy disk that contains the motherboard BIOS** (P4S800DX.ROM) before proceeding with the BIOS update process.
2. If you have saved a copy of the original motherboard BIOS to a bootable floppy disk, you may also use this disk to restore the BIOS. See section "2.1.1 Creating a bootable floppy disk."

To recover the BIOS from a floppy disk:

1. Boot the system.
2. When a corrupted BIOS is detected, the following message appears.

```
Bad BIOS checksum. Starting BIOS recovery...
Checking for floppy...
```

3. Insert a floppy disk that contains the original, or the latest, BIOS file for this motherboard (P4S800DX.ROM). If the BIOS file that you downloaded from the ASUS website has a different filename (e.g. P4S800D2.ROM), rename it to **P4S800DX.ROM**. The BIOS update process continues when the P4S800DX.ROM is found.

```
Bad BIOS checksum. Starting BIOS recovery...
Checking for floppy...
Floppy found!
Reading file "P4S800DX.ROM". Completed.
Start flashing...
```



DO NOT shutdown or reset the system while updating the BIOS! Doing so may cause system boot failure!

4. When the BIOS update process is complete, reboot the system.

To recover the BIOS from the support CD:

1. Boot the system.
2. When a corrupted BIOS is detected, the following screen message appears.

```
Bad BIOS checksum. Starting BIOS recovery...
Checking for floppy...
```



If there is no floppy disk found in the drive, the system automatically checks the CD-ROM.

3. Place the support CD in the CD-ROM. The support CD contains the original BIOS for this motherboard.

```
Bad BIOS checksum. Starting BIOS recovery...
Checking for floppy...
Floppy not found!
Checking for CD-ROM...
CD-ROM found.
Reading file "P4S800DX.ROM". Completed.
Start flashing...
```



DO NOT shutdown or reset the system while updating the BIOS! Doing so may cause system boot failure!

4. When the BIOS update process is complete, reboot the system.



The recovered BIOS may not be the latest BIOS version for this motherboard. Visit the ASUS website (www.asus.com) to download the latest BIOS file.

2.2 BIOS Setup program

This motherboard supports a programmable Low Pin Count (LPC) chip that you can update using the provided utility described in section “2.1 Managing and updating your BIOS.”

Use the BIOS Setup program when you are installing a motherboard, reconfiguring your system, or prompted to “Run Setup”. This section explains how to configure your system using this utility.

Even if you are not prompted to use the Setup program, you may want to change the configuration of your computer in the future. For example, you may want to enable the security password feature or make changes to the power management settings. This requires you to reconfigure your system using the BIOS Setup program so that the computer can recognize these changes and record them in the CMOS RAM of the LPC chip.

The LPC chip on the motherboard stores the Setup utility. When you start up the computer, the system provides you with the opportunity to run this program. Press during the Power-On Self Test (POST) to enter the Setup utility, otherwise, POST continues with its test routines.

If you wish to enter Setup after POST, restart the system by pressing <Ctrl>+<Alt>+<Delete>, or by pressing the reset button on the system chassis. You can also restart by turning the system off and then back on. Do this last option only if the first two failed.

The Setup program is designed to make it as easy to use as possible. It is a menu-driven program, which means you can scroll through the various sub-menus and make your selections among the predetermined choices.



Because the BIOS software is constantly being updated, the following BIOS setup screens and descriptions are for reference purposes only, and may not exactly match what you see on your screen.

2.2.1 BIOS menu screen

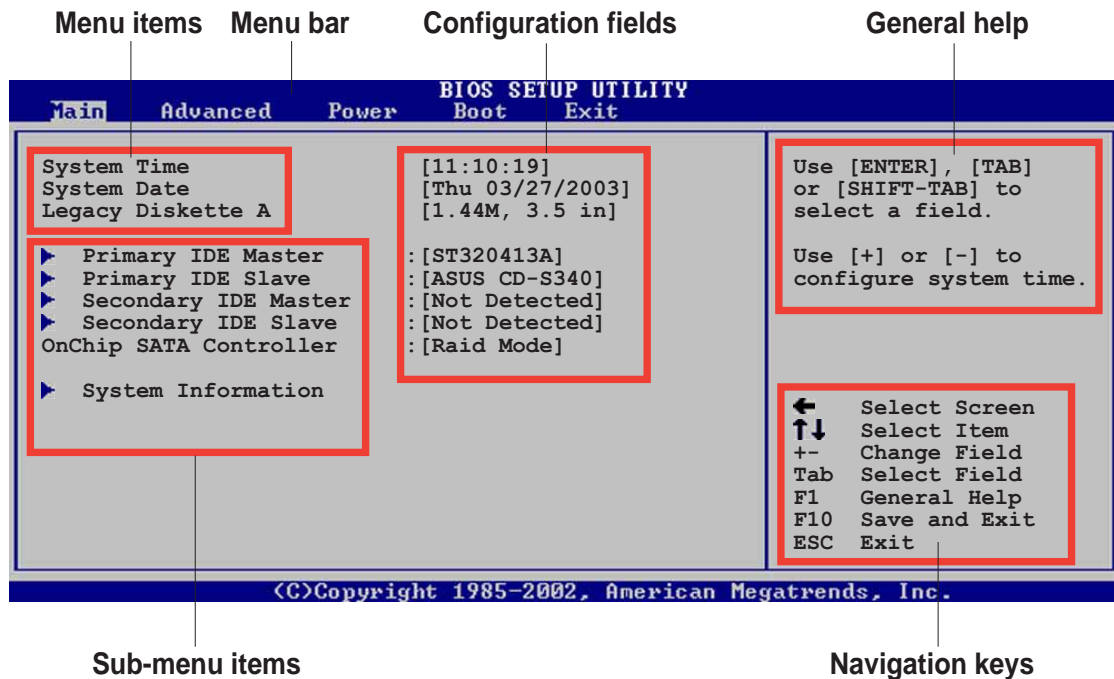

2.2.2 Menu bar

The menu bar on top of the screen has the following main items:

Main	For changing the basic system configuration
Advanced	For changing the advanced system settings
Power	For changing the advanced power management (APM) configuration
Boot	For changing the system boot configuration
Exit	For selecting the exit options and loading default settings

To select an item on the menu bar, press the right or left arrow key on the keyboard until the desired item is highlighted.

2.2.3 Navigation keys

At the **bottom right corner** of a menu screen are the navigation keys for that particular menu. Use the navigation keys to select items in the menu and change the settings.



Some of the navigation keys differ from one screen to another.

2.2.4 Menu items

The highlighted item on the menu bar displays the specific items for that menu. For example, selecting **Main** shows the Main menu items.

The other items (Advanced, Power, Boot, and Exit) on the menu bar have their respective menu items.

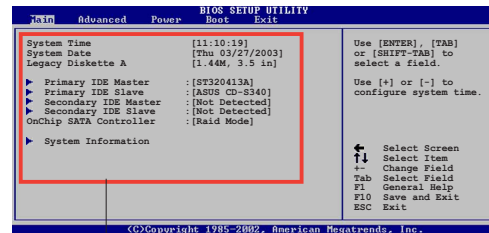

Main menu items

2.2.5 Sub-menu items

An item with a sub-menu on any menu screen is distinguished by a solid triangle before the item. To display the sub-menu, select the item and press Enter.

2.2.6 Configuration fields

These fields show the values for the menu items. If an item is user-configurable, you may change the value of the field opposite the item. You can not select an item that is not user-configurable.

A configurable field is enclosed in brackets, and is highlighted when selected. To change the value of a field, select it then press Enter to display a list of options. Refer to “2.2.7 Pop-up window.”

2.2.7 Pop-up window

Select a menu item then press Enter to display a pop-up window with the configuration options for that item.

2.2.8 Scroll bar

A scroll bar appears on the right side of a menu screen when there are items that do not fit on the screen. Press **Up/Down arrow keys** or **PageUp/PageDown keys** to display the other items on the screen.

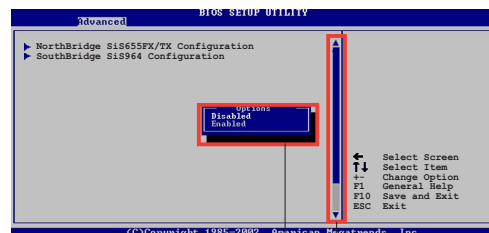

Pop-up window

Scroll bar

2.2.9 General help

At the top right corner of the menu screen is a brief description of the selected item.

2.3 Main menu

When you enter the BIOS Setup program, the Main menu screen appears giving you an overview of the basic system information.



Refer to section “2.2.1 BIOS menu screen” for information on the menu screen items and how to navigate through them.

```
BIOS SETUP UTILITY
Main  Advanced  Power  Boot  Exit

System Time           [11:10:19]
System Date           [Thu 03/27/2003]
Legacy Diskette A     [1.44M, 3.5 in.]

▶ Primary IDE Master   : [ST320413A]
▶ Primary IDE Slave    : [ASUS CD-S340]
▶ Secondary IDE Master : [Not Detected]
▶ Secondary IDE Slave  : [Not Detected]
OnChip SATA Controller : [Raid Mode]

▶ System Information

Use [ENTER], [TAB]
or [SHIFT-TAB] to
select a field.

Use [+] or [-] to
configure system time.

← Select Screen
↑↓ Select Item
+- Change Field
Tab Select Field
F1 General Help
F10 Save and Exit
ESC Exit

(C)Copyright 1985-2002, American Megatrends, Inc.
```

2.3.1 System Time [xx:xx:xxxx]

This item allows you to set the system time.

2.3.2 System Date [Day xx/xx/xxxx]

This item allows you to set the system date.

2.3.3 Legacy Diskette A [1.44M, 3.5 in.]

Sets the type of floppy drive installed. Configuration options: [Disabled]
[360K, 5.25 in.] [1.2M, 5.25 in.] [720K, 3.5 in.] [1.44M, 3.5 in.] [2.88M, 3.5 in.]

2.3.4 Primary and Secondary IDE Master/Slave

While entering Setup, BIOS auto-detects the presence of IDE devices. There is a separate sub-menu for each IDE device. Select a device item then press Enter to display the IDE device information.

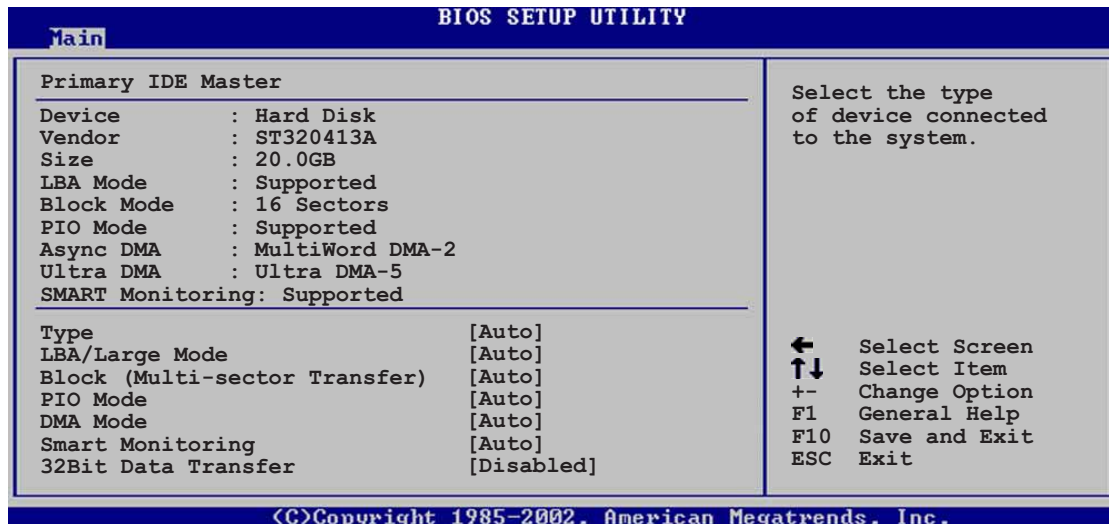

The values opposite the dimmed items (Device, Vendor, Size, LBA Mode, Block Mode, PIO Mode, Async DMA, Ultra DMA, and SMART monitoring) are auto-detected by BIOS and are not user-configurable. These items show N/A if no IDE device is installed in the system.

Type [Auto]

Selects the type of IDE drive. Setting to Auto allows automatic selection of the appropriate IDE device type. Select CDROM if you are specifically configuring a CD-ROM drive. Select ARMD (ATAPI Removable Media Device) if your device is either a ZIP, LS-120, or MO drive.

Configuration options: [Not Installed] [Auto] [CDROM] [ARMD]

LBA/Large Mode [Auto]

Enables or disables the LBA mode. Setting to Auto enables the LBA mode if the device supports this mode, and if the device was not previously formatted with LBA mode disabled. Configuration options: [Disabled] [Auto]

Block (Multi-sector Transfer) [Auto]

Enables or disables data multi-sectors transfers. When set to Auto, the data transfer from and to the device occurs multiple sectors at a time if the device supports multi-sector transfer feature. When set to Disabled, the data transfer from and to the device occurs one sector at a time.

Configuration options: [Disabled] [Auto]

PIO Mode [Auto]

Selects the PIO mode. Configuration options: [Auto] [0] [1] [2] [3] [4]

DMA Mode [Auto]

Selects the DMA mode. Configuration options: [Auto] [SWDMA0] [SWDMA1] [SWDMA2] [MWDMA0] [MWDMA1] [MWDMA2] [UDMA0] [UDMA1] [UDMA2] [UDMA3] [UDMA4] [UDMA5]

SMART Monitoring [Auto]

Sets the Smart Monitoring, Analysis, and Reporting Technology. Configuration options: [Auto] [Disabled] [Enabled]

32Bit Data Transfer [Disabled]

Enables or disables 32-bit data transfer. Configuration options: [Disabled] [Enabled]

2.3.5 OnChip SATA Controller [Enabled]

This field allows you to enable or disable the onchip Serial ATA controller. Configuration options: [Disabled] [Enabled]

2.3.6 System Information

This menu gives you an overview of the general system specifications. The items in this menu are auto-detected by BIOS.

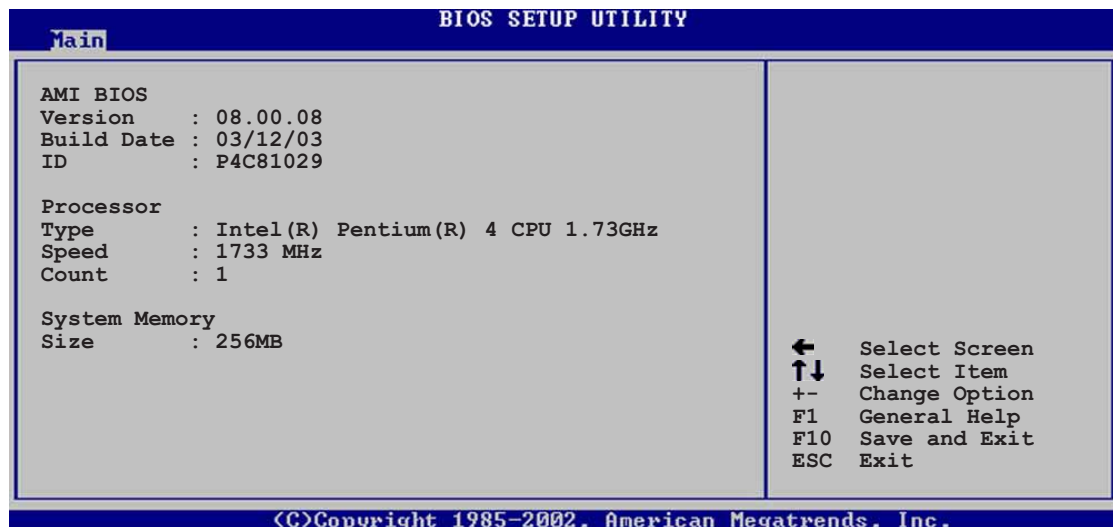

AMI BIOS

This item displays the auto-detected BIOS information.

Processor

This item displays the auto-detected CPU specification.

System Memory

This item displays the auto-detected system memory.

2.4 Advanced menu

The Advanced menu items allow you to change the settings for the CPU and other system devices.



Take caution when changing the settings of the Advanced menu items. Incorrect field values may cause the system to malfunction.

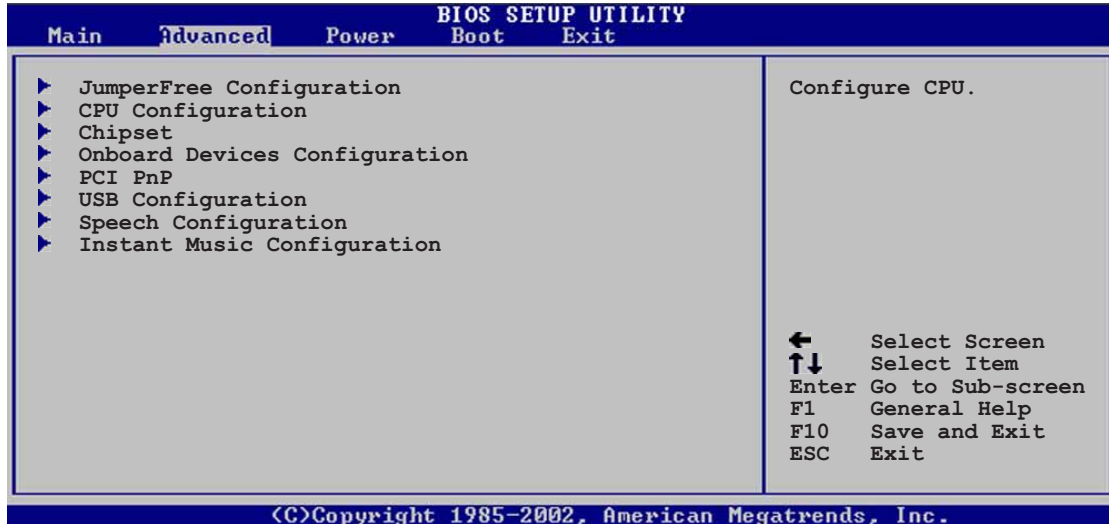

2.4.1 JumperFree Configuration



AI Overclock Tuner [Standard]

Allows selection of CPU overclocking options to achieve desired CPU internal frequency. Select either one of the preset overclocking options. Configuration options: [Manual] [Standard]



Selecting a very high CPU frequency may cause the system to become unstable! If this happens, revert to the default setting.



If you are using an unlocked CPU, the item **CPU Ratio** appears under the AI Overclock Tuner item. You may select your desired ratio from the available options.

CPU Frequency [133]

Indicates the frequency sent by the clock generator to the system bus and PCI bus. The bus frequency (external frequency) multiplied by the bus multiple equals the CPU speed. The value of this item is auto-detected by BIOS and is not manually configurable. The values range from 100 to 300.



The **CPU Frequency** item appears only when you set the **AI Overclocking Tuner** item to [Manual].

DRAM Frequency [Auto]

Allows you to set the DDR operating frequency.

Configuration options: [200 Mhz] [266 MHz] [333 MHz] [400 MHz] [Auto]

CPU FSB/Memory frequency synchronization

CPU FSB	Memory Frequency
800 MHz	200/266/333/400/450/500/533 MHz
533 MHz	200/266/333/400/450/533 MHz
400 MHz	200/266/333/400 MHz

2.4.2 CPU Configuration

The items in this menu show the CPU-related information auto-detected by BIOS.

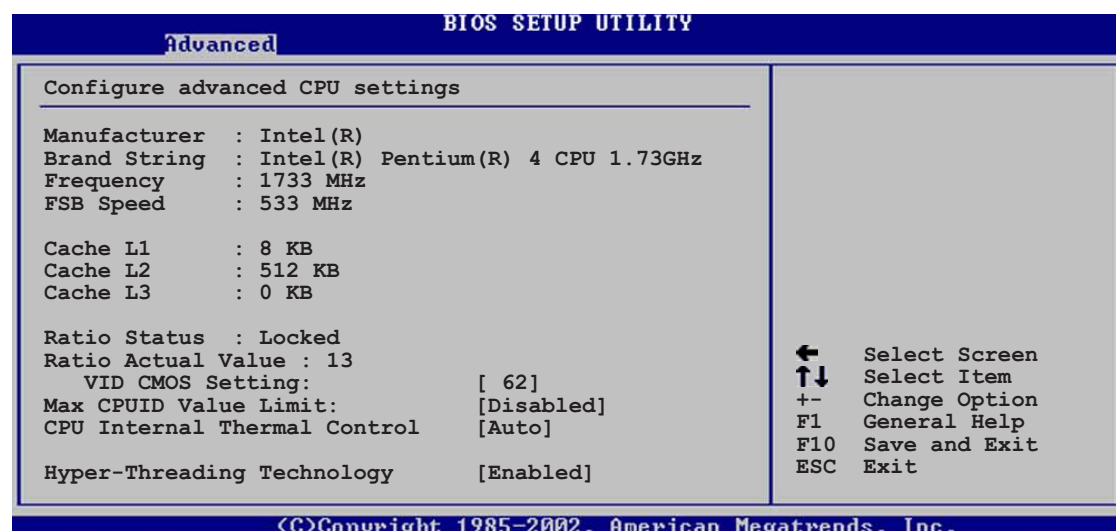

VID CMOS Setting [62]

This item allows you to set the VID setting value in which the processor is to run.

Max CPUID Value Limit [Disabled]

This item allows you to enable or disable the maximum CPUID value limit.

Configuration options: [Disabled] [Enabled]

CPU Internal Thermal Control [Auto]

This item allows you to disable or set to auto the CPU internal thermal control feature. Configuration options: [Auto] [Disabled]

Hyper-Threading Technology [Enabled]

Allows you to enable or disable the processor Hyper-Threading Technology. This item appears only when you installed a CPU with Hyper-Threading Technology feature. Configuration options: [Disabled] [Enabled]

2.4.3 Chipset

The Chipset menu items allow you to change the advanced chipset settings. Select an item then press Enter to display the sub-menu.

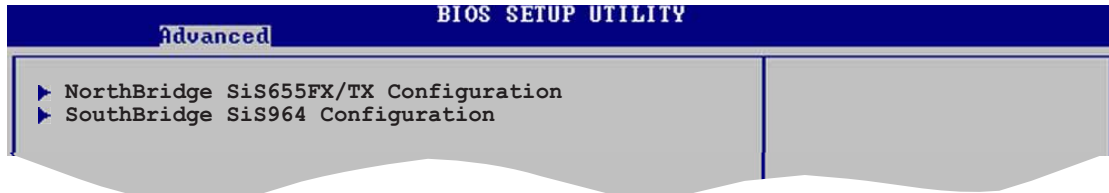

NorthBridge SiS655FX/TX Configuration

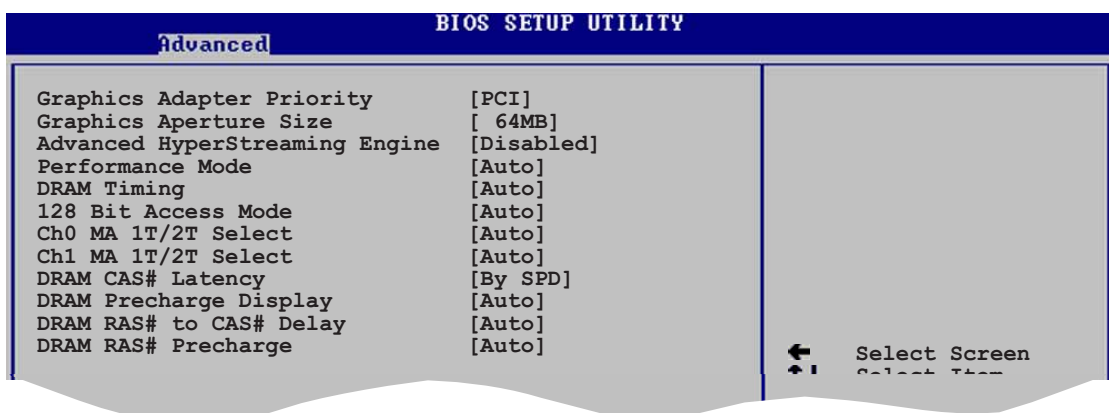

Graphic Adapter Priority [PCI]

Allows selection of the graphics controller to use as primary boot device.
Configuration options: [PCI] [AGP]

Graphics Aperture Size [64MB]

Allows you to select the size of mapped memory for AGP graphic data.
Configuration options: [32MB] [64MB] [128MB] [256MB]

Advanced HyperStreaming Engine [Disabled]

Allows your to enable or disable the advanced hyperstreaming engine.
Configuration options: [Disabled] [Enabled]

Performance Mode [Auto]

Allows boost in system performance.
Configuration options: [Safe] [Normal] [Aggressive] [Auto]

DRAM Timing [Auto]

Allows you to set the DRAM Timing.
Configuration options: [Slow] [Normal] [Fast] [Fast+] [Auto]

128 Bit Access Mode [Auto]

Allows you to set the 128 Bit Access mode.

Configuration options: [Auto] [64*2] [128*1]

Ch0 MA 1T/2T Select [Auto]

Allows you to set the Channel 0 MA 1T or 2T setting.

Configuration options: [Auto] [MA 2T] [MA 1T]

Ch1 MA 1T/2T Select [Auto]

Allows you to set the Channel 1 MA 1T or 2T setting.

Configuration options: [Auto] [MA 2T] [MA 1T]

DRAM CAS# Latency [By SPD]

This item controls the latency between the SDRAM read command and the time the data actually becomes available.

Configuration options: [By SPD] [2T] [2.5T] [3T]

DRAM Precharge Delay [Auto]

Configuration options: [Auto] [6T] [7T] [5T] [4T] [8T] [9T]

DRAM RAS# to CAS# Delay [Auto]

This item controls the latency between the DDR SDRAM active command and the read/write command.

Configuration options: [Auto] [3T] [2T] [4T] [5T]

DRAM RAS# Precharge [Auto]

This item controls the idle clocks after issuing a precharge command to the DDR SDRAM. Configuration options: [Auto] [3T] [2T] [4T] [5T]



If the system becomes unstable after changing the settings of any of the above items, revert to the default settings.

SouthBridge SiS964 Configuration

BIOS SETUP UTILITY	
Advanced	
Onboard AC97 Audio Device	[Enabled]
Onboard SiS900 LAN Device	[Enabled]
Onboard LAN Boot ROM	[Disabled]

Onboard AC97 Audio Device [Enabled]

This item enables or disables the onboard AC'97 audio CODEC device.
Configuration options: [Disabled] [Enabled]

OnBoard SiS900 LAN Device [Enabled]

Allows you to enable or disable the onboard LAN controller.
Configuration options: [Disabled] [Enabled]

OnBoard LAN Boot ROM [Disabled]

Allows you to enable or disable the option ROM in the onboard LAN controller.
This item appears only when the Onboard LAN item is set to Enabled.
Configuration options: [Disabled] [Enabled]

2.4.4 Onboard Devices Configuration

BIOS SETUP UTILITY	
Advanced	
Configure Win637 Super IO Chipset	
Serial Port1 Address	[3F8/IRQ4]
Parallel Port Address	[Disabled]
Parallel Port Mode	[Normal]
Parallel Port IRQ	[IRQ7]
OnBoard Game/MIDI Port	[Disabled]

Serial Port1 Address [3F8/IRQ4]

Allows you to select the Serial Port1 base address.
Configuration options: [Disabled] [3F8/IRQ4] [3E8/IRQ4] [2E8/IRQ3]

Parallel Port Address [Disabled]

Allows you to select the Parallel Port base addresses.
Configuration options: [Disabled] [378] [278] [3BC]

Parallel Port Mode [Normal]

Allows you to select the Parallel Port mode. When the item **Parallel Port Address** is set to **3BC**, the Parallel Port Mode options are only Normal, Bi-directional, and ECP. Configuration options: [Normal] [Bi-directional] [EPP] [ECP]

EPP Version [1.9]

Allows selection of the Parallel Port EPP version. This item appears only when the **Parallel Port Mode** is set to **EPP**. Configuration options: [1.9] [1.7]

ECP Mode DMA Channel [DMA3]

Allows selection of the Parallel Port ECP DMA channel. This item appears only when the **Parallel Port Mode** is set to **ECP**. Configuration options: [DMA0] [DMA1] [DMA3]

Parallel Port IRQ [IRQ7]

Allows you to select the Parallel Port IRQ. Configuration options: [IRQ5] [IRQ7]

Onboard Game/MIDI Port [Disabled]

Allows you to select the Game Port address or to disable the port.

Configuration options: [Disabled] [200/300] [200/330] [208/300] [208/330]

2.4.5 PCI PnP

The PCI PnP menu items allow you to change the advanced settings for PCI/PnP devices. The menu includes setting IRQ and DMA channel resources for either PCI/PnP or legacy ISA devices, and setting the memory size block for legacy ISA devices.



Take caution when changing the settings of the PCI PnP menu items. Incorrect field values may cause the system to malfunction.

Advanced		BIOS SETUP UTILITY	
Advanced PCI/PnP settings			
WARNING: Setting wrong values in the sections below may cause system to malfunction.			
Plug and Play OS	[No]	NO: Lets the BIOS configure all the devices in the system. YES: Lets the operating system configure Plug and Play (PnP) devices not required for boot if your system has a Plug and Play operating system. ← Select Screen ↑↓ Select Item +- Change Option F1 General Help F10 Save and Exit ESC Exit	
PCI Latency Timer	[64]		
Allocate IRQ to PCI VGA	[Yes]		
Palette Snooping	[Disabled]		
PCI IDE BusMaster	[Enabled]		
IRQ3	[Available]		
IRQ4	[Available]		
IRQ5	[Available]		
IRQ7	[Available]		
IRQ9	[Available]		
IRQ10	[Available]		
IRQ11	[Available]		
IRQ14	[Available]		
IRQ15	[Available]		
(C)Copyright 1985-2002, American Megatrends, Inc.			

Plug and Play O/S [No]

When set to [No], BIOS configures all the devices in the system. When set to [Yes] and if you installed a Plug & Play operating system, the operating system configures the Plug & Play devices not required for boot.

Configuration options: [No] [Yes]

PCI Latency Timer [64]

Allows you to select the value in units of PCI clocks for the PCI device latency timer register. Configuration options: [32] [64] [96] [128] [160] [192] [224] [248]

Allocate IRQ to PCI VGA [Yes]

When set to [Yes], BIOS assigns an IRQ to PCI VGA card if the card requests for an IRQ. When set to [No], BIOS does not assign an IRQ to the PCI VGA card even if requested. Configuration options: [No] [Yes]

Pallete Snooping [Disabled]

When set to [Enabled], the pallete snooping feature informs the PCI devices that an ISA graphics device is installed in the system so that the latter can function correctly. Setting to [Disabled] deactivates this feature.

Configuration options: [Disabled] [Enabled]

PCI IDE BusMaster [Enabled]

Allows BIOS to use PCI bus mastering when reading/writing to IDE devices.

Configuration options: [Disabled] [Enabled]

IRQ xx [Available]

When set to [Available], the specific IRQ is free for use of PCI/PnP devices. When set to [Reserved], the IRQ is reserved for legacy ISA devices.

Configuration options: [Available] [Reserved]

2.4.6 USB Configuration

The items in this menu allows you to change the USB-related features. Select an item then press Enter to display the configuration options.

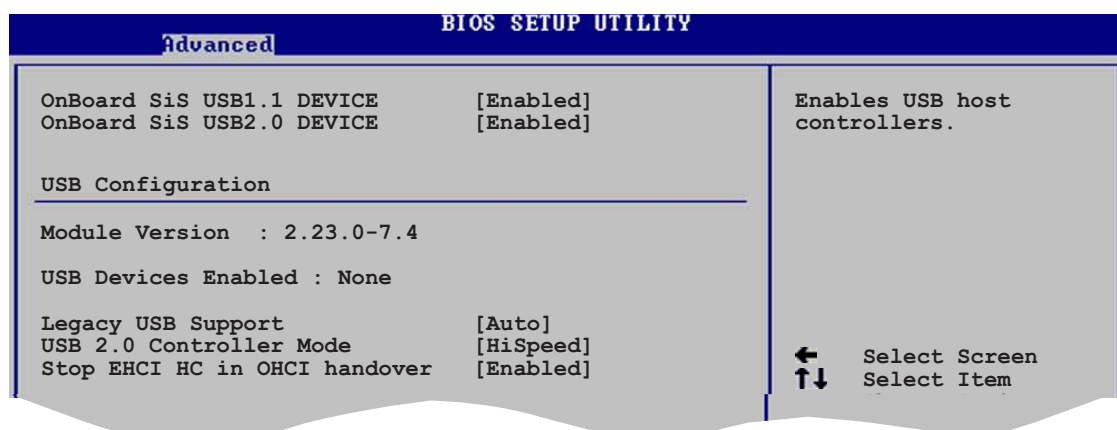

OnBoard SiS USB 1.1 Device [Enabled]

Allows you to enable or disable the onboard SiS USB 1.1 device.

Configuration options: [Disabled] [Enabled]

OnBoard SiS USB 2.0 Device [Enabled]

Allows you to enable or disable the onboard SiS USB 2.0 device.

Configuration options: [Disabled] [Enabled]



- The Module Version and USB Devices Enabled items show the auto-detected values. If no USB device is detected, the item shows None.
- Set this item to Disable when using Windows® 98SE or Windows® ME OS.

Legacy USB Support [Auto]

Allows you to enable or disable support for legacy USB devices. Setting to Auto allows the system to detect the presence of USB devices at startup. If detected, the USB controller legacy mode is enabled. If no USB device is detected, the legacy USB support is disabled. Configuration options: [Disabled] [Enabled] [Auto]

USB 2.0 Controller Mode [HiSpeed]

Allows you to configure the USB 2.0 controller in HiSpeed (480 Mbps) or Full Speed (12 Mbps). Configuration options: [HiSpeed] [Full Speed]

Stop EHCI HC in OHCI handover [Enabled]

Allows you to enable or disable the feature to stop the EHCI host controller during the OHCI OS handover call. This is needed when installing operating systems that do not support EHCI host controllers. Configuration options: [Disabled] [Enabled]

2.4.7 Instant Music Configuration



Instant Music [Disabled]

Allows you to enable or disable the Instant Music feature in BIOS.

Configuration options: [Disabled] [Enabled]



When Instant Music is enabled, the PS/2 keyboard power up feature is automatically disabled.

Instant Music CD-ROM Drive [IDE Secondary Master]

Allows you to select the CD-ROM drive that you wish to use for the Instant Music CD playback. Configuration options: [IDE Primary Master] [IDE Primary Slave] [IDE Secondary Master] [IDE Secondary Slave]



The above item appears only if you enabled the Instant Music item.

2.5 Power menu

The Power menu items allow you to change the settings for the Advanced Power Management (APM). Select an item then press Enter to display the configuration options.

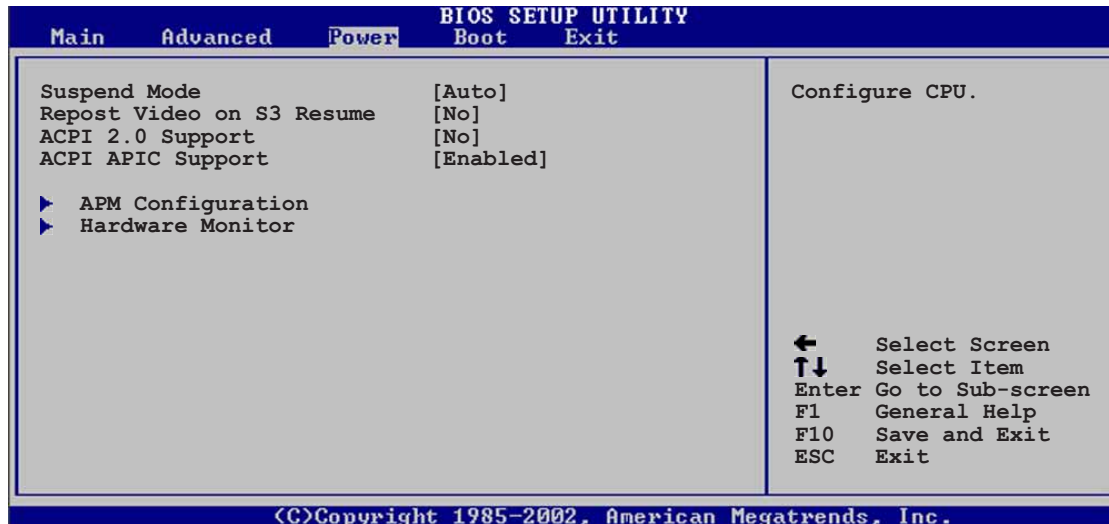

2.5.1 Suspend Mode [Auto]

Allows you to select the ACPI state to be used for system suspend.

Configuration options: [S1 (POS) Only] [S3 Only] [Auto]

2.5.2 Repost Video on S3 Resume [No]

Determines whether to invoke VGA BIOS POST on S3/STR resume.

Configuration options: [No] [Yes]

2.5.3 ACPI 2.0 Support [No]

Allows you to add more tables for ACPI 2.0 specifications.

Configuration options: [No] [Yes]

2.5.4 ACPI APIC Support [Enabled]

Allows you to enable or disable the ACPI support in the ASIC. When set to Enabled, the ACPI APIC table pointer is included in the RSDT pointer list.

Configuration options: [Disabled] [Enabled]

2.5.5 APM Configuration

BIOS SETUP UTILITY		
Power		
Power Button Mode	[On/Off]	Enabled or disable APM.
Restore on AC Power Loss	[Always OFF]	
Power On By PS/2 Keyboard	[Disabled]	
Power On By PS/2 Mouse	[Disabled]	
Power On By Internal MAC LAN	[Disabled]	
Power On By PCI Devices	[Disabled]	
Power On By External Modem	[Disabled]	
Power On By RTC Alarm	[Disabled]	

Power Button Mode [On/Off]

Allows the system to go into On/Off mode or suspend mode when the power button is pressed. Configuration options: [On/Off] [Suspend]

Restore on AC Power Loss [Always OFF]

When set to Power Off, the system goes into off state after an AC power loss. When set to Power On, the system goes on after an AC power loss. When set to Last State, the system goes into either off or on state whatever was the system state before the AC power loss. Configuration options: [Always Off] [Always On] [Keep Previous State]

Power On By PS/2 Keyboard [Disabled]

This parameter allows you to use specific keys on the keyboard to turn on the system. This feature requires an ATX power supply that provides at least 1A on the +5VSB lead. Configuration options: [Disabled] [Space Bar] [Ctrl-Esc] [Power key]



If **Instant Music** is enabled, the **Power On By PS/2 Keyboard** function is disabled.

Power On By PS/2 Mouse [Disabled]

When set to [Enabled], this parameter allows you to use the PS/2 mouse to turn on the system. This feature requires an ATX power supply that provides at least 1A on the +5VSB lead. Configuration options: [Disabled] [Enabled]



If the **Power On By PS/2 Keyboard** is enabled, the **Power On by PS/2 Mouse** function is disabled.

Power On By Internal MAC LAN [Disabled]

When set to [Enabled], this parameter allows you to use the MAC LAN device to wake the system from sleep state. This feature requires an ATX power supply that provides at least 1A on the +5VSB lead. Configuration options: [Disabled] [Enabled]

Power On By PCI Devices [Disabled]

When set to [Enabled], this parameter allows you to turn on the system through a PCI LAN or modem card. This feature requires an ATX power supply that provides at least 1A on the +5VSB lead.

Configuration options: [Disabled] [Enabled]

Power On By External Modem [Disabled]

This allows either settings of [Enabled] or [Disabled] for powering up the computer when the external modem receives a call while the computer is in Soft-off mode.

Configuration options: [Disabled] [Enabled]



The computer cannot receive or transmit data until the computer and applications are fully running. Thus, connection cannot be made on the first try. Turning an external modem off and then back on while the computer is off causes an initialization string that turns the system power on.

Power On By RTC Alarm [Disabled]

Allows you to enable or disable RTC to generate a wake event. When this item is set to Enabled, the items RTC Alarm Date, RTC Alarm Hour, RTC Alarm Minute, and RTC Alarm Second appear with set values.

Configuration options: [Disabled] [Enabled]

2.5.6 Hardware Monitor

```
BIOS SETUP UTILITY
Power
-----
Hardware Monitor
-----
CPU Temperature      [44°C/111°F]
MB Temperature      [36°C/96.5°F]
CPU Fan Speed       [2250RPM]
Chassis Fan Speed   [XXX RPM]
Power Fan Speed     [XXX RPM]
Vcore Voltage       [1.550V]
3.3V Voltage        [3.386V]
5V Voltage          [4.890V]
12V Voltage         [11.900V]
← Select Screen
↑↓ Select Item
+- Change Option
F1 General Help
F10 Save and Exit
ESC Exit
(C)Copyright 1985-2002, American Megatrends, Inc.
```

CPU Temperature [xxx°C/xxx°F]

MB Temperature [xxx°C/xxx°F]

The onboard hardware monitor automatically detects and displays the motherboard and CPU temperatures. Select [Ignored] if you do not wish to display the detected temperatures.

CPU Fan Speed [xxxxRPM] or [N/A]
Chassis Fan Speed [xxxxRPM] or [N/A]
Power Fan Speed [xxxxRPM] or [N/A]

The onboard hardware monitor automatically detects and displays the CPU, chassis, and power fan speeds in rotations per minute (RPM). If any of the fans is not connected to the motherboard, the specific field shows N/A.

VCORE Voltage, +3.3V Voltage, +5V Voltage, +12V Voltage

The onboard hardware monitor automatically detects the voltage output through the onboard voltage regulators.



If any of the monitored items is out of range, the following error message appears: "Hardware Monitor found an error. Enter Power setup menu for details". You will then be prompted to "Press F1 to continue or DEL to enter SETUP".

2.6 Boot menu

The Boot menu items allow you to change the system boot options. Select an item then press Enter to display the sub-menu.

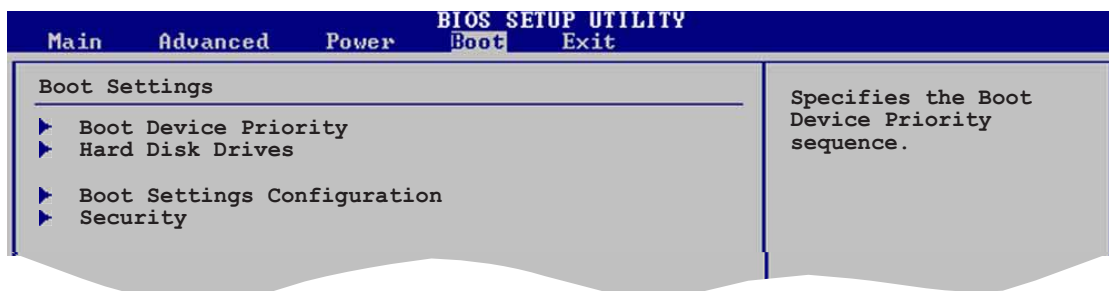

2.6.1 Boot Device Priority

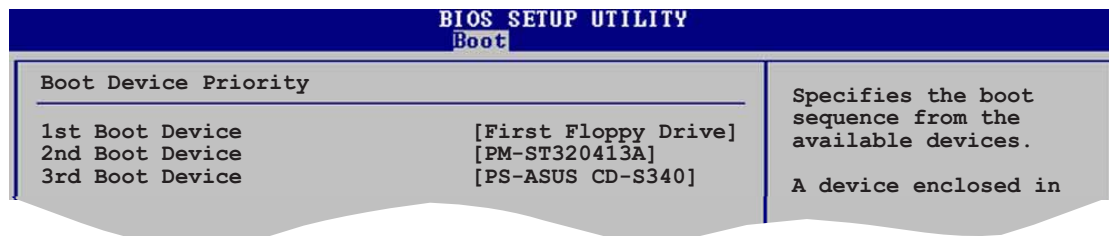

1st ~ xxth Boot Device [1st Floppy Drive]

These items specify the boot device priority sequence from the available devices. The number of device items that appear on the screen depends on the the number of devices installed in the system. Configuration options: [xxxxx Drive] [Disabled]

2.6.2 Hard Disk Drives

BIOS SETUP UTILITY		
Boot		
Hard Disk Drives		Specifies the boot sequence from the available devices.
1st Drive	[PM-ST320413A]	
2nd Drive	[SiS 964]	

1st ~ xxth Drive (Hard disk model number auto detected)

These items specify the hard disk priority sequence from the available hard disk drives. The number of hard disk drive items that appear on the screen depends on the the number of hard disk drives installed in the system.

Configuration options: [xxxxx Drive] [Disabled]

2.6.3 Removable Drives



This item appears only when there are removable drives (like a USB flash disk) plugged in the system.

BIOS SETUP UTILITY				
Main	Advanced	Power	Boot	Exit
Removable Drives		Specifies the boot sequence from the available devices. A device enclosed in		
1st Boot Device	[1st FLOPPY DRIVE]			
2nd Boot Device	[ASUS USB Flash Disk]			
3rd Boot Device	[ASUS USB Flash Disk]			

1st ~ xxth Boot Device [1st Floppy Drive]

These items specify the removable boot device priority sequence from the available removable boot devices. Configuration options: [xxxxx Drive] [Disabled]

2.6.4 Boot Settings Configuration

BIOS SETUP UTILITY		
Boot		
Boot Settings Configuration		Allows BIOS to skip certain tests while booting. This will decrease the time needed to boot the system.
Quick Boot	[Enabled]	
Full Screen Logo	[Enabled]	
Add On ROM Display Mode	[Force BIOS]	
Bootup Num-Lock	[On]	
PS/2 Mouse Support	[Auto]	
Wait for 'F1' If Error	[Enabled]	
Hit 'DEL' Message Display	[Enabled]	
Interrupt 19 Capture	[Disabled]	

Quick Boot [Enabled]

Enabling this item allows BIOS to skip some power on self tests (POST) while booting to decrease the time needed to boot the system. When set to [Disabled], BIOS performs all the POST items. Configuration options: [Disabled] [Enabled]

Full Screen Logo [Enabled]

This allows you to enable or disable the full screen logo display feature.

Configuration options: [Disabled] [Enabled]



Make sure that the **Full Screen Logo** item is set to [Enabled] if you wish to use the ASUS MyLogo2™ feature.

Add On ROM Display Mode [Force BIOS]

Sets the display mode for option ROM. Configuration options: [Force BIOS] [Keep Current]

Bootup Num-Lock [On]

Allows you to select the power-on state for the NumLock.

Configuration options: [Off] [On]

PS/2 Mouse Support [Auto]

Allows you to enable or disable support for PS/2 mouse.

Configuration options: [Disabled] [Enabled] [Auto]

Wait for 'F1' If Error [Enabled]

When set to Enabled, the system waits for F1 key to be pressed when error occurs. Configuration options: [Disabled] [Enabled]

Hit 'DEL' Message Display [Enabled]

When set to Enabled, the system displays the message "Press DEL to run Setup" during POST. Configuration options: [Disabled] [Enabled]

Interrupt 19 Capture [Disabled]

When set to [Enabled], this function allows the option ROMs to trap Interrupt 19.

Configuration options: [Disabled] [Enabled]

2.6.5 Security

The Security menu items allow you to change the system security settings. Select an item then press Enter to display the configuration options.

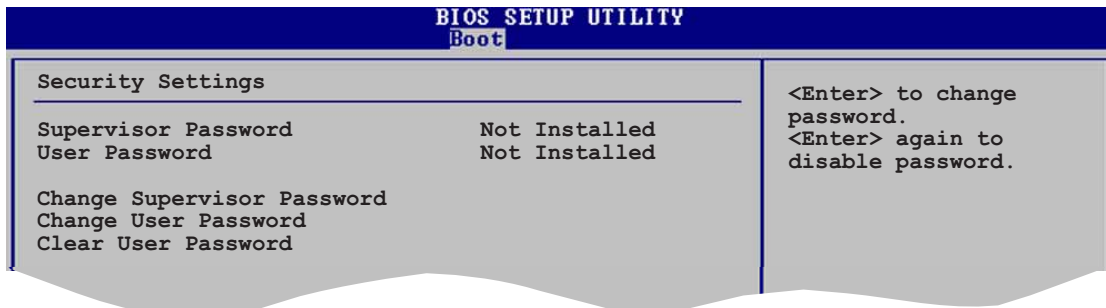

Change Supervisor Password

Select this item to set or change the supervisor password. The Supervisor Password item on top of the screen shows the default **Not Installed**. After you have set a password, this item shows **Installed**.

To set a Supervisor Password:

1. Select the Change Supervisor Password item and press Enter.
2. On the password box that appears, type a password composed of letters and/or numbers, then press Enter. The password supports only a maximum of 6 characters.
3. Confirm the password when prompted.
The message "Password Installed" appears after you have successfully set your password.

The Supervisor Password item now shows **Installed**.

To change the supervisor password, follow the same steps as in setting a user password.

To clear the supervisor password, select the Change Supervisor Password then press Enter. The message "Password Uninstalled" appears.

After you have set a supervisor password, the other items appear to allow you to change other security settings.

User Access Level (Full Access]

This item allows you to select the access restriction to the Setup items.

Configuration options: [No Access] [View Only] [Limited] [Full Access]

No Access prevents user access to the Setup utility.

View Only allows access but does not allow change to any field.

Limited allows change to only selected fields, such as Date and Time.

Full Access allows viewing and changing all the fields in the Setup utility.

Change User Password

Select this item to set or change the user password. The User Password item on top of the screen shows the default **Not Installed**. After you have set a password, this item shows **Installed**.

To set a User Password:

1. Select the Change User Password item and press Enter.
2. On the password box that appears, type a password composed of letters and/or numbers, then press Enter. Your password should have at least six characters.
3. Confirm the password when prompted.
The message "Password Installed" appears after you have successfully set your password.

The User Password item now shows **Installed**.

To change the user password, follow the same steps as in setting a user password.

Clear User Password

Select this item if you wish to clear the user password.

Password Check [Setup]

When set to [Setup], BIOS checks for user password when accessing the Setup utility. When set to [Always], BIOS checks for user password both when accessing Setup and booting the system. Configuration options: [Setup] [Always]

2.7 Exit menu

The Exit menu items allow you to load the optimal or failsafe default values for the BIOS items, and save or discard your changes to the BIOS items.

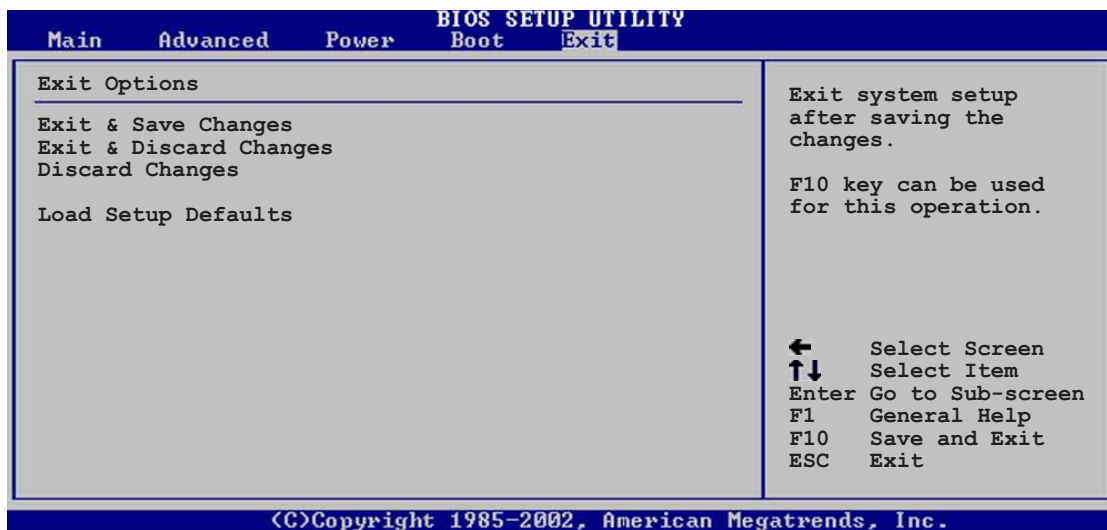

Pressing <Esc> does not immediately exit this menu. Select one of the options from this menu or <F10> from the legend bar to exit.

Exit & Save Changes

Once you are finished making your selections, choose this option from the Exit menu to ensure the values you selected are saved to the CMOS RAM. The CMOS RAM is sustained by an onboard backup battery and stays on even when the PC is turned off. When you select this option, a confirmation window appears. Select [Yes] to save changes and exit.



If you attempt to exit the Setup program without saving your changes, the program prompts you with a message asking if you want to save your changes before exiting. Pressing <Enter> saves the changes while exiting.

Exit & Discard Changes

Select this option only if you do not want to save the changes that you made to the Setup program. If you made changes to fields other than system date, system time, and password, the BIOS asks for a confirmation before exiting.

Discard Changes

This option allows you to discard the selections you made and restore the previously saved values. After selecting this option, a confirmation appears. Select [Yes] to discard any changes and load the previously saved values.

Load Setup Defaults

This option allows you to load the default values for each of the parameters on the Setup menus. When you select this option or if you press <F5>, a confirmation window appears. Select [Yes] to load default values. Select Exit Saving Changes or make other changes before saving the values to the non-volatile RAM.

Chapter 3

This chapter describes the contents of the support CD that comes with the motherboard package.

Software support

3.1 Install an operating system

This motherboard supports Windows® ME/2000/XP operating system (OS). Always install the latest OS version and corresponding updates so you can maximize the features of your hardware.



- Because motherboard settings and hardware options vary, use the setup procedures presented in this chapter for general reference only. Refer to your OS documentation for more information.
- This motherboard does not support Windows® 98SE.

3.2 Support CD information

The support CD that came with the motherboard contains useful software and several utility drivers that enhance the motherboard features.



The contents of the support CD are subject to change at any time without notice. Visit the ASUS website for updates.

3.2.1 Running the support CD

To begin using the support CD, simply insert the CD into your CD-ROM drive. The CD automatically displays the **Drivers** menu if Autorun is enabled in your computer. Click on an item to install.



If **Autorun** is NOT enabled in your computer, browse the contents of the support CD to locate the file ASSETUP.EXE from the BIN folder. Double-click the **ASSETUP.EXE** to run the CD.

3.2.2 Drivers menu

The drivers menu shows the available device drivers if the system detects installed devices. Install the necessary drivers to activate the devices.

SiS RAID driver

Installs the SiS® RAID controller driver and application.

Make SiS RAID Driver Disk

Allows you to create a SiS® RAID driver disk.

SiS Mini IDE driver

Installs the SiS® mini IDE driver.

SiS AGP driver

Installs the SiS® AGP driver.

SoundMAX Audio Driver and Application

Installs the ADI SoundMAX 1888 AC'97 compliant audio controller and application.

SiS PCI LAN driver

Installs the SiS® PCI LAN driver.

USB 2.0 Driver

Installs the USB 2.0 drivers.

3.2.3 Utilities menu

The Utilities menu shows the applications and other software that the motherboard supports.



ASUS PC Probe

This smart utility monitors the fan speed, CPU temperature, and system voltages, and alerts you on any detected problems. This utility helps you keep your computer at a healthy operating condition.

Install ASUS Update

This program allows you to download the latest version of the BIOS from the ASUS website. Before using the ASUS Update, make sure that you have an Internet connection so you can connect to the ASUS website. Installing ASUS Update also installs ASUS Mylogo2™.

Anti-virus Utility

This item installs the Trend Micro PC-cillin 2004 anti-virus program. View the PC-CILLIN online help for details.

Adobe Acrobat Reader

This item installs the Adobe Acrobat Reader V5.0. The Acrobat Reader software is for viewing files saved in Portable Document Format (PDF).

ASUS Screen Saver

This item installs the ASUS screen saver.

3.2.4 ASUS Contact Information

Clicking the ASUS Contact Information tab displays as stated. You may also find this information on the inside front cover of this user guide.



Screen display and utilities option may not be the same for other operating system version.

3.3 ASUS Instant Music Lite

The motherboard is equipped with a BIOS-based audio playback feature called **Instant Music Lite**. This feature is supported by the onboard audio AC'97 CODEC, and requires an optical drive (CD-ROM, DVD-ROM, or CD-RW).



-
1. Instant Music Lite only supports CDs in audio format.
 2. Instant Music Lite does not work if you installed and enabled an add-on sound card.
 3. Instant Music Lite only supports PS/2 keyboard.
-

To enable ASUS Instant Music Lite:

1. Connect the analog audio cable from the optical drive (CD-ROM, DVD-ROM, or CD-RW drive) to the 4-pin CD-In connector (labeled CD1) on the motherboard. See section “1.10 Connectors” for the connector location.



Make sure to connect the CD-ROM audio cable. Otherwise, you cannot control the audio volume using the Instant Music Lite function keys.

2. Turn on the system and enter BIOS by pressing the **Delete** key during the Power On Self-Tests (POST).
3. In the **Advanced Configuration** menu, select the item **Instant Music** and set it to **Enabled**. See section “2.4 Advanced Menu” in the user guide.
4. Highlight the **Instant Music CDROM** item and press Enter to display the CD-ROM options. Select the CD-ROM drive that you wish to use for this feature. See section “2.4 Advanced Menu” in the user guide.



If you have only one optical drive (either CD-ROM, DVD-ROM, or CD-RW) installed in the system, you don't have to set Instant Music CDROM item. BIOS automatically detects and displays the installed drive type.

5. Save your changes and exit BIOS Setup.



-
1. The Scroll Lock LED is fixed to ON after enabling Instant Music.
 2. The Caps Lock LED is turns ON when you pause the CD playback.
 3. When set to Instant Music Lite mode, the system wake-up features (LAN, keyboard, mouse, USB) are deactivated. In this case, power up the system using the power switch.
 4. If the system lost connection or did not detect any optical drive, the Instant Music Lite feature turns OFF (disabled) automatically. A “beep” indicates this condition.
-

To use ASUS Instant Music Lite:

1. Ensure that the power cord is plugged to a grounded power source, so that the system has a standby power.
2. Use either one of the two sets of special function keys on your keyboard to play audio CDs. These keys only function as indicated if you enabled the Instant Music item in the BIOS.

Instant Music function keys (Set 1)

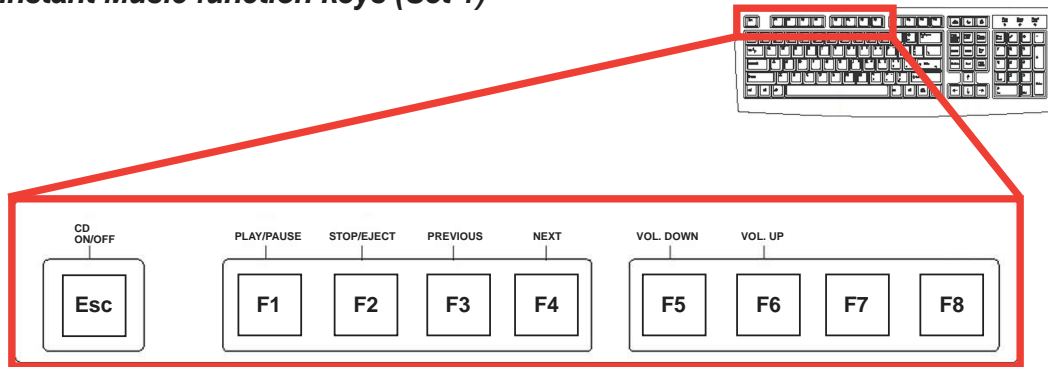

Instant Music function keys (Set 2)

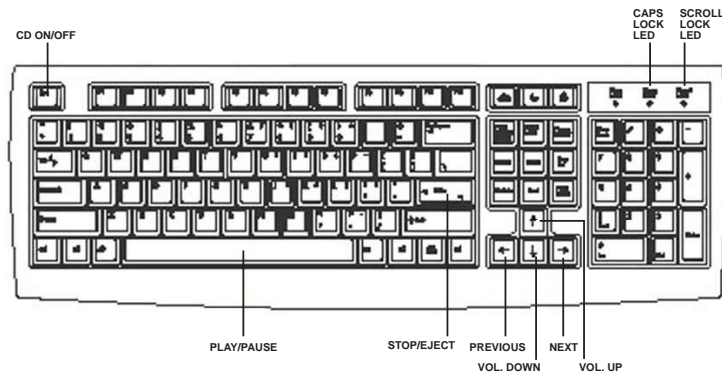

3. Connect speakers or a headphone to the Line Out (lime colored) port on the rear panel for audio output. You may also connect a headphone to the headphone jack on the CD-ROM drive front panel.
4. Press **Esc** to turn ON Instant Music Lite.
5. Place an audio CD on the drive.
6. Press **F1** or the **Space Bar** to play the first track on the CD.



If there is no CD on the drive and you press F1 or Space Bar, the drive tray ejects.

7. Refer to the Instant Music function key definitions on the previous page to select other tracks or control the volume.
8. Press **F2** or **Enter** *once* to stop playing the CD.
Press **F2** or **Enter** *one more time* to eject the CD.

Free Manuals Download Website

<http://myh66.com>

<http://usermanuals.us>

<http://www.somanuals.com>

<http://www.4manuals.cc>

<http://www.manual-lib.com>

<http://www.404manual.com>

<http://www.luxmanual.com>

<http://aubethermostatmanual.com>

Golf course search by state

<http://golfingnear.com>

Email search by domain

<http://emailbydomain.com>

Auto manuals search

<http://auto.somanuals.com>

TV manuals search

<http://tv.somanuals.com>