

**Projector**  
**CP-X253**  
**User's Manual (detailed)**  
**Operating Guide**

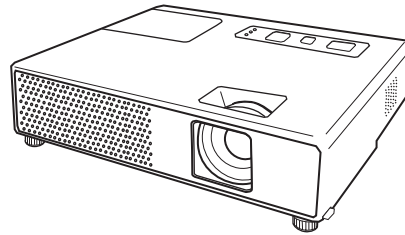

Thank you for purchasing this projector.

**⚠WARNING** ► Before using this product, please read all manuals for this product. Be sure to read "Safety Guide" first. After reading them, store them in a safe place for future reference.

#### About this manual

Various symbols are used in this manual. The meanings of these symbols are described below.

- ⚠WARNING** This symbol indicates information that, if ignored, could possibly result in personal injury or even death due to incorrect handling.
- ⚠CAUTION** This symbol indicates information that, if ignored, could possibly result in personal injury or physical damage due to incorrect handling.

 Please refer to the pages written following this symbol.

**NOTE** • The information in this manual is subject to change without notice.  
• The manufacturer assumes no responsibility for any errors that may appear in this manual.  
• The reproduction, transfer or copy of all or any part of this document is not permitted without express written consent.

#### Trademark acknowledgment

- Mac is registered trademarks of Apple Computer, Inc.
  - VESA and SVGA are trademarks of the Video Electronics Standard Association.
  - Windows is a registered trademark of Microsoft Corporation.
- All other trademarks are the properties of their respective owners.

Content

<b>About this manual</b> . . . . .	<b>1</b>	<b>EASY MENU</b> . . . . .	<b>21</b>
<b>Content</b> . . . . .	<b>2</b>	ASPECT, AUTO KEYSTONE  EXECUTE,	
<b>Projector features</b> . . . . .	<b>3</b>	KEYSTONE  , PICTURE MODE, BRIGHTNESS,	
<b>Preparations</b> . . . . .	<b>3</b>	CONTRAST, COLOR, TINT, SHARPNESS,	
Contents of package . . . . .	3	WHISPER, MIRROR, RESET, FILTER TIME,	
Fastening the lens cover . . . . .	3	LANGUAGE, Go to Advanced Menu...	
Replacing the filter cover for		<b>PICTURE menu</b> . . . . .	<b>23</b>
bottom-up use . . . . .	3	BRIGHTNESS, CONTRAST, GAMMA, COLOR TEMP,	
<b>Part names</b> . . . . .	<b>4</b>	COLOR, TINT, SHARPNESS, MY MEMORY	
Projector . . . . .	4	<b>IMAGE menu</b> . . . . .	<b>26</b>
Control panel . . . . .	5	ASPECT, OVER SCAN, V POSITION, H POSITION,	
Remote control . . . . .	5	H PHASE, H SIZE, AUTO ADJUST EXECUTE	
<b>Setting up</b> . . . . .	<b>6</b>	<b>INPUT menu</b> . . . . .	<b>28</b>
Arrangement . . . . .	6	PROGRESSIVE, VIDEO NR, COLOR SPACE,	
Connecting your devices . . . . .	8	VIDEO FORMAT, FRAME LOCK, COMPUTER IN,	
Connecting power supply . . . . .	10	RESOLUTION	
Using the security slot . . . . .	10	<b>SETUP menu</b> . . . . .	<b>31</b>
<b>Remote control</b> . . . . .	<b>11</b>	AUTO KEYSTONE  EXECUTE, KEYSTONE  ,	
Putting batteries . . . . .	11	WHISPER, MIRROR, VOLUME, AUDIO	
About the remote control signal . . . . .	11	<b>SCREEN menu</b> . . . . .	<b>33</b>
Changing the frequency of remote		LANGUAGE, MENU POSITION, BLANK,	
control signal . . . . .	12	START UP, MyScreen, MyScreen Lock,	
Using as a		MESSAGE, SOURCE NAME	
simple PC mouse & keyboard . . . . .	12	<b>OPTION menu</b> . . . . .	<b>37</b>
<b>Power on/off</b> . . . . .	<b>13</b>	AUTO SEARCH, AUTO KEYSTONE  ,	
Turning on the power . . . . .	13	AUTO ON, AUTO OFF, LAMP TIME,	
Turning off the power . . . . .	13	FILTER TIME, MY BUTTON, SERVICE,	
<b>Operating</b> . . . . .	<b>14</b>	SECURITY	
Adjusting the volume . . . . .	14	<b>Maintenance</b> . . . . .	<b>48</b>
Temporarily muting the sound . . . . .	14	Lamp . . . . .	48
Selecting an input signal . . . . .	14	Air filter . . . . .	50
Searching an input signal . . . . .	15	Other care . . . . .	51
Selecting an aspect ratio . . . . .	15	<b>Troubleshooting</b> . . . . .	<b>52</b>
Adjusting the projector's elevator . . . . .	16	Related messages . . . . .	52
Adjusting the zoom and focus . . . . .	16	Regarding the indicator lamps . . . . .	53
Using the automatic adjustment feature . . . . .	17	Shutting the projector down . . . . .	54
Adjusting the position . . . . .	17	Resetting all settings . . . . .	54
Correcting the keystone distortions . . . . .	18	Phenomena that may be easy	
Using the magnify feature . . . . .	18	to be mistaken for machine defects . . . . .	55
Freezing the screen . . . . .	19	<b>Specifications</b> . . . . .	<b>57</b>
Temporarily blanking the screen . . . . .	19		
Using the menu function . . . . .	20		

## Projector features

This projector has a capability to project various picture signals onto a screen. This projector requires only a minimal amount of space for installation and can produce a large projected image from even a short distance. This projector has very compact and stylish design. Also in such compact body, high power optical engine is mounted, which can make high bright image on screen.

## Preparations

### Contents of package

Please see the "Contents of package" in the "User's Manual (concise)" which is a book. Your projector should come with the items shown there. Contact immediately your dealer if anything is missing.

**NOTE** • Keep the original packing materials, for future reshipment. Be sure to use the original packing materials when moving the projector. Use special caution for the lens.

### Fastening the lens cover

To avoid losing the lens cover, please fasten the lens cover to the projector using the enclosed strap.

1. Fix the strap to the strap hole of the lens cover. Thread one end of the strap through the strap hole of the lens cover and make the loop at the end, and let the other end of the strap through the loop. Not have a knot in the strap at either end.
2. Fix the strap to the strap hole of the projector. Thread the other end of the strap through the strap hole of the projector and make the loop there. Let the lens cover with the one end of strap through the loop.

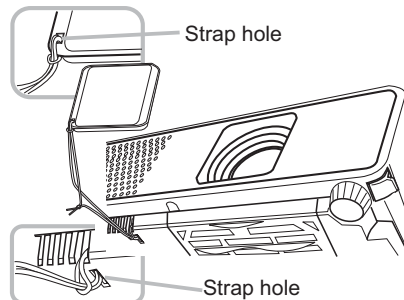

### Replacing the filter cover for bottom-up use

For the projector installed bottom-up, please replace the filter cover with the enclosed filter cover for bottom-up use, to keep necessary ventilation space. Please refer to the "Air filter" (P.50) for how to detach and attach a filter cover.

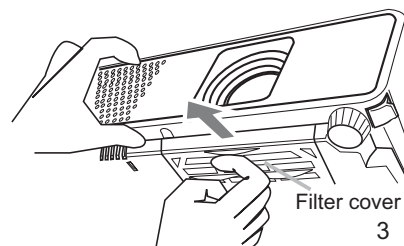

**⚠ WARNING** ▶ Consult with your dealer before a special installation such as suspending from a ceiling.

Part names

Part names

**Projector**

- (1) Lamp cover (📖48)  
The lamp unit is inside.
- (2) Focus ring (📖16)
- (3) Zoom ring (📖16)
- (4) Control panel (📖5)
- (5) Speaker (📖32)
- (6) Elevator knobs (x 2) (📖16)
- (7) Elevator feet (x 2) (📖16)
- (8) Lens (📖13, 51)
- (9) Lens cover (📖3)
- (10) Intake vents  
The air filter and intake vent are inside.
- (11) Filter cover (📖50)
- (12) Exhaust vents
- (13) AC inlet (📖10)
- (14) VIDEO port (📖8)
- (15) S-VIDEO port (📖8)
- (16) Security slot (📖10)
- (17) COMPUTER IN1 port (📖8)
- (18) Shutdown switch (📖54)
- (19) COMPUTER IN2 port (📖8)
- (20) USB port (📖8)
- (21) AUDIO IN1 port (📖8)
- (22) AUDIO IN2 port (📖8)
- (23) AUDIO OUT port (📖8)
- (24) CONTROL port (📖8)
- (25) MONITOR OUT port (📖8)

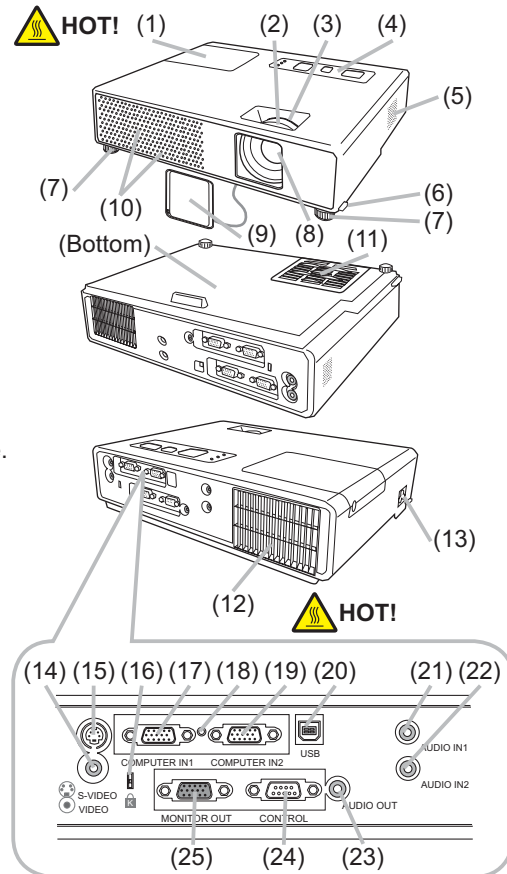

**⚠️ WARNING ► HOT! :** Do not touch around the lamp cover and the exhaust vents during use or just after use, since it is too hot.

- Do not look into the lens or vents while the lamp is on, since the strong light is not good for your eyes.
- Do not handle the elevator knobs without holding the projector, since the projector may drop down.

**⚠️ CAUTION ►** Maintain normal ventilation to prevent the projector from heating up. Do not cover, block or plug up the vents. Do not place anything that can stick or be sucked to the vents, around the intake vents. Clean the air filter periodically.

- Do not use the security slot to prevent the projector from falling down, since it is not designed for it.
- Use the shutdown switch only when the projector is not turned off by normal procedure, since pushing this switch stops operation of the projector without cooling it down.

## Control panel

- (1) STANDBY/ON button (13)
  - (2) INPUT/ENTER button (14, 20)
  - (3) MENU button (20)
  - (4) POWER indicator (13, 53)
  - (5) TEMP indicator (53)
  - (6) LAMP indicator (53)
- It consists of four cursor buttons.

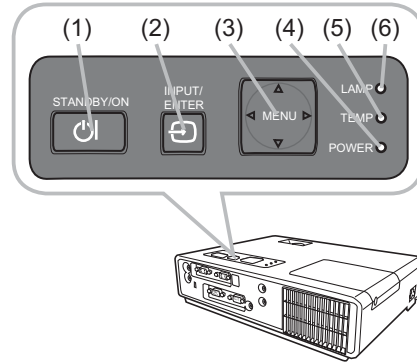

## Remote control

- (1) VIDEO button (15)
- (2) COMPUTER/STORAGE button (14)
- (3) SEARCH button (15)
- (4) STANDBY/ON button (13)
- (5) ASPECT button (15)
- (6) AUTO button (17)
- (7) BLANK button (19)
- (8) MAGNIFY - ON button (18)
- (9) MAGNIFY - OFF button (12, 18)
- (10) HOME button (12)
- (11) END button (12)
- (12) PAGE UP button (12)
- (13) PAGE DOWN button (12)
- (14) VOLUME button (14)
- (15) MUTE button (12, 14)
- (16) FREEZE button (19)
- (17) MY BUTTON - 1 button (39)
- (18) MY BUTTON - 2 button (39)
- (19) KEYSTONE button (18)
- (20) POSITION button (17)
- (21) MENU button (20)
- (22) ▲/▼/◀/▶ cursor buttons (12, 20)
- (23) ENTER button (12, 20)
- (24) ESC button (12, 20)
- (25) RESET button (12, 20)
- (26) Battery cover (11)

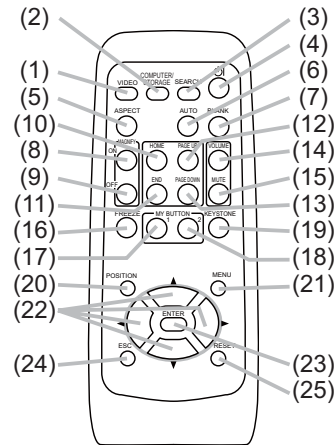

Back of the remote control

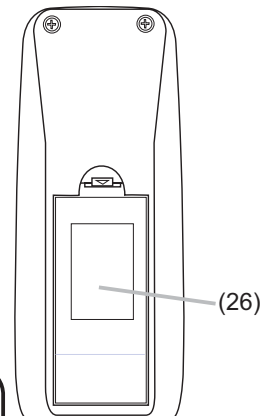

**NOTE** • The COMPUTER/STORAGE button on the remote control is button for selecting only a PC input. This model does not have any function about STORAGE device.

Setting up

Setting up

Install the projector according to the environment and manner the projector will be used in.

**Arrangement**

Refer to the illustrations and tables below to determine screen size and projection distance.

The values shown in the table are calculated for a full size screen: 1024×768.

- (a) Screen size (diagonal)
- (b) Projection distance (±10%)
- (c) Screen height (±10%)

**On a horizontal surface**

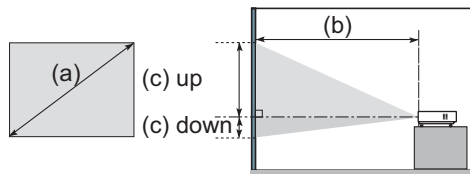

**Suspended from the ceiling**

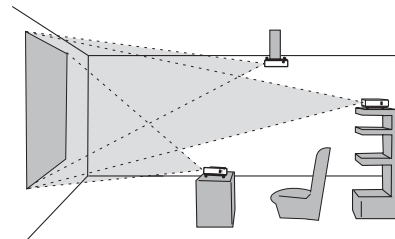
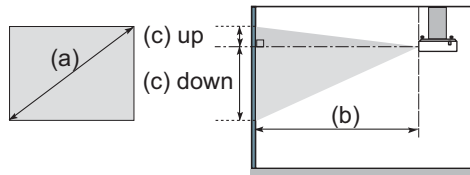

- Keep a space of 30 cm or more between the sides of the projector and other objects such as walls.
- Consult with your dealer before a special installation such as suspending from a ceiling.

(a) Screen size (diagonal)	4 : 3 screen								16 : 9 screen								
	(b) Projection distance				(c) Screen height				(b) Projection distance				(c) Screen height				
	min.		max.		down		up		min.		max.		down		up		
inch	m	m	inch	m	inch	cm	inch	cm	inch	m	inch	m	inch	cm	inch	cm	inch
30	0.8	0.8	30	0.9	36	7	3	39	15	0.8	33	1.0	39	1	0	37	14
40	1.0	1.0	40	1.2	48	9	3	52	21	1.1	44	1.3	53	1	0	49	19
50	1.3	1.3	50	1.5	61	11	4	65	26	1.4	55	1.7	66	1	1	61	24
60	1.5	1.5	61	1.9	73	13	5	78	31	1.7	66	2.0	79	2	1	73	29
70	1.8	1.8	71	2.2	85	15	6	91	36	2.0	77	2.4	93	2	1	85	34
80	2.0	2.1	81	2.5	97	17	7	105	41	2.2	88	2.7	106	2	1	97	38
90	2.3	2.3	91	2.8	110	20	8	118	46	2.5	100	3.0	120	2	1	110	43
100	2.5	2.6	102	3.1	122	22	9	131	51	2.8	111	3.4	133	3	1	122	48
120	3.0	3.1	122	3.7	147	26	10	157	62	3.4	133	4.1	160	3	1	146	58
150	3.8	3.9	153	4.7	183	33	13	196	77	4.2	166	5.1	200	4	2	183	72
200	5.1	5.2	204	6.2	245	44	17	261	103	5.6	222	6.8	267	5	2	243	96
250	6.4	6.5	255	7.8	306	54	21	327	129	7.1	278	8.5	334	7	3	304	120
300	7.6	7.8	306	9.3	368	65	26	392	154	8.5	334	10.2	400	8	3	365	144

**⚠WARNING** ► Place the projector in a stable horizontal position. If the projector falls or is knocked over it could cause injury and/or damage to the projector. Using a damaged projector could then result in fire and/or electric shock.

- Do not place the projector on an unstable, slanted or vibrational surface such as a wobbly or inclined stand.
- Do not place the projector on its side, front or rear position.
- Consult with your dealer before a special installation such as suspending from a ceiling.

► Place the projector in a cool place, and ensure that there is sufficient ventilation. The high temperature of the projector could cause fire, burns and/or malfunction of the projector.

- Do not stop-up, block or otherwise cover the projector's vents.
- Keep a space of 30 cm or more between the sides of the projector and other objects such as walls.
- Do not place the projector on metallic thing or anything weak in heat.
- Do not place the projector on carpet, cushions or bedding.
- Do not place the projector in direct sunlight or near hot objects such as heaters.
- Do not anything near the projector lens or vents, or on top of the projector.
- Do not place anything that may be sucked into or stick to the vents on the bottom of the projector. This projector has some intake vents also on the bottom.

► Do not place the projector anyplace where it may get wet. Getting the projector wet or inserting liquid into the projector could cause fire, electric shock and/or malfunction of the projector.

- Do not place the projector in a bathroom or the outdoors.
- Do not place anything containing liquid near the projector.

**⚠CAUTION** ► Avoid placing the projector in smoky, humid or dusty place. Placing the projector in such places could cause fire, electric shock and/or malfunction of the projector.

- Do not place the projector near humidifiers, smoking spaces or a kitchen.
- Position the projector to prevent light from directly hitting the projector's remote sensor.

## Connecting your devices

Be sure to read the manuals for devices before connecting them to the projector. Make sure that all the devices are suitable to be connected with this product, and prepare the cables required to connect.

Please refer to the following illustrations to connect them.

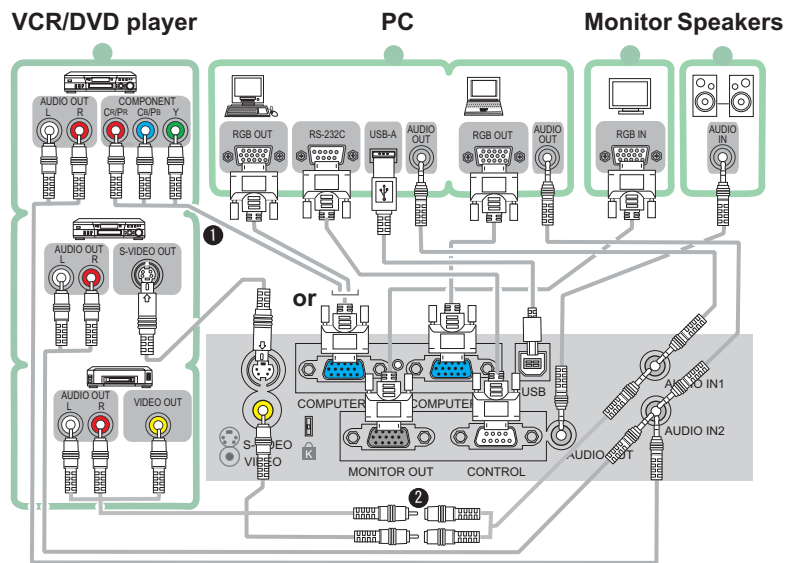

**NOTE ①** The COMPUTER IN1 port can support a component signal also. For more information, please see the description of the COMPUTER IN item of the INPUT menu (p.29).

**②** Please use the enclosed Video/Audio cable and Audio adapter.

**⚠ WARNING** ▶ Do not disassemble or modify the projector and accessories.  
 ▶ Be careful not to damage the cables, and do not use damaged cables.  
**⚠ CAUTION** ▶ Turn off all devices and unplug their power cords prior to connecting them to projector. Connecting a live device to the projector may generate extremely loud noises or other abnormalities that may result in malfunction or damage to the device and the projector.  
 ▶ Use appropriate accessory or otherwise designed cables. Ask your dealer about non-accessory cables which may have to be of a specific length or equipped with a core. For cables with a core only at one end, connect the end with the core to the projector.  
 ▶ Make sure that devices are connected to the correct ports. An incorrect connection may result in malfunction or damage to the device and the projector.



**Connecting your devices (continued)**

**NOTE** • Be sure to read the manuals for devices before connecting them to the projector, and make sure that all the devices are suitable to be connected with this product. Before connecting to a PC, check the signal level, the signal timing, and the resolution.

- Some signal may need an adapter to input this projector.
- Some PCs have multiple screen display modes that may include some signals which are not supported by this projector.
- Although the projector can display signals with resolution up to UXGA (1600X1200), the signal will be converted to the projector's panel resolution before being displayed. The best display performance will be achieved if the resolutions of the input signal and the projector panel are identical.
- While connecting, make sure that the shape of the cable's connector fits the port to connect with. And be sure to tighten the screws on connectors with screws.
- When connecting a laptop PC to the projector, be sure to activate the PC's external RGB output. (Set the laptop PC to CRT display or to simultaneous LCD and CRT display.) For details on how this is done, please refer to the instruction manual of the corresponding laptop PC.
- When the picture resolution is changed on a pc depending on an input, automatic adjustment function may take some time and may not be completed. In this case, you may not be able to see a check box to select "Yes/No" for the new resolution on Windows. Then the resolution will go back to the original. It might be recommended to use other CRT or LCD monitors to change the resolution.
- In some cases, this projector may not display a proper picture or display any picture on screen. For example, automatic adjustment may not function correctly with some input signals. An input signal of composite sync or sync on G may confuse this projector, so the projector may not display a proper picture.

**About Plug-and-Play capability**

Plug-and-Play is a system composed of a PC, its operating system and peripheral equipment (i.e. display devices). This projector is VESA DDC 2B compatible. Plug-and-Play can be used by connecting this projector to a pc that is VESA DDC (display data channel) compatible.

- Take advantage of this feature by connecting an RGB cable to the COMPUTER IN1 port (DDC 2B compatible). Plug-and-Play may not work properly if any other type of connection is attempted.
- Please use the standard drivers in your pc as this projector is a Plug-and-Play monitor.

## Connecting power supply

1. Put the connector of the power cord into the AC inlet of the projector.
2. Firmly plug the power cord's plug into the outlet. In a couple of seconds after the power supply connection, the POWER indicator will light up in steady orange.

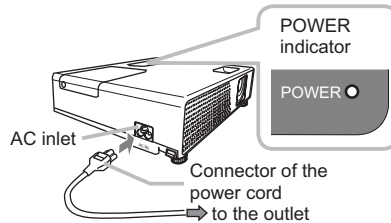

Please remember that when the AUTO ON function (📖37) activated, the connection of the power supply make the projector turn on.

**⚠ WARNING** ► Please use extra caution when connecting the power cord, as incorrect or faulty connections may result in fire and/or electrical shock.

- Only use the power cord that came with the projector. If it is damaged, contact your dealer to newly get correct one.
- Only plug the power cord into an outlet rated for use with the power cord's specified voltage range. The power outlet should be close to the projector and easily accessible. Remove the power cord for complete separation.
- Never modify the power cord.

## Using the security slot

This product has the security slot for the Kensington lock. For details, see the manual of the security tool.

**⚠ WARNING** ► Do not use the security slot to prevent the projector from falling down, since it is not designed for it.

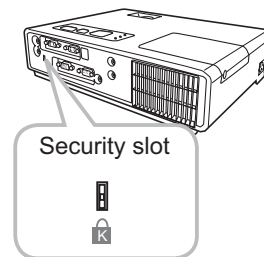

**NOTE** • The security slot is not comprehensive theft prevention measures. It is intended to be used as supplemental theft prevention measure.

## Remote control

**Putting batteries**

Please set the batteries to the remote control before using it. If the remote control starts to malfunction, try to replace the batteries. If you will not use the remote control for long period, remove the batteries from the remote control and store them in a safe place.

1. Holding the hook part of the battery cover, remove it.
2. Align and insert the two AA batteries according to their plus and minus terminals as indicated in the remote control.
3. Replace the battery cover in the direction of the arrow and snap it back into place.

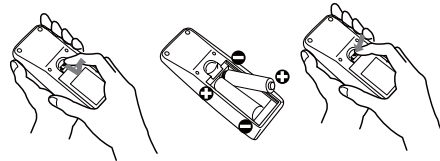

**⚠ WARNING** ► Always handle the batteries with care and use them only as directed. Improper use may result in battery explosion, cracking or leakage, which could result in fire, injury and/or pollution of the surrounding environment.

- Be sure to use only the batteries specified. Do not use batteries of different types at the same time. Do not mix a new battery with used one.
- Make sure the plus and minus terminals are correctly aligned when loading a battery.
- Keep a battery away from children and pets.
- Do not recharge, short circuit, solder or disassemble a battery.
- Do not allow a battery in a fire or water. Keep batteries in a dark, cool and dry place.
- If you observe a leakage of a battery, wipe out the flower and then replace a battery. If the flower adheres your body or clothes, rinse well with water immediately.
- Obey the local laws on disposing the battery.

**About the remote control signal**

The remote control works with the projector's remote sensor. This projector has a remote sensor on the front.

The sensor senses the signal within the following range when the sensor is active:

60 degrees (30 degrees to the left and right of the sensor) within 3 meters about.

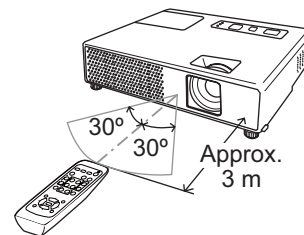

**NOTE** • The remote control signal reflected in the screen or the like may be available. If it is difficult to send the signal to the sensor directly, attempt to make the signal reflect.

- The remote control uses infrared light to send signals to the projector (Class 1 LED), so be sure to use the remote control in an area free from obstacles that could block the remote control's signal to the projector.
- The remote control may not work correctly if strong light (such as direct sun light) or light from an extremely close range (such as from an inverter fluorescent lamp) shines on the remote sensor of the projector. Adjust the position of projector avoiding those lights.

## Changing the frequency of remote control signal

The accessory remote control has the two choices on signal frequency Mode 1:NORMAL and Mode 2:HIGH. If the remote control does not function properly, attempt to change the signal frequency.

In order to set the Mode, please keep pressing the combination of two buttons listed below simultaneously for about 3 seconds.

- (1) Set to Mode 1:NORMAL... MUTE and RESET buttons
  - (2) Set to Mode 2:HIGH... MAGNIFY OFF and ESC buttons
- Please remember that the REMOTE FREQ. in the SERVICE item of the OPTION menu (41) of the projector to be controlled should be set to the same mode as the remote control.

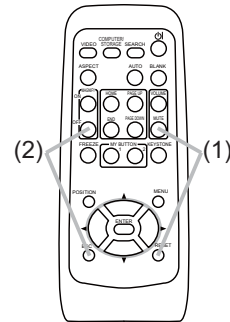

## Using as a simple PC mouse & keyboard

The enclosed remote control works as a simple mouse and keyboard of the PC, when the projector's USB port (B type) connects with the PC's mouse port via a mouse cable.

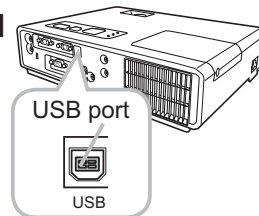

- (1) **HOME key:** Press the HOME button.
- (2) **END key:** Press the END button.
- (3) **PAGE UP key:** Press the PAGE UP button.
- (4) **PAGE DOWN key:** Press the PAGE DOWN button.
- (5) **Mouse left button:** Press the ENTER button.
- (6) **Move pointer:** Use the cursor buttons ▲, ▼, ◀ and ▶.
- (7) **ESC key:** Press the ESC button.
- (8) **Mouse right button:** Press the RESET button.

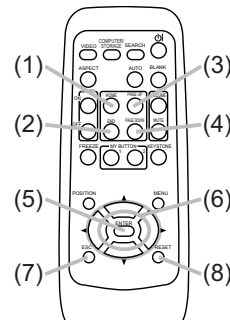

**⚠ CAUTION** ▶ Improper use of the simple mouse & keyboard function could damage your equipment. While using this function, please connect this product only to a PC. Be sure to check your PC's manuals before connecting this product to the PC.

**NOTE** • When the simple mouse & keyboard function of this product does not work correctly, please check the following.

- When the mouse cable connects this projector with a PC having a built-in pointing device (e.g. track ball) like a notebook PC, open BIOS setup menu, then select the external mouse and disable the built-in pointing device, because the built-in pointing device may have priority to this function.
- Windows 95 OSR 2.1 or higher is required for this function. And also this function may not work depending on the PC's configurations and mouse drivers.
- You cannot do things like press two buttons at once (for instance, pressing two buttons at the same time to move the mouse pointer diagonally).
- This function is activated only when the projector is working properly. This function is not available while the lamp is warming up (the POWER indicator flashes green), and while adjusting the volume and display, correcting for keystone, zooming in on the screen, using the BLANK function, or displaying the menu screen.

## Power on/off

**Turning on the power**

1. Make sure that the POWER indicator turns in steady orange and the lens cover is removed.
2. Press the STANDBY/ON button on the projector or the remote control.  
The projection lamp will light up and the POWER indicator will begin blinking in green. When the power is completely on, the indicator will stop blinking and light in steady green.

To display the picture, select an input signal according to the section "Selecting an input signal" (15).

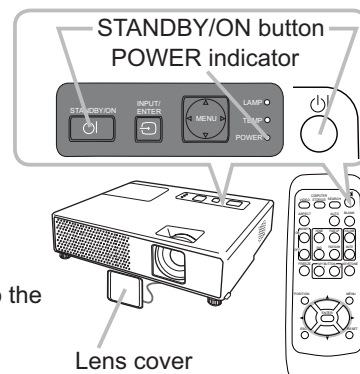
**Turning off the power**

1. Press the STANDBY/ON button on the projector or the remote control. The message "Power off?" will appear on the screen for about 5 seconds.
2. Press the STANDBY/ON button again while the message appears.  
The projector lamp will go off, and the POWER indicator will begin blinking in orange. Then the POWER indicator will stop blinking and light in steady orange when the lamp cooling is complete.
3. Attach the lens cover, after the POWER indicator turns in steady orange.  
Do not turn the projector on for about 10 minutes after turning it off. Turning the projector on again too soon could shorten the lifetime of some consumable parts of the projector.

**⚠ WARNING** ▶ A strong light is emitted when the projector's power is on. Do not look into the lens of the projector or look inside of the projector through any of the projector's openings.

▶ Do not touch around the lamp cover and the exhaust vents during use or just after use, since it is too hot.

▶ Remove the power cord for complete separation.

**NOTE** • Please power on the projector prior to the connected devices. Power off the projector, after all of connected devices are powered off.

- This projector has the function that can make the projector automatically turn on/off. Please refer to the AUTO ON (37) and AUTO OFF (38) items of the OPTION menu.
- Use the shutdown switch (54) only when the projector is not turned off by normal procedure.

Operating

### Adjusting the volume

1. Press the VOLUME button on the remote control.
    - A dialog will appear on the screen to aid you in adjusting the volume.
  2. Use the ▲/▼ cursor buttons to adjust the volume.
    - To close the dialog and complete the operation, press the VOLUME button again. Even if you do not do anything, the dialog will automatically disappear after a few seconds.
- When  $\times$  is selected for the AUDIO item of the SETUP menu (32), the volume adjustment is disable.

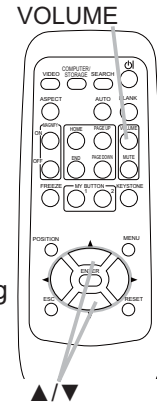

### Temporarily muting the sound

1. Press the MUTE button on the remote control.
    - A dialog will appear on the screen indicating that you have muted the sound.
    - To restore the sound, press the MUTE or VOLUME button. Even if you do not do anything, the dialog will automatically disappear after a few seconds.
- When  $\times$  is selected for the AUDIO item of the SETUP menu (32), the volume adjustment is disable.

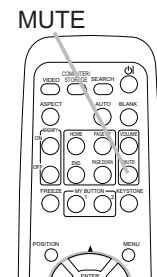

### Selecting an input signal

1. Press the INPUT/ENTER button on the projector.
  - Each time you press the button, the projector switches its input port as below.

COMPUTER IN1 → COMPUTER IN2  
 ↑ VIDEO ← S-VIDEO ←

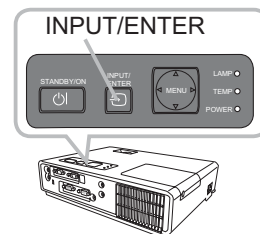

1. Press the COMPUTER/STORAGE button on the remote control.
  - Each time you press the button, the projector switches its input port as below.

COMPUTER IN1 ↔ COMPUTER IN2

- If the COMPUTER/STORAGE button is pushed to switch from a signal from the VIDEO or S-VIDEO port, when TURN ON is selected for the AUTO SEARCH item in the OPTION menu (37), the projector will check the COMPUTER IN1 port first. If no input is detected at the port, the projector will check other port in above order.

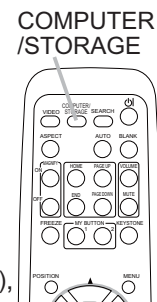

(continued on next page)

### Selecting an input signal (continued)

1. Press the VIDEO button on the remote control.
  - Each time you press the button, the projector switches its input port as below.
    - S-VIDEO ↔ VIDEO
- If the VIDEO button is pushed to switch from a signal from the COMPUTER IN1 or COMPUTER IN2 port, when TURN ON is selected for the AUTO SEARCH item in the OPTION menu (37), the projector will check the S-VIDEO port first. If no input is detected at the port, the projector will check the VIDEO port.

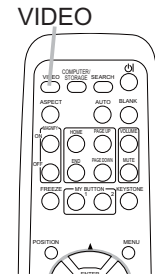

### Searching an input signal

1. Press the SEARCH button on the remote control.
  - The projector will start to check its input ports in order to find any input signals. When an input is found, the projector will stop searching and display the image. If no signal is found, the projector will return to the state selected before the operation.

COMPUTER IN1 → COMPUTER IN2  
 ↑ VIDEO ← S-VIDEO ←

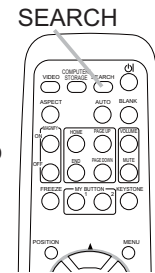

### Selecting an aspect ratio

1. Press the ASPECT button on the remote control.
  - Each time you press the button, the projector switches the mode for aspect ratio in turn.
    - For a PC signal
      - NORMAL → 4:3 → 16:9 → SMALL
      - ↑
    - For a video signal, s-video signal or component video signal
      - 4:3 → 16:9 → 14:9 → SMALL
      - ↑
    - For no signal
      - 4:3 (fixed)
  - The ASPECT button does not work when no proper signal is inputted.
  - The NORMAL mode keeps the original aspect ratio setting.
  - Performing the automatic adjustment initializes the aspect ratio setting.

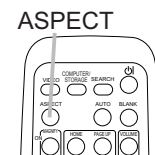

## Adjusting the projector's elevator

When the place to put the projector is slightly uneven to the left or right, use the elevator feet to place the projector horizontally.

Using the feet can also tilt the projector in order to project at a suitable angle to the screen, elevating the front side of the projector within 12 degrees.

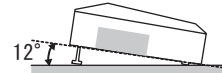

This projector has 2 elevator feet and 2 elevator knobs. An elevator foot is adjustable while pulling up the elevator knob on the same side as it.

1. Holding the projector, pull the elevator knobs up to loose the elevator feet.
2. Position the front side of the projector to the desired height.
3. Release the elevator knobs in order to lock the elevator feet.
4. After making sure that the elevator feet are locked, put the projector gently.
5. If necessary, the elevator feet can be manually twisted to make more precise adjustments. Hold the projector when twisting the feet.

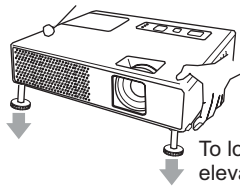

To loose an elevator foot, pull up the elevator knob on the same side as it.

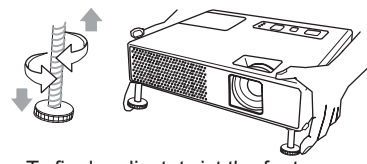

To finely adjust, twist the foot.

**⚠ CAUTION** ▶ Do not handle the elevator knobs without holding the projector, since the projector may drop down.  
 ▶ Do not tilt the projector other than it elevating its front within 12 degrees using the adjuster feet. A tilt of the projector exceeding the restriction could cause malfunction or shortening the lifetime of consumables, or the projector itself.

## Adjusting the zoom and focus

1. Use the zoom ring to adjust the screen size.
2. Use the focus ring to focus the picture.

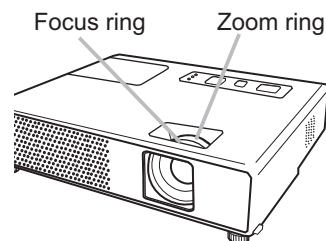





## Correcting the keystone distortions

1. Press the KEYSTONE button on the remote control. A dialog will appear on the screen to aid you in correcting the distortion.
2. Use the ▲/▼ cursor buttons to select the AUTO or MANUAL operation, and press the ► button to perform the following.
  - (1) The AUTO executes automatic vertical keystone correction.
  - (2) The MANUAL displays a dialog for keystone correction. Use the ▲/▼ buttons for adjustment.

To close the dialog and complete this operation, press the KEYSTONE button again. Even if you do not do anything, the dialog will automatically disappear after a few seconds.

- The adjustable range of this correction will vary among inputs. For some input, this function may not work well.
- When V:INVERT or H&V:INVERT is selected to the MIRROR item in the SETUP menu, if the projector screen is inclined or angled downward, this function may not work correctly.
- When the zoom adjustment is set to the TELE (telephoto focus), the automatic keystone distortion correction may be excessive. This function should be used when the zoom adjustment is set to the full WIDE (wide-angle focus) whenever possible.
- When the projector is placed on the level (about  $\pm 0^\circ$ ), the automatic keystone distortion correction may not work.
- When the projector is inclined to near  $\pm 30$  degree or over, this function may not work well.
- This function will be unavailable when Transition Detector is on (46).

KEYSTONE

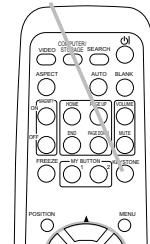

## Using the magnify feature

1. Press the ON button of MAGNIFY on the remote control. The "MAGNIFY" indication will appear on the screen (although the indication will disappear in several seconds with no operation), and the projector will go into the MAGNIFY mode.
2. Use the ▲/▼ cursor buttons to adjust the zoom level. To move the zoom area, press the POSITION button in the MAGNIFY mode, then use the ▲/▼/◀/▶ cursor buttons to move the area. And to finalize the zoom area, press the POSITION button again.

To exit from the MAGNIFY mode and restore the screen to normal, press the OFF button of MAGNIFY on the remote control.

- The projector automatically exits from the MAGNIFY mode when the input signal is changed, or when the display condition is changed.
- Although in the MAGNIFY mode, the keystone distortion condition may vary, it will be restored when the projector exits from the MAGNIFY mode.

MAGNIFY ON/OFF

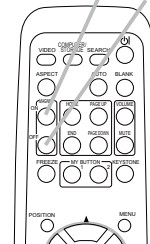

**NOTE** • The zoom level can be finely adjusted. Closely watch the screen to find the level you want.

### Freezing the screen

- 1 Press the FREEZE button on the remote control.
  - The "FREEZE" indication will appear on the screen (although the indication will not appear when the TURN ON is selected to the MESSAGE item of the SCREEN menu (36)), and the projector will go into the FREEZE mode.

To exit the FREEZE mode and restore the screen to normal, press the FREEZE button again.

- The projector automatically exits from the FREEZE mode when one of the projector's buttons or remote control buttons of STANDBY/ON, SEARCH, COMPUTER/STORAGE, VIDEO, BLANK, AUTO, VOLUME, MUTE, KEYSTONE, MENU, MAGNIFY and MY BUTTON1/2(except MyMemory or PICTURE MODE is assigned to) (39) is pressed.
- If the projector continues projecting a still image for a long time, the LCD panel might possibly be burned in. Do not leave the projector in the FREEZE mode for too long.

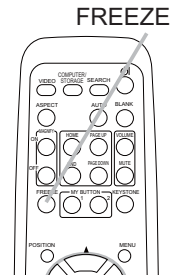

### Temporarily blanking the screen

- 1 Press the BLANK button on the remote control.
  - The blank screen will be displayed instead of the screen of input signal. Please refer to the BLANK item in the SCREEN menu (33).

To exit from the blank screen and return to the input signal screen, press the BLANK button again.

- The projector automatically returns to the input signal screen when one of the projector's buttons or the remote control buttons (except ASPECT, POSITION or FREEZE button, also except MY BUTTON1/2 if AUTO KEYSTONE or MyMemory or PICTURE MODE is assigned on these buttons (39)) is pressed.

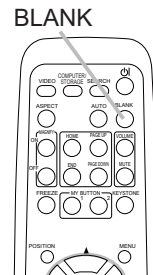

**NOTE** • The sound is not connected with the blank screen function. If necessary, set the volume or mute first.

## Using the menu function

This projector has the following menus: PICTURE, IMAGE, INPUT, SETUP, SCREEN, OPTION and EASY MENU. EASY MENU consists of functions often used, and the other menus are classified into each purpose. Each of these menus is operated using the same methods. The basic operations of these menus are as follows.

1. Press the MENU button on the remote control or the projector. The Advanced MENU, or EASY MENU that has priority just after powered on, will appear. While the projector is displaying any menu, the INPUT/ENTER button on the projector works as the ENTER button and the MENU button on the projector works as the cursor buttons.

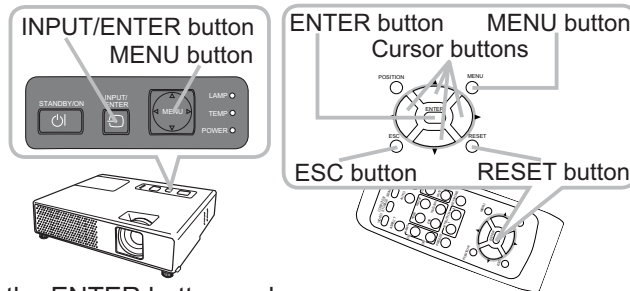

### In the EASY MENU

2. If you want to change it to the Advanced Menu, select the "Go to Advanced Menu..."
3. Use the ▲/▼ cursor buttons to select an item to operate.
4. Use the ◀/▶ cursor buttons to operate the item.

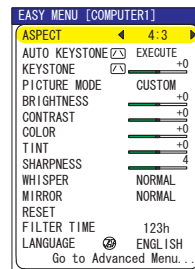

EASY MENU

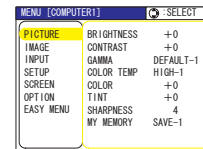

Advanced MENU

### In the Advanced MENU

2. Use the ▲/▼ cursor buttons to select a menu. If you want to change it to the EASY MENU, select the EASY MENU. Then press the ▶ cursor button, or the ENTER button to select an item. The lower layer menu of the selected item will appear.
3. Use the ▲/▼ cursor buttons to select an item to operate. Then press the ▶ cursor button, or the ENTER button to progress. The operation menu of the selected item will appear.
4. Use the ▲/▼ cursor buttons to operate the item. Some functions cannot be performed when a certain input port is selected, or when a certain input signal is displayed. When you want to reset the operation, press the RESET button on the remote control during the operation. Note that some items (ex. LANGUAGE, H PHASE, VOLUME) cannot be reset. In the Advanced Menu, when you want to return to the previous display, press the ◀ cursor button, or the ESC button on the remote control.
5. Press the MENU button on the remote control again to close the menu and complete this operation. Even if you do not do anything, the dialog will automatically disappear after about 10 seconds.

## EASY MENU

### EASY MENU

From the EASY MENU, items shown in the table below can be performed.

Select an item using the ▲/▼ cursor buttons. Then perform it according to the following table.

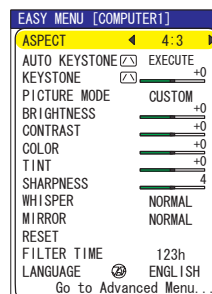

Item	Description																					
<b>ASPECT</b>	Using the ◀/▶ buttons switches the mode for aspect ratio. See the ASPECT item in IMAGE menu (26).																					
<b>AUTO KEYSTONE EXECUTE</b> (↵)	Using the ▶ button executes the auto keystone function. See the AUTO KEYSTONE (↵) EXECUTE item in SETUP menu (31).																					
<b>KEYSTONE</b> (↵)	Using the ◀/▶ buttons corrects the vertical keystone distortion. See the KEYSTONE (↵) item in SETUP menu (31).																					
<b>PICTURE MODE</b>	<p>Using the ◀/▶ buttons switches the picture mode. The picture modes are combinations of GAMMA and COLOR TEMP settings. Choose a suitable mode according to the projected source.</p> <p> </p> <table border="1"> <thead> <tr> <th></th> <th>COLOR TEMP</th> <th>GAMMA</th> </tr> </thead> <tbody> <tr> <td>NORMAL</td> <td>MID DEFAULT</td> <td>#1 DEFAULT</td> </tr> <tr> <td>CINEMA</td> <td>LOW DEFAULT</td> <td>#2 DEFAULT</td> </tr> <tr> <td>DYNAMIC</td> <td>HIGH DEFAULT</td> <td>#3 DEFAULT</td> </tr> <tr> <td>BOARD(BLACK)</td> <td>Hi-BRIGHT-1 DEFAULT</td> <td>#4 DEFAULT</td> </tr> <tr> <td>BOARD(GREEN)</td> <td>Hi-BRIGHT-2 DEFAULT</td> <td>#4 DEFAULT</td> </tr> <tr> <td>WHITEBOARD</td> <td>MID DEFAULT</td> <td>#5 DEFAULT</td> </tr> </tbody> </table> <ul style="list-style-type: none"> <li>• When the combination of GAMMA and COLOR TEMP differs from pre-assigned modes above, the display on the menu for the PICTURE MODE is "CUSTOM". Please refer to the GAMMA (23) and COLOR TEMP (24) items in PICTURE menu.</li> <li>• When this function is performed, a certain extra such as a line may appear.</li> </ul>		COLOR TEMP	GAMMA	NORMAL	MID DEFAULT	#1 DEFAULT	CINEMA	LOW DEFAULT	#2 DEFAULT	DYNAMIC	HIGH DEFAULT	#3 DEFAULT	BOARD(BLACK)	Hi-BRIGHT-1 DEFAULT	#4 DEFAULT	BOARD(GREEN)	Hi-BRIGHT-2 DEFAULT	#4 DEFAULT	WHITEBOARD	MID DEFAULT	#5 DEFAULT
	COLOR TEMP	GAMMA																				
NORMAL	MID DEFAULT	#1 DEFAULT																				
CINEMA	LOW DEFAULT	#2 DEFAULT																				
DYNAMIC	HIGH DEFAULT	#3 DEFAULT																				
BOARD(BLACK)	Hi-BRIGHT-1 DEFAULT	#4 DEFAULT																				
BOARD(GREEN)	Hi-BRIGHT-2 DEFAULT	#4 DEFAULT																				
WHITEBOARD	MID DEFAULT	#5 DEFAULT																				

(continued on next page)

## EASY MENU

### EASY MENU (continued)

Item	Description
<b>BRIGHTNESS</b>	Using the ◀/▶ buttons adjusts the brightness. See the BRIGHTNESS item in PICTURE menu (📖23).
<b>CONTRAST</b>	Using the ◀/▶ buttons adjusts the contrast. See the CONTRAST item in PICTURE menu (📖23).
<b>COLOR</b>	Using the ◀/▶ buttons adjusts the strength of whole color. See the COLOR item in PICTURE menu (📖24).
<b>TINT</b>	Using the ◀/▶ buttons adjusts the tint. See the TINT item in PICTURE menu (📖24).
<b>SHARPNESS</b>	Using the ◀/▶ buttons adjusts the sharpness. See the SHARPNESS item in PICTURE menu (📖24).
<b>WHISPER</b>	Using the ◀/▶ buttons turns off/on the whisper mode. See the WHISPER item in SETUP menu (📖32).
<b>MIRROR</b>	Using the ◀/▶ buttons switches the mode for mirror status. See the MIRROR item in SETUP menu (📖32).
<b>RESET</b>	Performing this item resets all of the EASY MENU items except the FILTER TIME and LANGUAGE. A dialog is displayed for confirmation. Selecting the RESET using the ▲ button performs resetting.
<b>FILTER TIME</b>	Performing this item resets the filter time which counts usage time of the air filter. A dialog is displayed for confirmation. Selecting the RESET using the ▲ button performs resetting. See the FILTER TIME item in OPTION menu (📖38).
<b>LANGUAGE</b>	Using the ◀/▶ buttons changes the display language. See the LANGUAGE item in SCREEN menu (📖33).
<b>Go to Advanced Menu...</b>	Select "Go to Advanced Menu..." on the menu, and press the ▶ or ENTER button to use the menu of PICTURE, IMAGE, INPUT, SETUP, SCREEN or OPTION.

PICTURE Menu

From the PICTURE menu, items shown in the table below can be performed.

Select an item using the ▲/▼ cursor buttons, and press the ► cursor button or ENTER button to execute the item. Then perform it according to the following table.

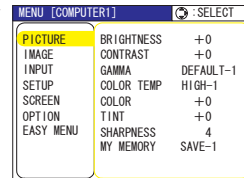

Item	Description
<b>BRIGHTNESS</b>	Using the ▲/▼ buttons adjusts the brightness. Light ⇔ Dark
<b>CONTRAST</b>	Using the ▲/▼ buttons adjusts the contrast. Strong ⇔ Weak
<b>GAMMA</b>	<p>Using the ▲/▼ buttons switches the gamma mode.                      #1 DEFAULT ⇔ #1 CUSTOM ⇔ #2 DEFAULT ⇔ #2 CUSTOM ⇔ #3 DEFAULT                      ⇕                      #5 CUSTOM ⇔ #5 DEFAULT ⇔ #4 CUSTOM ⇔ #4 DEFAULT ⇔ #3 CUSTOM</p> <p><b>To adjust CUSTOM</b></p> <p>Selecting a mode whose name includes CUSTOM and then pressing the ► button or the ENTER button displays a dialog to aid you in adjusting the mode. This function is useful when you want to change the brightness of particular tones.</p> <p>Choose an item using the ◀/▶ buttons, and adjust the level using the ▲/▼ buttons.</p> <p>You can display a test pattern for checking the effect of your adjustment by pressing the ENTER button. Each time you press the ENTER button, the pattern changes as below.</p> <p>No pattern ⇔ Gray scale of 9 steps ⇔ Ramp ⇔ Gray scale of 15 steps</p> <p>The eight equalizing bars correspond to eight tone levels of the test pattern except the darkest in the left end. If you want to adjust the 2nd tone from left end on the test pattern (Gray scale of 9 steps), use the equalizing adjustment bar "1". The darkest tone at the left end of the test pattern cannot be controlled with any of equalizing adjustment bar.</p> <ul style="list-style-type: none"> <li>When this function is performed, lines or other distortion may appear.</li> </ul>

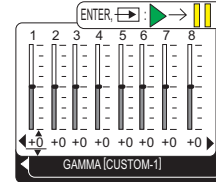

(continued on next page)

**PICTURE Menu**

**PICTURE Menu (continued)**

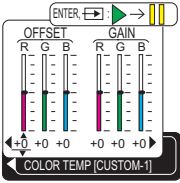
Item	Description
<p><b>COLOR TEMP</b></p>	<p>Using the ▲/▼ buttons switches the color temperature mode.</p> <p>→ HIGH DEFAULT ⇄ HIGH CUSTOM ⇄ MID DEFAULT ⇄ MID CUSTOM ←          → LOW DEFAULT ⇄ LOW CUSTOM ⇄ HI-BRIGHT-1 DEFAULT ⇄ HI-BRIGHT-1 CUSTOM ←          → HI-BRIGHT-2 DEFAULT ⇄ HI-BRIGHT-2 CUSTOM ←</p> <p><b>To adjust CUSTOM</b></p> <p>Selecting a mode whose name includes CUSTOM and then pressing the ► button or the ENTER button displays a dialog to aid you in adjusting the OFFSET and GAIN of the selected mode.</p> <p>OFFSET adjustments change the color intensity on the whole tones of the test pattern.</p> <p>GAIN adjustments mainly affect color intensity on the brighter tones of the test pattern.</p> <p>Choose an item using the ◀/▶ buttons, and adjust the level using the ▲/▼ buttons.</p> <p>You can display a test pattern for checking the effect of your adjustment by pressing the ENTER button. Each time you press the ENTER button, the pattern changes as below.</p> <p>No pattern ⇄ Gray scale of 9 steps ⇄          ⇄ Ramp ⇄ Gray scale of 15 steps</p> <ul style="list-style-type: none"> <li>• When this function is performed, lines or other distortion may appear.</li> </ul> 
<p><b>COLOR</b></p>	<p>Using the ▲/▼ buttons adjusts the strength of whole color.</p> <p>Strong ⇄ Weak</p> <ul style="list-style-type: none"> <li>• This item can be selected only for a video signal, s-video or component video signal.</li> </ul>
<p><b>TINT</b></p>	<p>Using the ▲/▼ buttons adjusts the tint.</p> <p>Greenish ⇄ Reddish</p> <ul style="list-style-type: none"> <li>• This item can be selected only for a video signal, s-video or component video signal.</li> </ul>
<p><b>SHARPNESS</b></p>	<p>Using the ▲/▼ buttons adjusts the sharpness.</p> <p>Strong ⇄ Weak</p> <ul style="list-style-type: none"> <li>• There may be some noise and/or the screen may flicker for a moment when an adjustment is made. This is not a malfunction.</li> </ul>

(continued on next page)

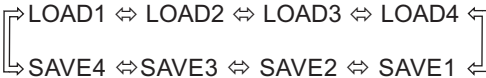

**PICTURE Menu (continued)**

Item	Description
<p><b>MY MEMORY</b></p>	<p>This projector has 4 memories for adjustment data (for all the items of the PICTURE menu).                      Selecting a function using the ▲/▼ buttons and pressing the ► or ENTER button performs each function.</p> <p style="text-align: center;">  </p> <p><b><u>LOAD1, LOAD2, LOAD3, LOAD4</u></b></p> <p>Performing a LOAD function loads the data from the memory linked in the number included in the function's name, and adjusts the picture automatically depending on the data.</p> <ul style="list-style-type: none"> <li>• The LOAD functions whose linked memory has no data are skipped.</li> <li>• Remember that the current adjusted condition will be lost by loading data. If you want to keep the current adjustment, please save it before performing a LOAD function.</li> <li>• There may be some noise and the screen may flicker for a moment when loading data. This is not malfunction.</li> <li>• The LOAD functions can be also performed by the MY MEMORY button which can be set by the MY BUTTON item in OPTION menu (p.29).</li> </ul> <p><b><u>SAVE1, SAVE2, SAVE3, SAVE4</u></b></p> <p>Performing a SAVE function saves the current adjustment data into the memory linked in the number included in the function's name.</p> <ul style="list-style-type: none"> <li>• Remember that the current data being stored of a memory will be lost by saving a new data into the memory.</li> </ul>

## IMAGE Menu

### IMAGE Menu

From the IMAGE menu, items shown in the table below can be performed.

Select an item using the ▲/▼ cursor buttons, and press the ► cursor button or ENTER button to execute the item. Then perform it according to the following table.

MENU [COMPUTER1]		◀ SELECT
PICTURE	ASPECT	4:3
IMAGE	OVER SCAN	5
INPUT	V POSITION	25
SETUP	H POSITION	142
SCREEN	H PHASE	16
OPTION	H SIZE	1344
EASY MENU	AUTO ADJUST	EXECUTE

Item	Description
<b>ASPECT</b>	<p>Using the ▲/▼ buttons switches the mode for aspect ratio.</p> <p><b>For a PC signal</b>            NORMAL ⇔ 4:3 ⇔ 16:9 ⇔ SMALL            ↑—————↑</p> <p><b>For a Video signal, s-video signal or component video signal</b>            4:3 ⇔ 16:9 ⇔ 14:9 ⇔ SMALL            ↑—————↑</p> <p><b>For no signal</b>            4:3 (fixed)</p> <ul style="list-style-type: none"> <li>• This item can be selected only for a proper signal.</li> <li>• The NORMAL mode keeps the original aspect ratio setting.</li> <li>• Performing the automatic adjustment initializes the aspect ratio setting.</li> </ul>
<b>OVER SCAN</b>	<p>Using the ▲/▼ buttons adjusts the over-scan ratio.</p> <p>Large (It reduces picture) ⇔ Small (It magnifies picture)</p> <ul style="list-style-type: none"> <li>• This item can be selected only for a video, s-video and component video signal.</li> <li>• When this adjustment is too large, certain degradation may appear at the frame area of the picture. In such a case, please adjust small.</li> </ul>
<b>V POSITION</b>	<p>Using the ▲/▼ buttons adjusts the vertical position.</p> <p>Up ⇔ Down</p> <ul style="list-style-type: none"> <li>• Over-adjusting the vertical position may cause noise to appear on the screen. If this occurs please reset the vertical position to the default setting. Pressing the RESET button when the V POSITION is selected will reset the V POSITION to the default setting.</li> <li>• When this function is performed on a video signal, s-video signal, or component video signal, the range of this adjustment depends on the OVER SCAN (👉above) setting. It is not possible to adjust when the OVER SCAN is set to 10.</li> </ul>
<b>H POSITION</b>	<p>Using the ▲/▼ buttons adjusts the horizontal position.</p> <p>Left ⇔ Right</p> <ul style="list-style-type: none"> <li>• Over-adjusting the horizontal position may cause noise to appear on the screen. If this occurs please reset the horizontal position to the default setting. Pressing the RESET button when the H POSITION is selected will reset the H POSITION to the default setting.</li> <li>• When this function is performed on a video signal, s-video signal, or component video signal, the range of this adjustment depends on the OVER SCAN (👉above) setting. It is not possible to adjust when the OVER SCAN is set to 10.</li> </ul>

(continued on next page)

**IMAGE Menu (continued)**

Item	Description
<b>H PHASE</b>	Using the ▲/▼ buttons adjusts the horizontal phase to eliminate flicker. Right ⇔ Left • This item can be selected only for a computer signal or component video signal.
<b>H SIZE</b>	Using the ▲/▼ buttons adjusts the horizontal size. Large ⇔ Small • This item can be selected only for a computer signal. • When this adjustment is excessive, the picture may not be displayed correctly. In such a case, please reset the adjustment by pressing the RESET button during this operation.
<b>AUTO ADJUST EXECUTE</b>	Selecting this item performs the automatic adjustment feature. <b>For a PC signal</b> The vertical position, the horizontal position, the horizontal phase and the horizontal size (📖40) will be automatically adjusted. And the aspect ratio will be automatically set to the default. Make sure that the application window is set to its maximum size prior to attempting to use this feature. A dark picture may still be incorrectly adjusted. Use a bright picture when adjusting. <b>For a video signal, s-video signal or component video signal</b> The video format best suited for the respective input signal will be selected automatically. This function is available only when the AUTO mode is selected to the VIDEO FORMAT item in INPUT menu (📖29). The vertical position, horizontal position and aspect ratio will be automatically set to the the default. For a component video signal, also the horizontal phase will be automatically set to the default. • The automatic adjustment operation requires about 10 seconds. Also please note that it may not function correctly with some input.

## INPUT Menu

### INPUT Menu

From the INPUT menu, items shown in the table below can be performed.

Select an item using the ▲/▼ cursor buttons, and press the ► cursor button or ENTER button to execute the item. Then perform it according to the following table.

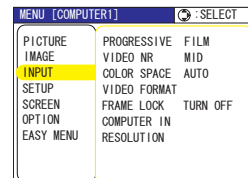

Item	Description
<b>PROGRESSIVE</b>	<p>Using the ▲/▼ buttons switches the progress mode. TV ⇄ FILM ⇄ TURN OFF</p> <ul style="list-style-type: none"> <li>• This function is performed only for an interlaced signal of a video, s-video or component video of 525i (480i) or 625i (576i) signal.</li> <li>• When TV or FILM is selected, the screen image will be sharp. FILM adapts to the 2-3 Pull-Down conversion system. But these may cause a certain defect (for example, jagged line) of the picture for a quick moving object. In such a case, please select TURN OFF, even though the screen image may lose the sharpness.</li> </ul>
<b>VIDEO NR</b>	<p>Using the ▲/▼ buttons switches the noise reduction mode. HIGH ⇄ MID ⇄ LOW</p> <ul style="list-style-type: none"> <li>• This function performs only for a video, s-video or component video of 525i(480i) or 625i(576i) signal.</li> <li>• When this function is excessive, it may cause a certain degradation of the picture.</li> </ul>
<b>COLOR SPACE</b>	<p>Using the ▲/▼ buttons switches the mode for color space. AUTO ⇄ RGB ⇄ SMPTE240 ⇄ REC709 ⇄ REC601</p> <p style="text-align: center;">↑</p> <ul style="list-style-type: none"> <li>• This item can be selected only for a computer signal or component video signal.</li> <li>• The AUTO mode automatically selects the optimum mode.</li> <li>• The AUTO operation may not work well at some signals. In such a case, it might be good to select a suitable mode except AUTO.</li> </ul>



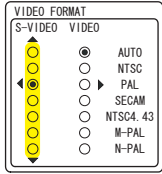

(continued on next page)

**INPUT Menu (continued)**

Item	Description
<p><b>VIDEO FORMAT</b></p>	<p>Set the video format for the s-video port and video port.                      (1) Use the ◀/▶ buttons to select the input port.                      (2) Using the ▲/▼ buttons switches the mode for video format.                      AUTO ⇔ NTSC ⇔ PAL ⇔ SECAM                      ⤴ N-PAL ⇔ M-PAL ⇔ NTSC4.43 ⤵</p>  <ul style="list-style-type: none"> <li>• This item is performed only for a video signal from the VIDEO port or the S-VIDEO port.</li> <li>• The AUTO mode automatically selects the optimum mode.</li> <li>• The AUTO operation may not work well for some signals. If the picture becomes unstable (e.g. an irregular picture, lack of color), please select the mode according to the input signal.</li> </ul>
<p><b>FRAME LOCK</b></p>	<p>Using the ▲/▼ buttons turns the frame lock function on/off.                      TURN ON ⇔ TURN OFF</p> <ul style="list-style-type: none"> <li>• This item can be performed only on a computer signal with a vertical frequency of 50 to 60 Hz.</li> <li>• When the TURN ON is selected, a moving pictures are displayed more smoothly.</li> <li>• This function may cause a certain degradation of the picture. In such a case, please select the TURN OFF.</li> </ul>
<p><b>COMPUTER IN</b></p>	<p>Set the computer input signal type for the ports of COMPUTER.                      (1) Use the ◀/▶ buttons to select a COMPUTER port to be set.                      COMPUTER IN1 ⇔ COMPUTER IN2                      (2) Use the ▲/▼ buttons to select the computer input signal type.                      AUTO ⇔ SYNC ON G OFF</p> <p>Sync on Green signal can be supported, if AUTO is selected.</p> <ul style="list-style-type: none"> <li>• When the AUTO is selected, the picture may be distorted with certain input signals. In such a case, remove the signal connector first and select SYNC ON G OFF on the menu, and then reconnect the signal.</li> <li>• Component signal can be supported through COMPUTER IN1 port, if AUTO is selected for the COMPUTER IN1 port.</li> </ul>

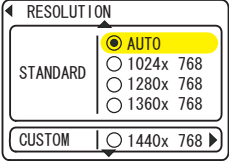
(continued on next page)

INPUT Menu (continued)

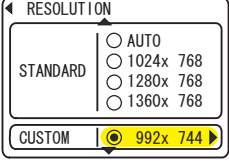
Item	Description
<p><b>RESOLUTION</b></p>	<p>The resolution for the COMPUTER IN1 and COMPUTER IN2 input signals can be set on this projector.</p> <p>(1) In the INPUT menu select the RESOLUTION using the ▲/▼ buttons and press the ► button. The RESOLUTION menu will be displayed.</p>  <p>(2) In the RESOLUTION menu, select the resolution you wish to display using the ▲/▼ buttons. Selecting AUTO will set a resolution appropriate to the input signal.</p> <p>(3) Pressing the ► or ENTER button when selecting a STANDARD resolution will automatically adjust the horizontal and vertical positions, clock phase and horizontal size and automatically select an aspect ratio. The INFORMATION dialog (41) will be displayed.</p>  <p>(4) To set a custom resolution use the ▲/▼ buttons to select the CUSTOM and the CUSTOM RESOLUTION box will be displayed. Set the horizontal (HORZ) and vertical (VERT) resolutions using the ▲/▼/◀/▶ buttons. Although not all resolutions are guaranteed.</p>  <p>(5) To save the setting place the cursor on the right-most digit and press the ► button. The horizontal and vertical positions, clock phase and horizontal size will be automatically adjusted and an aspect ratio will be automatically selected. After the INFORMATION (41) dialog has displayed for about 10 seconds the screen will return to the RESOLUTION menu displaying the changed resolution.</p>   <p>(6) To revert back to the previous resolution without saving changes place the cursor on the left-most digit and press the ◀ button. The screen will then return to the RESOLUTION menu displaying the previous resolution.</p> <ul style="list-style-type: none"> <li>• For some pictures, this function may not work well.</li> </ul>

SETUP Menu

From the SETUP menu, items shown in the table below can be performed.

Select an item using the ▲/▼ cursor buttons, and press the ► cursor button on the ENTER button to execute the item. Then perform it according to the following table.

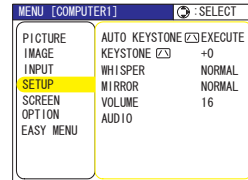

Item	Description
<b>AUTO KEYSTONE EXECUTE</b> (trapezoid icon)	<p>Selecting this item performs the automatic keystone distortion correction. Projector automatically corrects vertical keystone distortion due to the (forward/backward) setup angle by itself. This function will be executed only once when selected in the menu. When the slant of the projector is changed, execute this function again.</p> <ul style="list-style-type: none"> <li>• The adjustable range for correction will vary among inputs. For some input, this function may not work well.</li> <li>• When V:INVERT or H&amp;V:INVERT is selected to the MIRROR item in the SETUP menu, if the projector screen is inclined or angled downward, this function may not work correctly.</li> <li>• When the zoom adjustment is set to the TELE (telephoto focus), this function may be excessive. This function should be used when the zoom adjustment is set to the full WIDE (wide-angle focus) whenever possible.</li> <li>• When the projector is placed on the level (about ±0°), this function may not work.</li> <li>• When the projector is inclined to near ±30 degree or over, this function may not work well.</li> <li>• This function will be unavailable when the Transition Detector is on (46).</li> </ul>
<b>KEYSTONE</b> (trapezoid icon)	<p>Using the ▲/▼ buttons corrects the vertical keystone distortion. Shrink the top of the image ⇔ Shrink the bottom of the image</p> <ul style="list-style-type: none"> <li>• The adjustable range of this function will vary with the type of input signal. For some input, this function may not work well.</li> <li>• This function will be unavailable when the Transition Detector is on (46).</li> </ul>

(continued on next page)

**SETUP Menu**

**SETUP Menu (continued)**

Item	Description
<b>WHISPER</b>	Using the ▲/▼ buttons turns off/on the whisper mode. NORMAL ⇔ WHISPER • When the WHISPER is selected, acoustic noise and screen brightness are reduced.
<b>MIRROR</b>	Using the ▲/▼ buttons switches the mode for mirror status.  NORMAL ⇔ H:INVERT ⇔ V:INVERT ⇔ H&V:INVERT ↑—————↑ If the Transition Detector is TURN ON and MIRROR status is changed, Transition Detector Alarm (46) will be displayed when projector is restarted after the power switch is turned off.
<b>VOLUME</b>	Using the ▲/▼ buttons adjusts the volume. High ⇔ Low
<b>AUDIO</b>	Allocates the audio ports. (1) Choose a picture input port using the ▲/▼ buttons. (2) Select the audio port to be interlocked with the input port using the ◀/▶ buttons. 1 ⇔ 2 ⇔ ✕ • When ✕ is selected to an input port, any audio ports do not work interlocking with the input port, and any items in AUDIO menu are invalid.

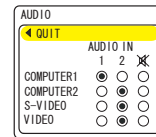



SCREEN Menu

From the SCREEN menu, items shown in the table below can be performed.

Select an item using the ▲/▼ cursor buttons, and press the ► cursor button or ENTER button to execute the item. Then perform it according to the following table.

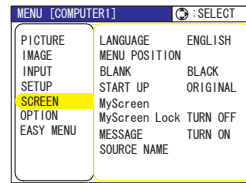

Item	Description								
<b>LANGUAGE</b>	<p>Using the ▲/▼ buttons switches the OSD (On Screen Display) language.</p> <p>ENGLISH ⇄ FRANÇAIS ⇄ DEUTSCH ⇄ ESPAÑOL ⇄ ITALIANO</p> <p>NORSK ⇄ NEDERLANDS ⇄ PORTUGUÊS ⇄ 日本語</p> <p>简体中文 ⇄ 繁體中文 ⇄ 한글 ⇄ SVENSKA ⇄ РУССКИЙ</p> <p>SUOMI ⇄ POLSKI ⇄ TÜRKÇE</p>								
<b>MENU POSITION</b>	<p>Using the ▲/▼/◀/▶ buttons adjusts the menu position.</p> <p>To quit the operation, press the MENU button on the remote control or keep no operation for about 10 seconds.</p>								
<b>BLANK</b>	<p>Using the ▲/▼ buttons switches the mode for the blank screen. The blank screen is a screen for the temporarily blanking feature (19). It is displayed by pressing the BLANK button.</p> <p>MyScreen ⇄ ORIGINAL ⇄ BLUE ⇄ WHITE ⇄ BLACK</p> <table border="1"> <thead> <tr> <th></th> <th>Feature</th> </tr> </thead> <tbody> <tr> <td>MyScreen</td> <td>Screen can be registered by the MyScreen item (35).</td> </tr> <tr> <td>ORIGINAL</td> <td>Screen preset as the standard screen.</td> </tr> <tr> <td>BLUE, WHITE, BLACK</td> <td>Plain screens in each color.</td> </tr> </tbody> </table> <p>• To avoid remaining as an afterimage, the MyScreen or ORIGINAL screen will change to the plain black screen after several minutes.</p>		Feature	MyScreen	Screen can be registered by the MyScreen item (35).	ORIGINAL	Screen preset as the standard screen.	BLUE, WHITE, BLACK	Plain screens in each color.
	Feature								
MyScreen	Screen can be registered by the MyScreen item (35).								
ORIGINAL	Screen preset as the standard screen.								
BLUE, WHITE, BLACK	Plain screens in each color.								

(continued on next page)

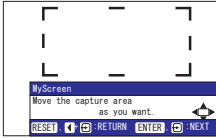

SCREEN Menu (continued)

Item	Description
<p><b>MyScreen</b></p>	<p>This item allows you to capture an image for use as a MyScreen image which can be used as the BLANK screen and START UP screen. Display the image you want to capture before executing the following procedure.</p> <ol style="list-style-type: none"> <li>1. Selecting this item displays a dialog titled "MyScreen". It will ask you if you start capturing an image from the current screen.                      <p>Please wait for the target image to be displayed, and press the ENTER button when the image is displayed. The image will freeze and the frame for capturing will appear. To stop performing, press the RESET or ESC button.</p> </li> <li>2. Using the ▲/▼/◀/▶ buttons adjusts the frame position.                      <p>Please move the frame to the position of the image which you want to use. The frame may not be able to be moved for some input signals. To start registration, press the ENTER button. To restore the screen and return to the previous dialog, press the RESET or ESC button. Registration takes several minutes. When the registration is completed, the registered screen and the following message is displayed for several seconds: <b>"MyScreen registration is finished."</b> If the registration failed, the following message is displayed: <b>"A capturing error has occurred. Please try again."</b></p> <ul style="list-style-type: none"> <li>• This function cannot be selected when the TURN ON is selected to the MyScreen Lock item (<a href="#">below</a>).</li> <li>• This function cannot be selected when the TURN ON is selected to the MyScreen PASSWORD of SECURITY item in OPTION menu (<a href="#">43</a>).</li> </ul> </li> </ol>
<p><b>MyScreen Lock</b></p>	<p>Using the ▲/▼ buttons turns on/off the MyScreen lock function. TURN ON ⇔ TURN OFF</p> <p>When the TURN ON is selected, the MyScreen item is locked. Use this function for protecting the current MyScreen.</p> <ul style="list-style-type: none"> <li>• This function cannot be selected when the TURN ON is selected to the MyScreen PASSWORD of SECURITY item in OPTION menu (<a href="#">43</a>).</li> </ul>

(continued on next page)

SCREEN Menu (continued)

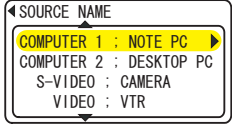
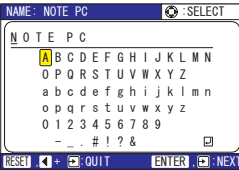
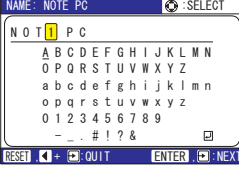
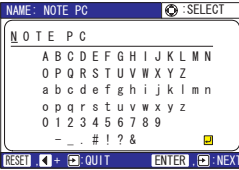
Item	Description
<p><b>MESSAGE</b></p>	<p>Using the ▲/▼ buttons turns on/off the message function. TURN ON ⇔ TURN OFF</p> <p>When the TURN ON is selected, the following message function works. “AUTO IN PROGRESS” while automatically adjusting “NO INPUT IS DETECTED” “SYNC IS OUT OF RANGE” “Searching....” while searching for the input “Detecting....” while an input signal is detected The indication of the input signal displayed by changing The indication of the aspect ratio displayed by changing The indication of the PICTURE MODE displayed by changing The indication of the MY MEMORY displayed by changing The indication of “FREEZE” and “II” while freezing the screen by pressing the FREEZE button.</p> <ul style="list-style-type: none"> <li>• When the TURN OFF is selected, please remember if the picture is freezing. Do not mistake freezing for a malfunction (19).</li> </ul>
<p><b>SOURCE NAME</b></p>	<p>Each input port for this projector can have a name applied to it.</p> <p>(1) Use the ▲/▼ buttons on the SCREEN menu to select SOURCE NAME and press the ► button. The SOURCE NAME menu will be displayed.</p>  <p>(2) Use the ▲/▼ buttons on the SOURCE NAME menu to select the port to be named and press the ► button. Right side of the menu is blank until a name is specified. The SOURCE NAME dialog will be displayed.</p>  <p>(3) The current name will be displayed on the first line. Use the ▲/▼/◀/▶ buttons and the ENTER or INPUT button to select and enter characters. The RESET button can be used to erase 1 character at a time. The name can be a maximum of 16 characters.</p>  <p>(4) To change an already inserted character, press the ▲ button while the cursor is on the [A-N] row to move the cursor to the name displayed on the first line and use the ◀/▶ buttons to select character to be changed. Once a character in the name is selected use the ▼ button to move the cursor back down to the character entry area to select and enter characters as described above.</p>  <p>(5) Select [ ] and press the ENTER or INPUT buttons when finished entering text. To revert to the previous name without saving changes press the ESC or ◀ button and the INPUT button simultaneously.</p>

OPTION Menu

From the OPTION menu, items shown in the table below can be performed.

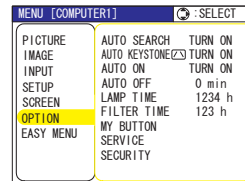

Select an item using the ▲/▼ cursor buttons, and press the ► cursor button or ENTER button to execute the item, except for the items LAMP TIME and FILTER TIME. Then perform it according to the following table.



Item	Description
<b>AUTO SEARCH</b>	<p>Using the ▲/▼ buttons turns on/off the automatic signal search function. TURN ON ⇔ TURN OFF</p> <p>When the TURN ON is selected, detecting no signal automatically cycles through input ports in the following order. The search is started from the current port. Then when an input is found, the projector will stop searching and display the image.</p> <p style="text-align: center;">COMPUTER IN1 ⇔ COMPUTER IN2  </p>
<b>AUTO KEYSTONE</b>	<p>Using the ▲/▼ buttons turns on/off the automatic keystone function. TURN ON ⇔ TURN OFF</p> <p>TURN ON : Automatic keystone distortion correction will be executed whenever changing the slant of the projector.</p> <p>TURN OFF : This function is disabled. Please execute the AUTO KEYSTONE  EXECUTE in the SETUP Menu for automatic keystone distortion correction.</p> <ul style="list-style-type: none"> <li>• When the projector is suspended from the ceiling this feature will not function properly so select the TURN OFF.</li> <li>• This function will be unavailable when the Transition Detector is on (46).</li> </ul>
<b>AUTO ON</b>	<p>Using the ▲/▼ buttons turns on/off the AUTO ON function. TURN ON ⇔ TURN OFF</p> <p>When set to the TURN ON, the lamp in projector will be automatically turned on without the usual procedure (13), only when the projector is supplied with the power after the power was cut while the lamp was on.</p> <ul style="list-style-type: none"> <li>• This function does not work as long as the power has been supplied to the projector while the lamp is off.</li> <li>• After turning the lamp on by the AUTO ON function, if neither input nor operation is detected for about 30 minutes, the projector is turned off, even though the AUTO OFF function (38) is disabled.</li> </ul>







(continued on next page)

**OPTION Menu (continued)**

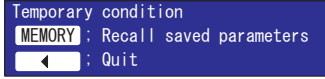
Item	Description
<p><b>AUTO OFF</b></p>	<p>Using the ▲/▼ buttons adjusts the time to count down to automatically turn the projector off.                      Long (max. 99 minutes) ⇔ Short (min. 0 minute = DISABLE)</p> <div style="display: flex; justify-content: space-around; align-items: center;">   </div> <p>When the time is set to 0, the projector is not turned off automatically. When the time is set to 1 to 99, and when the passed time with no-signal or an unsuitable signal reaches at the set time, the projector lamp will be turned off.                      If one of the projector's buttons or the remote control buttons is pressed or one of the commands (except get commands) is transmitted to the control port during the corresponding time, projector will not be turned off.                      Please refer to the section "Turning off the power" (13).</p>
<p><b>LAMP TIME</b></p>	<p>The lamp time is the time counted after the last resetting. It is shown in the OPTION menu as the usage time of the lamp. Pressing the RESET button or the ► button displays a dialog. To reset the lamp time, select the RESET using the ▲ button.                      RESET ⇔ CANCEL</p> <ul style="list-style-type: none"> <li>• Please reset the lamp time only when you have replaced the lamp, for a suitable indication about the lamp.</li> <li>• For the lamp replacement, see the section "Lamp" (48).</li> </ul>
<p><b>FILTER TIME</b></p>	<p>The filter time is the time counted after the last resetting. It is shown in the OPTION menu as the usage time of the air filter. Pressing the RESET button or the ► button displays a dialog. To reset the filter time, select the RESET using the ▲ button.                      RESET ⇔ CANCEL</p> <ul style="list-style-type: none"> <li>• Please reset the filter time only when you have cleaned or replaced the air filter, for a suitable indication about the air filter.</li> <li>• For the air filter cleaning, see the section "Air filter" (50).</li> </ul>

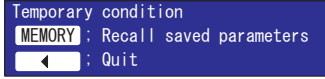
(continued on next page)

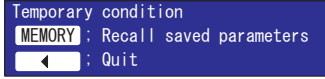
OPTION Menu (continued)

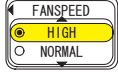
Item	Description		
<p><b>MY BUTTON</b></p>	<p>This item is to assign one of the following function to MY BUTTON 1 and 2 on the remote control (☐5). Choose 1 or 2 on the MY BUTTON menu using the ◀/▶ button first. Then using the ▲/▼ buttons sets one of the following functions to the chosen button.</p> <ul style="list-style-type: none"> <li>• COMPUTER1: Sets port to COMPUTER IN1.</li> <li>• COMPUTER2: Sets port to COMPUTER IN2.</li> <li>• S-VIDEO: Sets port to S-VIDEO.</li> <li>• VIDEO: Sets port to VIDEO.</li> <li>• INFORMATION: Displays a dialog of INPUT INFORMATION (☐41).</li> <li>• AUTO KEYSTONE [☐] EXECUTE: Performs automatic keystone distortion correction (☐31).</li> <li>• MY MEMORY: Loads one of adjustment data stored (☐25).</li> </ul> <table border="0" style="width: 100%;"> <tr> <td style="width: 50%; vertical-align: top;"> <p>When the current adjustment is not saved to memory a dialog is displayed.</p>  </td> <td style="width: 50%; vertical-align: top;"> <p>When no data is saved in memory, a dialog is displayed.</p>  </td> </tr> </table> <p>If you want to keep the current adjustment, please press the ◀ button to quit. Otherwise the current adjusted condition will be lost by loading a data.</p> <ul style="list-style-type: none"> <li>• PICTURE MODE: Changes the PICTURE MODE (☐21).</li> <li>• FILTER RESET: Displays the filter time reset confirmation dialogue (☐38).</li> <li>• VOLUME+: Set the volume up.</li> <li>• VOLUME-: Set the volume down.</li> </ul>	<p>When the current adjustment is not saved to memory a dialog is displayed.</p> 	<p>When no data is saved in memory, a dialog is displayed.</p> 
<p>When the current adjustment is not saved to memory a dialog is displayed.</p> 	<p>When no data is saved in memory, a dialog is displayed.</p> 		
<p><b>SERVICE</b></p>	<p>Selecting this item displays the SERVICE menu. Select an item using the ▲/▼ buttons, and press the ▶ button or the ENTER button to execute the item.</p> <p style="text-align: center;">FAN SPEED ⇄ AUTO ADJUST ⇄ GHOST ⇄ FILTER MESSAGE ⇄ KEY LOCK</p> <p style="text-align: center;">↙      ↘ FACTORY RESET ⇄ INFORMATION ⇄ REMOTE FREQ.</p> <p><b>FAN SPEED</b> Using the ▲/▼ buttons switches the rotation speed of the cooling fans. The HIGH is the mode for use at highlands etc. Note that the projector is noisier when the HIGH is selected. HIGH ⇄ NORMAL</p> 		

(continued on next page)







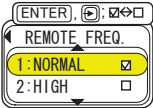
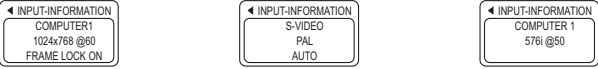

OPTION Menu (continued)

Item	Description
<p><b>SERVICE</b> (continued)</p>	<p><b>KEY LOCK</b> Using the ▲/▼ buttons turns on/off the key lock feature. When TURN ON is selected, the buttons on the projector except the STANDBY/ON button are locked. TURN ON ⇔ TURN OFF</p> <ul style="list-style-type: none"> <li>• Please use to avoid a mischief and touching accidentally. This function does not have any effect on the remote control.</li> </ul> <p><b>REMOTE FREQ.</b> Use the ▲/▼ button to change the Projector's remote sensor setting. 1:NORMAL ⇔ 2:HIGH</p> <p>Items with a checkmark are on. The factory default setting is for both 1:NORMAL and 2: HIGH to be on. If the remote control does not function correctly set this to either only 1 or only 2 (12). Neither can be turned off at the same time.</p>  <p><b>INFORMATION</b> Selecting this item displays a dialog titled "INPUT INFORMATION". It shows the information about the current input.</p>  <ul style="list-style-type: none"> <li>• The "FRAME LOCK" message on the dialog means the frame lock function is working.</li> <li>• This item can't be selected for no signal and sync out.</li> </ul> <p><b>FACTORY RESET</b> Selecting RESET using the button ▲ performs this function. By this function, all the items in all of menus will collectively return to the initial setting. Note that the items LAMP TIME, FILTER TIME, LANGUAGE and SECURITY are not reset. RESET ⇔ CANCEL</p>

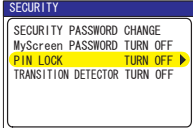
(continued on next page)

OPTION Menu (continued)

Item	Description
<p align="center"><b>SECURITY</b></p>	<p>This projector is equipped with security functions. User registration is required before using the security functions. Please contact your local dealer.</p>
	<p><b>1. Using Security Features</b></p>
	<p><b>1.1 Inputting the PASSWORD</b></p> <p>1.1-1 Use the ▲/▼ buttons on the OPTION menu to select SECURITY and press the ► button. The ENTER PASSWORD box will be displayed.</p>  <p>The factory default PASSWORD is <b>2805</b>. This PASSWORD can be changed (1.2 Changing the PASSWORD).</p> <ul style="list-style-type: none"> <li>It is strongly recommended the factory default PASSWORD to be changed as soon as possible.</li> </ul>
	<p>1.1-2 Use the ▲/▼/◀/▶ buttons to enter the registered PASSWORD. Move the cursor to the right side of the ENTER PASSWORD BOX and press the ► button to display the SECURITY menu.</p> <p>If an incorrect PASSWORD is input the ENTER PASSWORD BOX will be displayed again. If incorrect PASSWORD is input 3 times the projector will turn off. Afterwards the projector will turn off every time an incorrect PASSWORD is input.</p> 
	<p><b>1.2 Changing the PASSWORD</b></p>
<p>1.2-1 Use the ▲/▼ buttons on the SECURITY menu to select SECURITY PASSWORD CHANGE and press the ► button to display the ENTER NEW PASSWORD BOX.</p> 	
<p>1.2-2 Use the ▲/▼/◀/▶ buttons to enter the new PASSWORD.</p>	
<p>1.2-3 Move the cursor to the right side of the ENTER NEW PASSWORD BOX and press the ► button to display the NEW PASSWORD AGAIN BOX, enter the same PASSWORD again.</p> 	
<p>1.2-4 Move the cursor to the right side of the NEW PASSWORD AGAIN BOX and press the ► button and the NOTE NEW PASSWORD BOX will be displayed for about 20 seconds, please make note of the PASSWORD during this time.</p> <p>Pressing the ENTER button will close the NOTE NEW PASSWORD BOX.</p> <ul style="list-style-type: none"> <li>Please do not forget your PASSWORD.</li> </ul> 	

(continued on next page)

OPTION Menu (continued)

Item	Description
<p><b>SECURITY</b> (continued)</p>	<p><b>1.3 If you have forgotten your PASSWORD</b></p> <p>1.3-1 Follow the procedure in 1.1-1 to display the ENTER PASSWORD BOX.</p> <p>1.3-2 While the ENTER PASSWORD BOX is displayed, press and hold the RESET button for about 3 seconds or press and hold the INPUT and ► buttons on the projector for about 3 seconds</p> <p>The 10 digit Inquiring Code will be displayed.</p> <ul style="list-style-type: none"> <li>• If there is no key input for about 55 seconds while the Inquiring Code is displayed the menu will close. If necessary repeat the process from 1.3-1.</li> </ul> <p>1.3-3 Contact your dealer with the 10 digit Inquiring Code. Your PASSWORD will be sent after your user registration information is confirmed.</p>
	<p><b>2. Using the MyScreen PASSWORD Function</b></p> <p>The MyScreen PASSWORD function can be used to prohibit access to the MyScreen function and prevent the currently registered MyScreen image from being overwritten.</p> <p><b>2.1 Turning on the MyScreen PASSWORD Function</b></p> <p>2.1-1 Use the ▲/▼ buttons on the SECURITY menu to select MyScreen PASSWORD and press the ► button to display the MyScreen PASSWORD on/off menu.</p>
	<p><b>2.2 Setting the PASSWORD</b></p> <p>2.2-1 Display the MyScreen on/off menu using the procedure in 2.1-1.</p> <p>2.2-2 Use the ▲/▼ buttons on the MyScreen PASSWORD on/off menu to select TURN ON. The ENTER PASSWORD BOX (small) will be displayed.</p>
	<p>2.2-3 Use the ▲/▼/◀/▶ buttons to enter the PASSWORD. Move the cursor to the right side of the ENTER PASSWORD BOX (small) and press the ► button to display the CHECK PASSWORD BOX, enter the same PASSWORD again.</p>

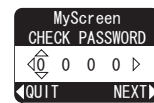
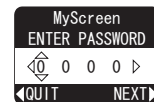
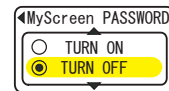

(continued on next page)

OPTION Menu (continued)

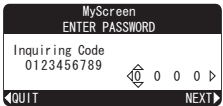
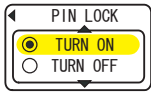
Item	Description
<p><b>SECURITY</b> (continued)</p>	<p>2.2-4 Move the cursor to the right side of the CHECK PASSWORD BOX and press the ► button to display the PASSWORD for about 20 seconds, please make note of the PASSWORD during this time.</p>  <p>Pressing the ENTER button will return to MyScreen PASS WORD on/off menu.</p> <p>When a PASSWORD is set for MyScreen:</p> <ul style="list-style-type: none"> <li>• The MyScreen registration function (and menu) will be unavailable.</li> <li>• The MyScreen Lock function (and menu) will be unavailable.</li> <li>• The START UP setting will be locked on MyScreen (and the menu will be unavailable).</li> </ul> <p>Turning the MyScreen PASSWORD off will allow normal operation of both functions.</p> <ul style="list-style-type: none"> <li>• Please do not forget your MyScreen PASSWORD.</li> </ul> <p><b>2.3 Turning the PASSWORD off</b></p> <p>2.3-1 Follow the procedure in 2.1-1 to display the MyScreen PASSWORD on/off menu.</p> <p>2.3-2 Select TURN OFF to display the ENTER PASSWORD BOX (large). Enter the registered PASSWORD and the screen will return to the MyScreen on/off menu.</p> <p>If an incorrect PASSWORD is input the menu will close. If necessary repeat the process from 2.3-1.</p>
	<p><b>2.4 If you have forgotten your PASSWORD</b></p> <p>2.4-1 Follow the procedure in 2.1-1 to display the MyScreen PASSWORD on/off menu.</p> <p>2.4-2 Select TURN OFF to display the ENTER PASSWORD BOX (large). The 10 digit Inquiring Code will be displayed inside the BOX.</p>  <p>2.4-3 Contact your dealer with the 10 digit Inquiring Code. Your PASSWORD will be sent after your user registration information is confirmed.</p> <p><b>3. Using the PIN LOCK Function</b></p> <p>PIN LOCK is a function which prevents the projector from being used unless a registered Code is input.</p> <p><b>3.1 Registering the PIN Code</b></p> <p>3.1-1 Use the ▲/▼ buttons on the SECURITY menu to select PIN LOCK and press the ► button or the ENTER button to display the PIN LOCK on/off menu.</p> 

(continued on next page)



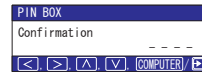
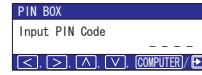

**OPTION Menu (continued)**

Item	Description
<p><b>SECURITY</b> (continued)</p>	<p>3.1-2 Use the ▲/▼ buttons on the PIN LOCK on/off menu to select TURN ON and the PIN BOX will be displayed.</p> <p>3.1-3 Input a 4 part PIN Code using the ▲, ▼, ◀, ▶, COMPUTER/STORAGE and INPUT buttons.</p> <p>A CONFIRMATION BOX will appear. Reenter the same PIN Code. This will complete the PIN Code registration.</p> <ul style="list-style-type: none"> <li>• If there is no key input for about 55 seconds while the PIN BOX or the CONFIRMATION BOX are displayed the menu will close. If necessary repeat the process from 3.1-1.</li> </ul> <p>Afterwards, anytime the projector is restarted after the power switch is turned off the PIN BOX will be displayed. Enter the registered PIN Code. The projector can be used after entering the registered PIN Code. If an incorrect PIN Code is input the PIN BOX will be displayed again. If an incorrect PIN Code is input 3 times the projector will turn off. Afterwards the projector will turn off every time an incorrect PIN Code is input. The projector will also turn off if there is no key input for about 5 minutes while the PIN BOX is displayed.</p> <p>This function will activate only when the projector is started after the power switch was turned off.</p> <ul style="list-style-type: none"> <li>• Please do not forget your PIN Code.</li> </ul> <p><b>3.2 Turning Off the PIN LOCK Function</b></p> <p>3.2-1 Follow the procedure in 3.1-1 to display the PIN LOCK on/off menu. Use the ▲/▼ buttons to select TURN OFF and the PIN BOX will be displayed.</p> <p>Enter the registered PIN Code to turn the PIN LOCK function off. If an incorrect PASSWORD is entered the menu will close.</p>
	<p><b>3.3 If you have forgotten your PIN Code</b></p> <p>3.3-1 While the PIN BOX is displayed, press and hold the RESET button for three seconds or press and hold the INPUT and ▶ buttons for three seconds. The 10 digit Inquiring Code will be displayed.</p> <ul style="list-style-type: none"> <li>• If there is no key input for about 5 minutes while the Inquiring Code is displayed the projector will turn off.</li> </ul> <p>3.3-2 Contact your dealer with the 10 digit Inquiring Code. Your PASSWORD will be sent after your user registration information is confirmed.</p>

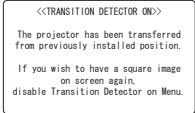

(continued on next page)

OPTION Menu (continued)

Item	Description
<p><b>SECURITY</b> (continued)</p>	<p><b>4. Using the Transition Detector Function</b> While the Transition Detector function is ON, when power switch is started to supply to the projector, it might react as below.</p> <ul style="list-style-type: none"> <li>• Transition Detector alarm shown below might appear on screen, if the projector has been moved or re-installed.</li> <li>• Transition Detector alarm might appear on screen, if the MIRROR setting has been changed.</li> <li>• Keystone adjustment feature has been prohibited as long as the Transition Detector function is ON.</li> </ul> <p><b>4.1 Turning On the Transition Detector Function</b></p> <p>4.1-1 Use the ▲/▼ buttons on the SECURITY menu to select Transition Detector and press the ► or the ENTER button to display the Transition Detector on/off menu.</p>  <p>Select TURN ON and the current angle and mirror setting will be recorded.</p> <ul style="list-style-type: none"> <li>• This feature may not function properly if the projector is not in a stable position when TURN ON is selected.</li> </ul> <p>4.1-2 If this function is set to TURN ON when the vertical angle of the projector or mirror setting at which the projector is turned on is different than the previously recorded the Transition Detector Alarm will be displayed and the projector will not display the input signal.</p>  <p>Set the Transition Detector off in the SECURITY menu to display the input signal. If the Transition Detector ALARM is displayed for about 5 minutes the lamp will turn off. This function will activate only when the projector is started after the power switch was turned off.</p> <p><b>4.2 Setting the Transition Detector PASSWORD</b></p> <p>4.2-1 Use the ▲/▼ buttons on the SECURITY menu to select Transition Detector and press the ► or the ENTER button to display the Transition Detector on/off menu.</p> <p>4.2-2 Use the ▲/▼ buttons on the Transition Detector on/off menu to select TURN ON. The ENTER PASSWORD BOX (small) will be displayed.</p>  <p>4.2-3 Use the ▲/▼/◀/▶ buttons to enter a PASSWORD. Move the cursor to the right side of the ENTER PASSWORD BOX (small) and press the ► button to display the CHECK PASSWORD BOX, enter the same PASSWORD again.</p>  <p>4.2-4 Move the cursor to the right side of the CHECK PASSWORD BOX and press the ► button to display the PASSWORD for about 20 seconds, please make note of the PASSWORD during this time.</p>  <p>Pressing the ENTER button will return to the Transition Detector on/off menu.</p> <ul style="list-style-type: none"> <li>• Please do not forget your Transition Detector PASSWORD.</li> </ul>

(continued on next page)

**OPTION Menu (continued)**

Item	Description
<p><b>SECURITY</b> (continued)</p>	<p><b>4.3 Setting the Transition Detector off</b>                      4.3-1 Follow the procedure in 4.1-1 to display the Transition Detector on/off menu.                       4.3-2 Select TURN OFF to display the ENTER PASSWORD BOX (large). Enter the registered PASSWORD and the screen will return to the Transition Detector on/off menu. If an incorrect PASSWORD is input the menu will close. If necessary repeat the process from 4.3-1.</p>
	<p><b>4.4 If you have forgotten your PASSWORD</b>                      4.4-1 Follow the procedure in 4.1-1 to display the Transition Detector on/off menu.                       4.4-2 Select TURN OFF to display the ENTER PASSWORD BOX (large). The 10 digit Inquiring Code will be displayed inside the BOX.</p>
	<p>4.4-3 Contact your dealer with the 10 digit Inquiring Code. Your PASSWORD will be sent after your user registration information is confirmed.</p>
	

## Maintenance

**Lamp**

A lamp has finite product life. Using the lamp for long periods of time could cause the pictures darker or the color tone poor. Note that each lamp has a different lifetime, and some may burst or burn out soon after you start using them.

Preparation of a new lamp and early replacement are recommended. To prepare a new lamp, contact your dealer and tell the lamp type number.

**Type number : DT00781**

**Replacing the lamp**

1. Turn the projector off, and unplug the power cord.  
Allow the projector to cool for at least 45 minutes.
2. Prepare a new lamp.  
If the projector is mounted on a ceiling, or if the lamp has broken, also ask the dealer to replace the lamp.

The lamp cover

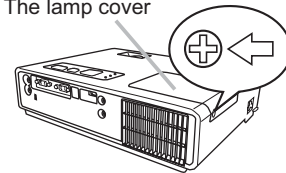
**In case of replacement by yourself,**

3. Loosen the screw (marked by arrow) of the lamp cover and then slide the lamp cover to the side to remove it.
4. Loosen the 2 screws (marked by arrow) of the lamp, and slowly pick up the lamp by the handle.  
It may make it easy to take the lamp out slightly toward the control panel of the projector.
5. Insert the new lamp, and retighten firmly the 2 screws of the lamp that are loosened in the previous process to lock it in place. Tighten the screw ① first, then screw ②.
6. Slide the lamp cover back in place and firmly fasten the screw of the lamp cover.
7. Turn the projector on and reset the lamp time using the LAMP TIME item in the OPTION menu.
  - (1) Press the MENU button to display a menu.
  - (2) Point at the "Go to Advanced Menu ..." in the menu using the ▼/▲ button, then press the ► button.
  - (3) Point at the "OPTION" in the left column of the menu using the ▼/▲ button, then press the ► button.
  - (4) Point at the "LAMP TIME" using the ▼/▲ button, then press the ► button. A dialog will appear.
  - (5) Press the ▲ button to select "RESET" on the dialog. It performs resetting the lamp time.

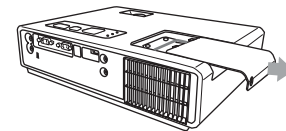

The handle

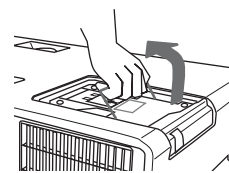
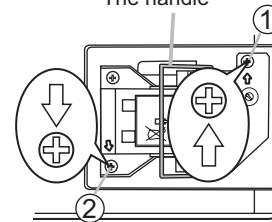

**⚠ CAUTION** ► Do not touch any inner space of the projector, while the lamp is taken out.

**NOTE** • Please reset the lamp time only when you have replaced the lamp, for a suitable indication about the lamp.



**Lamp (continued)****Lamp warning**

 **HIGH VOLTAGE**    **HIGH TEMPERATURE**    **HIGH PRESSURE**

**⚠ WARNING** ► The projector uses a high-pressure mercury glass lamp. The lamp can break with a loud bang, or burn out, if jolted or scratched, handled while hot, or worn over time. Note that each lamp has a different lifetime, and some may burst or burn out soon after you start using them. In addition, when the bulb bursts, it is possible for shards of glass to fly into the lamp housing, and for gas containing mercury to escape from the projector's vent holes.

► **About disposal of a lamp:** This product contains a mercury lamp; do not put it in a trash. Dispose of it in accordance with environmental laws.

- For lamp recycling, go to [www.lamprecycle.org](http://www.lamprecycle.org). (in the US).
- For product disposal, contact your local government agency or [www.eiae.org](http://www.eiae.org) (in the US) or [www.epsc.ca](http://www.epsc.ca) (in Canada).

For more information, call your dealer.



Disconnect  
the plug  
from the  
power  
outlet

- If the lamp should break (it will make a loud bang when it does), unplug the power cord from the outlet, and make sure to request a replacement lamp from your local dealer. Note that shards of glass could damage the projector's internals, or cause injury during handling, so please do not try to clean the projector or replace the lamp yourself.
- If the lamp should break (it will make a loud bang when it does), ventilate the room well, and make sure not to breathe the gas that comes out of the projector vents, or get it in your eyes or mouth.
- Before replacing the lamp, turn the projector off and unplug the power cord, then wait at least 45 minutes for the lamp to cool sufficiently. Handling the lamp while hot can cause burns, as well as damaging the lamp.



- Never unscrew except the appointed (marked by an arrow) screws.
- Do not open the lamp cover while the projector is suspended from above. This is dangerous, since if the lamp's bulb has broken, the shards will fall out when the cover is opened. In addition, working in high places is dangerous, so ask your local dealer to have the lamp replaced even if the bulb is not broken.
- Do not use the projector with the lamp cover removed. At the lamp replacing, make sure that the screws are screwed in firmly. Loose screws could result in damage or injury.



- Use only the lamp of the specified type.
- If the lamp breaks soon after the first time it is used, it is possible that there are electrical problems elsewhere besides the lamp. If this happens, contact your local dealer or a service representative.
- Handle with care: jolting or scratching could cause the lamp bulb to burst during use.
- Using the lamp for long periods of time, could cause it dark, not to light up or to burst. When the pictures appear dark, or when the color tone is poor, please replace the lamp as soon as possible. Do not use old (used) lamps; this is a cause of breakage.

## Air filter

Please check and clean the air filter periodically. When the indicators or a message prompts you to clean the air filter, comply with it as soon as possible. Replace the air filter when it is damaged or too soiled. To prepare a new air filter, contact your dealer and tell the air filter type number.

**Type number : MU03602**

When you replace the lamp, please replace the air filter. An air filter of specified type will come together with a replacement lamp for this projector.

### Cleaning the air filter

1. Turn the projector off, and unplug the power cord. Allow the projector to sufficiently cool down.
2. Use a vacuum cleaner on and around the filter cover.
3. While supporting the projector with one hand, use your other hand to pull the filter cover forward in the direction of the arrow.
4. Use a vacuum cleaner for the filter ventilation of the projector. And clean the air filter that is set at one side of the filter cover by using a vacuum cleaner over the other side of the filter cover. Please replace the air filter when it is damaged or too soiled. When the air filter is set, take its half moon shape cut part to the swelled part of the filter cover.
5. Put the filter unit back into the projector.
6. Turn the projector on and reset the filter time using the FILTER TIME item in the EASY MENU.
  - (1) Press the MENU button to display a menu.
  - (2) Point at the "FILTER TIME" using the ▼/▲ button, then press the ► button. A dialog will appear.
  - (3) Press the ▲ button to select "RESET" on the dialog. It performs resetting the filter time.

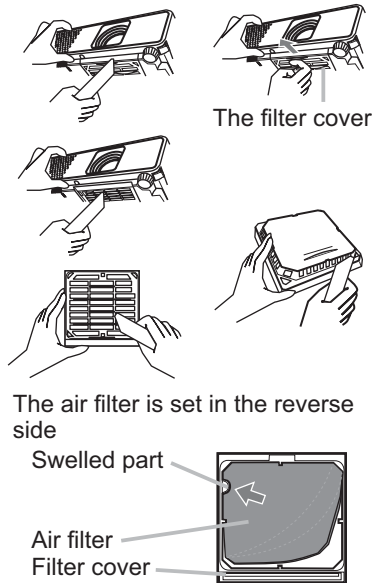

**⚠ WARNING** ► Before taking care of the air filter, make sure the power cable is not plugged in, then allow the projector to cool sufficiently.  
 ► Use only the air filter of the specified type. Do not use the projector without the air filter or the filter cover. It could result in a fire or malfunction to the projector.  
 ► Clean the air filter periodically. If the air filter becomes clogged by dust or the like, internal temperatures rise and could cause a fire, a burn or malfunction to the projector.

**NOTE** • Please reset the filter time only when you have cleaned or replaced the air filter, for a suitable indication about the air filter.  
 • The projector may display the message such as "CHECK THE AIR FLOW" or turn off the projector, to prevent the internal heat level rising.

## Other care

### Inside of the projector

In order to ensure the safe use of your projector, please have it cleaned and inspected by your dealer about once every year.

### Caring for the lens

If the lens is flawed, soiled or fogged, it could cause deterioration of display quality. Please take care of the lens, being cautious of handling.

1. Turn the projector off, and unplug the power cord. Allow the projector to cool sufficiently.
2. After making sure that the projector is cool adequately, lightly wipe the lens with a commercially available lens-cleaning wipe. Do not touch the lens directly with your hand.

### Caring for the cabinet and remote control

Incorrect care could have adverse influence such as discoloration, peeling paint, etc.

1. Turn the projector off, and unplug the power cord. Allow the projector to cool sufficiently.
2. After making sure that the projector is cool adequately, lightly wipe with gauze or a soft cloth.  
If the projector is extremely dirty, dip soft cloth in water or a neutral cleaner diluted in water, and wipe lightly after wringing well. Then, wipe lightly with a soft, dry cloth.

**⚠ WARNING** ▶ Before caring, make sure the power cable is not plugged in, and then allow the projector to cool sufficiently. The care in a high temperature state of the projector could cause a burn and/or malfunction to the projector.

▶ Never try to care for the inside of the projector personally. Doing is so dangerous.

▶ Avoid wetting the projector or inserting liquids in the projector. It could result in a fire, an electric shock, and/or malfunction to the projector.

• Do not put anything containing water, cleaners or chemicals near the projector.

• Do not use aerosols or sprays.

**⚠ CAUTION** ▶ Please take right care of the projector according to the following. Incorrect care could cause not only an injury but adverse influence such as discoloration, peeling paint, etc.

▶ Do not use cleaners or chemicals other than those specified in this manual.

▶ Do not polish or wipe with hard objects.

## Troubleshooting

If an abnormal operation should occur, stop using the projector immediately.

**⚠WARNING ▶** Never use the projector if abnormal operations such as smoke, strange odor, excessive sound, damaged casing or elements or cables, penetration of liquids or foreign matter, etc. should occur. In such cases, immediately disconnect the power plug from the power outlet. After making sure that the smoke or odor has stopped, contact your dealer or service company.

Otherwise if a problem occurs with the projector, the following checks and measures are recommended before requesting repair. If this does not resolve the problem, please contact your dealer or service company. They will tell you what warranty condition is applied.

### Related messages

When some message appears, check and cope with it according to the following table. Although these messages will be automatically disappeared around several minutes, it will be reappeared every time the power is turned on.

Message	Description
<p><b>NO INPUT IS DETECTED</b> ***</p>	<p><b>There is no input signal.</b> Please confirm the signal input connection, and the status of the signal source.</p>
<p><b>SYNC IS OUT OF RANGE</b> *** [fH] **kHz [fV] **Hz</p>	<p><b>The horizontal or vertical frequency of the input signal is not within the specified range.</b> Please confirm the specs for your projector or the signal source specs.</p>
<p><b>CHECK THE AIR FLOW</b></p>	<p><b>The internal temperature is rising.</b> Please turn the power off, and allow the projector to cool down at least 20 minutes. After having confirmed the following items, please turn the power ON again.</p> <ul style="list-style-type: none"> <li>• Is there blockage of the air passage aperture?</li> <li>• Is the air filter dirty?</li> <li>• Does the peripheral temperature exceed 35°C?</li> </ul> <p>If the same indication is displayed after the remedy, please set FAN SPEED of the SERVICE item in the OPTION menu to HIGH.</p>
<p><b>REMINDER</b> <b>*** HRS PASSED AFTER THE LAST FILTER CHECK. FILTER MAINTENANCE IS ESSENTIAL TO REMOVE WARNING MESSAGE, RESET FILTER TIMER. SEE MANUAL FURTHER INFO.</b></p>	<p><b>A note of precaution when cleaning the air filter.</b> Please immediately turn the power off, and clean or change the air filter referring to the "Air Filter" section of this manual. After you have cleaned or changed the air filter, please be sure to reset the filter timer (📖50).</p>

## Regarding the indicator lamps

When operation of the LAMP, TEMP and POWER indicators differs from usual, check and cope with it according to the following table.

POWER indicator	LAMP indicator	TEMP indicator	Description
Lighting In <b>Orange</b>	Turned <b>off</b>	Turned <b>off</b>	<b>The projector is in a standby state.</b> Please refer to the section "Power on/off".
<i>Blinking</i> In <b>Green</b>	Turned <b>off</b>	Turned <b>off</b>	<b>The projector is warming up.</b> Please wait.
Lighting In <b>Green</b>	Turned <b>off</b>	Turned <b>off</b>	<b>The projector is in an on state.</b> Ordinary operations may be performed.
<i>Blinking</i> In <b>Orange</b>	Turned <b>off</b>	Turned <b>off</b>	<b>The projector is cooling down.</b> Please wait.
<i>Blinking</i> In <b>Red</b>	(discretionary)	(discretionary)	<b>The projector is cooling down. A certain error has been detected.</b> Please wait until the POWER indicator finishes blinking, and then perform the proper measure using the item descriptions below.
<i>Blinking</i> In <b>Red</b> or Lighting In <b>Red</b>	Lighting In <b>Red</b>	Turned <b>off</b>	<b>The lamp does not light, and there is a possibility that interior portion has become heated.</b> Please turn the power off, and allow the projector to cool down at least 20 minutes. After the projector has sufficiently cooled down, please make confirmation of the following items, and then turn the power on again. • Is there blockage of the air passage aperture? • Is the air filter dirty? • Does the peripheral temperature exceed 35°C? If the same indication is displayed after the remedy, please change the lamp referring to the section "Lamp".
<i>Blinking</i> In <b>Red</b> or Lighting In <b>Red</b>	<i>Blinking</i> In <b>Red</b>	Turned <b>off</b>	<b>The lamp cover has not been properly fixed.</b> Please turn the power off, and allow the projector to cool down at least 45 minutes. After the projector has sufficiently cooled down, please make confirmation of the attachment state of the lamp cover. After performing any needed maintenance, turn the power on again. If the same indication is displayed after the remedy, please contact your dealer or service company.
<i>Blinking</i> In <b>Red</b> or Lighting In <b>Red</b>	Turned <b>off</b>	<i>Blinking</i> In <b>Red</b>	<b>The cooling fan is not operating.</b> Please turn the power off, and allow the projector to cool down at least 20 minutes. After the projector has sufficiently cooled down, please make confirmation that no foreign matter has become caught in the fan, etc., and then turn the power on again. If the same indication is displayed after the remedy, please contact your dealer or service company.

(continued on next page)

**Regarding the indicator lamps (continued)**

POWER indicator	LAMP indicator	TEMP indicator	Description
Blinking In <b>Red</b> or Lighting In <b>Red</b>	Turned off	Lighting In <b>Red</b>	<p><b>There is a possibility that the interior portion has become heated.</b></p> <p>Please turn the power off, and allow the projector to cool down at least 20 minutes. After the projector has sufficiently cooled down, please make confirmation of the following items, and then turn the power on again.</p> <ul style="list-style-type: none"> <li>• Is there blockage of the air passage aperture?</li> <li>• Is the air filter dirty?</li> <li>• Does the peripheral temperature exceed 35°C?</li> </ul> <p>If the same indication is displayed after the remedy, please set FAN SPEED of the SERVICE item in the OPTION menu to HIGH.</p>
Lighting In <b>Green</b>	Simultaneous blinking in <b>Red</b>		<p><b>It is time to clean the air filter.</b></p> <p>Please immediately turn the power off, and clean or change the air filter referring to the section "Air Filter". After cleaning or changing the air filter, please be sure to reset the filter timer. After the remedy, reset the power to ON.</p>
Lighting In <b>Green</b>	Alternative blinking in <b>Red</b>		<p><b>There is a possibility that the interior portion has become overcooled.</b></p> <p>Please use the unit within the usage temperature parameters (5°C to 35°C). After the treatment, reset the power to ON.</p>

**NOTE** • When the interior portion has become overheated, for safety purposes, the projector is automatically shut down, and the indicator lamps may also be turned off. In such a case, disconnect the power cord, and wait at least 45 minutes. After the projector has sufficiently cooled down, please make confirmation of the attachment state of the lamp and lamp cover, and then turn the power on again.

**Shutting the projector down**

Only when the projector can not be turned off by usual procedure (413), please push the shutdown switch using a pin or similar, and disconnect the power plug from the power outlet. Before turning it on again, wait at least 10 minutes to make the projector cool down enough.

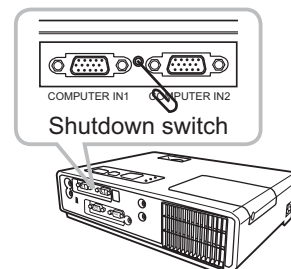

**Resetting all settings**

When it is hard to correct some wrong settings, the FACTORY RESET function of the SERVICE item in the OPTION menu (441) can reset all settings(except LANGUAGE, FILTER TIME, LAMP TIME, FILTER MESSAGE and etc.) to the factory default.

### Phenomena that may be easy to be mistaken for machine defects

About the phenomenon confused with a machine defect, check and cope with it according to the following table.

Phenomenon	Cases not involving a machine defect	Reference page
Power does not come on.	<b>The electrical power cord is not plugged in.</b> Correctly connect the power cord.	10
	<b>The main power source has been interrupted during operation such as by a power outage (blackout), etc.</b> Please disconnect the power plug from the power outlet, and allow the projector to cool down at least 10 minutes, then turn the power on again.	10, 13
	<b>Either there is no lamp and/or lamp cover, or either of these has not been properly fixed.</b> Please turn the power off and disconnect the power plug from the power outlet, and allow the projector to cool down at least 45 minutes. After the projector has sufficiently cooled down, please make confirmation of the attachment state of the lamp and lamp cover, and then turn the power on again.	48
Neither sounds nor pictures are outputted.	<b>The signal cables are not correctly connected.</b> Correctly connect the connection cables.	8
	<b>Signal source does not correctly work.</b> Correctly set up the signal source device by referring to the manual of the source device.	–
	<b>The input changeover settings are mismatched.</b> Select the input signal, and correct the settings.	14, 15
Sound does not come out.	<b>The signal cables are not correctly connected.</b> Correctly connect the audio cables.	8
	<b>The MUTE function is working.</b> Restore the sound pressing the MUTE or VOLUME button on the remote control.	14
	<b>The volume is adjusted to an extremely low level.</b> Adjust the volume to a higher level using the menu function or the remote control.	14
	<b>The AUDIO setting is not correct.</b> Correctly set the AUDIO in the SETUP menu.	32
No pictures are displayed.	<b>The lens cover is attached.</b> Remove the lens cover.	13
	<b>The signal cables are not correctly connected.</b> Correctly connect the connection cables.	8

(continued on next page)

**Phenomena that may be easy to be mistaken for machine defects (continued)**

Phenomenon	Cases not involving a machine defect	Reference page
No pictures are displayed. (continued)	<b>The brightness is adjusted to an extremely low level.</b> Adjust BRIGHTNESS to a higher level using the menu function or the remote control.	21, 23
	<b>The computer cannot detect the projector as a plug and play monitor.</b> Make sure that the computer can detect a plug and play monitor using another plug and play monitor.	9
	<b>The BLANK screen is displayed.</b> Press the BLANK button on the remote control.	19
Video screen display freezes.	<b>The FREEZE function is working.</b> Press the FREEZE button to restore the screen to normal.	19
Colors have a faded- out appearance, or Color tone is poor.	<b>Color settings are not correctly adjusted.</b> Perform picture adjustments by changing the COLOR TEMP, COLOR, TINT and/or COLOR SPACE settings, using the menu functions.	21, 24, 28
	<b>COLOR SPACE setting is not suitable.</b> Change the COLOR SPACE setting to AUTO, RGB, SMPTE240, REC709 or REC601.	28
Pictures appear dark.	<b>The brightness and/or contrast are adjusted to an extremely low level.</b> Adjust BRIGHTNESS and/or CONTRAST settings to a higher level using the menu function.	21, 23
	<b>The WHISPER function is working.</b> Select NORMAL for the WHISPER item in the SETUP menu.	22, 32
	<b>The lamp is approaching the end of its product lifetime.</b> Replace the lamp.	48
Pictures appear blurry.	<b>Either the focus and/or horizontal phase settings are not properly adjusted.</b> Adjust the focus using the focus ring, and/or H PHASE using the menu function.	16, 27
	<b>The lens is dirty or misty.</b> Clean the lens referring to the section "Caring for the lens".	51

**NOTE** • Although bright spots or dark spots may appear on the screen, this is a unique characteristic of liquid crystal displays, and it does not constitute or imply a machine defect.



Specifications

Specifications

Item	Specification	
Product name	Liquid crystal projector	
Liquid Crystal Panel	Panel size	1.6 cm (0.63 type)
	Drive system	TFT active matrix
	Pixels	786,432 pixels (1024 horizontal x 768 vertical)
Lens	Zoom lens F=1.8 ~ 1.9 f = 16.4~ 19.7 mm	
Lamp	160W UHB	
Speaker	1 W x1	
Power supply	AC100-120V/2.8A, AC220-240V/1.4A	
Power consumption	250 W	
Temperature range	5 ~ 35°C (Operating)	
Size	274 (W) x 59 (H) x 205 (D) mm * Not including protruding parts. Please refer to the following figure.	
Weight (mass)	1.8 kg	
Ports	<b>Computer input port</b> COMPUTER IN1 .....D-sub 15 pin mini x1 COMPUTER IN2 .....D-sub 15 pin mini x1 <b>Monitor output port</b> MONITOR OUT .....D-sub 15 pin mini x1 <b>Video input port</b> S-VIDEO ..... S-video x1 VIDEO ..... video x1 <b>Audio input/output port</b> AUDIO IN1 ..... Stereo mini x1 AUDIO IN2 ..... Stereo mini x1 AUDIO OUT ..... Stereo mini x1 <b>Communication port</b> CONTROL ..... D-sub 9pin x1 USB .....USB-B x1	
Optional parts	<b>Lamp:</b> DT00781 <b>Air filter:</b> MU03602 <b>Others:</b> Please consult your dealer.	

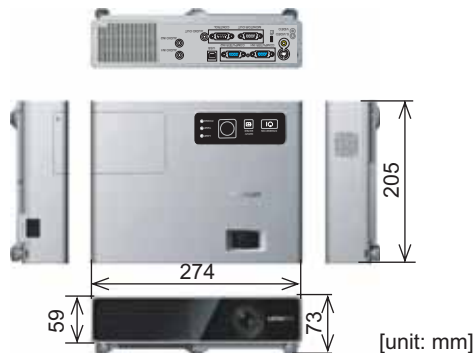

## Free Manuals Download Website

<http://myh66.com>

<http://usermanuals.us>

<http://www.somanuals.com>

<http://www.4manuals.cc>

<http://www.manual-lib.com>

<http://www.404manual.com>

<http://www.luxmanual.com>

<http://aubethermostatmanual.com>

Golf course search by state

<http://golfingnear.com>

Email search by domain

<http://emailbydomain.com>

Auto manuals search

<http://auto.somanuals.com>

TV manuals search

<http://tv.somanuals.com>