



Power Macintosh 7200 Series/WS 7250

Power Macintosh 7200/75, 7200/90, 7200/120 and
WS 7250/120





Basics

Power Macintosh 7200 Series/ WS 7250





Overview

The chassis design of the Power Macintosh 7200 Series and WS 7250 computers allows you to access the logic board and its components without having to remove the power supply or any drives. This flexible design makes these computers easier to service and upgrade.

Features of the Power Macintosh 7200 Series include

- A 75, 90, or 120 MHz PowerPC™ 601 microprocessor with built-in FPU and optional Level 2 cache
- Three PCI expansion slots
- 5 MB per second internal and external SCSI channels
- DRAM expansion up to 256 MB using 168-pin, 70 ns, 64-bit DIMMs
- 1 MB of soldered VRAM, expandable to 2 or 4 MB
- Built-in AAUI and 10BASE-T Ethernet
- Two GeoPort serial ports





- AppleCD™ 600i or 1200i CD-ROM drive
- CD-quality stereo sound in/out
- Optional PC Compatibility Card (Power Macintosh 7200/120)
- Mac™ OS system software 7.5.2 (7200/75 and 7200/90), system software 7.5.3 (7200/120), and system software 7.5.3 Revision 2 (7200/120 8x-CD)

Note: VRAM expansion works as follows: 1 MB of VRAM is soldered to the board. To go to 2 MB, install one 1 MB VRAM DIMM in slot 1. To go to 4 MB, install three 1 MB VRAM DIMMs in slots 1, 2, and 3.

Features of the Workgroup Server 7250/120 include

- A 120 MHz PowerPC™ 601 microprocessor with built-in FPU and 32K on-chip cache
- 256K level 2 cache
- 16 MB of DRAM, expandable to 256 MB





- Three PCI expansion slots
- SCSI DMA bus that supports up to four external and three internal SCSI devices
- Built-in AAUI and 10BASE-T Ethernet support
- Support for AppleTalk and TCP/IP networking protocols
- Two GeoPort serial ports
- 1.2 GB or 2 GB hard drive
- AppleCD™ 600i or 1200i CD-ROM drive
- 16-bit stereo sound input/output
- 1 MB of soldered VRAM
- Mac™ OS system software 7.5.3 Revision 2

The Power Macintosh 7200 and WS 7250 computer is pictured on the following page.





Power Macintosh 7200 and WS 7250 Computer





Configurations

The Power Macintosh 7200 Series computers come standard with

- 75, 90, or 120 MHz PowerPC 601 microprocessor
- 8 or 16 MB DRAM
- 500 MB or 1.2 GB hard drive
- AppleCD 600i CD-ROM (7200/75, 7200/90, and 7200/120) or 1200i CD-ROM (7200/120 8x-CD)
- 1 MB of VRAM soldered to the logic board

The WS 7250/120 computer comes standard with

- 120 MHz PowerPC 601 microprocessor
- 16 MB DRAM
- 1.2 GB or 2 GB hard drive
- AppleCD 600i or 1200i CD-ROM drive
- 1 MB of VRAM soldered to the logic board





PowerPC 601 Microprocessor

The Power Macintosh 7200 Series and WS 7250 computers feature the PowerPC 601 RISC microprocessor. Features of this microprocessor include

- Full RISC processor architecture
- 32-bit addressing
- 64-bit data bus
- Built-in FPU
- 32K cache for data and instructions
- Internal Memory Management Unit (MMU)
- Advanced branching techniques for improved throughput





Peripheral Component Interconnect (PCI)

The Power Macintosh 7200 Series and WS 7250 computers offer a Peripheral Component Interconnect (PCI) expansion bus. Because the PCI bus is an industry standard, most existing PCI 2.0-compliant cards (with the addition of a Mac OS-specific software driver) will work in these computers.

PCI offers significantly higher performance than the NuBus architecture used in previous Macintosh models. Running at 33 MHz, the PCI bus is up to three times faster than NuBus, offering overall enhanced system performance, particularly in the areas of video and networking.





Dual In-Line Memory Modules (DIMMs)

The Power Macintosh 7200 Series and WS 7250 computers use DRAM Dual In-Line Memory Modules (DIMMs) instead of DRAM SIMMs. Whereas SIMMs have 72 pins, DIMMs have 168 pins. The extra pins provide a 64-bit data path, compared to a 32-bit data path for SIMMs. In addition, DIMMs do not have to be installed in pairs like the SIMMs on earlier Macintosh models.

Important: The VRAM and DRAM Single In-Line Memory Modules (SIMMs) used in previous Macintosh models are **not** compatible with the Power Macintosh 7200 Series and WS 7250 computers.





Memory Configurations

The Power Macintosh 7200 and WS 7250 logic boards have four DRAM DIMM slots, each with a 64-bit data bus. You can increase the computer's DRAM to a total of 256 MB using 5-volt, 64-bit-wide, 168-pin fast-paged mode, 70 ns DIMMs.

Note: These computers do not have any main memory soldered to the logic board. At least one DRAM DIMM must be present for the computer to operate.

DRAM DIMMs can be installed individually or in pairs. These computers support linear memory only; therefore, no memory gains are seen when two DIMMs of the same size are installed (that is, memory interleaving is not supported on the Power Macintosh 7200 Series/WS 7250 computers).





Note: DIMMs purchased from different manufacturers can be paired; However, Apple recommends that you use DIMMs of the same size and speed.

The drawing on the next page illustrates where the DRAM slots are located on the Power Macintosh 7200 Series/WS 7250 logic boards and how they are numbered. DRAM can be installed in any order.



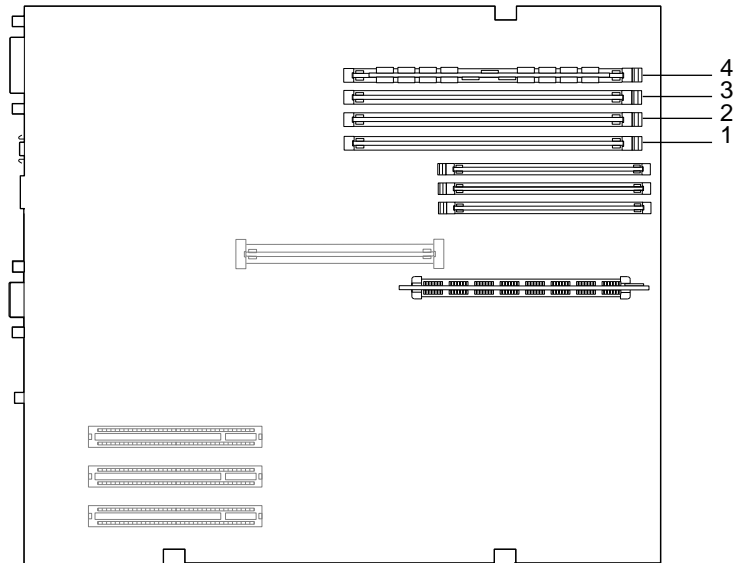

Figure: DRAM DIMM Slots





Ethernet Support

There are two Ethernet ports on the Power Macintosh 7200 Series and WS 7250 logic boards: an AAUI port and a 10BASE-T port. You can use only one Ethernet port at one time, however. If you have cables plugged into both Ethernet ports, the computer uses the 10BASE-T port by default.

GeoPort

Geoport is a hardware and software communications architecture that has been optimized for computer-telephony integration. It has three main attributes:

- It lets any computer connect to any telephone (analog or digital, public or private) anywhere in the world.





- Once connected, it supports an arbitrary number of independent data streams up to a total bandwidth of 2 MB/second.
- Unlike traditional asynchronous data communications (such as AppleTalk), GeoPort also supports isochronous data streams (such as real-time voice and video) and provides the real-time Application Program Interfaces (APIs) necessary to hide the implementation details from both the recipient and the sender.

By attaching an Apple GeoPort Telecom Adapter to the Power Macintosh 7200 or WS 7250, you can enjoy all the features of a 14.4 modem, including data, fax, send and receive, and voice capabilities. The GeoPort Telecom Adapter serves as a line interface to standard (analog) telephone lines. The adapter is capable of sending or receiving data at up to 14.4 kbps and faxes at up to 9600 bps using the GeoPort Telecom Adapter software.





PC Compatibility Cards

The Power Macintosh 7200/120 features an optional PC Compatibility card, which brings full DOS functionality to the Macintosh computer. Two versions of the PC Compatibility card are available: a 7" card and a 12" card. The cards plug into any available PCI slot on the logic board.

The two PC Compatibility cards are also available in individual upgrade kits. Refer to the Upgrades chapter in this manual for installation instructions.





The Cuda Chip

The Cuda is a microcontroller chip. Its function is to

- Turn system power on and off
- Manage system resets from various commands
- Maintain parameter RAM (PRAM)
- Manage the Apple Desktop Bus (ADB)
- Manage the real-time clock

Many system problems can be resolved by resetting the Cuda chip (see Symptom Charts for examples). Press the Cuda reset button on the logic board to reset the Cuda chip. (See "Logic Board Diagram" later in this chapter to locate the Cuda reset button.) If you continue to experience system problems, refer to "Resetting the Logic Board" later in this Basics chapter.





Resetting the Logic Board

Resetting the logic board can resolve many system problems (refer to "Symptom Charts" for examples). Whenever you have a unit that fails to power up, you should follow this procedure before replacing any modules.

- 1 Unplug the computer.
- 2 Remove the battery from the logic board. (See Take Apart for instructions on how to remove the battery.)
- 3 Disconnect the power supply cable from the logic board and then press the Power On button. (See "Logic Board Diagram" later in this chapter to locate the Power On button.)
- 4 Wait at least 10 minutes before replacing the battery. Make sure the battery is installed in the correct +/- direction.





5 Reassemble the computer and test the unit.

Note: This procedure resets the computer's PRAM. Be sure to check the computer's time/date and other system parameter settings afterwards.

Note: If this procedure resolves the problem, claim an adjustment on an SRO. If not, replace the defective component and DO NOT claim the adjustment procedure.





Rear View Diagram

The Power Macintosh 7200 Series and WS 7250 computers offer the following external ports: SCSI, AAUI Ethernet, 10BASE-T Ethernet, serial printer (GeoPort compatible), serial modem (GeoPort compatible), DB-15 video, ADB, sound input, and sound output.

The drawing on the next page illustrates the external ports on the Power Macintosh 7200 Series and WS 7250 computers.



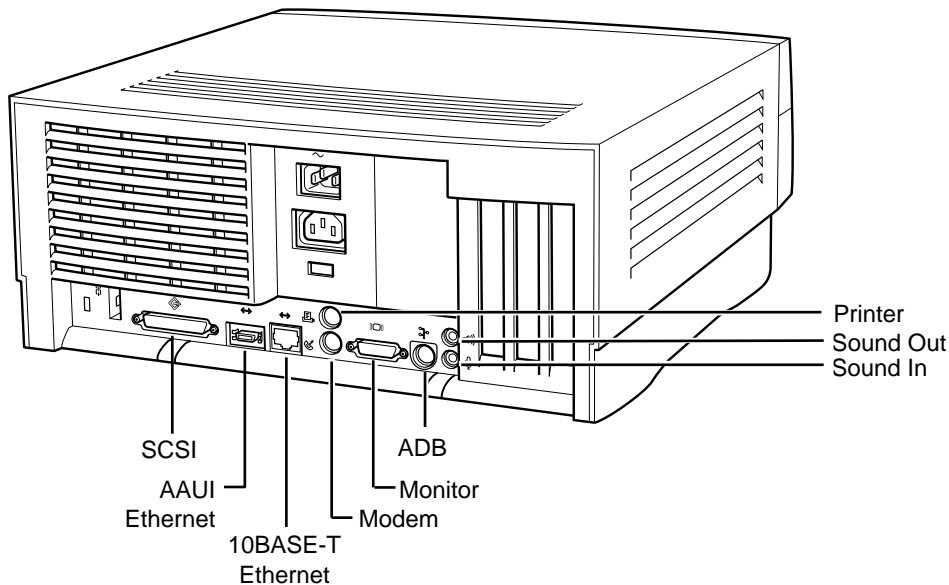

Figure: Power Macintosh 7200 and WS 7250 Rear Panel





Power Macintosh 7200 Logic Board Diagram

There are five versions of the Power Macintosh 7200 logic board: one 75 MHz version, two 90 MHz versions, and two 120 MHz versions. The two 90 MHz versions of the logic board are functionally equivalent, as are the two 120 MHz versions; However, one of the 90 MHz versions and one of the 120 MHz versions has an auxiliary fan that connects at J70.

Important: Do not unplug the Peltier device (one red wire and one black wire) that runs from the processor to the logic board or you will damage the board.

The following drawing shows the Power Macintosh 7200 logic board. Refer to the parts chapter for information on how you can distinguish between the different logic boards.



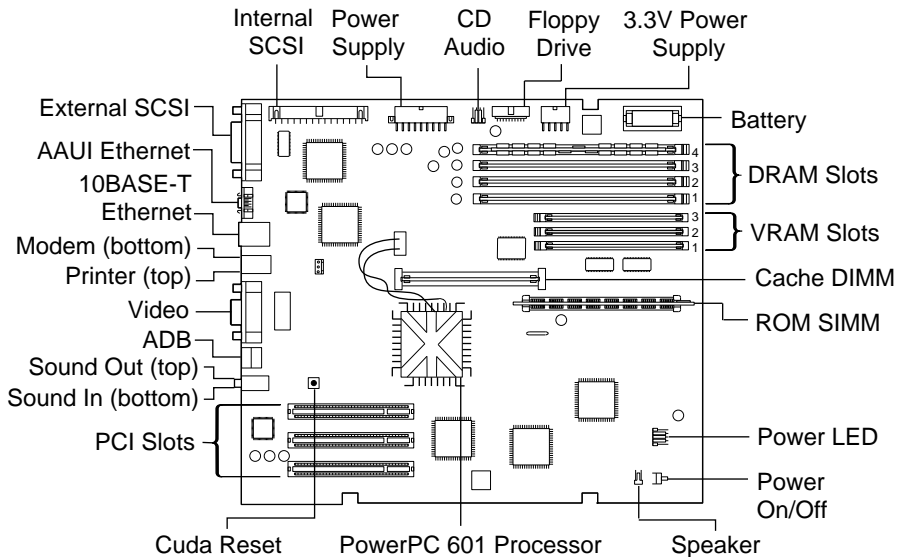

Figure: Power Macintosh 7200 Logic Board





Workgroup Server 7250 Logic Board Diagram

There is only one version of the WS 7250 logic board, which features a 120 MHz microprocessor. This board does not require an auxiliary processor fan.

The following drawing shows the WS 7250 logic board. **Note:** Some versions of the logic board have a ROM SIMM while others have the ROM soldered on the logic board.



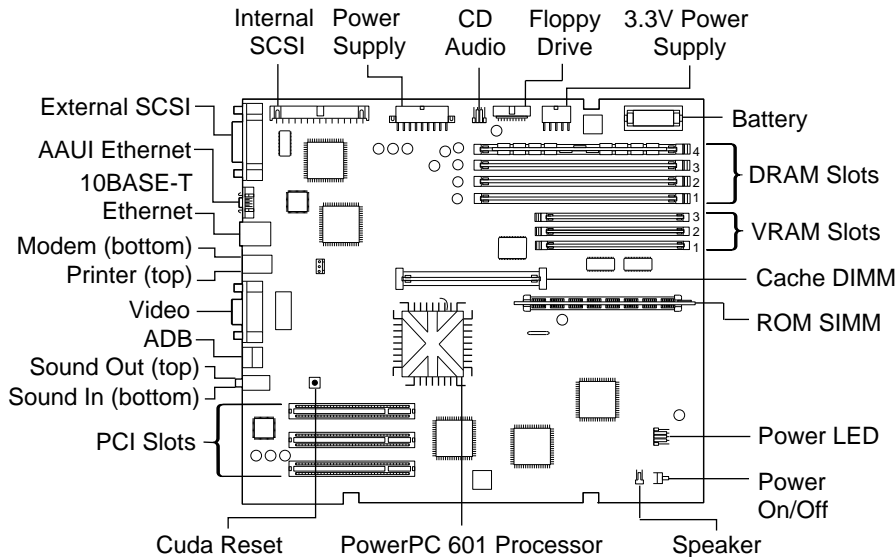

Figure: Workgroup Server 7250 Logic Board





Repair Strategy

Service the Power Macintosh 7200 Series and WS 7250 computers through module exchange and parts replacement. Customers can request on-site service from an Apple Authorized Service Provider Plus (AASP+) or Apple Assurance. They can also choose carry-in service from an AASP.

Ordering

Apple Service Providers planning to support the Power Macintosh 7200 Series and WS 7250 computers may purchase Service modules and parts to develop servicing capability. To order parts, use the AppleOrder system and refer to the Power Macintosh 7200 or Workgroup Server 7250 "Service Price Pages."





Large businesses, universities, and K-12 accounts must provide a purchase order on all transactions, including orders placed through the AppleOrder system. Service providers not enrolled in AppleOrder may fax their orders to Service Provider Support (512-908-8125) or mail them to

Apple Computer, Inc.
Service Provider Support
MS 212-SPS
Austin, TX 78714-9125

If you have further questions, please call Service Provider Support at 800-919-2775 and select option #1.





Warranty and AppleCare

The Power Macintosh 7200 Series and WS 7250 computers are covered under the Apple One-Year Limited Warranty. The AppleCare Service Plan is also available for these products. Service Providers are reimbursed for warranty and AppleCare repairs made to these computers. For pricing information, refer to "Service Price Pages."





Specifications

Power Macintosh 7200 Series/
WS 7250





Processor

CPU

PM 7200/75 and 7200/90

PowerPC 601 RISC microprocessor running at 75 or 90 MHz
Built-in FPU and 32K cache
Requires system software version 7.5.2 or later with appropriate
System Enabler

PM 7200/120 and WS 7250/120

PowerPC 601 RISC microprocessor running at 120 MHz
Built-in FPU and 32K cache
Requires system software version 7.5.3 or later with appropriate
System Enabler

Note: the 8x CD configurations of the Power Macintosh 7200/
120 and 7250/120 require system software 7.5.3 Revision 2.





Memory

DRAM	8 MB or 16 MB standard; expandable to 256 MB Uses 168-pin, 64-bit, 70 ns or faster DRAM DIMMs
ROM	4 MB ROM (may be installed in ROM SIMM slot, or soldered on the logic board)
Cache	Supports 256K Level 2 cache DIMM
Clock/Calendar	CMOS custom circuitry with long-life battery





I/O Interfaces

SCSI	Dual-channel asynchronous SCSI interface; external channel supports up to seven SCSI devices
Serial	Two RS-232/RS-422 serial ports compatible with LocalTalk and GeoPort cables; mini DIN-8 connectors
ADB	One Apple Desktop Bus port for a keyboard, mouse, etc.
Ethernet	One AAUI and one 10BASE-T Ethernet port (if cables are plugged into both ports, system defaults to 10BASE-T)





Expansion

Three PCI expansion slots, compatible with all PCI 2.0 specification-compliant cards with the addition of a Mac OS-specific software driver (not NuBus compatible)

Sound

16-bit stereo sound input and output ports

Video

Built-in DB-15 video connector on logic board





I/O Devices

Keyboard

Standard, extended, or adjustable keyboard; keyboard draws 25-80 mA, depending on model type

Mouse

ADB Mouse II; mouse draws up to 10 mA

Microphone

PM 7200 Series

Apple PlainTalk microphone standard





Video Support

Table 1: Video Table for Power Macintosh 7200 Series/WS 7250

MONITOR DISPLAY SIZE	PIXEL DEPTHS		
	1 MB VRAM*	2 MB VRAM*	4 MB VRAM*
512 by 384	8,16,32	8,16,32	8,16,32
640 by 480	8,16	8,16,32	8,16,32
768 by 576	8,16	8,16,32	8,16,32
800 by 600	8,16	8,16,32	8,16,32
832 by 624	8,16	8,16,32	8,16,32
1024 by 768	8	8,16	8,16,32
1280 by 960	—	8	8,16
1280 by 1024	—	8	8,16

*VRAM expansion works as follows: 1 MB of VRAM is soldered to the board. To go to 2 MB, install one 1 MB VRAM DIMM in slot 1. To go to 4 MB, install three 1 MB VRAM DIMMs in slots 1, 2, & 3.





Disk Storage

Hard Drive

**PM 7200/75 and
7200/90** 500 MB internal SCSI hard drive

PM 7200/120 1.2 GB internal SCSI hard drive

WS 7250/120 2 GB internal SCSI hard drive

Floppy Drive

One Apple SuperDrive 1.4 MB floppy drive

CD-ROM Drive

One internal AppleCD 600i 4x CD-ROM drive or
1200i 8x CD-ROM drive





PC Compatibility Card (Optional)

Processor

7" Card

5x86 processor operating at 100 MHz

12" Card

Pentium processor operating at 100 MHz

DRAM

7" Card

8 MB DIMM standard, expandable to 64 MB

12" Card

8 MB built-in, expandable to 72 MB

VRAM

7" Card

1 MB

12" Card

1 MB, expandable to 2 MB





Cache

7" Card	128K Level 2 cache
12" Card	256 K Level 2 Cache

Sound

Sound Blaster 16-compatible support

Software

MS-DOS version 6.22 included

Networking

Support for Novell NetWare SPX/IPX, TCP/IP, and NETBEUI protocols in MS-DOS and Windows environments using the built-in Ethernet connector and an ODI driver (network client software not included)





Electrical

Line Voltage

PM 7200	100-240 VAC, RMS single phase, automatically configured
WS 7250/120	100-270 VAC, RMS single phase, automatically configured

Frequency

50-60 Hz, single phase

Maximum Power

150 W maximum, not including monitor

Note: the power supply has two voltage settings: 115V and 230 V. The power supply must be set to 115V in the U.S.





Physical

Dimensions

Height	6.5 in. (15.6 cm)
Width	14.37 in. (36.5 cm)
Depth	16.93 in. (43.0 cm)
Weight	22 lb. (9.97 kg); weight varies depending on devices installed





Environmental

**Operating
Temperature**

50 to 104° F (10 to 40° C)

**Storage
Temperature**

—40 to 116° F (—40 to 47° C)

Relative Humidity

5% to 95% noncondensing

Maximum Altitude

10,000 ft. (3,048 m)





Troubleshooting

Power Macintosh 7200 Series/ WS 7250





General

The Symptom Charts included in this chapter will help you diagnose specific symptoms related to your product. Because cures are listed on the charts in the order of most likely solution, try the first cure first. Verify whether or not the product continues to exhibit the symptom. If the symptom persists, try the next cure. (Note: If you have replaced a module, reinstall the original module before you proceed to the next cure.)

If you are not sure what the problem is, or if the Symptom Charts do not resolve the problem, refer to the Flowchart for the product family.

For additional assistance, contact Apple Technical Support.





Cleaning Procedure for Card Connectors

It is possible for residue to build up on the gold edge connector pins on some PCI cards, which could cause a variety of symptoms.

If you are having problems with a PCI card, inspect the connector pins with a magnifying glass. If you find residue, use a pencil eraser to gently clean the pins.





Symptom Charts

Power Supply

System doesn't power up

- 1 Reseat ROM SIMM (if present).
- 2 Reset Cuda chip. (Refer to The Cuda Chip in Basics for instructions.)
- 3 Reset logic board. (Refer to Resetting the Logic Board in Basics for instructions.)
- 4 Replace power supply.
- 5 Replace logic board.





Error Chords

One-part error chord sounds during startup sequence

- 1 Disconnect SCSI data cable from hard drive and reboot system. If startup sequence is normal, initialize hard drive. Test unit again with SCSI data cable connected. If error chord still sounds, replace hard drive.
- 2 Disconnect floppy drive cable from floppy drive and reboot system. If startup sequence is normal, replace floppy drive.
- 3 Replace logic board. Retain customer's DIMMs.

Eight-part error chord (death chimes) sounds during startup sequence

- 1 Replace DRAM DIMMs one at a time to test DRAM. Replace any faulty DIMMs.
- 2 Replace logic board.





System

Does not power on, screen is black, fan is not running and LED is not lit

- 1 Check power cables.
- 2 Plug monitor directly into wall socket, and verify that monitor has power.
- 3 Reseat ROM SIMM (if present).
- 4 Reset Cuda chip. (Refer to The Cuda Chip in Basics for instructions.)
- 5 Reset logic board. (Refer to Resetting the Logic Board in Basics for instructions.)
- 6 Replace power cord.
- 7 Replace power supply.
- 8 Replace logic board. Retain customer's DIMMs.





Clicking, chirping,
or thumping

- 1 Remove all PCI cards and test the unit. If problem does not occur with cards removed, begin replacing them one at a time to determine which card is causing the problem. Replace problem card with known-good card.
- 2 Remove hard drive. If problem no longer occurs, replace hard drive with a known-good drive.
- 3 Replace power supply.
- 4 Replace logic board. Retain customer's DIMMs.
- 5 Replace floppy drive cable.
- 6 Replace floppy drive.





System shuts down
intermittently

- 1 Make sure air vents are clear. Thermal protection circuitry may shut down system. After 30 to 40 minutes, system should be OK.
- 2 Make sure power cord is firmly plugged in.
- 3 Verify fan is plugged in and working (if present). Replace if necessary. (Note: Some 90 MHz versions of the Power Macintosh 7200 logic board have a fan that plugs into the logic board near the processor.)
- 4 Replace power cord.
- 5 Check battery.
- 6 Reset Cuda chip. (Refer to The Cuda Chip in Basics for instructions.)
- 7 Reset logic board. (Refer to Resetting the Logic Board in Basics for instructions.)
- 8 Replace power supply.
- 9 Replace logic board. Retain customer's DIMMs.





System
intermittently
crashes or hangs

- 1 Verify system software is version 7.5.2 or later (Power Macintosh 7200/75 or 7200/90) or 7.5.3 or later (Power Macintosh 7200/120 or WS 7250/120).
- 2 Verify DIMMs are noncomposite.
- 3 Verify software is known-good. Do a clean install of the system software.
- 4 Verify software is Power Macintosh 7200/WS 7250 compatible (contact developer). Also, try booting with extensions off to determine if there are system init problems.
- 5 Clear parameter RAM. Hold down <Command> <Option> <P> <R> during startup but before "Welcome to Macintosh" appears.
- 6 Remove all DRAM DIMMs and try replacing them one at a time to test. Replace any bad DIMMs.
- 7 Replace logic board. Retain DIMMs.





During startup, following message is displayed, "This startup disk will not work on this Macintosh model...."

System can't be powered off unless external 1.2 GB hard drive is off **or** LED remains lit when system is powered off and attached 1.2 GB hard drive is left powered on

- 1 Verify that startup disk is good.
- 2 Verify system software is version 7.5.2 or later (Power Macintosh 7200/75 or 7200/90) or 7.5.3 or later (Power Macintosh 7200/120 or WS 7250/120).
- 3 Do a clean install of the system software.

This problem only affects PM 7200 and WS 7250 machines with serial numbers in the following ranges:

- CK634xxxxxx to CK637xxxxxx
- XB634xxxxxx to XB637xxxxxx
- SG634xxxxxx to SG637xxxxxx
- FC634xxxxxx to FC637xxxxxx

If system falls into one of these serial number ranges, execute the following instructions:

- 1) Unplug system and remove top cover.





- 2) Disconnect hard drive SCSI cable and power cable.
- 3) Remove hard drive from chassis.
- 4) Turn drive over and examine part number label on 50-pin SCSI connector (removing drive carrier if necessary). If label reads “1280S p/n TM12S012” **and** “REV 02-B”, replace drive.

Note: Only Revision “02” drives cause this problem; therefore, make sure bar code label includes the words “REV 02-B” before replacing hard drive.





Video

Screen is black, boot tone is present, drive operates, fan is running, and LED is lit

- 1 Adjust brightness on monitor.
- 2 Clear parameter RAM. Hold down <Command> <Option> <P> <R> during startup but before "Welcome to Macintosh" appears.
- 3 Reset Cuda chip. (Refer to The Cuda Chip in Basics for instructions.)
- 4 Reset logic board. (Refer to Resetting the Logic Board in Basics for instructions.)
- 5 Replace monitor cable.
- 6 Remove all DRAM DIMMs and try replacing them one at a time to test. Replace any bad DIMMs.
- 7 Test with known-good monitor. Replace monitor if necessary. Refer to appropriate monitor manual to troubleshoot defective monitor.
- 8 Replace logic board. Retain customer's DIMMs.





Screen is black, no boot tone and drive does not operate, but fan is running and LED is lit

- 1 Reset Cuda chip. (Refer to The Cuda Chip in Basics for instructions.)
- 2 Reset logic board. (Refer to Resetting the Logic Board in Basics for instructions.)
- 3 Remove all DRAM DIMMs and try replacing them one at a time to test. Replace any bad DIMMs.
- 4 Replace logic board. Retain customer's DIMMs.
- 5 Replace power supply.





Boot tone is present and screen lights up, but nothing is displayed on screen

- 1 Reset Cuda chip. (Refer to The Cuda Chip in Basics for instructions.)
- 2 Reset logic board. (Refer to Resetting the Logic Board in Basics for instructions.)
- 3 Replace monitor cable.
- 4 Test with known-good monitor. Replace monitor if necessary. Refer to appropriate monitor manual to troubleshoot defective monitor.
- 5 Replace logic board. Retain customer's DIMMs.





Floppy Drive

Internal floppy drive does not operate

- 1 Replace floppy disk with known-good disk.
- 2 Replace floppy drive cable.
- 3 Replace floppy drive.
- 4 Replace logic board. Retain customer's DIMMs.

During system startup, disk ejects; display shows icon with blinking "X"

- 1 Replace disk with known-good system disk.
- 2 Replace floppy drive cable.
- 3 Replace floppy drive.
- 4 Replace logic board. Retain customer's DIMMs.





- | | |
|-------------------------------------|--|
| Does not eject disk | <ol style="list-style-type: none"><li data-bbox="445 104 1410 182">1 Shut down computer. Hold mouse button down while you restart computer.<li data-bbox="445 197 948 228">2 Replace floppy drive cable.<li data-bbox="445 244 856 275">3 Replace floppy drive.<li data-bbox="445 291 1267 327">4 Replace logic board. Retain customer's DIMMs. |
| Attempts to eject disk, but doesn't | <ol style="list-style-type: none"><li data-bbox="445 389 1395 467">1 Reseat floppy drive bezel and drive so bezel slot aligns correctly with drive.<li data-bbox="445 482 856 518">2 Replace floppy drive. |





MS-DOS drive does not recognize a disk formatted on a 1.4 MB drive

To read and write files with either MS-DOS or 1.4 MB drive, format all disks with MS-DOS drive first.

Internal floppy drive runs continuously

- 1 Replace disk with known-good floppy disk.
- 2 Replace floppy drive cable.
- 3 Replace floppy drive.
- 4 Replace logic board. Retain customer's DIMMs.





Hard Drive

Single internal hard drive does not operate; drive doesn't spin

- 1 Replace hard drive. If problem resolved, reinstall SCSI device driver and system software.
- 2 Replace power supply.

No internal SCSI drives operate

- 1 Verify there are no duplicate SCSI device addresses.
- 2 Disconnect external SCSI devices and check for proper termination. Only last device in SCSI chain should be terminated.
- 3 Replace SCSI data cable.
- 4 Replace power supply.
- 5 Replace logic board. Retain customer's DIMMs.





Drive does not appear on the desktop

- 1 Verify there are no duplicate SCSI device addresses.
- 2 Update SCSI device driver using Drive Setup. Check drive's directory structure using Disk First Aid.
- 3 Replace SCSI hard drive cable.
- 4 If drive is not initialized, use Drive Setup to initialize.
- 5 Replace with known-good hard drive.
- 6 If hard drive still doesn't work, switch back to original hard drive and replace logic board.

Works with internal or external SCSI devices but not with both

- 1 Verify there are no duplicate SCSI device addresses.
- 2 Replace terminator on external SCSI device.
- 3 Verify that SCSI device at end of internal SCSI data cable is only device terminated.
- 4 Refer to appropriate manual to troubleshoot defective external device.





Peripherals

Cursor does not move

- 1 Check mouse connection.
- 2 Inspect inside of mouse for buildup of dirt or other contaminants. Clean mouse if necessary.
- 3 If mouse was connected to keyboard, connect mouse to computer ADB port instead. If mouse works, replace keyboard.
- 4 Replace ADB cable.
- 5 If mouse does not work in any ADB port on computer, replace mouse.
- 6 Replace logic board. Retain customer's DIMMs.

Cursor moves, but clicking mouse button has no effect

- 1 Boot from floppy or bootable CD.
- 2 Replace mouse.
- 3 Replace logic board. Retain customer's DIMMs.





Double-click doesn't open application, disk, or server

- 1 Remove duplicate system folders.
- 2 Clear parameter RAM. Hold down <Command> <Option> <P> <R> during startup but before "Welcome to Macintosh" appears.
- 3 If mouse was connected to keyboard, connect mouse to computer ADB port instead. If mouse works, replace keyboard.
- 4 If mouse does not work in any ADB port on computer, replace mouse.
- 5 Replace logic board. Retain customer's DIMMs.

No response to any key on keyboard

- 1 Check keyboard connection to ADB port.
- 2 Replace keyboard cable.
- 3 Replace keyboard.
- 4 Replace logic board. Retain customer's DIMMs.





Known-good serial
printer does not work

- 1 Verify you have correct version of system software.
- 2 Verify that Chooser is set correctly.
- 3 Reinstall correct printer drivers.
- 4 Do clean install of system software.
- 5 Replace printer interface cable.
- 6 Replace logic board. Retain customer's DIMMs.

Known-good network
printer does not print

- 1 Check network connections.
- 2 Verify you have correct version of system software.
- 3 Verify that Chooser is set correctly.
- 4 Does printer show up in Chooser? If so, do clean install of system software and/or network and printer software.
- 5 Replace logic board. Retain customer's DIMMs.





CD-ROM Drive

CD-ROM drive does not work

- 1 Try using known-good compact disc.
- 2 Replace CD-ROM drive mechanism.

Macintosh does not display CD-ROM icon once CD is inserted in drive

- 1 Verify that CD-ROM software is installed.
- 2 Replace CD-ROM drive mechanism.
- 3 Replace SCSI data cable.

Computer with 600i CD-ROM drive makes stuttering sounds when playing CD+ or CD-R formatted discs or CD-ROM disc won't mount

Replace CD-ROM drive.





Miscellaneous

No sound from speaker

- 1 Verify that volume setting in Control Panel is 1 or above.
- 2 Clear parameter RAM. Hold down <Command> <Option> <P> <R> during startup but before “Welcome to Macintosh” appears.
- 3 Verify speaker is plugged into logic board.
- 4 Replace speaker.
- 5 Replace logic board. Retain customer’s DIMMs.





Transferring/printing large files across certain repeaters causes Power Macintosh 7200/90 to hang or exhibit poor performance or Power Macintosh 7200/90 locks up or times out when running under TCP

- 1 Verify computer is Power Macintosh 7200/90 and attached to Ethernet network.
- 2 Test to see if problem occurs on other systems (preferably Power Macintosh 7200/75, 7500, 8500, or 9500 computers that utilize the new Open Transport networking protocol).
 - If yes, difficulty may be related to software or network to which computer is attached. Perform basic software and network troubleshooting to pinpoint problem.
 - If no, difficulty may be related to Ethernet clock jitter. Refer to logic board identification instructions on next page to determine whether or not logic board has been revised. If logic board is a revised module, problem may have to do with the network. If logic board has not been revised, replace it in at least one of the systems to verify whether a revised board solves the problem.





Identifying Logic Boards

As a general rule, if the Power Macintosh 7200/90 computer has a serial number of xx545xxxxx or higher, then the computer should have the revised logic board already installed. If the computer has a serial number of xx544xxxxx, xx543xxxxx or below, verify that the board is revised as follows:

Look at location G1; G1 is located next to the internal 50-pin SCSI connector and the CURIO ASIC.

- If a 20 MHz oscillator is present at location G1, the logic board has been revised.
- If a 20 MHz oscillator is not present (four blank solder pads) then the board has not been revised and should be replaced under warranty.





Take Apart

Power Macintosh 7200 Series/ WS 7250





Top Housing



Top Housing

No preliminary steps are required before you begin this procedure.

Note: The top housing covers the top, front, and left and right sides of the computer.





- 1 Press the two tabs at the front corners of the top housing to release the top housing from the bottom chassis.





- 2 Pull the top housing forward about 1 to 2 inches and lift straight up to remove the top housing from the computer.





Bezels

Before you begin, remove the top housing.

Note: As you face the computer, the bezels are in the middle of the top housing's front panel.



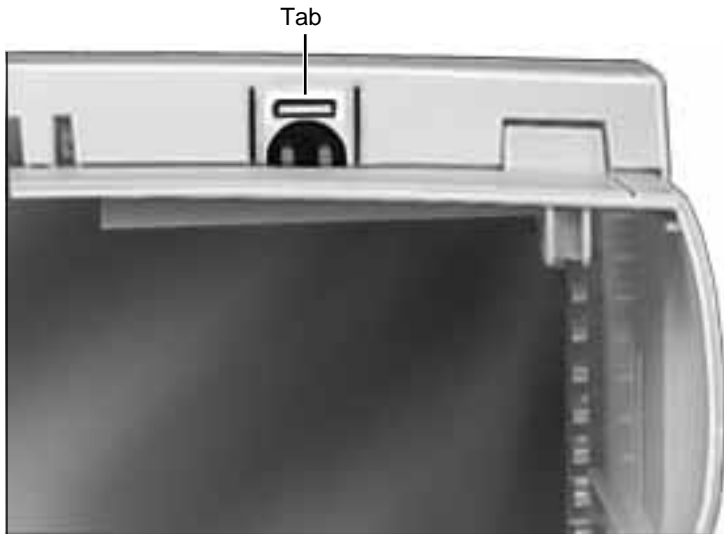

- 1 From the inside of the top housing, push out on the moon-shaped opening at the bottom of the bezel to release the tab. Lift up the bezel to remove it from the top housing.





CD-ROM Drive

Before you begin, remove the top housing.

Note: As you face the computer, the CD-ROM drive is in the bottom right drive bay.

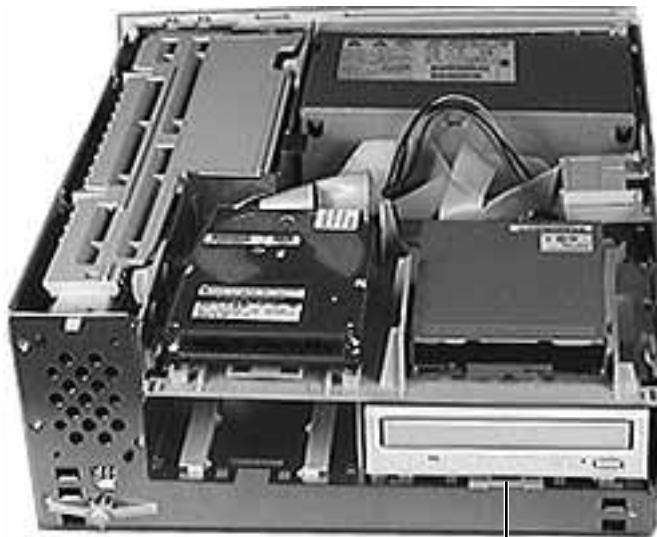

CD-ROM Drive





- 1 Lift up the top tabs and pull out the CD-ROM EMI shield to remove it from the front of the CD-ROM drive.





Power Cable

SCSI Cable

CD Audio Cable

- 2 Disconnect the SCSI cable, power cable, and CD audio cable from the back of the CD-ROM drive.





- 3 Pull up the retaining clip (which is located at the back of the CD-ROM drive) and slide the CD-ROM forward to remove it from the internal chassis.

Note: Be sure to remove the CD-ROM drive from its carrier before returning the drive to Apple.





Floppy Drive

Before you begin, remove the top housing.

Note: As you face the computer, the floppy drive is in the top right drive bay.

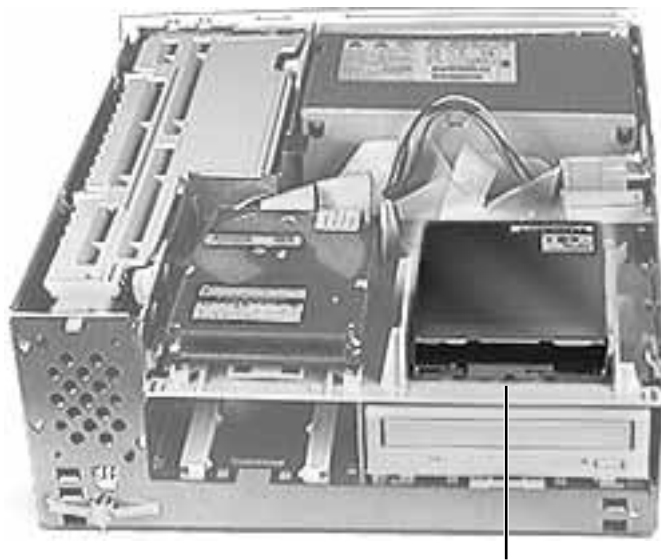

Floppy Drive



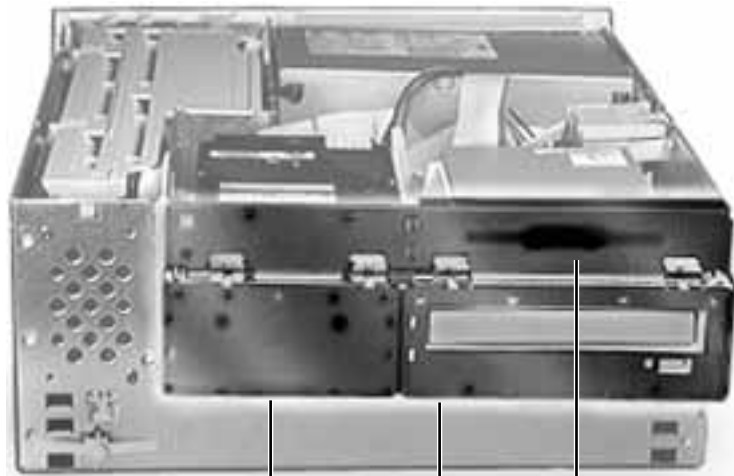

Blank Shield

CD-ROM Shield

Floppy Drive Shield

- 1 Remove the CD-ROM shield, the blank shield, and the floppy drive shield from the front of the unit.



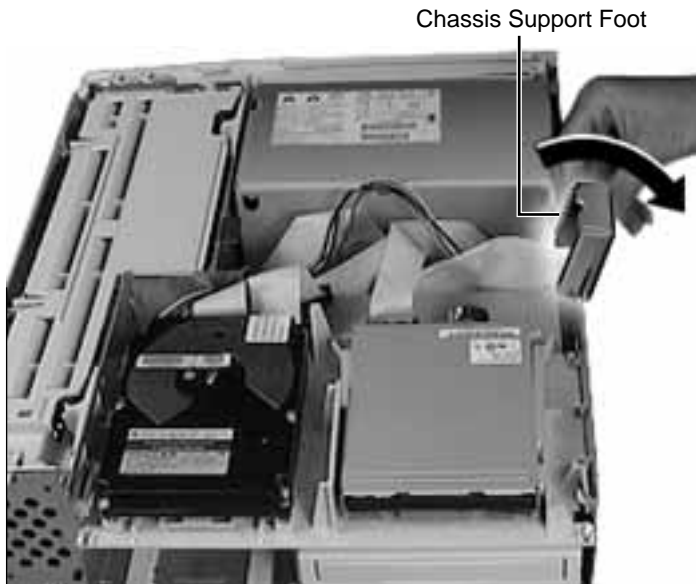

Chassis Support Foot

- 2 Flip open the chassis support foot.





Floppy Drive Cable

Floppy Drive

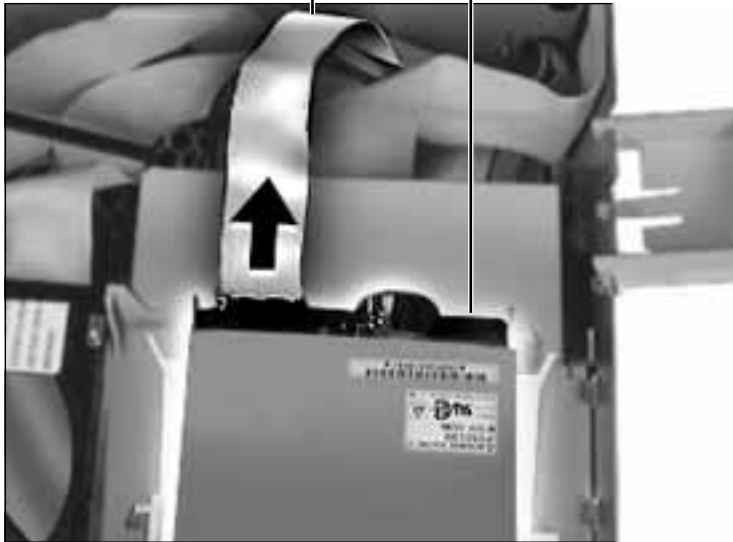

- 3 Disconnect the floppy drive cable from the back of the floppy drive.



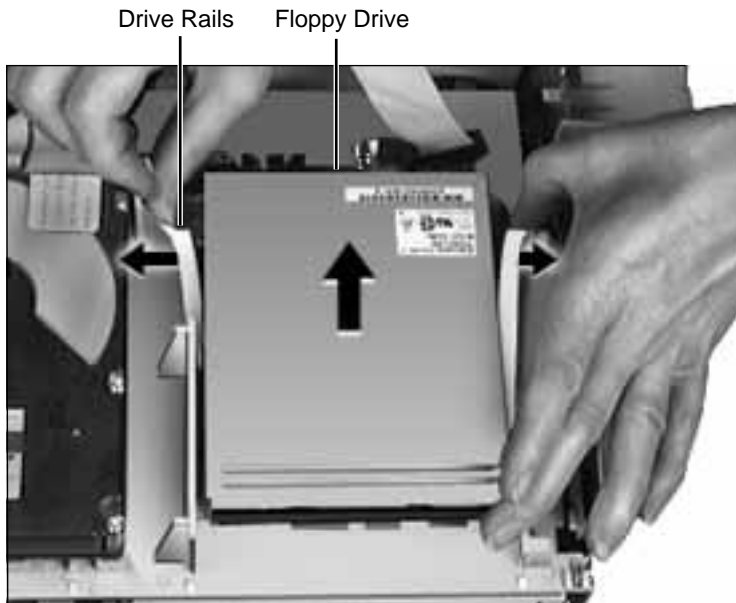

- 4 Pull out on the plastic drive rails that hold the floppy drive to the drive chassis and push the drive back to release it.

Replacement Note: If you are replacing the floppy drive, remove the EMI gasket from the defective drive and attach the gasket in the center of the replacement drive's top surface, with the "V" of the gasket pointing at the front edge of the drive. If the old gasket won't stick, order a new gasket (p/n 922-1895).





Hard Drive

Before you begin, remove the top housing.

Note: As you face the computer, the hard drive is in the top left drive bay.



Hard Drive



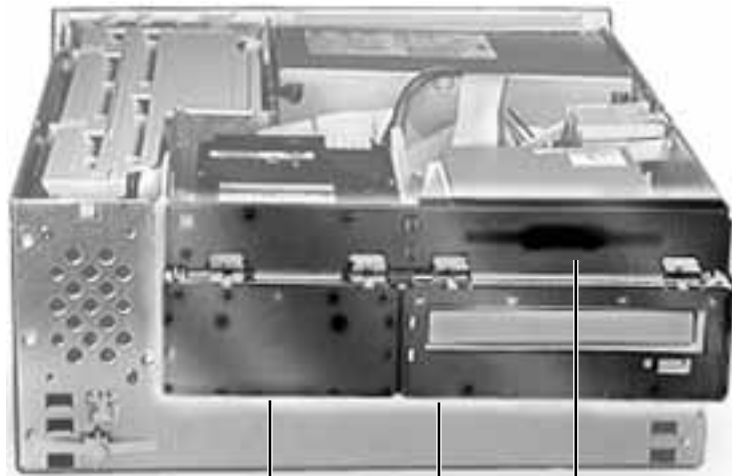

Blank Shield

CD-ROM Shield

Floppy Drive Shield

- 1 Remove the CD-ROM shield, the blank shield, and the floppy drive shield from the front of the unit.



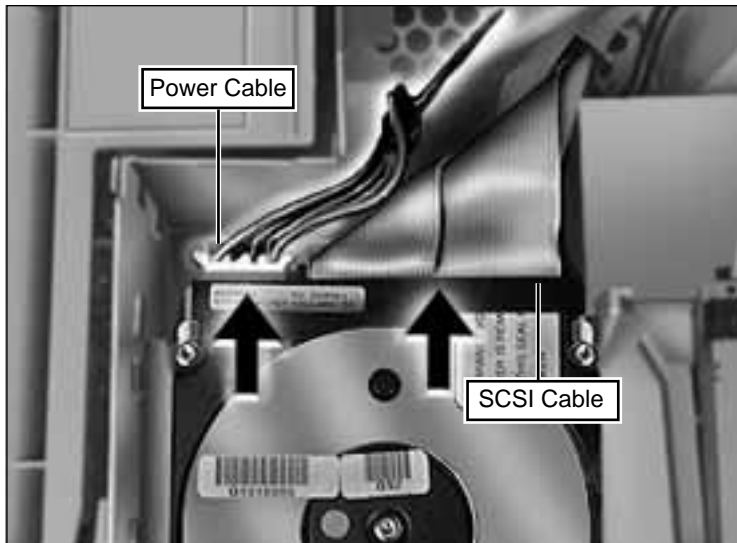

- 2 Disconnect the SCSI cable and hard drive power cable from the back of the hard drive.



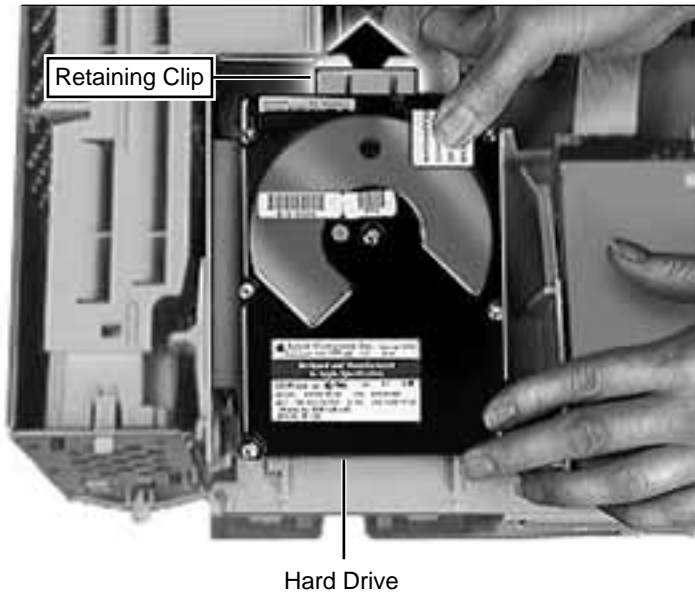

- 3 Pull up the retaining clip at the back of the hard drive and push back the hard drive to remove it from the drive chassis.

Note: For information on removing the hard drive from its carrier and returning drives, cables, and carriers to Apple, refer to Additional Procedures in the Hard Drives manual.





Chassis Latch

Before you begin, remove the top housing.

Note: The chassis latches mount in the internal chassis and secure the internal chassis to the external chassis frame.

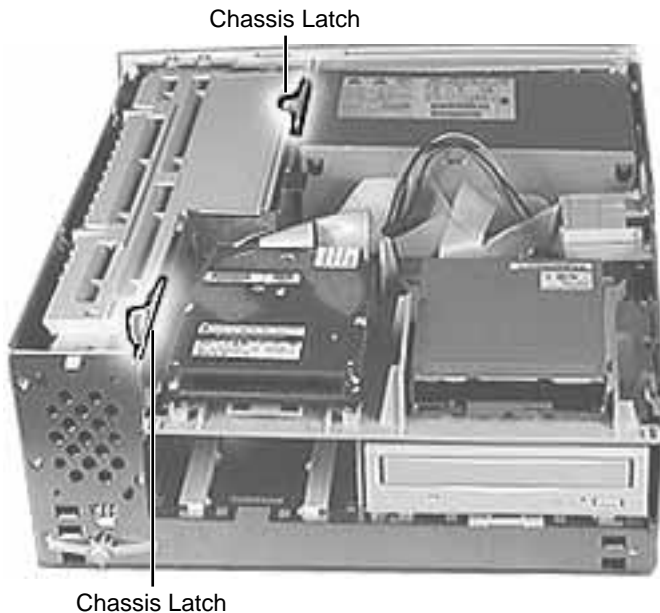



- 1 Use a screwdriver to push out the tab indicated in the illustration. Slide the latch forward and lift it from the chassis.

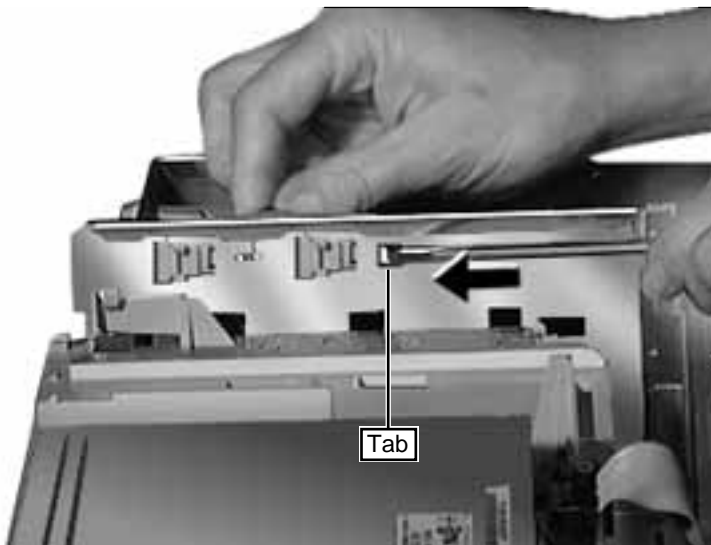

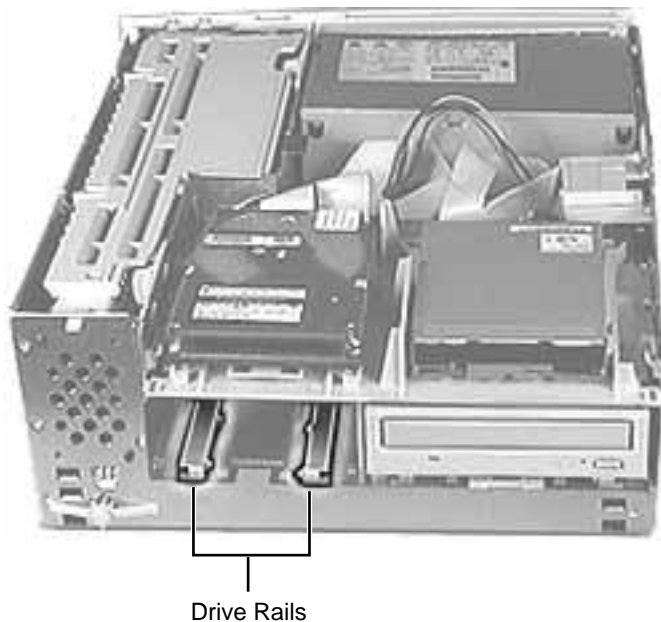

Drive Rails

Before you begin, remove:

- Top Housing
- All Drives

Note: The drive rails attach to the internal chassis underneath the CD-ROM drive and the extra hard drive bay.



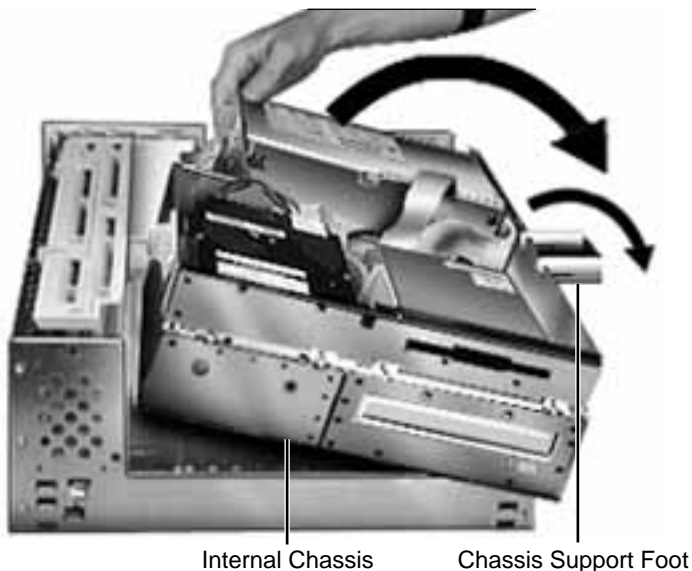

- 1 First, release the chassis latches. Next, flip open the chassis support foot and then swing open the internal chassis that contains the power supply.

IMPORTANT: On some 90 and 120 MHz versions there is a fan that plugs into the logic board at connector J70. You must unplug the fan as you are swinging open the chassis. Be sure to plug the fan back in when you put the unit back together.



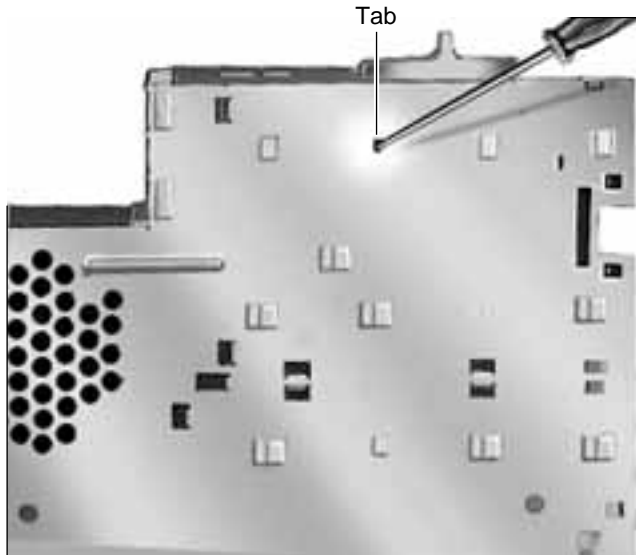

- 2 Use a screwdriver to push out the tab indicated in the illustration.
- 3 Slide the drive rail either forward or backward (depending on which way the tabs are facing) and lift it from the chassis.

IMPORTANT: On some 90 and 120 MHz versions there is a fan that plugs into the logic board at connector J70. Be sure to plug the fan back in when you put the unit back together.



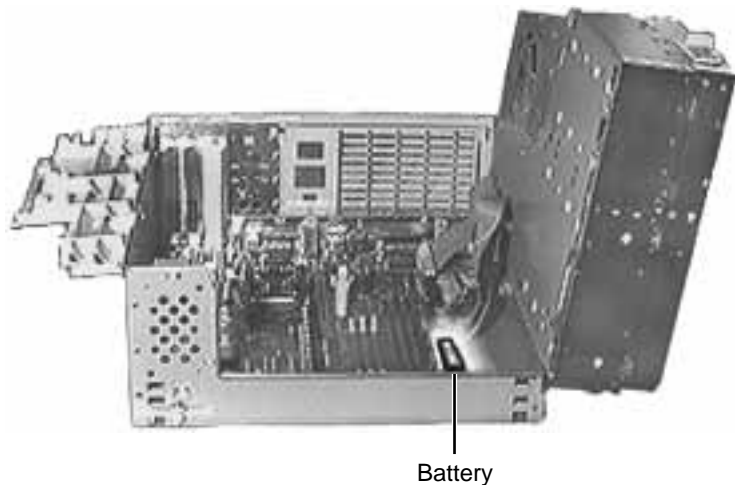

Battery

Before you begin, remove the top housing.

Note: As you face the computer, the battery is near the front left corner of the logic board.



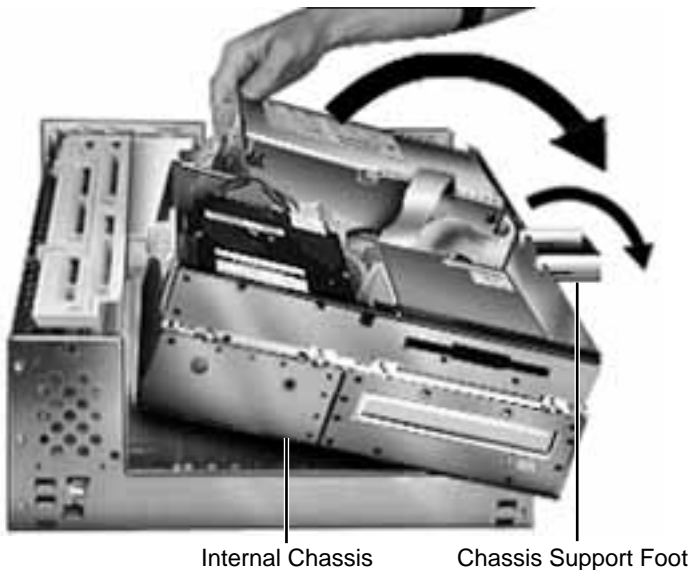

- 1 First, release the chassis latches. Next, flip open the chassis support foot and then swing open the internal chassis that contains the power supply.

IMPORTANT: On some 90 and 120 MHz versions there is a fan that plugs into the logic board at connector J70. You must unplug the fan as you are swinging open the chassis. Be sure to plug the fan back in when you put the unit back together.



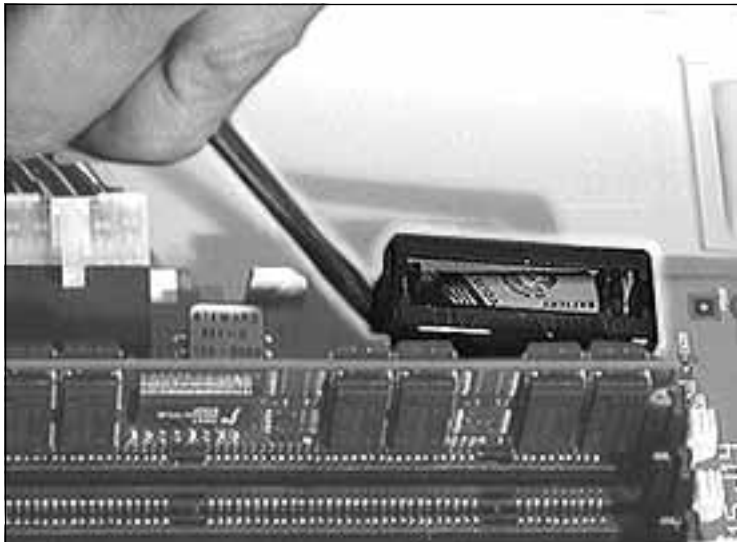

- 2 Use a screwdriver to gently pry up one side of the battery cover.



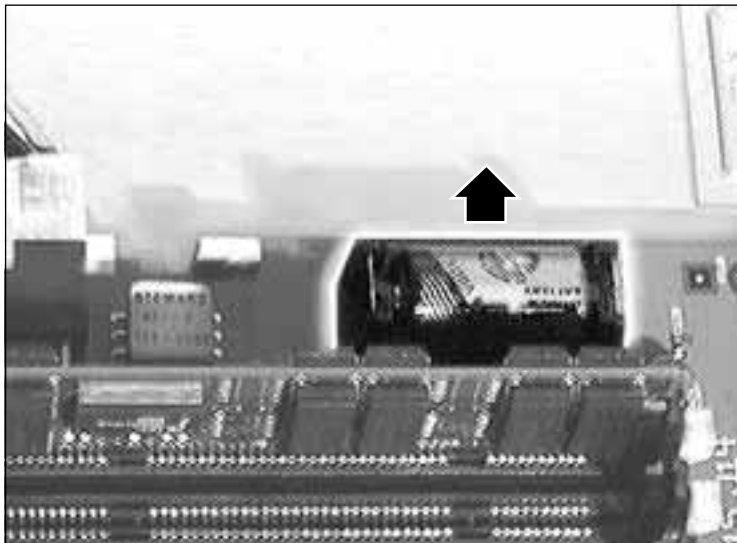

- 3 Lift up the battery to remove it from the logic board.

IMPORTANT: On some 90 and 120 MHz versions there is a fan that plugs into the logic board at connector J70. Be sure to plug the fan back in when you put the unit back together.



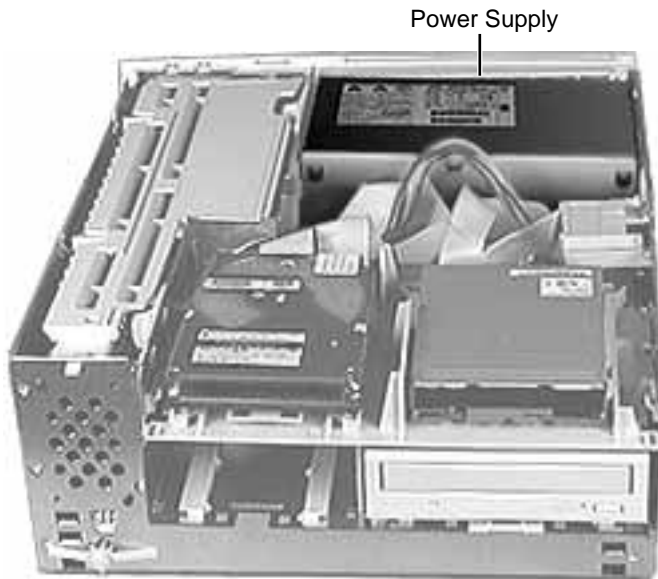

Power Supply

Before you begin, remove the top housing.

Note: As you face the computer, the power supply is in the back right corner.

IMPORTANT: When replacing the power supply, be sure the voltage switch on the back of the power supply is set correctly (115V in the U.S.).



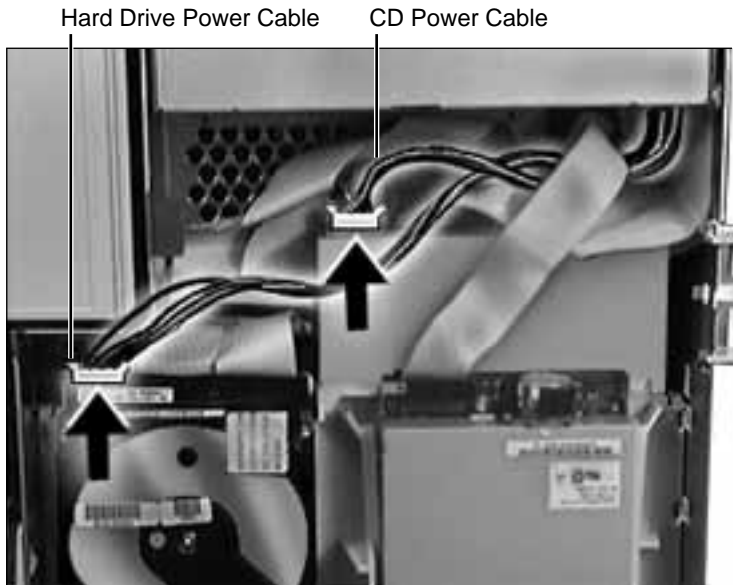

- 1 Disconnect the power supply cables from the back of the CD-ROM drive and hard drive(s).



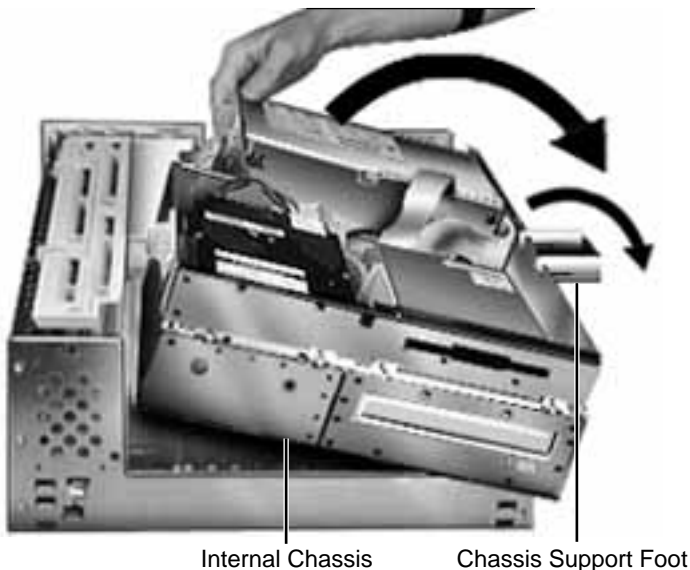

- 2 First, release the chassis latches. Next, flip open the chassis support foot and then swing open the internal chassis that contains the power supply.

IMPORTANT: On some 90 and 120 MHz versions there is a fan that plugs into the logic board at connector J70. You must unplug the fan as you are swinging open the chassis. Be sure to plug the fan back in when you put the unit back together.



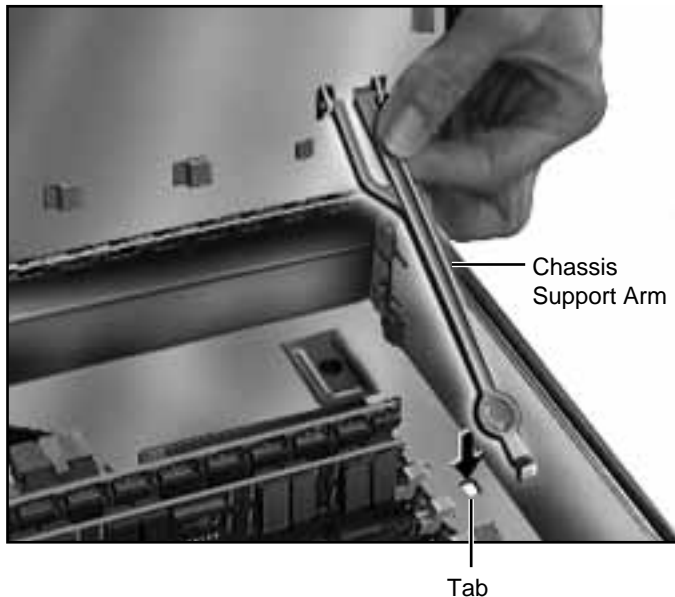

- 3 To secure the internal chassis in the up position, flip down the chassis support arm. Make sure the tab on the bottom of the support arm is securely fastened in the hole provided in the bottom chassis.

Warning: To be safe, never work on the computer with the internal chassis in the up position unless the chassis support arm is down and securely fastened.





Power Supply Cables

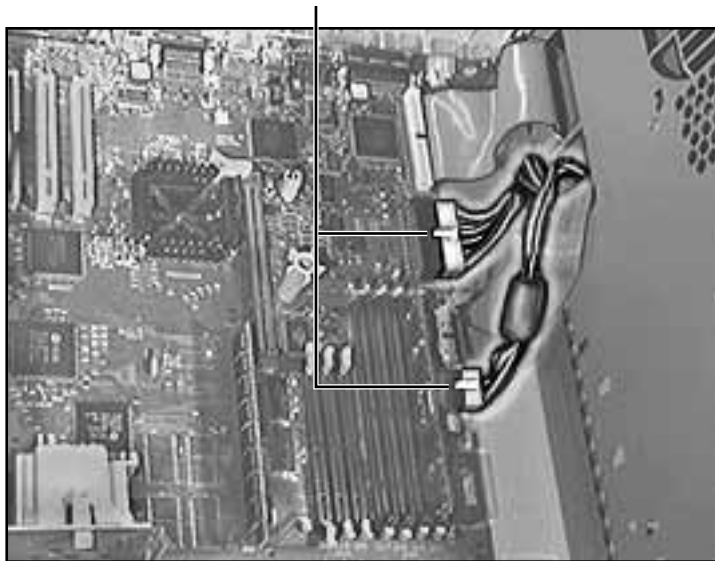

- 4 Disconnect the power supply cables from the logic board.

Note: The 22-pin cable supplies 5 V and +/- 12 V power for the logic board.



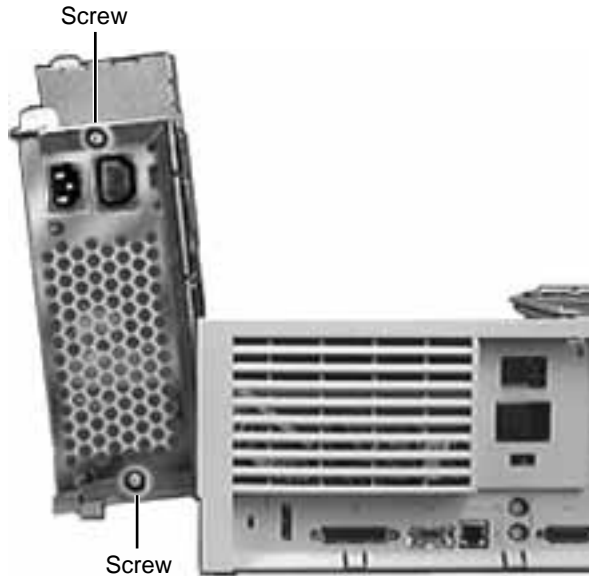

- 5 From the back of the computer, remove the two screws that secure the power supply to the chassis.



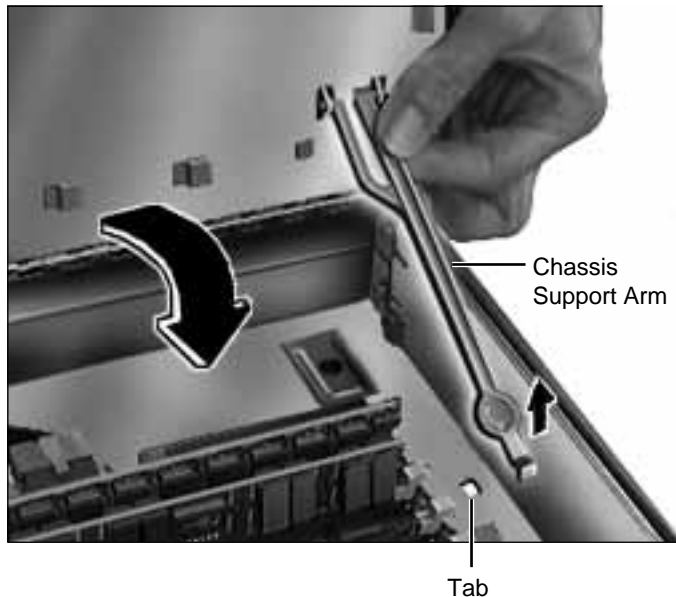

- 6 Release the chassis support arm and swing down the internal chassis.

IMPORTANT: On some 90 and 120 MHz versions there is a fan that plugs into the logic board at connector J70. Be sure to plug the fan back in when you put the unit back together.





- 7 Slide the power supply forward and pull it out of the computer. You will need to feed the power supply cables that connect to the logic board up through the hole in the chassis.

IMPORTANT: Make sure the power supply switch on the back of the power supply is set to the correct voltage (115V in the U.S.) The switch is accessible through the computer's rear panel when the power supply is installed.





Replacement Note: There are two metal tabs on the back of the metal chassis that lock into the power supply. When replacing the power supply, slide it back until it locks into place.



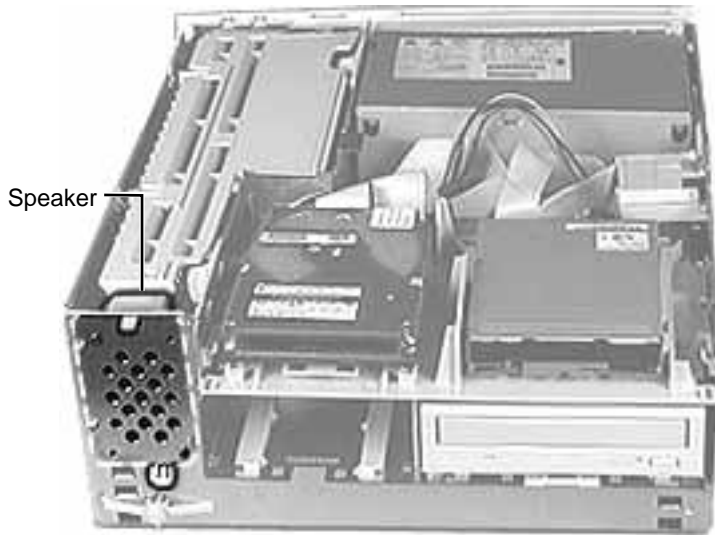

Speaker

Before you begin, remove the top housing.

Note: As you face the computer, the speaker is in the front left corner of the bottom chassis.



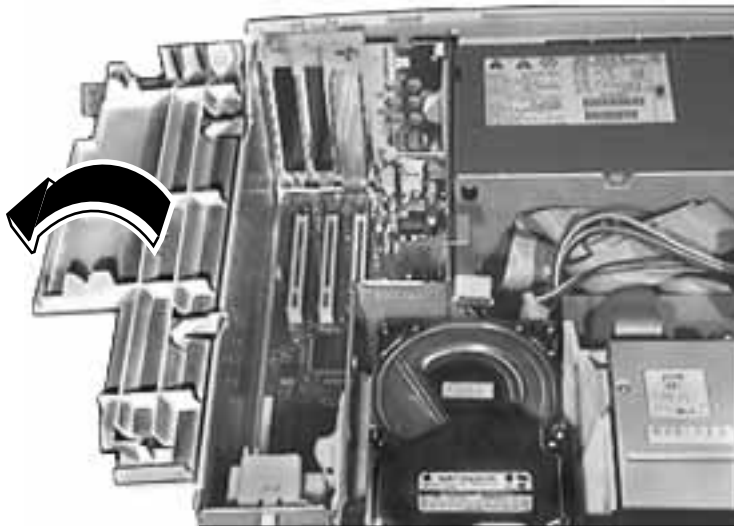

- 1 Swing open the expansion card cover.



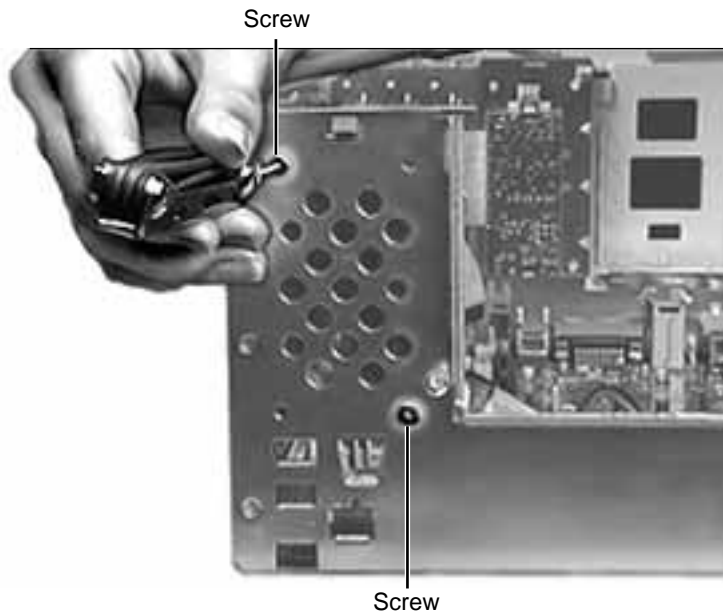

- 2 Remove the two Torx screws that secure the speaker to the metal chassis.



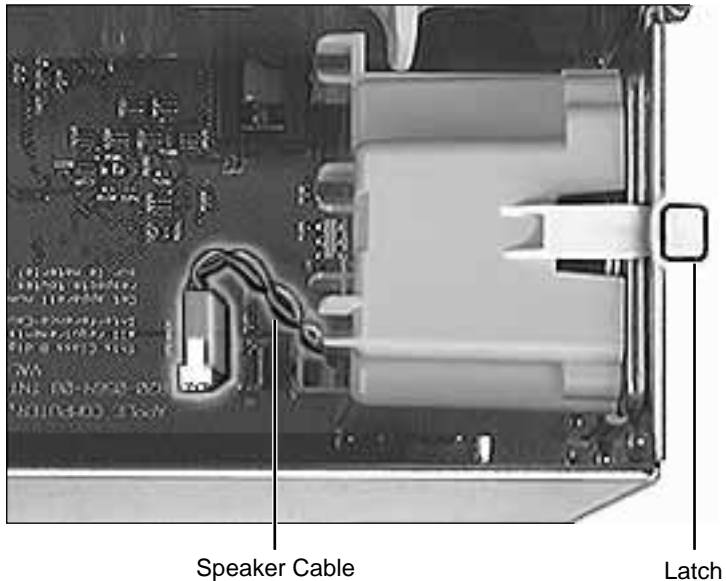

Speaker Cable

Latch

- 3 Disconnect the speaker cable from the logic board.
- 4 Press the latch holding the speaker to the chassis and lift the speaker out of the computer.





Power Actuator

Before you begin, remove the top housing.

Note: As you face the computer, the power actuator is in the front left corner of the bottom chassis (directly beneath the speaker).



Power Actuator



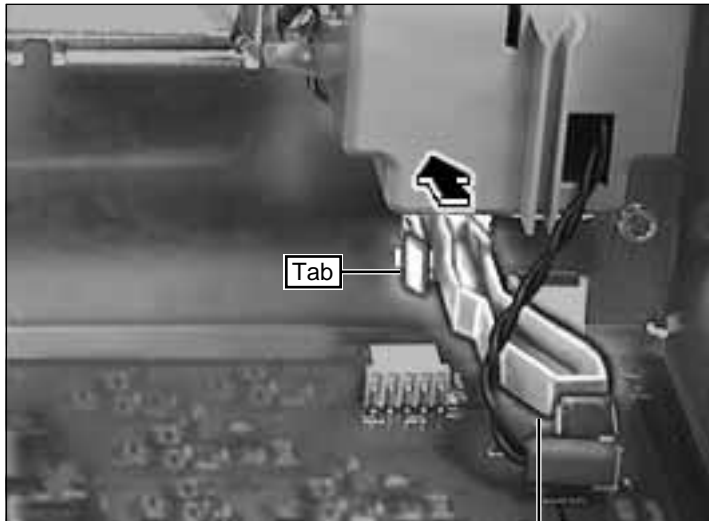

- 1 Push in the tab that secures the power actuator to the chassis and push the power actuator out of the computer.





PCI Covers

PCI Covers

Before you begin, remove the top housing.

Note: As you face the back of the computer, the PCI covers are on the right side of the rear panel.



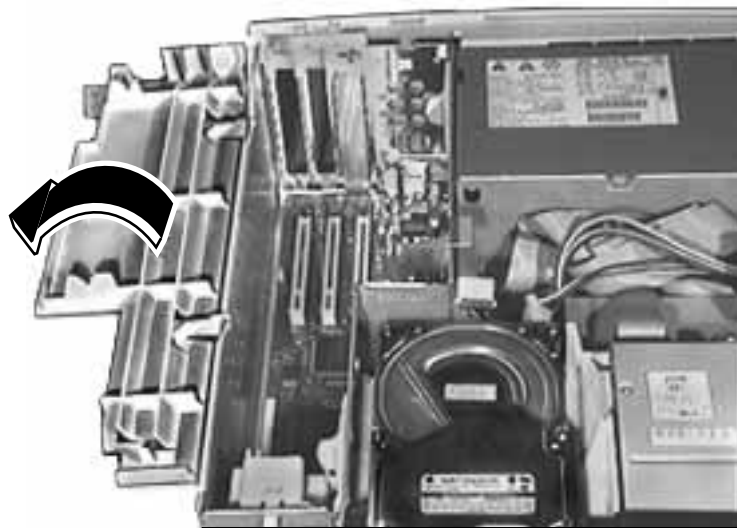

- 1 Swing open the expansion card cover.





PCI Cover

- 2 From the back of the computer, press in and lift up on the PCI cover to remove it.



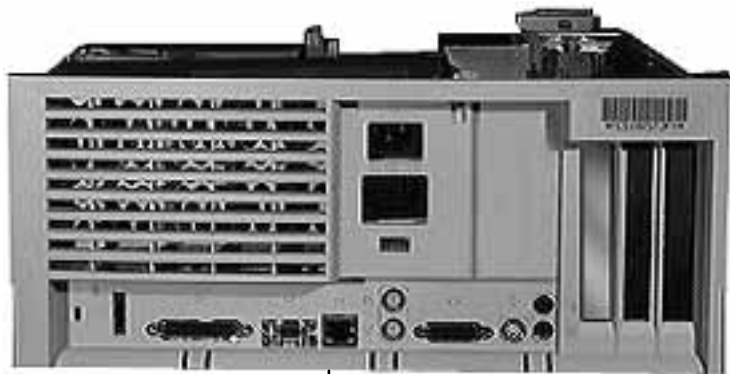

Rear Panel

Rear Panel

Before you begin, remove the top housing.

Note: The rear panel covers the back side of the computer through which all the external connectors are accessible.



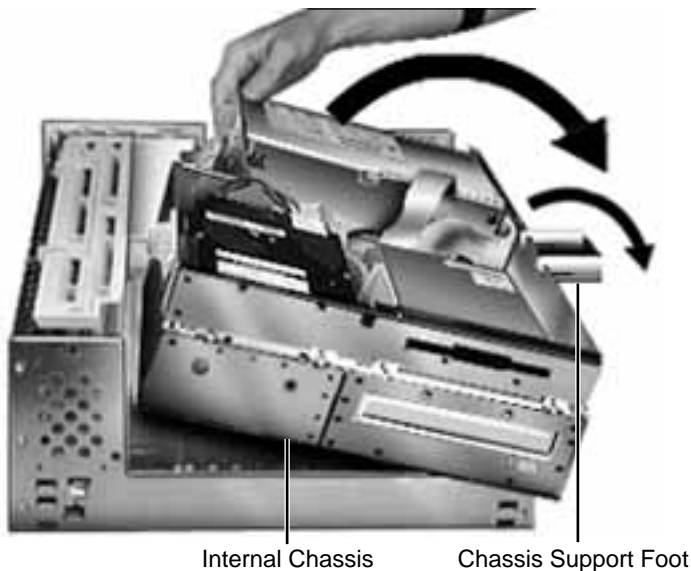

- 1 First, release the chassis latches. Next, flip open the chassis support foot and then swing open the internal chassis that contains the power supply.

IMPORTANT: On some 90 and 120 MHz versions there is a fan that plugs into the logic board at connector J70. You must unplug the fan as you are swinging open the chassis. Be sure to plug the fan back in when you put the unit back together.



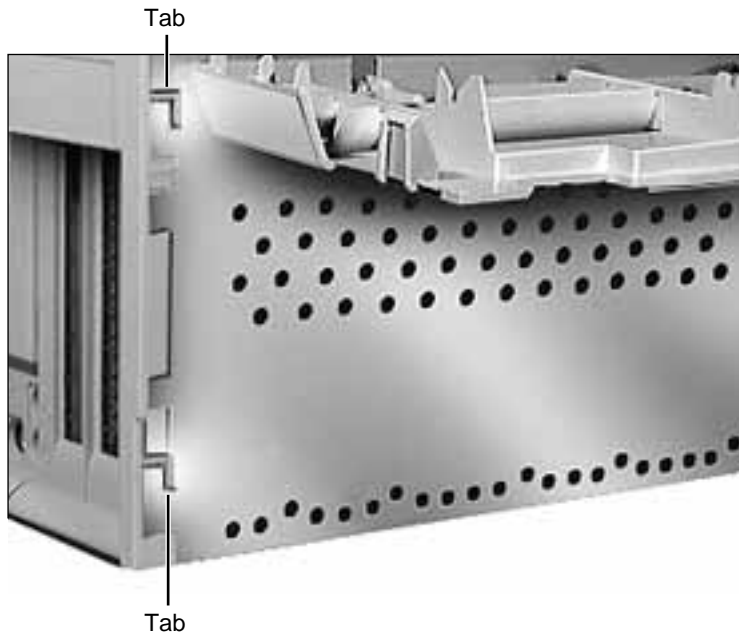

- 2 Lift the rear panel straight up to unhook it from the chassis. Once the rear panel is unhooked, you can remove it from the computer.

Note: There are tabs on the rear panel that hook into the metal chassis.

IMPORTANT: On some 90 and 120 MHz versions there is a fan that plugs into the logic board at J70. Be sure to plug the fan back in when you put the unit back together.





Replacement Note: To replace the rear panel, you must first follow the procedures for removing the logic board. Instead of fully removing the logic board from the chassis, however, just slide it forward about an inch. Once you have the rear panel in place, slide the logic board back toward the rear panel until the board locks into place. Be sure the logic board connectors are lined up properly with the openings in the rear panel.





PCI Cards

Before you begin, remove the top housing.

Note: PCI expansion cards, if present, install perpendicularly to the logic board in one of three PCI slots. They are located directly beneath the plastic PCI guide.

If installing third-party PCI cards, use the middle PCI slot for better clearance with the expansion card cover. If necessary, remove the expansion card cover.



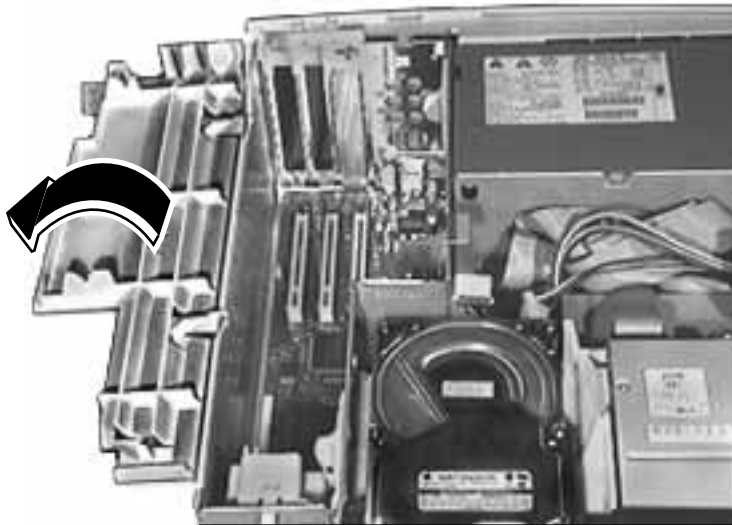

- 1 Swing open the expansion card cover to provide access to the logic board.



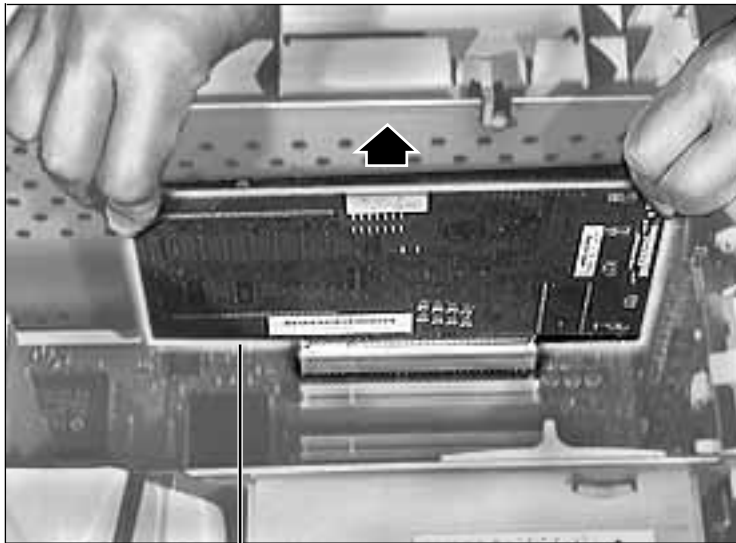

PCI Card

- 2 Grab the corners of the PCI card and pull up the card to remove it.

Replacement Note: When installing third-party PCI cards, use the middle PCI slot for better clearance with the expansion card cover. If the expansion card cover will not close completely once the third-party card is installed, remove the expansion card cover. Be sure to check for proper clearance when replacing the computer's top housing.



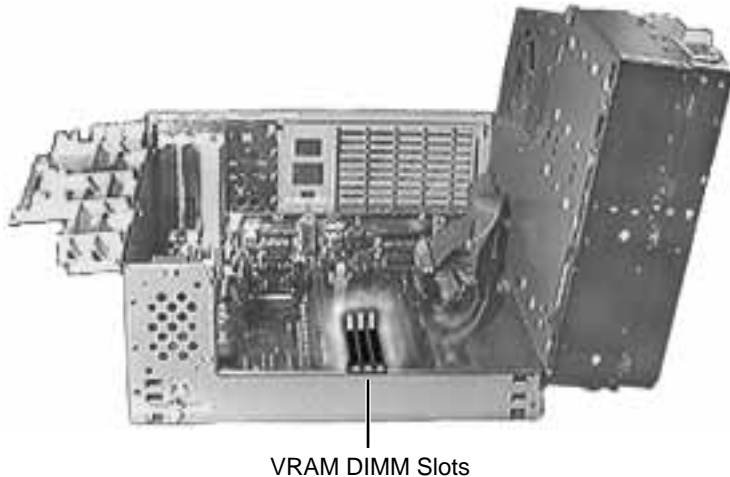

VRAM DIMMs

Before you begin, remove the top housing.

Note: VRAM DIMMs install in the VRAM DIMM slots on the logic board.

Note: The Power Macintosh 7200 Series and WS 7250 computers use VRAM DIMMs (112-pin, 70 ns or faster) instead of VRAM SIMMs. The VRAM SIMMs used in earlier Power Macintosh models are not compatible.



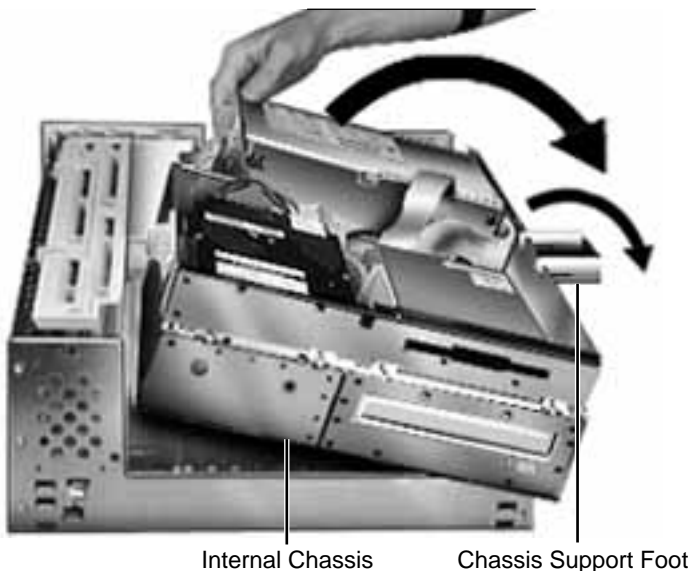

- 1 First, release the chassis latches. Next, flip open the chassis support foot and then swing open the internal chassis that contains the power supply.

IMPORTANT: On some 90 and 120 MHz versions there is a fan that plugs into the logic board at connector J70. You must unplug the fan as you are swinging open the chassis. Be sure to plug the fan back in when you put the unit back together.



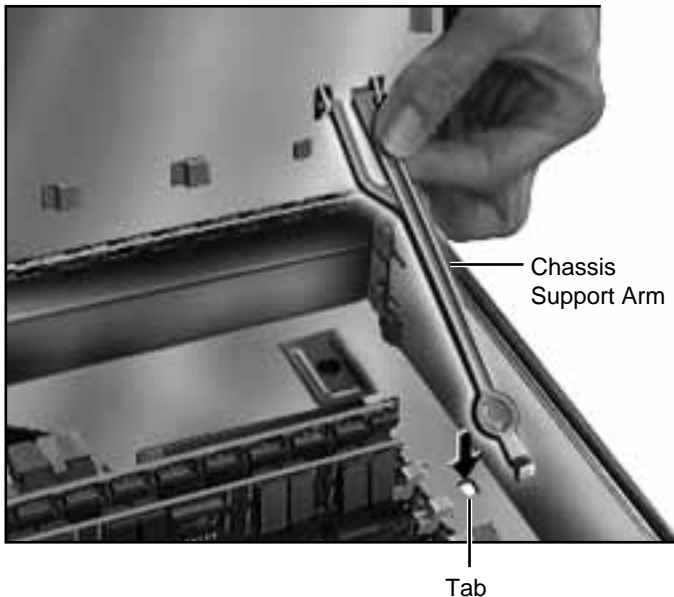

- 2 To secure the internal chassis in the up position, flip down the chassis support arm and make sure its bottom tab is securely fastened in the hole provided in the bottom chassis.

Warning: To be safe, never work on the computer with the internal chassis in the up position unless the chassis support arm is down and securely fastened.





Release Latch

VRAM DIMM

- 3 Push down the release latch next to the VRAM DIMM. Grab the DIMM by the top corners and lift straight up to remove the DIMM.

Note: See the following pages for important replacement information.





Replacement Note: Position the DIMM evenly over the slot and press down gently to install it. The release latch should click into place. Do not force the DIMM or you may damage it. Make sure the DIMM is evenly seated.

Note: These computers use VRAM DIMMs (112-pin, 70 ns or faster) instead of VRAM SIMMs. The VRAM SIMMs used in earlier Power Macintosh models are not compatible.

Note: 1 MB of VRAM is soldered to the board. To go to 2 MB, install one 1 MB VRAM DIMM in slot 1. To go to 4 MB, install three 1 MB VRAM DIMMs in slots 1, 2, and 3. VRAM slots 2 and 3 must be populated together.



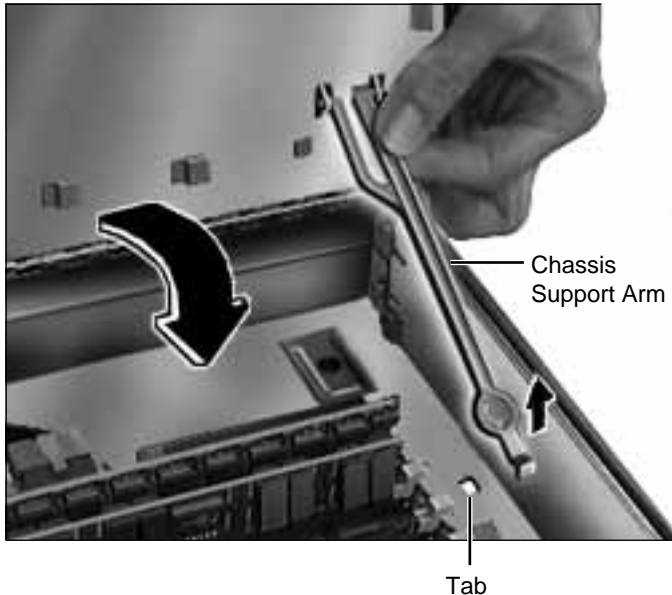

- 4 Be sure to release the chassis support arm before you swing down the internal chassis.

IMPORTANT: On some 90 and 120 MHz versions there is a fan that plugs into the logic board at connector J70. Be sure to plug the fan back in when you put the unit back together.



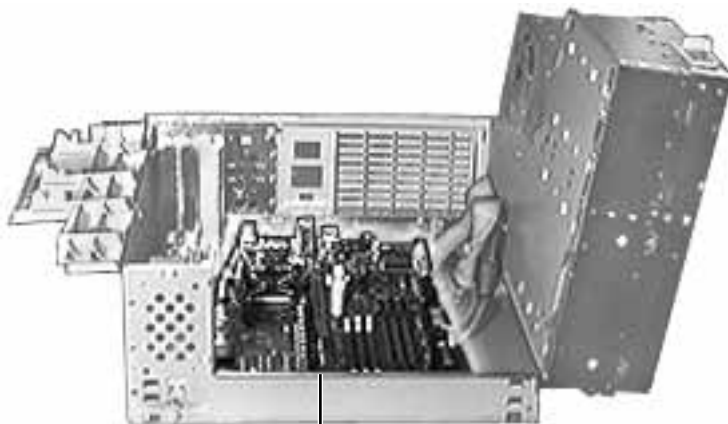

Logic Board

Logic Board

Before you begin, remove the following:

- Top Housing
- PCI Cards (if present)
- Speaker
- Power Actuator

Note: The logic board is located in the very bottom of the bottom chassis.



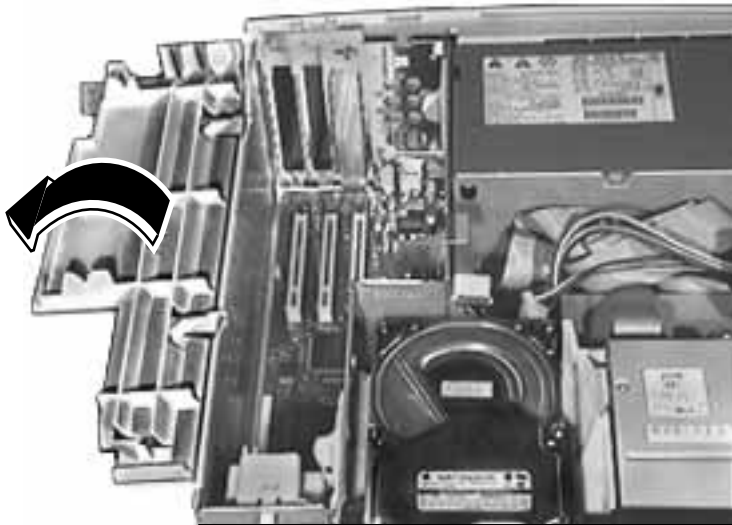

- 1 Swing open the expansion card cover to provide access to the logic board.



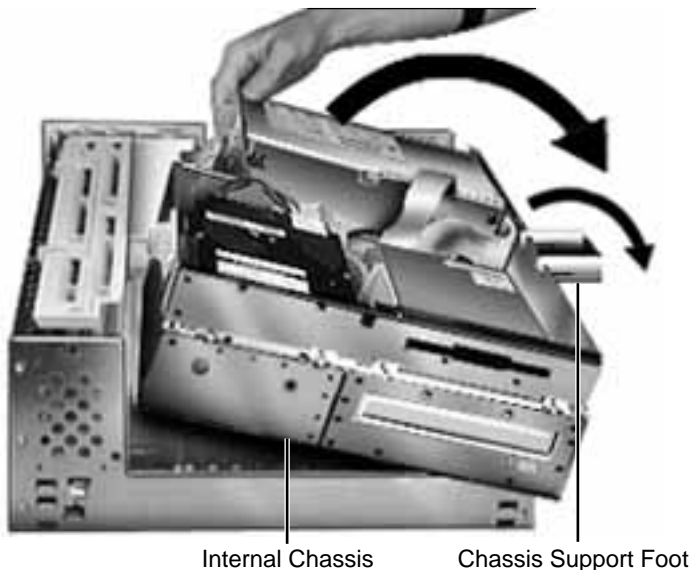

- 2 First, release the chassis latches. Next, flip open the chassis support foot and then swing open the internal chassis that contains the power supply.

IMPORTANT: On some 90 and 120 MHz versions there is a fan that plugs into the logic board at connector J70. You must unplug the fan as you are swinging open the chassis. Be sure to plug the fan back in when you put the unit back together.



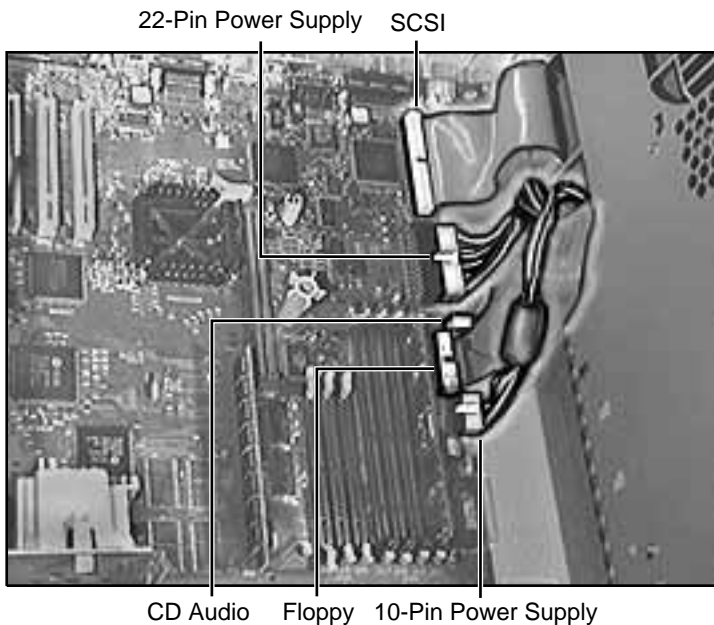

- 3 Disconnect the following cables from the logic board: both power supply cables, floppy drive cable, SCSI cable, and CD audio cable.



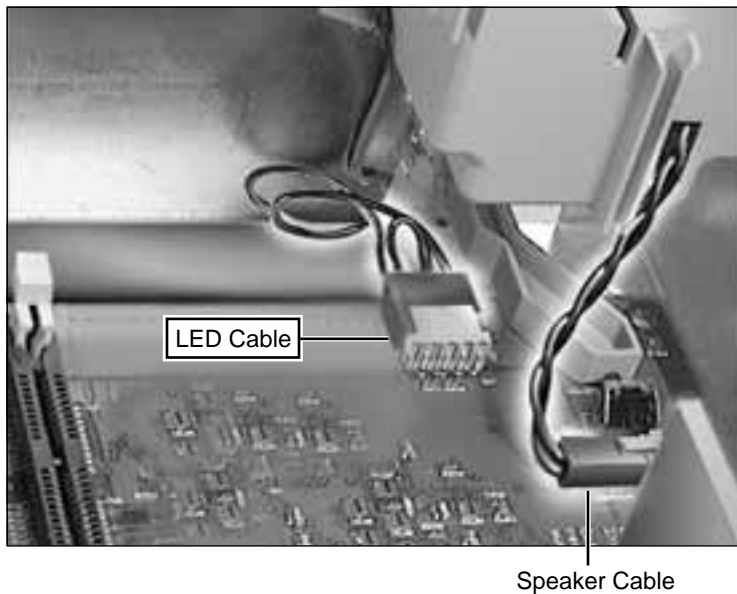

- 4 Disconnect the LED and speaker cables from the logic board.





Top Column Support

- 5 Remove the screw inside the top column support that secures the logic board to the chassis.



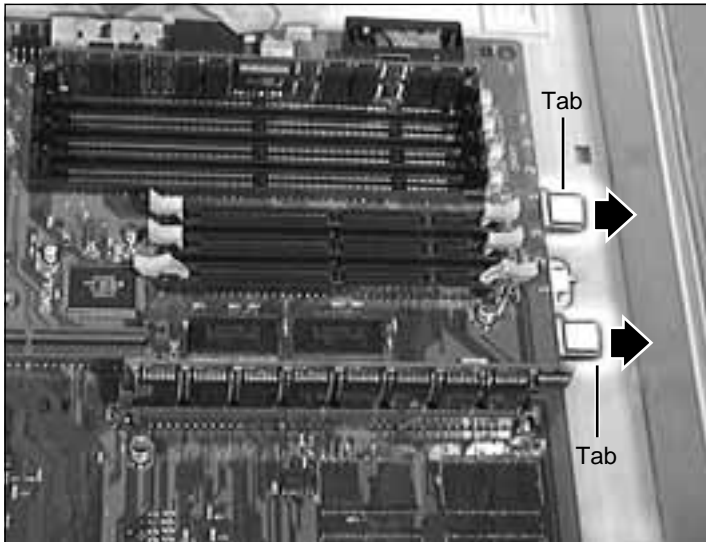

- 6 Press down on the two tabs at the front of the logic board and slide the board forward (away from the rear panel) to release it from the tabs on the bottom chassis. Lift the logic board from the chassis to remove it.

IMPORTANT: Remove the EMI clip when you take the logic board out of the chassis. Failure to comply may result in damage to the board. (See the next page for instructions).



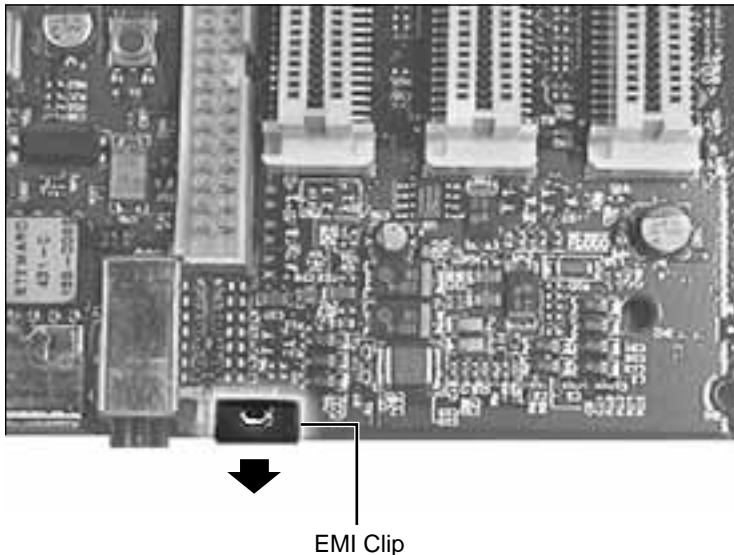

- 7 Lift up the top edge of the EMI clip and pull it off the board to remove it.

IMPORTANT: Some 90 and 120 MHz versions have a fan that plugs into the logic board at J70. Be sure to plug the fan back in when you put the unit back together.

Note: Remove the EMI clip and any cache, DRAM, or VRAM DIMM(s) before returning the logic board to Apple. Do NOT remove the ROM SIMM (if present).





Processor Fan

Before you begin, remove the top housing.

IMPORTANT: Only some versions of the 90 and 120 MHz logic board use the processor fan. If you replace the processor fan, make sure you plug it back into the logic board before you replace the top housing.

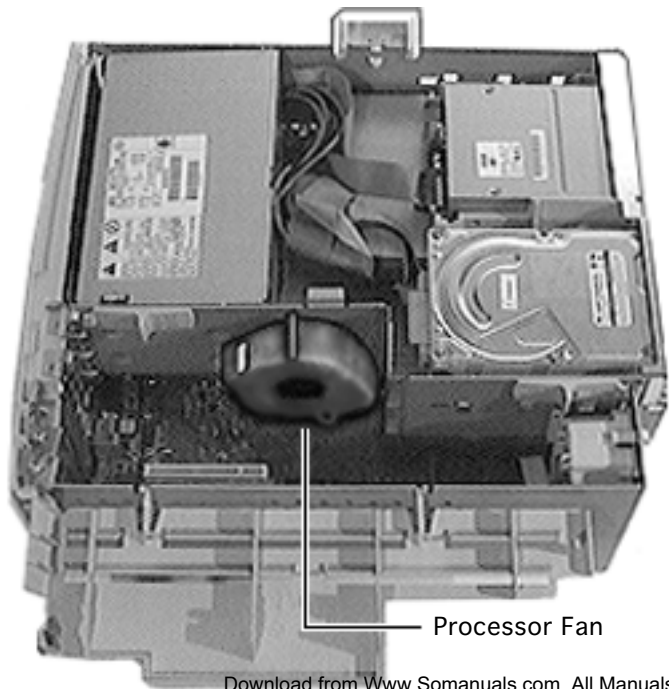

Processor Fan





- 1 Unplug the fan connector from the logic board.

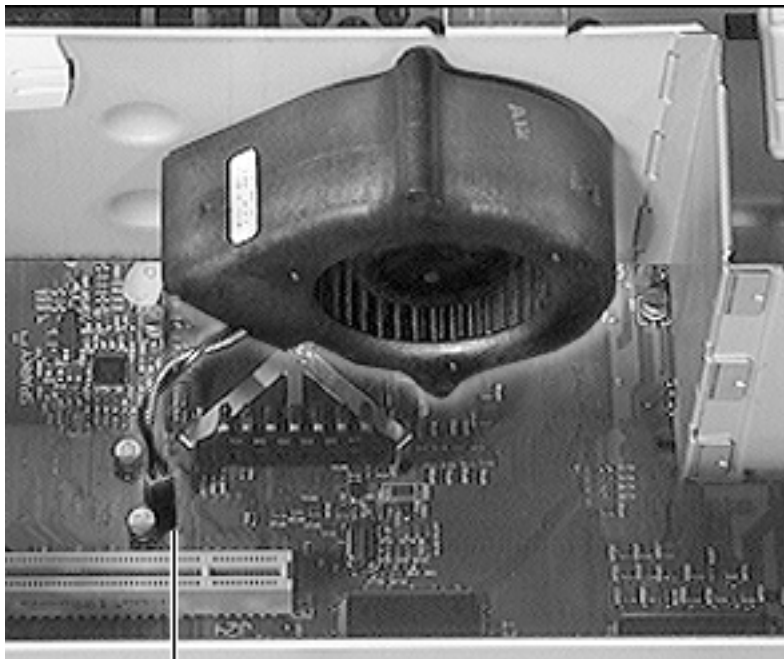

Fan Connector



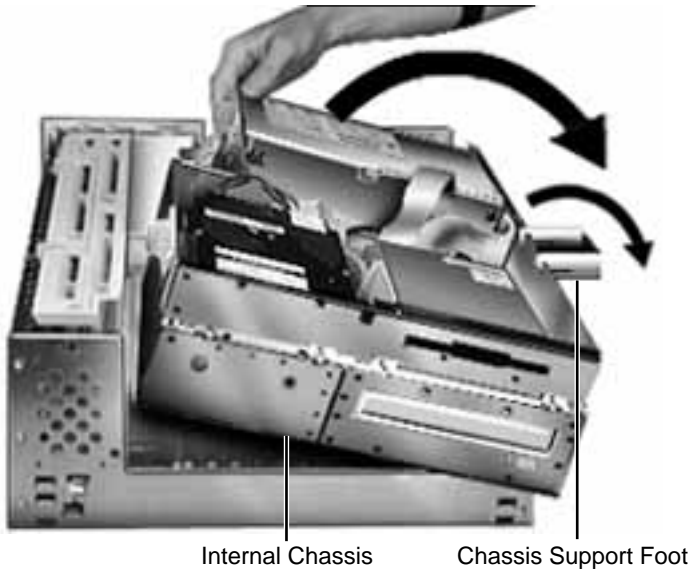

- 2 First, release the chassis latches. Next, flip open the chassis support foot and then swing open the internal chassis that contains the power supply.



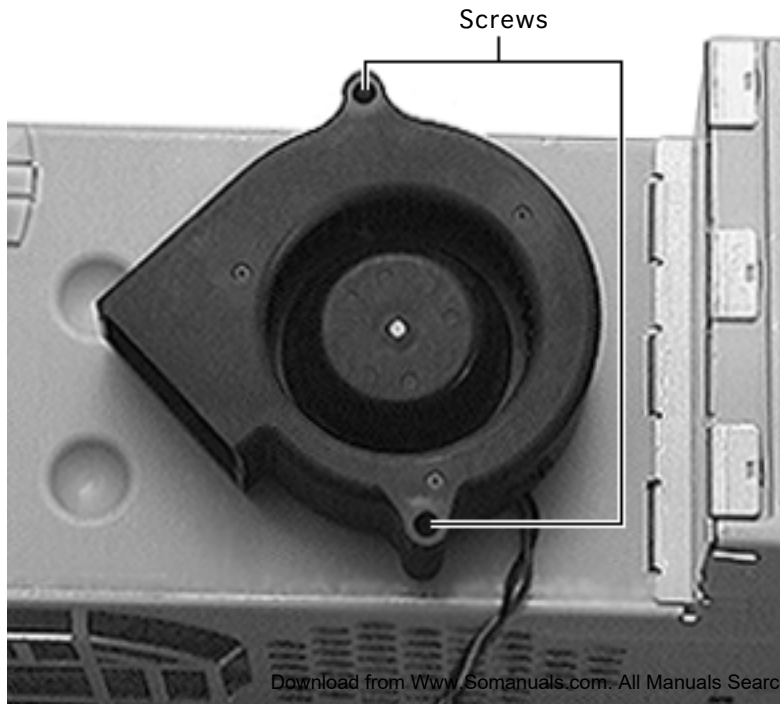

- 3 Remove the two screws that attach the processor fan to the internal chassis.

Replacement Note: The processor fan installs at an angle so that it blows down directly on the processor when the internal chassis is closed.



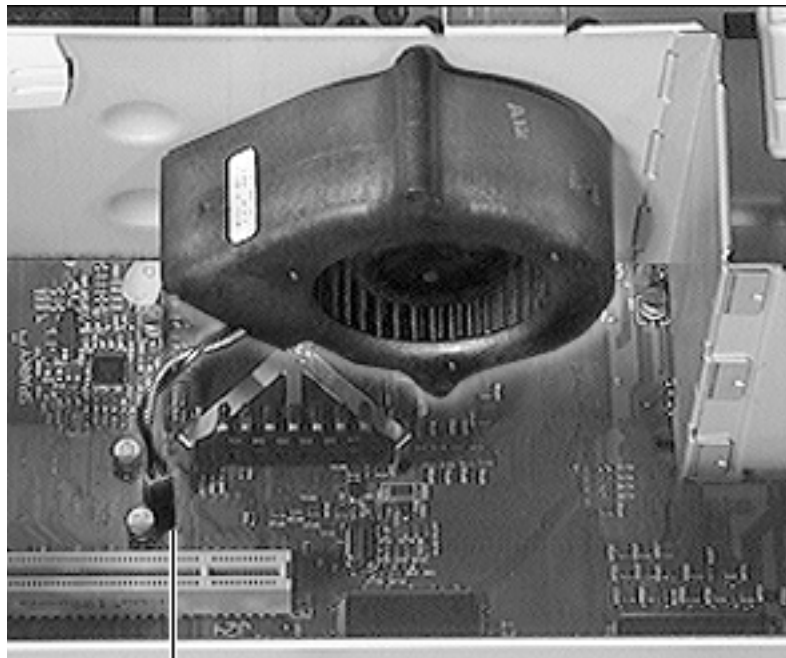

Replacement Note: Be sure to plug the processor fan connector back into the logic board.

Fan Connector



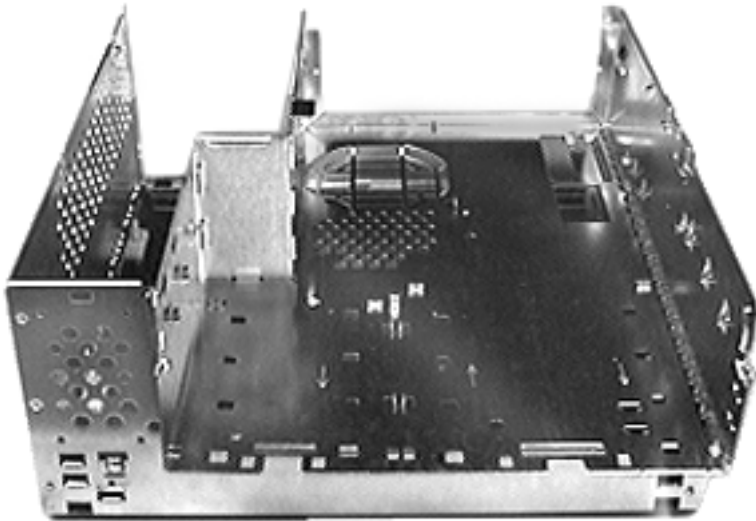

Bottom Chassis

Before you begin, remove:

- Top Housing
- PCI Cards (if present)
- AV Module
- Speaker
- Power Supply
- Power Actuator
- All Drives
- Chassis Latches
- Drive Rails
- Logic Board
- Rear Panel
- Fan (if present)



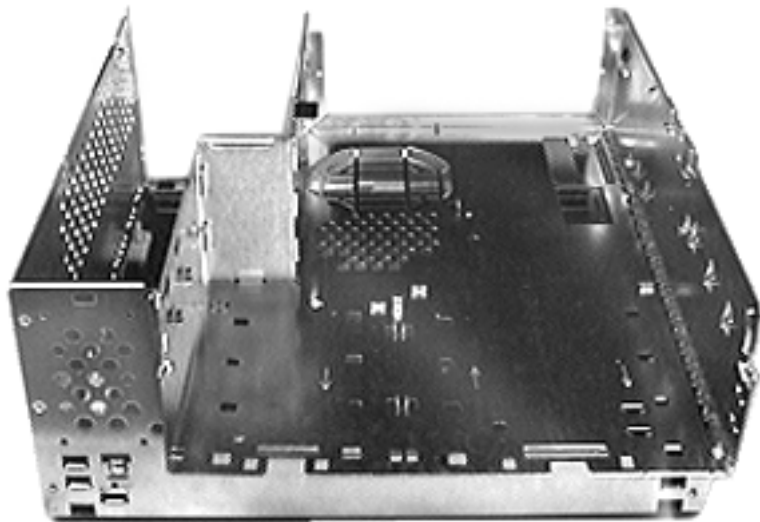

Note: The bottom chassis is what is left once all other modules have been removed.





Upgrades

Power Macintosh 7200 Series/
WS 7250





PC Compatibility Cards

There are three Apple PC Compatibility cards that can be installed in the Power Macintosh 7200 Series computers:

- 7" 100 MHz PC Compatibility Card
- 12" 100 MHz PC Compatibility Card
- 12" 166 MHz-P PC Compatibility Card

For more information about these cards and installation instructions, refer to the PC Compatibility Card manual on this Service Source CD.





Power Macintosh 7600 Upgrade

The Power Macintosh 7600 Upgrade kit includes:

- A Power Macintosh 7600 logic board
- An EMI clip and EMI gasket
- An AV module connector assembly
- A video out cover
- Two M 2.5x88mm screws
- A Power Macintosh 7600 product ID label

Note: Unlike the Power Macintosh 7200, the Power Macintosh 7600 logic board does not have a built-in processor. You must install a separate processor card.





Before you begin, remove the following components. Refer to the Take Apart chapter in this manual for instructions.

- Top Housing
- Processor Fan (if present)
- PCI Cards (if present)
- Speaker
- Power Actuator
- Cache DIMM
- DRAM DIMMs
- VRAM DIMMs

Note: Set the Cache, DRAM, and VRAM DIMMs aside as you will be installing them on the Power Macintosh 7600 logic board in a later step.



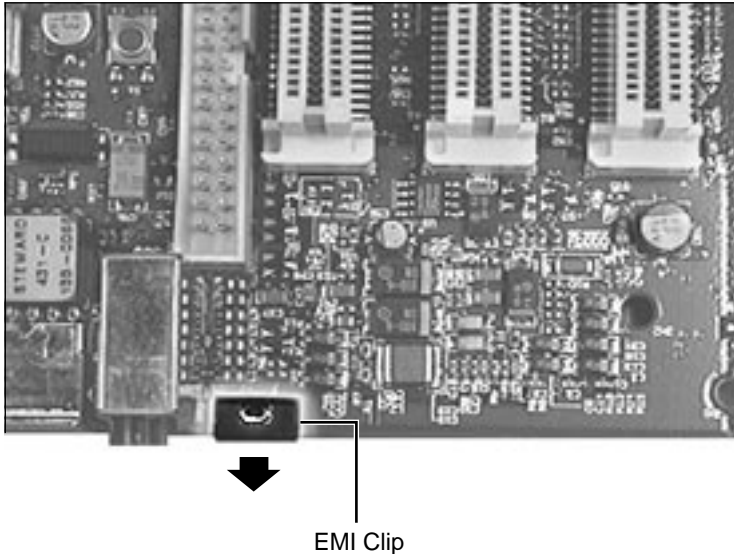

- 1 Remove the Power Macintosh 7200 logic board. (Refer to the Take Apart chapter for instructions.)

IMPORTANT: When you take the Power Macintosh 7200 logic board out of the chassis, remove the EMI clip or you may damage the board. The EMI clip is located next to the sound in and out ports.

Note: Do NOT remove the ROM SIMM (if present) from the old logic board.





- 2 Install the EMI gasket between the sound in and sound out ports on the Power Macintosh 7600 logic board.

Note: The gasket may already be installed. Be sure to check.





- 3 Install the EMI clip that came with the Upgrade Kit onto the Power Macintosh 7600 logic board in the same location as the one you removed from the old logic board at the very beginning of the upgrade procedure.

IMPORTANT: Once you have installed the EMI clip, do not set down the logic board or you may damage the board. Be sure to install the logic board into the bottom housing immediately.

- 4 Install the logic board in the computer.
- 5 Install on the Power Macintosh 7600 logic board any cache, DRAM, or VRAM DIMM(s) that you removed earlier from the Power Macintosh 7200 logic board.



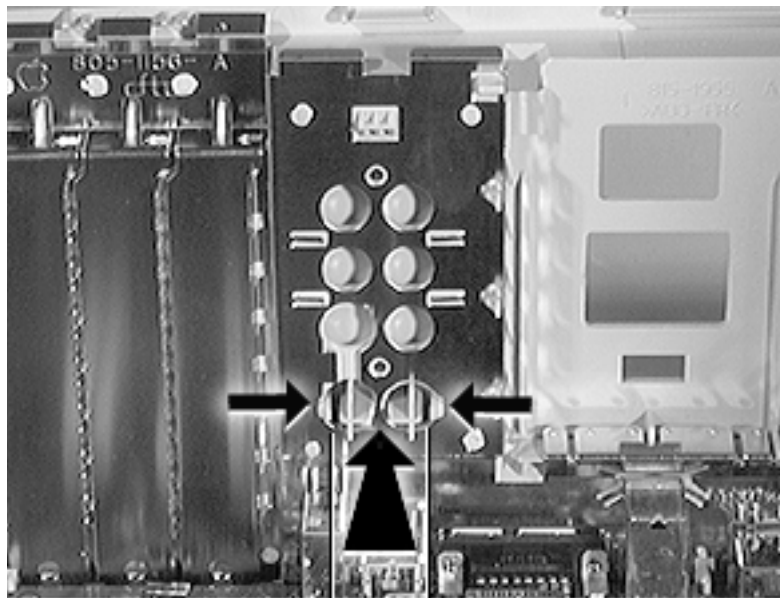

AV Cover Tabs

Download from www.Somanuals.com. All Manuals Search And Download.

Note: For the next two steps, turn the computer so you are facing the inside of the rear panel.

- 6 Press in on the two plastic tabs at the bottom of the blank AV module cover, and push out on the cover to remove it.

Note: Once the blank cover is removed, you will see a plastic frame with port holes for the AV module.



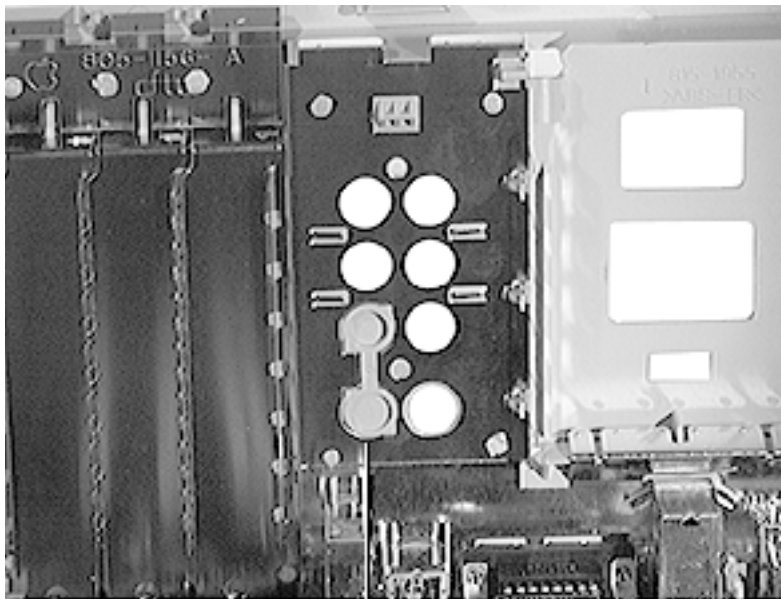

- 7 Place the video out cover over the bottom two openings on the left side.

Video Out Cover



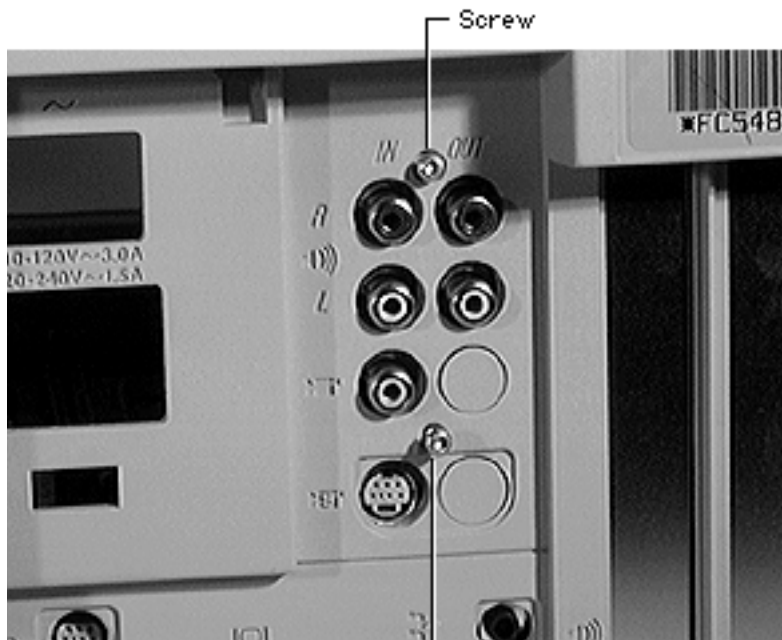

- 8 From the inside of the computer, position the AV module into the plastic frame so that its connectors fit into the appropriate holes in the frame.
- 9 Secure the AV module with the two screws that came in the Upgrade Kit.
- 10 Attach the AV module to the logic board. The AV connector on the logic board is located between the processor card slot and the first PCI slot.



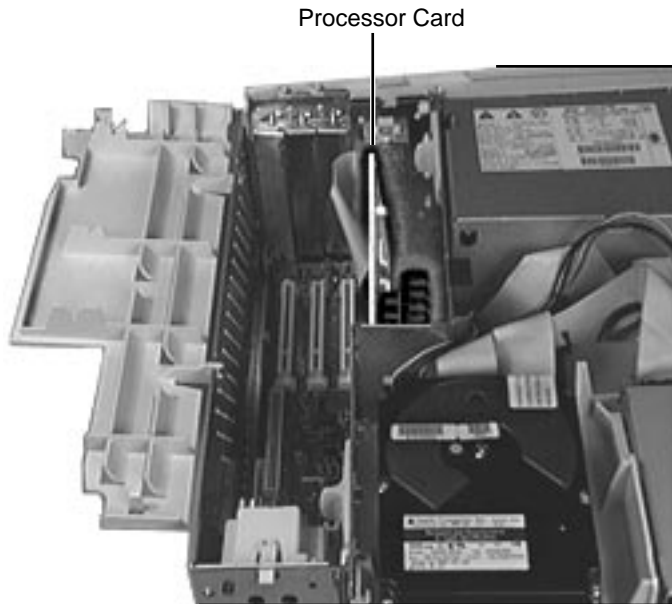

Note: At this point you must install a processor card in the computer. The processor card is not included in the Power Macintosh 7600 Upgrade Kit and must be purchased separately.

The processor card installs perpendicularly to the logic board directly beneath the plastic PCI guide.

Note: If you install a 132 or 150 MHz card, you must also install an EMI grounding clip.



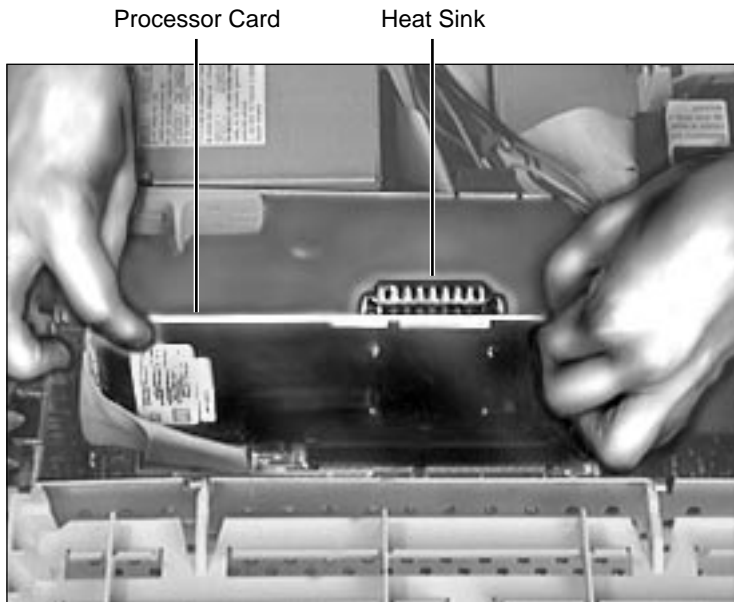

11 Position the card evenly over the processor card slot and press down gently. Do not force the card or you may damage it. Make sure the card is seated evenly.

Note: If the card is properly seated, the gold contacts on the card should not be visible.



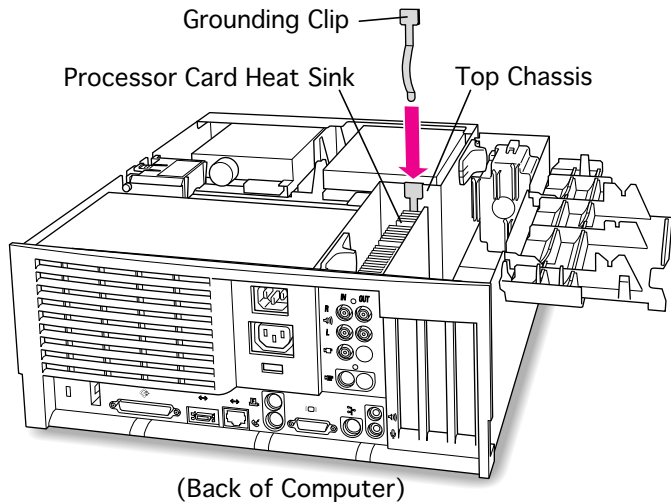

12 If you are installing a 132 MHz card, be sure to install the EMI grounding clip that came with the 132 MHz Upgrade Kit.





13 Replace the following components. Refer to the Take Apart chapter for instructions:

- Power Actuator
- Speaker
- PCI Cards (if present)
- Top Housing

IMPORTANT: Do not replace the processor fan (if present in the original Power Macintosh 7200 unit). The fan is not used with the Power Macintosh 7600 logic board and will interfere with air flow and the installation of the processor card.

14 Affix the Power Macintosh 7600 product ID label over the original Power Macintosh 7200 label.





Exploded View

Power Macintosh 7200 Series/
WS 7250



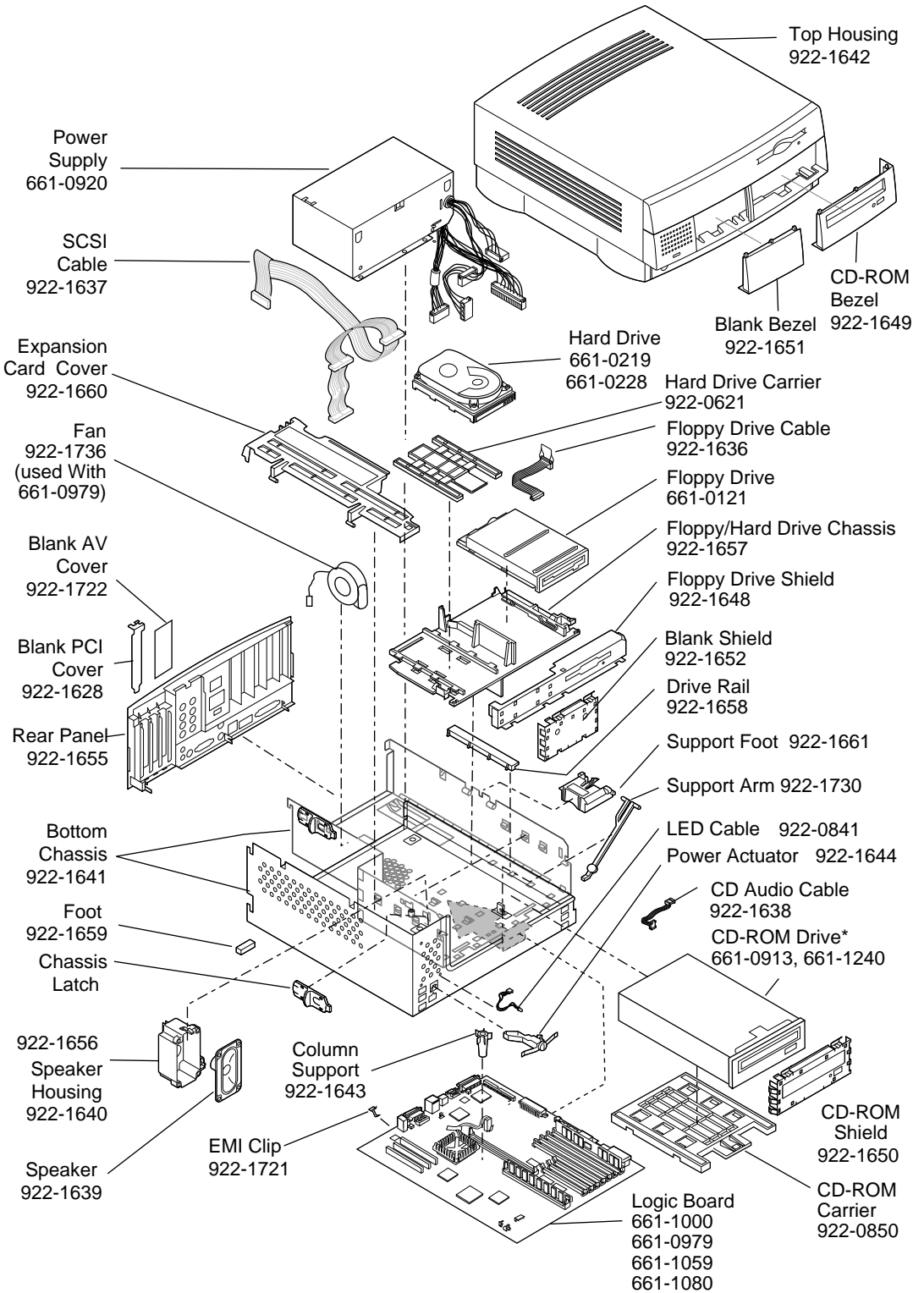

Product family configurations may vary. For parts with asterisk (*), refer to parts list.

Power Macintosh 7200 Series



Free Manuals Download Website

<http://myh66.com>

<http://usermanuals.us>

<http://www.somanuals.com>

<http://www.4manuals.cc>

<http://www.manual-lib.com>

<http://www.404manual.com>

<http://www.luxmanual.com>

<http://aubethermostatmanual.com>

Golf course search by state

<http://golfingnear.com>

Email search by domain

<http://emailbydomain.com>

Auto manuals search

<http://auto.somanuals.com>

TV manuals search

<http://tv.somanuals.com>