

Processor Cage Fans, Front and Rear Replacement Instructions

First Steps

Note: Follow these instructions carefully. Failure to do so could damage your equipment and void its warranty.

- 1 Shut down computer.
- 2 Wait 10 minutes.
- 3  **Warning:** Parts inside computer can be very hot. Allow computer to cool down before continuing.
- 4 Unplug all external cables except power cord.
- 5 Touch metal PCI cover on back of computer.
- 6 Unplug power cord.

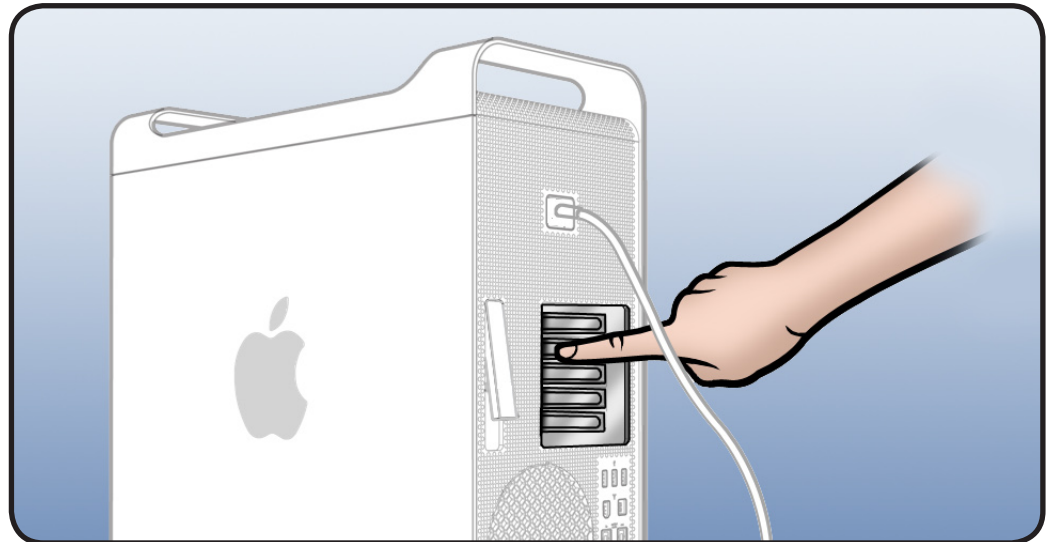

Opening the Computer

- 1 Hold side access panel and lift latch on back of computer.
- 2  **Warning:** Edges of access panel and enclosure can be sharp. Be careful when handling.
- 3 Remove access panel and place it on flat surface covered by soft, clean cloth.

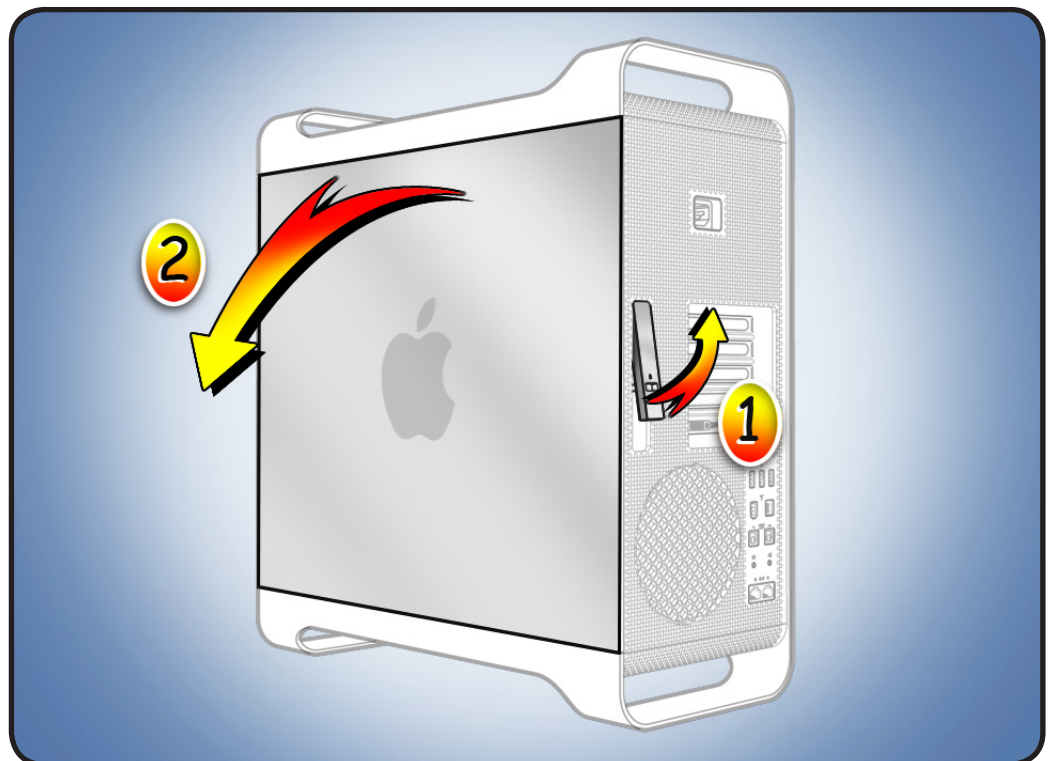

Required Tools

- Phillips #2 screwdriver
- Right-angle, 2.5 mm hex driver
- Flatblade screwdriver
- Long-handled Phillips #1 screwdriver

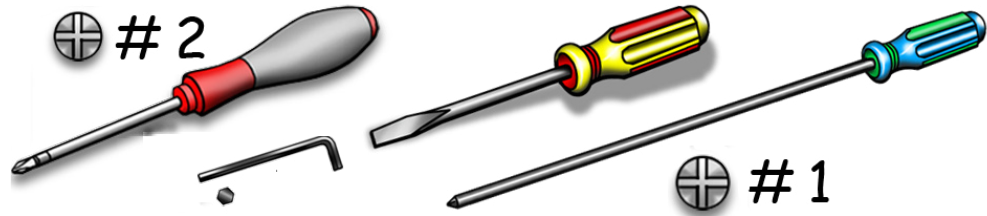

Removing the Installed Fans

Fans are installed in processor cage. To access fans, you must first remove:

- Hard drive in far-left drive bay
- Graphics card in slot 1
- Processor tray
- PCIe fan
- Processor cage

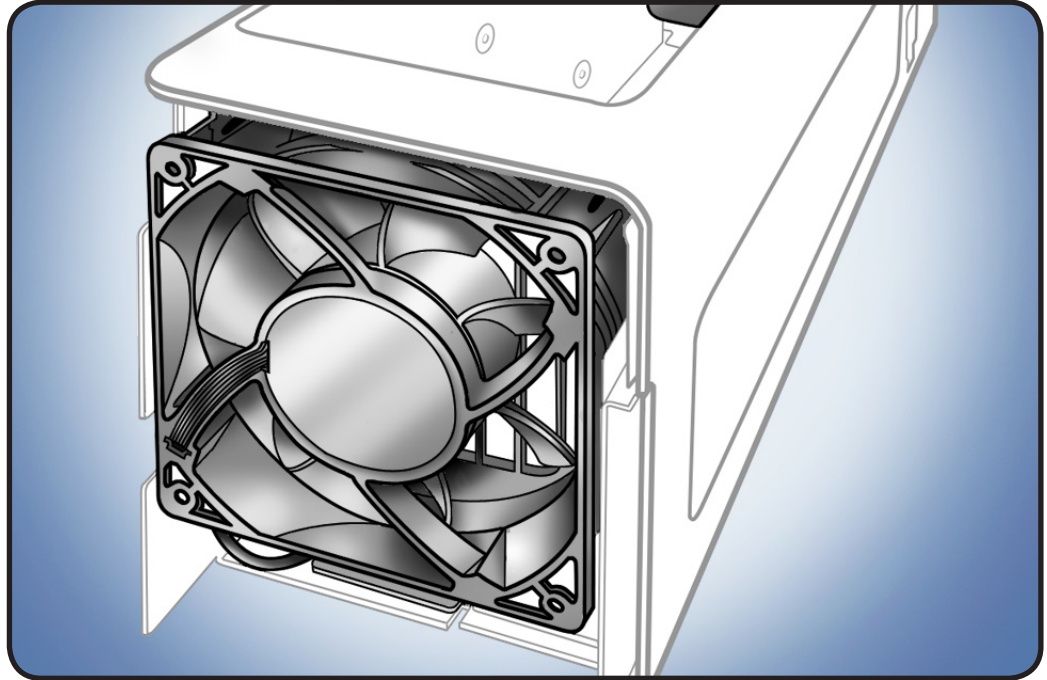

Hard Drive

- 1 Make sure latch on back panel is up, so that drive is unlocked.
- 2 Pull hard drive out of far-left drive bay.

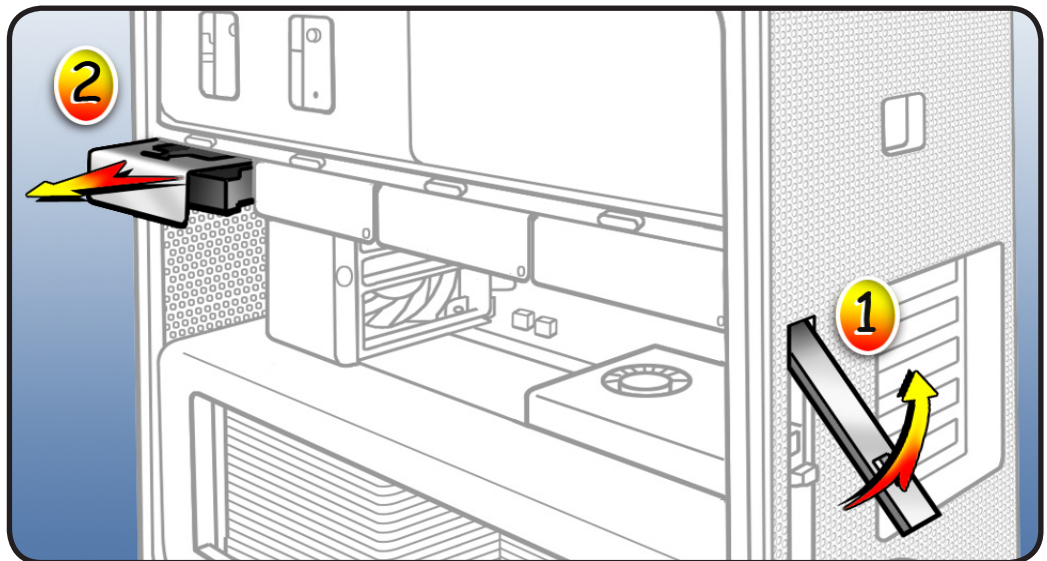

Graphics Card

- 3 Locate graphics card in slot 1.

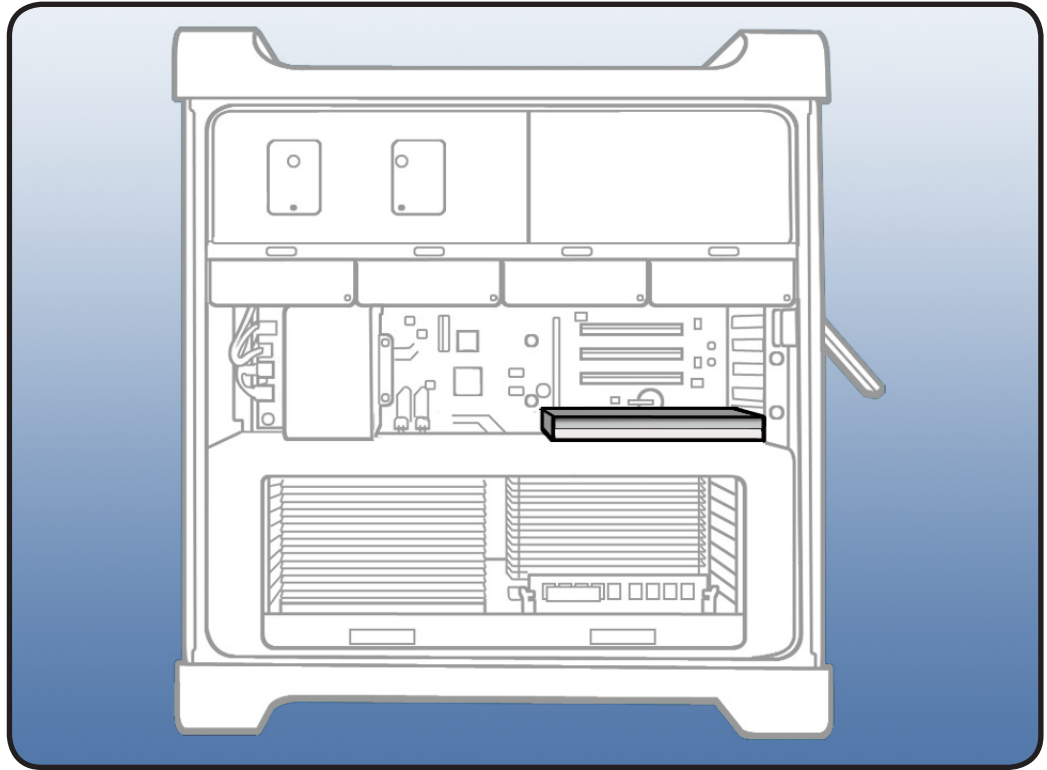

- 4 Using Phillips #1 screwdriver, loosen 2 captive screws securing card's bracket to enclosure.

- 5 Remove bracket from enclosure.

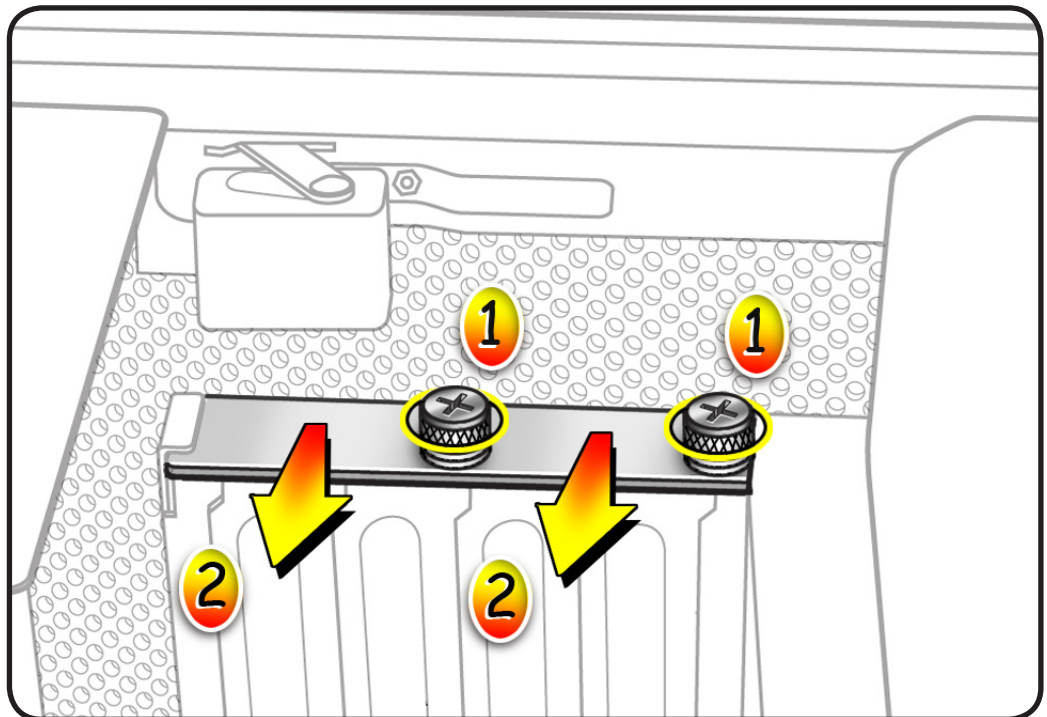

Note: Card is held in place by retention bar. Following two steps explain how to release bar.

- 6 Press button on PCIe fan.
- 7 Move fan to left, which releases retention bar.

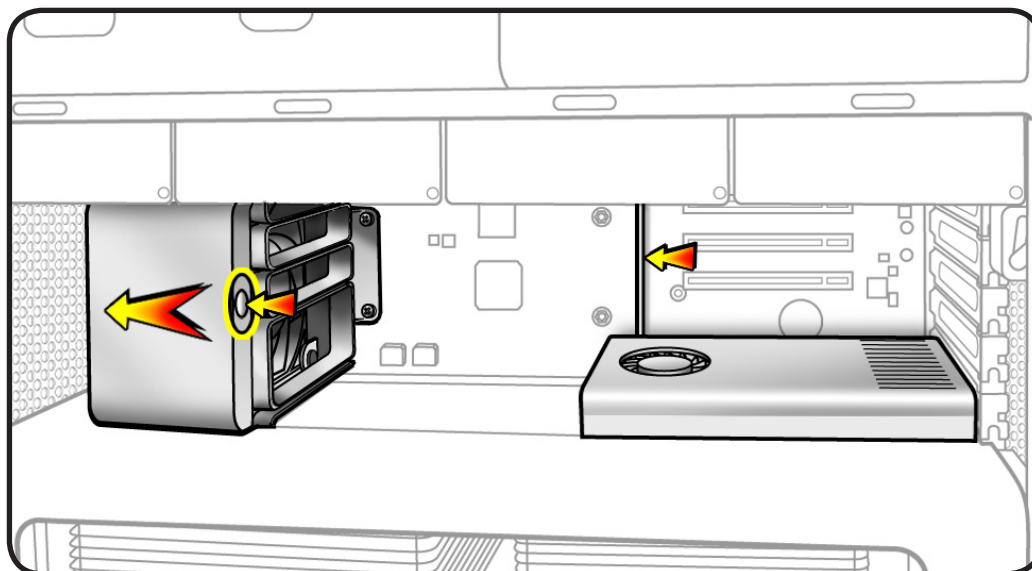

Note: Some graphics cards require 1 or 2 booster cables connecting card to auxiliary power connectors on backplane board. If your card has booster cables, disconnect them from backplane board.

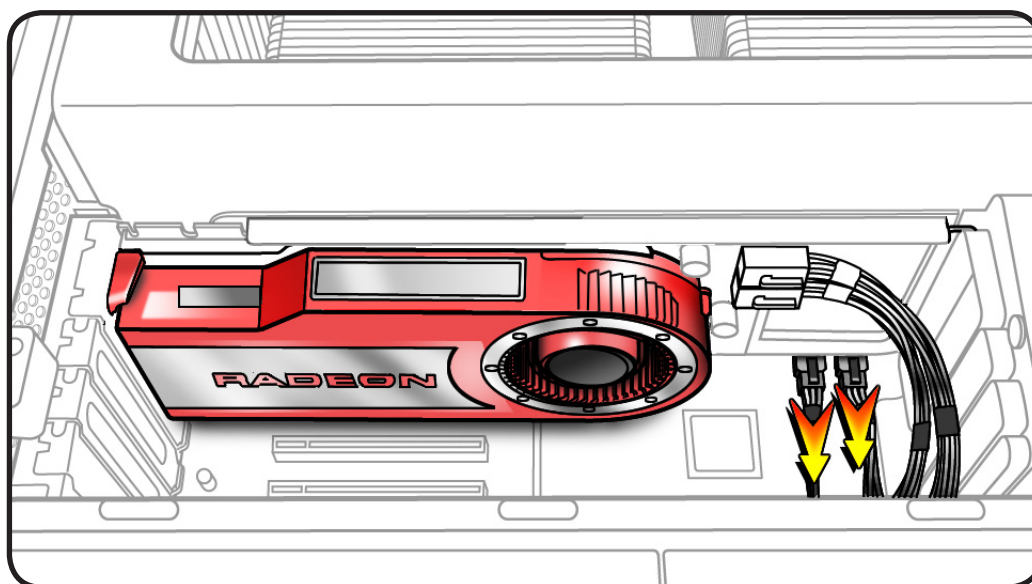

8 Holding card by top corners, pull it up out of slot.

9 Remove card from computer.

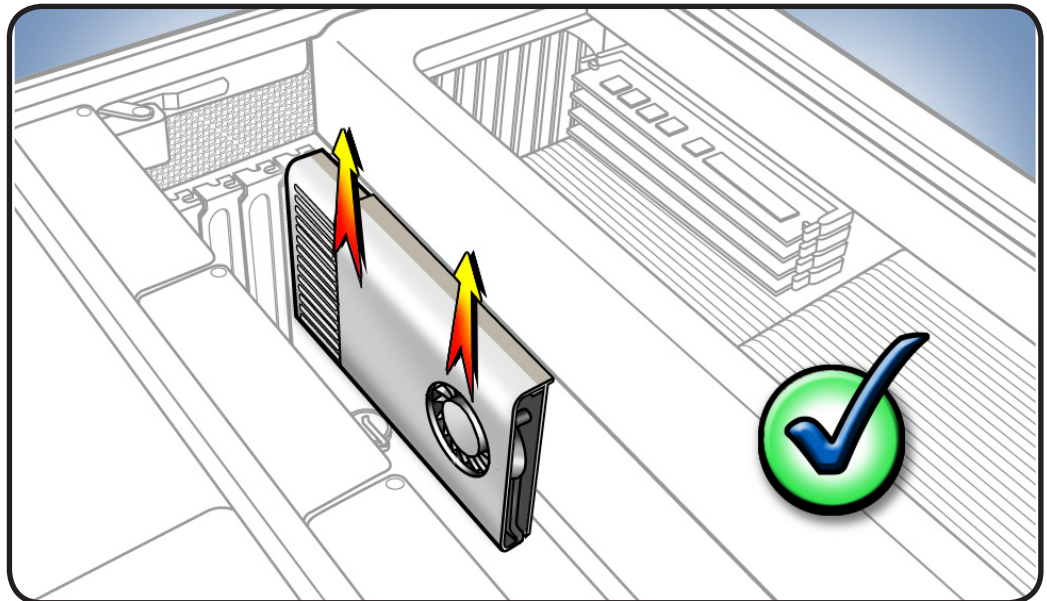

Checklist for handling card:

- When removing or installing card, handle it only by the edges. Do not touch its connectors or any components.
- Don't rock card from side to side; instead, lift card straight up from connector to remove it, and press card straight into slot to install it.
- Don't force card. If you meet a lot of resistance, pull card out. Check connector and slot for damage or obstructions, then try inserting card again.
- Pull card gently to see if it is properly connected. If it resists and stays in place and its gold connectors are barely visible, card is connected.

Processor Tray

10 Locate processor tray.

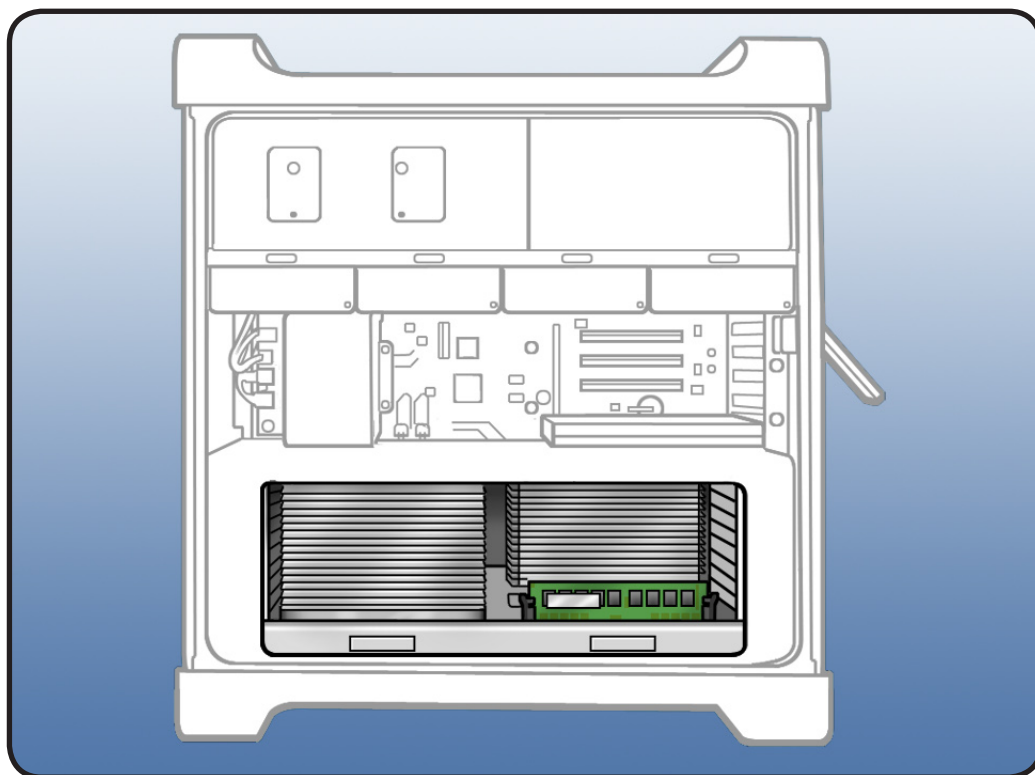

11 Press down and release 2 latches on front of processor tray.

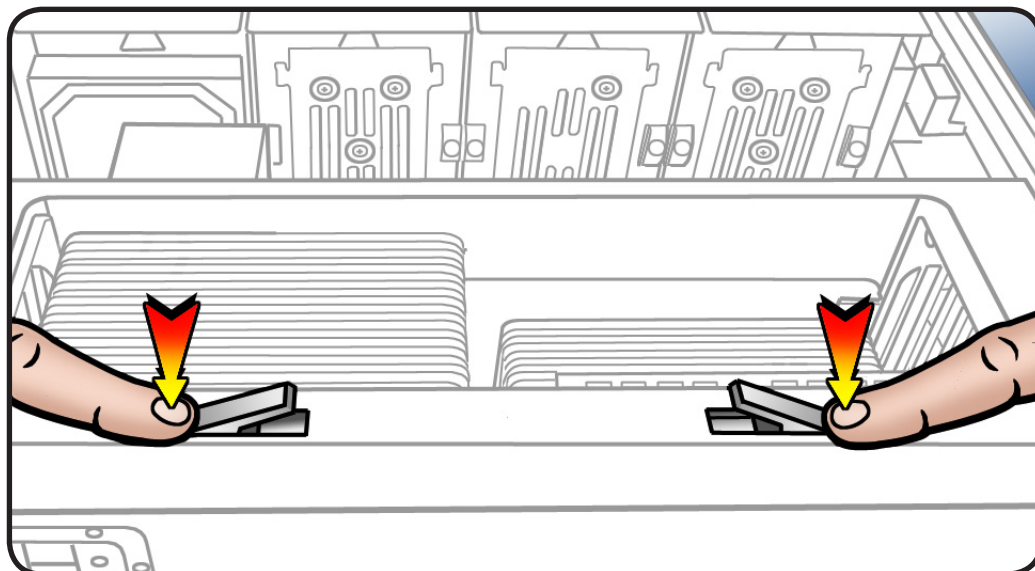

12 Holding tray by latches, lift it out of computer.

13 Place tray DIMM side up on soft, clean cloth.

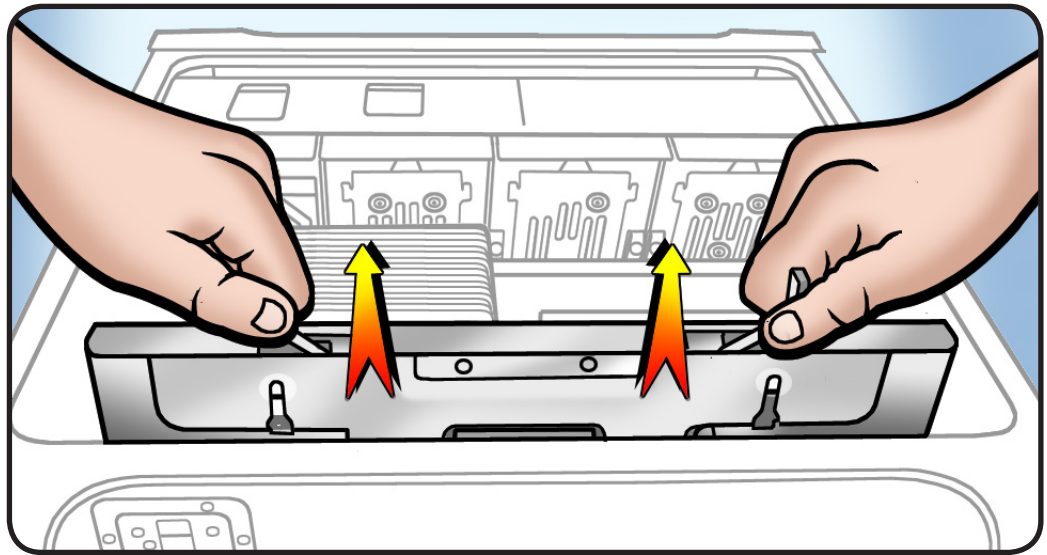

PCIe Fan

14 Locate PCIe fan.

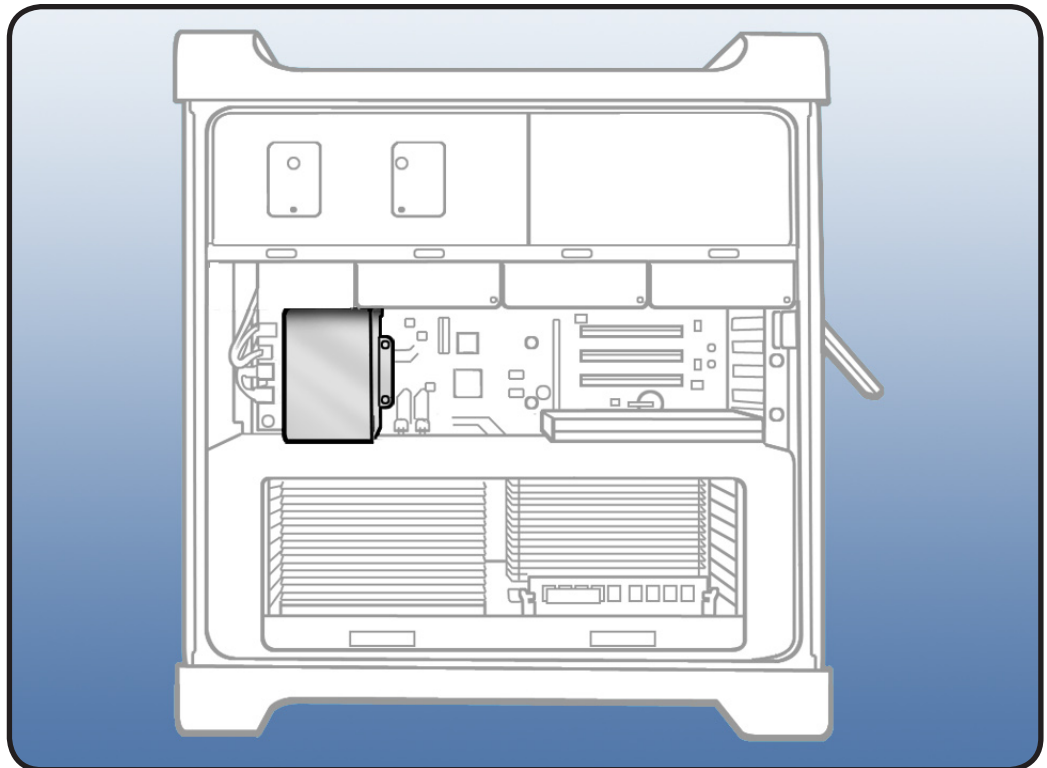

15 Remove 2 screws.

16 Slide fan up and out of computer.

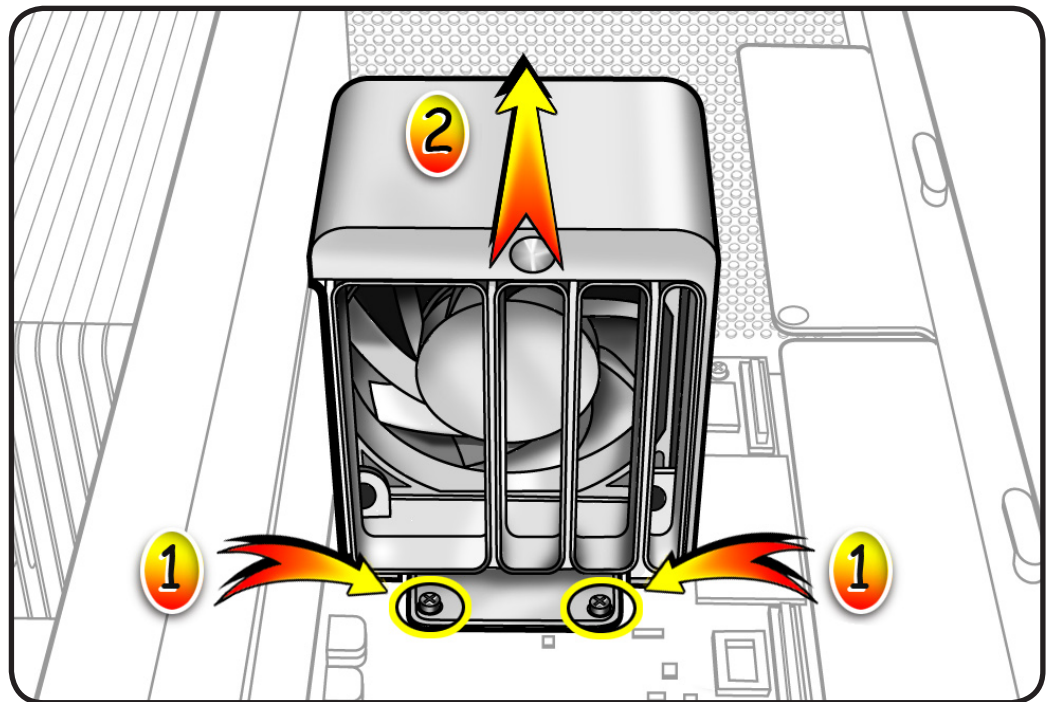

Processor Cage

17 Locate processor cage.

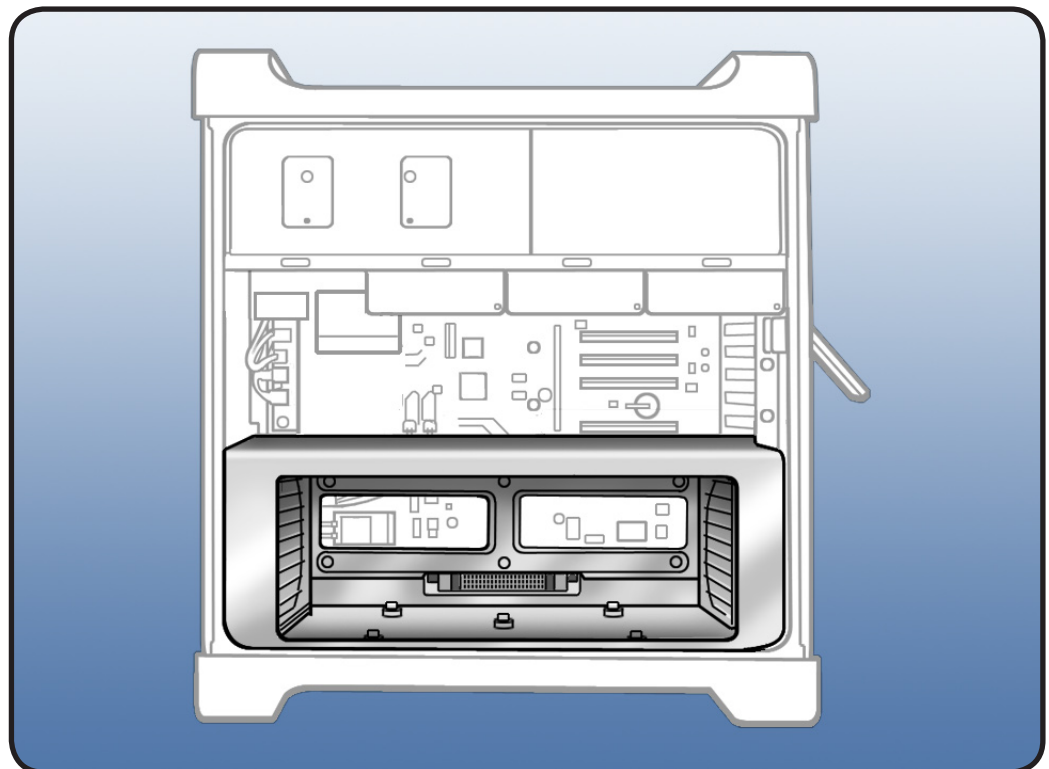

- 18 Disconnect 3 cables from logic board.
- 19 Using long-handled Phillips #1 screwdriver, loosen 6 captive screws.
- 20 Rotate computer to stand vertically. Using 2.5 mm hex driver, remove 5 mushroom-head screws.

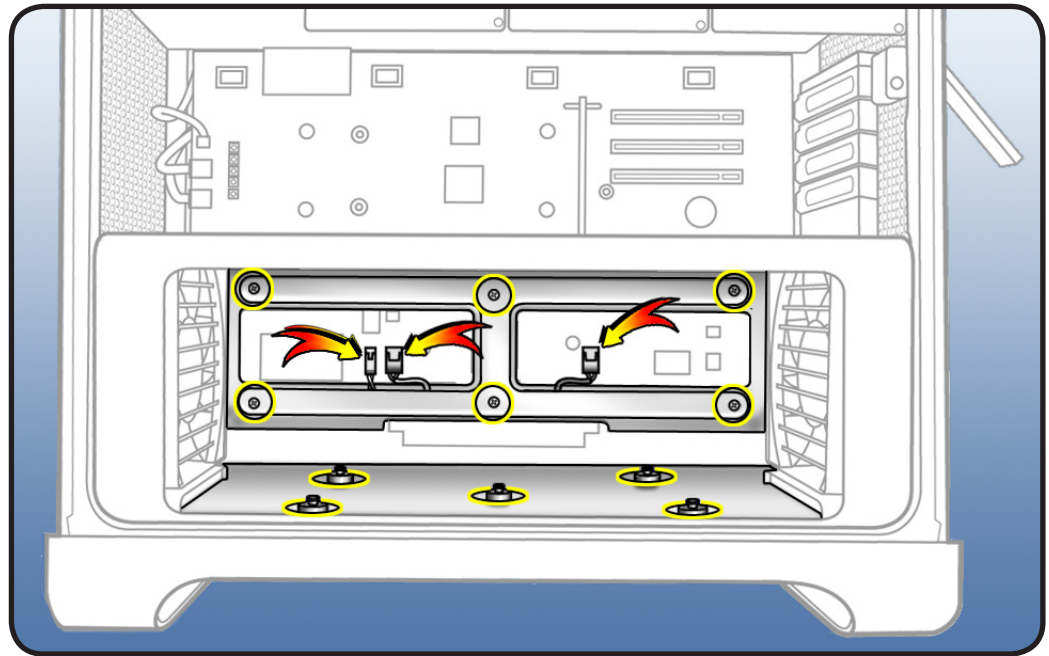

Note: Processor cage includes two fans, one at each end of cage. Before removing cage from enclosure, you must release 2 latches on each fan and push fans partway into cage.

- 21 To release 2 latches holding front fan to cage, press down on bottom of cage while using flatblade screwdriver to release latch from top of cage.
- 22 Slide fan partway into cage, so that fan clears enclosure.
- 23 Repeat steps 4 and 5 for rear fan.

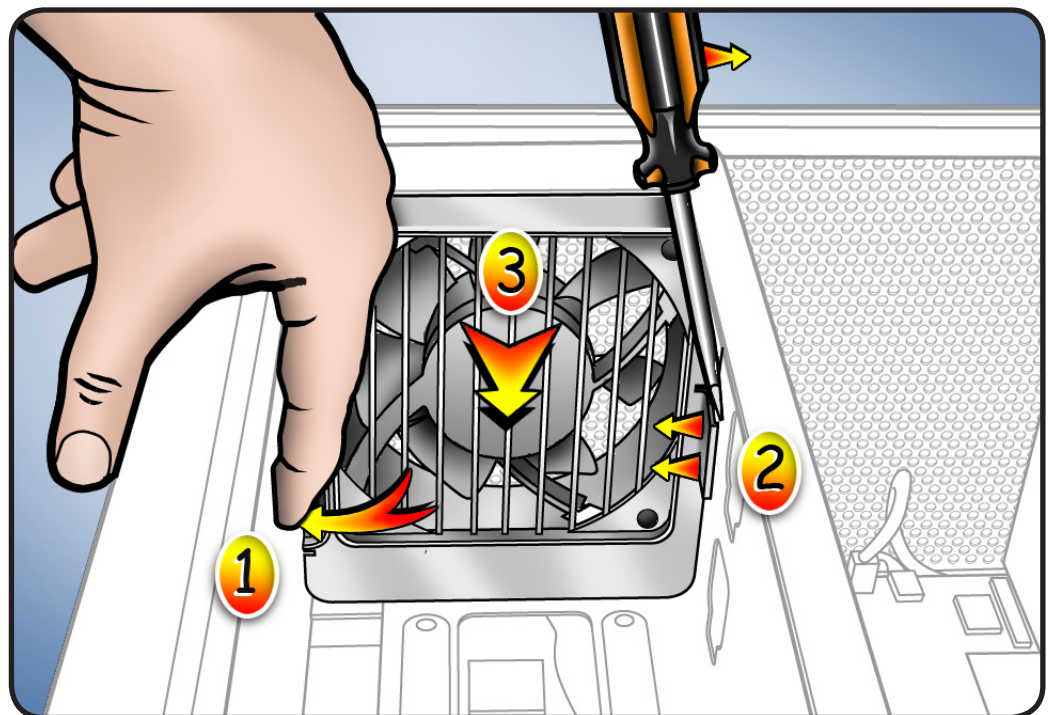

24 Lift cage out of enclosure.

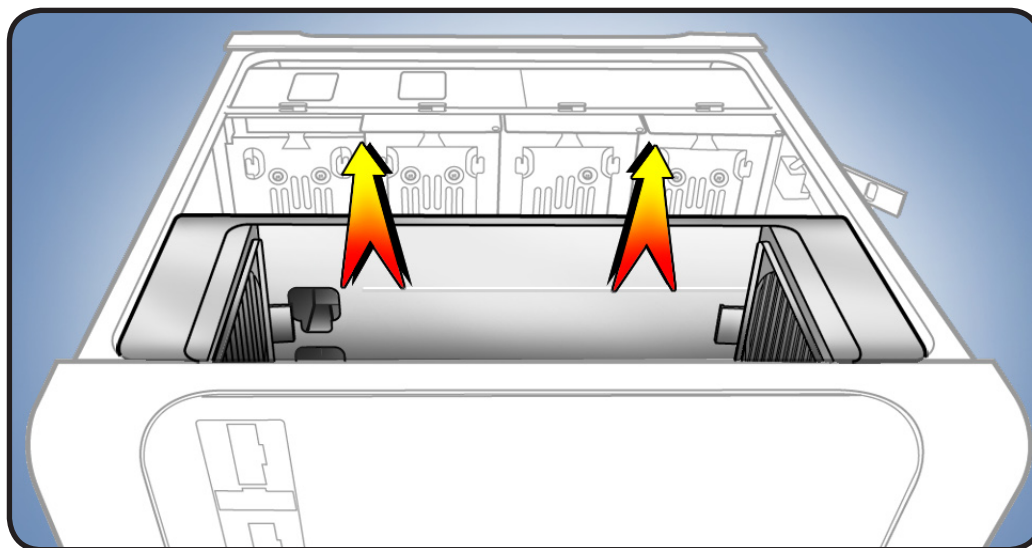

Processor Cage Fans

25 Locate processor cage fans.

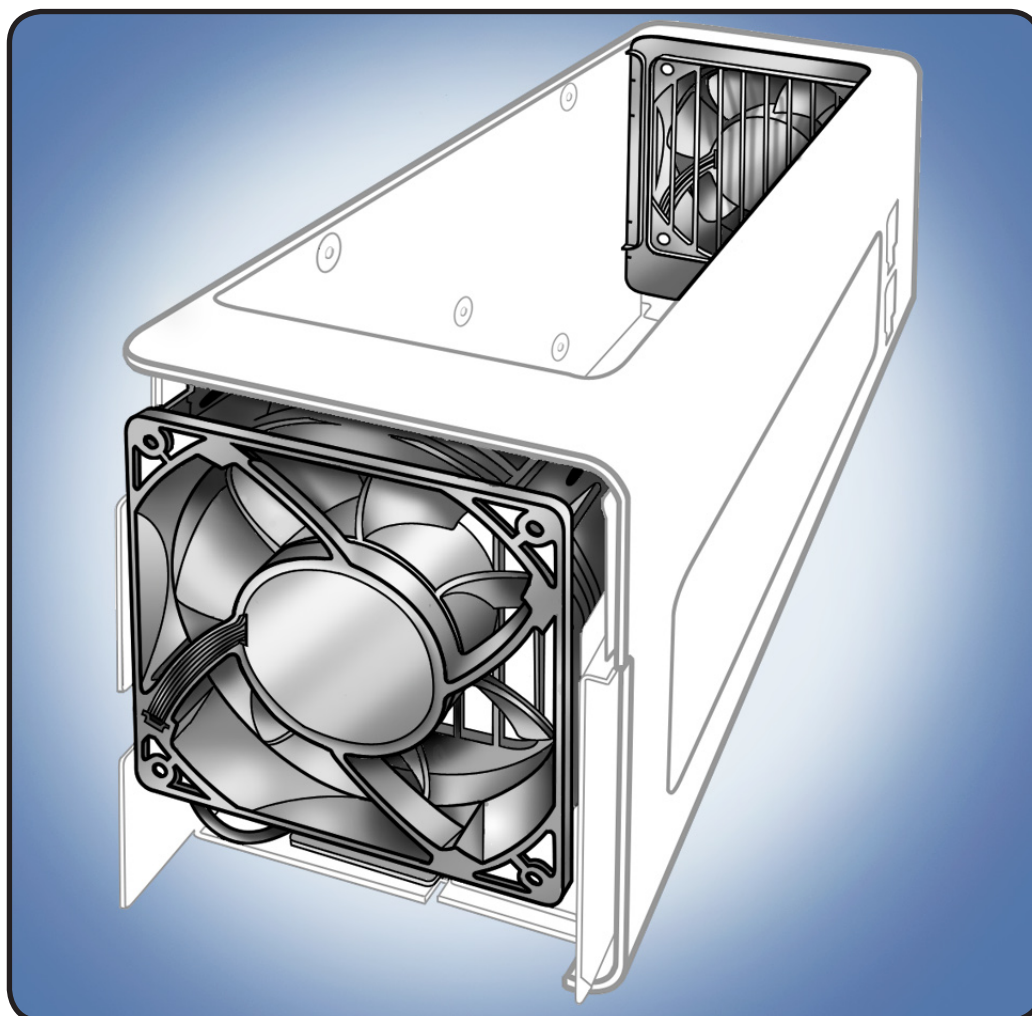

- 26** Release fan cables from clips on bottom of processor cage.

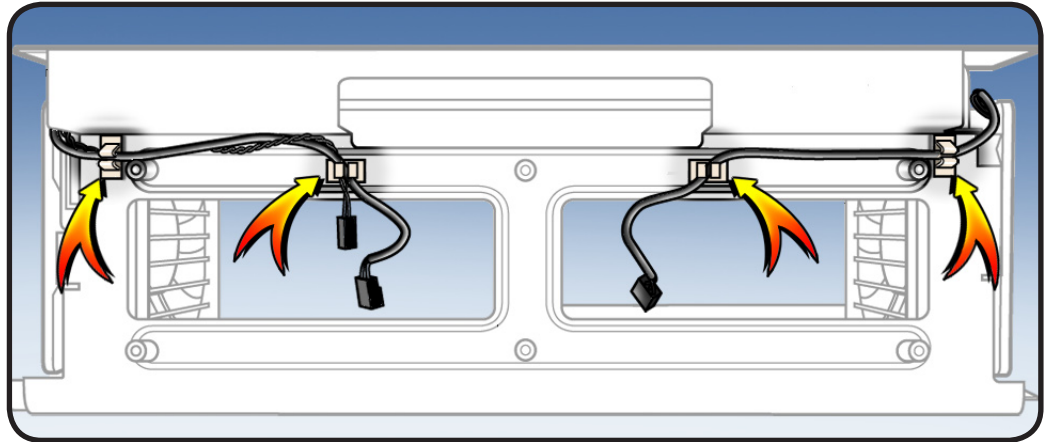

- 27** Release 4 latches on front fan and slide fan out of cage.

Note: Latch #4 is on inside of cage.

- 28** Repeat above step for rear fan.

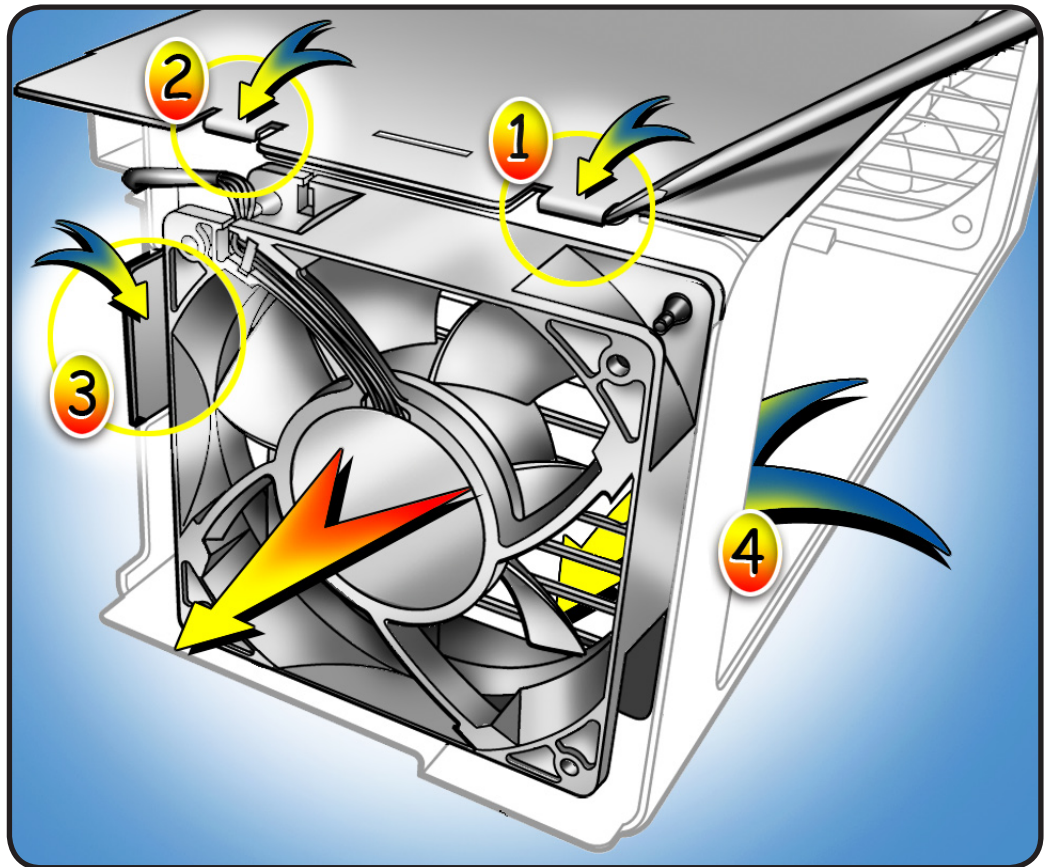

Installing the Replacement Fans

- 1 Position front fan in cage.
- 2 Slide fan back until it engages with the 4 latches.
- 3 Repeat above two steps for rear fan.

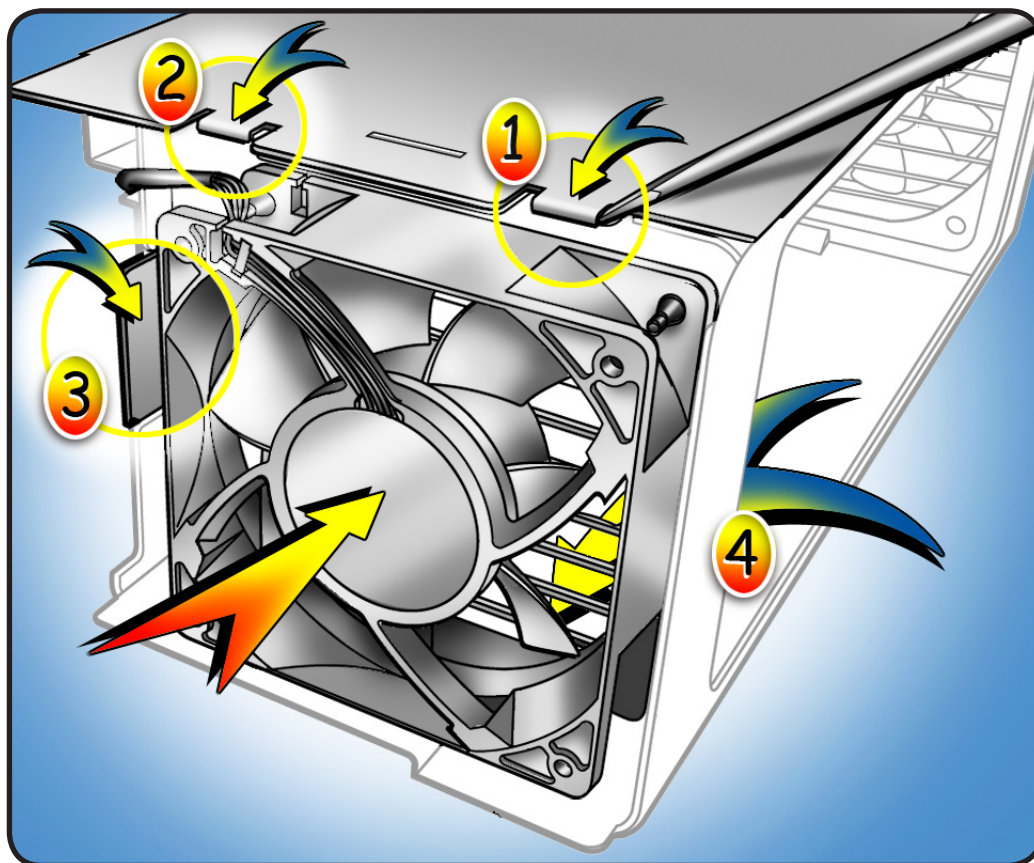

- 4 Re-insert fan cables in clips on bottom of processor cage.

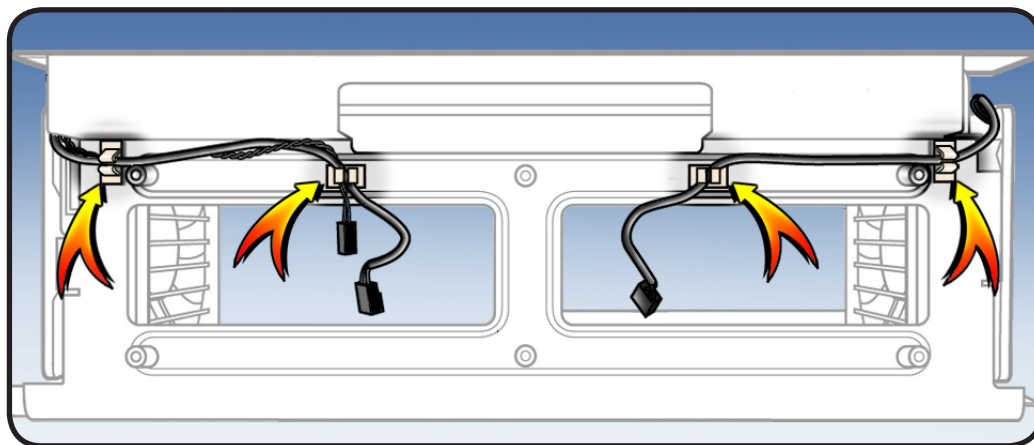

Processor Cage

Important: Before you re-install cage into enclosure, fans must be inserted partway into cage.

- 5 Position cage in enclosure.
- 6 Slide front and rear fans into place, so that they engage with latches.
- 7 Replace and tighten 5 mushroom-head screws.
- 8 Secure 6 captive screws.
- 9 Reconnect 3 cables.

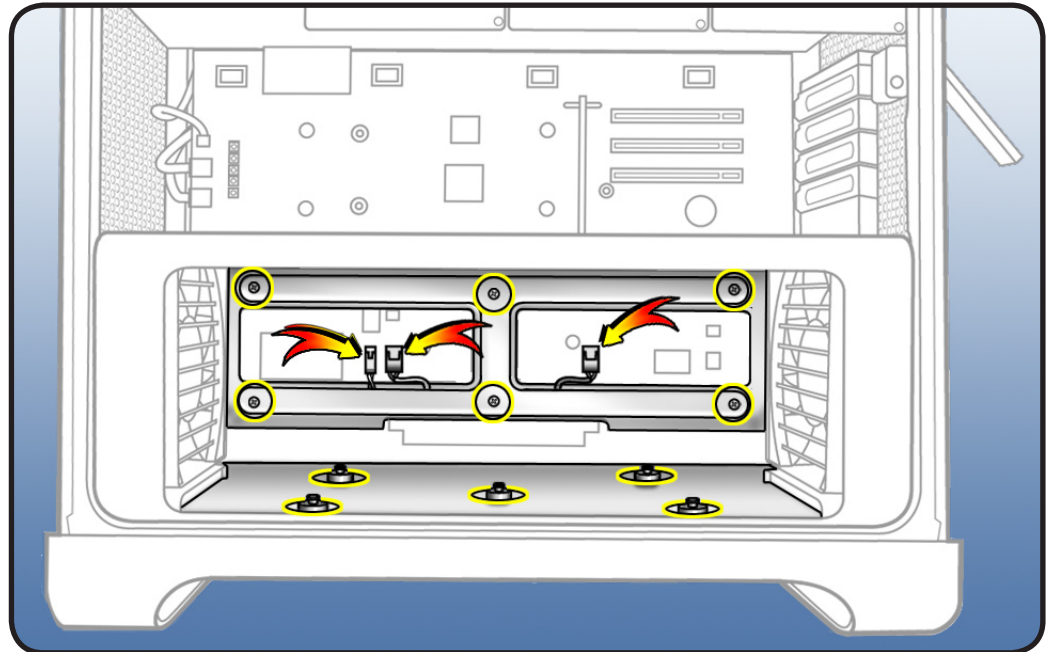

PCIe Fan

- 10 Slide fan into enclosure so that fan tabs engage with slots on metal cage.
- 11 Press down until fan clicks into place in connector.
- 12 Replace 2 screws.

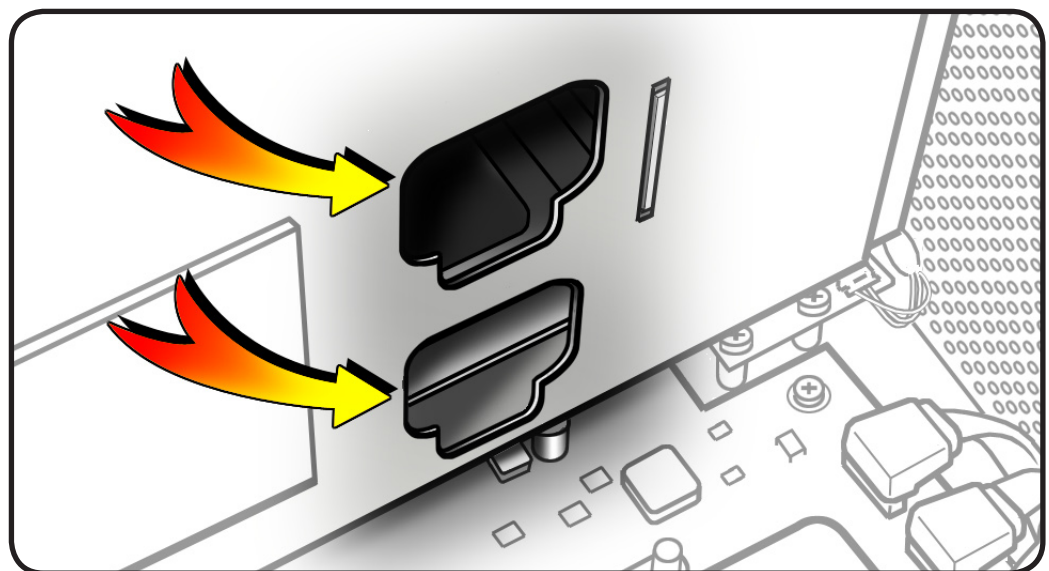

Processor Tray

- 13 Holding tray by latches, lower it into processor cage.
- 14 Make sure latches are closed flush with front of processor tray.

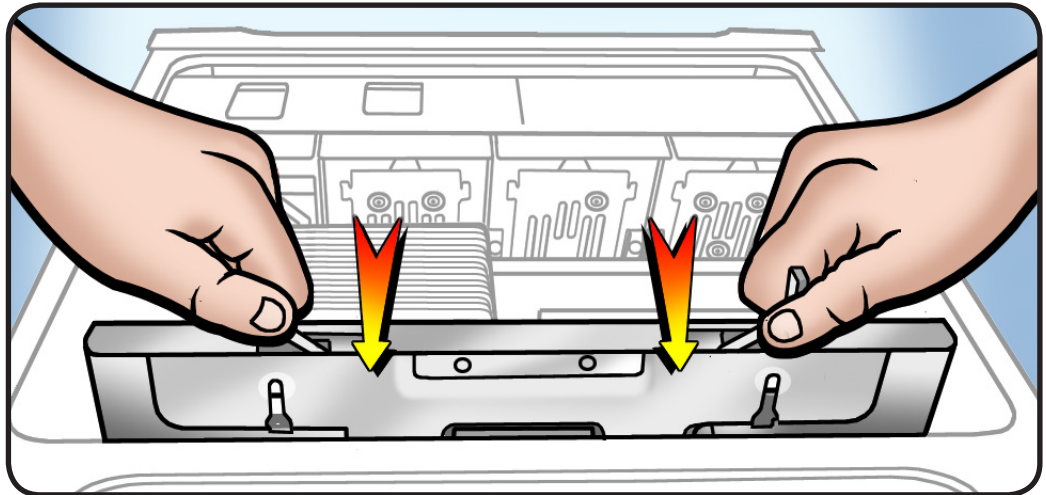

Graphics Card

- 15 Reinstall graphics card in slot 1.

Note: Align card's connector with expansion slot and press down until connector is inserted all the way into slot. If installing a 12-inch card, make sure card engages correct slot in PCIe card guide.

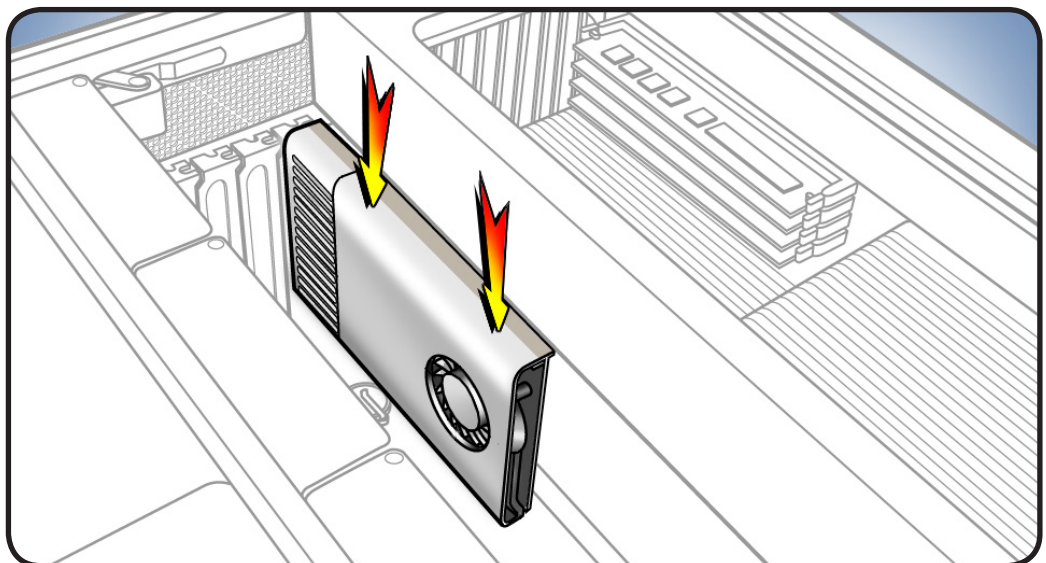

- 16 If card includes booster cables, reconnect cables.

- 17 Slide PCIe fan to the right to lock card in place.

- 18 Replace PCI bracket and tighten screws.

Note: Slide bracket under circled tab.

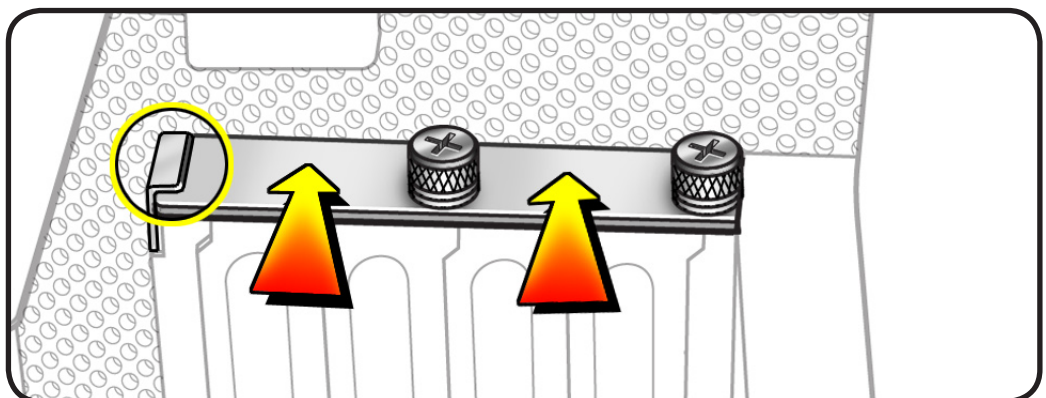

Hard Drive

- 19 Replace hard drive in far-left drive bay.

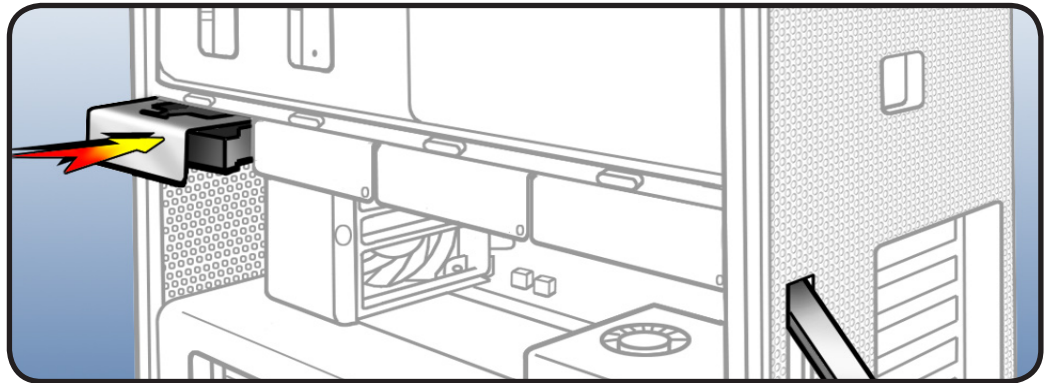

Closing the Computer

- 1 Replace access panel.

Note: Make sure latch is up before you replace panel. If latch is down, panel will not seat correctly.

- 2 Push latch down to close and secure access panel.



Warning: Never turn on computer unless all its internal and external parts are in place and it is closed. Operating computer when open or missing parts can cause damage or injury.

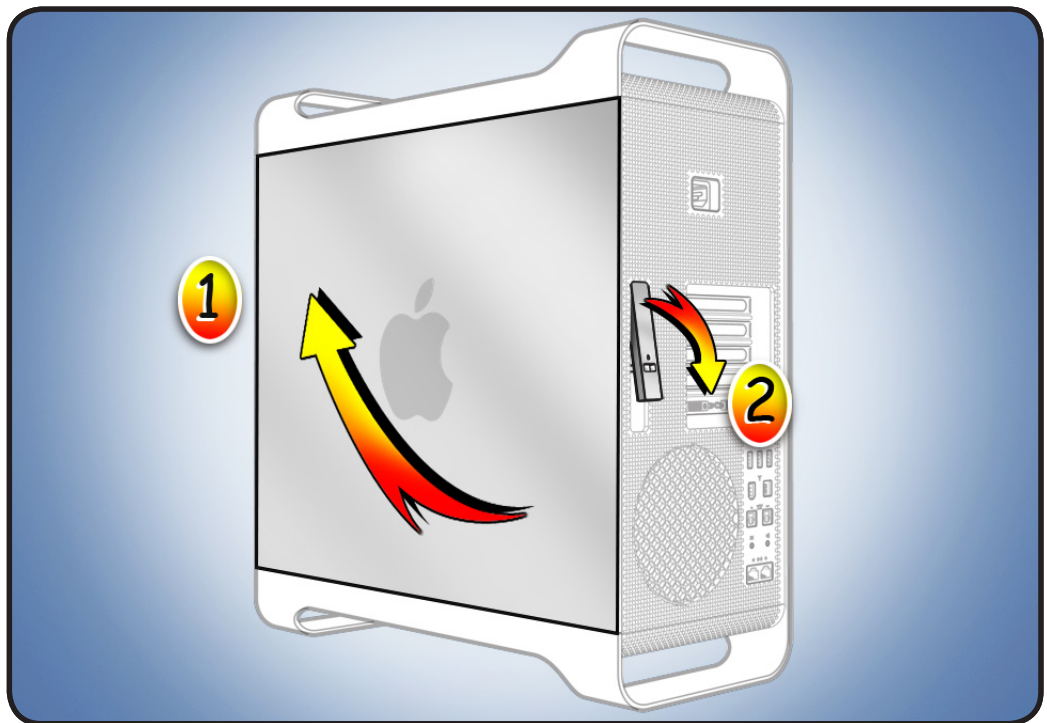

Apple Inc.

© 2009 Apple Inc. All rights reserved.

This document is protected under U.S. Copyright Law and International Treaties, and no part of this document may be reproduced in any form without written permission from Apple.

Apple is not responsible for typographical, printing, or inadvertent errors.

Apple Inc.
1 Infinite Loop
Cupertino, CA 95014-2084 USA
+ 1 408 996 1010
www.apple.com

Apple, the Apple logo, and Mac are trademarks of Apple Inc., registered in the U.S. and other countries.

Free Manuals Download Website

<http://myh66.com>

<http://usermanuals.us>

<http://www.somanuals.com>

<http://www.4manuals.cc>

<http://www.manual-lib.com>

<http://www.404manual.com>

<http://www.luxmanual.com>

<http://aubethermostatmanual.com>

Golf course search by state

<http://golfingnear.com>

Email search by domain

<http://emailbydomain.com>

Auto manuals search

<http://auto.somanuals.com>

TV manuals search

<http://tv.somanuals.com>