

**Magnum VS 50
Magnum VS 100
-48 Vdc Power Systems
User Manual**



Table of Contents

1	Introduction	6
1.1.	GENERAL INFORMATION	6
2	Installation	9
2.1.	UNPACKING EQUIPMENT	9
2.2.	MECHANICAL INSTALLATION	9
	<i>Room / Location</i>	9
	<i>Mounting</i>	9
	<i>Ventilation</i>	9
2.3.	AC POWER CONNECTIONS	10
	<i>AC Connections</i>	10
	<i>AC Power Cord Sets</i>	11
2.4.	BATTERY CONNECTIONS	12
	<i>Planning the Battery installation</i>	12
	<i>Connecting the Cables</i>	12
	<i>Battery Temperature Probe Installation</i>	13
2.5.	COUNTER ELECTRO-MOTIVE FORCE (CEMF) CELL CONNECTIONS	13
2.6.	DC SYSTEM GROUNDING	14
2.7.	LOAD PROTECTION INSTALLATION	15
	<i>Circuit Breaker Installation</i>	15
	<i>GMT Fuse Installation</i>	15
2.8.	LOAD CONNECTIONS	15
	<i>Cable Size Considerations</i>	15
	<i>Circuit Breaker Protected Load Connections (30 or 60 A)</i>	16
	<i>GMT Fuse-protected Load Connections</i>	16
2.9.	MONITORING AND RELAY OUTPUT CONNECTIONS	17
	<i>Front Panel DB9 Connection</i>	17
	<i>RJ45 Ethernet Connector</i>	17
	<i>Major, Minor and Relay 1 Output Connections</i>	17
	<i>Output Relay 2-6 Connections</i>	18
	<i>External Alarm Input Connections</i>	19
2.10.	RECTIFIER MODULE INSTALLATION	20
2.11.	CONTROLLER MODULE INSTALLATION	20
3	Commissioning	21
3.1.	PRE-COMMISSIONING INSPECTION	21
	<i>Environment</i>	21
	<i>Electrical Installation</i>	21
	<i>Battery Visual and Safety Inspection</i>	21
3.2.	COMMISSIONING	22
	<i>Initial Set-up</i>	22
	<i>AC Power Up</i>	22
	<i>DC Power Up:</i>	22
	<i>Rectifier Test:</i>	23
	<i>Battery Power Up</i>	23
	<i>LVD Test</i>	23
	<i>Circuit Breaker/ Fuse Test:</i>	23
	<i>User Inputs</i>	23
	<i>Output Relay 1:</i>	24
	<i>Battery Temperature Compensation</i>	24
3.3.	FINAL INSPECTION:	24
4	Technical Description	25
4.1.	RECTIFIER MANAGEMENT	25
	<i>AC Input Power</i>	25
	<i>DC Output Power</i>	25
	<i>Rectifier alarms reporting</i>	25
4.2.	SYSTEM MANAGEMENT	25
	<i>System Voltage Monitor and Control</i>	25

MAGNUM VS CONTROLLER	50
8.4. MECHANICAL	51
<i>TWF0500H54B Rectifier</i>	51
<i>Magnum VS 50 Power System</i>	51
<i>Magnum VS 100 Power System</i>	51
8.5. ENVIRONMENTAL	51
8.6. COMPLIANCE	52
8.7. COMPLIANCE	52
8.8. COMPLIANCE	52
9 APC Worldwide Customer Support	53
10 Limited Product Warranty	54
TWO YEAR FACTORY WARRANTY	54
10.1.....	54

Table of Figures

FIGURE 1.1-1 MAGNUM VS 50 –48 VDC POWER PLANT	6
FIGURE 1.1-2 MAGNUM VS BLOCK DIAGRAM.....	8
FIGURE 2.3-1 MAGNUM VS 50 BACKPLANE.....	10
FIGURE 2.3-2 AC INPUT WIRING	10
FIGURE 2.4-1 BATTERY CABLE CONNECTION LOCATIONS	13
FIGURE 2.4-2 BATTERY TEMPERATURE PROBE INSTALLATION	13
FIGURE 2.5-1 CEMF CONNECTION LOCATIONS.....	14
FIGURE 2.7-1 GMT FUSE TEMPERATURE DE-RATING CHART.....	15
FIGURE 2.8-1 CONNECTIONS TO CIRCUIT BREAKERS.....	16
FIGURE 2.8-2 TOP SHELF GMT FUSE CONNECTIONS.....	16
FIGURE 2.8-3 BOTTOM SHELF GMT FUSE CONNECTIONS.....	17
FIGURE 2.9-1 INTERFACE CONNECTIONS	18
FIGURE 2.9-2 OUTPUT RELAY CONNECTIONS	19
FIGURE 2.9-3 EXTERNAL USER INPUT CONNECTIONS	19
FIGURE 5.2-1 CONTROLLER CARD JUMPER LOCATIONS.....	31
FIGURE 0-1 MAGNUM VS CONTROLLER	32
FIGURE 5.5-1 PARAMETER LOCATIONS, DESCRIPTIONS, AND SETTINGS	34

Entire contents copyright 2007 American Power Conversion. All rights reserved. Reproduction in whole or in part without permission is prohibited.

APC and the APC logo are trademarks of American Power Conversion Corporation. All other trademarks, product names, and corporate names are the property of their respective owners and are used for informational purposes only.

1.1. General Information

The APC Magnum VS is a modular -48 Vdc power plant. The Magnum VS has unique features that make it easy to install, maintain, and upgrade. There are two Magnum VS models; Magnum VS 50 and 100. The Magnum VS 50 is a single shelf system and can support up to 5, 10A rectifiers, for a rated current of 50A. The Magnum VS 100 is a dual shelf system and can support up to 10, 10A rectifiers, for a rated current of 100A. The rectifier units are modular and “hot-swappable” making it easy to add or remove rectifiers as dictated by capacity requirements, without having to change the input or output wiring.

There are two basic DC output distribution options, circuit breakers (30A or 60A) or GMT-style fuses. The DC output distribution module also includes terminals to connect a battery string and a low voltage disconnect (LVD) device to disconnect the batteries after a deep discharge.

The system controller module provides monitoring and control functions for each component of the system, and stores alarm events for system diagnosis and maintenance. The system controller module enables the user to change/update Magnum VS settings, as well as monitor the system via a local computer directly connected to the Magnum VS system (using the serial cable provided by APC (please note that a standard serial cable cannot be used; the APC-provided serial cable must be used to connect directly to the Magnum VS system)), or a remote computer connected to the system over a network using a 10/100 Base-T Ethernet connection.

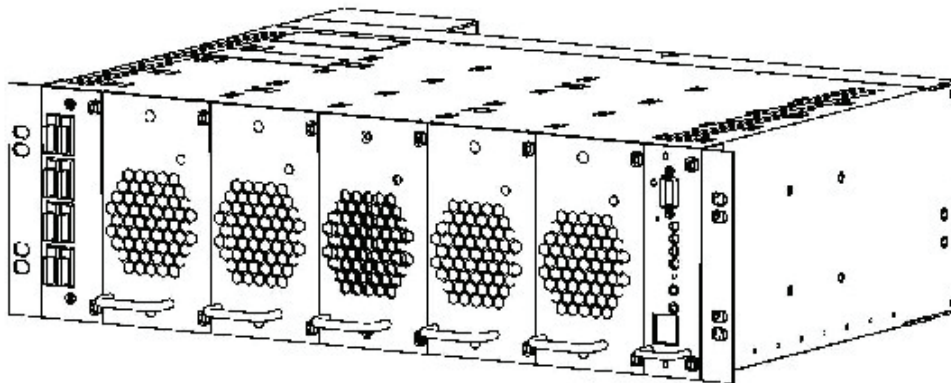

Figure 1.1-1 Magnum VS 50 –48 Vdc Power Plant

A fully equipped Magnum VS 50 power system is shown in Figure 1.1-1.

Magnum VS system and accessory SKUs are listed below:

SKU	Description
DCM00K03SGMT	Magnum VS 50, Basic Controller and Integrated Network Management Card (NMC), One (1) 1TWF0500H54B 10 A Rectifier, and One (1) GMT Distribution Module (8 Fuse Positions)
DCM00K03S2X30	Magnum VS 50, Basic Controller and Integrated Network Management Card (NMC), One (1) 1TWF0500H54B 10 A Rectifier, and One (1) Circuit Breaker (CB) Distribution Module (2–30 A Circuit Breakers)
DCM00K03S1X60	Magnum VS 50, Basic Controller and Integrated Network Management Card (NMC), One (1) 1TWF0500H54B 10 A Rectifier, and One (1) CB Distribution Module (1–60A Circuit Breaker)
DCM00K06SGMT	Magnum VS 100, Basic Controller and Integrated Network Management Card (NMC), One (1) 1TWF0500H54B 10 A Rectifier, and Two (2) GMT Distribution Modules (8 Fuse Positions (Each))
DCM00K06S4X30	Magnum VS 100, Basic Controller and Integrated Network Management Card (NMC), One (1) 1TWF0500H54B 10 A Rectifier, and Two (2) CB Distribution Modules (2–30 A Circuit Breakers (Each))
DCM00K03S2X60	Magnum VS 100, Basic Controller and Integrated Network Management Card (NMC), One (1) 1TWF0500H54B 10 A Rectifier, and Two (2) CB Distribution Modules (1–60 A Circuit Breaker (Each))
Accessories	
1TWF0500H54B	Magnum VS 10A Rectifier
DCMOPTCS1	AC Input Cable Kit; Includes Two (2) 12ft, 10 AWG, L6-30P Power Cords
DCMOPT23RM	Magnum VS 50/100 Mounting Bracket Kit; For 23” Racks/Frames
DCMOPTBATE	EMEA Battery Kit: 2U 19” Battery Disconnect Module with Four (4) 100 A Disconnect Breakers and Battery Cable Kit
DCMOPTBATN	North America Battery Kit: 19”-Frame Battery Tray, Circuit Breaker Kit, Battery Termination Bus Assembly, and Battery Cable Kit.
DCBT005	DC System Battery Module: -48V Battery String (Power Battery CSL-12100) with Hardware Kit

TOP SHELF

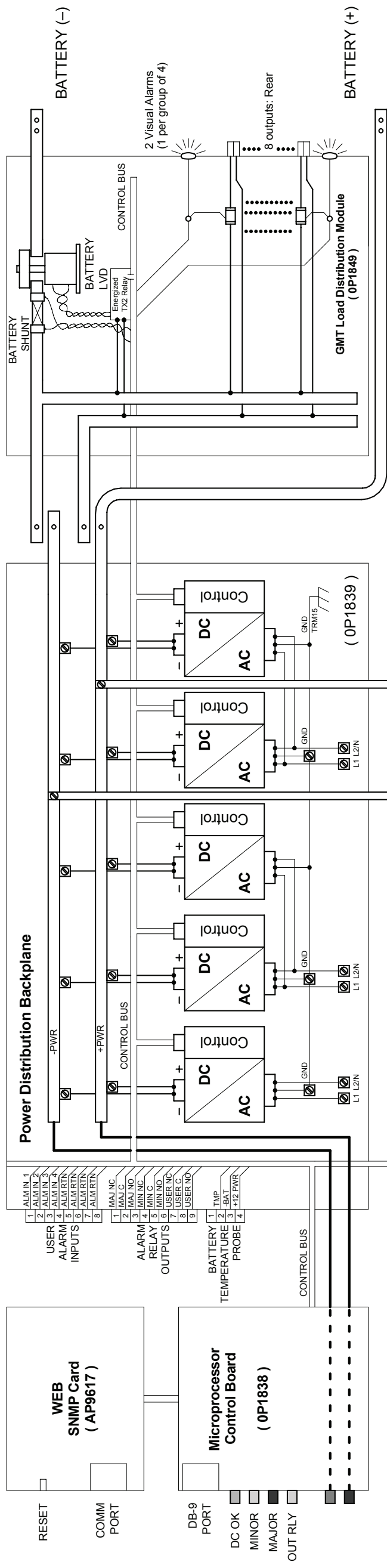

Bus Bars

SIGNALS CABLE

BOTTOM SHELF

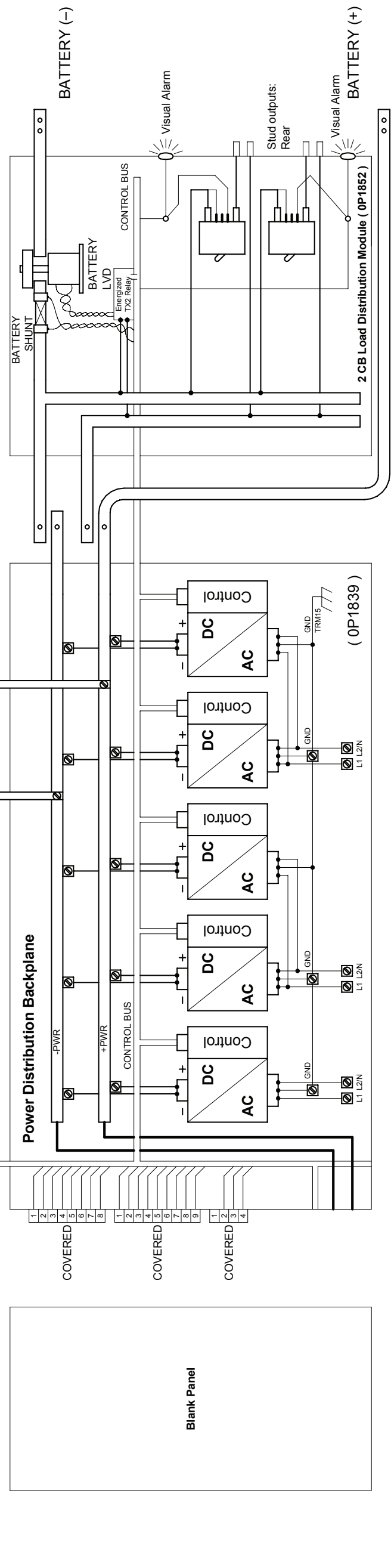

100 Amp System Only

Figure 1.1-2 Magnum VS BLOCK DIAGRAM

2.1. Unpacking Equipment

Remove equipment from packing material and inspect for shipping damage or missing items. It is important to report damage or material shortages to the shipping carrier while a representative is on site.

If concealed damage or material shortages are found at a later time, contact the shipper to make arrangements for inspection and claim filing. Refer to **Section** Error! Reference source not found. in the event it is necessary to return equipment to APC.



CAUTION: Appropriate lifting techniques and safety equipment should be used to remove equipment from packing.



RECYCLE: The shipping materials can be recycled. Save them for later use or dispose properly.

2.2. Mechanical Installation

Room / Location

NOTE: The APC dc power plant is to be installed in a room, vault, or similar enclosure accessible only to qualified persons in accordance with the national and local electrical codes.

Prior to installation, drawings, floor loading requirements, external alarm points, ac service entrance, and grounding schemes should all be checked and confirmed. If batteries are to be mounted in a room separate from the power plant, careful attention should be paid to battery cable voltage drop effects. Environmental operating temperatures and ventilation/cooling considerations should also be noted, not just for the power system but also for all other equipment that may reside in the power room area.

Mounting

The Magnum VS 50 and 100 include brackets to mount the system in a standard EIA 19" rack. Install the power system using hardware designed for the rack. To install a Magnum VS 50 or 100 in a 23-inch rack use the 23" Mounting Bracket Kit (DCMOPT23RM).

Ventilation

The rectifier modules for this system have fans that provide front-to-rear airflow for internal cooling. The power system housing should be mounted such that there is free airflow to the front and back of the unit. [Refer to **Section 8.5** for environmental characteristics.] Free airflow should be ensured so that the power system can provide full power without de-rating.

2.3. AC Power Connections



WARNING: Ensure that all of the external dc and ac circuit breakers are in the OFF position prior to connecting service to the power plant. Confirm that all voltages have been removed including any battery sources before proceeding.

AC Connections

The Magnum VS DC power system, specifically each rectifier, requires a single phase input AC supply (Range: 85–264 VAC, 47–63 Hz) to operate. Each Magnum VS shelf has three (3) sets of input terminals (TRM 2, 5, 8; TRM 3, 6, 9; and TRM 4, 7, 10). As a result, each Magnum VS shelf can be wired such that three (3) different AC sources (e.g., three phase, delta or star, connections) provide power to the rectifiers (see Figure 3.3-2), or, a single AC source is used to provide power to the rectifiers, and jumper cables are used to interconnect the different input terminals (as appropriate, and provided the input wiring is not overloaded; see Figure 3.3-1).

The Magnum VS 50 SKUs are shipped configured (including the appropriate jumper cables) for operation from a single AC source.

The Magnum VS 100 SKUs are shipped configured (including the appropriate jumper cables) for operation from two AC sources (one for each shelf).

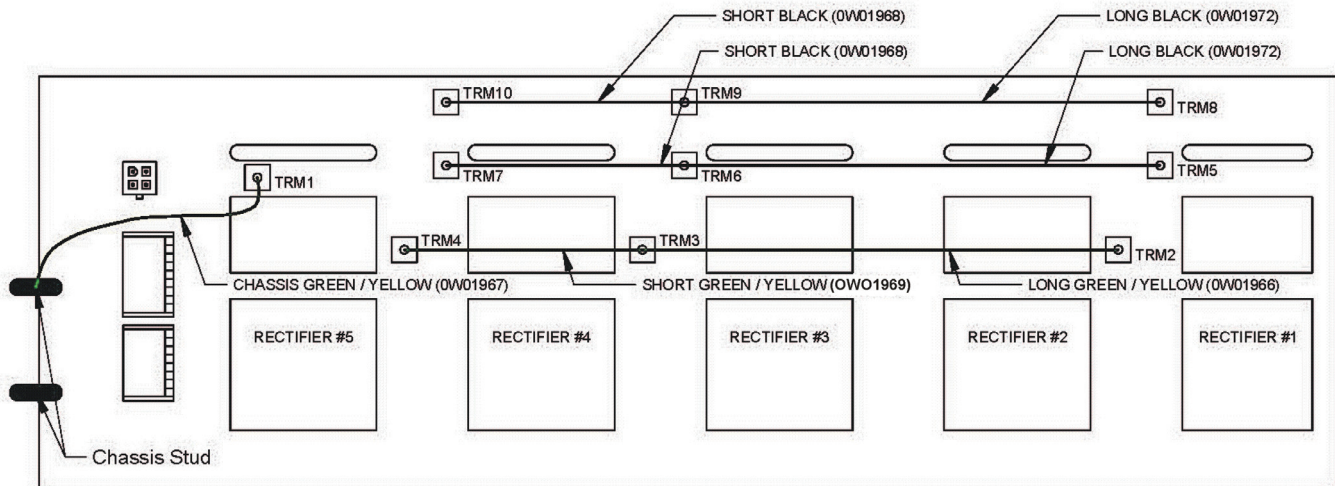
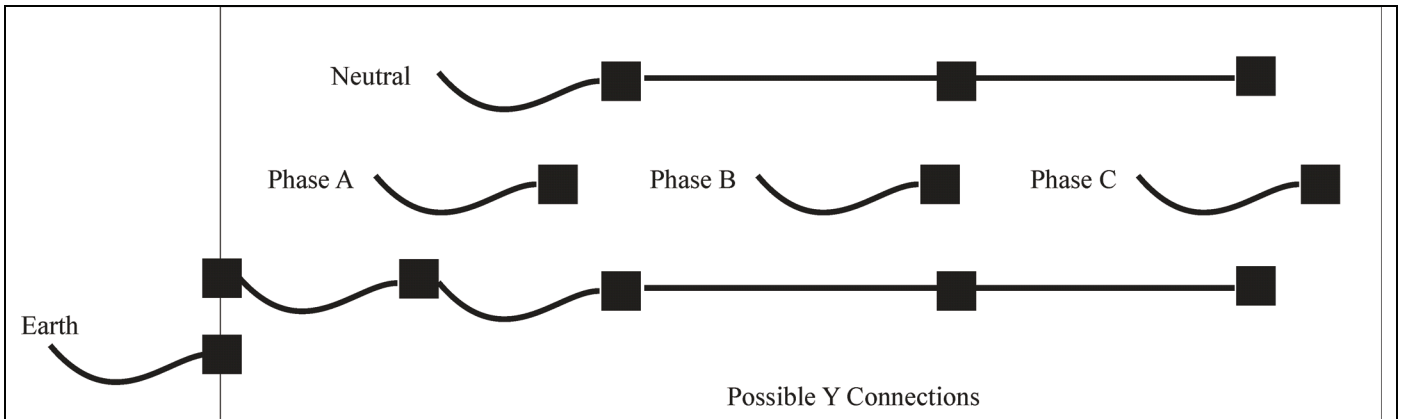

Figure 2.3-1 Magnum VS 50 Backplane

If a single AC source is used it is typically connected to TRM 10 (Line), 7 (Neutral) and 4 (Ground).

Rectifier	Terminal #	Function	Terminal #	Function	Terminal #	Function
Rectifier 1	TRM2	Ground	TRM5	Line or Neutral	TRM8	Line
Rectifier 2 & 3	TRM3	Ground	TRM6	Line or Neutral	TRM9	Line
Rectifier 4 & 5	TRM4	Ground	TRM7	Line or Neutral	TRM10	Line
Chassis	TRM1	Ground				

Figure 2.3-2 AC Input Wiring



Each phase should be wired for a minimum of 15 A.

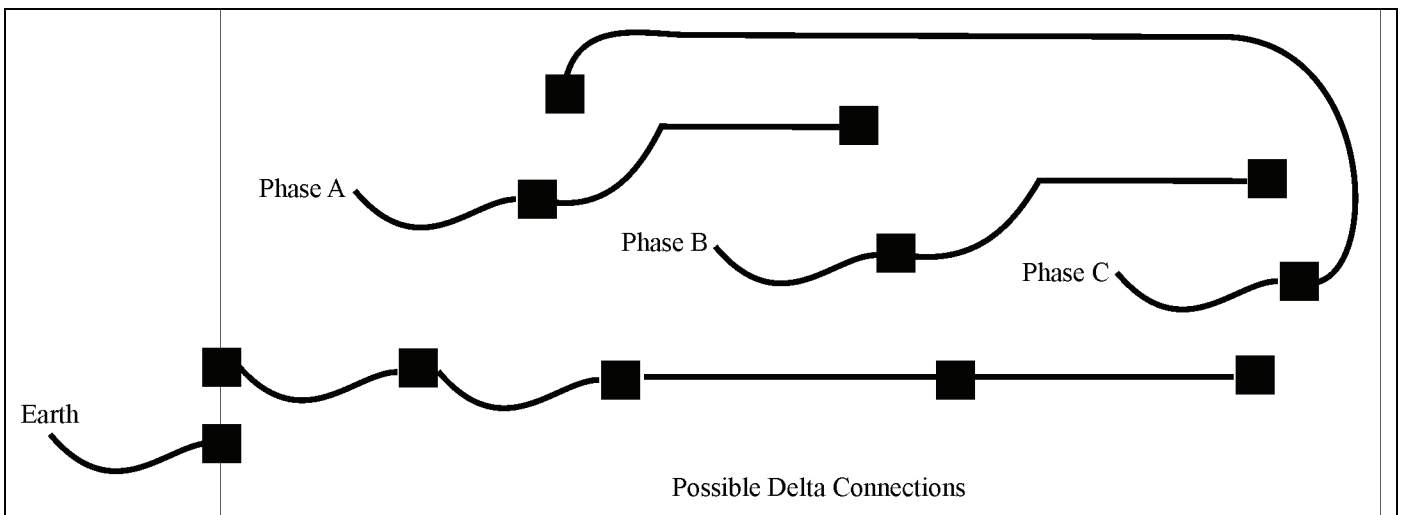

The rear cover of each Magnum VS shelf in the power system has two 1.125-inch (2.858 cm) diameter holes for electrical conduit. Conduit can be run to each Magnum VS shelf, or, alternatively, strain relief is provided for the direct installation of AC power cables. Please note that the ambient temperature and the number of wires in a conduit must be considered in accordance with national and local wiring code requirements (e.g., NEC).

AC Power Cord Sets

The AC power cord sets are not included with the Magnum VS DC System, and must be purchased separately, or provided by the Licensed Electrician installing the system.

APC offers a standard AC input cable kit that includes two (2), 12 foot, 10 AWG, L6-30P power cords (SKU: DCMOPTCS1).

	<p>WARNING: Hazardous ac voltage levels are present inside the power system. Keep the rear cover in place when the system is operational or energized.</p>
---	---

2.4. Battery Connections



WARNING: Hazardous energy levels are present on bare conductors in the DC distribution connection area of the plant. Accidental shorting of distribution conductors can cause arcing and high currents that can cause serious burns or other physical harm. **It is recommended to:**

Remove any jewelry, rings, or watches while working on this equipment.

- Use insulated wrenches, screwdrivers, cutters, pliers and other tools.



WARNING: Rectifier output DC circuits will be damaged if the batteries are installed incorrectly. Ensure proper battery polarity and that the battery is isolated from the rest of the system.

Planning the Battery installation

The battery cable(s) should be sized to limit the voltage drop from the dc power plant to the battery during charging per system design requirements. The cable(s) must also carry the full load current during battery operation. If assistance is required to determine the necessary cables for the application, contact your sales representative or APC (**Refer to Section Error! Reference source not found. for APC Customer Support information**). A fuse or circuit breaker (various options are available from APC) is recommended in the negative line to protect the cables from the battery to the DC power plant. If a circuit breaker is used, the power plant can monitor auxiliary contacts from this breaker.

Connecting the Cables



WARNING: Make certain that the battery polarity is correct when making connections to the DC power plant. Incorrect connections can cause severe equipment damage.

The battery cable connections are located at the rear of the unit as shown in Figure 2.4-1. The battery positive and battery negative buses each provide a pair of #10-32 studs on 5/8" centers for connecting two-hole battery cable lugs. A ring size of 6 mm may also be used. Connect the battery cables as applicable using #10-32 nuts. Cover connections with heat shrink after assembly.

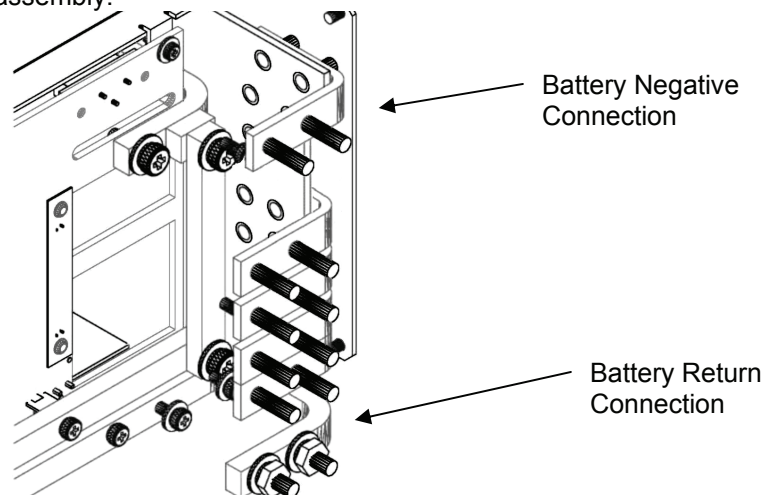

Figure 2.4-1 Battery Cable Connection Locations

Battery Temperature Probe Installation

The temperature probe is used to monitor the battery string temperature. To get the most representative temperature measurement, the probe should be placed in contact with a battery cell that is centrally located. The probe should be placed directly in contact with the cell (not the frame surrounding the cell). Generally, the cell cover can be used; be careful not to allow the probe body to touch the terminals. Plug the connector end of the temperature probe into J410 of the backplane card. Route the cable as required positioning the probe on the selected battery cell. Remove the adhesive protection strip from the probe body and press the adhesive side of the probe on the battery cell cover. Refer to Figure 2.4-2 for details.

Note: Program Hardware Battery Temperature Alarm to “Ignore” if no battery temperature probe is connected to J410.

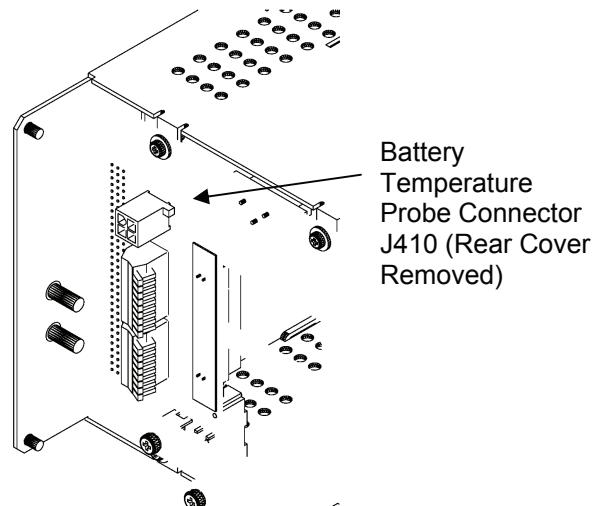

Figure 2.4-2 Battery Temperature Probe Installation

2.5. Counter Electro-Motive Force (CEMF) Cell Connections



WARNING: Hazardous energy levels are present on the CEMF connection area of the plant. Accidental shorting of conductors can cause arcing and high currents that can cause serious burns or other physical harm.

In some applications, a CEMF cell is used to lower the dc voltage delivered to the loads. The CEMF cell is mounted externally to the Magnum VS. The CEMF connections are located at the rear of the unit as shown in Figure 2.5-1. Two bus-plates, installed at the factory, bypass the CEMF connection. If a CEMF cell will be used, remove the bus plate connecting the two CEMF connection points and install two connection buses before installing the CEMF. The CEMF connection buses each provide a pair of #10-32 studs on 5/8" centers for connecting two-hole CEMF cable lugs. A ring size of 6 mm may also be used. Connect the CEMF cables as applicable using #10-32 nuts.

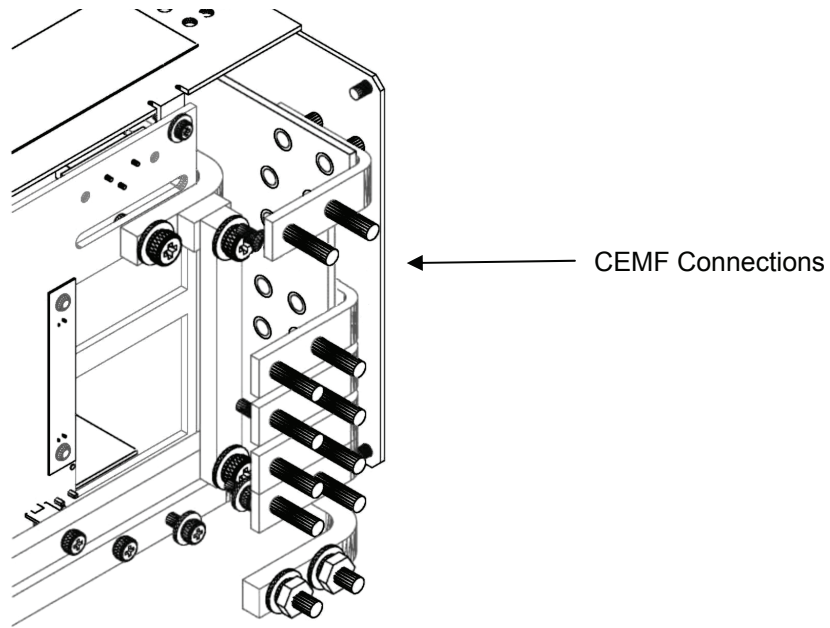

Figure 2.5-1 CEMF Connection Locations

2.6. DC System Grounding

The positive bus for the power plant should be connected to the Central Office Ground. The Battery Return **provides** a pair of #10-32 studs on 5/8-inch centers for connection of a two-hole lugged cable to the Central Office Ground. A ring size of 6 mm may also be used. Cover this connection with heat shrink tubing after assembly.

2.7. Load Protection Installation

Circuit Breaker Installation

Standard circuit breaker output distribution modules are available with two 30-A breakers or one 60-A breaker. Output distribution modules are installed at the factory and are typically not field replaceable units. Contact APC if the output configuration is not suitable for your needs. Other breaker sizes are not readily available.

GMT Fuse Installation

The standard GMT output distribution module includes eight (8) fuse positions and is installed on the left side of the Magnum VS shelf. The GMT fuse holders are located on the front panel of the unit. Insert the fuses into the holder; observing the tripped indicator is correctly oriented. Use the chart shown in **Figure 2.7-1** to help determine what size fuses will carry the desired current. When using several of the larger GMT fuses in one shelf, better heat dissipation will be achieved if the fuses are spaced out evenly within the output panel. The following GMT-type fuses are provided by APC with the DCM00K03SGMT or DCM00K06SGMT Magnum VS systems: 1A, 3A, 5A, 7.5A, and 10A.

		AMBIENT TEMPERATURE		
		20° C	50° C	60° C
FUSE SIZE	7.5 A	5 A	4.5 A	4 A
	10 A	7 A	6 A	5 A
	15 A	10 A	9 A	8 A

Figure 2.7-1 GMT Fuse Temperature De-rating Chart

2.8. Load Connections

Cable Size Considerations

The DC load cable(s) should be sized to limit the voltage drop from the dc power plant to the loads per system design requirements. The cable(s) must also carry the full load current during battery operation. During battery operation the voltage will be lower and for constant power loads, the current will typically be higher. If assistance is required to determine the necessary cables for the application, contact your sales representative or APC.

Circuit Breaker Protected Load Connections (30 or 60 A)

The circuit breaker lug landing connection provides a pair of #10-32 studs on 5/8" centers for mounting two-hole lugs. A ring size of 6 mm may also be used. A right angle bus bar with two studs is provided to land the lugs. Load Connections should be made as shown in. Cover connections with heat shrink after assembly.

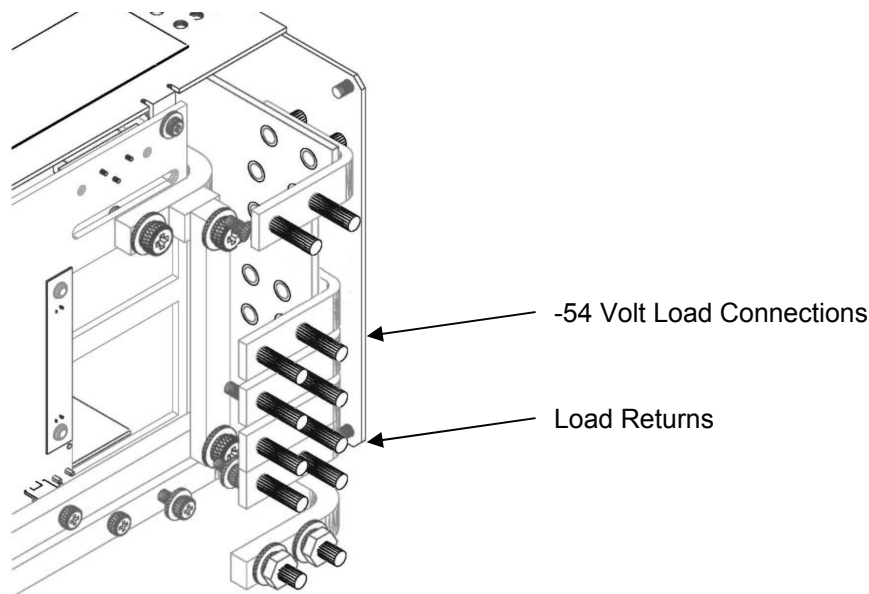

Figure 2.8-1 Connections to Circuit Breakers

GMT Fuse-protected Load Connections

Connections for 1A to 14A loads require a ring terminal with a 0.170 in (4.3 mm) clearance hole and are located at the rear of the unit. Load connections should be made as shown in Figure 2.8-2 and Figure 2.8-3.

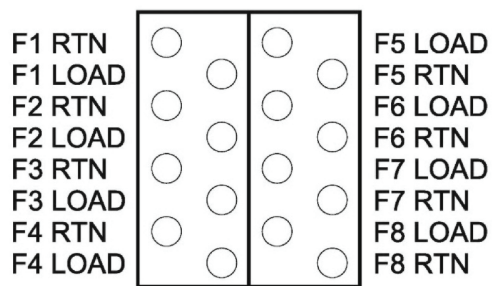

Figure 2.8-2 Top Shelf GMT Fuse Connections

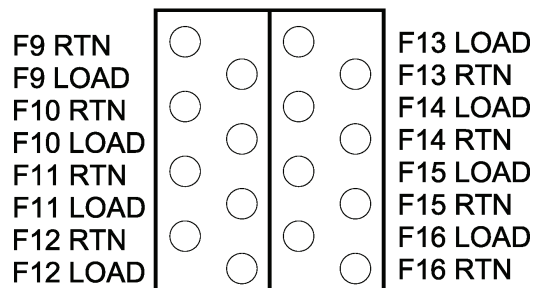

Figure 2.8-3 Bottom Shelf GMT Fuse Connections

2.9. Monitoring and Relay Output Connections

Front Panel DB9 Connection

The front panel DB-9 connector is used to hook up a standard RS-232 cable (such as APC part number 0129-XX. A 0129-6 is included with this manual.). This will allow local access through a Terminal Emulation program such as HyperTerminal™ or ProComm.™

RJ45 Ethernet Connector

The management card has an RJ-45 connector to support a TCP/IP protocol over a 10/100 BaseT Ethernet Local Area Network (LAN).

Major, Minor and Relay 1 Output Connections

There are three output relays available that provide outputs via Form "C" contacts. The output relays are named Minor, Major and Out Relay 1. Various system alarm conditions can be assigned to any of these three output relays. Most alarm conditions are shipped programmed to Minor or Major Relay. Wago connectors are located on the backplane card mounted in the left rear of the unit. Refer to the board layout in Figure 2.9-1 for Output Relay connections. The Wago connectors accept wires 26 AWG to 20 AWG (0.129 mm² to 0.518 mm²). To connect the relay output, remove ¼ in (6 mm) of insulation from the end of the wire. Push down the white tab on the Wago connector, insert the stripped wire and release the tab to make the connection. The relay contacts should only be used to switch resistive loads of 0.5 A or less at 60 V or less. Figure 2.9-2 shows the alarm output connection designations. Whenever possible use the common and normally closed contacts. If the alarm wiring gets pulled loose, or the controller is removed, you will get an alarm. The Major relay is energized (C-NO contacts closed) during normal (non-alarm) operating conditions; the other relays energize when an alarm condition occurs. If your Major relay wiring uses the C-NO contacts, then a major relay output will be seen whenever the controller is removed from the shelf.

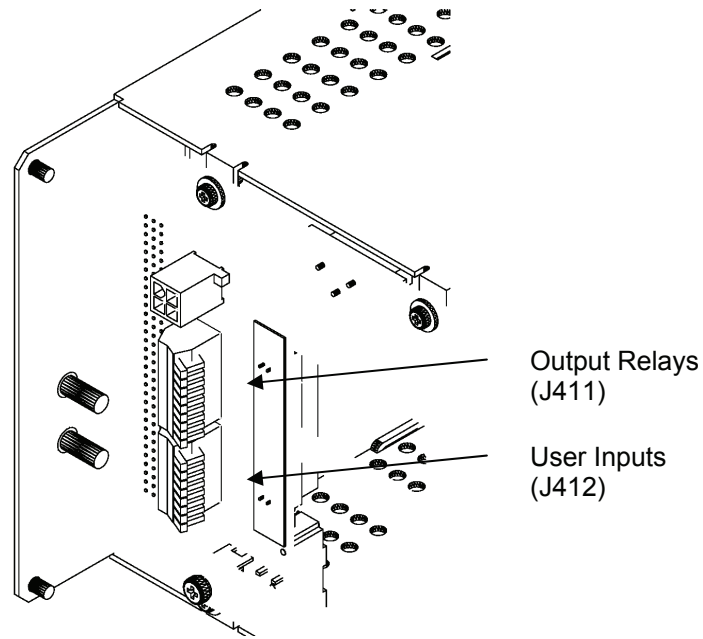

Figure 2.9-1 Interface Connections

Output Relay 2-6 Connections

Output Relays 2 through 6 are virtual relays and are not available for physical connection by the user. The small size of this unit limits the number of relays that can be placed in the system. These output relays are supported by the controller and reported by the network management card. Any alarm condition can be programmed to map to one of these relays. The alarm will activate the relay, illuminate the front panel Out Relay LED, and send the relay output message to the network management card.

RELAY OUTPUT	J 411 TERMINAL DESIGNATIONS	RELAY ALIAS	OUTPUT RELAY NOTES
OUT RELAY #1	NO		
	C		
	NC		
OUT RELAY #2	N/A		
OUT RELAY #3	N/A		
OUT RELAY #4	N/A		
OUT RELAY #5	N/A		
OUT RELAY #6	N/A		
MINOR	NO	N/A	
	C	N/A	
	NC	N/A	
MAJOR	NO	N/A	
	C	N/A	
	NC	N/A	

Figure 2.9-2 Output Relay Connections

External Alarm Input Connections

Four external alarm inputs with assignable relay outputs are available. User 1 and 2 inputs respond only to external dry contact closures between normally open (NO) and common (C) and User 3 and 4 respond only to external dry contact openings between normally closed (NC) and C. A Wago connector is located on the backplane card mounted in the left rear of the unit. The Wago connectors accept wires 26 AWG to 20 AWG (0.129 mm² to 0.518 mm²). To connect the user input, remove ¼ in (6 mm) of insulation from the end of the wire. Push down the white tab on the Wago connector, insert the stripped wire and release the tab to make the connection. Refer to **Figure 2.9-1** for backplane board connections.

EXTERNAL ALARM INPUT	J412 TERMINAL DESIGNATIONS	USER ALARM NOTES
#1 NO	USER1NO	
#2 NO	USER2NO	
#3 NC	USER3NC	
#4 NC	USER4NC	
#1 C	USER1C	
#2 C	USER2C	
#3 C	USER3C	
#4 C	USER4C	

Figure 2.9-3 External User Input Connections

2.10. Rectifier Module Installation



WARNING: Rectifier output DC circuits will be damaged if the batteries are installed incorrectly. Before installing additional rectifiers, ensure proper battery polarity, and that the battery is isolated from the rest of the system.

The Magnum VS system includes one (1), 10A, rectifier module. To install additional rectifier modules (shipped separately), follow the procedure outlined below. Rectifiers are “hot-swappable”, and, hence, may be installed when the DC system is turned on and in service.

- 1) Remove the rectifier from its shipping container.
- 2) Slide the rectifier module into the shelf between the guides until it is fully seated.
- 3) **Secure** the rectifier in place with the captive rectifier retaining screws.

Since all system settings are made from the system controller, no physical rectifier settings or adjustments are necessary.

2.11. Controller Module Installation

The Magnum VS Controller Module is installed at the factory. In the Magnum VS 50, the Controller Module is installed in the right-most slot of the power system. In the Magnum VS 100, the Controller Module is installed in the upper right-hand slot of the power system.



CAUTION: The controller and the network management card have lithium batteries. These batteries are not field serviceable.

- Danger of explosion if battery is replaced by an incorrect type.
- Dispose of used batteries according to the manufacturer’s instructions.

This section is intended as a guide when powering up a system for the first time. It may not be desirable to perform some steps depending on the particular installation. Refer to the appropriate section for information relating to how these steps should be performed.

3.1. Pre-Commissioning Inspection

Environment

1. Ensure the dc system environment is suitable for operation.
2. Ensure that there is sufficient clearance around the system for service.
3. Ensure that there is no sign of damage to the dc system.
4. Disable installed alarms before servicing the unit. This will allow the unit to be serviced without creating false alarms.

Electrical Installation

1. Ensure that the dc wiring is properly installed, sized, terminated and identified.
2. Ensure that the ac wiring is properly installed, sized, terminated and identified.
3. Ensure that the battery wiring is properly installed.
4. Ensure that the dc output over-current protection devices are adequate for the size of wiring installed.
5. Ensure that the dc positive is bonded to central office ground.
6. Note the resistance of the ground bond.
7. Note any currents flowing in the ground.
8. Record ambient temperature.
9. Verify that the battery polarity is correct.
10. If a battery disconnect device(s) is/are present, note the following for each device:
 - a. DC voltage Rating.
 - b. DC Current Rating
 - c. Interrupting Current Rating

Battery Visual and Safety Inspection

1. Check the mechanical integrity of the battery framing, racking, or cabinet.
2. Check that the battery framing, racking or cabinet is adequately secured to the floor.
3. Check compliance with seismic zone requirements.
4. Check the general appearance and cleanliness of the battery.
5. Record the manufacturer, model number, and capacity of the battery string(s).
6. Record the batch number, date code, and serial number of each cell or mono-block, and any other pertinent information that is available on the battery cells.
7. Check that the cell or mono-block numbering starts at the positive battery string terminal and is correct.
8. Check that anti-oxidation compound is properly applied.
9. Visually inspect each cell for:
 - a. Cracks.
 - b. Case leaks.
 - c. Post-seal leaks.
 - d. Pressure relief valve leaks (VRLA only).
 - e. Case swelling (VRLA only).
10. Check the torque of all battery inter- cell connector in accordance with the battery manufacturer's specifications.

3.2. Commissioning

Initial Set-up

1. Remove all rectifiers.
2. Disconnect battery by removing a link in each string or opening the battery disconnects.
3. Check that battery voltage does not appear on the system bus.
4. Disconnect all loads.

AC Power Up



WARNING: The dc power plant is supplied from a nominal high voltage ac voltage source. Keep the ac input enclosure cover in place when the system is operational or energized

1. Verify that all of the circuit breaker positions are labeled to the corresponding rectifier correctly.
2. Insert all rectifiers.
3. Turn all rectifier circuit breakers on.
4. Each rectifier should have green Input Healthy and Output Healthy LEDs illuminated.

NOTE: When ac power is initially applied, there is a 60-second period during which no alarms are reported.

DC Power Up:

1. Verify, with a voltmeter, that the DC voltage is within 0.1 Vdc of the System Voltage
2. Using the Controller interface (direct serial or network-based connection), adjust battery float voltage to negative 49 Vdc.
3. Verify System Low Voltage Alarm.
4. Using the Controller interface (direct serial or network-based connection), adjust battery float voltage to negative 57 Vdc.
5. Verify System High Voltage Alarm.
6. Restore the battery float voltage to negative 54.00 Vdc or desired voltage.

Rectifier Test:

1. To verify that all rectifiers are reporting correctly to the controller, navigate through the menu and verify that the status for every rectifier in the system is correct.
2. Remove any rectifier and verify that you get a Minor Relay Output for rectifier 1 of n failure.
3. Remove a second rectifier and verify that you get a Major Relay Output for rectifier 2 of n failure.

Battery Power Up

1. Monitor battery current and verify that it is +/- 0.1 A.
2. Set battery maximum recharge value in the Max Batt Rech screen.
3. Monitor the battery current while closing the battery disconnects or installing open battery links. Arcing can occur during this connection.
4. The voltage may drop if the maximum battery recharge current is exceeded.
5. The current should gradually decrease when the battery is nearing full charge.

LVD Test

1. Enable LVD 1.
2. Set the LVD trip for LVD 1 to negative 56 Vdc.
3. The LVD should have dropped out (opened). Verify by monitoring the voltage at the battery connection. Also, the minor alarm should be on.
4. Set LVD Trip back to negative 42 Vdc.
5. The LVD should have closed. Verify visually or by monitoring the voltage at the battery connection. The minor alarm should be off.
6. Ensure that the LVD parameters are set to desired value.

Circuit Breaker/ Fuse Test:

1. Monitor alarm screen for fuse alarm while installing blown GMT fuses in each position.
2. Verify proper voltage at fuse and circuit breaker output connections.
3. Turn on fuses and circuit breakers as desired.

User Inputs

1. Change the user input to desired output relay via the controller for any input that will be used.
2. Exercise the output relay by causing the user input to change state.
3. Verify the desired relay output LED on the controller module.

Output Relay 1:

1. Minor and Major output relays were tested in the rectifier test section.
2. Change the alarm to desired relay output via the controller for any relay output that will be used. All alarm parameters are shipped as either major or minor, but may be changed to output relay 1.
3. Program output relay 1 to desired major or minor alarm to complete programming.
4. Exercise the output relay by causing the alarm to change state.

Battery Temperature Compensation

1. Enable battery temperature compensation if desired.
2. Ensure that battery temperature probe is connected to the system and attached to the battery.
3. Verify that the system voltage is above the float voltage setting if the battery temperature is below 25 degrees C and below the float voltage setting if the battery temperature is above 25 degrees C.

3.3. Final Inspection:

1. Verify that the interior and exterior of the system is clean and free from debris.
2. Ensure all wires connected and bolts are properly tightened.
3. Ensure the following the User, Service, and Calibration parameters are set properly on the controller:

LVD

LVD1 Trip

LVD1 Reset

Battery Parameters

Discharge Threshold

Float Voltage

Maximum Recharge

Compensation Method

4. Verify that the system is functioning correctly with no alarms.

Be sure to leave the site as orderly and neat as possible.

The Power System is designed to supply safe -54 Vdc primary power through the use of up to 10 rectifier modules. The controller will monitor all functions and provides battery management including controlled battery recharge with temperature compensation and low voltage disconnect. Integrated dc output distribution supports loads ranging from ¼ A all the way to 60 A. The controller can monitor up to 4 discrete external events with voltage free (“dry contact”) user inputs.

4.1. Rectifier Management

AC Input Power

The basic component of the power system is the rectifier module, which rectifies utility ac into nominal 48 Vdc. Each rectifier module requires 85 – 264 Vac, 47 – 63 Hz single phase power. Available cord sets include a variety of blade and twist lock plugs. Dedicated wiring inside conduit can also be used.

DC Output Power

The dc outputs of all the rectifiers in the system are connected to a common bus that is rated to carry the current of the entire system. The rectifier modules will equally share the entire load, independent of the controller. The rectifiers will continue to provide dc power (-54.5 Vdc) if the controller is removed or fails.

Rectifier alarms reporting

The rectifier has numerous sensors inside the unit that monitor fan fail, high temperature, high/low voltage, etc. These rectifier sensors trigger outputs that are monitored by the controller. In addition rectifier current is measured inside each rectifier. The controller can trigger output relays in the event of a rectifier alarm. Refer to Section 4.5 for controller functions.

4.2. System Management

System Voltage Monitor and Control

The controller monitors and adjusts the system voltage. It uses a voltage trim input to the rectifier to precisely control the dc output voltage. In the event of controller removal or failure, individual rectifiers will default to the analog voltage level (-54.5 Vdc) preset at the factory. System high and low voltage alarms are reported by the controller.

System Current Monitor

The controller monitors individual rectifier currents and displays total system current as a sum of rectifier currents. Load current can be found by adding battery current to system current. Battery Current is positive when the battery is discharging.

Sys Current + Batt current = Load Current

For example, if the battery is charging the Batt Current reading could be (-) 10 A, Sys Current reading could be 50 A. Load Current would be:

Sys Current + Batt current = Load Current
50 A + (-) 10 A = 40 A.

If the battery is discharging the Batt Current reading could be 10 A, Sys Current reading could be 30 A. Load current would be:

Sys Current + Batt current = Load Current
30 A + 10 A = 40 A.

System Status and Alarm Reporting

The controller will monitor system, temperature. The controller reports system high and low temperature alarms.

4.3. Load Management

Circuit Breakers

The Magnum VS Distribution Module includes two (2) 30A or one (1) 60A circuit breaker, or eight (8) GMT fuses. When a circuit breaker trips, a normally open switch closes and the Controller reports a CB alarm. Alarms are reported only when a breaker is tripped. When a breaker is turned off, no alarm is generated. Circuit Breaker Alarms 1 or 2 are reported when a circuit breaker in the top shelf trips. Circuit Breaker Alarms 3 or 4 are reported when a circuit breaker in the bottom shelf trips. Please note that if a Magnum VS 100 system has one (1) circuit breaker in the top shelf and one (1) circuit breaker in the bottom shelf, the circuit breakers in the bottom shelf will be labeled CB2 on the front panel, but Circuit Breaker Alarm 3 will be reported. To disconnect a load attached to a circuit breaker, move the lever down to the "OFF" position.

GMT Fuses

When a GMT fuse trips, a fuse element burns out allowing the indicator to connect DC power to the alarm contact. This turns on the fuse alarm LED on the fuse panel indicating the affected group and the Controller reports a fuse alarm. Each Controller fuse alarm combines alarms from 4 individual fuses:

Fuse F1 to F4: Controller Fuse Alarm 1
Fuse F5 to F8: Controller Fuse Alarm 2
Fuse F9 to F12: Controller Fuse Alarm 3
Fuse F13 to F16: Controller Fuse Alarm 4.

To disconnect a load attached to a GMT fuse, pull the fuse straight out of the fuse holder base.

4.4. Battery Management

Battery Charging

Battery charging is integrated into the dc power system to support the primary function of providing power to the load. Accurate measurement of battery parameters such as voltage, current and temperature are used to maintain and protect the batteries attached to the power plant.

Charging the battery at the correct rate reduces battery heating, increases the charge returned to the battery and prevents excess hydrogen generation or, in the case of Valve Regulated Lead Acid (VRLA) batteries, possible thermal runaway. The Magnum VS operates as a current limited constant voltage battery charger. The current limit value is set by the controller's Battery Maximum Recharge Current parameter and is normally based on the size of the battery plant in ampere-hours.

Consult the battery manufacturer for the recommended maximum charging current. This is frequently expressed as a percentage of the battery's 20-hour ampere-hour capacity rating, commonly abbreviated as "C". For example, the maximum recharge current in amperes may be expressed as 0.2C, 20% C or C/5, all of which are equivalent. If the battery used has a capacity of 120 Ah, then the 0.2 C max current is 24 amperes. Manufacturers typically specify max recharge current between 0.1C to 0.3C (C/10 to C/3). Avoid high recharge rates that may induce elevated battery temperatures that can lead to thermal runaway. A 0.1C max recharge current is generally a conservative value that will result in a 90-95% recharge in 12-15 hours, depending on the initial depth of discharge. In this case charging current will begin to taper (reduce) from the current limited value after 3.5 - 7 hours.

Typically four 12-volt batteries are connected in series to form a battery string. The ampere-hour rating for one 12-volt battery will equal the Ah rating of the string. For multiple parallel strings, add the Ah rating of each string together to get the total Ah rating.

Battery Protection

An external disconnect should be mounted at the battery string to protect the system from the high energy stored in the battery if a short occurs. The battery LVD will not be energized until a battery string is installed with the proper polarity and the battery disconnect switch is turned on. The battery connections are to be used for the battery only. Do not attach loads to the battery connections or erroneous battery current will be reported. The controller reports Battery high and low voltage alarms and LVD alarms.

Battery Temperature Monitoring

Battery temperature is monitored using a probe attached to the battery casing. The controller reports Battery high and low temperature alarms.

Battery Temperature Compensation

The Battery Float Voltage is set to the value recommended by the battery manufacturer in order to maintain correct battery charge at 25°C. As temperature rises, electrochemical activity in a battery increases. Similarly, as temperature falls, electrochemical activity in a battery decreases. As temperature rises, charging voltage should be reduced to prevent overcharge and possible thermal runaway. As battery temperature falls, voltage is increased to prevent undercharge. The dc power system uses Battery Temperature compensation to change output voltage to compensate for temperature changes monitored at the battery temperature probe. This temperature compensation function is programmed into the controller using the compensation parameters settings. Default settings can be changed to values recommended by the particular battery manufacturer. The controller will not allow the system voltage to be adjusted beyond the range of -47 Vdc to -56.5 Vdc.

Battery Low Voltage Disconnect

In order to prevent damage to the battery due to deep discharge, the dc power system has hardware and software support for a battery Low Voltage Disconnect (LVD). When the battery voltage reaches the threshold set by the *LVD 1 Trip Voltage* setting during discharge, the dc power system will activate the LVD contactor to disconnect the battery from the system. The LVD will remain open until ac power is restored to the system and the bus voltage reaches the level defined by the *LVD 1 Reset Voltage* variable. The LVD control can be disabled on the LVD parameters screen in the controller.

NOTE: The LVD is normally energized and must be commanded to open. This assures that the LVD will remain closed even if the controller fails or is removed.

The LVD will not be energized until a battery string is installed with the correct polarity and the battery disconnect switch is turned on. This will prevent the battery from being hooked up backwards and damaging the rectifiers and/or the loads. Once the battery is connected correctly and the LVD is closed, the LVD will open only in low voltage situations. The battery connections are to be used for the battery only.

Counter Electro-Motive Force Module Connections

A connection is provided to connect a Counter Electro-Motive Force (CEMF) Module. A CEMF is a semiconductor device connected in series with a battery and used to reduce the voltage to loads that cannot tolerate the "normal" main cell voltage. The CEMF cells are automatically switched out of the circuit when the discharge voltage drops to a predetermined level and are automatically switched back into the circuit when the battery approaches its normal float value.

4.5. Controls and Indicators

Controller Module

All status monitoring and/or parameter changes are made using a computer connected to the Magnum VS system over an (10/100 Base-T) Ethernet network or directly connected via a serial cable. Refer to Section 5 for additional information.

There are five visual indicators (LEDs) on the Controller Module. The Major LED (Red) is on when the Major Relay is de-energized. The Major Relay is energized when there is no alarm. This will produce a major relay output even when all power is lost. The Minor LED (Yellow) is on when the Minor Relay is energized. The Out Relay LED (Yellow) is on when the Out Relay is energized. The DC OK LED (Green) is on when the voltage is between 50 and 57 Vdc. The green LED behind the front panel is slowly flashing when the controller is processing data.

4.6. Alarm Outputs (Output Relays)

There are three alarm output relays designated Out Relay 1, Minor, and Major. Various system parameters may be programmed to activate any of these output relays when set thresholds are exceeded or specific conditions occur. Out Relay 1 can also be routed or “mapped” to “Out Relay 1-6,” “Minor Relay,” “Major Relay” or “Ignore.” This feature makes it possible for a single alarm condition to activate multiple alarm output relays including the Minor or Major alarm relay. For information on making wiring connections to the alarm output relays refer to **Section 2.9**

In addition to the output relays described above there are 5 outputs that do not support actual hardware. These are called Output Relay 2 through 6. While the relay hardware is not available, the programming can still be used to provide more detailed information through the network management card. Using the actual relay 1 and the 5 virtual relays 2-6, six different parameters can be alarmed with unique messages through the network management card. Various system parameters may be programmed to activate any of these output relays when set thresholds are exceeded or specific conditions occur. Relay 2-6 can also be routed or “mapped” to “Out Relay 1-6,” “Minor Relay,” “Major Relay” or “Ignore.”

Out Relay 1-6 can be renamed using the Relay Alias setup screen. Each relay name can be up to sixteen characters in length. This name will appear in the messages generated by the network management card. This can be used to give specific information on the exact nature of the active alarm.

4.7. External Alarm Inputs (User Input)

The Controller can monitor any external device that uses a voltage free (“dry contact”) switch or relay to output status information. The four external user inputs can be routed or “mapped” to alarm output relays. Available assignments are “Ignore”, “Major”, “Minor”, and “Out Relay 1.” For information on wiring connections to these inputs refer to **Section 2.9**

4.8. Network Management Card - Local & Remote Monitoring

The Magnum VS controller includes an APC AP9617 Network Management Card which allows both local and remote access to the power system. The AP9617 is a web-based management product that uses multiple, open standards such as Telnet, HTTP, and SNMP to provide full management of supported devices. The following is a list of some of this Management Card's features:

- Provides a Data Log accessible by FTP or a Web browser.
- Provides an Event Log accessible by Telnet, FTP, or a Web browser
- Detects connection speed of 10/100 MB per second.
- Generates Email notifications for DC Power Plant events and system events.
- Limits SNMP traps and Email notifications based on the severity level of the DC Power Plant or system events

The Management Card has two internal interfaces (control console and Web interface) which provide menus with options that allow you to manage the DC Power Plant and the Management Card. The Management Card's SNMP interface also allows you to use an SNMP browser with the PowerNet® Management Information Base (MIB) to manage the DC Power Plant.

5.1. Description

The Magnum VS is designed for years of operation with no user input. The power system is pre-programmed at the factory with all parameters needed for normal operation. The front panel LEDs and the alarm output relays, indicate the general health of the unit.

5.2. Controller Module Jumpers

System Voltage J5

The positioning of jumpers on header J5 will determine the operating voltage of the controller card operates. Options include –48 V, +24 V, +48 V, or –24 V systems. The Magnum VS is only a –48 V system. The only setting allowed is the –48 V setting, which is J5-1 jumpered to J5-6 and J5-2 jumpered to J5-7.

Remote Lockout J8

It is possible to make parameter changes to the controller card through the RS232 port or through the 10/100 Base T port of the network management card. The controller card is shipped with a jumper between pins J8-2 and J8-3, allowing such parameter changes. If the user wishes to disable the remote configuration feature, then the jumper is moved to pins J8-1 and J8-2.

Firmware Programming Enable J9

When the operating system is initially installed at the factory, J9-1 is jumpered to J9-2. This setting interferes with normal operation. To ensure normal operation, the controller card is shipped without this jumper. During normal operation, the only setting allowed is no jumper between J9-1 and J9-2.

Vtrim Trip Select J13

The header J13 is a factory set header that allows this controller to work with different types of rectifiers. The Magnum VS always uses the Magnum VS rectifier. During normal operation, the only setting allowed is J13-2 jumpered to J13-3.

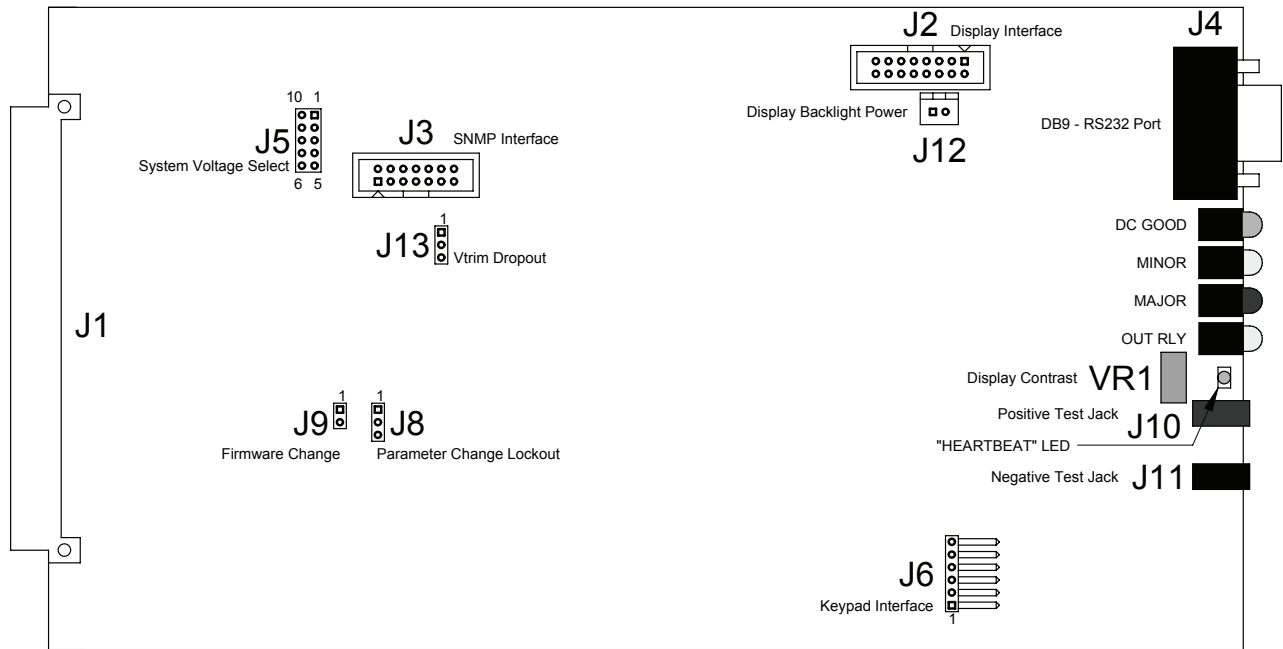

Figure 5.2-1 Controller Card Jumper Locations

Controller Module

All status monitoring and/or parameter changes are made using a computer connected to the Magnum VS system over an (10/100 Base-T) Ethernet network or directly connected via a serial cable. Refer to Figure 0-1 for the front panel layout.

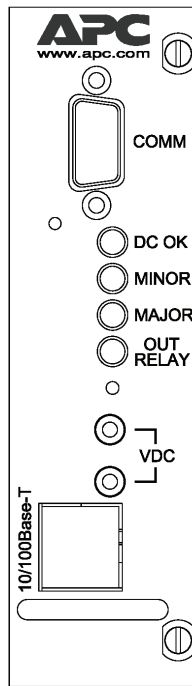

Figure 0-1 Magnum VS Controller

5.3. Operation Using the RS-232 Comm Port

The front panel DB-9 connector provides a means to connect a PC to the controller locally to set controller parameters and to view status. To connect to this port use a straight through cable such as APC part number 0129-XX. A 0129-6 is included with this manual. Refer to the Network Management Card Quick Start Manual or the User's Guide supplied on the CD shipped with the system for details on how to communicate to the controller using a terminal emulation program like HyperTerminal^(TM) or ProComm^(TM)

NOTE: The smart-signaling cable (940-0024 or 940-1524) referenced in the Quick Start Manual and User's Guide does not apply to the Magnum VS. Use a straight through cable such as APC part number 0129-XX. A 0129-6 is included with this manual.

Communication to the controller through the local serial port is accomplished via the network management card's Control Console interface. This is a simple text based menu interface.

5.4. Operation Using the 10/100 BaseT Ethernet Port

The RJ-45 10/100 Base-T port is primarily intended for connection to an intranet for remote access to the DC power system. However with the use of a crossover cable or a hub, a direct PC to 10/100 Base-T local connection may also be made.

After the Management Card is configured and running on your network, you can use several different interfaces to access the Management Card: Web, Telnet, SNMP and FTP.

-The Web interface uses a web browser such as Microsoft® Internet Explorer 5.0 (and higher) or Netscape® 4.0.8 (and higher) to configure Management Card options and to view DC power system status, alarms and events.

-Telnet is used to access a Management Card's Control Console and is the same user interface available via the local RS-232 serial port.

-SNMP access is available after you add the PowerNet MIB to a standard SNMP MIB browser.

-FTP access is used to download new firmware to a Management Card, or to access a copy of a Management Card's event or data logs.

Complete documentation for the use of the management card accompanies the DC power system in the form of a Quick Start Guide and a CD. The CD contains electronic copies of User's Manuals along with the necessary software utilities to support the management function. Some of the functions supported by the network card are not supported by this power system.

5.5. Operation using Network Management Card Web Browser Interface

The location, description, and factory programmed default value for each of the Magnum VS system parameters accessible via a Web browser is found in the table below. The table also shows all of the status and information screens with typical displays. The location of a parameter screen is shown in brackets, for example: **[Power Modules/Rectifiers]**. This table is organized alphabetically by parameter name.

Figure 5.5-1 Parameter Locations, Descriptions, and Settings

PARAMETER NAME/ [MENU LOCATION]	DESCRIPTION	SETTINGS (Default settings in BOLD)
Alarms Item 1 {Status Only} [System/Active Alarms] • • • Alarms Item 16 [System/Active Alarms]	Display of up to 16 active alarms (a typical alarm screen is shown). • • • Display of up to 16 active alarms (a typical alarm screen is shown).	No Alarms • • • No Alarms
Battery Current {Status Only} [System/DC Parameters]	Battery current measured by the system controller at the battery current shunt.	Status Only
Battery Discharge Alarm [Batteries/Parameters]	Defines the output relay that is energized if the battery discharge current exceeds the programmed battery discharge threshold.	Ignore, Minor , Major Output Relay 1-6
Battery Discharge Threshold [Batteries/Parameters]	An alarm is generated if the battery discharge current exceeds this value.	0 A – 20A, 5 A
Battery Float Voltage [Batteries/Parameters]	One of three parameters that control the dc output voltage. Set the Float Voltage at 25° C battery temperature per the battery manufacturer recommendations.	-56.5 – -47.0, -54.00 V
Battery High Temperature Alarm [Batteries/Parameters]	Defines the output relay that is energized if the battery temperature exceeds the Battery High Temperature threshold.	Ignore, Minor , Major Output Relay 1-6
Battery High Temperature Threshold [Batteries/Parameters]	Battery Temperature is temperature measured at the battery probe. An alarm is generated if the battery temperature exceeds this value.	-100 °C – 200 °C, 40.0 °C
Battery High Voltage Alarm [Batteries/Parameters]	Defines the output relay that is energized if the dc output voltage rises above the battery high voltage threshold.	Ignore, Minor , Major Output Relay 1-6
Battery High Voltage Threshold [Batteries/Parameters]	An alarm will be reported if temperature is lower than the temperature entered. An alarm is generated if the dc output voltage rises above this value.	-40.00 V – -60.00 V, - 58.00 V
Battery Low Temperature Alarm [Batteries/Parameters]	Defines the output relay that is energized if the Battery Temperature drops below the battery Low Temperature threshold.	Ignore, Minor , Major Output Relay 1-6
Battery Low Temperature Threshold [Batteries/Parameters]	Battery Temperature is temperature measured at the battery probe. An alarm is generated if the battery temperature drops below this value.	-100 °C – 200 °C, -20.0 °C
Battery Low Voltage Alarm [Batteries/Parameters]	Defines the output relay that is energized if the dc output voltage drops below the battery low voltage threshold.	Ignore, Minor , Major Output Relay 1-6
Battery Low Voltage Threshold [Batteries/Parameters]	An alarm is generated if the dc output voltage drops below this value.	-40.00 V – -60.00 V, -44.00 V

PARAMETER NAME/ [MENU LOCATION]	DESCRIPTION	SETTINGS (Default settings in BOLD)
Battery Max Recharge {Status Only} [System/DC Parameters]	This is just a convenient place to view the Battery Max Recharge Current parameter. Go to Batteries/Parameters to change setting.	Status Only
Battery Maximum Recharge Current [Batteries/Parameters]	One of three parameters that control the dc output voltage. If Battery Current surpasses the Maximum Battery Recharge Current, the dc output voltage will be reduced (the system limits the charging current to this programmable value).	0 – 10,000 A, 10 A
Battery Temperature [System/DC Parameters]	Battery temperature measured by the system controller at the optional battery temperature sensor probe.	Status Only
Battery Temperature Compensation High Knee [Batteries/Parameters]	The temperature compensation high knee is the point where there is no additional battery voltage compensation for further increases in temperature.	0 °C – 100 °C, 40.0 °C
Battery Temperature Compensation Low Knee [Batteries/Parameters]	The temperature compensation low knee is the point where there is no additional battery voltage compensation for further decreases in temperature.	-100 °C – 100 °C, 0.0 °C
Battery Temperature Compensation Method [Batteries/Parameters]	One of three parameters that control the dc output voltage. Activate “ON” or deactivate “OFF” battery temperature compensation.	ON , OFF
Battery Temperature Compensation Temperature Coefficient [Batteries/Parameters]	Temperature compensation coefficient between low knee and high knee in mV/cell/°C. (Compensation equals zero at 25°C.)	-4.99 mV – 0 mV, -3.00 mV
Circuit Breaker 1 Alias [Distribution/Breakers] • • • Circuit Breaker 4 Alias [Distribution/Breakers]	An alternate name (alias) can be assigned to Circuit Breaker 1 if desired. This feature is supported by the standard SNMP card monitor, but is not supported by this dc system.	Circuit Breaker 1 • • • Circuit Breaker 4
Circuit Breaker 1 Tripped [Distribution/Breakers] • • • Circuit Breaker 4 Tripped [Distribution/Breakers]	Defines the output relay that is energized when Circuit Breaker 1 is tripped. • • • Defines the output relay that is energized when Circuit Breaker 4 is tripped.	Ignore, Minor, Major Output Relay 1-6 • • • Ignore, Minor, Major Output Relay 1-6 Circuit Breaker 5-72 is not used in this system.
Communications Fail	Defines the output relay that is energized if the System stops communicating with the rectifiers. This feature is supported by the standard SNMP card monitor, but is not supported by this dc system.	Ignore , Minor, Major Output Relay 1-6•

PARAMETER NAME/ [MENU LOCATION]	DESCRIPTION	SETTINGS (Default settings in BOLD)
Current Limit Alarm Status {Status Only} [Power Modules/Rectifiers]	The status will be "ON" if the rectifier has been forced into its current limited mode.	Status Only
Date [System/Date & Time]	Internal network management card calendar date. Used as a date stamp in the web card event log.	Current Date
Description 1 [System/DC Parameters]	Power plant identification - first line.	
Description 2 [System/DC Parameters]	Power plant identification - second line.	Magnum VS This is not user edit-able.
Description 3 [System/DC Parameters]	Power plant identification - third line.	Power System This is not user edit-able.
Fail Safe [Power Modules/Rectifiers]	If the rectifiers fail to communicate with the system, the rectifiers will output this pre-defined voltage.	This feature is supported by the standard SNMP card monitor, but is not supported by this dc system.
FUSE 1 Alias [Distribution/Fuses] • • • FUSE 1 Alias [Distribution/Fuses]	An alternate name (alias) can be assigned to Fuse 1 if desired. This feature is supported by the standard SNMP card monitor, but is not supported by this dc system.	FUSE 1 • • • FUSE 16
FUSE 1 Blown [Distribution/Fuses] • • • FUSE 4 Blown [Distribution/Fuses]	Defines the output relay that is energized when F1-4 is blown. • • • Defines the output relay that is energized when F13-16 is blown.	Ignore, Minor, Major Output Relay 1-6 • • • Ignore, Minor, Major Output Relay 1-6 Fuse 5-16 is not used in this system
Hardware Battery Current Alarm [Batteries Parameters]	Defines the output relay that is energized if there is a hardware failure in the battery current monitoring function. This feature is supported by the standard SNMP card monitor, but is not supported by this dc system.	Ignore , Minor, Major Output Relay 1-6
Hardware Battery Temperature Alarm [Batteries Parameters]	Defines the output relay that is energized if there is a hardware failure in the battery temperature monitoring function. Program to Ignore if no battery temperature probe is connected to J410.	Ignore, Minor , Major Output Relay 1-6
Hardware LVD Alarm [Batteries/LVD]	Defines the output relay that is energized if there is a conflict between the commanded and sensed positions of the LVD contactor. This feature is supported by the standard SNMP card monitor, but is not supported by this dc system.	Ignore , Minor, Major Output Relay 1-6

PARAMETER NAME/ [MENU LOCATION]	DESCRIPTION	SETTINGS (Default settings in BOLD)
Hardware System Voltage Alarm [Power Modules/Rectifiers]	Defines the output relay that is energized if there is a hardware failure in the system voltage monitoring function.	Ignore, Minor , Major Output Relay 1-6
Hardware Temperature Alarm [System/DC Parameters]	Defines the output relay that is energized if there is a hardware failure in the system temperature monitoring function.	Ignore, Minor , Major Output Relay 1-6
High Temperature Alarm [System/DC Parameters]	Defines the output relay that is energized if the System Temperature exceeds the system high temperature threshold. Not the same as battery temperature alarm.	Ignore, Minor , Major Output Relay 1-6
High Temperature Threshold [System/DC Parameters]	Ambient temperature measured inside the controller. An alarm will be reported if temperature is higher than the temperature entered. Not the same as battery temperature threshold.	0 °C – 100 °C, 70.0 °C
High Voltage alarm [Power Modules/Rectifiers]	Defines the output relay that is energized if the System Voltage is above the System High Voltage threshold. Not the same as battery voltage alarm.	Ignore, Minor , Major Output Relay 1-6
High Voltage Threshold [Power Modules/Rectifiers]	DC voltage measured by the controller. An alarm will be reported if voltage is higher than the voltage entered. Not the same as battery voltage threshold.	-60 V – -40 V, -58.00 V
Imbalance Alarm [Power Modules/Rectifiers]	An alarm will be generated if the rectifiers do not current share. This feature is supported by the standard SNMP card monitor, but is not supported by this dc system.	Ignore , Minor, Major Output Relay 1-6
Input Relay 1 [I/O/Input]	Defines the output relay that is energized when an external contact closure or opening at the Input Relay 1 connection changes state.	Ignore , Minor, Major Output Relay 1-6
• • • Input Relay 4 [I/O/Input]	Defines the output relay that is energized when an external contact closure or opening at the Input Relay 4 connection changes state.	• • • Ignore , Minor, Major Output Relay 1-6
Input Relay 1-4 Alias [I/O/Input]	This feature is supported by the standard SNMP card monitor, but is not supported by this dc system.	Input 1-4
Input Relay 1-4 Delay [I/O/Input]	This feature is supported by the standard SNMP card monitor, but is not supported by this dc system.	0.00 Seconds
Low Temperature Alarm [System/DC Parameters]	Defines the output relay that is energized if the System Temperature is below the System Low Temperature threshold. Not the same as battery temperature alarm.	Ignore, Minor , Major Output Relay 1-6

PARAMETER NAME/ [MENU LOCATION]	DESCRIPTION	SETTINGS (Default settings in BOLD)
Low Temperature Threshold [System/DC Parameters]	System Temperature is ambient temperature measured inside the controller. An alarm will be reported if temperature is lower than the temperature entered. Not the same as battery temperature threshold.	-100 °C – 100 °C, 0.0 °C
Low Voltage Alarm [Power Modules/Rectifiers]	Defines the output relay that is energized if the System Voltage is below the System Low Voltage threshold. Not the same as battery voltage alarm.	Ignore, Minor , Major Output Relay 1-6
Low Voltage Threshold [Power Modules/Rectifiers]	System Voltage is bus voltage measured by the controller. An alarm will be reported if voltage is lower than the voltage entered. Not the same as battery voltage threshold.	-60 V – -40 V, -50.00 V
LVD 1 Option [Batteries/LVD]	If the unit has an LVD, but it is disabled, the controller will not disconnect the LVD.	Enable , Disable
LVD 1 Reset [Batteries/LVD]	LVD Reset (reconnect) threshold voltage.	-56 V – -40 V, -50.00 V
LVD 1 Trip [Batteries/LVD]	LVD Trip (disconnect) threshold voltage.	-56 V – -40 V, -42.00 V
LVD 2 Option [Batteries/LVD]	Not available on this system.	Disable
LVD 2 Reset [Batteries/LVD]	Not available on this system.	0.00 V
LVD 2 Trip [Batteries/LVD]	Not available on this system.	0.00 V
LVD Alarm [Batteries/LVD]	Defines the output relay that is energized when the controller opens the LVD. If unit has a battery LVD, no power will be available to turn on any Output Relays.	Ignore, Minor , Major Output Relay 1-6
Output Relay 1 Alarm [I/O/Output]	Output Relay 1 Alarm can be “mapped” to activate other output relays (“Ignore” activates no additional relays).	Ignore , Minor, Major Output Relay 1-6
Output Relay 2 Alarm [I/O/Output]	Output Relay 2-6 Alarm can be “mapped” to activate other output relays (“Ignore” activates no additional relays). Alarms that are mapped to output relay 2-6 are not supported by hardware. The network management card supports programming these relays. These relays can be mapped to the hardware relays minor and major.	<ul style="list-style-type: none"> • • • Ignore , Minor, Major Output Relay 1-6
Output Relay 6 Alarm [I/O/Output]		

PARAMETER NAME/ [MENU LOCATION]	DESCRIPTION	SETTINGS (Default settings in BOLD)
Output Relay 1 Alias [System/Out-Rly/Alias] • • • Output Relay 6 Alias [System/Out-Rly/Alias]	An alternate name (alias) can be assigned to Output Relay 1 if desired. • • An alternate name (alias) can be assigned to Output Relay 6 if desired.	Output Relay 1 • • • Output Relay 6
Output Relay 1 Delay [I/O/Output] • • • Output Relay 6 Delay [I/O/Output]	Delay between sensing of the alarm condition and activation of the mapped relay. An alarm condition must exist for longer than the delay to be activated.	0.00 seconds – 600.00 seconds, 0.00 seconds
Rectifier 1-of-N Alarm [Power Modules/Rectifiers]	Defines the output relay that is energized if Rectifier Fail 1-of-N alarm occurs. This is a special rectifier alarm group that signifies that one rectifier has at least one alarm condition.	Ignore, Minor , Major Output Relay 1-6
Rectifier 2-of-N Alarm [Power Modules/Rectifiers]	Defines the output relay that is energized if Rectifier Fail 2-of-N alarm occurs. This is a special rectifier alarm group that signifies that more than one rectifier has at least one alarm condition.	Ignore, Minor, Major Output Relay 1-6
Rectifier Configuration Alarm [Power Modules/Rectifiers]	Defines the output relay that is that is energized a rectifier is added to any empty slot after the dc system is powered up or configured. This feature is supported by the standard SNMP card monitor, but is not supported by this dc system.	Ignore, Minor, Major Output Relay 1-6, n of N
Rectifier Current Limit Alarm [Power Modules/Rectifiers]	Defines the output relay that is energized or special rectifier alarm group n of N that occurs when a rectifier has been forced into the current limited mode.	Ignore, Minor, Major Output Relay 1-6, n of N
Rectifier Current Output Status {Status Only} [Power Modules/Rectifiers]	A display of the dc output current for the individual rectifier.	Status Only
Rectifier Description {Status Only} [Power Modules/Rectifiers]	Displays the model number of the installed rectifier.	Status Only
Rectifier Diagnostic Alarm [Power Modules/Rectifiers]	This feature is not needed in this particular configuration.	Ignore , Minor, Major Output Relay 1-6, n of N
Rectifier Fan Fail Alarm [Power Modules/Rectifiers]	Defines the output relay that is energized or special rectifier alarm group n of N that occurs when a rectifier fan has failed.	Ignore, Minor, Major Output Relay 1-6, n of N
Rectifier Fan Fail Alarm Status {Status Only} [Power Modules/Rectifiers]	The status will be “ON” if the rectifier fan has failed.	Status Only

PARAMETER NAME/ [MENU LOCATION]	DESCRIPTION	SETTINGS (Default settings in BOLD)
Rectifier Fault Alarm (RFA) Status {Status Only} [Power Modules/Rectifiers]	The status will be on if the rectifier output has failed.	Status Only
Rectifier RFA Alarm [Power Modules/Rectifiers]	Defines the output relay that is energized or special rectifier alarm group n of N that occurs when a rectifier output has failed.	Ignore, Minor, Major Output Relay 1-6, n of N
Rectifier Standby Alarm [Power Modules/Rectifiers]	Defines the output relay that is that is energized or special rectifier alarm group n of N that occurs when the controller is holding a rectifier in the standby mode.	Ignore, Minor, Major Output Relay 1-6, n of N
Rectifier Standby Alarm Status {Status Only} [Power Modules/Rectifiers]	The status will be "ON" if the controller is holding the rectifier in the standby mode.	This feature is supported by the standard SNMP card monitor, but is not supported by this dc system.
Remote Configurable [System/DC Parameters]	This allows settings to be made using the SNMP interface card. Disabling this feature allows changes to be made through the local interface only. Status and parameters are still displayed.	Enabled , Disabled
Store Configuration [Power Modules/Rectifiers]	This feature is supported by the standard SNMP card monitor, but is not supported by this dc system.	Enable, Disable
System Current {Status Only} [System/DC Parameters]	The total system output current (calculated as the sum of the individual rectifier output currents).	Status Only
System Temperature {Status Only} [System/DC Parameters]	System temperature measured within the controller.	Status Only
System Voltage {Status Only} [System/DC Parameters]	Voltage readout measured by the controller at the output of the rectifiers. This voltage is based on calculations performed by the controller based on the Battery Float, Battery Temperature Compensation, and Battery Maximum Recharge parameter settings.	Status Only
Temperature Display Units [System/Preferences]	Enables selection of Fahrenheit or Celsius temperature scale (Fahrenheit "OFF" displays readings in °C).	Fahrenheit, Celsius
Time [System/Date & Time]	Network management card Internal system clock time (24-hour format). Used as a time stamp in the web card event log.	Current Time

5.6. LVD Operation

In order to prevent damage to the battery due to deep discharge, the dc power system has a Low Voltage Disconnect (LVD). When the battery voltage reaches the threshold set by the *LVD 1 Trip Voltage* setting during discharge, the dc power system will activate the LVD contactor to disconnect the battery from the system. The LVD will remain open until ac power is restored to the system and the bus voltage reaches the level defined by the *LVD 1 Reset Voltage* variable. The LVD control can be disabled on the LVD parameters screen in the controller.

The LVD will not be energized until a battery string is installed with the correct polarity and the battery disconnect switch is turned on. This will prevent the battery from being hooked up backwards and damaging the rectifiers and/or the loads. Once the battery is connected correctly and the LVD is closed, the LVD will open only in low voltage situations. The battery connections are to be used for the battery only.

5.7. Programming Output Relays

Any alarm condition such as System High Voltage Alarm, Battery Discharge Alarm, or Rectifier 1 of n Alarm can be programmed to any of the eight output relays. Programming alarms to the output relays 1-6 will give a much better idea of what the failure is before actually visiting the site. Using the default programming, over twenty conditions could cause activate a minor relay. However, if you program Battery Discharge Alarm to Output Relay 1, you will know exactly what the alarm is just by knowing that output relay 1 is on. The network management card also displays the output relays individually and can be set up to e-mail these messages.

Output relay mapping options are Ignore, Major, Minor, and Output Relay 1-6. To program the alarm to an output relay find the alarm setup screen for the desired alarm from the table in Figure 5.5-1. The Ignore setting will not send an alarm to any display or relay. Programming the alarm to Major, Minor or Output Relay 1 will send the alarm to the relay output connector on the back of the plant, turn on the appropriate front panel LED, and will send the alarm to the network management card. Programming the alarm to Output Relay 2-6 will not send the alarm to the relay output connector on the back of the plant, but will turn on the front panel Out Relay LED, and will send the alarm to the network management card. For instance, go to the Batteries / Parameters screen and program Battery Discharge Alarm to Output Relay 1. When the battery discharge current goes above the default setting of 5 Amps, the alarm will come on, the Out Relay contact will energize, the front panel Out Relay LED will come on and the network management card will report Output Relay 1 is on.

Most alarms are originally assigned to a minor or major relay. Usually it is desirable to keep the minor and major assignments when programming to the output relays. To do this, go to the output relay-programming screen and map the relay back to the desired minor or major relay. For instance, go to the I/O / Output screen and program Relay 1 to Minor Relay. When the battery discharge current goes above the default setting of 5 Amps, the alarm will come on, the Out Relay contact will energize, the Out Relay LED will come on, and the network management card will report Output Relay 1 is on. In addition, the Minor Relay contact will energize, the front panel Minor LED will come on, and the network management card will report the Minor Relay is on. With this scheme of programming, you will know that you have a minor alarm and specifically that the batteries are discharging.

Out Relay 1-6 can be renamed using the Relay Alias setup screen. Each relay name can be up to sixteen characters in length. This name will not appear in the alarm summary, but will appear in the messages generated by the network management card. This can be used to give specific information on the exact nature of the active alarm. Using the example above, if you use the default programming, the message "A minor relay in the power plant has been activated." will be reported. Using the relay mapping and aliasing you could get the additional message "An output relay (1; Batt Discharge) for the power plant has been activated."

Preventive Maintenance is typically performed on a quarterly basis.

6.1. Equipment

1. 4-Digit Voltmeter.
2. Clamp-on Ampere Meter.
3. Standard Insulated tools.

6.2. Inspection

Environmental Inspection

1. Ensure the dc system environment is suitable for operation.
2. Ensure that there is sufficient clearance around the system for service.
3. Ensure that there is no sign of damage to the dc system.
4. Contact monitoring personnel or disable system alarms before servicing the unit. This will allow the unit to be serviced without creating false alarms.

System Visual and Safety Inspection



WARNING: Hazardous energy levels are present on bare conductors in the dc distribution connection area of the plant. Accidental shorting of distribution conductors can cause arcing and high currents that can cause serious burns or other physical harm. It is recommended that:

- Any jewelry, rings, or watches be removed while working on this equipment.
- Handles of all wrenches, screwdrivers, cutters, and pliers are insulated.

1. Ensure that the dc wiring is properly installed, sized, terminated, and identified.
2. Ensure that the ac wiring is properly installed, sized, terminated, and identified.
3. Ensure that the battery wiring is properly connected to the System.
4. Ensure that the dc output over-current protection devices are adequate for the size of wiring installed.
5. Ensure that the dc Positive is bonded to central office ground (- 48 volt system).
6. Note the resistance of the ground bond.
7. Note any currents flowing in the ground.
8. Record ambient temperature.
9. Verify that the battery polarity is correct.
10. If battery disconnect devices are present, note the following for each device:
 - a) DC voltage rating.
 - b) DC current rating
 - c) Interrupting Current Rating

Battery Visual and Safety Inspection

Check that the battery temperature probe is firmly attached to the battery.

Check the mechanical integrity of the battery framing, racking, or cabinet. Tighten where necessary.

If there is a battery disconnect device fitted, ensure that it is properly connected and protected.

1. Check the general appearance and cleanliness of the battery. Clean if necessary. Use only approved cleaning materials.

Visually inspect each cell for the following, and clean and neutralize if necessary. Document discrepancies on Site form accordingly.

- a. Cracks.
 - b. Case leaks.
 - c. Post-seal leaks.
 - d. Pressure relief valve leaks (VRLA only).
 - e. Case swelling (VRLA only).
 - f. Terminal corrosion and connector corrosion.
2. Check the torque of all battery inter-cell connector in accordance with specifications. Re-torque if necessary (annual only).
 3. Measure and record ambient temperature.

6.3. Test

System Voltage Test

1. Verify with a voltmeter directly attached to the dc bus that the system voltage is correct.
2. System voltage should also agree with the battery float voltage set up in the battery parameters section. Be sure to take into account the effects of temperature compensation and battery recharge current limit.

Rectifier Current Share Test

Verify that the highest rectifier current and the lowest current are within 5 A of each other.

System Current Test

Verify the System current equal to the total of the rectifier currents. System current should equal the total current of the loads as well as any battery current.

Rectifier Alarm Test

1. Verify that all of the rectifiers report RFA Alarm is off.
2. Remove 1 rectifier and verify that you get a Minor alarm for Rect 1 of n failure on the controller and the customer remote alarm panel.
3. Remove the second rectifier and verify that you get a Major alarm for Rect 2 of n failure on the controller and the customer remote alarm panel.
4. After the fan has completely stopped spinning, insert a plastic pen or plastic screwdriver into the fan blade of one of the rectifiers and reinsert both rectifiers
5. Verify that you get the fan fail alarm on controller and the customer remote alarm panel.
6. Remove the fan fail device.

System Temperature Test

Verify that the system temperature is correct.

Battery Current Test

1. Measure the battery current with a clamp-on meter.
2. Verify that the battery current is below 5 A.
3. Verify that the displayed battery current is within ± 5 A.
4. Determine the total battery capacity at the site:
Cells connected in series make up a string, and the capacity is determined by the capacity of a single cell.
Add Ah capacity for all strings connected in parallel.
5. Determine the Max. Batt. Recharge rate:
Divide Total battery capacity by 20 hours and enter it in the appropriate box on the Site Form.
6. Verify that the Max. Batt. Recharge rate is set to the calculated value.
7. Remove ac power to the rectifiers purposely causing the battery discharge alarm to come on.
8. Verify that the System Current is 0 ± 5 A.
9. Verify that the battery current is within 5 % of the system current recorded previously.
10. Restore ac power to the rectifiers.

Battery Temperature Test

If the battery temperature probe is used in this system, verify that the battery temperature is correct.

LVD Test

1. Ensure that the LVD parameters are set to proper values.
2. Record the LVD trip point.
3. To test the LVD function, set the LVD Trip to -56.00 Vdc.
4. The LVD should have dropped out (opened). Verify it by monitoring the voltage at the battery connection.
5. Verify that the LVD Open Alarm is registered on the controller and at the customer remote alarm panel.
6. Reset the LVD Trip to the original setting.
7. Verify that the LVD Open Alarm has been removed.

Battery Preventive Maintenance Procedure

The purpose of the preventive maintenance is to ensure that the battery is in good, working condition. The observations, measurements, and tests performed are designed to determine the “state of health” of the battery. It will also allow for the prediction of future performance and preempt possible failure.

1. Measure the float charge voltage.
 - a. At the power bay bus.
 - b. At the battery.
 - c. Reset voltage if necessary.
2. Measure the float current on each battery cable. If it is fluctuating, measure maximum and minimum.
3. Measure the ac ripple voltage at the battery.
4. Measure the float voltage of each cell or monoblock. Record the battery memory location allocated on the battery tester.
5. Perform a load test on each cell or monoblock and measure the internal cell resistance and inter-cell resistance of each cell or monoblock.
6. Ensure that all protective covers are replaced and that the battery is electrically non-hazardous to personnel that could be working in the vicinity

6.4. Final Inspection:

5. Verify that the interior and exterior of the system is clean and free from debris.
6. Ensure all wires connected and bolts are properly tightened.
7. Ensure the following the User, Service, and Calibration parameters are set properly on the controller (default settings are in parenthesis):

LVD

- LVD1 Trip
- LVD1 Reset

Battery Parameters

- Discharge Threshold
 - Float Voltage
 - Maximum Recharge
 - Compensation Method
8. Verify on the status menu that the system is functioning correctly with no alarms.
 9. Be sure to leave the site as orderly and neat as possible.

ALARM/ [MENU LOCATION]	DESCRIPTION	DEFAULT SETTINGS
Battery Discharge Alarm [Batteries/Parameters]	The battery discharge current exceeds the programmed battery discharge threshold.	Minor
Battery High Temp Alm [Batteries/Parameters]	The battery temperature exceeds the Battery High Temperature threshold.	Minor
Battery Low Temp Alm [Batteries/Parameters]	The Battery Temperature is below the battery Low Temperature threshold.	Minor
Battery LV Alm [Batteries/Parameters]	The dc output voltage is below the battery low voltage threshold.	Major
Circuit Breaker Alm 1 [Distribution/Breakers]	The top Circuit Breaker in the top shelf is tripped.	Major
Circuit Breaker Alm 2 [Distribution/Breakers]	The bottom Circuit Breaker in the top shelf is tripped	Major
Circuit Breaker Alm 3 [Distribution/Breakers]	The top Circuit Breaker in the bottom shelf is tripped.	Major
Circuit Breaker Alm 4 [Distribution/Breakers]	The bottom Circuit Breaker in the bottom shelf is tripped	Major
FUSE Alm 1 [Distribution/Fuses]	Any of Fuse 1 through 4 is blown.	Major
FUSE Alm 2 [Distribution/Fuses]	Any of Fuse 5 through 8 is blown.	Major
FUSE Alm 3 [Distribution/Fuses]	Any of Fuse 9 through 12 is blown.	Major
FUSE Alm 4 [Distribution/Fuses]	Any of Fuse 13 through 16 is blown.	Major
Hardware Batt Temp Alm [Batteries Parameters]	There is a hardware failure in the battery temperature monitoring function.	Minor
Hardware Sys Volt Alm [Power Modules/Rectifiers]	There is a hardware failure in the system voltage monitoring function.	Minor
Hardware Sys Temp Alm [System/DC Parameters]	There is a hardware failure in the system temperature monitoring function.	Minor.
System HT Alm [System/DC Parameters]	The System Temperature exceeds the system high temperature threshold. Not the same as battery temperature alarm.	Minor
System HV Alm [Power Modules/Rectifiers]	The System Voltage is above the System High Voltage threshold. Not the same as battery high voltage alarm.	Minor
Input Relay 1 [I/O/Input]	An external contact closure at the Input Relay 1 connection.	Ignore
•	•	•
•	•	•
•	•	•
Input Relay 4 [I/O/Input]	An external contact opening at the Input Relay 4 connection.	Ignore

ALARM/ [MENU LOCATION]	DESCRIPTION	DEFAULT SETTINGS
System LT Alm [System/DC Parameters]	The System Temperature is below the System Low Temperature threshold. Not the same as battery temperature alarm.	Minor
Low Voltage Alarm [Power Modules/Rectifiers]	The System Voltage is below the System Low Voltage threshold. Not the same as battery voltage alarm.	Minor
LVD Alarm [Batteries/LVD]	The controller opened the LVD. If unit has a battery LVD, no power will be available to turn on any Output Relays.	Major
User Output Relay 1 Alarm [I/O/Output]	Output Relay 1 Alarm can be “mapped” to activate other output relays (“Ignore” activates no additional relays).	Ignore
Rectifier 1-of-N Alm [Power Modules/Rectifiers]	Rectifier Fail 1-of-N alarm occurs. This is a special rectifier alarm group that signifies that one rectifier has at least one alarm condition.	Minor
Rectifier 2-of-N Alm [Power Modules/Rectifiers]	Rectifier Fail 2-of-N alarm occurs This is a special rectifier alarm group that signifies that more than one rectifier has at least one alarm condition.	Major
Rectifier Current Limit Alarm [Power Modules/Rectifiers]	A rectifier is in the current limited mode.	n of N
Rectifier Fan Fail Alm [Power Modules/Rectifiers]	A rectifier fan has failed.	n of N
Rectifier RFA Alarm [Power Modules/Rectifiers]	A rectifier output has failed.	n of N

The overall system specifications can vary, depending upon the number of rectifier modules. Note that some specification items are provided on a “per rectifier” basis and must be combined or totaled for a given system configuration.

8.1. AC Input

TWF0500H54B Rectifier

Input Voltage Range	85 – 264 Vac
AC Frequency Range	47 – 63 Hz
Apparent Power Factor	99% Typical, 98% Minimum
Input Current (per Rectifier)	5.5 A @ 115 Vac 3.7 A @ 230 Vac
Turn on Time	2 Seconds

Magnum VS 50 Power System

Input Voltage Range	85 – 264 Vac
AC Frequency Range	47 – 63 Hz
Apparent Power Factor	99% Typical, 98% Minimum
Input Current	27.5 A @ 115 Vac 18.5 A @ 230 Vac

Magnum VS 100 Power System

Input Voltage Range	85 – 264 Vac
AC Frequency Range	47 – 63 Hz
Apparent Power Factor	99% Typical, 98% Minimum
Input Current	55 A @ 115 Vac 37 A @ 230 Vac

8.2. DC Output

TWF0500H54B Rectifier

Output Voltage (factory set)	54.5 Vdc
Operating Voltage Range	44 – 58 Vdc
Efficiency	85% Typical
Over Voltage Protection	59.5 Vdc
Output Current per Rectifier	9.0 A Minimum Continuous at 115 Vac Input 10.5 A Minimum Continuous at 230 Vac Input.
Current Limit	9.3 A Maximum at 115 Vac Input 11.0 A Maximum at 230 Vac Input.
Power Output per Rectifier @ 54.5 Vdc	490 W Continuous at 115 Vac Input 570 W Continuous at 230 Vac Input

Magnum VS 50 Power System

Output Voltage (factory programmed)	54.0 Vdc
Operating Voltage Range	47 – 56.5 Vdc
Rated Output Current	50 A
Efficiency	85% Typical
Over Voltage Protection	59.5 Vdc
Output Current	45 A Minimum Continuous at 115 Vac Input 52.5 A Minimum Continuous at 230 Vac Input.
Current Limit	46.5 A Maximum at 115 Vac Input 55.0 A Maximum at 230 Vac Input.
Power Output @ 54.5 Vdc	2450 W Continuous at 115 Vac Input 2850 W Continuous at 230 Vac Input

Magnum VS 100 Power System

Output Voltage (factory programmed)	54.0 Vdc
Operating Voltage Range	47 – 56.5 Vdc
Rated Output Current	100 A
Efficiency	85% Typical
Over Voltage Protection	59.5 Vdc
Output Current	90 A Minimum Continuous at 115 Vac Input 105 A Minimum Continuous at 230 Vac Input.
Current Limit	93 A Maximum at 115 Vac Input 110 A Maximum at 230 Vac Input.
Power Output per Rectifier @ 54.5 Vdc	4900 W Continuous at 115 Vac Input 5700 W Continuous at 230 Vac Input

8.3. Controls and Indicators

TWF0500H54B Rectifier

Input Healthy LED	AC power present.
Output Healthy LED	DC output voltage between 39.5 to 59.5 Vdc.
Current Limit LED	On when rectifier is in current limit.
Overvolts LED	On when rectifier is above 57 Vdc. (Must be powered down to reset)

Magnum VS Controller

DC OK (Green)	On when voltage is between 50 and 57 Vdc.
Major (Red)	On when Major Relay is de-energized*
Minor (Yellow)	On when Minor Relay is energized
Out Relay 1 (Red)	On when Output Relay 1 is energized
(Flashing Green)	Watchdog LED

* Major relay is energized in normal operation. If all power fails, major relay will lose power and the contacts will change state, signifying an alarm.

8.4. Mechanical

TWF0500H54B Rectifier

Dimensions (Overall)	5 in (12.7 cm) high x 2.75 in (7 cm) wide x 10.5 in (26.7 cm) deep
Dimensions (not including faceplate or connectors)	5 in (12.7 cm) high x 2.5 in (6.3 cm) wide x 9.4 in (24 cm) deep
Weight	4 lb (1.8 kg)
Color	Black front, Yellow zinc sides and back
Mounting	Hot swappable. Secured with 2.5 mm captive screws

Magnum VS 50 Power System

Dimensions	5-1/4 in (13.3 cm) high x 17-1/4 in (43.8 cm) wide x 13 in (33 cm) deep
Weight	15 lb. (6.8 kg)
Color	Black Front, Yellow zinc sides and back
Mounting	19" Rack Mounting (23" Optional)

Magnum VS 100 Power System

Dimensions	10-1/2 in (26.6 cm) high x 17-1/4 in (43.8 cm) wide x 13 in (33 cm) deep
Weight	30 lb. (13.6 kg)
Color	Black Front, Yellow zinc sides and back
Mounting	19" Rack Mounting (23" Optional)

8.5. Environmental

Ambient Temperature	(Operating)	-40°C to +55°C (+65°C with reduced power output)
	(Storage)	-45°C to +85°C
Humidity	(Operating)	0 – 85% RH (non-condensing)
	(Storage)	0 – 95% RH (non-condensing)
Altitude	(Operating)	3000 m (9840 ft.)
	(Storage)	10000 m (39370 ft.)

8.6. Compliance

NEBS	Level 3 (Pending)
Safety	UL 60950 CE Marked to Low Voltage Directive (EN60950)
EMC	FCC Part 15 Class A EN55022 Class A, EN55024 EN61000-3-2, EN61000-3-3

8.7. Compliance

NEBS	Level 3 (Pending)
Safety	UL 60950 CE Marked to Low Voltage Directive (EN60950)
EMC	FCC Part 15 Class A EN55022 Class A, EN55024 EN61000-3-2, EN61000-3-3

8.8. Compliance

NEBS	Level 3 (Pending)
Safety	UL 60950 CE Marked to Low Voltage Directive (EN60950)
EMC	FCC Part 15 Class A EN55022 Class A, EN55024 EN61000-3-2, EN61000-3-3

Customer Support for this or any other APC product is available at no charge in any of the following ways:

Refer to the APC Web site to access documents in the APC Knowledge Base and to submit customer support requests.

- www.apc.com (Corporate Headquarters)
Connect to localized APC Web sites for specific countries, each of which provides customer support information.
- www.apc.com/support
Global support searching APC Knowledge Base and using e-support.

Contact an APC Customer Support center by telephone or e-mail.

Local, country-specific centers:

Go to www.apc.com/support/contact for information

Contact the APC representative or other distributor from whom you purchased your APC product for information on how to obtain local customer support.

Two Year Factory Warranty¹

The limited warranty provided by American Power Conversion (APC®) in this Statement of Limited Factory Warranty applies only to Products you purchase for your commercial or industrial use in the ordinary course of your business.

Terms of Warranty

APC warrants its products to be free from defects in materials and workmanship for a period of two years from the date of purchase. The APC obligation under this warranty is limited to repairing or replacing, at its sole discretion, any such defective products. This warranty does not apply to equipment that has been damaged by accident, negligence, or misapplication or has been altered or modified in any way. Repair or replacement of a defective product or part thereof does not extend the original warranty period. Any parts furnished under this warranty may be new or factory remanufactured.

Non-transferable Warranty

This warranty applies only to the original purchaser who must have properly registered the product. Product may be registered at www.apc.warranty.com.

Exclusions

APC shall not be liable under the warranty if its testing and examination disclose that the alleged defect in the product does not exist or was caused by end user or any third person misuse, negligence, improper installation or testing. Further APC shall not be liable under the warranty for unauthorized attempts to repair or modify wrong or inadequate electrical voltage or connection, inappropriate on-site operation conditions, corrosive atmosphere, repair, installation, start-up by non-APC designated personnel, a change in location or operating use, exposure to the elements, Acts of God, fire, theft, or installation contrary to APC recommendations or specifications or in any event if the APC serial number has been altered, defaced, or removed, or any other cause beyond the range of the intended use.

THERE ARE NO WARRANTIES, EXPRESS OR IMPLIED, BY OPERATION OF LAW OR OTHERWISE, OF PRODUCTS SOLD, SERVICED OR FURNISHED UNDER THIS AGREEMENT OR IN CONNECTION HEREWITH. APC DISCLAIMS ALL IMPLIED WARRANTIES OF MERCHANTABILITY, SATISFACTION, AND FITNESS FOR A PARTICULAR PURPOSE. APC EXPRESS WARRANTIES WILL NOT BE ENLARGED, DIMINISHED, OR AFFECTED BY AND NO OBLIGATION OR LIABILITY WILL ARISE OUT OF, APC RENDERING OF TECHNICAL OR OTHER ADVICE OR SERVICE IN CONNECTION WITH THE PRODUCTS. THE FOREGOING WARRANTIES AND REMEDIES ARE EXCLUSIVE AND IN LIEU OF ALL OTHER WARRANTIES AND REMEDIES. THE WARRANTIES SET FORTH ABOVE CONSTITUTE APC SOLE LIABILITY AND PURCHASER'S EXCLUSIVE REMEDY FOR ANY BREACH OF SUCH WARRANTIES. APC WARRANTIES RUN ONLY TO PURCHASER AND ARE NOT EXTENDED TO ANY THIRD PARTIES.

IN NO EVENT SHALL APC, ITS OFFICERS, DIRECTORS, AFFILIATES OR EMPLOYEES BE LIABLE FOR ANY FORM OF INDIRECT, SPECIAL, CONSEQUENTIAL OR PUNITIVE DAMAGES, ARISING OUT OF THE USE, SERVICE OR INSTALLATION, OF THE PRODUCTS, WHETHER SUCH DAMAGES ARISE IN CONTRACT OR TORT, IRRESPECTIVE OF FAULT, NEGLIGENCE OR STRICT LIABILITY OR WHETHER APC HAS BEEN ADVISED IN ADVANCE OF THE POSSIBILITY OF SUCH DAMAGES. SPECIFICALLY, APC IS NOT LIABLE FOR ANY COSTS, SUCH AS LOST PROFITS OR REVENUE, LOSS OF EQUIPMENT, LOSS OF USE OF EQUIPMENT, LOSS OF SOFTWARE, LOSS OF DATA, COSTS OF SUBSTITUANTS, CLAIMS BY THIRD PARTIES, OR OTHERWISE.

NO SALESMAN, EMPLOYEE, OR AGENT OF APC IS AUTHORIZED TO ADD TO OR VARY THE TERMS OF THIS WARRANTY. WARRANTY TERMS MAY BE MODIFIED, IF AT ALL, ONLY IN WRITING SIGNED BY AN APC OFFICER AND LEGAL DEPARTMENT.

^{10.1.}

Warranty Claims

Customers with warranty claims issues may access the APC worldwide customer support network by referring to the APC Web site, www.apc.com. Select your country from the country selection pull-down menu. Open the Support tab at the top of the web page to obtain contact information for customer support in your region.

¹ To determine which factory warranty applies to the APC product you purchased, consult the factory warranties located on the APC Web site, www.apc.com/products.

Free Manuals Download Website

<http://myh66.com>

<http://usermanuals.us>

<http://www.somanuals.com>

<http://www.4manuals.cc>

<http://www.manual-lib.com>

<http://www.404manual.com>

<http://www.luxmanual.com>

<http://aubethermostatmanual.com>

Golf course search by state

<http://golfingnear.com>

Email search by domain

<http://emailbydomain.com>

Auto manuals search

<http://auto.somanuals.com>

TV manuals search

<http://tv.somanuals.com>