



SpeedDome Ultra VII Day/Night Camera Dome

**RAS917LS
RAS917LS-1
RAS917WLS
RAS917WLS-1**

Configuration Utility Operator's Manual

8200-0184-04 D

SpeedDome[®] Ultra VII Day/Night Camera Dome

Configuration Utility Operator's Manual

Version - 0710-0147-0107

EQUIPMENT MODIFICATION CAUTION

Equipment changes or modifications not expressly approved by Sensormatic Electronics Corporation, the party responsible for FCC compliance, could void the user's authority to operate the equipment and could create a hazardous condition.

FCC COMPLIANCE

This equipment has been tested and complies with the limits for a Class A digital device, according to Part 15 of the FCC Rules. These limits provide reasonable protection against harmful interference when the equipment operates in a commercial environment. This equipment generates, uses, and can radiate radio frequency energy, and, if not installed and used according to these instructions, may cause harmful interference to radio communications.

Operation of this equipment in a residential area is likely to cause harmful interference. If this equipment is used in a residential area, users must correct the interference at their own expense.

LIMITED RIGHTS NOTICE

For units of the Department of Defense, all documentation and manuals were developed at private expense and no part of it was developed using Government Funds. The restrictions governing the use and disclosure of technical data marked with this legend are set forth in the definition of "limited rights" in paragraph (a) (15) of the clause of DFARS 252.227.7013. Unpublished - rights reserved under the Copyright Laws of the United States.

SOFTWARE LICENSE AGREEMENT

A Software License Agreement appears in Appendix S of this manual. Please read it carefully. Using the SpeedDome Ultra VII Camera Dome Configuration Utility software indicates that you accept the terms and conditions of this agreement.

NOTICE

The information in this manual was current when published. The manufacturer reserves the right to revise and improve its products. All specifications are therefore subject to change without notice.

© Copyright 2003 Sensormatic Electronics Corporation

Under copyright laws, the contents of this manual may not be copied, photocopied, reproduced, translated or reduced to any electronic medium or machine-readable form, in whole or in part, without prior written consent of Sensormatic Electronics.

American Dynamics and *SpeedDome* are trademarks or registered trademarks of Sensormatic Electronics Corporation. Product names mentioned herein may be trademarks or registered trademarks of other companies.

Thank you for using American Dynamics products. We support our products through an extensive and worldwide network of dealers. The dealer, through whom you originally purchased this product, is your point of contact if you have a need for service or support. Our dealers are fully empowered to provide the very best in customer service and support. Dealers should contact American Dynamics at (800) 507-6268 or (561) 912-6259, or on the web at www.americandynamics.net.

TABLE OF CONTENTS

PREFACE: BEFORE YOU BEGIN	V
What's In This Manual?	vi
Text Conventions	vii
Related Documents	vii
Getting Help	vii
CHAPTER 1: USING THE DOME CONFIGURATION UTILITY	1-1
What is the Dome Configuration Utility?	1-2
Starting the Dome Configuration Utility	1-2
Working with the Dome Configuration Utility	1-3
Entering the Dome's Password.....	1-3
Restoring Factory Settings.....	1-4
Exiting the Configuration Utility	1-5
Accessing the Quick Set Menu	1-5
Where To Go Next.....	1-7
Keeping Records for the Dome's Settings	1-8
CHAPTER 2: CONFIGURING PAN, TILT, ZOOM, AND SYNCHRONIZATION OPTIONS	2-1
Overview of Pan / Tilt / Zoom/Synchronization Options Screen.....	2-2
Setting the Automatic "Flip" Feature	2-2
Adjusting the Zoom Stop Settings.....	2-3
Configuring the Line Lock Setting	2-4
Configuring the Freeze Frame Setting	2-5
Configuring Auto Iris/Auto Focus Resume Settings	2-6
What To Do Next	2-7
CHAPTER 3: CONFIGURING CAMERA FEATURES	3-1
Overview of Camera Settings	3-1
Adjusting White Balance Settings	3-2
Understanding How IR (Black & White) Mode Operates.....	3-3
Understanding Wide Dynamic Range.....	3-5
Working with AGC and Open Shutter Settings.....	3-7
What To Do Next	3-10
CHAPTER 4: CONFIGURING ALARMS, AREAS, HOME, PRIVACY SETTINGS, PRESETS AND SCAN LIMITS	4-1
Overview of Alarms, Areas, Home, North Position, Preset, Privacy and Scan Limit Settings	4-2
Configuring Alarm Actions.....	4-3
Configuring Normal Input States for Alarms.....	4-5
Assigning the Dome's Home Position	4-6
Setting the North Position	4-8
Programming Area Boundaries.....	4-9
Establishing Privacy Zones	4-11
Programming Presets	4-16
Establishing Scan Limits	4-17
What To Do Next	4-20
CHAPTER 5: CONFIGURING TEXT DISPLAYED ON-SCREEN	5-1
Overview of On-Screen Text Display Settings	5-1
Displaying or Hiding Status Information	5-2
Displaying or Hiding All Name Information.....	5-3
Displaying Diagnostic Tests During Reset	5-4
Displaying Direction Indicators.....	5-5
Configuring the Display of Name Information.....	5-6
Assigning or Changing Name Information.....	5-7
Changing the Settings for Text Displayed On-Screen.....	5-9
What To Do Next	5-11
CHAPTER 6: CONFIGURING LANGUAGE AND PASSWORD SETTINGS	6-1
Overview of Language and Password Settings.....	6-1
Selecting a Language for Dome Messages and Prompts	6-2
Setting and Enabling the Dome Password.....	6-3
What To Do Next	6-4

CHAPTER 7: DISPLAYING DOME INFORMATION	7-1
Understanding the Dome Information Screen	7-1
Viewing Dome Operating Statistics	7-2
What To Do Next.....	7-3
APPENDIX A: SENSORNET AND RS-422 COMMAND SUMMARY	A-1
Command Summary	A-2
Supported Controllers and Matrix Switching Systems.....	A-3
Performance Notes	A-6
APPENDIX B: MANCHESTER COMMAND SUMMARY	B-1
Command Summary	B-2
Supported Controllers	B-4
Performance Notes	B-4
APPENDIX C: PELCO COAXITRON AND "P" PROTOCOLS COMMAND SUMMARY	C-1
Supported SpeedDome Ultra VII Features.....	C-2
Pelco Command Summary	C-3
Performance Notes	C-4
Tested Pelco Equipment	C-4
Supported Pelco Features	C-4
APPENDIX D: PANASONIC UP-THE-COAX (UTC) PROTOCOL COMMAND SUMMARY	D-1
Supported SpeedDome Ultra VII Day/Night Features	D-2
Panasonic UTC Command Summary	D-3
Performance Notes	D-4
Programming Presets	D-4
Tested Panasonic Equipment	D-5
APPENDIX E: AD UP-THE-COAX (UTC) COMMAND SUMMARY	E-1
Command Summary	E-2
Supported Controllers	E-4
Performance Notes	E-4
APPENDIX F: VICON COMMAND SUMMARY	F-1
Supported SpeedDome Ultra VII Features.....	F-1
Vicon Command Summary	F-2
Operating the Dome Configuration Menu.....	F-3
Setting Left and Right Auto Pan Scan Limits	F-4
Wiring Configurations	F-5
Tested Vicon Equipment	F-6
APPENDIX R: DOME CONFIGURATION RECORDS.....	R-1
Configuration Settings.....	R-2
<i>Pan / Tilt / Zoom / Sync Options</i>	R-2
<i>Camera Functions</i>	R-2
<i>Set Alarm Actions</i>	R-2
<i>Set Alarm States</i>	R-2
<i>Set Home Position</i>	R-2
<i>Set North Position</i>	R-3
<i>Area Boundaries</i>	R-3
<i>Privacy Zones</i>	R-3
<i>Scan Limits</i>	R-3
<i>On-Screen Text Display</i>	R-3
<i>Text Attribute Options</i>	R-4
<i>Language Password</i>	R-4
<i>Name Configuration</i>	R-4
<i>Presets</i>	R-5
<i>Dome Information</i>	R-7
APPENDIX S: SOFTWARE LICENSE AGREEMENT	S-1
SPEEDDOME ULTRA VII GLOSSARY	
INDEX	

P R E F A C E

Before You Begin

This preface provides important information that you should be familiar with before using the SpeedDome Ultra VII Day/Night camera dome. It includes a document overview, text conventions, a list of related documents, and how to obtain product help.

In This Preface

- What's In This Manual?..... vi
- Text Conventions vii
- Related Documentsvii
- Getting Help.....vii

What's In This Manual?

The SpeedDome Ultra VII Day/Night Camera Dome Configuration Utility Operator's Manual is organized as follows:

- **Chapter 1, Using the Dome Configuration Utility**, describes how to use the SpeedDome Ultra VII Day/Night Camera Dome configuration utility.
- **Chapter 2, Configuring Pan, Tilt, Zoom, and Synchronization Options**, describes how to set the “flip” feature, zoom stop, line lock, and Freeze Frame settings.
- **Chapter 3, Configuring Camera Features**, describes how to configure camera settings to improve color and low-light performance.
- **Chapter 4: Configuring Alarms, Areas, Home, Privacy Settings, Presets and Scan Limits**, describes how to configure settings associated with alarm inputs, the home position, and the North setting. In addition, you can also set the boundaries for up to 16 areas, establish left and right scan limits, as well as program presets and Privacy Zones.
- **Chapter 5, Configuring Text Displayed On-Screen**, describes how to configure settings associated with displaying text on-screen. This includes names and status information, as well as the text format and direction indicators.
- **Chapter 6, Configuring Language and Password Settings**, describes how to set the language for the menus and prompts. It also describes how to set and enable a password to prevent unauthorized use of the configuration utility.



IMPORTANT

If Portuguese is the selected language, the characters “ã” and “õ ” are not available for display on-screen. This is due to a limitation of the dome’s text overlay chip.

-
- **Chapter 7, Displaying Dome Information**, explains how to display essential information about your dome if service should be required.
 - **Appendix A, SensorNet and RS-422 Command Summary**, provides information about commands specific to using the dome in a SensorNet or RS-422 environment.
 - **Appendix B, Manchester Command Summary**, provides information about commands specific to using the dome in a Manchester environment.
 - **Appendix C, Pelco Coaxitron and P Protocol Command Summary**, provides information about features and commands supported by Pelco Coaxitron and “P” protocols.
 - **Appendix D, Panasonic Up-the-Coax (UTC) Protocol Command Summary**, provides information about features and commands supported by Panasonic UTC protocol.
 - **Appendix E: AD Up-the-Coax (UTC) Protocol Command Summary**, provides information about features and commands supported by AD UTC protocol.
 - **Appendix F: Vicon Protocol Command Summary**, provides information about features and commands supported by Vicon protocol.
 - **Appendix R, Dome Configuration Records**, provides a convenient place for listing the configuration information associated with your camera dome.
 - **Appendix S, Software License Agreement**, lists the terms and conditions for using this product.

Text Conventions

This book uses text in different ways to identify different kinds of information.

- Bold Italics*** Used for terms specific to the system, and text that requires special emphasis, for example *Preset*.
- Italics* Used for menu selections or settings, for example, *On-screen Text Display*.
- Bold** Used for names of buttons, for example, **Zoom**.

Notes are separated by ruled lines. Notes call attention to any items that may be of special importance. Icons identify the type of note.



General information



Tips for using the product more effectively



Important information essential to proper operation of the product

Related Documents

Other sources provide supplemental information about your SpeedDome Ultra VII Day/Night Camera Dome. These sources serve to enhance your understanding of the product and its use.

- The *SpeedDome Ultra VII Day/Night Camera Dome Configuration Utility Quick Reference Guide* (8200-0184-05) provides a brief overview of how to use the configuration utility.
- The *SpeedDome Ultra VII Camera Dome Installation and Service Guide* (8200-0184-01) provides specific information about the wiring and physical set up of the camera dome.

Getting Help

If you have a question about the operation of this product and cannot find the answer in this manual, consult with your supervisor. If your supervisor cannot answer your question, contact your Sales Representative.

NOTES :

CHAPTER 1

Using the Dome Configuration Utility

The SpeedDome Ultra VII Day/Night camera dome is a 23X optical zoom camera enclosed in a compact dome housing. It provides a black-and-white mode to enhance images obtained under low lighting conditions. It also supports Wide Dynamic Range (WDR), which improves video performance under simultaneous indoor and outdoor lighting conditions—such as looking through an open door or window. In addition, the camera dome supports advanced features such as 10X digital zoom (up to 230X total zoom), open shutter settings, privacy zones, direction indicators, and freeze frame. The Dome Configuration Utility is used to customize the camera dome's settings.

This chapter introduces you to the Dome Configuration Utility. It explains how to start the utility, navigate through the menus, and change settings. It also explains where to find specific information about customizing dome settings.

In This Chapter

- What is the Dome Configuration Utility? 1–2
- Starting the Dome Configuration Utility 1–2
- Working with the Dome Configuration Utility 1–3
- Entering the Dome's Password 1–3
- Restoring Factory Settings 1–4
- Exiting the Configuration Utility 1–5
- Accessing the Quick Set Menu 1–5
- Where To Go Next 1–7
- Keeping Records for the Dome's Settings 1–8

What is the Dome Configuration Utility?

The Dome Configuration Utility provides a means to setting features for your camera dome via a text overlay menu. You access this utility using a keystroke combination on your camera controller. The utility provides settings relating to camera functions, alarms, text display, privacy zones, direction indicators and password protection. Some items supplement similar features that may be available through your controller.

Refer to your controller operating instructions for information about button locations mentioned in this document.

Starting the Dome Configuration Utility

The Dome Configuration Utility is started using a series of keyboard commands. Depending on the controller and network protocol in use, the commands required to start the configuration utility differ.

- If the dome is installed in a *SensorNet* or *RS-422* environment, press and hold **Iris Open**, press and hold a **Focus** button (**near** or **far**), then press **Zoom Out**.
- If the dome is installed in a *Manchester* environment, place the controller in programming mode (turn the keyswitch to **Prog** or disable the lock), enter **66**, and press **Set Preset (Set Shot)**.



Note: Other protocols and controllers may be supported. The Appendixes located at the end of this manual provide additional information.

The following menu appears on the monitor:

```
DOME CONFIGURATION MENU
PAN/TILT/ZOOM/SYNC OPTS
CAMERA FUNCTIONS
ALARMS/AREAS/PRESETS/PZ
ON-SCREEN TEXT DISPLAY
LANGUAGE / PASSWORD
DOME INFORMATION
RESET TO FACTORY SETTINGS
QUIT WITHOUT SAVING
EXIT AND SAVE CHANGES
```



IMPORTANT

If you have password protection enabled for the configuration utility, the **Enter Password** screen appears first. You must correctly enter the password before the **Dome Configuration Menu** will appear. For information about entering the password, refer to *Entering the Dome's Password* on page 1–3.

Working with the Dome Configuration Utility

Once the *Dome Configuration Menu* is displayed, you may select a menu item, and then modify the settings you want to change. The following table summarizes the controller commands for *SensorNet*, *RS-422*, and *Manchester* protocols. For combination keystrokes, press and hold each button in sequence, then release.

If you want to ...	Use ...
Move the <i>highlight bar</i> .	Pan/Tilt
<i>Select</i> the highlighted item on the screen.	Focus
<i>Increase</i> the value of the selected setting or display the <i>next choice</i> for the setting	Zoom In
<i>Decrease</i> the value of the selected field, or display the <i>previous choice</i> for the field.	Zoom Out
During naming, move the cursor to the <i>right</i> of the current character in the name.	Zoom In
During naming, move the cursor to the <i>left</i> of the current character in the name.	Zoom Out
Save changes and exit the utility from any screen.	Iris Close , then Focus

Entering the Dome's Password

A dome password can be used to prevent unauthorized users from starting the configuration utility. If password protection is enabled the **Enter Password** screen appears when the command to start the configuration utility is entered.

ENTER PASSWORD
PASSWORD: *****

A B C D E F G H I J K L M N O P Q R S T
U V W X Y Z a b c d e f g h i j k l m n
o p q r s t u v w x y z 0 1 2 3 4 5 6
7 8 9 / -

CONTINUE
CANCEL

Blank Space Character

Users must enter the password before the Dome Configuration Menu displays. The password may be from *1 to 8 characters* long.

To enter the password using SensorNet, RS-422, or Manchester protocols:

1. Use the **Pan/Tilt** control to move the highlight the appropriate character.
2. Press **Focus** to enter the highlighted character.

If you need to change a character that has been entered:

- **Zoom In** moves the cursor to the right in the **Password** field.
- **Zoom Out** moves the cursor to the left in the **Password** field.

As each character in the password is selected, asterisks (*) appear in the **Password** field. When you have finished entering the password, select **Continue**. If the correct password has been entered, the **Dome Configuration Menu** appears. If the correct password was not entered, the **Enter Password** screen remains on the monitor.

If you do not want to start the configuration utility, select **Cancel** to return to normal dome operation.



IMPORTANT

If you forget the password, contact your Sales Representative for assistance.

For information about programming and enabling password protection, see **Chapter 6**.

Restoring Factory Settings

Some screens provide a choice to *restore factory settings*. This choice applies only to those settings currently displayed on the screen. To reset all configuration settings, choose **Reset to Factory Settings** from the **Dome Configuration Menu**. The following prompt appears:

Reset to Factory Settings

No

Press **Zoom** to display the options.

- If you want to restore the factory settings, select **Yes**.
- If you do not want to restore the factory settings, select **No**.

Press **Focus** to accept the displayed option.



IMPORTANT

Selecting **Reset to Factory Settings** from the **Dome Configuration Menu** does not change the following settings: *Camera Name, Alarm Names, Area Names, Preset Names, Pattern Names, Area Boundaries, Privacy Zones, and Presets*. To reset names to the default settings, see **Chapter 5: Configuring Text Displayed On-Screen**.

Exiting the Configuration Utility

Under SensorNet, RS-422, and Manchester protocols, you may save your changes and exit the utility from any screen by pressing and holding **Iris Close**, then pressing **Focus**. From the *Dome Configuration Menu*, you have two choices for exiting the utility: **Exit and Save Changes** or **Quit Without Saving**. Use the **Pan/Tilt** control to move the highlight bar up and down on the screen.

- If you want to keep the changes you made, move the highlight bar to **Exit and Save Changes**, and select. The utility closes.
- If you want to exit without making changes, move the highlight bar to **Quit Without Saving**, and select. The following prompt appears on the screen:

Data Not Saved. Quit Anyway?

No

Press **Zoom** to display the options.

- To cancel the changes, select **Yes**.
- To keep the changes, select **No**. If you choose **No**, the *Dome Configuration Menu* is displayed.

Press **Focus** to accept the displayed option.



IMPORTANT

The following settings do not restore when selecting *Quit Without Saving* from the *Dome Configuration Menu*: **Area Boundaries** and **AGC/Shutter Limit**.

Accessing the Quick Set Menu

SpeedDome Ultra VII Day/Night provides a Quick Set Menu for commonly used features and functions when used with compatible controllers. This allows you to change or activate features without starting the dome configuration menu. Two pages of menu options are available.

0	TOGGLE QUICK SET MENU
1	DOME CONFIG MENU
2	AUTO IRIS/AUTO FOCUS
3	FLIP
4	PEEL PATTERN
10	NIGHT MODE
11	DAY MODE
12	AUTO DAY/NIGHT MODE
13	WDR ON
14	WDR OFF
FOCUS FAR = next page	

15	SMOOTH SCAN
16	STEPPED SCAN
17	RANDOM SCAN
20	DOME INFORMATION
FOCUS NEAR = previous page	

To access a feature on the menu, enter the number and press the Quick Set button (varies by controller). To display the different pages of the menu, press **Focus Far** or **Focus Near**. The following table provides a description of the available options.

Quick Set Command	Description
0+ Quick Set	Toggles between displaying and hiding the quick set menu.
1+ Quick Set	Displays the SpeedDome Ultra configuration menu. Refer to the dome manual for information about the available settings.
2+ Quick Set	Resumes Auto Focus/Auto Iris mode.
3+ Quick Set	Rotates the SpeedDome 180° from its current pointing direction. This is the same as pressing the Flip button on controllers with that feature.
4+ Quick Set	Runs the default Apple Peel Pattern continuously.
10+ Quick Set	Sets the dome IR mode setting to ON. The dome switches to full-time black-and-white (B/W) mode.
11+ Quick Set	Sets the dome IR mode setting to OFF. The dome switches to full-time color mode.
12+ Quick Set	Resumes the most recently selected automatic IR mode setting. <ul style="list-style-type: none"> • Auto High: B/W mode activates ~30 lux. • Auto Mid: B/W mode activates ~3 lux. • Auto Low: B/W mode activates ~.5 lux
13+ Quick Set	Enables Wide Dynamic Range (WDR). Use this setting when both bright and low light areas need to be viewed simultaneously.
14+ Quick Set	Disables Wide Dynamic Range (WDR). Use this setting when the light level is constant or changes in lighting conditions are gradual.
15+ Quick Set	Initiates a smooth scan between the left and right scan limits, starting at the left scan limit. If no scan limits have been set, initiates a smooth 360° clockwise rotation around the dome axis using the current tilt, zoom and focus settings.
16+ Quick Set	Initiates a scan between the left and right scan limits pausing briefly every 10° (at 1x zoom), starting at the left scan limit. When the right scan limit is reached, the scan is reversed. If no scan limits have been set, initiates a clockwise rotation around the dome axis pausing briefly every 10° (at 1x zoom) for 3 seconds using the current tilt, zoom and focus settings.
17+ Quick Set	Initiates a scan between the left and right scan limits pausing randomly between the limits. If no scan limits have been set, initiates a clockwise or counter-clockwise rotation around the dome axis using the current tilt, zoom and focus settings. The dome pauses randomly as it rotates around the axis.
20+ Quick Set	Displays the Dome Information screen available through the dome configuration menu.

Refer to your controller instructions to determine if the Quick Set Menu is supported.

Where To Go Next

Now that you understand how to start and work with the Dome Configuration Utility, you are ready to begin changing the settings for your dome. Use the following chart to determine which chapters you should use next.

Chapter	Topics Covered
<i>Chapter 2: Configuring Pan, Tilt, Zoom, and Synchronization Options</i>	<ul style="list-style-type: none"> – Set the “flip” feature to rotate the dome 180° – Set the first zoom stop (23X or 35X) and maximum zoom (up to 230X) – Set line lock to prevent vertical rolling when switching between cameras
<i>Chapter 3: Configuring Camera Features</i>	<ul style="list-style-type: none"> – Enable automatic or manual White Balance settings (red and blue values) – Configure IR (black-and-white) mode settings – Enable Wide Dynamic Range – Set the open shutter options to improve camera performance in low light situations – Enable automatic or manual Gain settings and set maximum gain values
<i>Chapter 4: Configuring Alarms, Areas, Home, Privacy Settings and Presets</i>	<ul style="list-style-type: none"> – Set alarm actions to initiate a preset, pattern, or no action when alarm conditions are detected – Configure normal input states for alarms to be open or closed – Send input states to host controller – Set a “home” position for dome – Establish a North position for use with the direction indicators – Program Privacy Zones to prevent operators from viewing restricted areas – Program area boundaries – Program presets
<i>Chapter 5: Configuring Text Displayed On-Screen</i>	<ul style="list-style-type: none"> – Display or hide dome status information – Display or hide camera, preset, pattern, area or alarm name information – Display diagnostic information or “splash” screen during dome reset – Display direction indicators – Assign names to camera, presets, patterns, areas, and alarms – Reset all names to factory defaults – Set text attributes (outline and translucent characters)

Chapter	Topics Covered
<i>Chapter 6: Configuring Language and Password Settings</i>	<ul style="list-style-type: none"> – Choose the language for the menus and prompts – Set a password to limit access to the Dome Configuration Utility – Enable or disable password protection
<i>Chapter 7: Displaying Dome Information</i>	<ul style="list-style-type: none"> – Display dome version information – Display dome performance statistics
<i>Appendix A: SensorNet and RS-422 Command Summary</i>	<ul style="list-style-type: none"> – Summarizes the controller commands available for SensorNet/RS-422
<i>Appendix B: Manchester Command Summary</i>	<ul style="list-style-type: none"> – Summarizes the controller commands available for Manchester – Performance limitations for Manchester
<i>Appendix C: Pelco Coaxitron and “P” Protocols Command Summary</i>	<ul style="list-style-type: none"> – Summarizes the controller commands available for Pelco Coaxitron and “P” protocols – Performance limitations for Coaxitron and “P” protocols
<i>Appendix D: Panasonic Up-the-Coax Command Summary</i>	<ul style="list-style-type: none"> – Summarizes the controller commands available for Panasonic UTC protocol – Performance limitations for UTC protocol
<i>Appendix E: AD Up-the-Coax Command Summary</i>	<ul style="list-style-type: none"> – Summarizes the controller commands available for AD-UTC protocol
<i>Appendix F: Vicon Protocol Command Summary</i>	<ul style="list-style-type: none"> – Summarizes the controller commands available for Vicon protocol
<i>Appendix R: Dome Configuration Records</i>	<ul style="list-style-type: none"> – Lists the default dome settings – Provide space for documenting changes to settings
<i>Appendix S: Software License Agreement</i>	<ul style="list-style-type: none"> – Lists the terms and conditions for using this product

Keeping Records for the Dome's Settings

Keep records for each SpeedDome Ultra VII Day/Night camera dome installed at your facility. ***Appendix R: Dome Configuration Records*** summarizes the default values for each configuration setting. Space is provided for documenting the settings you change. Note any changes you make to the dome settings.

CHAPTER 2

Configuring Pan, Tilt, Zoom, and Synchronization Options

This chapter describes the use of the **Pan/Tilt/Zoom/Sync Opts** menu. Use this screen to set the *Auto Flip* feature, configure the *Zoom Stop* settings, set the *Line Lock* option, and configure the *Freeze Frame* setting.

In This Chapter

- Overview of Pan / Tilt / Zoom/Synchronization Options Screen 2-2
- Setting the Automatic “Flip” Feature..... 2-2
- Adjusting the Zoom Stop Settings 2-3
- Configuring the Line Lock Setting 2-4
- Configuring the Freeze Frame Setting 2-5
- Configuring Auto Iris/Auto Focus Resume Settings..... 2-6
- What To Do Next 2-7

Overview of Pan / Tilt / Zoom/Synchronization Options Screen

When **Pan/Tilt/Zoom/Sync Opts** is selected from the *Dome Configuration Menu*, the following screen appears:

PAN/TILT/ZOOM/SYNC OPTS	
PROPORTIONAL FLIP	OFF / ON
1ST ZOOM STOP X	35 / 23
MAX TOTAL ZOOM X	46 . . . 230
LINE LOCK	ON / OFF
FREEZE FRAME	OFF / ON
I / F RETURN TO AUTO	OFF / ON / IRIS / FOCUS
RESET TO FACTORY SETTINGS	
EXIT	

Use this screen to enable or disable the “automatic flip” feature, configure the zoom stop settings, and set the line lock options.

- To change the settings, move the highlight bar to appropriate field and make the changes.
- To change the settings for this screen to the factory defaults, select **Reset to Factory Settings**.
- To return to the *Dome Configuration Menu*, select **Exit**.

Setting the Automatic “Flip” Feature

Use the automatic (proportional) “flip” feature when you need to track someone who walks directly under the dome and continues on the other side. You start the flip by moving the tilt control to its lower limit and holding for a brief period. When the flip engages, the dome automatically rotates 180°. You may then continue to track the person as long as the tilt control stays in its lower limit. Once the tilt control is released, the dome resumes normal operation.

The dome is initially installed with the automatic flip feature disabled. In this situation, the dome stops when the tilt down reaches its lower limit.

Changing the Automatic Flip Setting

1. Select *Pan/Tilt/Zoom/Sync Opts* from the *Dome Configuration Menu*.
The highlight bar appears on the **Proportional Flip** setting.
2. Change the setting.
 - Select **On** to enable the flip feature.
 - Select **Off** to disable the flip feature.

The default setting is Off.
3. Select **Exit**. The *Dome Configuration Menu* appears. Continue with **What To Do Next** on page 2–7.

Adjusting the Zoom Stop Settings

The SpeedDome Ultra VII Day/Night dome includes a **23X** optical zoom camera with **10X** digital zoom capability. The maximum possible zoom is **230X**. *Zoom stop settings* define how the zoom function is partitioned. Depending on the current zoom level, the camera will either stop at the first zoom stop setting or continue to the maximum zoom setting. The following example explains how zoom stop settings work.

The default camera settings are **35X** for the first zoom stop setting and **92X** for the maximum zoom setting. If the current zoom level is less than 35X, pressing **Zoom In** continuously causes the zoom to stop at 35X. If the zoom level is 35X or greater, pressing **Zoom In** continuously causes the zoom to stop at the maximum zoom setting of 92X. The second zoom stop remains in effect until the zoom function is reduced to less than the first zoom stop setting (35X) and the zoom button is released for one second or longer. To achieve higher zoom levels, change the maximum zoom setting.

2X is the margin of error for the zoom stop settings.

Changing the Zoom Stop Settings

1. Select *Pan/Tilt/Zoom/Sync Opts* from the *Dome Configuration Menu*.
2. To change the first zoom stop, continue with step 3. To change the maximum zoom setting, continue with step 5.
3. Move the highlight bar to **1st Zoom Stop X**. Change the setting.
 - Select **23** to set the first zoom stop to 23X magnification.
 - Select **35** to set the first zoom stop to 35X magnification.

The default setting is 35X.
4. To change the maximum zoom setting, continue with step 5. Otherwise, continue with step 6.
5. Move the highlight bar to the **Max Total Zoom X** setting. Change the value of the setting.
 - The values for the setting are: **46, 69, 92, 115, 138, 161, 184, 207, and 230X** magnification.

The default setting is 92X.
6. Select **Exit**. The *Dome Configuration Menu* appears. Continue with *What To Do Next* on page 2–7.

Configuring the Line Lock Setting

Use the **Line Lock** setting to prevent vertical rolling or adjust the appearance of overlay text on color monitors.

If you experience problems with vertical video rolling when switching multiple cameras to a single monitor, enabling the **Line Lock** setting phase locks the video with the AC power line. All cameras connected to the same power supply will be synchronized. This synchronization prevents the video from rolling vertically when cameras are switched.

With the Line Lock disabled, the appearance of text displayed on color monitors may be improved. However, the video will no longer be phase locked with the AC power line. Video may roll vertically when switching between cameras.

Changing the Line Lock Setting

1. Select *Pan/Tilt/Zoom/Sync Opts* from the *Dome Configuration Menu*.
2. Move the highlight bar to **Line Lock**. Change the setting.
 - Select **On** to enable the line lock. This phase locks the video with the AC power line to prevent video rolling.
 - Select **Off** to disable the line lock. This stops the phase lock, but may improve the appearance of text displayed on color monitors.

The default setting is On.



IMPORTANT

Changing the **Line Lock** setting is not immediate. The dome must reinitialize (reset) for the change to take place. When the configuration utility is exited, the following prompt appears:

**DOMEST MUST RESET TO
CHANGE LINELOCK MODE.**

RESET DOME NOW?

NO

- If you do not want to reinitialize the dome, select **No**. Changes to the Line Lock setting will not take effect.
- If you want to reinitialize the dome, select **Yes**. Changes to the Line Lock setting will take effect when the dome finishes the reset.

3. Select **Exit**. The *Dome Configuration Menu* appears. Continue with *What To Do Next* on page 2-7.

Configuring the Freeze Frame Setting

If you need to maintain a static image when calling automatic functions, such as presets or patterns, use the Freeze Frame setting. This prevents the display of the dome movement and lens adjustments from being displayed on-screen while the preset or pattern is being sought.

When the Freeze Frame setting is enabled, the scene currently displayed on the monitor will be preserved (frozen) on-screen until the pattern or preset is ready for display. The image then switches smoothly to the new scene. You may want to use this setting if using a digital video recorder.

For example, if the dome is installed in a lobby of a busy building, you may want to program presets that show different areas in the lobby. Figure 2-1 shows a sample floor plan for the lobby.

Figure 2-1: Lobby Floor Plan

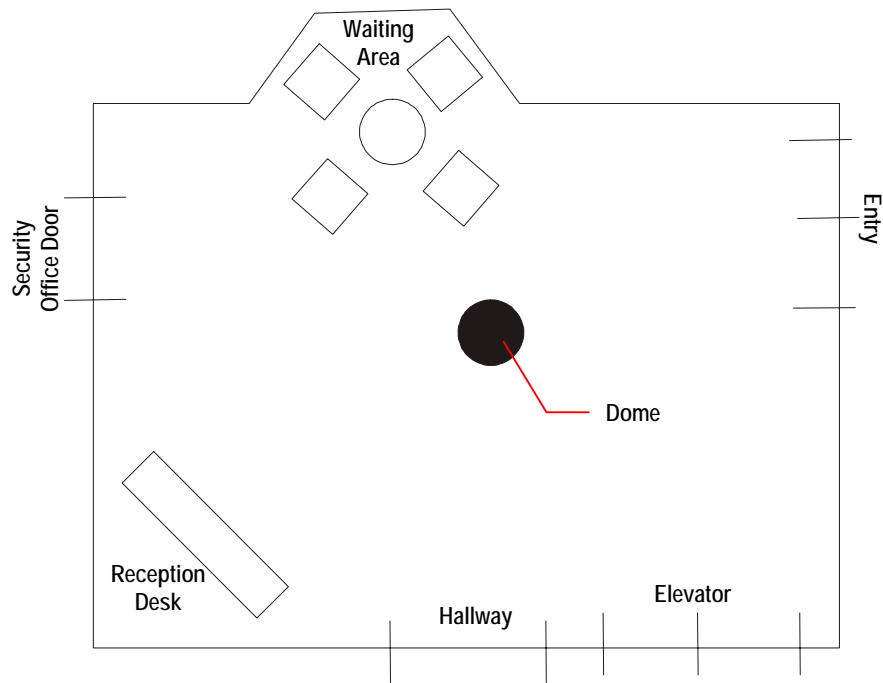

If Freeze Frame is disabled, each time the dome points to a different preset, you will see the dome movement to the new scene, as well as any lens adjustments that are required. For example, if the dome is currently pointing at Reception Desk, and the preset number assigned to the Entry is selected, you will see a blur of motion as the dome quickly pans past other areas in the lobby before focusing on the Entry scene.

If Freeze Frame is enabled, the current scene is displayed on-screen until all dome movement and lens adjustments are complete. For example, the Reception Desk scene will be frozen on-screen until the dome completes the movement and lens adjustments necessary to display the selected preset. When the adjustments are finished, the Entry scene is automatically displayed.

Changing the Freeze Frame Setting

1. Select *Pan/Tilt/Zoom/Sync Opts* from the *Dome Configuration Menu*.
2. Move the highlight bar to **Freeze Frame**. Change the setting.
 - Select **On** to enable Freeze Frame. This freezes the current scene when presets or patterns are selected.
 - Select **Off** to disable Freeze Frame. This displays the dome motion and lens adjustments when presets or patterns are selected.

The default setting is Off.

3. Select **Exit**. The Dome Configuration Menu appears. Continue with *What To Do Next* on page 2–7.

Configuring Auto Iris/Auto Focus Resume Settings

Normally, the camera's iris and focus settings return to automatic mode when the dome moves a minimum of one frame from its current pointing position. In some situations, you may want to maintain specific iris and/focus adjustments based upon your surveillance needs.

Use the **I/F Return to Auto** setting to configure the auto iris and auto focus resume settings. Four settings are available.

Setting	Description
ON	Both return to auto iris and return to auto focus settings are <i>enabled</i> . Moving the dome resumes auto mode for both iris and focus changes.
OFF	Both return to auto iris and return to auto focus settings are <i>disabled</i> . Moving the dome <i>does not</i> resume auto mode for iris and focus changes.
IRIS	Only return to auto iris is enabled. Return to auto focus is disabled. Moving the dome resumes auto iris mode without changing focus settings.
FOCUS	Only return to <i>auto focus is enabled</i> . Return to <i>auto iris is disabled</i> . Moving the dome resumes auto focus mode without changing iris settings.

Changing the Auto Iris/Auto Focus Resume Setting

1. Select *Pan/Tilt/Zoom/Sync Opts* from the *Dome Configuration Menu*.
2. Move the highlight bar to **I/F Return to Auto**. Change the setting.
 - Select **On** to enable both resume auto iris and resume auto focus.
 - Select **Off** to disable both resume auto iris and resume auto focus.
 - Select **Iris** to enable resume auto iris only.
 - Select **Focus** to enable resume auto focus only.

The default setting is On.

3. Select **Exit**. The *Dome Configuration Menu* appears. Continue with *What To Do Next* on page 2–7.

What To Do Next

When you select **Exit** from the *Pan/Tilt/Zoom* screen, the *Dome Configuration Menu* appears.

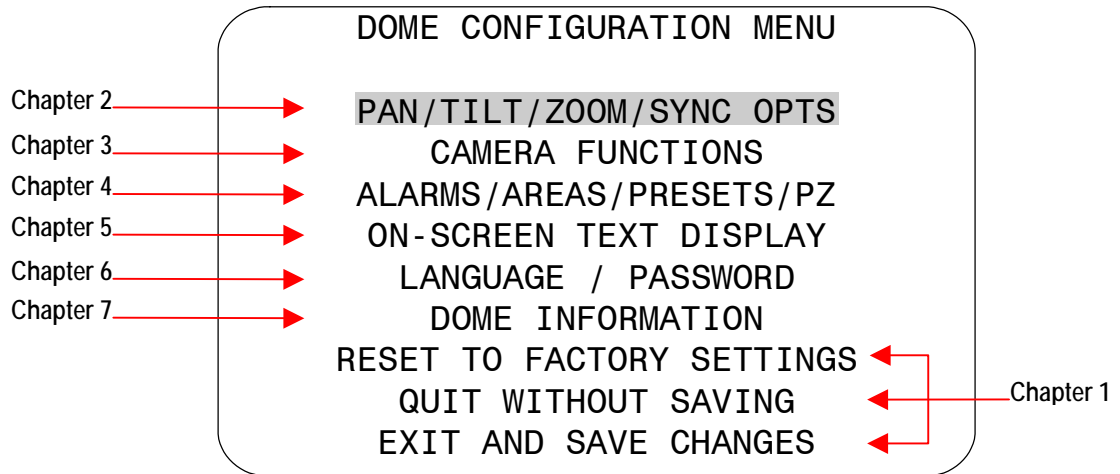

From this screen you can:

- Select an option to make additional changes.
- Restore all settings to the factory defaults.
- Exit the utility without saving changes.
- Save the changes and exit the utility.

Move the highlight bar to an item and select it. Refer to the related chapter for additional information.

N O T E S :

CHAPTER 3

Configuring Camera Features

This chapter describes the settings used to control the camera features. It describes how to change the *white balance* settings, *IR mode*, *wide dynamic range* settings, *automatic gain control*, and *open shutter* settings to improve camera performance.

In This Chapter

- Overview of Camera Settings 3-1
- Adjusting White Balance Settings 3-2
- Understanding How IR (Black & White) Mode Operates 3-3
- Understanding Wide Dynamic Range 3-5
- Working with AGC and Open Shutter Settings 3-7
- What To Do Next 3-10

Overview of Camera Settings

When **Camera Functions** is selected from the *Dome Configuration Menu*, the following screen appears:

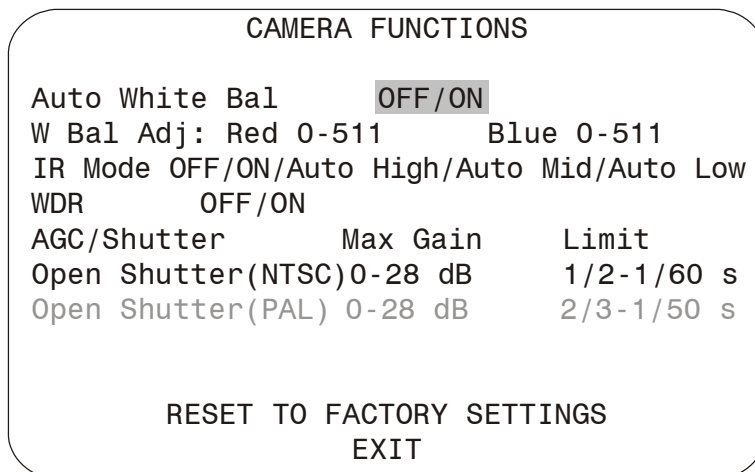

From this screen you can adjust the white balance settings, set the IR mode for the camera, enable or disable Wide Dynamic Range, set the automatic gain control (AGC) feature, adjust the AGC level, and configure the open shutter settings.

- To change settings, move the highlight bar to the appropriate field and make the changes.
- To change the settings for this screen to the factory defaults, select **Reset to Factory Settings**.
- To return to the *Dome Configuration Menu*, select **Exit**.

Adjusting White Balance Settings

White balance is normally compensated for by the automatic white balance gain control. In some lighting conditions, you may need to manually adjust the red and blue settings for optimal viewing.

When *Automatic White Balance* is enabled, the red and blue setting values are based on feedback from the camera. When *Automatic White Balance* is disabled, the camera uses the red and blue setting values to control the white balance. When *Automatic White Balance* is first switched from *On* to *Off*, the red and blue values displayed are based on the current feedback from the camera. The red and blue values range from 0 to 511. Changes occur in increments of 5.

The following chart illustrates the red and blue settings relationship to white balance.

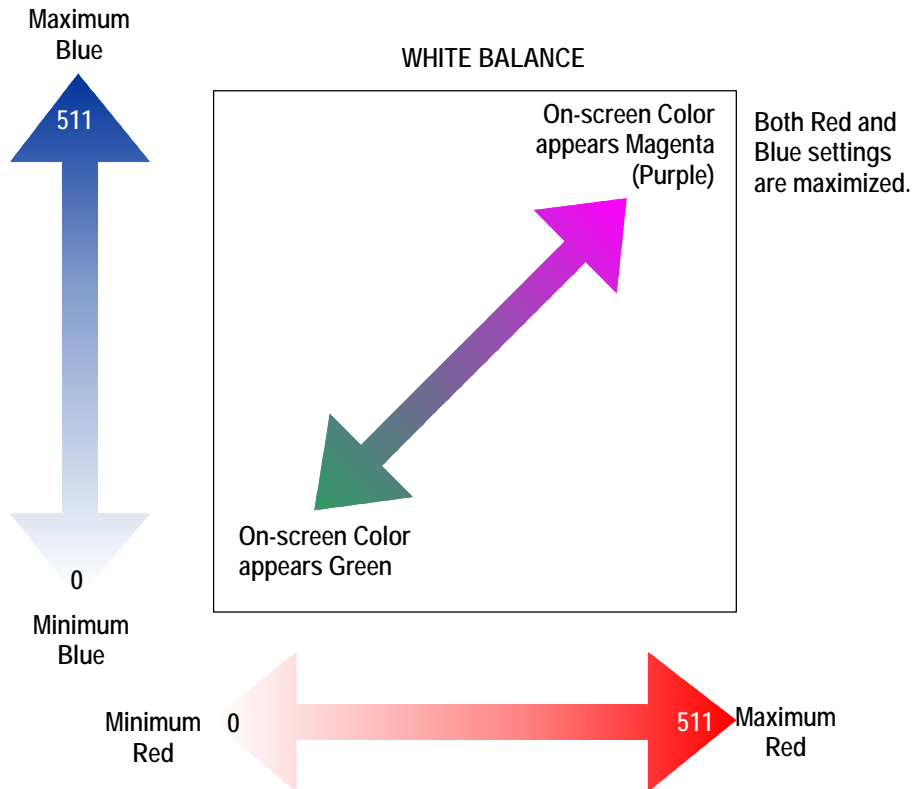

As the value for the red setting increases, the image appears more red. As the value decreases, the image appears less red.

As the value for the blue setting increases, the image appears more blue. As the value decreases, the image appears less blue.

As the values for both the red and blue settings are increased, the image appears more magenta (purple). As the values for both the red and blue settings are decreased, the image appears more green.



Tip: *Auto White Bal* must be set to **Off** to manually change the **Red** and **Blue** settings. Changes to the red and blue settings occur in increments of **5**.

Changing Automatic White Balance Settings

1. Select *Camera Functions* from the *Dome Configuration Menu*. The highlight appears on the *Auto White Bal* setting.
2. Change the setting.
 - Select **Off** to manually adjust the red or blue settings. Continue with step 3.
 - Select **On** for automatic white balance. Continue with step 7.
The default setting is On.
3. Do one of the following:
 - To change the red setting, move the highlight bar to **W Bal Adj: Red**, and then continue with step 4.
 - To change the blue setting, continue with step 5.
4. Adjust the red setting. The values range from **0 to 511** and change in increments of **5**.
There is no default value for the red setting.
5. Do one of the following:
 - To change the blue setting, move the highlight bar to **Blue**, then continue with step 6.
 - If you are finished making changes, continue with step 7.
6. Adjust the blue setting. The values range from **0 to 511** and change in increments of **5**.
There is no default value for the blue setting.
7. Select **Exit**. The *Dome Configuration Menu* appears. Continue with *What To Do Next* on page 3–10.

Understanding How IR (Black & White) Mode Operates

SpeedDome Ultra VII Day/Night provides a black-and-white (B/W) mode to improve camera performance when the light level falls below certain thresholds. This allows clear images to be obtained under low-light conditions. This is referred to as **IR Mode**. There are five IR Mode settings: **Off**, **On**, **Auto High**, **Auto Mid** and **Auto Low**. The following table lists the approximate lux values when the camera is expected to switch between color and B/W modes. Actual values depend on the current zoom setting of the camera and the light source.

IR Mode Setting	Camera Performance	B/W Mode Activates	B/W Mode Deactivates
Off	No B/W capabilities.	N/A	N/A
On	Full-time B/W mode.	N/A	N/A
Auto High	Cleanest possible picture. No field integration effect.	~30 lux	~135-155 lux
Auto Mid	Minimizes field integration effect.	~3 lux	~20-25 lux
Auto Low	Maximizes color low-light performance.	~.5 lux	~10-12 lux

For more information, see the following topics:

- *Changing the IR Mode Setting*
- *Manually Activating or Deactivating the IR Mode*

Changing the IR Mode Setting

1. Select *Camera Functions* from the *Dome Configuration Menu*.
2. Move the highlight to the *IR Mode* field. Change the setting.
 - Select **OFF** to disable the IR mode. The camera will operate in color mode only.
 - Select **ON** to enable full-time B/W mode.
 - Select **Auto High** to enable automatic B/W mode at approximately 30 lux.
 - Select **Auto Mid** to enable automatic B/W mode at approximately 3 lux.
 - Select **Auto Low** to enable automatic B/W mode at approximately .5 lux.

The default setting is Auto Low.
3. Select **Exit**. The *Dome Configuration Menu* appears. Continue with *What To Do Next* on page 3–10.

Manually Activating or Deactivating the IR Mode

The IR mode may be activated or deactivated using a combination of keyboard commands. This allows you to change between color and B/W modes as needed.

- To change the mode using *SensorNet* or *RS-422* protocols: press and hold **Iris Open**, press and hold **Focus Far**, then press **Focus Near**.
- To change the mode using *Manchester* protocol: enter **68**, and then press **Call Preset**.

Using the manual command has the following affect on the menu settings:

If the current IR Mode setting is...	The setting changes to...
<i>IR Mode On</i>	<i>IR Mode Off</i>
<i>IR Mode Off</i>	<i>IR Mode On</i>
<i>IR Mode Auto High, Auto Mid, or Auto Low</i>	<i>IR Mode On</i>



Tip: If you need to resume **Auto High**, **Auto Mid**, or **Auto Low** IR mode settings, you must use the *Dome Configuration Menu*. See *Changing the IR Mode Setting* on page 3–4.

Understanding Wide Dynamic Range

Wide Dynamic Range (WDR) is a feature that allows clear viewing of both bright and low light areas in a scene. Use this feature if you need to view both indoor and outdoor lighting conditions simultaneously.

For example, a dome is installed in the loading dock area of a building. When the door to the loading dock area is closed, the light level remains constant and the interior scene can be viewed clearly without iris adjustments.

Figure 3-1: Example scene of a loading dock with the door closed.

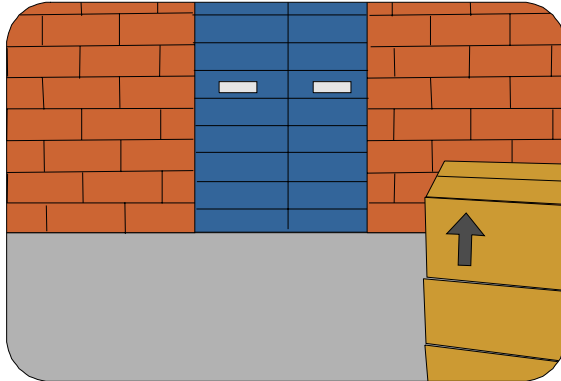

When the door is open, additional light from outside enters the room and distortion occurs. Without WDR, you could adjust the iris of the camera to compensate for the lighting change, however you cannot clearly see both activities inside and outside of the loading dock area simultaneously.

For example, if you close the iris, the outside scene will improve, but the interior scene will become too dark to view clearly. In Figure 3-2, the car near the loading dock door can be seen clearly, but the interior of the room appears too dark

Figure 3-2: Example scene of loading dock with door open and iris close adjustment.



If you want to view the interior scene, open the iris to make the dark scene appear brighter. However, this causes the outdoor scene to appear too bright. In Figure 3-3, it is difficult to see the car near the loading dock door.

Figure 3-3: Example scene with loading dock door open and iris open adjustment.

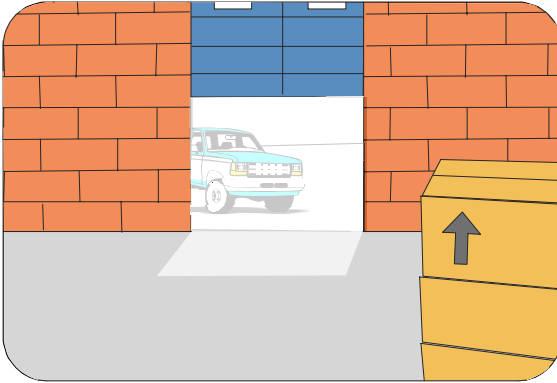

With WDR enabled, you can see the scenes both inside and outside the loading dock area. In Figure 3-4, you can see the boxes stacked inside the loading dock area and the car approaching the door.

Figure 3-4: Example scene with loading dock door open and WDR enabled.

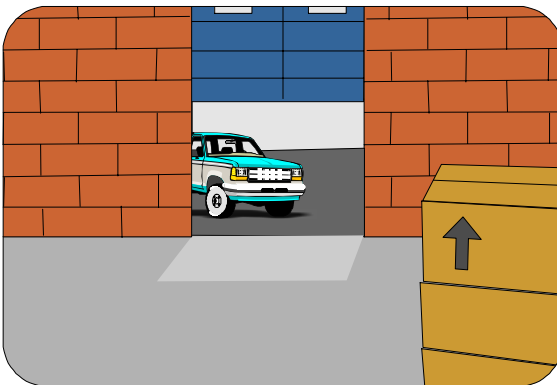

Note: When WDR is enabled, you may notice a slight flicker to the video image. This is a normal characteristic of WDR operation.

Changing the Wide Dynamic Range Setting

1. Select *Camera Functions* from the *Dome Configuration Menu*.
2. Move the highlight to the *WDR* field. Change the setting.
 - Select **OFF** to disable wide dynamic range. Use this setting when the light level is constant or changes in lighting conditions are gradual.
 - Select **ON** to enable wide dynamic range. Use this setting when both bright and low light areas need to be viewed simultaneously.

The default setting is OFF.

3. Select **Exit**. The *Dome Configuration Menu* appears. Continue with *What To Do Next* on page 3-10.

Working with AGC and Open Shutter Settings

The SpeedDome Ultra VII Day/Night dome provides settings for compensating for low-light scenes in color: *Automatic Gain Control* and *Open Shutter*. Automatic Gain Control (AGC) amplifies the video signal in scenes with minimal light. Many low-light scenes result in picture noise. As gain is increased, the picture noise is also amplified.

When AGC is enabled, the camera automatically adjusts the gain setting value. When AGC is disabled, no gain is applied to the video signal. This may make the video appear darker on the monitor.

The gain setting for the camera differs from the maximum gain (*Max Gain*) setting available on the *Camera Functions* menu. The *Max Gain* setting is an upper limit for how much gain can be increased when AGC is enabled. The trade-off between picture level (brightness) and noise may be adjusted by setting the *Max Gain* value. Lower values for *Max Gain* setting may result in a darker picture with less noise. Higher values for *Max Gain* setting may result in a brighter picture with more noise.

In addition to the AGC settings, you may also adjust the Open Shutter settings to improve dome performance in low light situations. For more information, continue with *Understanding How Advanced Shutter Settings Improve Low-Light Performance*.

Understanding How Advanced Shutter Settings Improve Low-Light Performance

The camera dome supports the ability to view color images from extremely low-light situations. This feature is called *Open Shutter* and is only in effect during low-light situations where an image would not be obtainable otherwise. It does not affect the camera performance in normal or bright light situations.

When the Open Shutter is enabled *and* the scene illumination is too low to obtain a clear image at the normal video rate, the camera collects luminance information from multiple fields. As it does so, the current video information is retransmitted until new information is available from the camera. Under these conditions, moving objects will appear blurred, and still images may appear blurred, choppy, and with more static than video obtained under normal lighting conditions.

The *Shutter Limit* value sets the video update time in fractions of a second. Depending on the lighting conditions, the video information may be updated more frequently, but no slower than the limit set.

Figure 3–5 illustrates a Shutter Limit of 1/4.

Figure 3–5: Graphical view of Shutter Limit settings

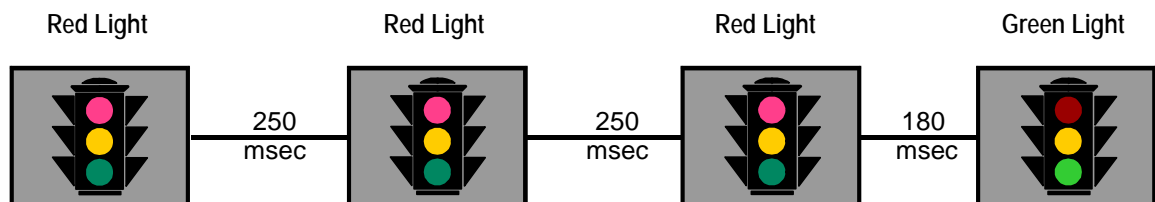

In this example, the dome receives information about the color of the traffic light. While the light is red, the image is relatively static. With the shutter limit set to 1/4 second (250 milliseconds), updated red light information is transmitted at 1/4-second intervals. When the light changes from red to green, updated light color information becomes available. The dome must now transmit information about the green light. This update occurs as soon as the green light information is available. This may occur before the 1/4-second interval elapses. In this example, the light changed to green after 180-milliseconds. Thereafter the green light information is transmitted at 1/4-second intervals until new light color information becomes available.

If the light were to change from red to green halfway through the field integration interval (125 milliseconds), it may appear that both the red and green lights are on simultaneously. This situation is illustrated in Figure 3–6.

Figure 3–6: Mixed field integration

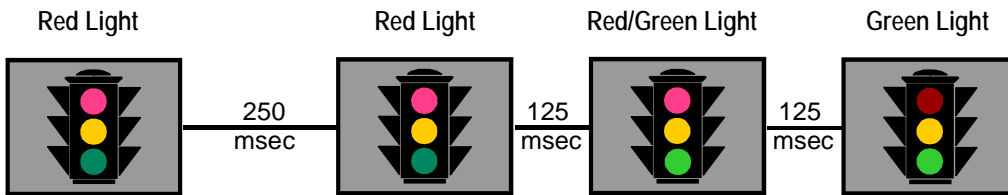

Adjusting the Shutter Limit sets the update time used to maintain the image quality. If you want to videotape an incident in low-light conditions, you may find that tape quality is not acceptable. To ensure that the videotape quality is acceptable for possible prosecution purposes, you may want to test the Shutter Limit settings under the expected lighting conditions.

The Relationship between IR Mode and AGC and Open Shutter Settings

The current IR Mode setting affects which AGC and Open Shutter settings are available. The following table lists which AGC/Shutter modes are available based upon the IR Mode setting:

IR Mode Setting	AGC Off	AGC On	Open Shutter
Off	Yes	Yes	Yes
On	Yes	Yes	Yes
Auto High	Yes	Yes	No
Auto Mid	No	No	Yes
Auto Low	No	No	Yes

In addition:

- When **AGC Off** is the current setting, the **Max Gain** and **Limit** fields are not displayed.
- When **AGC On** is the current setting, the **Max Gain** field is displayed and may be modified. The **Limit** field is not displayed.
- When **Open Shutter** is the current setting, both the **Max Gain** and **Limit** fields are displayed and may be modified.



Tip: The current IR mode setting affects which AGC Gain and Open Shutter settings are available. *The Relationship between IR Mode and AGC and Open Shutter Settings* chart on page 3–8 describes which settings are available.

1. Select *Camera Functions* from the *Dome Configuration Menu*.
2. Move the highlight to *AGC/Shutter* mode field. The highlight appears in the first field (AGC/Mode).
3. Select one of the following:
 - Select **AGC On** to set AGC to automatic mode. This allows you to adjust the maximum AGC gain setting (in decibels). Continue with step 4.
 - Select **AGC Off** to set the AGC to minimum level. You cannot adjust the maximum AGC gain or shutter limit settings. Continue with step 7.
 - Select **Open Shutter** to enable field integration. This allows you to adjust the maximum AGC gain and shutter limit settings. Continue with step 4.
The default setting is Open Shutter.
4. Move the highlight to *Max Gain* field. Change the setting. The following settings are available:
 - For NTSC cameras, the setting values range from **0 to 28dB**.
 - For PAL cameras, the setting values range from **0 to 28dB**.
5. If you need to change the shutter limit setting, continue below. Otherwise, continue with step 7.
6. Move the highlight to the *Limit* field. Change the setting. The following settings are available:
 - For NTSC cameras, the setting values range from **1/2 to 1/60**.
 - For PAL cameras, the setting values range from **2/3 to 1/50**.
The default setting is 1/4 for NTSC and 1/3 for PAL.
7. Select **Exit**. The *Dome Configuration Menu* appears. Continue with *What To Do Next* on page 3–10.

What To Do Next

When you select **Exit** from the *Camera Functions* screen, the *Dome Configuration Menu* appears.

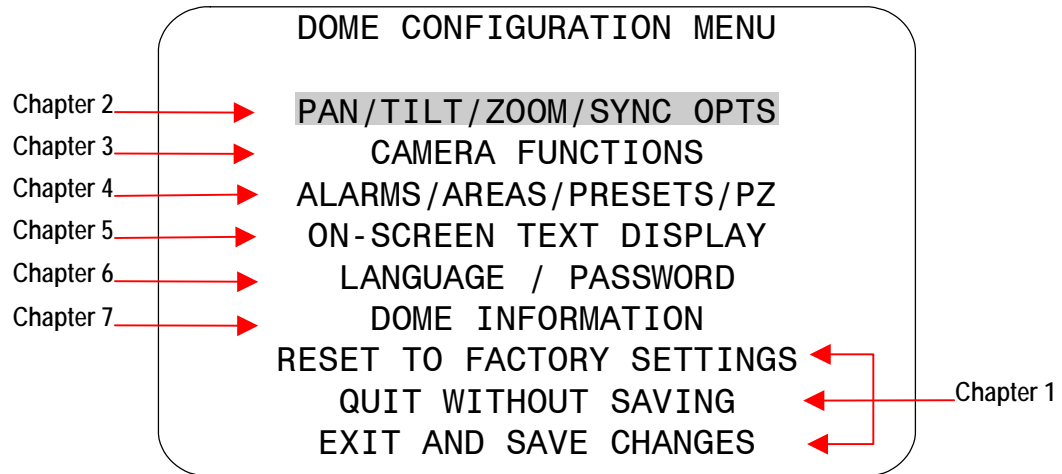

From this screen you can:

- Select an option to make additional changes.
- Restore settings to the factory defaults.
- Exit the utility without saving changes.
- Save the changes and exit the utility.

Move the highlight bar to an item and select it. Refer to the related chapter for additional information.

CHAPTER 4

Configuring Alarms, Areas, Home, Privacy Settings, Presets and Scan Limits

This chapter describes settings associated with *Alarms*, *Areas*, the *Home Position*, *Privacy Zones*, *Presets* and *Scan Limits*. It explains how to set a default action to run when a dome alarm occurs, as well as how to define the normal alarm input states. It describes how to set a default position for the dome and assign a dome position that corresponds with North. It also explains how to program Areas, Privacy Zones, Presets and Scan Limits.

In This Chapter

- Overview of Alarms, Areas, Home, North Position, Preset, Privacy and Scan Limit Settings 4-2
- Configuring Alarm Actions..... 4-3
- Configuring Normal Input States for Alarms..... 4-5
- Assigning the Dome's Home Position 4-6
- Setting the North Position 4-8
- Programming Area Boundaries 4-9
- Establishing Privacy Zones 4-11
- Programming Presets 4-16
- Establishing Scan Limits 4-17
- What To Do Next 4-20

Overview of Alarms, Areas, Home, North Position, Preset, Privacy and Scan Limit Settings

When **Alarms/Areas/Home/Presets/PZ** is selected from the *Dome Configuration Menu*, the following screen appears:

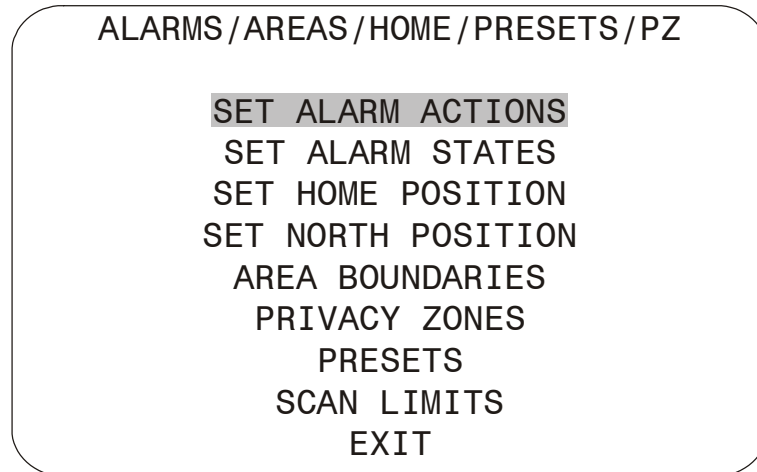

From this menu you can choose to configure alarm actions, configure normal states for alarm inputs, assign the “home position”, establish the north position for the dome, set area boundaries, set privacy zones, and program presets.

- To make changes, select a menu item to display the associated settings.
- To change the settings, move the highlight bar to appropriate field and make the changes.
- To return to the *Dome Configuration Menu*, select **Exit**.

Configuring Alarm Actions



IMPORTANT

When operating on *Manchester networks*, the dome can be programmed to respond to any of the four available alarm inputs. However, the dome cannot transmit alarm input states to the host controller. If transmitting the alarm state to the host controller is required, the alarm device must be wired directly to the host controller.

The dome provides four alarm inputs. By connecting alarm devices—such as smoke alarms, twilight sensors, or motion sensors—to these inputs, you can enhance the usability of your video surveillance system. You can further improve your video surveillance by assigning a dome action (a preset or pattern) to start whenever an alarm input changes from normal to abnormal.

When **Set Alarm Actions** is selected from *Alarms/Areas/Home/Presets/PZ* screen, the following screen appears:

SET ALARM ACTIONS	
INTERNAL ALARMS	
INPUT NO.	ACTION
1	NO ACTION
2	PRESET 1-96
3	PATTERN 1-3
4	NO ACTION
SEND INPUTS TO HOST? YES / NO	
EXIT	

Use this screen to assign a preset or pattern to occur whenever the alarm's input state changes from normal to abnormal. You may also choose to have no action occur when the alarm's input state changes.

Alarms can be processed internally by the dome, externally by the controller, or both. You may choose to send changes in the input state to the host controller. If the changes in input state are sent to the host controller, the host actions have higher priority than the associated dome actions.



Note: An active internal alarm only resets when the input state changes to “normal.” A manual reset *is not* available.



IMPORTANT

Some controllers allow the alarm actions for domes to be specified at the controller. See the appendixes for information about which controllers support this function. Do not use both the dome configuration utility and the controller to assign the alarm actions for the same input.

Use only the dome configuration utility or the controller to assign the alarm actions.

1. Select *Alarms/Areas/Home/Presets/PZ* from the *Dome Configuration Menu*.
 2. Select **Set Alarm Actions**.
The *Set Alarm Action* screen appears.
 3. Move the highlight bar to the appropriate alarm input. Change the setting.
 - Select **Preset** to use a preset as the alarm action. Continue with step 4.
 - Select **Pattern** to use a pattern as the alarm action. Continue with step 4.
 - Select **No Action** if you do not want to set an alarm action. Continue with step 6.
The default setting is No Action.
 4. Move the highlight bar to the **Action Number** field and select the action number.
 - For *preset*, select the number from **1 through 96**. Continue with step 5.
-



Note: The protocol (or controller) used may support fewer presets. Refer to the appropriate Appendix for additional information.

- For *pattern*, select the number from **1 through 3** for the pattern you want to assign. Continue with step 5.
If the selected pattern is not programmed, the dome runs the Apple Peel pattern.
5. If you need to make additional changes to the alarm actions for this dome, repeat steps 3 and 4. When finished, continue with step 6.
 6. Move the highlight bar to **Send Inputs to Host?**
 - Choose **Yes** to forward changes in input states to the host controller.
 - Choose **No** to prevent changes in the input states from being forwarded to the host controller.
The default setting is Yes.
 7. Select **Exit** to return to the *Alarm/Areas/Home/PZ* screen.
 8. When the *Alarm/Areas/Home/PZ* screen appears, select **Exit**. The *Dome Configuration Menu* appears. Continue with **What To Do Next** on page 4–20.

Configuring Normal Input States for Alarms



IMPORTANT

Some controllers allow the normal input states for domes to be specified at the controller. These controllers include VM96, AD matrices with AD2083-02A code units or AD168 matrix with the AD168CCM or AD2083-02A code unit. Do not use both the dome configuration utility and the controller to assign the normal input states. *Use only the dome configuration utility or the controller to assign the normal input states.*

The normal input state for an alarm is the state that the device maintains when an alarm is not occurring. For example, you have a smoke detector connected to a dome input. Under normal circumstances, the smoke detector should not be detecting smoke. When smoke is detected, the alarm input changes states (from open to closed) and an alarm is issued.

To configure the normal state for the alarm, select **Set Alarm States** from the *Alarm/Areas/Home/Presets/PZ* screen. The following screen appears:

SET ALARM STATES

INPUT NO.	NORMAL STATE
1	OPEN / CLOSED
2	OPEN / CLOSED
3	OPEN / CLOSED
4	OPEN / CLOSED

EXIT

Use this screen to assign open or closed as the normal state for the dome alarm inputs. When an input state changes from normal to abnormal *and* an internal alarm action is associated with the input, the alarm is triggered. The normal state is used by both internal alarms and controller defined alarms.



IMPORTANT

When operating on *Manchester networks*, the dome can be programmed to respond to any of the four available alarm inputs. However, the alarm input states cannot be transmitted to the host controller. If transmitting the alarm input state to the host controller is required, the alarm device must be wired directly to the host controller.

Setting Alarm Input States

1. Select *Alarms/Areas/Home/Presets/PZ* from the *Dome Configuration Menu*.
2. Select **Set Alarm States**.
3. Select the appropriate input line, and then change the setting.
 - Select **Open** if the alarm normal input state is open.
 - Select **Closed** if the alarm normal input state is closed.

The default setting is Open.



Note: In most cases, the normal input state for a dome's input should match the contact type of the connected switch.

4. Repeat step 3 for each input requiring change. When finished, continue with step 5.
5. Select **Exit** to return to the *Alarms/Areas/Home/Presets/PZ* screen.
6. When the *Alarms/Areas/Home/Presets/PZ* screen appears, select **Exit**. The *Dome Configuration Menu* appears. Continue with *What To Do Next* on page 4–20.

Assigning the Dome's Home Position

The home position is a preset or pattern that automatically runs after a designated period of dome inactivity. Use this option if you want to keep a specific area to be under surveillance whenever the dome is not moving.

To assign the home position, select **Set Home Position** from the *Alarms/Areas/Home/Presets/PZ* screen. The following screen appears:

SET HOME POSITION

HOME POSITION NO ACTION
PRESET 1-96
PATTERN 1-3

RETURN TIME MINS 1-60 (10)

EXIT



Tip: When a pattern is selected as the home position, the pattern runs until stopped manually by issuing a camera command, such as **Tilt** or **Focus**.

Setting the Home Position

1. Select *Alarms/Areas/Home/Presets/PZ* from the *Dome Configuration Menu*.
2. Select **Set Home Position**.

The highlight bar appears on the **Home Position** setting.

3. Select a setting.
 - Select **Preset** to use a preset as the home position. Continue with step 4.
 - Select **Pattern** to use a pattern as the home position. Continue with step 4.
 - Select **No Action** if you do not want to set a home position. Continue with step 5.
The default setting is No Action.
4. Move the highlight bar to the **Number** field, and select a number.
 - For *preset*, select the number from **1 through 96**. Continue with step 5.



Note: The protocol used may support fewer presets. Refer to the appropriate Appendix for additional information.

- For *pattern*, select the number from **1 through 3** for the pattern you want to assign. Continue with step 5.

If the selected pattern is not programmed, the dome runs the Apple Peel pattern.

5. Move the highlight bar to **Return Time Mins**. Set the amount of time that the dome must remain inactive before returning to the home position.
 - The setting ranges from **1 to 60 minutes**.

The default setting is 10 minutes.

6. Select **Exit** to return to the *Alarms/Areas/Home/Presets/PZ* screen.



Note: If you selected a preset that has not been programmed, preset programming automatically starts. See *Programming Presets* on page 4–16.

7. When the *Alarms/Areas/Home/Presets/PZ* screen appears, select **Exit**. The *Dome Configuration Menu* appears. Continue with *What To Do Next* on page 4–20.

Setting the North Position

Direction Indicators permit you to understand the approximate pointing position of the dome to an established reference point. This reference point is called “North” and may correspond to magnetic north (if it is known) or some other landmark or fixture. When the dome is initially installed, “North” defaults to a pre-defined position (0° pan/tilt). You may program the “North” position to be any point along the dome's pan axis (also called *azimuth*).

For more information about Direction Indicators, see *Chapter 5*.

Programming the North Position

1. Select *Alarms/Areas/Home/Presets/PZ* from the *Dome Configuration Menu*.
2. Select **Set North Position**.

The *Set North Position* screen appears:

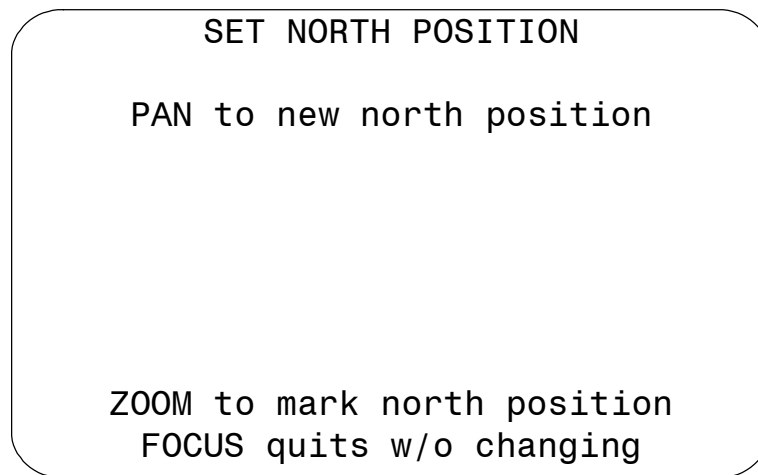

3. Point the dome to the new North position. When satisfied with the view, save the setting, or cancel the change.
4. The *Alarms/Areas/Home/Presets/PZ* screen appears. Select **Exit**. The *Dome Configuration Menu* appears. Continue with *What To Do Next* on page 4–20.

Programming Area Boundaries

If the dome is installed in a location where you can see numerous departments or other identifiable objects, you might want to consider programming area boundaries. **Areas** are programmed start- and end-points of a camera's field of view. Each area is a part of a circular viewing area that extends around the dome.

For example, **Error! Reference source not found.** represents the floor plan of a break room. The room includes a main entrance, tables with chairs, vending machines, lockers, and an emergency exit. Areas have been programmed around the fixtures in the room. As shown in this example, areas can be different sizes.

Figure 4-1: An example of areas found in a break room.

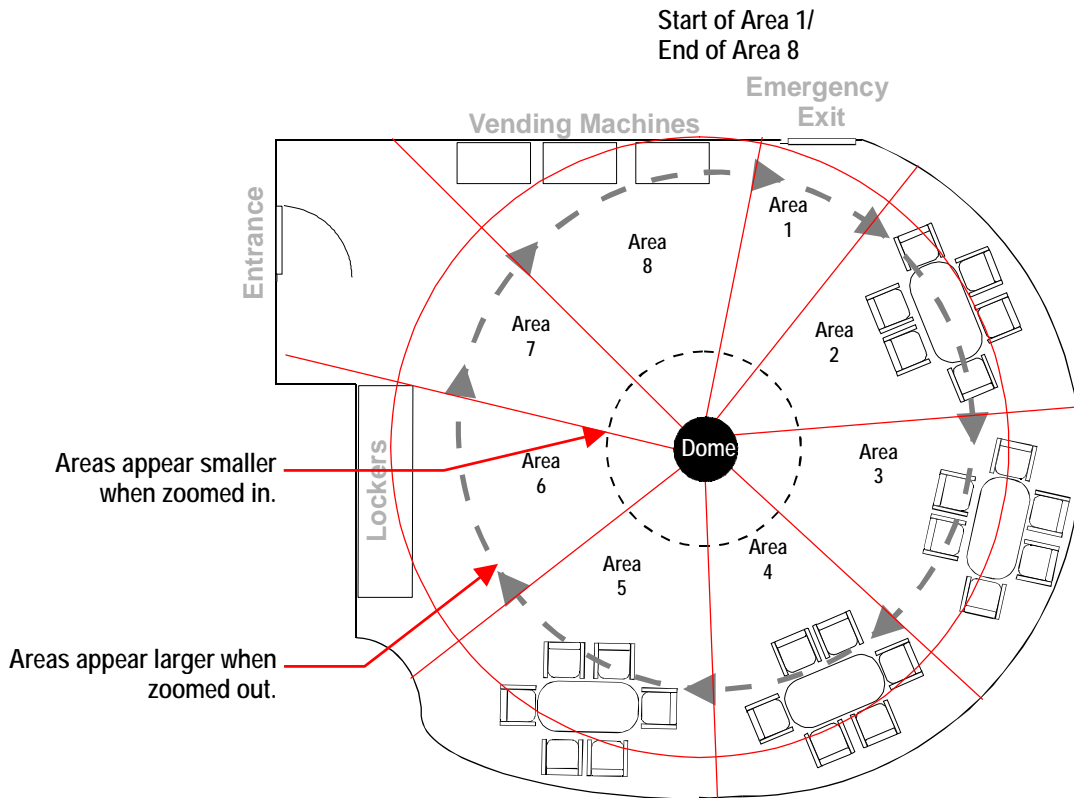

The ending point of one area is the starting point for the next area. The ending point of the last area cannot go past the starting point of the first area. In this example, the area that includes the vending machines cannot extend past the starting point of the area that includes the emergency exit. If your controller supports areas, these are separate from the areas you can program with the dome. You should not use both the controller and the configuration utility to define areas.

The zoom level also affects how large areas appear. When you zoom in to an area, the area may appear to be small. When you pan the dome, area boundaries may appear to be close. However, if you zoom out, the area appears to be larger. When you pan the dome, the area boundaries appear further apart. With this in mind, it will be easier to establish area boundaries if the zoom level is small than if the zoom level is large.



Note: When areas are programmed, each area is assigned a default name. Instructions for assigning new names appear in *Chapter 5*.

To program areas, select **Area Boundaries** from the *Alarms/Areas/Home/Presets/PZ* screen. The following screen appears:

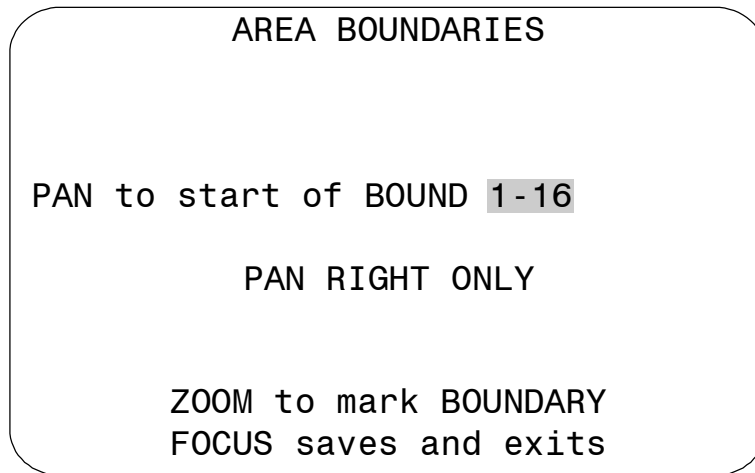

If no boundary is set, pressing **Focus** quits without making any changes.

The dome supports from 2 to 16 areas.



IMPORTANT

If areas were previously programmed, you cannot restore the previously programmed boundaries by selecting **Quit Without Saving** from the *Dome Configuration Menu* once you begin making changes to the boundaries.

Setting Area Boundaries

1. Select *Alarms/Areas/Home/Presets/PZ* from the *Dome Configuration Menu*.
2. Move the highlight bar to **Area Boundaries**, then select.
The *Area Boundaries* screen appears.
3. Adjust the camera to the starting point of the first area, and press **Zoom** to mark the boundary.
4. Adjust the dome to the right until the ending point of the area is seen. If you attempt to move left, an error message appears. See the note on page 4–11 for information.
5. Mark the end-point of the area.
The area number automatically advances.
6. Repeat steps 4 and 5 for each area you want to establish.



Note:

You will receive an error message under the following conditions:

- If you attempt to program an area boundary that passes the starting point of the first area
- If you move the camera left after establishing the first boundary

Return to step 2 and start again.

7. When the last area boundary is set, save the changes. A message appears confirming that the areas have been successfully saved. Press **Focus** to continue.
8. When the *Alarms/Areas/Home/Presets/PZ* screen appears, select **Exit**. The *Dome Configuration Menu* appears. Continue with *What To Do Next* on page 4–20.

Establishing Privacy Zones

Privacy Zones are “masked” sections of the dome’s viewing area. These masks prevent operators of the surveillance system who do not have access to the dome password from viewing these designated zones. Each zone has four sides, and the zones may overlap to form irregular shapes. The Privacy Zones move in relation to the dome pan/tilt position. In addition, the apparent size of the Privacy Zone adjusts automatically as the zoom level is adjusted. Up to **eight** Privacy Zones may be established for a dome.

Privacy Zones are useful for high security areas. For example, you might establish a Privacy Zone around a safe’s combination. However, you could view people approaching or opening the safe.

When Privacy Zones are active, the dome’s firmware automatically disables text transparency. For additional information about text appearance, see *Chapter 5*.

In addition, the appearance of the configuration menus changes slightly when Privacy Zones are active. Both the first and last lines of the menus will appear in enlarged text when Privacy Zones are active. The menus change to one-sized text if Privacy Zones are hidden or deleted.

To program Privacy Zones, select **Privacy Zones** from the *Alarms/Areas/Home/Presets/ PZ* screen. The following screen appears:

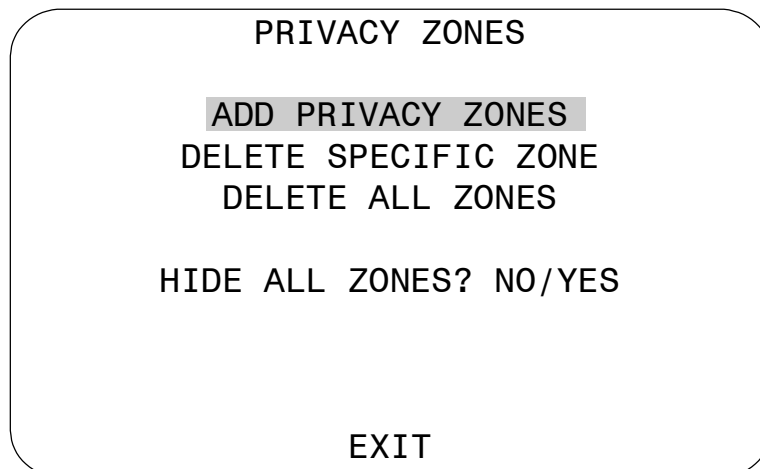

From this screen, you can program up to eight Privacy Zones, delete all or specific Privacy Zones, or temporarily hide all Privacy Zones. For more information see:

<i>Topic</i>	<i>Page Number</i>
<i>How Privacy Zones are Programmed</i>	4-12
<i>Programming Privacy Zones</i>	4-13
<i>Removing or Hiding Privacy Zones</i>	4-14
<i>Deleting Specific Privacy Zones</i>	4-15
<i>Deleting All Privacy Zones</i>	4-15
<i>Hiding Privacy Zones</i>	4-15

How Privacy Zones are Programmed

Privacy Zones are established by selecting three points on the display image to mask. The fourth point on the Privacy Zone is automatically generated by mirroring the longest axis between the three selected points. Figure 4-2 illustrates how Privacy Zones are programmed.

Figure 4-2: Privacy Zone programming example

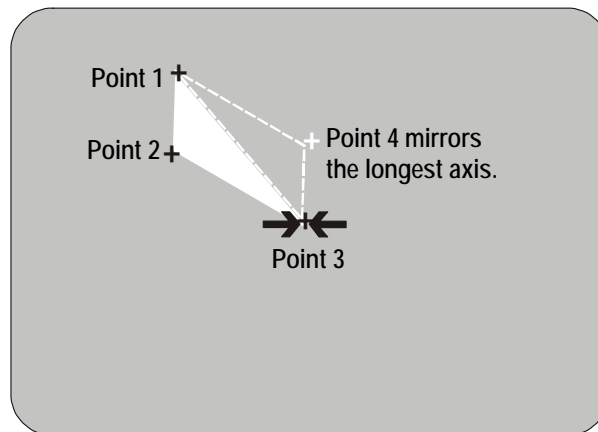

The dome's firmware prevents you from establishing a zone that is too small or too large (greater than 90-degrees pan or tilt from the starting point).

Figure 4-3 illustrates the Privacy Zone programming screen:

Figure 4-3: Privacy Zone Programming screen

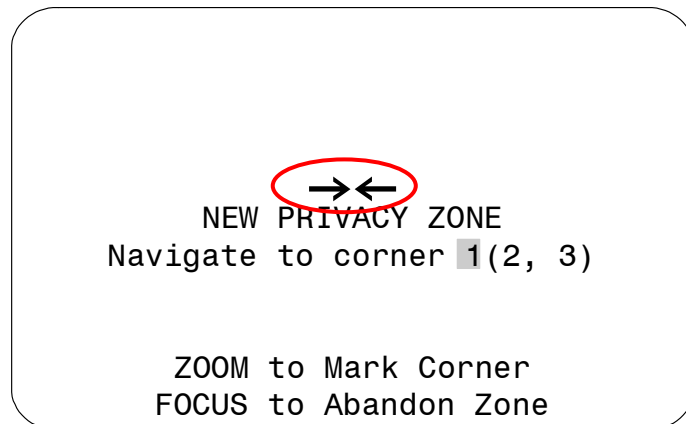

The circled arrows represent the target area on the screen for creating the Privacy Zone. Normally, this target area remains in the center of the screen. Using the **Pan/Tilt** control moves the target area by panning or tilting the dome. If the dome reaches its maximum tilt position, the Privacy Zone may still be established in the upper part of the display. When this occurs, the arrows move relative to the movement of the **Pan/Tilt** control until the top of the display area is reached.

The boundary points on the Privacy Zone are selected by pressing **Zoom**. Once a boundary point is selected, the arrows “blink” until the target area is moved to a valid area. Once the target moves to a valid area, the arrows stop blinking. If you move the target more than 90-degrees from a selected point, the arrows begin to blink again, indicating that the boundary is too large.

If you attempt to establish a boundary point while the arrows are blinking you will receive an error message: **Zone is Too Small** or **Zone is Too Large**. If this happens, you must start programming from the beginning. Pressing **Focus Far** returns you to the Privacy Zone programming screen.

If you attempt to program more than eight Privacy Zones, the following message appears:

Maximum Allowed Number of Zones Defined

Pressing **Focus Far** returns to the *Program Privacy Zones* screen. To program a new zone, you must delete at least one of the eight existing Privacy Zones. See *Removing or Hiding Privacy Zones* on page 4–14.



IMPORTANT

Areas of the Privacy Zone may be exposed during rapid pan / tilt movements of the dome. To compensate for this limitation, you may want to program the Privacy Zone to be 20 to 25% larger than the area you want to mask.

Programming Privacy Zones

1. Select *Alarms/Areas/Home/Presets/PZ* from the *Dome Configuration Menu*.
2. Select **Privacy Zones**.
3. The Program Privacy Zones screen appears. Select **Add Privacy Zone**.
4. Use the **Pan/Tilt** control to position the arrows over the boundary point. Press **Zoom** to create.
5. Repeat step 4 to create boundary points 2 and 3.



Tip: Remember, if the arrows are blinking, you are not in a valid target area. Only select a point if the arrows are not blinking.

6. After the third boundary point is created, the fourth boundary point is automatically calculated. The new Privacy Zone appears on the screen. To program additional Privacy Zones, repeat steps 3 through 5. When finished, continue with step 7.
7. Select **Exit** to return to *Alarms/Areas/Home/Presets/PZ* screen.
8. When the *Alarms/Areas/Home/Presets/PZ* screen appears, select **Exit**. The *Dome Configuration Menu* appears. Continue with *What To Do Next* on page 4–20.

Removing or Hiding Privacy Zones

If you make an error during programming or no longer require Privacy Zones, individual zones or all Privacy Zones may be deleted. To temporarily remove the Privacy Zones, you may disable their appearance by changing the **Hide All Zones** setting to **Yes**.

To delete individual Privacy Zones, you must adjust the position of the arrows to the area of the screen where the zone is recognized by the firmware. If multiple Privacy Zones are close together or overlap, the arrows blink, indicating that the selection is not allowed. Figure 4-4 illustrates Privacy Zones that are close together.

Figure 4-4: Deleting Privacy Zones – Invalid Selection

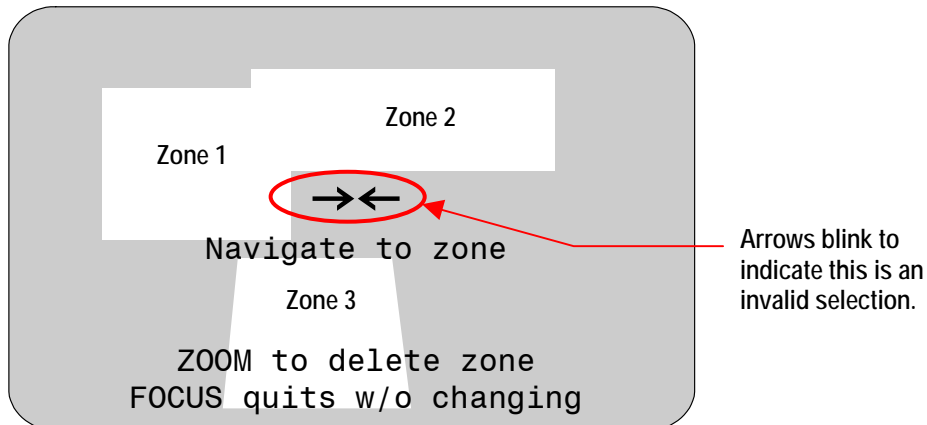

Three Privacy Zones are illustrated. Zones 1 and 2 are overlapping. Zone 1 and 3 are in close proximity. In this situation, the arrows blink because the target area is the same distance from all three zones.

To ensure that the correct Privacy Zone is deleted, place the arrows clearly in the zone you want to delete. Figure 4-5 illustrates a valid selection.

Figure 4-5: Deleting Privacy Zone – Valid Selection

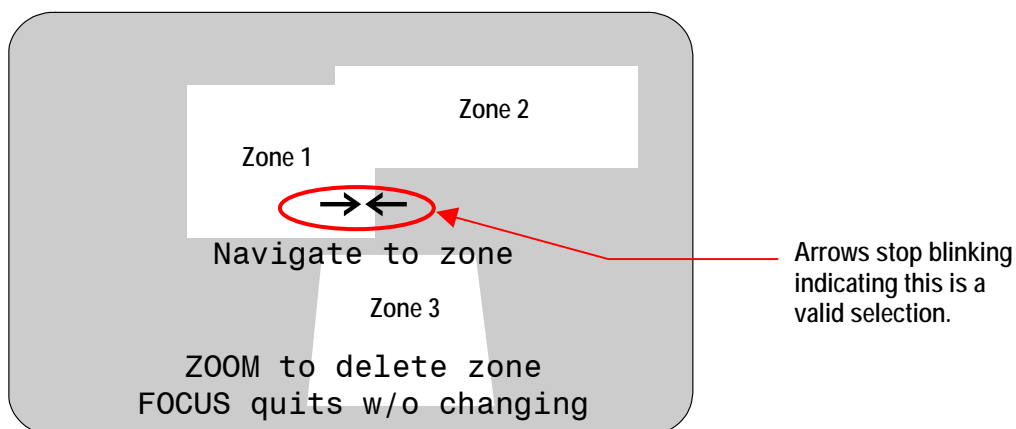

By moving to the left, the arrows stop blinking when the target area enters Zone 1. Pressing **Zoom** allows you to delete Zone 1. If you do not want to delete the zone, press **Focus**.



Note: Once you delete a zone, pressing **Focus** saves and exits the **Delete Privacy Zones** screen.

Deleting Specific Privacy Zones

To delete individual Privacy Zones, use the following procedure. To delete all Privacy Zones, see *Deleting All Privacy Zones* on page 4–15.

1. Select *Alarms/Areas/Home/Presets/PZ* from the *Dome Configuration Menu*.
2. Select *Privacy Zones*.
The *Program Privacy Zones* screen displays.
3. Select **Delete Specific Zones**.
4. Position the arrows in the Privacy Zone that you want to delete. Press **Zoom** to delete.
If you do not want to delete the zone, press **Focus**.
5. Repeat steps 3 and 4 for each Privacy Zone you want to delete. When finished, select **Exit**.
6. When the *Alarms/Areas/Home/Presets/PZ* screen appears, select **Exit**. The *Dome Configuration Menu* appears. Continue with *What To Do Next* on page 4–20.

Deleting All Privacy Zones

To delete all Privacy Zones, use the following procedure. To delete individual Privacy Zones, see *Deleting Specific Privacy Zones* on page 4–15.

1. Select *Alarms/Areas/Home/Presets/PZ* from the *Dome Configuration Menu*.
2. Select *Privacy Zones*. The *Program Privacy Zones* screen displays.
3. Select **Delete All Zones**.
4. The following prompt appears on-screen:

**You are about to delete
All Privacy Zones**

Cancel
Continue

5. To delete all Privacy Zones, select **Continue**.
If you do not want to delete all Privacy Zones, select **Cancel**. The *Program Privacy Zones* screen displays.
6. Select **Exit** to return to *Alarms/Areas/Home/Presets/PZ* screen.
7. When the *Alarms/Areas/Home/Presets/PZ* screen appears, select **Exit**. The *Dome Configuration Menu* appears. Continue with *What To Do Next* on page 4–20.

Hiding Privacy Zones

If you want to temporarily disable the appearance of Privacy Zones, you may “hide” them. This allows you to keep the Privacy Zones that have been programmed while disabling their appearance on-screen.

To hide all Privacy Zones:

1. Select *Alarms/Areas/Home/Presets/PZ* from the *Dome Configuration Menu*.
2. Select *Privacy Zones*.
The *Program Privacy Zones* screen displays.
3. Select **Hide All Zones**. Change the setting.
 - Select **Yes** to hide all Privacy Zones.
 - Select **No** to make all Privacy Zones active.
The default setting is No.
4. Select **Exit** to return to *Alarms/Areas/Home/Presets/PZ* screen.
5. When the *Alarms/Areas/Home/Presets/PZ* screen appears, select **Exit**. The *Dome Configuration Menu* appears. Continue with *What To Do Next* on page 4–20.

Programming Presets

If you need to view specific places routinely, you should program presets. A *preset* is a programmed video scene with automatic pan, tilt, zoom, focus and iris settings. Once programmed, entering the number and pressing a button on your controller automatically calls up the preset. In addition, presets may be assigned to alarm actions or as the “home” position for the dome. As many as 96 presets—whose positions are saved in the dome’s firmware—may be programmed.

VM96 and AD matrices installed as RS-422 and SensorNet networks support “virtual views.” This means that the pan, tilt, zoom, focus, and iris settings are stored within the controller, not the dome. You cannot use the “virtual views” that you define on those systems as the home position or an alarm action. You must use the presets programmed using this utility.

AD168 matrices with an AD168CCM control code module support Manchester, RS-422, and SensorNet networks and provide 64 “virtual views.” All other AD matrices support Manchester and 64 dome presets, or RS-422 networks and provide 16 “virtual views” when the AD2083-02A code unit is used.

Setting Presets



Note: When presets are programmed, each preset is assigned a default name. Instructions for assigning new names appear in *Chapter 5*.

1. Select *Alarms/Areas/Home/Presets/PZ* from the *Dome Configuration Menu*.
2. Select **Presets**.

The **Select Preset to Program** screen appears:

SELECT PRESET TO PROGRAM	
PRESET NUMBER	PRESET NAME
1 - 96	PRESET 1 - 96
FOCUS FAR to program preset	
EXIT	

3. Select the number for the preset that you want to program. The **Presets** screen appears.

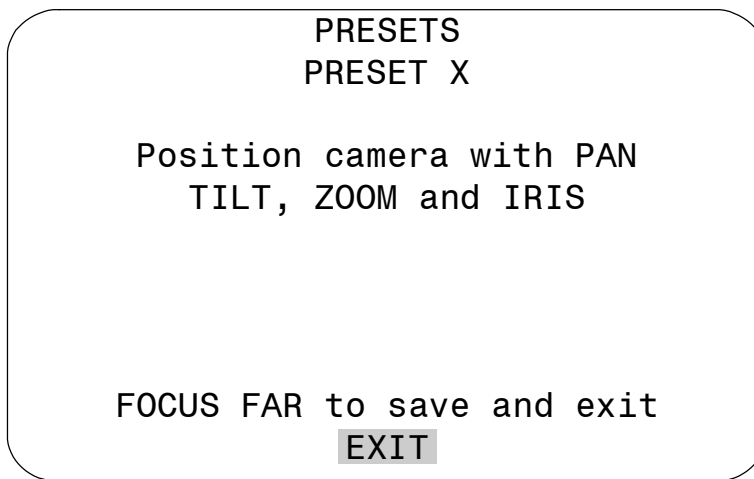

4. Adjust the camera until you see the scene you want to use as the preset. Adjust the zoom and iris settings as necessary. When satisfied with the scene, save the preset.
5. Repeat steps 3 and 4 for each preset you want to program. When finished, select **Exit**.
6. When the *Alarms/Areas/Home/Presets/PZ* screen appears, select **Exit**. The *Dome Configuration Menu* appears. Continue with **What To Do Next** on page 4–20.

Establishing Scan Limits

If your controller supports the Quick Set menu function, you can program left and right scan limits to automate your surveillance activities. Once these scan limits are programmed you can choose to run a smooth scan, stepped scan, or random scan. When active, the scan repeats until interrupted by a camera command, preset, pattern, or alarm.

Understanding Scan Limits

Scan Limits are two points around the pan axis that define a surveillance area. When a scan is activated, the dome pans between the two surveillance points—the left and right scan limits. This helps to ensure that only useful video is being monitored during the scan.

For example, a dome is mounted off the edge of a building to monitor a parking lot. Part of the observable area in this situation is a wall. By setting left and right scan limits to exclude the wall, only the viewable area of the parking lot is monitored when a scan is active.

Figure 4–6 illustrates the scan limits. The dashed circle represents the dome's field of view. The solid line curve represents the scan area. By setting left and right scan limits where the building's wall becomes visible, you ensure that only useful video of the parking lot is being observed when the scan is active.

Figure 4–6: Left and Right Scan Limits

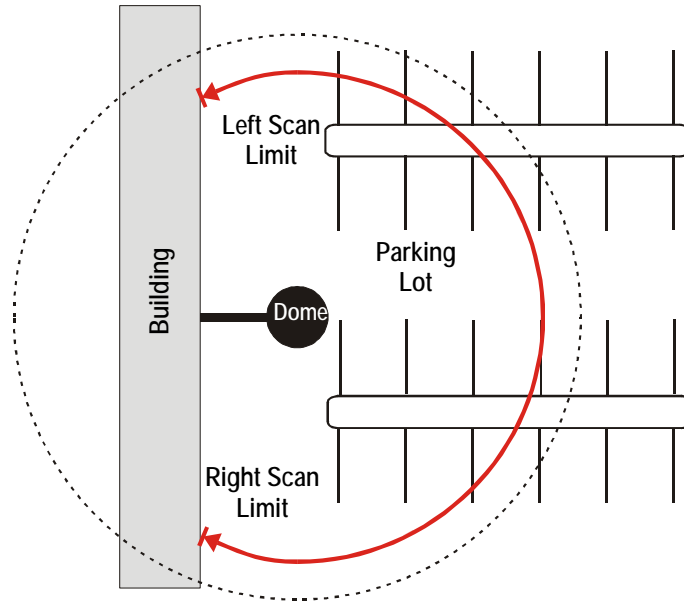

Scan Types

Three types of scans may be activated: smooth scan, stepped scan, and random scan.

A *smooth scan* slowly pans between the left and right scan limits, starting at the left scan limit. When the right scan limit is reached, the scan reverses. Figure 4–6 illustrates the smooth scan.

A *stepped scan* pans slowly, pausing briefly every 10° between the left and right scan limits. Once the right scan limit is reached, the scan reverses. Figure 4–7 illustrates the stepped scan. Each arrowhead represents a 10° step in the scan.

Figure 4–7: Stepped Scan

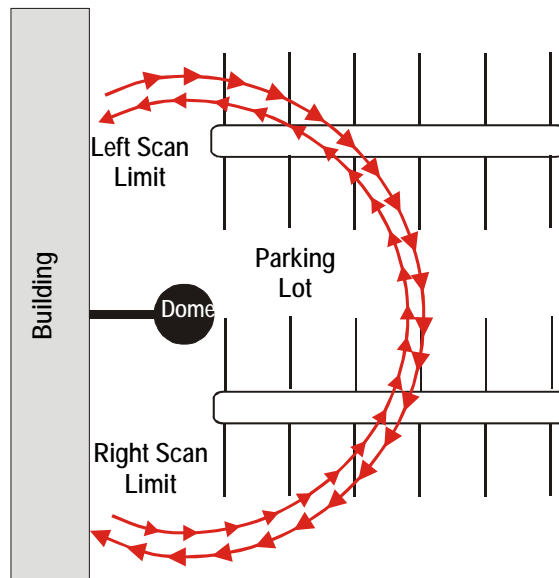

A random scan pans randomly between the left and right scan limits. For example, the scan may start at point in the scan, then pan right 40° and pause, pan right 10° and pause, pan left 20° and pause, and pan right until it reaches the right scan limit. Figure 4–8 illustrates a random scan. In this figure, the dashed line represents the scan area, and the solid line represents the scan pattern. The circle on the scan represents the start point. Each arrowhead represents a pause. “X” represents a change in direction.

Figure 4–8: Random Scan

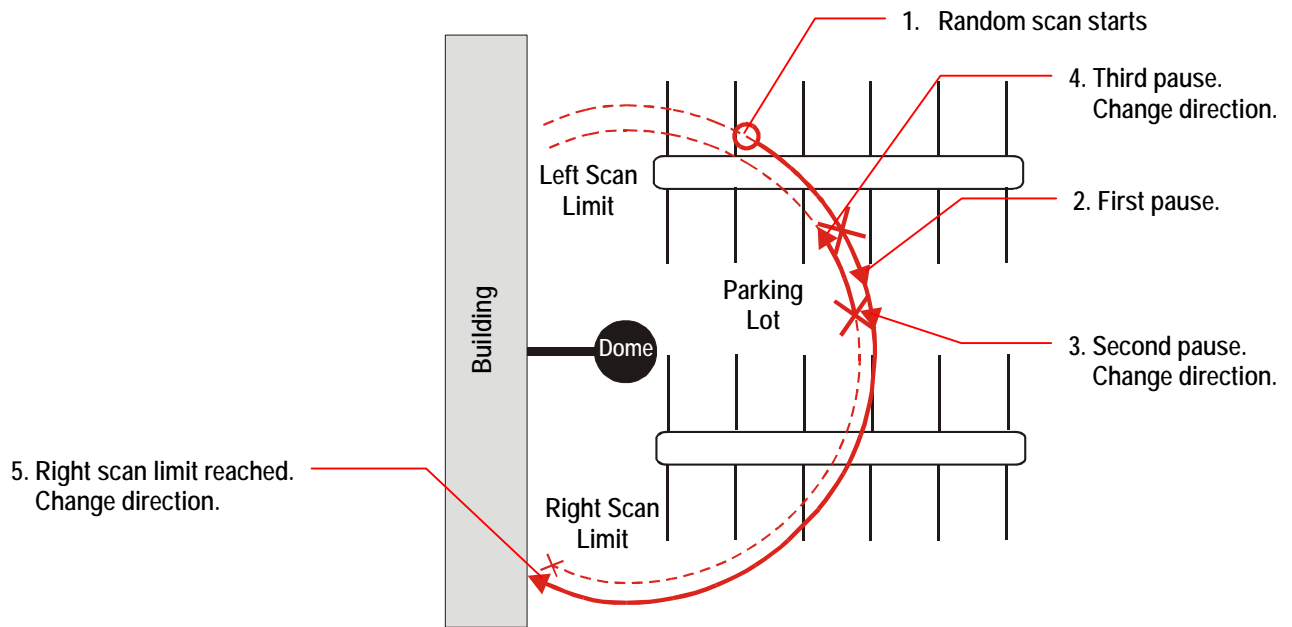

Programming Scan Limits



Note: Scan Limits can only be used with controllers that support the Quick Set menu. The Quick Set menu is not available for domes used with the Manchester protocol.

1. Select *Alarms/Areas/Home/Presets/PZ* from the *Dome Configuration Menu*.
2. Select **Scan Limits**.

The **Scan Limits** screen appears:

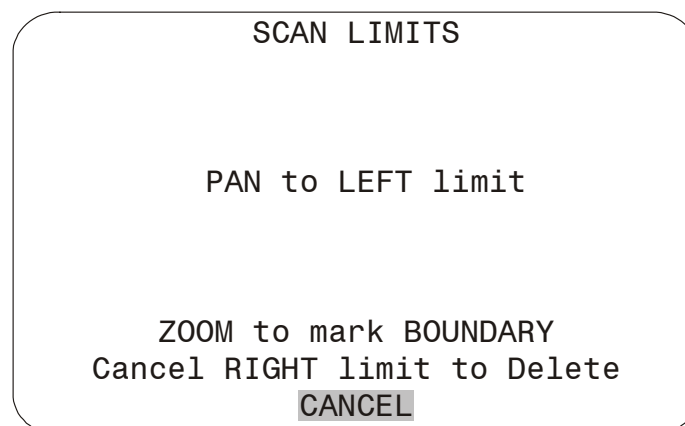



Note: Press **Focus** during steps 3 or 4 to cancel scan limit programming.

3. Adjust the pan position of the dome to set the *left scan limit*. Press **Zoom** to select.
4. Pan the dome **to the right** to set the *right scan limit*. Press **Zoom** to select.
5. When the *Alarms/Areas/Home/Presets/PZ* screen appears, select **Exit**. The *Dome Configuration Menu* appears. Continue with **What To Do Next** on page 4–20.

What To Do Next

When you select **Exit** from the *Alarms/Areas/Home/Presets/PZ* screen, the *Dome Configuration Menu* appears.

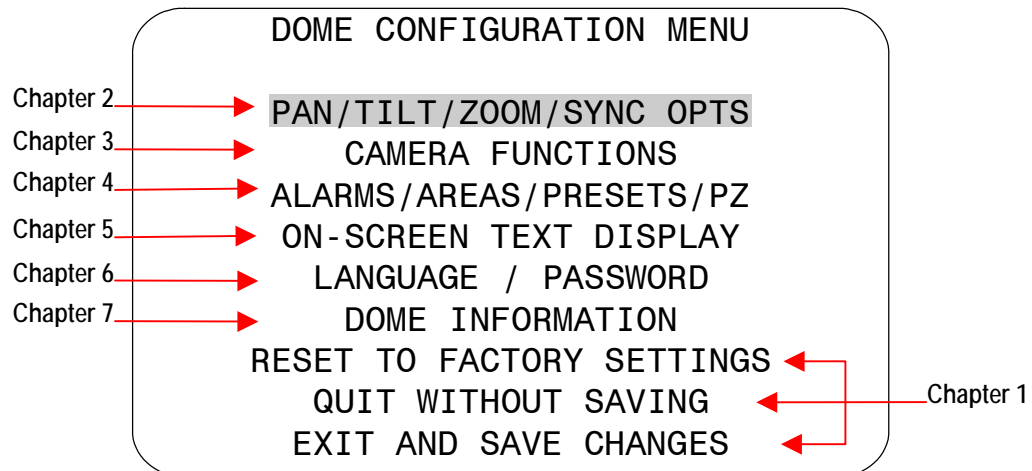

From this screen you can:

- Select an option to make additional changes.
- Restore all settings to the factory defaults.
- Exit the utility without saving changes.
- Save the changes and exit the utility.

Move the highlight bar to an item and select it. Refer to the related chapter for additional information.

CHAPTER 5

Configuring Text Displayed On-Screen

This chapter describes how to modify settings related to text displayed by the dome. It includes settings for displaying *dome status information*, *names*, *diagnostics*, and *pointing direction*. It also provides instructions for *programming names* and configuring *text display options*.

In This Chapter

- Overview of On-Screen Text Display Settings 5-1
- Displaying or Hiding Status Information 5-2
- Displaying or Hiding All Name Information 5-3
- Displaying Diagnostic Tests During Reset 5-4
- Displaying Direction Indicators 5-5
- Configuring the Display of Name Information 5-6
- Assigning or Changing Name Information 5-7
- Changing the Settings for Text Displayed On-Screen 5-9
- What To Do Next 5-11

Overview of On-Screen Text Display Settings

When **On-Screen Text Display** is selected from the *Dome Configuration Menu*, the following screen appears:

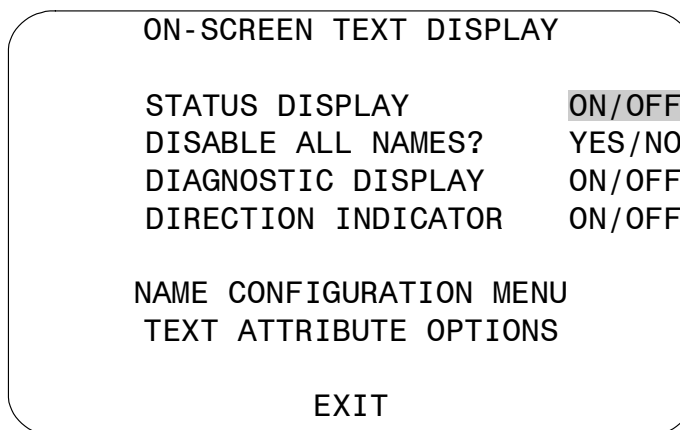

Use this screen to display dome status information, enable or disable the display of all name information, display diagnostic information after a dome reset, and display direction information about where the dome is pointing. You may also start the **Name Configuration Menu** and the **Text Attribute Options** screens.

- To change the settings, move the highlight bar to appropriate field and make the changes.
- To return to the *Dome Configuration Menu*, select **Exit**.

Displaying or Hiding Status Information

You can choose to display the status of the zoom setting, auto focus, and auto iris. This information will appear in the upper left corner of the monitor. The information only appears when there is a change in the status of any item and remains on the screen for 5 seconds. If “D” appears next to the zoom factor, the digital zoom is active (zooms greater than 22X).

Figure 5-1: Example of Zoom, Auto Focus and Auto Iris Status Information

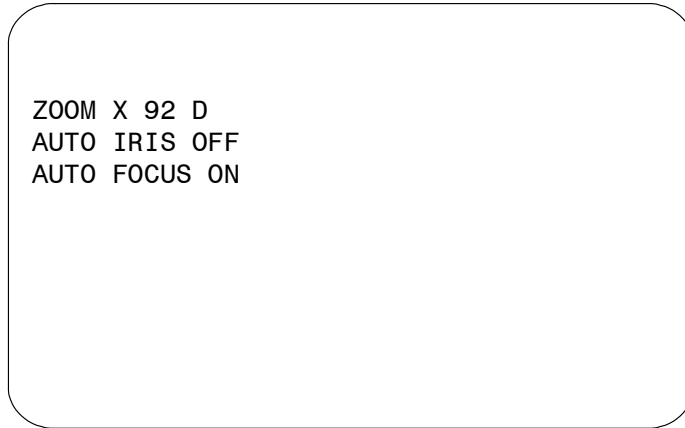

Note: Displaying status information is separate from displaying name information. If the **Disable All Names?** setting is set to **Yes**, the status information still appears if **Status Display** is set to **On**.

Changing the Display of Status Information

1. Select *On-Screen Text Display* from the *Dome Configuration Menu*.
The highlight bar appears on **Status Display**.
2. Change the setting.
 - Select **On** to display dome status information on the monitor.
 - Select **Off** to prevent dome status information from appearing on the monitor.

The default setting is Off.
3. Select **Exit**. The *Dome Configuration Menu* appears. Continue with *What To Do Next* on page 5-11.

Displaying or Hiding All Name Information

The dome provides the ability to display the dome name, the area where the dome is pointing, the name of the preset or pattern that is running, and alarm names. When the display of camera or area names is enabled, the information appears on the screen continuously. Preset, pattern, and alarm names appear only while they are active.

Figure 5-2: Display Locations for Name Information

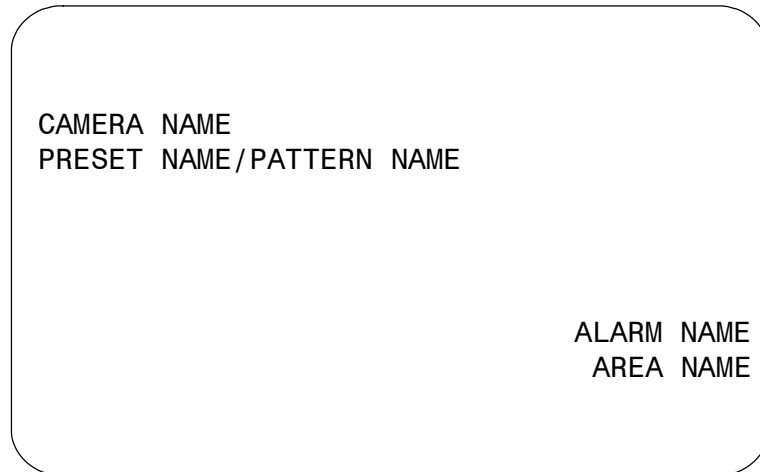

You may choose to disable displaying all name information, or you may choose to display selected or all name information.

Changing the Display of All Name Information

1. Select *On-Screen Text Display* from the *Dome Configuration Menu*.
2. Move the highlight to **Disable All Names?**
3. Change the setting.
 - Select **Yes** to disable the appearance of all name information.
 - Select **No** to enable the appearance of all or some name information. Then continue with *Configuring the Display of Name Information* on page 5-6.

The default setting is No.
4. Select **Exit**. The *Dome Configuration Menu* appears. Continue with *What To Do Next* on page 5-11.

Displaying Diagnostic Tests During Reset

You can choose to have dome diagnostic tests run whenever the dome resets. The diagnostic information displayed includes:

- Communications Loopback Test
- Camera Loopback Test
- Motor Circuit Test

If you do not want diagnostic information to appear when the dome resets, a screen displaying the firmware version numbers for the Boot and Application code and the maximum optical zoom for the dome appears.



IMPORTANT

Enabling diagnostic tests may cause a momentary loss of communication on the network when the dome diagnostics are executed.

Changing the Display of Diagnostic Information

1. Select *On-Screen Text Display* from the *Dome Configuration Menu*.
2. Move the highlight to ***Diagnostic Display***.
3. Change the setting.
 - If you want diagnostic tests to run when the dome resets, select **On**.
 - If you do not want diagnostic tests to run when the dome resets, select **Off**. This choice displays the firmware versions whenever the dome resets.

The default setting is Off.

4. Select ***Exit***. The Dome Configuration Menu appears. Continue with ***What To Do Next*** on page 5-11.

Displaying Direction Indicators

Direction Indicators let you know the approximate pointing direction of the dome in relation to an established point called “North”. Directions for setting the North Position are covered in **Chapter 4**.

When enabled, the Direction Indicators appear along the top edge of the display. In addition, a tilt elevation indicator also appears along the left edge of the display. The value of the tilt elevation indicator is relative to the “virtual horizon” of 0° tilt. By default, the display of Direction Indicators is disabled.

Figure 5–3 illustrates the locations of the Direction Indicators on the display.

Figure 5–3: Screen locations for Direction Indicators

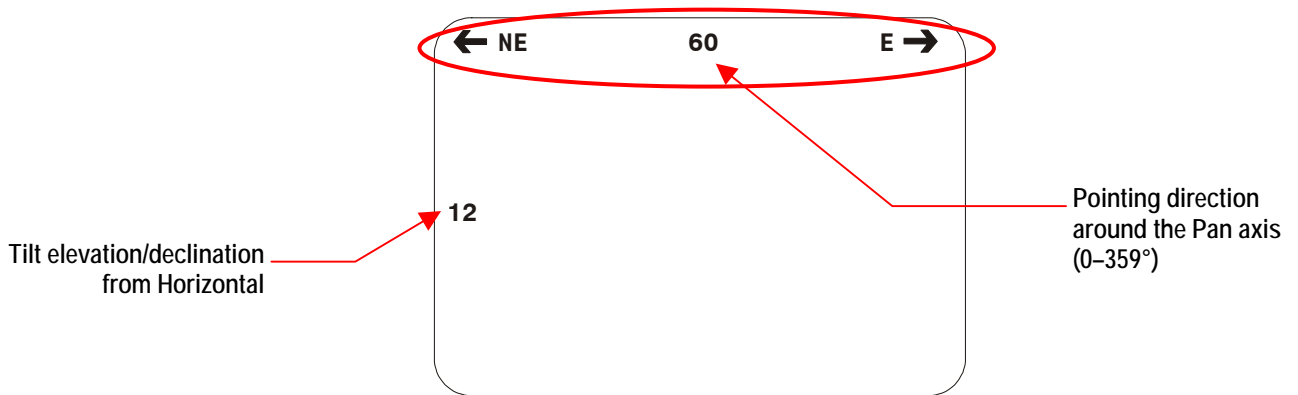

In this example, the current pointing position is 60° from North. The tilt elevation is 12° above the virtual horizon. Panning to the left points the dome towards the Northeast. Panning to the right points the dome towards the East. If you tilt below the virtual horizon, the negative values will be displayed along the left edge (for example, -25). The elevation values range from +25° to -90°.

If you pan to a position that corresponds to a well-known navigational heading, the label corresponding to the heading appears in the center position. Figure 5–4 illustrates the navigational headings and their corresponding degrees from North.

Figure 5–4: Navigational headings and corresponding degrees from North

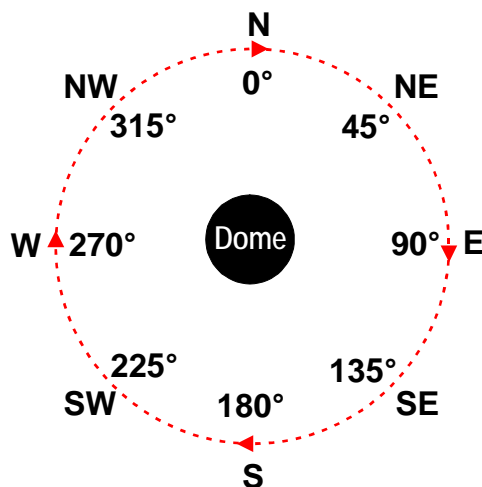

In this illustration, the black circle in the center represents the dome, the dotted circle represents the pan axis, and the arrowheads represent panning the dome to the right.

Figure 5–5 represents pointing the dome precisely at 225° from North (Southwest) with a tilt of 25° below the virtual horizon. Panning to the left points the dome towards the South. Panning to the right points the dome towards the West.

Figure 5–5: Pointing the dome precisely southwest with a tilt elevation of –25°

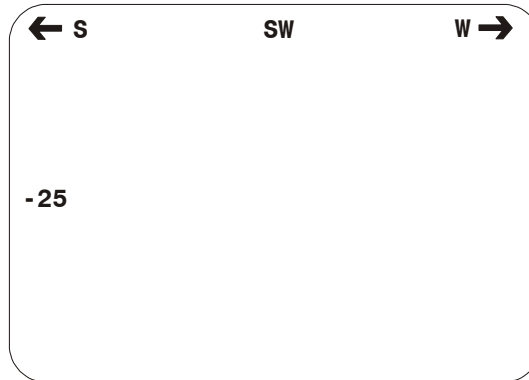

Changing the Display of Direction Indicators

1. Select *On-Screen Text Display* from the *Dome Configuration Menu*.
2. Move the highlight to **Direction Indicator**.
3. Change the setting.
 - Select **On** to display the direction information.
 - Select **Off** to prevent the direction information from displaying.

The default setting is Off.
4. Select *Exit*. The *Dome Configuration Menu* appears. Continue with *What To Do Next* on page 5–11.

Configuring the Display of Name Information

Use the **Name Configuration Menu** to select which name information appears on-screen. To display this screen, select *Name Configuration Menu* from the *On-Screen Text Display* screen. The following screen appears:

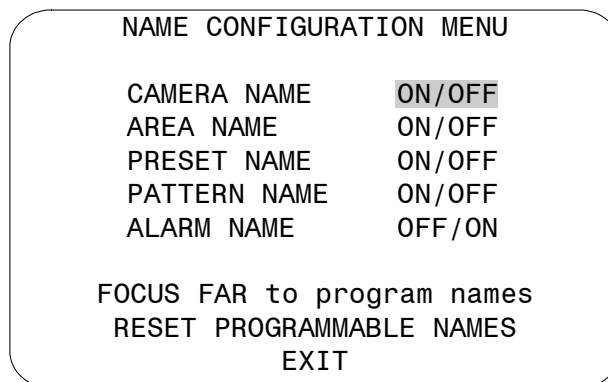

You can choose to enable or disable the display of camera, area, preset, pattern, and alarm names from this screen. You can reset all programmable names to their default settings. You may also initiate name programming from this screen. See *Assigning or Changing Name Information* on page 5–7.

Changing the Display of *Selected* Name Information

1. Select *On-Screen Text Display* from the *Dome Configuration Menu*.
2. Move the highlight to *Name Configuration Menu* and select.
The *Name Configuration Menu* appears.
3. Move the highlight bar to the item whose display setting you want to change.
4. Change the setting.
 - Choose **On** to display name information on the monitor.
 - Choose **Off** to prevent name information from appearing on the monitor.

The default settings are Off for Camera, Areas, Presets, and Patterns, and On for Alarms.

5. Repeat steps 3 and 4 for each item you want to change.
6. Do one of the following:
 - To reset all programmable names to their default values, select **Reset Programmable Names**. Continue with step 7.
 - If you do not want to reset the programmable names, continue with step 8.
7. The following prompt appears on the screen:

RESET PROGRAMMABLE NAMES **NO**

 - To reset all names to the default value, select **Yes**. The *Name Configuration Menu* displays. "**Programmable Names Have Been Reset**" appears at the bottom of the screen.
 - To cancel resetting of names, select **No**. The *Name Configuration Menu* displays.
The default selection is No.
8. Do one of the following:
 - To change programmable name information, continue with *Assigning or Changing Name Information* on page 5–7.
 - To return to the *On-Screen Text Display* settings screen, select **Exit**. Continue with step 9.
9. Select **Exit**. The *Dome Configuration Menu* appears. Continue with *What To Do Next* on page 5–11.

Assigning or Changing Name Information

With the *Name Configuration Menu* displayed, you can select a menu item to begin name programming.

Names for each selection can be up to 19 characters long. The following characters are available:

- A-Z (upper case)
- a-z (lower case)
- 0-9
- Blank Space
- Minus Sign (-)
- Forward Slash (/)

Setting or Changing Names

1. Select *On-Screen Text Display* from the *Dome Configuration Menu*.
2. Select *Name Configuration Menu*.
The *Name Configuration Menu* appears.
3. Select the name setting you want to change. The choices are **Camera Name**, **Area Name**, **Preset Name**, **Pattern Name**, and **Alarm Name**.
 - If you choose *Camera Name*, continue with step 6.
 - If you choose *Area Name*, *Preset Name*, *Pattern Name*, or *Alarm Name*, continue with step 4.
4. The **Select Name to Program** screen appears.

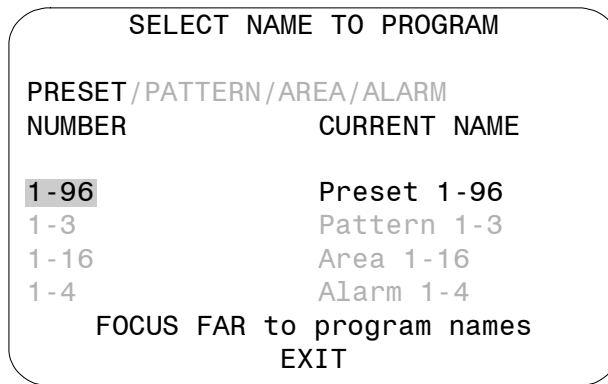

Note: Gray text refers to other options that may appear on-screen.

5. Press **Zoom** to change the number. When the item whose name you want to change appears press **Focus Far**.
Note: If Presets, Patterns, or Areas have been programmed, the dome automatically points to the starting position of the associated selection each time the number is advanced.
6. The **Name Programming** screen appears.

Figure 5-6: Example Name Programming Screen

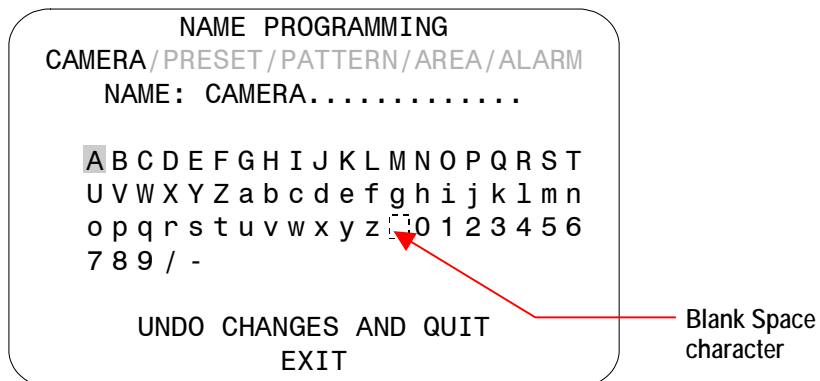

7. Move the blinking highlight around the available characters. When the correct character is highlighted, press **Focus** to select it.
If you make a mistake, **Zoom In** moves the cursor one space right, and **Zoom Out** moves the cursor one space left in the name.
8. Repeat step 7 until the name is complete.
9. Do one of the following:
 - To save the name changes, select **Exit**.
 - To discard the name changes, select **Undo Changes and Quit**.
10. Do one of the following:
 - If you were changing the camera name, continue with step 12.
 - If you were changing the name of an area, preset, pattern or alarm, the *Select Name to Program* screen appears. Continue with step 11.
11. Do one of the following:
 - To make additional changes to the same type of name selected in step 3, repeat steps 4 through 10.
 - To return to the *Name Configuration Menu*, select **Exit**, and continue with step 12.
12. Do one of the following:
 - To make additional name changes, repeat steps 3 through 11.
 - To return to *On-Screen Text Display*, select **Exit**. Continue with step 13.
13. Select **Exit**. The *Dome Configuration Menu* appears. Continue with *What To Do Next* on page 5–11.

Changing the Settings for Text Displayed On-Screen

You may customize the way text is displayed on-screen. You have the choice of displaying text as translucent (slightly clear) or solid, with or without outlines. To change these settings, select **Text Attribute Options** from the *On-Screen Text Display* screen. The following screen appears:

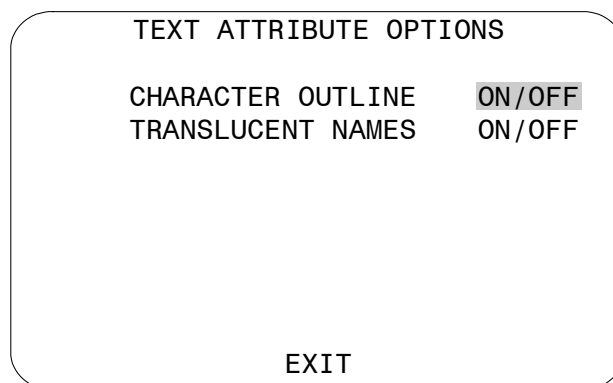

Figure 5–7 illustrates the types of text attributes available.

Figure 5-7: Examples of text attributes



If the video background is light, enable character outlines. If on-screen text obscures the video being displayed, enable translucent names. Character outlines and translucent names may be used together to best suit your video environment.



IMPORTANT

If you have Privacy Zones enabled, the appearance of the text automatically changes to solid. Changing the text appearance to translucent will have no effect until the Privacy Zones are hidden or deleted. See *Chapter 4* for more information about Privacy Zones.

Changing On-Screen Text Appearance

1. Select *On-Screen Text Display* from the *Dome Configuration Menu*.
2. Move the highlight to **Text Attribute Options** and select.
The *Text Attribute Options* screen appears. The highlight bar appears on **Character Outline**.
3. Change the setting.
 - Select **On** to display text with an outline around each character.
 - Select **Off** to display without an outline around each character.

The default setting is On.
4. Do one of the following:
 - If you want to change the text appearance for dome names and status information, move the highlight bar to **Translucent Names**. Continue with step 5.
 - If you are finished making changes, continue with step 6.
5. Change the *Translucent Names* setting.
 - Select **On** to display text associated with dome names and status information as translucent (slightly clear).
 - Select **Off** to display text associated with dome names and status information as solid.

The default setting is On.
6. Select **Exit** to return to the *On-Screen Text Display* screen.
7. Select **Exit**. The *Dome Configuration Menu* appears. Continue with *What To Do Next* on page 5-11.

What To Do Next

When you select **Exit** from the *On-Screen Text Display* screen, the *Dome Configuration Menu* appears.

Figure 5–8: Dome Configuration Menu

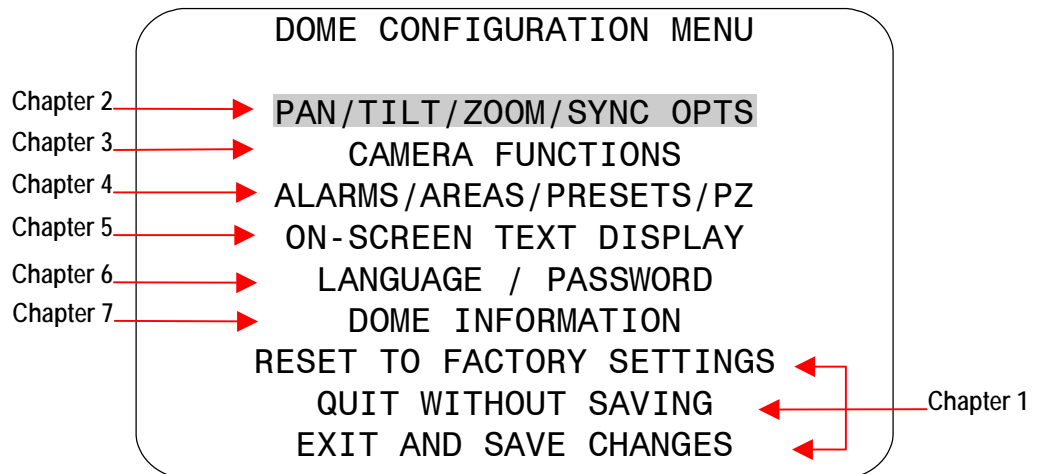

From this screen you can:

- Select an option to make additional changes.
- Restore all settings to the factory defaults.
- Exit the utility without saving changes.
- Save the changes made and exit the utility.

Move the highlight bar to an item and select it. Refer to the related chapter for additional information.

NOTES

CHAPTER 6

Configuring Language and Password Settings

This chapter explains how to change the language for dome messages and text, and how to set and enable the dome password.

In This Chapter

- Overview of Language and Password Settings 6-1
- Selecting a Language for Dome Messages and Prompts 6-2
- Setting and Enabling the Dome Password 6-3
- What To Do Next 6-4

Overview of Language and Password Settings

When **Language / Password** is selected from the *Dome Configuration Menu*, the following screen appears:

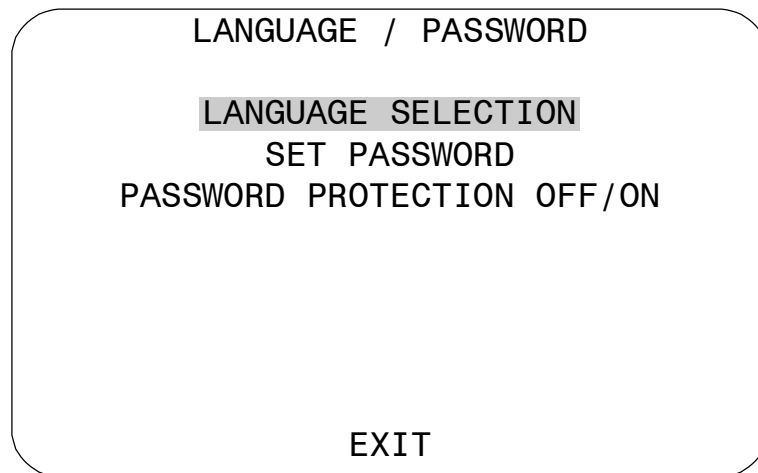

From this screen, you can choose the language for the menus, status information, and prompts from the dome. You can also set and enable the use of the dome password.

- To make changes, select a menu item to display the associated settings.
- To change the settings, move the highlight bar to appropriate field and make the changes.
- To return to the *Dome Configuration Menu*, select **Exit**.

Selecting a Language for Dome Messages and Prompts

The dome supports menus, status information and prompts in English, Spanish, French, German, Italian, and Portuguese. When the dome is initially installed, the language setting is English.



IMPORTANT

If Portuguese is the selected language, the characters “ã” and “õ” will not be displayed on the screen. This is due to a limitation of the text overlay chip.

Changing the Language Setting

1. Select *Language/Password* from the *Dome Configuration Menu*.
2. Select **Language Selection**.

The *Language Selection* screen appears:



Move the highlight bar to the preferred language setting.

The default setting is English.

3. Select the highlighted language. The following screen appears:

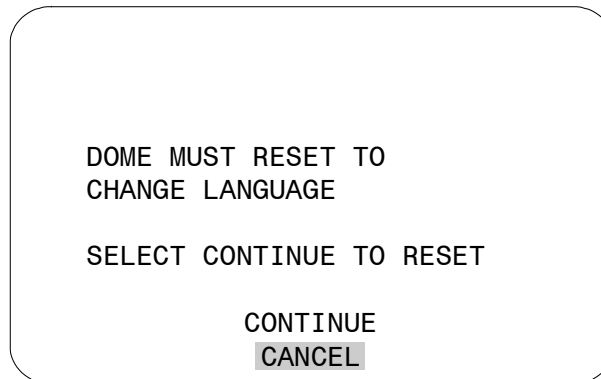

The highlight bar appears on *Cancel*.



Note: Changing the language does not alter any previously programmed names. Only default names, such as **Preset 1**, change to the new language setting

4. Do one of the following:
 - To continue with changing the language, select **Continue**. The dome automatically resets. To verify the language change, continue with step 5. Otherwise, continue with step 6.
 - To cancel the language change, select **Cancel**. The *Language Selection* screen appears. You may choose a different language, or select **Exit** to return to the *Language / Password* screen. Continue with step 6.
5. Start the *Dome Configuration Menu*. The menu will appear in the new language setting.
6. To make changes to other settings, continue with **What To Do Next** on page 6–4.

Setting and Enabling the Dome Password

To prevent unauthorized use of the configuration utility, you may choose to enable password protection. There are two parts to using passwords with your dome: setting a password and enabling password use. The dome password can be from 1 to 8 characters long. The characters available depend on the current language setting.

Setting or Changing the Dome Password

1. Select *Language/Password* from the *Dome Configuration Menu*.
2. Select **Set Password**.

The *Set Password* screen appears.

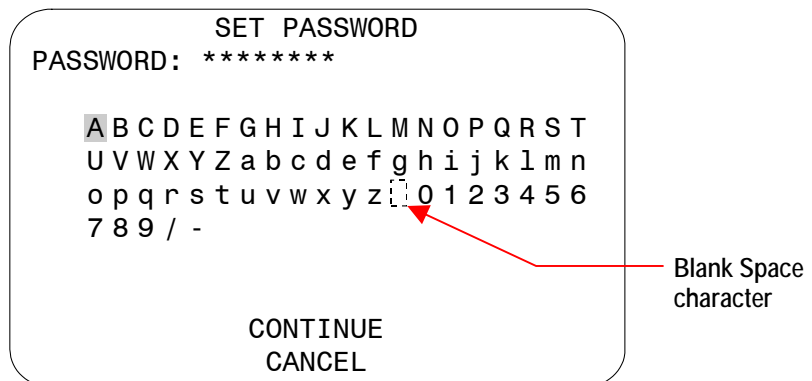

3. Move the blinking highlight around the available characters. When the correct character is highlighted, press **Focus**.
If you make a mistake, press **Zoom In** to move the cursor one space right or **Zoom Out** to move the cursor one space left.
4. Repeat step 3 until the password is complete. When finished, select **Continue**.
5. You must successfully enter the password twice. Use the procedure in step 3 to enter the password again. When finished, select **Continue**.



Note: If the passwords do not match, you must start over. Return to step 3 and repeat the procedure.

6. The *Language/Password* screen appears. Select **Exit**. The *Dome Configuration Menu* appears. Continue with **What To Do Next** on page 6–4.

Enabling or Disabling Password Protection

Password protection must be enabled before passwords can be used. To enable or disable the dome password:

1. Select *Language/Password* from the *Dome Configuration Menu*.
2. Move the highlight bar to **Password Protection**.
3. Change the setting.
 - Select **On** to enable password protection.
 - Select **Off** to disable password protection.

The default setting is Off.

4. Select **Exit**. The *Dome Configuration Menu* appears. Continue with *What To Do Next* on page 6–4.



Tip: Instructions for entering the dome password are found in *Chapter 1*.

What To Do Next

When you select **Exit** from the *Language / Password* screen, the *Dome Configuration Menu* appears.

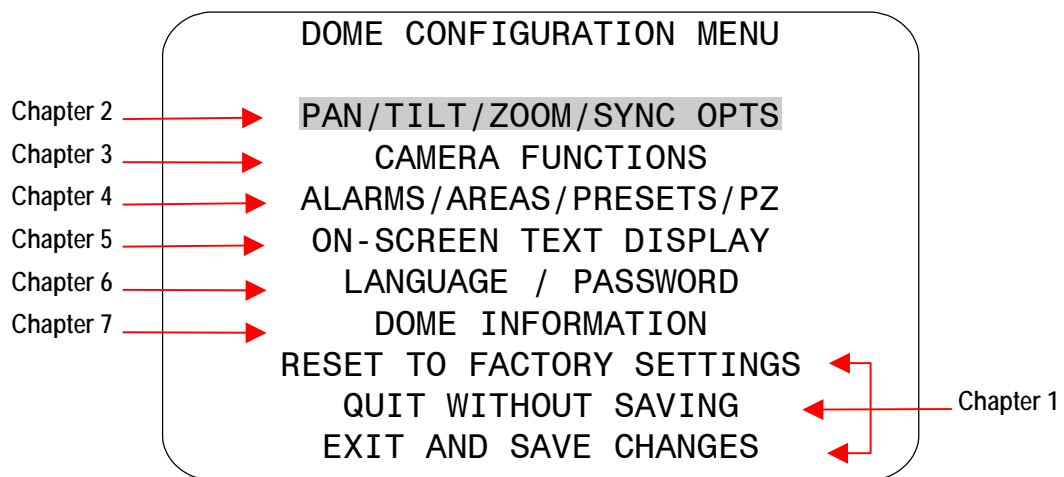

From this screen you can:

- Select an option to make additional changes.
- Restore all settings to the factory defaults.
- Exit the utility without saving changes.
- Save the changes and exit the utility.

Move the highlight bar to an item and select it. Refer to the related chapter for additional information.

CHAPTER 7

Displaying Dome Information

This chapter explains how to display dome information and operating information.

In This Chapter

- Understanding the Dome Information Screen..... 7-1
- Viewing Dome Operating Statistics..... 7-2
- What To Do Next..... 7-3

Understanding the Dome Information Screen

The **Dome Information** screen provides essential information about the SpeedDome Ultra VII Day/Night camera dome if service is required. When you view this screen, you can determine the dome type, mnemonic, software version, serial number, and manufacture date.

```
DOMI INFORMATION
NAME:           SpeedDome Ultra VII
Mnemonic:      SDU 7
Software Ver:   0710-0147-0100
Device Type:   24770105
SN: 01234567890123456789
Manufacture Date: 11012002
Dome Statistics
EXIT
```

The information that appears on the *Dome Information* screen cannot be changed or altered. This feature is provided for information purposes only.



Note: The **Manufacture Date** information appears in **Month-Date-Year (MMDDYYYY)** format.

-
- Select **Dome Statistics** to display additional information.
 - Select **Exit** to return to the *Dome Configuration Menu*.

Viewing Dome Operating Statistics

When **Dome Statistics** is selected from the *Dome Information* screen, the following information is displayed:

DOME STATISTICS			
	PanStat	TiltStat	ZoomStat
R	000000C9	00000085	00000011
L	0000006A	00000074	00000012
M	000001B5	00000089	00000048
T	00000013	00000017	0000000E
Pwr/Run		Pwr/Run	
O	00007615	W	00000000
P	00000000	U	00000000
EXIT			

From this screen, you can identify the operating statistics for various features of the dome. The information represents either runtime in seconds or number of occurrences (displayed in hexadecimal values). The following table describes the abbreviations used.

Abbreviation	Description
R	Time moving <i>right</i> in seconds.
L	Time moving <i>left</i> in seconds.
M	Total <i>move</i> time in seconds.
T	Total <i>target</i> count.
O	<i>Operating</i> time in seconds.
P	<i>Power</i> failure reset count.
W	<i>Watchdog</i> reset count. The watchdog tracks software problems that cause the dome to hang. This number should be zero.
U	<i>User</i> reset count. This represents the resets initiated by the dome operators.

When you are finished viewing the dome statistics, select **Exit** to return to the *Dome Information* screen.

What To Do Next

When you select **Exit** from the *Dome Information* screen, the *Dome Configuration Menu* appears.

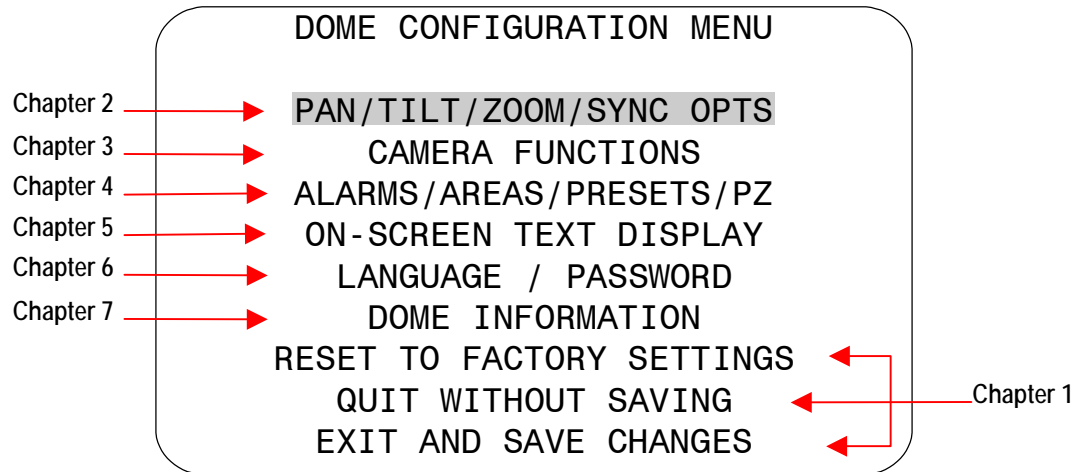

From this screen you can:

- Select an option to make additional changes.
- Restore all settings to the factory defaults.
- Exit the utility without saving changes.
- Save the changes and exit the utility.

Move the highlight bar to an item and select it. Refer to the related chapter for additional information.

N O T E S :

APPENDIX A

SensorNet and RS-422 Command Summary

This appendix summarizes the SensorNet and RS-422 controller commands used with the Configuration Utility. It also provides a list of compatible controllers.

In This Appendix

- Command Summary..... A-2
- Supported Controllers and Matrix Switching Systems A-3
- Performance Notes A-6

Command Summary

The following table lists the commands to operate the configuration utility when the dome is installed in a SensorNet or RS-422 environment.

If you want to ...	Use ...
Start the configuration utility.	Press and hold Iris Open , press and hold a Focus button , then press Zoom Out*
Move the highlight bar on the active menu.	Pan/Tilt
Select the highlighted item on the active menu.	Focus
Increase the value of the selected setting. For example, Red or Blue white balance values.	Zoom In
Decrease the value of the selected field. For example, Red or Blue white balance values.	Zoom Out
Display the next choice for the setting. For example, Maximum Zoom setting.	Zoom In
Display the previous choice for the setting. For example, Maximum Zoom setting.	Zoom Out
Save changes and exit the utility from any screen.	Iris Close , then Focus*
Manually activate or deactivate IR mode .	Press and hold Iris Open , press and hold Focus Far , then press Focus Near*

* These commands not supported with MPLT with ADCC0200 or ADCC0300 controller. Refer to the appropriate operator's manual for instructions.

Setting Names / Working with Passwords

When setting names or entering password information, the screen displays the available characters in the selected languages. In these situations, the following commands are used:

If you want to ...	Use ...
Move the highlight left or right in the character field.	Pan
Move the highlight up or down in the character field.	Tilt
Select the highlighted character in the character field.	Focus
Move the cursor to the right of the current character in the name or password.	Zoom In
Move the cursor to the left of the current character in the name.	Zoom Out

Supported Controllers and Matrix Switching Systems

This section provides information about the SensorNet and RS-422 controllers and matrix switchers that are compatible with SpeedDome Ultra VII Day/Night. Refer to the controller information for details concerning specific functions supported.



Note: This list of controllers is complete as of the time of publication. Other controllers may be supported. Contact your Sales Representative for current information.

Controller/Switcher	Page Number	Controller/Switcher	Page Number
• VM8	A-3	• AD1650	A-4
• VM16/ADTT16	A-3	• AD168	A-5
• VM16E/ADTT16E	A-3	• AD2050	A-5
• VM32/AD32	A-4	• MegaPower LT	A-5
• VM96	A-4	• MegaPower 48	A-5
• AD2150/AD2350	A-4	• MegaPower 1024	A-5

VM8

Supported Protocol	SensorNet
Maximum Presets	0
Maximum Patterns ⁽¹⁾	1
Quick Set Menu	Not supported
Address Range	1-8

Notes:

(1) Apple Peel only. Programmable patterns are not available.

VM16/ADTT16 (White Touch Tracker)

Supported Protocols	SensorNet RS-422 ⁽¹⁾
Maximum Presets	96 – SensorNet 4 – RS-422
Maximum Patterns ⁽²⁾	3
Quick Set Menu	Not supported
Address Range	1-16

Notes:

- (1) Requires RCSN422 code converter.
- (2) Patterns are limited by time and the number of available dome commands. Total time for each pattern cannot exceed 6 minutes 50 seconds. Total dome commands used in all patterns cannot exceed 99.

VM16E/ADTT16E (Black Touch Tracker)

Supported Protocols	SensorNet RS-422 ⁽¹⁾
Maximum Presets	96 – SensorNet 4 – RS-422
Maximum Patterns ⁽²⁾	3
Quick Set Menu	Yes ⁽³⁾
Address Range	1-16 or 1-64 ⁽³⁾

Notes:

- (1) Requires RCSN422 code converter.
- (2) Patterns are limited by time and the number of available dome commands. Total time for each pattern cannot exceed 6 minutes 50 seconds. Total dome commands used in all patterns cannot exceed 99.
- (3) Requires firmware version 0701-2833-0103 (EEPROM) / 0701-2834-0201 (Flash PROM) or newer.

VM32/AD32

Supported Protocols	SensorNet RS-422 ⁽¹⁾
Maximum Presets	96 – SensorNet 4 – RS-422
Maximum Patterns ⁽²⁾	3
Quick Set Menu	Not supported
Address Range	1-32

Notes:

- (1) Requires RCSN422 code converter.
- (2) Patterns are limited by time and the number of available dome commands. Total time for each pattern cannot exceed 6 minutes 50 seconds. Total dome commands used in all patterns cannot exceed 99.

VM96 ⁽¹⁾

Supported Protocols	SensorNet RS-422
Maximum Presets	Unlimited ⁽²⁾
Maximum Patterns ⁽³⁾	3
Quick Set Menu	Not supported
Address Range	1-96

Notes:

- (1) Requires software version 5.2 or newer.
- (2) Preset information is stored at the host, not the dome.
- (3) Patterns are limited by time and the number of available dome commands. Total time for each pattern cannot exceed 6 minutes 50 seconds. Total dome commands used in all patterns cannot exceed 99.

AD2150/AD2350

Supported Protocol	RS-422 ⁽¹⁾
Maximum Presets	16 ⁽²⁾ or 60 ⁽³⁾
Maximum Patterns ⁽⁴⁾	3
Quick Set Menu	Not supported
Address Range	1-32

Notes:

- (1) Requires the AD2083-02 series code converter.
- (2) Preset information is stored at the converter, not the dome.
- (3) Requires AD2083-02 with firmware version 0701-11YB-156A or newer. Preset information is stored in the dome, not the converter.
- (4) Patterns are limited by time and the number of available dome commands. Total time for each pattern cannot exceed 6 minutes 50 seconds. Total dome commands used in all patterns cannot exceed 99.

AD1650

Supported Protocol	RS-422 ⁽¹⁾
Maximum Presets	16 ⁽²⁾ or 60 ⁽³⁾
Maximum Patterns ⁽⁴⁾	3
Quick Set Menu	Not supported
Address Range	1-128 ⁽⁵⁾

Notes:

- (1) Requires the AD2083-02 series code converter.
- (2) Preset information is stored at the converter, not the dome.
- (3) Requires AD2083-02 with firmware version 0701-11YB-156A or newer. Preset information is stored in the dome, not the converter.
- (4) Patterns are limited by time and the number of available dome commands. Total time for each pattern cannot exceed 6 minutes 50 seconds. Total dome commands used in all patterns cannot exceed 99.
- (5) Requires additional equipment to achieve these numbers. A dome address within each group of 64 or 99 cameras is reserved as a global broadcast address.

AD168

Supported Protocols	SensorNet ⁽¹⁾ RS-422 ^{(1) or (2)}
Maximum Presets	16 ⁽¹⁾⁽²⁾ , 64 ⁽¹⁾⁽³⁾ , or 60 ⁽⁴⁾
Maximum Patterns ⁽⁵⁾	3
Quick Set Menu	Not supported
Address Range	SensorNet: 1-180 RS-422: 1-99 ⁽¹⁾⁽⁶⁾ or 1-180 ⁽²⁾⁽⁶⁾

Notes:

- (1) Requires the appropriate code control module.
- (2) Requires the AD2083-02 series code converter.
- (3) Presets information is stored at the converter or control module, not the dome.
- (4) Requires AD2083-02 with firmware version 0701-11YB-156A or newer. Preset information is stored in the dome, not the converter.
- (5) Patterns are limited by time and the number of available dome commands. Total time for each pattern cannot exceed 6 minutes 50 seconds. Total dome commands used in all patterns cannot exceed 99.
- (6) Requires additional equipment to achieve these numbers. A dome address within each group of 64 or 99 cameras is reserved as a global broadcast address.

AD2050

Supported Protocol	RS-422 ⁽¹⁾
Maximum Presets	16 ⁽²⁾ or 60 ⁽³⁾
Maximum Patterns ⁽⁴⁾	3
Quick Set Menu	Not supported
Address Range	1-1024 ⁽⁵⁾

Notes:

- (1) Requires the AD2083-02 series code converter.
- (2) Preset information is stored at the converter, not the dome.
- (3) Requires AD2083-02 with firmware version 0701-11YB-156A or newer. Preset information is stored in the dome, not the converter.
- (4) Patterns are limited by time and the number of available dome commands. Total time for each pattern cannot exceed 6 minutes 50 seconds. Total dome commands used in all patterns cannot exceed 99.
- (5) Requires additional equipment to achieve these numbers. A dome address within each group of 64 or 99 cameras is reserved as a global broadcast address.

MegaPower LT

Supported Protocol	SensorNet
Maximum Presets	96
Maximum Patterns ⁽¹⁾	3
Quick Set Menu	Yes ⁽²⁾
Address Range	1-32

Notes:

- (1) Patterns are limited by time and the number of available dome commands. Total time for each pattern cannot exceed 6 minutes 50 seconds. Total dome commands used in all patterns cannot exceed 99.
- (2) Requires a compatible keyboard.

MegaPower 48

Supported Protocols	SensorNet RS-422
Maximum Presets	96 ⁽¹⁾
Maximum Patterns ⁽²⁾	3
Quick Set Menu	Yes ⁽³⁾
Address Range	1-48

Notes:

- (1) Preset information is stored at the host, not the dome.
- (2) Patterns are limited by time and the number of available dome commands. Total time for each pattern cannot exceed 6 minutes 50 seconds. Total dome commands used in all patterns cannot exceed 99.
- (3) Requires firmware 1.07 or newer and a compatible keyboard.

MegaPower 1024

Supported Protocol	RS-422 ⁽¹⁾
Maximum Presets	16 ⁽²⁾ or 60 ⁽³⁾
Maximum Patterns ⁽⁴⁾	3
Quick Set Menu	Not supported
Address Range	1-1024 ⁽⁵⁾

Notes:

- (1) Requires the AD2083-02 series code converter.
- (2) Preset information is stored at the converter, not the dome.
- (3) Requires AD2083-02 with firmware version 0701-11YB-156A or newer. Preset information is stored in the dome, not the converter.
- (4) Patterns are limited by time and the number of available dome commands. Total time for each pattern cannot exceed 6 minutes 50 seconds. Total dome commands used in all patterns cannot exceed 99.
- (5) Requires additional equipment to achieve these numbers. A dome address within each group of 64 or 99 cameras is reserved as a global broadcast address.

Performance Notes

The following considerations should be made when using the SpeedDome Ultra VII Day/Night camera dome in a SensorNet or RS-422 environment.

Alarm Action Configuration

The following controllers allow the alarm actions for domes to be specified at the controller:

- VM16 Plus/ADTT16/ADTT16E
- VM32/AD32/AD32E
- VM96
- Touch Tracker 16 Elite
- AD matrices with AD2083-02A code units
- AD168/MP168 with CCM or AD2083-02A.

Do not use both the dome configuration utility and the controller to assign the alarm actions for the same input. ***Use only the dome configuration utility or the controller to the assign the alarm actions.***

APPENDIX B

Manchester Command Summary

This appendix summarizes the Manchester controller commands used with the Configuration Utility. It also provides a list of additional Manchester commands that can be used with the dome and compatible controllers.

In This Appendix

- Command Summary..... B-2
- Supported Controllers B-4
- Performance Notes B-4

Command Summary

The following table lists the commands to operate the configuration utility when the dome is installed in a Manchester environment. The keyboard must be in programming mode to perform these functions.

If you want to ...	Use ...
<i>Start</i> the configuration utility.	66 , then press Set Preset ¹
Move the <i>highlight bar</i> on the active menu.	Pan/Tilt
<i>Select</i> the highlighted item on the active menu.	Focus
<i>Increase</i> the value of the selected setting. For example, Red or Blue white balance values.	Zoom In
<i>Decrease</i> the value of the selected field. For example, Red or Blue white balance values.	Zoom Out
Display the <i>next choice</i> for the setting. For example, Maximum Zoom setting.	Zoom In
Display the <i>previous choice</i> for the setting. For example, Maximum Zoom setting.	Zoom Out
Save changes and exit the utility from any screen.	Iris Close , then Focus

Setting Names / Working with Passwords

When setting names or entering password information, the screen displays the available characters in the selected languages. In these situations, the following commands are used:

If you want to ...	Use ...
Move the <i>highlight left or right</i> in the character field.	Pan
Move the <i>highlight up or down</i> in the character field.	Tilt
<i>Select</i> the highlighted character in the character field.	Focus
Move the cursor to the <i>right of the current character</i> in the name or password.	Zoom In
Move the cursor to the <i>left of the current character</i> in the name.	Zoom Out

¹ The label may read **Set Shot** on some keyboards.

Additional Manchester Commands

The following tables summarize the special commands available when using the dome in a Manchester network. These commands are available when you enter the number listed and press the **Set Preset** or **Call Preset** button on the controller.

Set Commands

This table describes the functions that can be performed when you enter the number listed then press the **Set Preset** button. The keyboard must be in programming mode to perform these functions.

If you want to ...	Use ...
Reset the Dome	65 Set Preset
Activate / Deactivate V-phase delay setting adjustment	67 Set Preset
Cancel Pattern Programming	68 Set Preset
Save Pattern Programming	69 Set Preset
Program Pattern 1	70 Set Preset
Program Pattern 2	71 Set Preset
Program Pattern 3	72 Set Preset

Call Commands

This table describes the functions that can be performed when you enter the number listed then press the **Call Preset** button.

If you want to ...	Use ...
Resume Auto Focus / Auto Iris	66 Call Preset
Rotate dome 180° from current position (“flip”)	67 Call Preset
Activate/Deactivate IR mode	68 Call Preset²
Repeats following pattern	69 Set Preset
Run Pattern 1	70 Set Preset
Run Pattern 2	71 Set Preset
Run Pattern 3	72 Set Preset

² This command changes the IR Mode setting on the Camera Functions menu. See Chapter 3 for information.

Supported Controllers

The following Manchester controllers are compatible with SpeedDome Ultra VII Day/Night:

Controller	Presets	Patterns	Quick Set Menu	Address Range
AD2150	64	3	No	1-64
MP48	64	3	No	1-64
AD168/MP168	64	3	No	1-64
AD2050/2052	64	3	No	1-64

This list of controllers is complete as of the time of publication. Other controllers may be supported. Contact your Sales Representative for current information.

Performance Notes

The following considerations should be made when using the SpeedDome Ultra VII Day/Night camera dome in a Manchester environment.

Using Auxiliaries

The dome provides four connections for auxiliaries. When used on a Manchester network, Auxiliaries 1 through 3 are supported. Auxiliary 4 is not supported.

Alarm Inputs

When operating on a Manchester network, the dome can be programmed to respond to any of the four available alarm inputs. However, the dome cannot transmit alarm input states to the host controller. If transmitting the alarm input states to the host controller is required, the alarm device must be wired directly to the host controller.

APPENDIX C

Pelco Coaxitron and “P” Protocols Command Summary

This appendix summarizes the SpeedDome Ultra VII features that are supported by the Pelco Coaxitron and “P” protocols. In addition, it provides the controller commands used with the Configuration Utility. It also supplies information about tested Pelco equipment and supported Pelco features.

In This Appendix

- Supported SpeedDome Ultra VII Features..... C-2
- Pelco Command Summary..... C-3
- Performance Notes C-4
- Tested Pelco Equipment..... C-4
- Supported Pelco Features C-4

Supported SpeedDome Ultra VII Features

The following SpeedDome Ultra VII Day/Night features are supported with Coaxitron and P protocols:

- 10X digital zoom (up to 230X total zoom)
- 85 Total Presets (1-32, 35-87)
- 3 Patterns
- 16 Areas
- 4 Alarm Inputs and Outputs
- 8 Privacy Zones
- Programmable Names (camera, preset, pattern, areas, and alarms)
- Open Shutter settings
- IR Mode
- Wide Dynamic Range (WDR)
- Proportional Flip
- Freeze Frame
- Direction Indicator display
- Multi-language Dome Configuration Utility (available in English, French, German, Italian, Portuguese, and Spanish) with Password Protection

Unsupported SpeedDome Ultra VII Features

The following SpeedDome Ultra VII features are not supported with the Pelco Coaxitron and “P” protocols:

- Save and exit from configuration menus using **Iris Close** and **Focus** keys
- Apple Peel pattern (default SpeedDome pattern)
- V-Phase adjustment

Pelco Command Summary

The following table lists the commands to operate the configuration utility when the dome is installed in a Pelco environment.

If you want to ...	Use ...
Start the configuration utility.	Set Preset 95
Move the highlight bar on the active menu.	Tilt Up/Down
Select the highlighted item on the active menu.	Iris Open (or Focus)
Increase the value of the selected setting. For example, Red or Blue white balance values.	Pan Right (or Zoom In)
Decrease the value of the selected field. For example, Red or Blue white balance values.	Pan Left (or Zoom Out)
Display the next choice for the setting. For example, Maximum Zoom setting.	Pan Right (or Zoom In)
Display the previous choice for the setting. For example, Maximum Zoom setting.	Pan Left (or Zoom Out)

Setting Names / Working with Passwords

When setting names or entering password information, the screen displays the available characters in the selected languages. In these situations, the following commands are used:

If you want to ...	Use ...
Move the highlight left or right in the character field.	Pan
Move the highlight up or down in the character field.	Tilt
Select the highlighted character in the character field.	Iris Open (or Focus)
Move the cursor to the right of the current character in the name or password.	Pan Right (or Zoom In)
Move the cursor to the left of the current character in the name.	Pan Left (or Zoom Out)

Additional Controller Commands

Use the following controller commands to perform these SpeedDome Ultra functions:

If you want to...	Use...
Flip the dome 180°	Call Preset 33
Return to 0° pan	Call Preset 34
Turn IR Mode On	Set Preset 88
Turn IR Mode Off	Set Preset 89
Reset Dome	Set Preset 94

Performance Notes

The following SpeedDome Ultra VII features are not supported with the Pelco protocols:

- PAL video format. This will be supported after further testing.
- Long line length applications that require video amplifiers or fiber optics.

Address Settings

The dome must have the correct address setting to operate with Pelco Coaxitron and “P” protocols. For Coaxitron protocol, the address must be set to **893**. For “P” protocol, the address setting is based upon the baud rate setting:

- **For 2400 baud**, the x100 switch must be set to **6**; the x10 and x1 switches may be set to any number.
- **For 4800 baud**, the x100 switch must be set to **0**; the x10 and x1 switches may be set to any number.
- **For 9600 baud**, the x100 switch must be set to **7**, the x10 and x1 switches may set to any number.

Tested Pelco Equipment

The following Pelco equipment has been tested with SpeedDome Ultra VII:

- Pelco 9760CTX
- Pelco MPT 9500

Supported Pelco Features

SpeedDome Ultra VII supports *Left and Right Scan Limits*, *Auto Scan*, *Frame Scan* and *Random Scan* when installed under the Pelco Coaxitron and “P” Protocol environment. The following commands are supported:

If you want to...	Use...
Program the <i>Left Scan Limit</i>	Set Preset 92
Program the <i>Right Scan Limit</i>	Set Preset 93
Activate <i>Auto Scan</i>	Call Preset 99
Activate <i>Frame Scan</i>	Call Preset 98
Activate <i>Random Scan</i>	Call Preset 97
Deactivate Auto, Frame or Random Scan	Call Preset 96

Setting Left and Right Scan Limits

Scan Limits allow you to set left and right boundaries for use with the Auto Scan, Frame Scan, and Random Scan functions. If the scan limits are not set, the dome pans continuously to the right when these functions are activated.



IMPORTANT

You must program the Left Scan Limit setting before programming the Right Scan Limit setting. This procedure erases any previously programmed Right Scan Limit setting.

To program the Scan Limits:

1. Select the camera number assigned to the SpeedDome Ultra VII dome.
2. Use the pan/tilt control to position the dome's pointing direction to the *Left Scan Limit*.
3. Enter **Set Preset 92** to save the setting.
4. Position the dome's pointing direction to *Right Scan Limit*.
5. Enter **Set Preset 93** to save the setting.

Activating Auto Scan

Auto Scan allows the dome to continuously pan between the left and right scan limit settings. When reaching the right scan limit, the direction is automatically reversed. If no scan limit settings are programmed, the dome pans to the right continuously.

To activate the Auto Scan:

1. Select the camera number assigned to the dome.
2. Enter **Go To Preset 99**.

The Auto Scan runs until stopped by selecting the camera and entering **Call Preset 96**.



Note: Entering a pan/tilt or lens command also stops the scan.

Activating Frame Scan

Frame Scan pans between the left and right scan limits, pausing briefly (3 seconds) at each frame. A frame is equivalent to approximately 10° when the zoom setting is 1X. If the scan limits are not programmed, the Frame Scan pans to the right, pausing at each frame.

To activate the Frame Scan:

1. Select the camera number assigned to the SpeedDome Ultra VII dome.
2. Enter **Call Preset 98**.

The Frame Scan runs until stopped by selecting the camera and entering **Call Preset 96**.



Note: Entering a pan/tilt or lens command also stops the scan.

Activating Random Scan

Random Scan pans between the left and right scan limits for random periods between 1 and 9 seconds, then pauses for periods between 1 and 9 seconds. If the scan limits are not programmed, the Random Scan pans to the right for random periods between 1 and 9 seconds, then pauses for periods between 1 and 9 seconds.

To activate the Random Scan:

1. Select the camera number assigned to the SpeedDome Ultra VII dome.
2. Enter **Call Preset 97**.

The Random Scan runs until stopped by selecting the camera and entering **Call Preset 96**.



Note: Entering a pan/tilt or lens command also stops the scan.

APPENDIX D

Panasonic Up-the-Coax (UTC) Protocol Command Summary

This appendix summarizes the SpeedDome Ultra VII features that are supported by the Panasonic UTC protocol. In addition, it provides the controller commands used with the Configuration Utility. It also provides information about tested Panasonic equipment.

In This Appendix

- Supported SpeedDome Ultra VII Day/Night Features..... D-2
- Panasonic UTC Command Summary D-3
- Performance Notes D-4
- Programming Presets D-4
- Tested Panasonic Equipment D-5

Supported SpeedDome Ultra VII Day/Night Features

The following SpeedDome Ultra VII Day/Night features are supported with the UTC (Up-the-Coax) protocol:

- 10X digital zoom (up to 230X total zoom)
- 64 Total Presets
- Apple Peel Pattern (using Auto Pan keys)
- 16 Areas
- 4 Alarm Inputs and Outputs
- 8 Privacy Zones
- Programmable Names (camera, preset, pattern, areas, and alarms)
- Open Shutter settings
- Proportional Flip
- Direction Indicator display
- Dome Configuration Utility (available in English, French, German, Italian, Portuguese, and Spanish) with Password Protection

Unsupported SpeedDome Ultra VII Features

The following SpeedDome Ultra VII features are not supported with the Panasonic UTC protocol:

- Save and exit from configuration menus using **Iris Close** and **Focus** keys
- Patterns
- V-Phase adjustment
- PAL video format. This will be supported after further testing.
- Long line length applications that require video amplifiers or fiber optics

Panasonic UTC Command Summary

The following table lists the commands to operate the configuration utility when the dome is installed in a Panasonic UTC environment.

<i>If you want to ...</i>	<i>Use ...</i>
Start the configuration utility.	Camera Set ON Set Up/Esc + Camera
Move the highlight bar on the active menu.	Up/Down
Select the highlighted item on the active menu.	SET
Increase the value of the selected setting. For example, Red or Blue white balance values.	Right
Decrease the value of the selected field. For example, Red or Blue white balance values.	Left
Display the next choice for the setting. For example, Maximum Zoom setting.	Right
Display the previous choice for the setting. For example, Maximum Zoom setting.	Left
Adjust dome position during menu programming.	ALT

Setting Names / Working with Passwords

When setting names or entering password information, the screen displays the available characters in the selected languages. In these situations, the following commands are used:

<i>If you want to ...</i>	<i>Use ...</i>
Move the highlight left or right in the character field.	ALT enabled, Left/Right
Move the highlight up or down in the character field.	ALT enabled, Up/Down
Select the highlighted character in the character field.	SET
Move the cursor to the right of the current character in the name or password.	ALT disabled, Right Or ALT enabled, Zoom Tele
Move the cursor to the left of the current character in the name.	ALT disabled, Left Or ALT enabled, Zoom Wide

Performance Notes

When selecting a dome, a 3- to 5-second delay is necessary for the Panasonic multiplexer to properly identify the dome type. If the dome is moved before the interrogation is complete, the controller recognizes the dome as a “single speed” dome. Once the dome stops moving and the interrogation completes, the normal 8 speed settings are available.

Address Setting

The dome must have the correct address setting to operate with Panasonic UTC protocol. Set the dome address switches to **890**.

Programming Presets

You must use the **Dome Configuration Menu** to program Presets. Up to 64 Presets may be programmed.



Note: This procedure has been verified using the following equipment:

- WJ-SX550 Multiplexer
- WV-CU550A Controller

1. Select the monitor and camera number assigned to the Speed Dome Ultra VII camera dome.
2. Use the arrow keys on the controller to scroll to the **Camera Setup Menu (D4)**.
3. Press **F1 (On)** key to display the **Dome Configuration Menu**.
4. Use the joystick to move the highlight to **Alarms/Areas/Home/Presets/PZ**. Press **Set** to select.

ALARMS/AREAS/HOME/PRESETS/PZ

SET ALARM ACTIONS
SET ALARM STATES
SET HOME POSITION
SET NORTH POSITION
AREA BOUNDARIES
PRIVACY ZONES
PRESETS
SCAN LIMITS
EXIT

5. Use the joystick to move the highlight to **Presets**. Press **Set** to select. The **Select Preset to Program** screen displays.

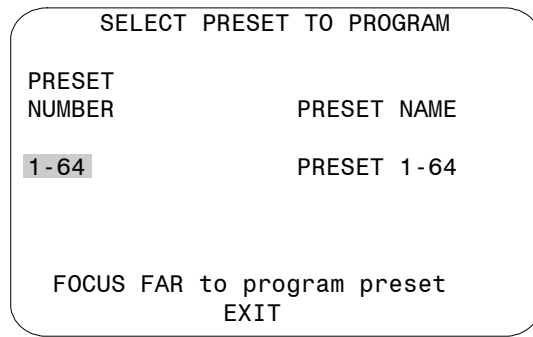

6. Use the joystick to select the Preset you want to program. If the Preset has been programmed the dome automatically moves to that position.
- Move the joystick right to increase the preset number.
 - Move the joystick left to decrease the preset number.

When the correct Preset number appears, press **Set** to begin programming.

7. The **Presets** screen displays. Use the joystick to adjust the dome to the correct pan/tilt position.

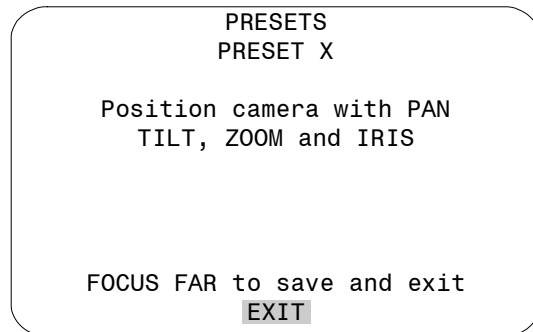

IMPORTANT! If using the WV-CU550A Controller with the WJ-SX550 Multiplexer, you must press **F3 (A. Res)** to adjust the zoom, focus, or iris settings. This places the controller in normal navigating mode. Make the necessary adjustments. When finished, press **F1 (On)** to resume menu mode.

8. Press **Set** to save the Preset information.
9. To program more Presets, repeat steps 5 through 8. To exit the Dome Configuration Menu and save changes, press **F4 (Exit)**.

To verify the Preset programming, enter a Preset number (1-64) and press **Preset**.

Tested Panasonic Equipment

The following Panasonic equipment has been tested with SpeedDome Ultra VII:

- WJ-SX550 Multiplexer
- WV-CU550A Controller

NOTES :

APPENDIX E

AD Up-the-Coax (UTC) Command Summary













This appendix summarizes the AD-UTC controller commands used with the Configuration Utility. It also provides a list of additional AD-UTC commands that can be used with the dome and compatible controllers.

In This Appendix

- Command Summary..... E-2
- Supported Controllers E-4
- Performance Notes E-4





Command Summary

The following table lists the commands to operate the configuration utility when the dome is installed in an AD Up-the-Coax (AD-UTC) environment. The keyboard must be in programming mode to perform these functions.

If you want to ...	Use ...
Start the configuration utility.	 ,  +  (Function, and then Shift+Menu)
Move the highlight bar on the active menu.	Use the Joystick (Pan/Tilt)
Select the highlighted item on the active menu.	 or  (Focus Far or Focus Near)
Increase the value of the selected setting. For example, Red or Blue white balance values.	 (Zoom In) or Twist joystick clockwise
Decrease the value of the selected field. For example, Red or Blue white balance values.	 (Zoom Out) or Twist joystick counter-clockwise
Display the next choice for the setting. For example, Maximum Zoom setting.	 (Zoom In)
Display the previous choice for the setting. For example, Maximum Zoom setting.	 (Zoom Out)
Save changes and exit the utility from any screen.	 ,  +  (Function, and then Shift+Clear)



















Setting Names / Working with Passwords

When setting names or entering password information, the screen displays the available characters in the selected languages. In these situations, the following commands are used:

If you want to ...	Use ...
Move the highlight left or right in the character field.	Joystick Left/Right
Move the highlight up or down in the character field.	Joystick Tilt Up/Down
Select the highlighted character in the character field.	 or  (Focus Far or Focus Near)
Move the cursor to the right of the current character in the name or password.	 (Zoom In) or Twist joystick clockwise
Move the cursor to the left of the current character in the name.	 (Zoom Out) or Twist joystick counter-clockwise

Additional AD-UTC Commands

The following tables summarize the special commands available when using the dome in an AD-UTC network. These commands are available when you enter the keyboard combination provided.

If you want to ...	Use ...
Program selected Preset	 , Preset number,  (Function, Preset number (1-96), and then Preset)
Recall selected Preset	Preset number,  (Preset number, then Preset)
Start selected Pattern programming	 , pattern number,  +  (Function, pattern number (1-3), then Shift+Preset)
Save Pattern programming	Pattern number,  (Pattern number (1-3), then Function)
Run selected Pattern continuously	Pattern number, then  and  (Pattern number, Shift and Preset)
Resume Auto Focus mode	 +  or  +  (Function+Focus Far or Function+Focus Near)
Resume Auto Iris mode	 +  or  +  (Function+Iris Open or Function+Iris Close)
Rotate dome 180° from current position (“flip”)	 (Flip)

Supported Controllers

The following AD-UTC controllers are compatible with SpeedDome Ultra VII:

Controller	Presets	Patterns	Quick Set Menu
ADCC0200	96	3	Yes
ADCC0300	96	3	Yes

This list of controllers is complete as of the time of publication. Other controllers may be supported. Contact your Sales Representative for current information.

Performance Notes

The following considerations should be made when using the SpeedDome Ultra VII Day/Night camera dome in the AD-UTC environment.

Address Setting

The SpeedDome Ultra VII camera dome must be set to address **891** to operate in the AD-UTC environment. When the dome initializes or resets, the address and protocol information (UTC_T) appear on-screen.

Accessing the Quick Set Menu

















The Quick Set Menu provides easy access to certain SpeedDome Ultra VII Day/Night functions from the keyboard. Two pages of settings are available. To access the Quick Set menu, select the dome, and press  (**Quick Set** button).

Figure E-1: Quick Set Menu

0	TOGGLE QUICK SET MENU	15	SMOOTH SCAN
1	DOMES CONFIG MENU	16	STEPPED SCAN
2	AUTO IRIS/AUTO FOCUS	17	RANDOM SCAN
3	FLIP	20	DOMES INFORMATION
4	PEEL PATTERN		
10	NIGHT MODE		
11	DAY MODE		
12	AUTO DAY/NIGHT MODE		
13	WDR ON		
14	WDR OFF		
FOCUS FAR = next page		FOCUS NEAR = previous page	

Enter a number and press  to use a quick set function. Press **Focus Far** or **Focus Near** to scroll between pages. The following table describes the options.

Quick Set Command / Menu Item	Description
0+  : Toggle Quick Set Menu	Toggles between displaying and hiding the quick set menu.
1+  : Dome Config Menu	Displays the SpeedDome Ultra configuration menu. Refer to the dome manual for information about the available settings.
2+  : Auto Iris/Auto Focus	Resumes Auto Focus/Auto Iris mode.
3+  : Flip	Rotates the SpeedDome 180° from its current pointing direction. This is the same as pressing the Flip button.
4+  : Peel Pattern	Runs the default Apple Peel Pattern continuously.
10+  : Night Mode	Sets the dome IR mode setting to ON. The dome switches to full-time black-and-white (B/W) mode.
11+  : Day Mode	Sets the dome IR mode setting to OFF. The dome switches to full-time color mode.
12+  : Auto/Day Night Mode	Resumes the most recently selected automatic IR mode setting. Auto High: B/W mode activates ~30 lux. Auto Mid: B/W mode activates ~3 lux. Auto Low: B/W mode activates ~.5 lux
13+  : WDR On	Enables Wide Dynamic Range (WDR). Use this setting when both bright and low light areas need to be viewed simultaneously.
14+  : WDR Off	Disables Wide Dynamic Range (WDR). Use this setting when the light level is constant or changes in lighting conditions are gradual.
15+  : Smooth Scan	Initiates a smooth scan between the left and right scan limits, starting at the left scan limit. If no scan limits have been set, initiates a smooth 360° clockwise rotation around the dome axis using the current tilt, zoom and focus settings.
16+  : Stepped Scan	Initiates a scan between the left and right scan limits pausing briefly every 10° (at 1x zoom), starting at the left scan limit. When the right scan limit is reached, the scan is reversed. If no scan limits have been set, initiates a clockwise rotation around the dome axis pausing briefly every 10° (at 1x zoom) for 3 seconds using the current tilt, zoom and focus settings.
17+  : Random Scan	Initiates a scan between the left and right scan limits pausing randomly between the limits. If no scan limits have been set, initiates a clockwise or counter-clockwise rotation around the dome axis using the current tilt, zoom and focus settings. The dome pauses randomly as it rotates around the axis.
20+  : Dome Information	Displays the Dome Information screen available through the dome configuration menu.

Note: You can access any quick set feature by entering the menu number and pressing .

When a selection is made, the Quick Set menu automatically closes. To close the menu without making a selection, press .

APPENDIX F

Vicon Command Summary

This appendix summarizes the SpeedDome Ultra VII features that are supported by the Vicon protocol. In addition, it provides the controller commands used with the Configuration Utility. It also provides information about tested Vicon equipment and supported Vicon features.

In This Appendix

- Supported SpeedDome Ultra VII Features.....F-1
- Vicon Command SummaryF-2
- Operating the Dome Configuration MenuF-3
- Setting Names / Working with PasswordsF-4
- Setting Left and Right Auto Pan Scan LimitsF-4
- Wiring ConfigurationsF-5
- Tested Vicon Equipment.....F-6

Supported SpeedDome Ultra VII Features

The following SpeedDome Ultra VII features are supported with the Vicon protocol:

- 10x digital zoom (up to 230X total zoom) for SpeedDome Ultra VII Day/Night dome
- 79 Total Presets (1-79)
- 3 Patterns
- 16 Areas
- 4 Alarm Inputs and Outputs
- 8 Privacy Zones
- Programmable Names (camera, preset, pattern, areas, and alarms)
- Open Shutter settings
- Proportional Flip
- Apple Peel pattern (default SpeedDome pattern)
- V-Phase adjustment
- Direction Indicator display
- Multi-language Dome Configuration Utility (available in English, French, German, Italian, Portuguese, and Spanish) with Password Protection

Vicon Command Summary

The following table lists the Vicon controller key sequence to control the indicated SpeedDome Ultra VII functions.

If you want to ...	Use ...
Set <i>Auto Iris</i> ON/OFF (LED indicates Auto Iris state: ON = AUTO)	A/I Toggles state
Set <i>Auto Focus ON/OFF</i> (LED indicates Auto Focus state: ON = AUTO)	Press and Hold L-Spd A/P Toggles state
<i>Goto Presets</i>	Run/Pgm switch to RUN Enter 1-79 Enter
<i>Program Presets</i>	Run/Pgm switch to PGM Enter 1-79 Enter
Run <i>PEEL Pattern and Repeat</i>	AUX5
<i>Rotate dome 180° (“Flip”)</i>	AUX6
Start <i>Pattern 1-3 Definition</i>	Run/Pgm switch to PGM Enter 80- 82 Enter
End <i>Pattern Definition</i>	Run/Pgm switch to PGM Enter 86 Enter
<i>Review Pattern</i>	Run/Pgm switch to PGM Enter 87 Enter
<i>Accept Pattern</i>	Run/Pgm switch to PGM Enter 88 Enter
<i>Run Pattern 1-3</i>	Run/Pgm switch to RUN Enter 80- 82 Enter
<i>Repeat Pattern 1-3</i>	Run/Pgm switch to RUN Enter 83- 85 Enter
<i>Set Pattern to Peel</i>	Enter 89 Enter
<i>Vphase Dome</i> <i>Note:</i> The A/I LED blinks indicating that you are in the vphase mode. Enter key sequence again to turn vphase adjustment off. The A/I LED stops blinking and indicates Auto Iris State.	Run/Pgm switch to PGM Enter 93 Enter <ul style="list-style-type: none"> • Pan Right to increment • Pan Left to decrement
Start <i>Dome Configuration Menu</i> See Operating the Dome Configuration Menu on page F-3.	Enter 94 Enter
Turn <i>IR Mode On</i>	Run/Pgm switch to PGM Enter 95 Enter
Turn <i>IR Mode Off</i>	Run/Pgm switch to PGM Enter 96 Enter

If you want to ...	Use ...
Reset Dome	Run/Pgm switch to PGM Enter 97 Enter
Auto Pan Left Limit See Setting Left and Right Auto Pan Scan Limits on page F-4.	Run/Pgm switch to PGM Enter 98 Enter
Auto Pan Right Limit See Setting Left and Right Auto Pan Scan Limits on page F-4.	Run/Pgm switch to PGM Enter 99 Enter
Auto Pan ON/OFF (LED indicates Auto Pan state: ON = Auto Pan is running.)	Run/Pgm switch to RUN A/P toggles state

Operating the Dome Configuration Menu

The following table lists the commands to operate the configuration utility when the dome is installed in a Vicon environment.

If you want to ...	Use ...
Start the configuration utility.	Run/Pgm switch to PGM Enter 94 Enter
Move the highlight bar on the active menu.	Tilt Up/Down
Select the highlighted item on the active menu.	A/P or AUX5
Increase the value of the selected setting. For example, Red or Blue white balance values.	Pan Right (or Zoom In)
Decrease the value of the selected field. For example, Red or Blue white balance values.	Pan Left (or Zoom Out)
Display the next choice for the setting. For example, Maximum Zoom setting.	Pan Right (or Zoom In)
Display the previous choice for the setting. For example, Maximum Zoom setting.	Pan Left (or Zoom Out)

Setting Names / Working with Passwords

When setting names or entering password information, the screen displays the available characters in the selected languages. In these situations, the following commands are used:

If you want to ...	Use ...
Move the <i>highlight left or right</i> in the character field.	Pan Left/Right
Move the <i>highlight up or down</i> in the character field.	Tilt Up/Down
<i>Select</i> the highlighted character in the character field.	A/P
Move the cursor to the <i>right of the current character</i> in the name or password.	Pan Right (or Zoom In)
Move the cursor to the <i>left of the current character</i> in the name.	Pan Left (or Zoom Out)

Setting Left and Right Auto Pan Scan Limits



IMPORTANT

You must program the Left Scan Limit setting before programming the Right Scan Limit setting. This procedure erases any previously programmed Right Scan Limit setting.

Programming the Scan Limits:

1. Select the camera number assigned to the SpeedDome Ultra VII dome.
2. Use the pan/tilt joystick to position the dome's pointing direction to the Left Scan Limit.
3. Set Run/Pgm switch to **Pgm**.
4. Enter **Set Preset 98** to save the setting.
5. Position the dome's pointing direction, by panning right to Right Scan Limit.
6. Enter **Set Preset 99** to save the setting.
7. Set Run/Pgm switch to **Run**.



Note: If both the **Left** and **Right** scan limits are set to the same position, the dome continuously pans to the right when *Auto Pan* is activated.

Setting the Auto Pan Speed

1. Press and hold **A/P** key.
2. Move joystick to **Pan Right** until the desired speed is observed on the monitor.
3. Release the **A/P** key.
4. Release the joystick

Activating Auto Pan

Auto Pan allows the dome to continuously pan between the left and right scan limit settings. To start Auto Pan, press the **A/P** key. If no scan limit settings are programmed, the dome pans to the right continuously.



Note: Auto Pan will be cancelled if the operator issues a Pan, Flip, Preset, or Pattern command.

Wiring Configurations

In Vicon systems where the domes support loop through, daisy chain the SpeedDome Ultra VII domes off the last Vicon dome in the communications chain.

Figure F-1: SpeedDome Ultra VII dome loop-through wiring from Vicon dome

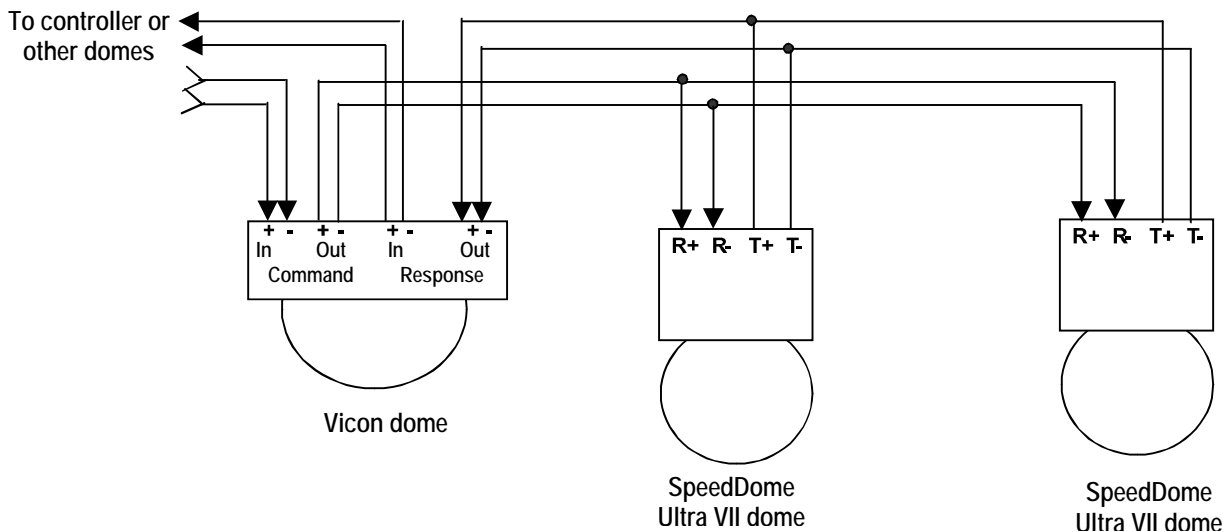

In Vicon systems where the domes support RS-485 daisy chaining, daisy chain the SpeedDome Ultra VII domes off the controller or one of the Vicon domes in the communications chain.

Figure F-2: SpeedDome Ultra VII dome RS-485 wiring from Vicon dome

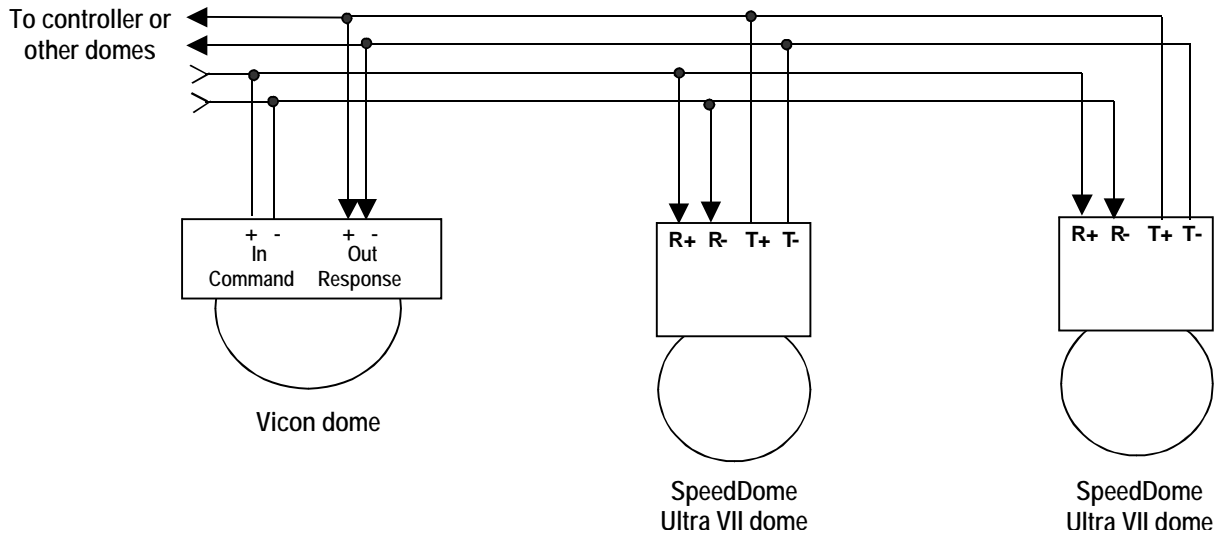

Tested Vicon Equipment

The following Vicon equipment has been tested with SpeedDome Ultra VII:

- Vicon 1300 CPU Systems
- Vicon 1400 CPU Systems
- Vicon 1500 CPU Systems
- Vicon VPS 324

APPENDIX R

Dome Configuration Records

Use the pages in this appendix to record the configuration settings for your SpeedDome Ultra VII Day/Night Camera Dome. Make copies of these pages for each dome. Whenever you change settings for a dome, update the information recorded on these pages.

In This Appendix

• Pan / Tilt / Zoom / Sync Options	R-2
• Camera Functions	R-2
• Set Alarm Actions	R-2
• Set Alarm States	R-2
• Set Home Position.....	R-2
• Set North Position	R-3
• Area Boundaries.....	R-3
• Privacy Zones.....	R-3
• Scan Limits	R-3
• On-Screen Text Display	R-3
• Text Attribute Options	R-4
• Language / Password.....	R-4
• Name Configuration.....	R-4
• Presets	R-5
• Dome Information.....	R-7

Configuration Settings

Pan / Tilt / Zoom / Sync Options

Menu Item	Default Setting (Choices)	Current Setting
Proportional Flip	Off (On / Off)	
1st Zoom Stop X	35 (23 /35)	
Max Total Zoom X	92 (46, 69, 92, 115, 138, 161, 184, 207, 230)	
Line Lock	On (On / Off)	
Freeze Frame	Off (Off/On)	

Camera Functions

Menu Item	Default Setting (Choices)	Current Setting
Auto White Bal	On (On / Off)	
White Bal Adj: Red ¹	0-511	
White Bal Adj: Blue ¹	0-511	
IR Mode	Auto Low (Off/On/Auto High/Auto Med/ Auto Low)	
WDR	Off (Off/On)	
AGC/Shutter	Open Shutter (AGC On/AGC Off/Open Shutter)	
Max Gain ²	28 (0-28dB NTSC) 28 (0-28dB PAL)	
Limit ³	1/4 (1/2 – 1/60 NTSC) 1/3 (2/3 - 1/50 PAL)	

¹ Auto White Bal must be set to Off to use these settings.

² AGC On or Open Shutter must be active to use this setting.

³ Open Shutter must be active to use this setting.

Set Alarm Actions

Menu Item	Default Setting (Choices)	Current Setting
Alarm No. 1	No Action (Preset 1-96 / Pattern 1-3 / No Action)	
Alarm No. 2	No Action (Preset 1-96 / Pattern 1-3 / No Action)	
Alarm No. 3	No Action (Preset 1-96 / Pattern 1-3 / No Action)	
Alarm No. 4	No Action (Preset 1-96 / Pattern 1-3 / No Action)	
Send Inputs to Host	Yes (Yes / No)	

Set Alarm States

Menu Item	Default Setting (Choices)	Current Setting
Input No. 1	Open (Open / Closed)	
Input No. 2	Open (Open / Closed)	
Input No. 3	Open (Open / Closed)	
Input No. 4	Open (Open / Closed)	

Set Home Position

Menu Item	Default Setting (Choices)	Current Setting
Home Position	No Action (Preset 1-96/ Pattern 1-3 / No Action)	
Return Time (Mins) ⁴	10 (1 - 60 Minutes)	

⁴ Home Position must be set to Preset or Pattern for this setting to apply.

DOMe NUMBER: _____

LOCATION: _____

Set North Position

Describe North position:	
--------------------------	--

Area Boundaries

Up to 16 areas can be programmed. Use this form to identify the start and end points of each area. This will assist you in restoring the boundaries if the areas should be erased.

Area Number	Start Point	End Point
Area 1		
Area 2		
Area 3		
Area 4		
Area 5		
Area 6		
Area 7		
Area 8		
Area 9		
Area 10		
Area 11		
Area 12		
Area 13		
Area 14		
Area 15		
Area 16		

Privacy Zones

Up to eight Privacy Zones can be programmed. Use this form to identify the number of Privacy Zones programmed and areas being obscured.

Number	Description
Zone 1	
Zone 2	
Zone 3	
Zone 4	
Zone 5	
Zone 6	
Zone 7	
Zone 8	

Scan Limits

Scan Limit	Description
Left	
Right	

On-Screen Text Display

Menu Item	Default Setting (Choices)	Current Setting
Status Display	Off (On / Off)	
Disable All Names	No (Yes / No)	
Diagnostic Display	Off (On / Off)	
Direction Indicator	Off (On / Off)	

DOME NUMBER: _____

LOCATION: _____

Text Attribute Options

Menu Item	Default Setting (Choices)	Current Setting
Character Outline	On (On / Off)	
Translucent Names	On (On / Off)	

Language / Password

Menu Item	Default Setting (Choices)	Current Setting
Language Selection	English (English / Spanish / French / German / Italian / Portuguese)	
Password Protection	Off (On / Off)	

Note: The SpeedDome Ultra VII password should be provided to authorized operators only.

Name Configuration

Menu Item	Default Setting (Choices)	Current Setting
Camera Name	Off (On / Off)	
Area Name	Off (On / Off)	
Area No. 1	Area 1	
Area No. 2	Area 2	
Area No. 3	Area 3	
Area No. 4	Area 4	
Area No. 5	Area 5	
Area No. 6	Area 6	
Area No. 7	Area 7	
Area No. 8	Area 8	
Area No. 9	Area 9	
Area No. 10	Area 10	
Area No. 11	Area 11	
Area No. 12	Area 12	
Area No. 13	Area 13	
Area No. 14	Area 14	
Area No. 15	Area 15	
Area No. 16	Area 16	
Preset Name	Off (On / Off)	

REFER TO PRESET WORKSHEET FOR NAME SETTINGS (page R-5)

Pattern Name	Off (On / Off)	
Pattern No. 1	Pattern 1	
Pattern No. 2	Pattern 2	
Pattern No. 3	Pattern 3	
Alarm Name	On (On / Off)	
Alarm No. 1	Alarm 1	
Alarm No. 2	Alarm 2	
Alarm No. 3	Alarm 3	
Alarm No. 4	Alarm 4	

DOME NUMBER: _____

LOCATION: _____

Presets

Up to 96 presets may be programmed for each dome. Use this form to describe the scene being viewed for each preset. This will assist you in restoring the presets if they should be erased.

Preset Number	Description	Assigned Name
Preset 1		
Preset 2		
Preset 3		
Preset 4		
Preset 5		
Preset 6		
Preset 7		
Preset 8		
Preset 9		
Preset 10		
Preset 11		
Preset 12		
Preset 13		
Preset 14		
Preset 15		
Preset 16		
Preset 17		
Preset 18		
Preset 19		
Preset 20		
Preset 21		
Preset 22		
Preset 23		
Preset 24		
Preset 25		
Preset 26		
Preset 27		
Preset 28		
Preset 29		
Preset 30		
Preset 31		
Preset 32		
Preset 33		
Preset 34		
Preset 35		
Preset 36		
Preset 37		
Preset 38		
Preset 39		
Preset 40		
Preset 41		
Preset 42		
Preset 43		
Preset 44		
Preset 45		
Preset 46		
Preset 47		
Preset 48		

DOME NUMBER: _____

LOCATION: _____

Preset Number	Description	Assigned Name
Preset 49		
Preset 50		
Preset 51		
Preset 52		
Preset 53		
Preset 54		
Preset 55		
Preset 56		
Preset 57		
Preset 58		
Preset 59		
Preset 60		
Preset 61		
Preset 62		
Preset 63		
Preset 64		
Preset 65		
Preset 66		
Preset 67		
Preset 68		
Preset 69		
Preset 70		
Preset 71		
Preset 72		
Preset 73		
Preset 74		
Preset 75		
Preset 76		
Preset 77		
Preset 78		
Preset 79		
Preset 80		
Preset 81		
Preset 82		
Preset 83		
Preset 84		
Preset 85		
Preset 86		
Preset 87		
Preset 88		
Preset 89		
Preset 90		
Preset 91		
Preset 92		
Preset 93		
Preset 94		
Preset 95		
Preset 96		

DOME NUMBER: _____

LOCATION: _____

Dome Information

Record the information found on the **Dome Information** screen here. The information on this screen cannot be modified and is provided for service use.

Item	Device Information
Name:	
Mnemonic:	
Software Version:	
Device Type:	
Serial Number (SN):	
Manufacture Date:	

DOME NUMBER: _____

LOCATION: _____

N O T E S :

Software License Agreement

By using this software, you accept the terms and conditions of this license agreement. Read this license agreement carefully.

1. **General.** Software is being licensed to the Customer pursuant to the following terms and conditions, which supplement any purchase or lease agreement (the "Equipment Agreement") between Customer and Sensormatic Electronics Corporation ("SEC"). By accepting receipt of, or by using, such Software, the Customer agrees to be bound by the terms of this Software License Agreement (the "License Agreement"). The term "Software" means all computer programs, instructions, data and databases, in any form or on any media, supplied by SEC (or its suppliers) to Customer and all current and future versions, revisions, updates, upgrades and new releases thereof. Except as otherwise provided in this License Agreement, the terms and conditions of the Equipment Agreement apply to the Software, the related technical and user manuals ("Documentation") and the license provided herein.
2. **License.** SEC licenses the Software and the Documentation to Customer, for the license fee(s) set forth (or included in the product prices set forth) in the Equipment Agreement and subject to the terms and conditions of this License Agreement. The license is non-exclusive and is limited by the terms of this License Agreement. Customer may not transfer the license except to a party to whom the equipment is transferred and then only with the written consent of SEC. The Software and Documentation are being licensed and not sold or leased to Customer. SEC or its suppliers who have authorized SEC to sublicense certain of the Software and Documentation retain ownership of the Software and Documentation. The Software is being licensed for use only on (i) a single computer (A) owned or leased by Customer and identified in the Equipment Agreement or (B) otherwise identified in the Documentation as compatible with the Software, or (ii) a back-up machine if and so long as such computer becomes temporarily inoperable.
3. **Term.** The term of the license is perpetual, except that it will terminate automatically if Customer sells or otherwise disposes of the Software or its related equipment or Customer breaches any provision of this License Agreement or the Equipment Agreement. If the license terminates, SEC will have the right to take possession of all copies of the Software and Documentation in the possession of Customer or to require Customer to destroy all such copies and certify such destruction in writing to SEC.
4. **Ownership.** Customer agrees and acknowledges that (i) SEC (or its suppliers) is the sole owner of the Software and Documentation (including all copies thereof, in whatever form or media, delivered to or made by Customer) and all patent, copyright and other intellectual property rights with respect thereto and (ii) the Software and Documentation constitute valuable trade secrets, confidential information and proprietary properties of SEC and its suppliers. Accordingly, Customer agrees that it will have no rights in the Software or Documentation other than those granted under this License Agreement and agrees to abide by the restrictions on its use of the Software and Documentation set forth in Section 5 of this License Agreement.
5. **Use and Copies.** Customer may use the Software and Documentation only in conjunction with the other equipment identified in the Equipment Agreement, as part of the access control, closed circuit television or other security system being acquired from SEC and for Customer's internal business purposes. SEC will furnish the Software to Customer solely in object code form.

Customer may make up to 2 copies of the Software solely for back-up and archival purposes. Customer will not remove or modify the copyright and other proprietary notices and legends of SEC and its suppliers contained in the Software and Documentation and will reproduce all such notices and legends on all copies of the Software made by Customer. Customer may not make copies of the Documentation, but may obtain additional copies of the Documentation from SEC at its established rates. Except as permitted above, copying of the Software and Documentation is forbidden.

Customer will not sell, assign, sublicense or transfer this license or sell or otherwise transfer the Software or Documentation (or any portion thereof) to others. Customer will maintain the Software and Documentation in confidence and not disclose any data or other information contained in the Software or Documentation to any party, except for Customer's employees and agents who require access to the Software for the purposes of Customer's internal business and who use it in accordance with the terms of this License Agreement. Customer will not use the Software for the provision of time-sharing services to others. Customer will not modify the Software or decompile, disassemble or otherwise reverse engineer the Software and will not have the right to create derivative works of the Software, including, without limitation, translated or localized versions of the Software. Customer will not export or re-export the Software or the Documentation or any portion thereof without appropriate United States or foreign governmental licenses.

Customer will implement appropriate measures, such as the requirement that employees and others permitted access to the Software enter into appropriate non-disclosure agreements, to satisfy its obligations hereunder and, generally, will treat the Software and Documentation with the same degree of care and confidentiality which Customer provides for its own confidential information. Customer acknowledges that it may be held legally responsible for any copyright infringement or trade secret violation that is caused, in whole or in part, by its failure to abide by the terms of this License Agreement. Since unauthorized transfer, use or disclosure of the Software and Documentation would diminish their value to SEC and its suppliers, who would have no adequate remedy at law if Customer breaches its obligations under this License Agreement, SEC and its suppliers (who are direct and intended beneficiaries of this License Agreement) will be entitled to injunctive relief, in addition to such other remedies and relief that would be available to them in the event of such a breach.

6. **Limited Warranty; Limitation of Liability.** The provisions of the Equipment Agreement respecting maintenance and warranty will not apply to the Software or the Documentation, unless specifically stated otherwise and agreed to in writing by both parties. SEC's sole warranties with respect to the Software and Documentation are that (i) SEC has title to the Software and Documentation and/or the right to grant Customer the license set forth in this License Agreement and (ii) the magnetic media on which the Software is recorded is free from defects in materials and workmanship under normal use. SEC's sole obligation under this warranty will be to replace any defective media returned to it free of charge. The period of this warranty will be 12 months from the date of the Equipment Agreement (the "Warranty Period").

EXCEPT AS SET FORTH IN THIS SECTION 6, SEC DISCLAIMS ANY WARRANTY, EXPRESS OR IMPLIED, WITH RESPECT TO THE SOFTWARE OR THE DOCUMENTATION OR THEIR OPERATION OR USE, INCLUDING, WITHOUT LIMITATION, ANY IMPLIED WARRANTY OF MERCHANTABILITY OR OF FITNESS FOR A PARTICULAR PURPOSE OR USE. SOME STATES DO NOT ALLOW THE EXCLUSION OF IMPLIED WARRANTIES, SO THE ABOVE EXCLUSION DOES NOT APPLY IN SUCH STATES. THIS WARRANTY GIVES YOU SPECIFIC LEGAL RIGHTS, AND YOU MAY ALSO HAVE OTHER RIGHTS THAT VARY FROM STATE TO STATE.

SEC AND ITS SUPPLIERS, EMPLOYEES, AGENTS AND FRANCHISEES WILL IN NO EVENT BE LIABLE FOR ANY INCIDENTAL, CONSEQUENTIAL OR OTHER DIRECT OR INDIRECT DAMAGES (FOR LOSS OF BUSINESS INFORMATION OR PROFITS OR OTHERWISE) SUFFERED BY CUSTOMER, ANY OF ITS EMPLOYEES OR AGENTS OR ANY OTHER PERSON ARISING OUT OF OR IN CONNECTION WITH THE USE OR INABILITY TO USE THE SOFTWARE OR THE DOCUMENTATION, OR THE MAINTENANCE OR SUPPORT THEREOF, EVEN IF THEY HAVE BEEN ADVISED OF THE POSSIBILITY OF SUCH DAMAGES. SEC neither assumes nor authorizes any employee, agent or franchisee to assume for SEC any other liability in connection with the license, use or performance of the Software or Documentation.

Customer is solely responsible for the selection of the Software to achieve customer's intended results, for the conformity of the computer on which the Software is run to SEC's specifications or requirements and for the maintenance of such computer in good working order and repair. SEC's suppliers do not warrant the Software, assume any liability regarding the use of the Software or undertake to provide any maintenance, support or information regarding the Software.

7. U.S. Government Restricted Rights. The Software and Documentation are provided with restricted rights. Use, duplication or disclosure by the U.S. Government is subject to restrictions as set forth in subparagraphs (c)(1)(ii) of the Rights in Technical Data and Computer Software Clause of Department of Defense Federal Acquisition Supplement (DFARS) 252.227-7013 or in subparagraph (g)(3)(i) of Federal Acquisition Regulations (FAR) 52.227-14, Alternate III, as applicable.
8. Indemnity. SEC will defend and hold Customer harmless from any claim, action, suit or proceeding brought against Customer to the extent that it is based on a claim that the use of the Software, as such, in accordance with this License Agreement and not as a result of the combination thereof with any other article, computer software or process, constitutes an infringement of any United States patent or copyright or the violation of any trade secret, if SEC is notified thereof promptly after its commencement and is given control of the defense thereof and any negotiations for its settlement and full cooperation by Customer.

SEC will pay all damages and costs awarded against Customer in connection with any such claim, except that SEC will not be liable for any amounts paid under any compromise or settlement made without its consent. If the Software is either claimed or held to infringe or violate any patent or copyright, SEC may, at its sole option and expense, and Customer will permit SEC to, procure for Customer the right to continue using the Software or modify it so that it becomes non-infringing or replace it with a non-infringing counterpart. If neither of such alternatives is available on terms which are reasonable in SEC's judgment, Customer will return all copies of the Software and Documentation in the possession of Customer to SEC, at SEC's request, and SEC will refund a reasonable portion of the license fees paid by Customer to SEC. This Section 8 sets forth SEC's entire liability regarding infringement and the like.

NOTES :

SPEEDDOME ULTRA VII GLOSSARY

Alarm Actions	The assigned responses for the dome when inputs change from normal to abnormal states. The dome may run a <i>Preset</i> , <i>Pattern</i> , or have no assigned action for each of the four dome inputs. The dome may also send alarm states to the host controller for processing. See also <i>Input</i> and <i>Normal Input State</i> .
Apple Peel Pattern	The default pattern of the SpeedDome Ultra VII. This pattern consists of three complete revolutions starting at the ceiling line and tilting down 30° each revolution.
Areas	Programmed start and end points of the dome's field of view around its pan axis. Each area is a part of a circular viewing area that extends around the dome. The areas can be different sizes. Up to 16 areas can be programmed for the dome.
Automatic “Flip” feature	Allows the dome to automatically turn 180 degrees when the camera tilts to its lower limit and stays in that position for a brief delay. When the dome flips (rotates), the camera starts moving upward as long as the tilt control is kept in the down position. Once the control is released, the tilt control returns to its normal operational mode. The flip feature is useful when you need to track someone who walks directly beneath the dome and continues on the other side. This is also referred to as “proportional flip.”
Automatic Gain Control (AGC)	Allows for the amplification of the video signal in scenes with minimal ambient light. Many low-light scenes result in picture noise. As gain is increased, the picture noise is also amplified. When AGC is enabled, the value of the gain setting is based on feedback from the camera. When AGC is disabled, the camera uses the value set for the manual gain setting. The trade-off between picture level and noise may be adjusted when AGC is disabled. See also <i>Open Shutter</i> .
Black and White Mode	<i>See IR Mode.</i>
Configuration Utility	The text overlay menu system used for setting dome features. The utility is accessed using a keystroke combination. The utility provides settings for camera functions, zoom, alarms, text display, and password protection.
Direction Indicators	Provides for the display of the camera dome's pointing direction based on the North setting. This information appears on the top line of the monitor when the setting is enabled. In addition, the tilt setting appears on the left side of the monitor. By default, North is set to 0° Pan/Tilt. This setting may be changed using the <i>Set North Position</i> setting. See also <i>North Position</i> .
Dome Information	A Dome Configuration Menu choice that provides essential information about the SpeedDome Ultra VI camera dome if service is required. When you view this screen, you can determine the dome type, mnemonic, software version, serial number, and manufacture date. The information on this screen cannot be modified. See <i>Dome Statistics</i> .
Dome Statistics	A feature that identifies the operating statistics for the dome. The information displayed represents either runtime in seconds or number of occurrences. See <i>Dome Information</i> .
Dome Status Information	Relates to zoom, focus, and iris settings. You may choose to have this information displayed on the monitor when any of these settings change. If display of status information is enabled, it appears in the upper left corner of the monitor.

Flip	To automatically rotate the dome 180° from its current pointing position. <i>See Automatic “Flip” feature.</i>
Freeze Frame	A feature that allows the current image to be maintained on-screen when switching to a preset or pattern. This function prevents the display of the dome movement and lens adjustments while the preset or pattern position is sought. Once the preset or pattern is ready for display, the image switches smoothly to the new scene. <i>See Preset and Pattern.</i>
Home Position	The default position to which the dome returns after an assigned period of inactivity passes. The default position may be a <i>Preset, Pattern, or No Action.</i>
Input	A connection point on the dome that enables the system to monitor <i>Input Devices</i> . There are four inputs available for the dome.
Input Devices	External devices that provide information about the condition of system components connected to the inputs on the dome. Typical input devices include door contacts, motion detectors and smoke detectors.
IR Mode	A feature of the camera that permits manual or automatic switching between color and IR (black-and-white) operation. When IR mode is active, clearer images may be obtained under low-light conditions.
Line Lock	Allows you to phase lock the video with the AC power line. When line lock is enabled, it prevents vertical video rolling when switching multiple cameras to a single monitor. If text appears slightly tinted on color monitors, disabling the line lock may prevent this problem.
Name Information	Relates to the display the dome name, the area where the dome is pointing, the name of the preset or pattern that is running, and alarm names. The display of each type of name setting can be enabled or disabled. When the display of camera or area names is enabled, the information appears on the screen continuously. Preset, pattern, and alarm names appear only while they are active.
Normal Input State	Describes the expected state of a device connected to one of four dome inputs. The normal state may be <i>open</i> or <i>closed</i> . When a device is not in its normal input state, an alarm is issued. Transmitting the dome input states to the host controller is not supported with Manchester.
North Position	User-definable setting that may correspond to magnetic north or some well-known landmark. Used to approximate the camera dome's pointing direction when <i>Direction Indicators</i> are enabled.
Open Shutter	Setting used to improve the quality of video obtained in extreme low-light situations. When the Open Shutter setting is enabled, low-light information is collected over multiple fields based on the <i>Shutter Limit</i> setting. As a result, video may appear blurred or choppy in extreme low-light situations. This setting does not effect camera operation in normal lighting situations. <i>See also Automatic Gain Control (AGC).</i>
Password Protection	Prevents unauthorized users from starting the <i>Configuration Utility</i> . The password may be from 1 to 8 characters long.
Pattern	A series of pan, tilt, zoom and focus movements from a single programmable dome. Up to 3 patterns may be programmed for the dome.

Peel	Button found on some controllers that initiates the Apple Peel pattern. <i>See Apple Peel Pattern.</i>
Preset	Programmed video scene, based on a specific pan, tilt, zoom, and focus settings. Up to 96 presets may be programmed for the dome. For domes running in a Manchester network, only 64 presets may be programmed. See also <i>Virtual Views</i> .
Privacy Zones	Masked areas of the camera dome's viewing area. These masks prevent operators of the surveillance system from viewing these designated zones. Each Privacy Zone has four sides, and the zones may overlap to form irregular shapes. The Privacy Zones move in relation to the dome pan/tilt position. In addition, the apparent size of the Privacy Zone adjusts automatically as the lens zooms in or out. Up to eight Privacy Zones may be established for a camera dome.
Quick Set Menu	A special menu that provides access to commonly used features and functions when used with compatible controllers. This allows for changing or activating features without starting the dome configuration menu.
Random Scan	An automated scan that pans randomly between the left and right scan limits, starting at any point between the scan limits. See <i>Smooth Scan</i> and <i>Stepped Scan</i> .
Scan	Automated surveillance between predefined scan limits. Three types of scans are available: smooth scan, stepped scan, and random scan. See <i>Smooth Scan</i> , <i>Stepped Scan</i> , and <i>Random Scan</i> .
Scan Limits	Two points around the dome's pan axis, which define a surveillance area.
Shutter Limit	Setting used to define the maximum exposure time for the <i>Open Shutter</i> setting. The values for the setting range from 1/2 to 1/60 for NTSC, and 2/3 to 1/50 for PAL. The default setting is 1/4 for NTSC and 1/3 for PAL.
Smooth Scan	An automated scan that slowly pans between the left and right scan limits, starting at the left scan limit. When the right scan limit is reached, the scan reverses. See <i>Stepped Scan</i> and <i>Random Scan</i> .
Stepped Scan	An automated scan that pans slowly pausing momentarily every 10° between the left and right scan limits. Once the right scan limit is reached, the scan reverses. See <i>Smooth Scan</i> and <i>Random Scan</i> .
Virtual Views	Similar to <i>Preset</i> . However, virtual views store the pan, tilt, zoom, focus, and iris settings within the controller, not the dome. Virtual Views cannot be used for the <i>Home Position</i> or <i>Alarm Actions</i> .
White balance	Adjustments in the color hue (red and blue) gains for a camera so that true white appears white in the image. It is normally compensated for by the automatic gain control. In some lighting conditions, you may need to manually adjust the red and blue settings for optimal viewing. When Automatic White Balance is enabled, the camera measures the image and automatically adjusts the red and blue settings to balance white. When Automatic White Balance is disabled, the camera uses the values set for the red and blue settings to balance white.
Wide Dynamic Range	A feature of the camera that allows a scene with both bright and low light areas to be viewed simultaneously.

Zoom

To adjust the magnification of the camera lens to make an object appear closer (larger) or farther away (smaller). See also *Zoom stop factors*.

Zoom stop factors

Defines how the zoom function is partitioned. The first zoom stop setting may be 23X or 35X. The default first zoom stop setting is 35X. The maximum zoom stop setting may be 46, 69, 92, 115, 138, 161, 184, 207 and 230X. The default maximum zoom stop setting is 92X.

INDEX

-A-

- Activating IR mode manually, 3–4
- Advanced Shutter Settings
 - Overview, 3–7
- Alarm Actions
 - Configuring, 4–3
- Area Boundaries
 - Overview, 4–9, 4–10
 - Programming, 4–10
- Auto Focus
 - configuring settings, 2–6
- Auto Iris
 - configuring settings, 2–6
- Auto Iris/Auto Focus, 1–6, E–5
- Auto Scan
 - Pelco protocols, C–5
- Automatic Flip
 - Configuring, 2–2
- Automatic Gain Control (AGC)
 - Overview, 3–7

-B-

- Black & White (B/W) mode. See IR Mode

-C-

- Changing
 - IR mode setting, 3–4
 - Wide Dynamic Range (WDR) setting, 3–6
- Changing name information, 5–8
- Compatible Controllers
 - RS-422, A–3
 - SensorNet, A–3
- Configuration Settings
 - where to find information, 1–7
- Configuration Utility
 - Commands used, 1–3
 - Description, 1–2
 - Exiting, 1–5
 - Starting, 1–2
- Controller Commands
 - AD-UTC, E–2
 - Manchester, B–2
 - Call commands, B–3
 - Set commands, B–3
 - Panasonic UTC, D–3
 - Pelco Coaxitron, C–3
 - Pelco P protocol, C–3
 - RS-422, A–2
 - SensorNet, A–2
 - Vicon, F–2

-D-

- Deactivating IR mode manually, 3–4
- Diagnostic Information
 - Changing display, 5–4
 - Displaying, 5–4
- Directional Indicators
 - Description, 5–5
- Dome Config Menu, 1–6, E–5
- Dome Information
 - Overview, 7–1
- Dome Statistics
 - Viewing, 7–2
- Dome Status Information
 - Changing display, 5–2, 5–6
 - Displaying or Hiding, 5–2

-F-

- Factory Settings
 - Restoring, 1–4
- Flip, 1–6, E–5
- Frame Scan
 - Pelco protocols, C–6
- Freeze Frame, 2–5

-H-

- Home Position
 - Configuring, 4–7
 - Overview, 4–6

-I-

- IR mode
 - changing, 3–4
 - manually activating/deactivating, 3–4
 - Overview, 3–3
 - relationship with AGC and Open Shutter settings, 3–8

-L-

- Language
 - Selecting, 6–2
- Language and Password
 - Overview of settings, 6–1
- Line Lock
 - Configuring, 2–4

-N-

- Name Information
 - Changing, 5–7
 - Changing display of all, 5–3
 - Changing display of selected, 5–7
 - Displaying or Hiding, 5–3

- Using Name Configuration Menu, 5–6

- Normal Input States
 - Configuring, 4–5
 - Setting open or closed, 4–6
- North Position
 - Setting, 4–8

-P-

- Passwords
 - Changing, 6–2, 6–3
 - Enabling or Disabling, 6–4
 - Entering, 1–2, 1–3
 - Setting, 6–3
 - Peel Pattern, 1–6, E–5
 - Performance Notes
 - AD UTC Address setting, E–4
 - Alarm Inputs, B–4
 - Panasonic UTC Address setting, D–4
 - Pelco Address Settings, C–4
 - Quick Set Menu, E–4
 - RS-422
 - configuring alarm actions, A–6
 - SensorNet
 - configuring alarm actions, A–6
 - Using Auxiliaries, B–4
 - Presets
 - Overview, 4–16
 - Programming, 4–16
 - Privacy Zones
 - Deleting all zones, 4–15
 - Deleting specific zones, 4–15
 - Hiding, 4–8, 4–15
 - Overview, 4–11
 - Programming, 4–13
 - Programming
 - Scan Limits, 4–19
 - Programming Presets
 - Panasonic UTC, D–4
 - Protocols
 - Vicon, F–2
- ## -R-
- Random Scan, 1–6, E–5
 - Pelco protocols, C–6
 - Relationship between IR mode, AGC and Open Shutter, 3–8

-S-

- Scan Limits, 4–17
 - programming, 4–19
 - understanding, 4–17

Scan Types

- random, 4–18
- smooth, 4–18
- stepped, 4–18

Setting Scan Limits

- Pelco protocols, C–5

Settings Overview

- Alarms, Areas, Home Position, North Position, Presets and Privacy Zones, 4–2
- Camera, 3–1
- On-screen Text Display, 5–1
- Pan, Tilt, Zoom, and Synchronization, 2–2

Smooth Scan, 1–6, E–5

Stepped Scan, 1–6, E–5

Supported Controllers

- AD UTC, E–4

Supported Features

- Coaxitron, C–2
- P Protocol, C–2
- Panasonic UTC, D–2
- Pelco specific, C–4
- Vicon protocol, F–1

–T–

Text Display Attributes

- Changing appearance, 5–9, 5–10
- Toggle Quick Set Menu, 1–6, E–5

–U–

Unsupported Features

- Coaxitron, C–2
- P Protocol, C–2
- Panasonic, D–2

–W–

White Balance Settings

- Overview, 3–2

Wide Dynamic Range (WDR)

- changing setting, 3–6
- Overview, 3–5

–Z–

Zoom Stop Settings

- Configuring, 2–3

Please visit our website for more information
www.americandynamics.net

© 2003 Sensormatic Electronics Corporation
Product specifications subject to change without notice.
Certain product names mentioned herein may be trade names
and/or registered trademarks of other companies.

8200-0184-04 D

Free Manuals Download Website

<http://myh66.com>

<http://usermanuals.us>

<http://www.somanuals.com>

<http://www.4manuals.cc>

<http://www.manual-lib.com>

<http://www.404manual.com>

<http://www.luxmanual.com>

<http://aubethermostatmanual.com>

Golf course search by state

<http://golfingnear.com>

Email search by domain

<http://emailbydomain.com>

Auto manuals search

<http://auto.somanuals.com>

TV manuals search

<http://tv.somanuals.com>