

AMERICAN AUDIO

CDI-500™

Featuring:



User Guide and Reference Manual

Rev. 4/05

AMERICAN AUDIO
4295 Charter Street
Los Angeles Ca. 90058
www.AmericanAudio.us

CONTENTS

SAFETY REGULATIONS.....	3
ELECTRICAL PRECAUTIONS.....	4
SAFETY INSTRUCTIONS.....	5
VOLTAGE SELECTOR.....	5
UNPACKING.....	6
CUSTOMER SUPPORT.....	6
FEATURES.....	7
SET-UP INSTALLATION.....	8
FUNCTIONS AND CONTROLS	
MAIN UNIT.....	9
LCD DISPLAY.....	13
BASIC OPERATIONS	
LOADING EJECTING DISC.....	14
SELECTING TRACKING.....	14
STARTING PLAYBACK.....	15
PAUSING PLAYBACK.....	15
FRAME SEARCH.....	15
TRACK SCANNING (FAST FWD/FAST REV).....	16
SETTING AND STORING CUE POINTS.....	16
CREATING A SEAMLESS LOOP.....	17
USING THE BUILT-IN SAMPLER.....	19
USING THE BANK BUTTONS.....	21
BANK PROGRAMMING.....	22
CHANGING TIME DISPLAY.....	23
SYSTEM MEMORY.....	23
JOG WHEEL SENSITIVITY	23
CREATING A BOP EFFECT.....	23
PITCH ADJUSTMENTS	
PITCH SLIDER.....	24
PITCH BENDING.....	25
BUILT-IN EFFECTS	
SCRATCH/SKID.....	27
FILTER/PHASE.....	28
ECHO/FLANGER/ROBOT.....	28
TRANS/PAN.....	29
CHANGING PARAMETERS.....	29
FX MIX.....	30
FLIP-FLOP™.....	32
WARRANTY.....	33
SPECIFICATIONS.....	34

IMPORTANT INFORMATION

IMPORTANT SAFETY ITEMS FOR U.S.A. & CANADA MODEL ONLY

NOTE:

This CD player uses a semiconductor laser. It is recommended for use in a room at the following temperature: 41°F - 95°F / 5°C - 35°C

WARNING:

TO PREVENT FIRE OR SHOCK HAZARD,
DO NOT EXPOSE THIS CD PLAYER TO
WATER OR MOISTURE

CAUTION:

1. Handle the power supply cord carefully. Do not damage or deform; it may cause electric shock or malfunction when used. Hold plug attachment when removing from wall outlet. Do not pull on the cord.
2. To avoid electric shock, do not open the top cover when the unit is plugged in. If problems occur with the unit, call your local American Audio® dealer.
3. Do not place metal objects or spill liquid inside the CD player. Electric shock or malfunction may occur.



CAUTION
Do not open -
Risk of electric shock



CAUTION: TO REDUCE THE RISK OF ELECTRIC SHOCK, DO NOT REMOVE THE COVER RACK. THERE ARE NO USER SERVICEABLE PARTS INSIDE REFER SERVICE TO YOUR AUTHORIZED American Audio DEALER.



The lightning flash with an arrow triangular symbol is intended to alert the user to the presence of non insulated "dangerous voltage" within the products enclosure, and may be of sufficient magnitude to constitute a risk of electric shock.



The exclamation point triangular symbol is intended to alert the user to the presence of important operating and maintenance (servicing) instructions in the user manual accompanying the CD player.

CAUTION

TO PREVENT ELECTRIC SHOCK DO NOT USE THIS (POLARIZED) PLUG WITH AN EXTENSION CORD, RECEPTACLE OR OTHER OUTLET UNLESS THE BLADES CAN BE CAREFULLY INSERTED TO PREVENT BLADE EXPOSURE

CAUTION:

USE OF CONTROLS OR ADJUSTMENTS OTHER THAN THOSE SPECIFIED HEREIN MAY RESULT IN HAZARDOUS RADIATION EXPOSURE

THE COMPACT DISC PLAYER SHOULD NOT BE ADJUSTED OR REPAIRED BY ANYONE EXCEPT PROPERLY QUALIFIED SERVICE PERSONNEL.

NOTE:

This unit may cause interference to radio and television reception.

Please carefully read and understand the instructions in this manual thoroughly before attempting to operate this unit. These instructions contain important safety information regarding the use and maintenance of this unit. Take special care to follow all warning symbols and labels both on the unit and printed in this manual. Also, Please keep this manual with the unit, for future reference.

CAUTION: TO PREVENT ELECTRIC SHOCK DO NOT USE THIS (POLARIZED) PLUG WITH AN EXTENSION CORD, RECEPTACLE, OR OTHER TYPE OF ELECTRICAL OUTLET UNLESS THE WIDE BLADES CAN BE CAREFULLY INSERTED INTO A MATCHING WIDE SLOT.

ATTENTION: POUR PREVENIR LES CHOCS ELECTRIQUES NE PAS UTILISER CETTE FICHE POLARISEE AVEC UN PROLONGATEUR, UNE PRISE DE COURANT OU UNE AUTRE SORTIE DE COURANT, SAUF SI LES LAMES PEUVENT ETRE INSEREES A FOND SANS EN LAISSER AUCUNE PARTIE A DECOUVERT.

ELECTRICAL SAFETY PRECAUTIONS

ELECTRICAL PRECAUTIONS



The lightning flash with arrowhead symbol, within an equilateral triangle, is intended to alert the user to the presence of uninsulated "dangerous voltage" within the product's enclosure that may be of sufficient magnitude to constitute a risk of electric shock to persons.

CAUTION
RISK OF ELECTRIC SHOCK
DO NOT OPEN

CAUTION: TO REDUCE THE RISK OF ELECTRIC SHOCK, DO NOT REMOVE THE COVER (OR BACK). THERE ARE NO USER SERVICEABLE PARTS INSIDE. REFER SERVICE TO YOUR AUTHORIZED AMERICAN AUDIO® SERVICE TECHNICIAN.



The exclamation point within an equilateral triangle is intended to alert the user to the presence of important operating and maintenance (servicing) instructions in the literature accompanying the appliance.

IMPORTANT SAFETY INSTRUCTIONS

READ INSTRUCTIONS — All the safety and operating instructions should be read before the product is operated.

RETAIN INSTRUCTIONS — The safety and operating instructions should be retained for future reference.

HEED WARNINGS — All warnings on the product and in the operating instructions should be adhered to.

FOLLOW INSTRUCTIONS — All operating and use instructions should be followed.

CLEANING — The product should be cleaned only with a polishing cloth or a soft dry cloth. Never clean with furniture wax, benzene, insecticides or other volatile liquids since they may corrode the cabinet.

ATTACHMENTS — Do not use attachments not recommended by the product manufacturer as they may cause hazards.

WATER AND MOISTURE — Do not use this product near water — for example, near a bathtub, wash bowl, kitchen sink, or laundry tub; in a wet basement; or near a swimming pool; and the like.

ACCESSORIES — Do not place this product on an unstable cart, stand, tripod, bracket, or table. The product may fall, causing serious injury to a child or adult, and serious damage to the product. Use only with a cart, stand, tripod, bracket, or table recommended by the manufacturer, or sold with the product. Any mounting of the product should follow the manufacturer's instructions, and should use a mounting accessory recommended by the manufacturer.

CART — A product and cart combination should be moved with care. Quick stops, excessive force, and uneven surfaces may cause the product and cart combination to overturn.



VENTILATION — Slots and openings in the cabinet are provided for ventilation and to ensure reliable operation of the product and to protect it from overheating, and these openings must not be blocked or covered. The openings should never be blocked by placing the product on a bed, sofa, rug, or other similar surface. This product should not be placed in a built-in installation such as a bookcase or rack unless proper ventilation is provided or the manufacturer's instructions have been adhered to.

POWER SOURCES — This product should be operated only from the type of power source indicated on the marking label. If you are not sure of the type of power supply to your home, consult your product dealer or local power company.

LOCATION — The appliance should be installed in a stable location.

NONUSE PERIODS — The power cord of the appliance should be unplugged from the outlet when left unused for a long period of time.

GROUNDING OR POLARIZATION

- If this product is equipped with a polarized alternating current line plug (a plug having one blade wider than the other), it will fit into the outlet only one way. This is a safety feature. If you are unable to insert the plug fully into the outlet, try reversing the plug. If the plug should still fail to fit, contact your electrician to replace your obsolete outlet. Do not defeat the safety purpose of the polarized plug.

- If this product is equipped with a three-wire grounding type plug, a plug having a third (grounding) pin, it will only fit into a grounding type power outlet. This is a safety feature. If you are unable to insert the plug into the outlet, contact your electrician to replace your obsolete outlet. Do not defeat the safety purpose of the grounding type plug.

POWER-CORD PROTECTION - Power-supply cords should be routed so that they are not likely to be walked on or pinched by items placed upon or against them, paying particular attention to cords at plugs, convenience receptacles, and the point where they exit from the product.

OUTDOOR ANTENNA GROUNDING — If an outside antenna or cable system is connected to the product, be sure the antenna or cable system is grounded so as to provide some protection against voltage surges and built-up static charges. Article 810 of the National Electrical Code, ANSI/NFPA 70, provides information with regard to proper grounding of the mast and supporting structure, grounding of the lead-in wire to an antenna discharge unit, size of grounding conductors, location of antenna-discharge unit, connection to grounding electrodes, and requirements for the grounding electrode. See Figure A.

LIGHTNING — For added protection for this product during a lightning storm, or when it is left unattended and unused for long periods of time, unplug it from the wall outlet and disconnect the antenna or cable system. This will prevent damage to the product due to lightning and power-line surges.

POWER LINES — An outside antenna system should not be located in the vicinity of overhead power lines or other electric light or power circuits, or where it can fall into such power lines or circuits. When installing an outside antenna system, extreme care should be taken to keep from touching such power lines or circuits as contact with them might be fatal.

OVERLOADING — Do not overload wall outlets, extension cords, or integral convenience receptacles as this can result in a risk of fire or electric shock.

OBJECT AND LIQUID ENTRY - Never push objects of any kind into this product through openings as they may touch dangerous voltage points or short-out parts that could result in a fire or electric shock. Never spill liquid of any kind on the product.

SERVICING — Do not attempt to service this product yourself as opening or removing covers may expose you to dangerous voltage or other hazards. Refer all servicing to qualified service personnel.

DAMAGE REQUIRING SERVICE - Unplug this product from the wall outlet and refer servicing to qualified service personnel under the following conditions:

- When the power-supply cord or plug is damaged.
- If liquid has been spilled, or objects have fallen into the product.
- If the product has been exposed to rain or water.
- If the product does not operate normally by following the operating instructions. Adjust only those controls that are covered by the operating instructions as an improper adjustment of other controls may result in damage and will often require extensive work by a qualified technician to restore the product to its normal operation.
- If the product has been dropped or damaged in any way.
- When the product exhibits a distinct change in performance — this indicates a need for service.

REPLACEMENT PARTS — When replacement parts are required, be sure the service technician has used replacement parts specified by the manufacturer or have the same characteristics as the original part. Unauthorized substitutions may result in fire, electric shock, or other hazards.

SAFETY CHECK - Upon completion of any service or repairs to this product, ask the service technician to perform safety checks to determine that the product is in proper operating condition.

WALL OR CEILING MOUNTING — The product should not be mounted to a wall or ceiling.

HEAT — The product should be situated away from heat sources such as radiators, heat registers, stoves, or other products (including amplifiers) that produce heat.

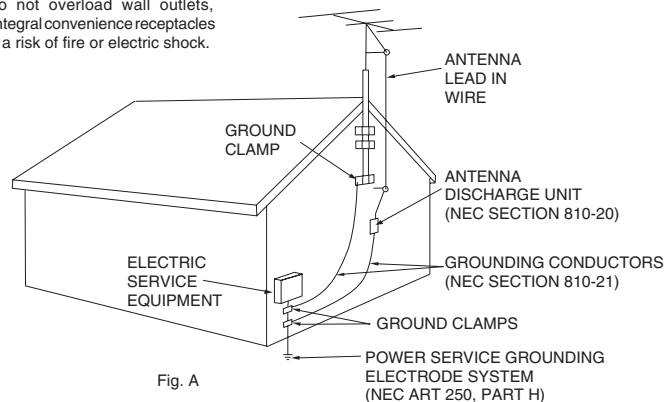

Fig. A

NEC — NATIONAL ELECTRICAL CODE

SAFETY INSTRUCTIONS

1. Read Instructions - All the safety and operating instructions should be read before the CD Player is operated. The safety and operating instructions should be saved for future reference.
2. Heed Warnings - All warnings on the CD Player and in the operating instructions should be adhered to.
3. Water and Moisture - The player should not be used near water - for example, near a bath tub, kitchen sink, laundry tub, in a wet basement or near a swimming pool, etc.
4. Ventilation - The CD Player should be situated so that its location or position does not interfere with its proper ventilation. For example, the CD player should not be situated on a bed, sofa, rug, or similar surface that may block the ventilation openings; or, placed in a built-in installation, such as a bookcase or cabinet that may impede the flow of air through the ventilation openings.
5. Heat - The CD player should be situated away from heat sources such as radiators, heat registers, stoves, or other appliances (including amplifiers) that produce heat.
6. Power Sources - The CD player should be connected to a power supply only of the type described in the operating instructions or as marked on the CD Player.
7. Servicing - The user should not attempt to service the CD Player beyond that described in the operating instructions. All other servicing should be referred to qualified service personnel. The Player should be serviced by qualified service personnel when:
 - A. The power-supply cord or the plug has been damaged.
 - B. Objects have fallen, or liquid has been spilled into the CD Player.
 - C. The CD Player has been exposed to rain or water.
 - D. The CD Player does not appear to operate normally or exhibits a marked change in performance.

Line Voltage Selection

- The desired voltage may be set with the VOLTAGE SELECTOR switch on the rear panel (using a flat head screw driver).
- Do not force the VOLTAGE SELECTOR switch as this may cause damage
- If the VOLTAGE SELECTOR switch does not move smoothly, please contact a qualified service technician.

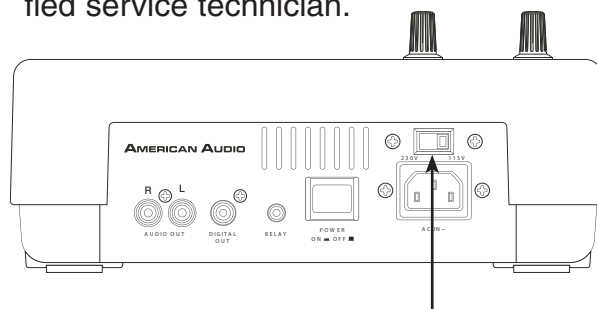

VOLTAGE SELECTOR switch

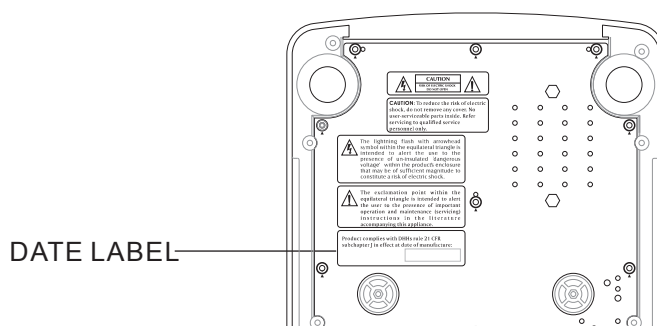

DATE LABEL

The serial and model number for this unit is located on the rear panel. Please write down the numbers here and retain for future reference.

Model No. _____

Serial No. _____

Purchase Notes:

Date of Purchase _____

Dealer Name _____

Dealer Address _____

Dealer Phone _____

UNPACKING

Every CDI-500™ has been thoroughly tested and has been shipped in perfect operating condition. Carefully check the shipping carton for damage that may have occurred during shipping. If the carton appears to be damaged, carefully inspect your CD player for any damage and be sure all equipment necessary to operate the CD player has arrived intact. In the event damage has been found or parts are missing, please contact our toll free customer support number for further instructions. Please do not return the CD player to your dealer without first contacting customer support.

INTRODUCTION

Introduction:

Congratulations and thank you for purchasing the American Audio® CDI-500™ CD player. This CD player is a representation of American Audio's continuing commitment to produce the best and highest quality audio products possible at an affordable price. Please read and understand this manual completely before attempting to operate your new CD player. This booklet contains important information concerning the proper and safe operation of your new CD player.

Customer Support:

American Audio® provides a toll free customer support line, to provide set up help and answer any question should you encounter problems during your initial set up or operation. You may also visit us on the web at www.AmericanAudio.us for any comments or suggestions. Service Hours are Monday through Friday 9:00 a.m. to 5:30 p.m. Pacific Standard Time.

Voice: (800) 322-6337

Fax: (323) 582-2610

E-mail: support@americandaudio.us

To purchase parts online visit <http://parts.americandj.com>

Caution! There are no user serviceable parts inside this CD player. Do not attempt any repairs yourself, without being instructed to do so by an authorized American Audio service technician. Doing so will void your manufacturer's warranty. In the unlikely event your CD player may require service, please contact American Audio® customer support.

Do not discard the packing carton in the trash. Please recycle when ever possible.

SET-UP PRECAUTIONS

Please be sure to make any connections before plugging the CD player in to an electrical outlet. All fader and volume controls should be set to zero or minimum position, before the CD player is switched on. If the CD player has been exposed to drastic temperature fluctuation (e.g. after transportation), do not switch on the CD player immediately. The arising condensation of water might damage your device. Leave the device switched off until it has reached room temperature.

Operating Determinations:

- When installing this CD player, please make sure that the device is not exposed or will not be exposed to extreme heat, moisture or dust!
- Do not operate the CD player in extremely hot (more than 30°/100°F) or extremely cold (less than 5°C/40°F) surroundings.
- Keep the unit out of direct sunlight and away from heaters.
- Operate the CD player only after becoming familiar with its' functions. Do not permit operation by persons not qualified for operating the unit. Most damages are the result of unprofessional operation.

MAIN FEATURES

- 8 times over sampling 1 bit D/A converter
- Auto cue
- 1/75th second frame search
- Real time cue ("Cue on the Fly")
- 8 different speed scan (4 Forward/4 Reverse)
- Pitch display
- Digital RCA coaxial output
- Large bright LCD display can be viewed from wide angles.
- Fader "Q" Start Control **(a)**
- Seamless Loop (uninterrupted loop playback)
- Sampler (Forward & Reverse Sampling)
- Digital Anti-Shock
- Flip-Flop (Relay Playback) **(c)**
- Jog Wheel Pitch Bend +/-100%
- 4 Programmable Cue (Bank) Buttons
- 508 programmable Cue Points (127 x 4) **(d)**
- Adjustable Pitch Percentages: +/-4%, +/-8%, +/-16% or +/-100%
- Instant Start within 10 ms (sound is produced immediately when the PLAY button is pressed)
- Music Master tempo
- Real Time Scratch Play
- Reverse Play
- Pan Effect
- Skid Effect
- Filter Effect
- Phase Effect
- Echo Effect
- Flanger Effect
- Robot Effect
- Trans Effect
- Flash Function **(e)**
- Visual Marker Display with 1:1 Ratio
- Memory Backup, Defaults to last setting **(c)**
- Selectable Single or Continuous Play
- Sleep Mode **(f)**

-
- (a) FADER "Q" START CONTROL:** This feature is used in conjunction with most American Audio® and American DJ® audio mixers that also feature "Fader Q Start" control. For best results use this feature with two (2) CDI-500™ players. Connect your CDI-500's as described in the set-up section of this manual. After set up is completed load your players. By moving the mixer's crossfader from left to right you can start and pause your CDI-500™ playback functions. For Example, when using two (2) CDI-500™ players and a Fader "Q" Start mixer, if your mixer's crossfader is all the way to the left (player one is playing, player two is in cue or pause mode), and you move the fader at least 20% to the right, player two (2) will begin to play and player one (1) will return to cue mode. When the crossfader is to the right, and you move it 20% to the left, player one (1) will begin to play and player two (2) will return to its' cue point. You can create great effects similar to scratching with this feature. After storing cue points on each side of the CD player, different songs or samples may quickly be recalled by moving the mixer crossfader back and forth. New cue points can be easily selected on the CDI-500™ player (see setting cue points page 17). "Q" Start control is easy to use and mastering this feature will help you create amazing effects with your music. Note: For proper "Q" Start operation be sure your mixers "Hamster" setting are set to 1/2 (Normal Setting).
- (b) FLIP-FLOP:** This feature is used in conjunction with American Audio® mixers that also feature Fader "Q" Start. For FLIP-FLOP results you must use two (2) CDI-500™ players. Connect your CDI-500's as described in the set-up section of this manual. This feature will start the next player once one (1) player has ended. For example, if player one (1) is playing a disc and it ends, player two (2) will instantly begin to play. You may set FLIP-FLOP to play track to track or disc to disc. For more information on this feature, see FLIP-FLOP™ on page 33.
- (c) MEMORY BACKUP:** The CDI-500™ has a five (5) year memory back-up, that will save your setting in case the power supply is accidentally disconnected. CDI-500™ will remember your last setting (repeat, SGL, CTN, and effect parameters) even if you disconnect your main power. The CDI-500™ will store your cue points and samples in memory if you accidentally eject a disc or shut off the power. See memory on page 23.
- (d) PROGRAMMABLE CUE POINTS:** The CDI-500™ has four *BANK BUTTONS* (12). 127 Cue points can be stored in each of the *BANK BUTTONS* (12), for a total of 508. These cue points can be stored into the unit's internal memory and may be recalled at any time. See setting "Cue Points" on page 17.
- (e) FLASH START FUNCTION:** This feature is used in conjunction with most American Audio® and American DJ® audio mixers that also feature "Fader Q Start" control. This function work similar to the Fader "Q" Start Control described above. In this case the crossfader is used to start and stop a any sample that is stored in the players memory.
- (f) SLEEP MODE:** The CDI-500's laser and pick-up assembly will power down after 15 minutes of inactivity (when in pause or cue mode). This will lengthen the life of your motor drive and laser. To initialize the player, just press the cue or play buttons.

SET-UP

FOR BEST CD-R DISC PLAYBACK RESULTS IN THIS CD PLAYER PLEASE FOLLOW THESE GUIDELINES:

1. High quality CD-R Audio discs (should conform to the standards of the Orange Book 2).
2. Use a high quality bit rate when recording discs. (At least 160kbps)
3. Record discs in the slowest speed possible. (i.e. 2x or 4x speed)

1. Checking the Contents

Be sure your CDI-500™ was shipped with the following:

- 1) CDI-500™ Professional CD player.
- 2) Operating instructions (this booklet).
- 3) One (1) set of RCA cables.
- 4) One (1) 1/8" mini plug.
- 5) Warranty card.

2. Installing the Units

Place your unit on a flat surface or mount it in a flat surface case

3. Connections

- 1) Be sure the power is disconnected.
- 2) Connect the included RCA cable from your CDI-500™ outputs to the inputs on your mixer.
- 3) Use the supplied 1/8" mini plug cable to connect your CDI-500™ to a mini jack connection (A or B) on a compatible American Audio® or American DJ® "Fader Q Start" mixer. (This will enable the Fader "Q" Start function)

CAUTION:

- **Be sure to use the supplied mono 1/8" control cables. Using other types of cable may result in unit damage**
- **To avoid severe damage to the unit, be sure the power is off when making connections to the unit.**

CAUTION:

- The player will work normally when the main unit is mounted with the front panel within 15 degrees of the vertical plane. If the unit is tilted excessively, discs may not be loaded or unloaded properly. **(Figure 1)**

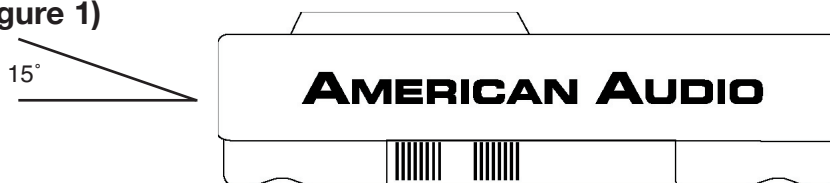

Figure 1

CAUTION:

- The LCD is designed to be clearly visible within the angles shown in **Figure 2**. Mount the control unit so that the visual angle is within this range.



Figure 2

GENERAL FUNCTIONS AND CONTROLS

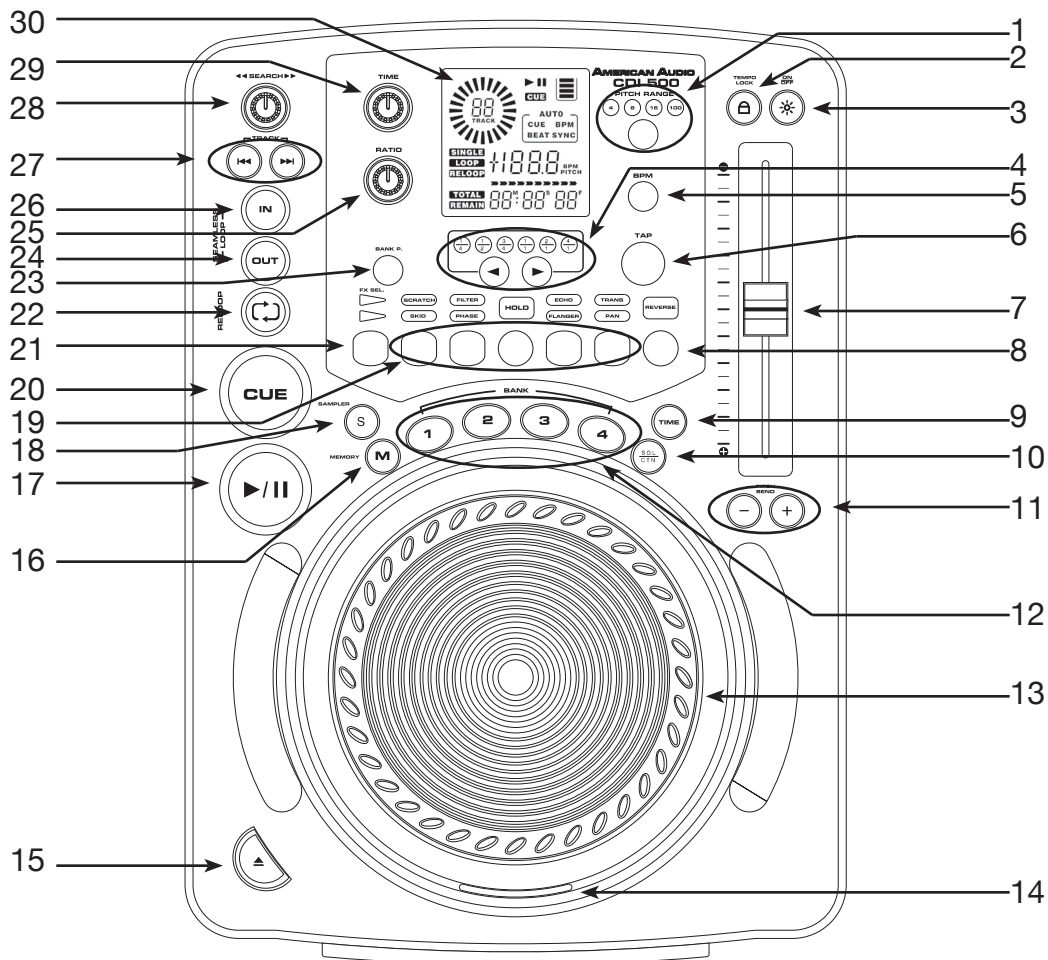

Figure 3

A. TOP UNIT CONTROLS (FIGURE 3)

1. PITCH PERCENTAGE SELECTOR - Press this button to choose any pitch range percentages of 4%, 8%, 16%, and 100%. See page 26 for more details.

2. TEMPO LOCK FUNCTION - This button activates the TEMPO LOCK function. This function allows you to use the PITCH SLIDER to speed up or slow down playback speed without altering the tonal pitch of the track. When this function is not engaged the original tonal pitch of the track will be altered giving you the "chipmunk" effect when a track is played at a high rate of speed, or the "James Earl Jones" effect when a track is slowed to much.

3. PITCH ON/OFF BUTTON - This button is used to turn the *PITCH SLIDER* (7) function on and off. The pitch percentage can be changed between 4%, 8%, 16% and 100%. 4% will allow the least

amount of pitch manipulation and 100% will allow the most amount of pitch manipulation. To adjust to the different values please see page 26.

4. BEAT SELECT BUTTONS - These buttons' are used to select the delay time of an effect to the beat of music. The beat delay ratios are 1/4, 1/2, 3/4, 1/1, 2/1, and 4/1.

NOTE: A effect must be selected to set a delay time.

5. BPM BUTTON - The BPM button is used to toggle between two readouts in the LCD (30). When the BPM function is activated, the LCD (30) will display a BPM meter. The BPM meter will automatically and accurately detail a tracks beats per a minute (BPM). When this function is not active the LCD will display the amount of pitch (if any) that is being applied to the track.

6. TAP BUTTON - This button is used to override

GENERAL FUNCTIONS AND CONTROLS (Cont.)

and manually set a tracks BPM. Occasionally the built-in BPM meter may not function as desired. This button allows you to override the internal beat clock and manually set a tracks BPMs. To manually set the BPMs; tap this button a few times to a tracks heavy down beat, the unit will automatically calculate your tapping and translate it into a tracks BPM. The BPM readout is then displayed in the LCD (30). To return to the automatic BPM counter, press and hold down the BPM BUTTON for at least 2 seconds and then release.

7. PITCH SLIDER - This slider is used to adjust the playback pitch percentage. The slider is a set adjustment and will remain set until the pitch slider is moved or the pitch function has been turned off. This adjustment can be made with or without a disc in the drive. The pitch adjustment will remain even if a disc has been removed and will reflect on any other disc loaded into the player. That is to say, if you set a +2% pitch on one disc, remove that disc and load another, that disc too will have a +2% pitch. The amount of pitch being applied will be displayed in the LCD (30).

8. REVERSE - This button activates reverse play mode This function will play your track or sample in reverse. All pitch and effect functions will operate normally in this mode

9. TIME BUTTON - The TIME button will switch the time value described in the *TIME METER* between ELAPSED PLAYING TIME, TRACK REMAINING TIME, and TOTAL REMAINING TIME.

10. SGL/CTN - This function allows you to choose between single track play or continuous track play (all tracks in order). This function also operates in FLIP-FLOP mode.

11.(-) PITCH BEND BUTTON - The (-) pitch bend function creates a momentary "Slow Down" in the CD's BPM's (Beats per minute) while it is playing. This will allow you to match the beats between two playing CD's or other playing music source. Remember, this is a momentary function. When you remove your finger from the pitch button, the BPM's will automatically return to *PITCH SLIDER'S (7)* pitch value Holding down this but-

ton will give a maximum of -100% pitch. Use this function to slow to another playing music source. Be sure to notice that this function is a momentary pitch adjustment, for a more precise adjustment use the *PITCH SLIDER (7)* to match the BPM's with another playing music source.

(+) PITCH BEND BUTTON - The (+) pitch bend function creates a momentary "BUMP" in the CD's BPM's (Beats per minute) while it is playing. This will allow you to match the beats between two playing CD's or any other music source. Remember, this is a momentary function. When you remove your finger from this button, the BPM's will automatically return to the *PITCH SLIDER'S (7)* selected pitch. Holding down this button will give a maximum of +100% pitch.

12.BANK BUTTONS 1-4 - These buttons are used to store either four (4) cue points or four (4) samples. Each Bank Button can store either a sample or a cue point.

13. JOG WHEEL/EFFECTS PLATTER - This wheel has three functions;

A. The jog wheel will act as a frame search control when the CD is in pause or cue mode, allowing you to set a cue point.

B. The wheel also works as a pitch bend during playback. Turning the wheel clockwise will increase the pitch percentage up to 100%, and turning the wheel in the counter-clockwise direction will decrease the pitch percentage down to -100%. The pitch bend will be determined on how long you turn the jog wheel continuously.

C. The jog wheel will also control the bop function and a speed effect when the jog wheel effect function is activated, see page 24.

14. CD LED - This LED will light up when a CD is loaded and the player is ready for use.

15. EJECT FUNCTION - Pressing this will eject the CD. The eject function will only when the unit is in cue or pause mode, this is to prevent accidentally ejecting the disc when in play mode.

16. MEMORY BUTTON - This button allows you to program up to four (4) cue points or four (4) samples in to the four *BANK BUTTONS (12)*. The

GENERAL FUNCTIONS AND CONTROLS (Cont.)

samples or cue points can then be recalled at any time even when the disc has been removed and replaced at a later time. See System Memory on page 23.

17. PLAY/PAUSE BUTTON - Each press of the PLAY/PAUSE BUTTON causes the operation to change from play to pause or from pause to play. While in play mode the green play LED will glow, and while in pause mode the green play LED will flash.

18. SAMPLER BUTTON - This is used to activate the sampler function. When this function is activated a created sample will play in a continuous loop mode.

19. EFFECTS AND HOLD BUTTON -

SCRATCH/SKID BUTTON - This button is used to activate and deactivate either the Scratch or Skid effect. See built-in effects on page 28.

FILTER/PHASE BUTTON - This button is used to activate and deactivate either the Filter or Phase effect. See built-in effects on page 29.

HOLD BUTTON - This button allows you to set and lock any new parameters you set to the effects. The button LED will glow red when the hold function is activated. If the hold function is not selected any changes to the effect parameters will be momentary.

ECHO/FLANGER EFFECT - This button is used to activate and deactivate either the Echo or Flanger effect. See built-in effects on page 29.

TRANS/PAN EFFECT - This button is used to activate and deactivate either the Trans or Pan effect. See built-in effects on page 30.

20. CUE - Pressing the **CUE** button during playback immediately pauses playback and returns the track to the last set cue point (see setting a CUE POINT, page 17). The blue CUE BUTTON LED will glow when the unit is in cue mode The LED will also flash every time a new CUE POINT is set. The CUE button can be held down to momentarily play the CD. When you release the

CUE button it instantly returns to the CUE POINT. You can also tap the CUE button to create a BOP EFFECT (for definition of BOP EFFECT, see page 24).

21. FX SEL. (SELECT) BUTTON - The effects are located on two different layers. This button allows you to select an effect on a different layer.

22. RELOOP BUTTON - If a SEAMLESS LOOP has been made (see setting a SEAMLESS LOOP on page 18), but the CD Player is not actively in SEAMLESS LOOP mode (a loop is not playing), pressing the RELOOP BUTTON will instantly reactivate the SEAMLESS LOOP mode. To exit the loop, press the *OUT BUTTON* (24). LOOP and RELOOP will appear in the *LCD DISPLAY* (30) when the RELOOP function is available.

23. BANK PROGRAM BUTTON - This function will allow you to program up to 12 saved samples. See page 22 for more information.

24. OUT BUTTON - This button is used to set the ending point of a loop. A loop is started by pressing the *IN BUTTON* (26), and pressing the OUT BUTTON to set the loop ending point. The loop will continue to play until the OUT BUTTON is pressed once again.

25. PARAMETER RATIO - This knob is used to adjust the parameter ratio value.

26. SEAMLESS LOOP IN BUTTON - "CUE ON THE FLY" - This function allows you to set a CUE POINT (see CUE POINT page 17) without music interruption ("on the fly"). This button also sets the starting point of a seamless loop (see SEAMLESS LOOP).

27.  TRACK BUTTON - This button is used to select a track. Tapping this button will forward skip to the next track, holding down this button will rapidly forward skip through the tracks.

 TRACK BUTTON - This button is used to select a track. Tapping this button will back skip on track, holding down this button will rapidly BACK SKIP through the tracks.

28. SEARCH KNOB - This knob has four forward and four reverse speed positions allowing you to quickly scan through tracks. The more you

GENERAL FUNCTIONS AND CONTROLS (Cont.)

turn the knob in either direction, the faster your search.

29. PARAMETER TIME - This knob is used to adjust the parameter time value.

30. LCD DISPLAY - This high quality LCD display indicates all the functions, as they are occurring. This display is viewable at several comfortable angles (see page 8). The display ICONS will be explained in the section D.

GENERAL FUNCTIONS AND CONTROLS (Cont.)

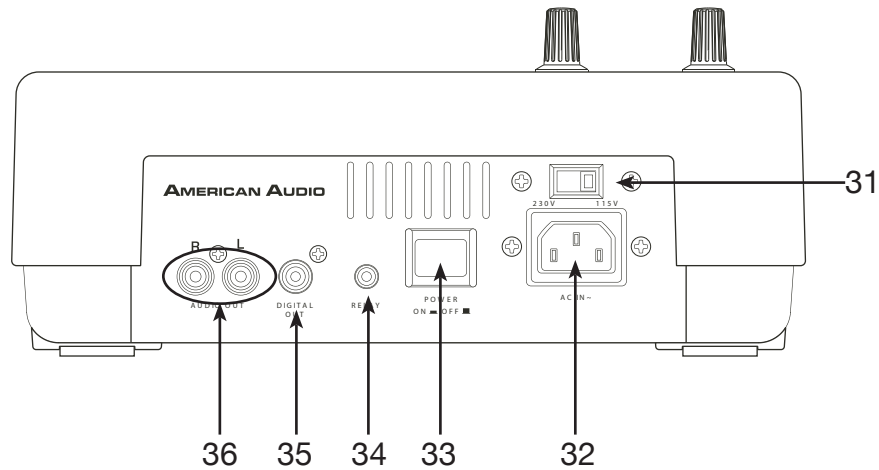

Figure 4

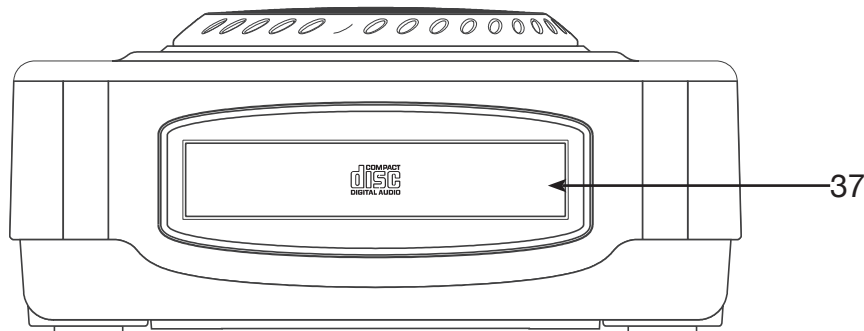

Figure 5

B. REAR PANEL (FIGURE 4)

31. VOLTAGE SELECTOR - Because power supplies vary from location to location we have incorporated a selectable voltage switch. This switch can select a voltage input of 120v~60Hz or 220v~50/60Hz. Always disconnect the power plug before changing the voltage.

32. POWER CONNECTOR - This connection is used to connect your main power. Be sure that your local power matches the unit's required power. **NEVER REMOVE THE GROUND PRONG FROM THE POWER CABLE, DOING SO MAY RESULT IN IMPROPER OPERATION.**

33. POWER BUTTON - This button is used to turn your unit's power on and off.

34. CUE MINI JACK - Connect the supplied mini-plug from CUE JACK on the rear of your unit to a compatible American Audio® mixer's CONTROL out. This feature is only available on American

Audio's "Q" series mixers.

35. DIGITAL OUT - Use this connection to create near perfect copies of your disc to a Mini disc, CD-R, or any other digital recording device.

36. AUDIO OUT R & L - Audio out signals. Connect stereo RCA cable from AUDIO OUT to a mixer's LINE input.

C. FRONT PANEL (FIGURE 5)

37. TRANSPORT TRAY - This tray is used to load and unload a compact disc. The tray is opened and closed by pressing the OPEN/CLOSE BUTTON (15). Never attempt to force the transport tray open or closed when the power is turned off.

GENERAL FUNCTIONS AND CONTROLS (Cont.)

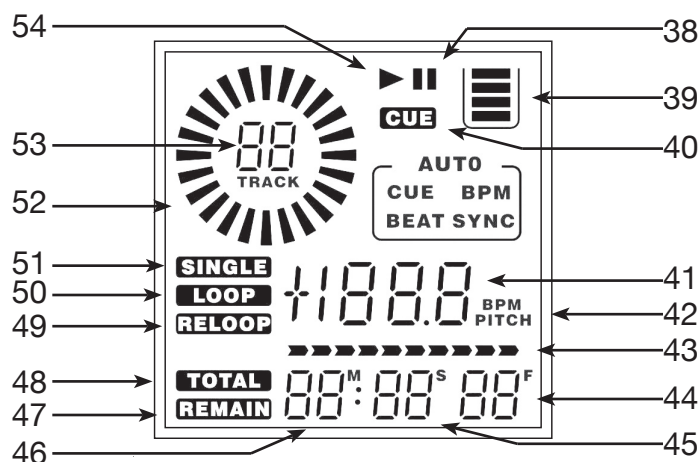

Figure 6

D. LCD DISPLAY PANEL (FIGURE 6)

38. PAUSE INDICATOR - This indicator will glow when the drive is in pause mode.

39. MEMORY BUCKET INDICATOR - This indicator serves two functions. The black bucket outline details the cue memory status, a full bucket outline indicates the cue memory is full. The five bars in the memory bucket detail the anti-shock memory state. Each bar indicates 2 seconds of digital anti-shock

40. CUE INDICATOR - This indicator will glow when the unit is in CUE mode and will flash every time a new CUE POINT is set.

41. PITCH/BPM METER - This meter will display either the pitch percentage applied by the *PITCH SLIDER* (7) or BPM.

42. PITCH/BPM INDICATOR - Indicator will light up when the Pitch is activated or BPM.

43. TIME BAR INDICATOR - This bar gives a visual approximation of a track's or disc's time. This bar will begin to flash when a track is ending. The flashing bar is great reminder, that time is running out to get that next track ready to go.

44, 45, 46. TIME METERS - These indicators will detail the current Minutes, Seconds, and Frames. The meter will display either the elapse, total, or remaining time of a track or the entire disc. The display time will depend on the selected time function. The selected time function will be displayed above the TIME METER as *TOTAL REMAIN* (48), *REMAIN* (47) OR *ELAPSE*.

47. REMAIN INDICATOR - When "REMAIN" is indicated in the *LCD DISPLAY* (30) the *TIME DESCRIBED* (44, 45, & 46) in the *LCD* will define the current track's remaining time.

48. TOTAL/REMAIN INDICATOR - When TOTAL is indicated in the *LCD DISPLAY* (30) the *TIME DESCRIBED* (44, 45, & 46) in the *LCD* (30) will define the total disc remaining time. When REMAIN is indicated in the *LCD DISPLAY* (19) the *TIME DESCRIBED* (44, 45, & 46) in the *LCD* will define the current track's remaining time.

49. RELOOP INDICATOR - Appears when LOOP is engaged or ready to be engaged.

50. LOOP - This icon will flash when you are in loop mode. This icon will glow when a loop has been created but is not actively playing.

51. SINGLE INDICATOR - This indicates that the CD drive is in single play mode, the track will play once and return to CUE mode. If the single indicator is not on the unit is in continuous mode. In continuous mode the drive will play all the remaining tracks on the disc. Once the remaining tracks have ended the unit will return to cue mode

52. CD DIRECTION INDICATOR - Indicates the direction the CD is rotating. Counter-Clockwise rotation means the CD is playing in reverse.

53. TRACK INDICATOR - This indicator describes which track is currently cued or is playing.

54. PLAY INDICATOR - This indicator will glow when the unit is in play mode.

BASIC OPERATIONS

1. LOADING/EJECTING DISCS

The CDI-500™ can only play 3 inch and regular 5 inch CDs. When loading a CD into the player always hold the disc by it edge). Load the disc label side up and never touch the signal surface (the glossy side). To remove a disc from the player press the *EJECT BUTTON* (15), see Figure 7.

CAUTION:

- **NEVER** attempt to load any other objects besides 3" and 5" CDs.
- **NEVER** attempt to load more than one disc at a time. Doing so may result in sever damage to your unit.
- **DO NOT** force the transport tray open or close when the power is off, this may damage the drive system.

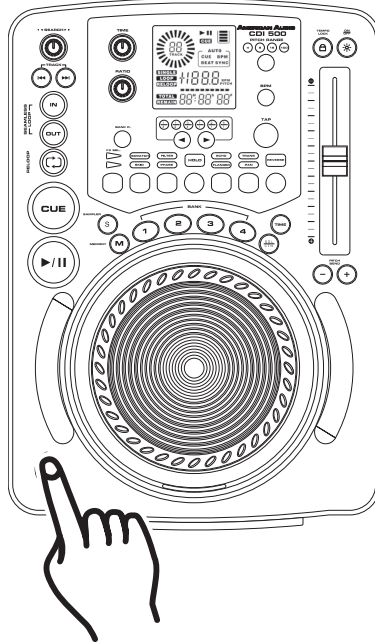

Figure 7: Press the Eject button to load and remove a disc. **Remeber:** When loading a disc always hold the disc by it edges and load the disc label side up.

2. SELECTING TRACKS

Select a desired track by using either of the two *TRACK BUTTONS* (27). Tapping the *TRACK BUTTONS* (27) once will select either the next higher or lower track. You may hold down the *TRACK BUTTONS* (27) to change tracks continuously at a faster speed. If you are using the *TRACK BUTTONS* (27) to select a new track during playback (a track is already in play mode) the new track you selected will immediately begin playback as soon as the search operation is completed.

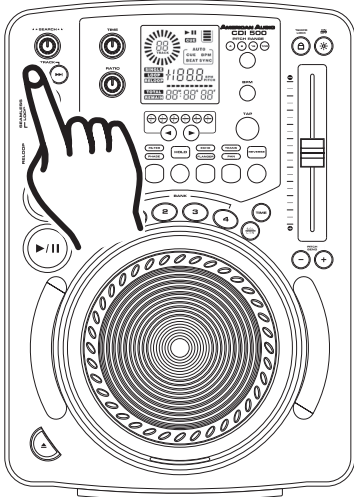

Figure 8: Tapping the reverse track button will jump back to the previous track.

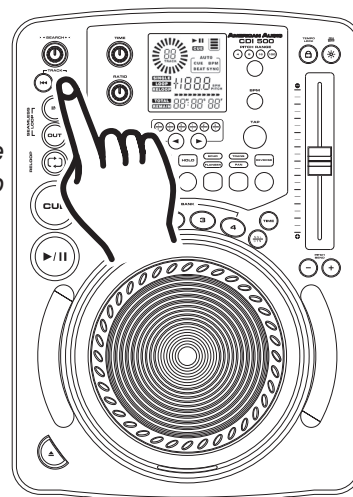

Figure 9: Tapping the forward track button will skip forward to the next track.

BASIC OPERATIONS (CONT.)

3. STARTING PLAYBACK - *Figure 11*

Insert an audio CD as described on page 15 (*LOADING/EJECTING DISCS*). Pressing the *PLAY/PAUSE BUTTON (17)* with an audio CD loaded will immediately start playback. The *PLAY (54)* indicator will glow as soon as playback begins. The point at which playback starts (cue point) will automatically be stored in the memory as the cue point. The unit will return to this cue point (the point at which playback started) when the *CUE BUTTON (20)* is pressed.

4. AUTO CUE

This function will automatically set a cue point to the first audio source when a CD is inserted. The first set cue point will always be the beginning of track 1. If a new track is selected before the *PLAY BUTTON (17)* is pressed, a new *CUE POINT* will be set to reflect the new starting point.

5. STOPPING PLAYBACK - *Figures 10 & 11*

Stopping playback will not stop the drive mechanism, but merely pause or cue the track, this functions allows the unit to begin play instantly. The drive mechanism will only stop if a disc is ejected or the unit has gone in to sleep mode. There are two ways to stop (pause) playback:

- 1) Press the *PLAY/PAUSE BUTTON (17)* during playback. This will pause playback at the exact same point the *PLAY/PAUSE BUTTON (17)* was pressed.
- 2) Press the *CUE BUTTON (20)* during playback. This will pause playback and return the track to the last set cue point.

6. PAUSING - *Figure 10*

This function pauses playback at the exact same point the *PLAY/PAUSE BUTTON (17)* was pressed. Pressing the *PLAY/PAUSE BUTTON (17)* will switch between play and pause modes. When the unit is in pause mode the *PAUSE INDICATOR (38)* in the *LCD DISPLAY (30)* will glow. The green *PLAY/PAUSE BUTTON (17)* LED will also begin to flash repeatedly.

7. FRAME SEARCH

This feature allows you to scroll through a track frame by frame, allowing you to find and set a starting cue, sample, or loop point. To use the scroll function you must first be in Pause Mode (see section 6) or Cue Mode (see section 5). Once you are in Pause or Cue mode, turn the *JOG WHEEL (13)* to scroll through the track (*Figure 12*). Turning the wheel in a clockwise direction will advance the frame search and turning the wheel in a counter-clockwise direction rewinds the frame search. When you use the *JOG WHEEL (13)* the monitor (headphone level) function allows you to here what you are scrolling through. Once you reach your desired starting point you can set a cue (starting) point by pressing the *PLAY/PAUSE BUTTON (17)* as in *Figure 10*. Pressing the *CUE BUTTON (20)* as in *Figure 11* will now return you to the point you just set.

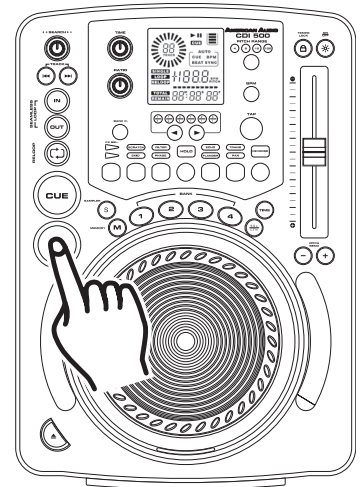

Figure 10

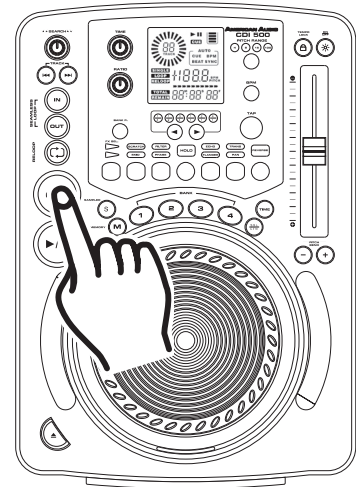

Figure 11

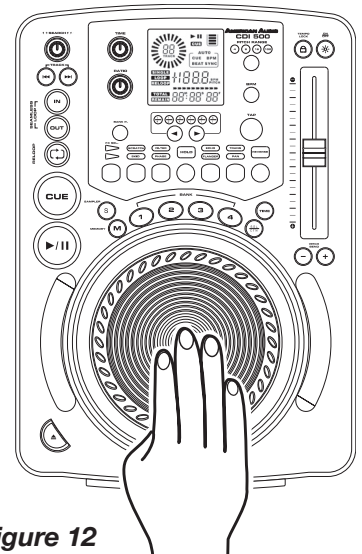

Figure 12

BASIC OPERATIONS (CONT.)

8. SCANNING (FAST FORWARD / FAST REVERSE)

This function gives you a fast search through a disc or track. Turn the *SEARCH KNOB (13)* in clockwise direction for fast forward or turn the wheel counterclockwise for fast reverse. You can scan in four different forward and four different reverse speeds depending on how much you rotate the knob.

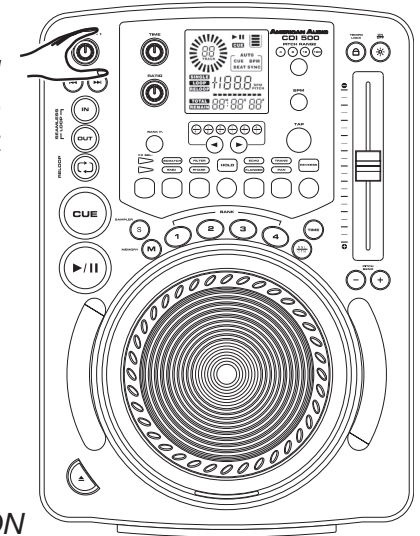

Figure 13

9. SETTING and STORING a CUE POINT:

Setting A Cue Point:

A cue point is the exact point playback will begin when the *PLAY/PAUSE BUTTON (17)* is pressed. You may set your cue points anywhere on a disc or in a track. You may set up to five independent cue points per disc. Four cue points are stored in the *BANK BUTTONS 1-4 (12)* and one is shared by the *IN BUTTON (26)* and the *CUE BUTTON (20)*. There are two (2) ways to set and create a CUE point as detailed in figures 14 and 15.

- 1) You may press the *IN BUTTON (26)* on the fly (while the disc is playing). This will set a CUE Point without music interruption. Pressing the *CUE BUTTON (20)* will now return you to the same point that you pressed the *IN BUTTON (26)*. You may now store this CUE Point in any of the *BANK BUTTONS 1-4 (12)*.

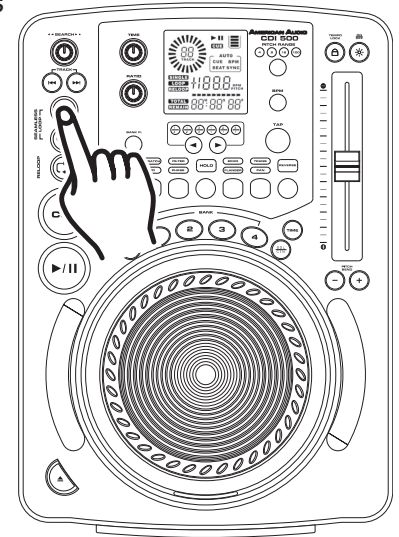

Figure 14

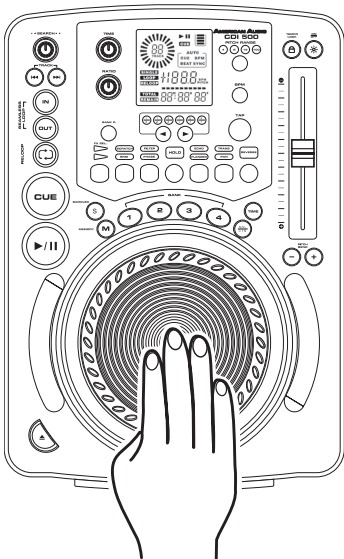

Figure 15

- 2) You may also use the *JOG WHEEL (13)* to set a cue point. While a disc is in PAUSE or CUE mode, use the *JOG WHEEL (13)* to scroll through a track to find your desired starting point. Once you have found your desired position press the *PLAY BUTTON (17)* to set your cue point. Pressing the *CUE BUTTON (20)* or the *IN BUTTON (26)* will now return you to this exact point.

BASIC OPERATIONS (CONT.)

Storing A Cue Point:

Once you have set your CUE Point by one of the two means listed on page 17, you may store your cue point in one of the **BANK BUTTONS (12)**. Once you store this cue point in memory you may recall it at any time and you may even recall memory if the disc has been removed or power had been disconnected, see **SYSTEM MEMORY** on page 23. You may store a maximum of four cue points per a disc and maximum of 508 cue points can be saved in unit's memory. The **MEMORY BUCKET (39)** in the **LCD DISPLAY (30)** will approximate the available memory. Either a **CUE POINT** or a **SAMPLE** (See creating a sample loop on page 19 and 20) can be stored into a **BANK BUTTON (12)** not both. **To Store a cue point:**

- 1) Create a Cue Point by one of the two means listed on page 17. Press the **MEMORY BUTTON (16)**, as in Figure 16. The yellow Memory Cue LED will glow indicating the store memory function has been activated. You may now press any one of the four **BANK BUTTONS (12)** to store your cue point into memory (Figure 17). After pressing one of the **BANK BUTTONS (12)**, the corresponding Bank Button LED will flash briefly. The LED on the the **BANK BUTTON (12)** will remain lit indicating either a sample or cue point is stored in memory. The yellow Memory LED will turn off.

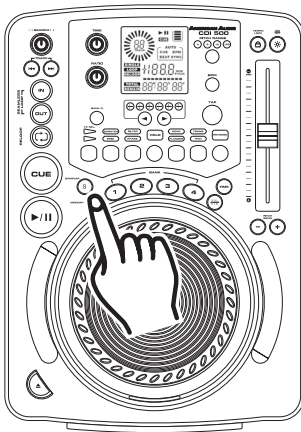

Figure 16

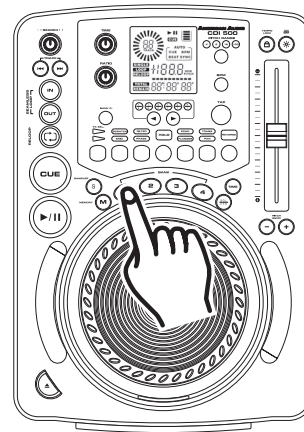
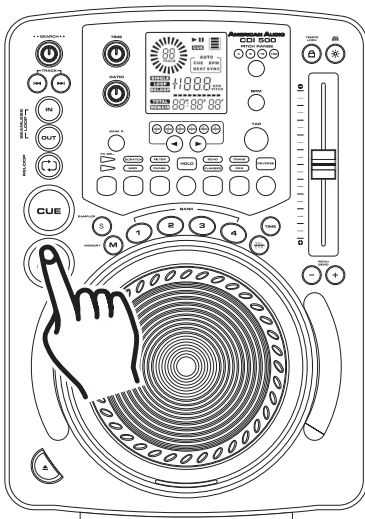

Figure 17

- 2) Repeat the above steps to store up to three more Cue Points. Once your four cue points have been stored you may access them at any time. During playback the cue points will instantly start playback from that point without any music interruption. Please note in order to access these cue point, the disc used to create the cue points must be loaded in the drive.

10. CREATING AND PLAYING A SEAMLESS LOOP

A seamless loop is a sound loop that plays continuously without sound interruption. You can use this loop to create dramatic effect in your mixing. This loop has no time limit and you could actually loop the entire length of disc. You create a seamless loop between two continuous points of a disc.



- 1) Press **PLAY/PAUSE BUTTON (17)** to activate playback mode.

Figure 18

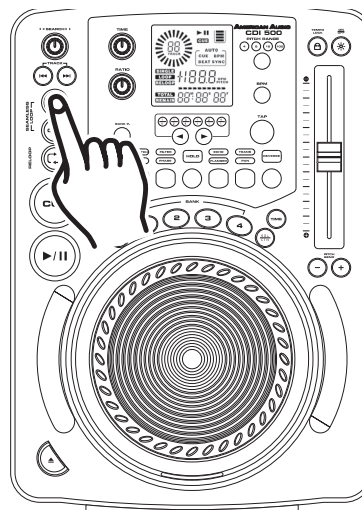

- 2) Press the **IN BUTTON (26)**. This will set the starting point of the **SEAMLESS LOOP**. The **IN BUTTON (26)** LED will flash then glow.

Figure 19

BASIC OPERATIONS (CONT.)

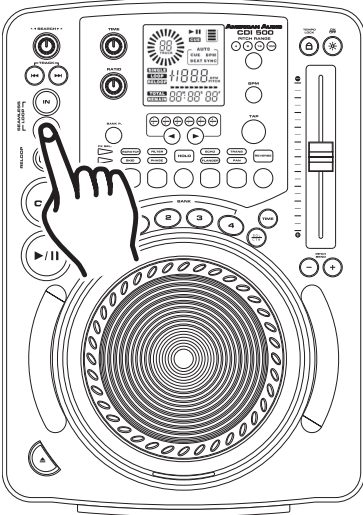

Figure 20

- 3) Press the *OUT BUTTON* (24) to set the ending point for your SEAMLESS LOOP (Figure 20). The *IN BUTTON* (26) and *OUT BUTTON* (24) LEDs will immediately begin to flash rapidly, indicating the SEAMLESS LOOP mode has been activated.

LCD LOOP INDICATORS - During a seamless loop, the *LOOP* (50) and *RELOOP* (49) INDICATORS will turn on in the *LCD DISPLAY* (30) indicating a loop is active.

EXITING A LOOP - To exit a SEAMLESS LOOP, press the *OUT BUTTON* (24). The *IN BUTTON* (26) and *OUT BUTTON* (24) LEDs will remain on, but will stop flashing. Music playback will resume normal play. The *IN BUTTON* (26) and *OUT BUTTON* (24) LEDs will remain on to remind you that a loop is stored in memory.

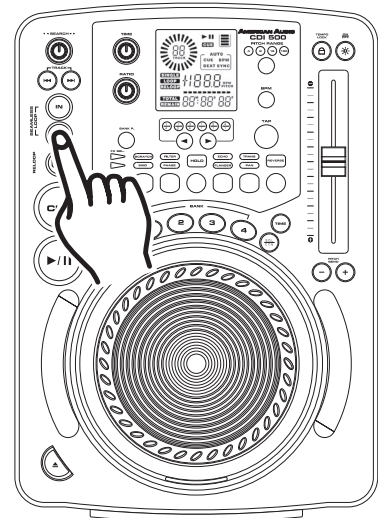

Figure 21

REPLAY LOOP - The *RELOOP* (22) function allows you to return to your stored loop at any time. The *IN BUTTON* (26) and *OUT BUTTON* (24) LEDs will indicate a loop is stored in memory, and may be played at any time. To replay the loop, press the *RELOOP BUTTON* (22). The *IN BUTTON* (26) and *OUT BUTTON* (24) LEDs will again begin to flash indicating SEAMLESS LOOP mode has been activated and your stored loop will immediately begin to play.

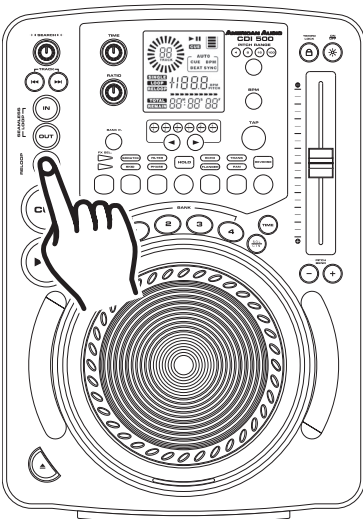

Figure 22

Please note: Only the ending point of the loop may be edited. You may make your loop shorter or longer. Before you can edit your seamless loop you obviously must first create a seamless loop to edit. If you haven't created a SEAMLESS LOOP, follow the instructions in step 10 to create a loop. If a SEAMLESS LOOP has already been created, press the *RELOOP BUTTON* (22) to activate your SEAMLESS LOOP (Figure 22) if it is not already activated. To edit your seamless loop's ending point:

- 1) Press the *OUT BUTTON* (24) to return to normal play from the loops cue point. (Figure 21). This will disengage the SEAMLESS LOOP mode and allows you to edit the loops ending point.
- 2) Press the *OUT BUTTON* (24) again when you reach your new ending point (Figure 21).
 - **FOR A SHORTER LOOP:** Press the *OUT BUTTON* (24) at sooner point in the track (Figure 21).
 - **FOR LONGER LOOP:** Press the *OUT BUTTON* (24) at later point in the track (Figure 21).

BASIC OPERATIONS (CONT.)

12. Using the Built In Sampler:

Your CDI-500™ comes with an advanced built in sampler. You may store up to four samples in the four **BANK BUTTONS (12)**. Once again please note you may only store either a **CUE POINT** or a **SAMPLE** into a **BANK BUTTON (12)**, not both. Your sample can be a maximum of 6.5 seconds in length. A sample can be recalled while a CD is playing, while the CD drive is in **PAUSE MODE**, you may even play a sample when the CD has been removed. You may play your sample at anytime without music interruption. If you play your sample when the unit is already in playback mode your sample will overlap the current music source. You can also play your sample once or in a continuous loop. As with cue points you may store approximately 508 (127 x 4) samples in a drives memory (depending on available memory). The **MEMORY BUCKET (39)** on the **LCD DISPLAY (30)** will approximate the remaining memory.

To create a sample:

- 1) Initialize a loop (see creating a seamless loop on page 18 and 19). **If your loop is longer than 6.5 seconds it can not be stored as a sample and will be stored as a Cue Point.**

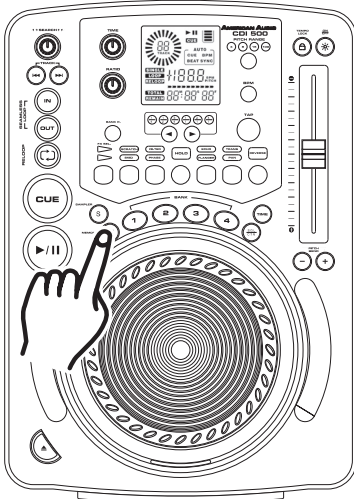

Figure 23

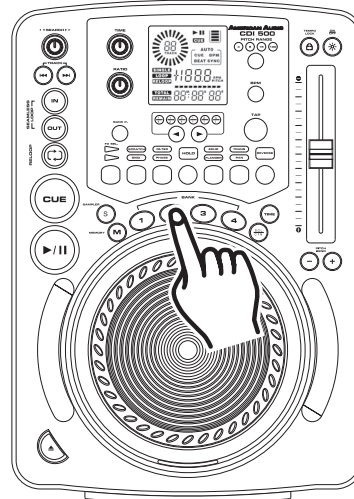

Figure 24

- 2) Press the **MEMORY BUTTON (16)**. The **MEMORY BUTTON (9)** Yellow LED will glow indicating memory is ready to be stored.

- 3) Select one of the four **BANK BUTTONS (12)** you wish to store your loop in and press that button.

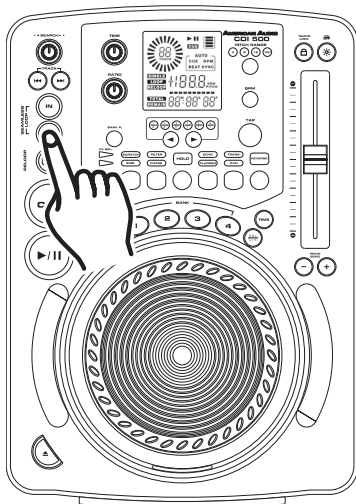

Figure 25

- 4) The yellow **MEMORY BUTTON (16)** LED will turn off, when your sample is locked into memory.
- 5) At this point your sample has been stored into memory. The original loop you used to create the sample will remain playing until the **OUT BUTTON (24)** is pressed (Figure 25).
- 6) Your sample can now be recalled at any time even when the unit is in **PAUSE MODE**. To recall the sample be sure the sample function is on, by pressing the **SAMPLE BUTTON (18)**. The yellow sample button LED will turn on. To play your sample in a continuous loop leave the sample function on. To play your sample just once, turn the sample function off immediately after initiating your sample. With the sample function on the sample will continue to play until the sample function is turned off.

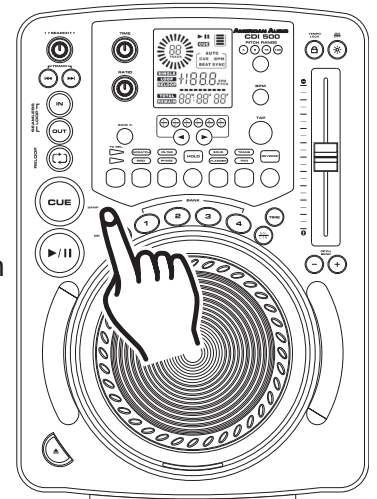

Figure 26

7) Important Notice: If you try to activate your sample without turning the sample function on, the **BANK BUTTON (12)** will act as a cue point!

BASIC OPERATIONS (CONT.)

Changing the Sample Parameters:

Changing the sample parameters allows you to change the sample's volume (SV) and pitch (SP). The parameter values for the pitch range from -10:00 to +10:00 (-10:00 being the lowest) and volume values range from 00:00 to 02:55 (00:00 being the lowest). A higher value will increase the pitch percentage or volume. It's important to understand that the pitch value is basically a speed adjustment and has nothing to do with tonal quality. The values can be either a momentary change or set adjustment. The sample values are changed in three easy steps, while in sample playback mode:

Changing the Sample Parameters - Speed

While a sample is playing push the *PARAMETER TIME KNOB* (29). One tap will display *SP +0 00* in the *LCD DISPLAY* (30). *SP* will signify the pitch percentage (speed) of the sample. *+0 00* is your default setting - Normal playback. Turning the knob in a clockwise direction will increase your pitch. Turning the knob in a counter-clockwise direction will decrease the parameters value.

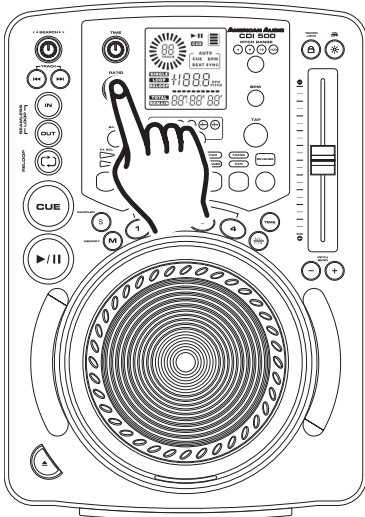

Figure 28

Changing the Sample Parameters - Hold Function

Hold Function - This mode will allow you to save and lock your parameter adjustments, if the hold function is not activated before you set your parameters, your parameter adjustments will be momentary. If you select the *HOLD BUTTON* (19) all parameters will remain until changed again or power is shut off, unless they are stored in to the unit's memory.

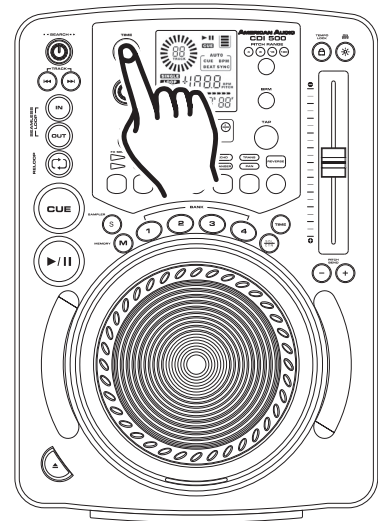

Figure 27

Changing the Sample Parameters - Volume

While a sample is playing push the *PARAMETER RATIO KNOB* (25). One tap will display *SV 02 55* in the *LCD DISPLAY* (30). *SV* will signify the volume of the sample. *02 55* is your default setting - Normal playback. Any adjustments will be based on this default setting. Turning the knob in a clockwise direction will increase the volume. Turning the knob in a counter-clockwise direction will decrease the parameters value.

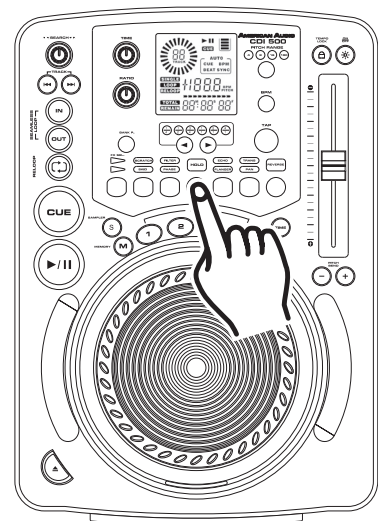

Figure 29

BASIC OPERATIONS (CONT.)

14. BANK BUTTONS (12):

These buttons are used to store your samples and cue points. Only a sample or a cue point can be stored into each of these four banks. When a sample is stored in of the banks you may use the sample starting point as a cue point. The *BANK BUTTONS* instantly recall and play any of your stored samples or cue points without interrupting music playback. When in sample mode, (see "Using the Built-In Sampler" on page 20) and during playback, pressing any of the *BANK BUTTONS* that stores a sample, will immediately begin to play that sample without interruption of music. If the unit is in sample mode and the drive is not in playback mode, pressing any of the *BANK BUTTONS* that stores a sample, will immediately begin to play that sample.

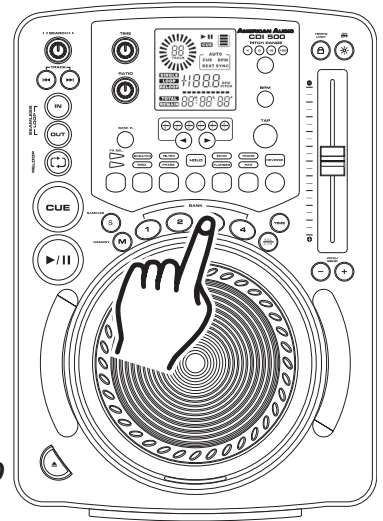

Figure 30

15. BANK PROGRAM BUTTON (23):

Once you store samples in the four (4) Bank Buttons, the CDI-500 can be programmed to play the stored samples in a desired order. You can program the four (4) banks up to 12 times. The programmed samples can be played in your desired order without interrupting music playback. The programmed samples can be played when the player is in Pause mode and even when the disc has been removed. If the unit is in sample mode and the drive is not in playback mode, pressing any of the *BANK BUTTONS* that stores a sample, will immediately begin to play that sample.

To program samples:

1) Once you have one or more samples stored. Press the *BANK PROGRAM BUTTON (23)*. The *PITCH/BPM METER (41)* will now display +1.

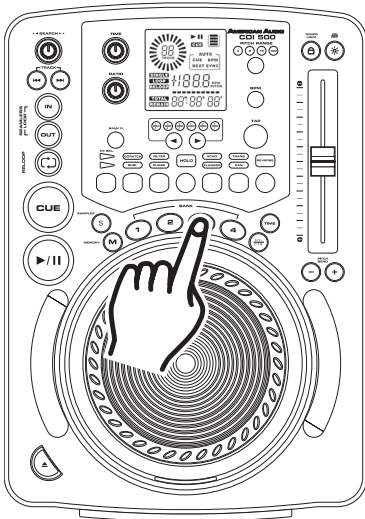

Figure 32

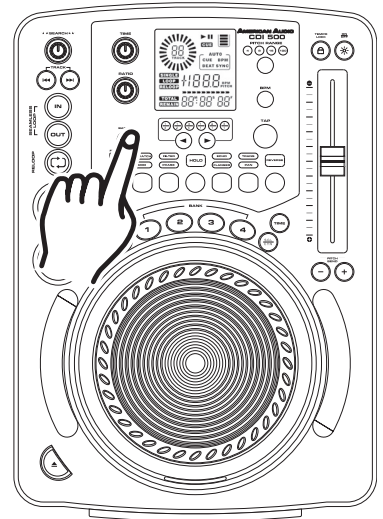

Figure 31

2) Program your Banks (Samples) in your desired order.

EXAMPLE: Bank 3; Bank 1; Bank 2; Bank 3; Bank 3; Bank 4; Bank 1. To end programming, press the *BANK PROGRAM BUTTON (23)*.

3) To play your programmed samples, press the *SAMPLE BUTTON (18)* then press the *BANK PROGRAM BUTTON (23)*.

BASIC OPERATIONS (CONT.)

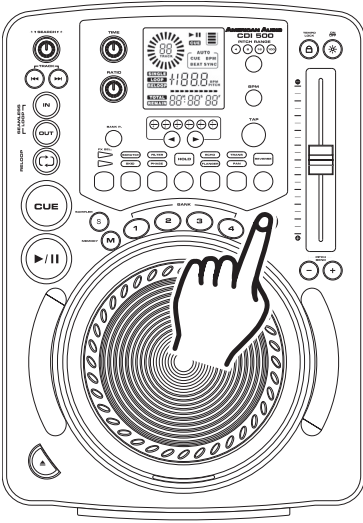

16. CHANGING THE TIME DISPLAY (44, 45, & 46)/TIME BAR (43):

DURING NORMAL PLAYBACK, pressing the *TIME BUTTON* (9), will change the time display information (44, 45, 46, & 43) in the *LCD* (30). The following is a break down of the time settings and their definitions:

- 1) **ELAPSED** - This describes the time in the LCD (44, 45, & 46) as the current TRACKS Elapsed running time.
- 2) **REMAIN** (47) - This describes the time in the LCD (44, 45, & 46) as the current TRACKS remaining running time.
- 3) **TOTAL REMAIN** (48) - This describes the time in the LCD (44, 45, & 46) as the disc total remaining running time.

Figure 33

TIME BAR INDICATOR (43) - Details the time defined in the *TIME METER* (44, 45, & 46) as a visual bar icon. As with the *TIME METER* (44, 45, & 46) this bar is also dependent on the selected time function [*TOTAL REMAIN* (48), *REMAIN* (47) OR *ELAPSED*]. This bar will begin to flash when a track is ending regardless of which time function you are in. Use the flashing bar as a visual reminder that a track is ending.

SYSTEM MEMORY

17. SYSTEM MEMORY:

The CDI-500 comes with an incredible memory system. The CDI-500™ can memorize virtually every customized setting for a particular CD. The unit can memorize all customized effect parameters, cue points, and samples used on a particular disc. To store all your setting for a CD, press and hold down the *MEMORY BUTTON* (16) for at least three seconds. When the memory has been stored properly the yellow *MEMORY LED* (16) will flash then turn off. The memory is full the outline of the *MEMORY BUCKET* (39) in the *LCD* (30) will disappear.

18. RECALL FLASH MEMORY:

The CDI-500 can store all your programmed cue points and effect parameters in to memory. These setting may be recalled at any time, even when a disc has been removed and loaded at a later time. To recall the memory on a specific disc; 1) Be sure a CD is not loaded in to the drive. 2) Press the *MEMORY BUTTON* (16) down until the yellow memory LED begins to flash. 3) Insert the CD. "RECALL" will appear in the *LCD* (30) while the memory is being installed and the yellow *MEMORY BUTTON* (16) LED will turn off.

19. CLEAR ALL MEMORY:

You may clear the system memory at any time. This will erase all your programmed memory and restore the unit to it's default settings. To clear the memory: While main power is turned off, turn the *SEARCH KNOB* (28) in a counter-clockwise direction. While the search knob is turned in a counter-clockwise direction turn main power on. The *LCD* (30) will flash three times and default memory will be restored.

20. FIRMWARE VERSION DISPLAY:

You may display the units firmware version. Firmware is the units internal programming code. To view the firmware version: While main power is turned off, turn the *SEARCH KNOB* (28) in a clockwise direction. While the search knob is turned in a clockwise direction turn main power on. The firmware version will appear in the *LCD* (30) as long as the search wheel is held in the clockwise position.

TOUCH SENSITIVE JOG WHEEL/BOP EFFECT

JOG WHEEL TOUCH SENSITIVITY: This function works with the SCRATCH effects. This function allows the play and cue commands to be controlled by tapping on the touch sensitive jog wheel.

BOP EFFECT: The Bop Effect is a stutter effect that is similar to turntable scratching. You can use this effect to create tricks in your mixing.

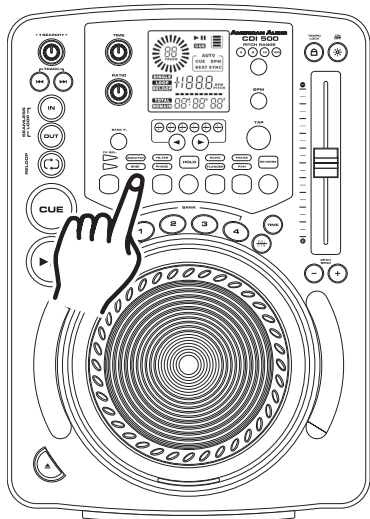

ACTIVATING TOUCH SENSITIVITY: Before you can use the *JOG WHEEL (13)* to control the play and cue commands you must first activate the jog wheel touch sensitivity. To activate the touch sensitivity mode, be sure the *FX SELECT LED (21)* is glowing green. Once the *FX SELECT LED (21)* is glowing green, press and hold the *SCRATCH BUTTON (19)* until it begins to flash red repeatedly. This will activate touch sensitivity mode.

Figure 34

IN PLAYBACK MODE: While in play mode and when the touch sensitivity function is active, the *JOG WHEEL (13)* can be used to return the unit to last cue point. Simply touch the *JOG WHEEL (13)* and unit will immediately return to the last set cue point and playback without music interruption. Essentially the *JOG WHEEL (13)* becomes a *BOP EFFECT*.

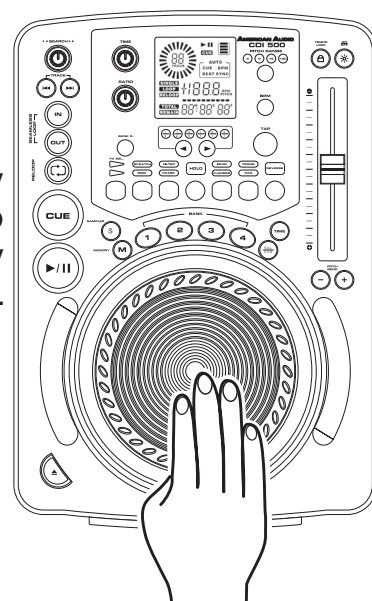
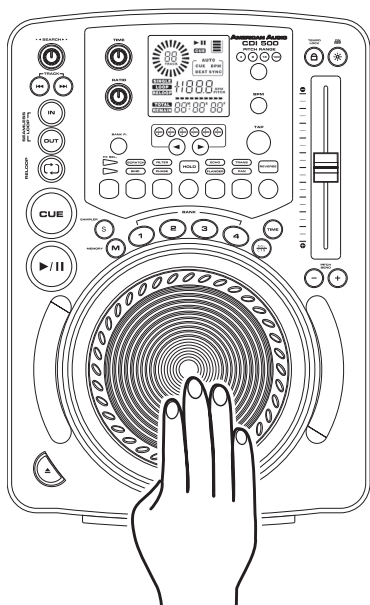

Figure 35



IN CUE MODE: While in cue mode and when the touch sensitivity function is active, tapping on the *JOG WHEEL (13)* can be used to start playback. The unit will continue to playback until the *JOG WHEEL (13)* is released. Once the *JOG WHEEL (13)* is released the unit will return to the last cue point.

Figure 36

PITCH ADJUSTMENTS

PITCH ADJUSTMENTS:

The different pitch adjustments allow a track's or a loop's playback speed to be manipulated. This speed manipulation is commonly used to beat match between two or more music sources such as a turntable or another CD player. The playback speed may be increased or decreased by a factor of +/-100. The next section details the different pitch manipulation schemes.

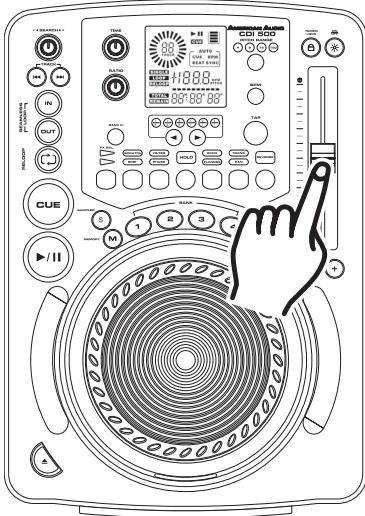

Figure 37

1. PITCH SLIDER (7):

This function will increase or decrease the tracks playback speed or "PITCH." The maximum pitch percentage manipulation in this function is +/-100%. The *PITCH SLIDER* is used to decrease or increase the playback pitch. If the slider is moved up (towards the top of the unit) the pitch will decrease, if the slider is moved down (towards the bottom of the unit) the pitch will increase. The *PITCH SLIDER* adjustment can be changed to range from +/-4%, +/-8%, +/-16%, or +/-100% (See changing "PITCH SLIDER PERCENTAGE RANGE" on the next page). The pitch adjustments will effect normal playback and loops only when the *PITCH ON/OFF BUTTON* (26) is turned on. The pitch adjustments will not affect your samples.

Activating the Pitch Slider (3): To activate the *PITCH SLIDER* (7) you must turn on the pitch adjustment function. Press the *ON/OFF BUTTON* (3) located at the top right of the unit. The *ON/OFF BUTTON* (3) LED will glow when the function is activated. If the pitch function is not activated the *PITCH SLIDER* (7) will not function.

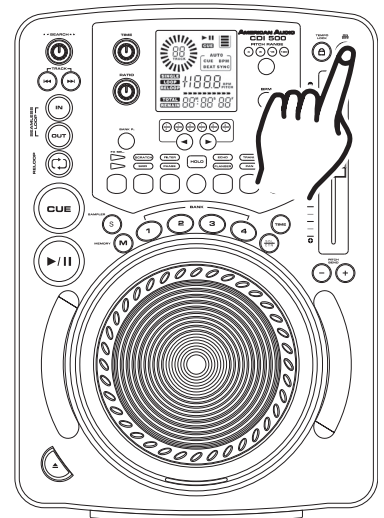

Figure 38

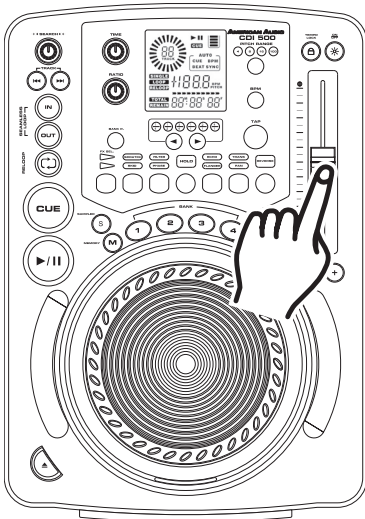

Figure 39

Using the Pitch Slider (7): Be sure the pitch function has been activated as described above. To use the *PITCH SLIDER* (7) slide the slider up and down. Down will increase the pitch and up will decrease the pitch.

PITCH ADJUSTMENTS

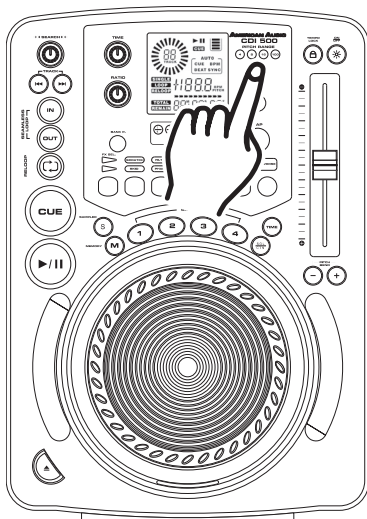

Figure 40

Adjusting the PITCH SLIDER'S RANGE (7): You may change the PITCH SLIDER'S (7) operating range at any time. To change the operating range be sure the pitch function is turned on, see figure 38. The pitch percentage range can be changed between +/-4%, +/-8%, +/-16%, and +/-100%. 4% will allow the least amount of pitch manipulation and 100% will allow the most amount of pitch manipulation. To adjust the different ranges, press the PITCH ON/OFF BUTTON (3) and tap on the PITCH RANGE BUTTON (1) until your desired value is reached, see figure 40.

2. PITCH BENDING:

Unlike the PITCH SLIDER (7) adjustment this function will momentarily increase or decrease a tracks speed during playback. There are two ways to operate this function, with the (-) & (+) PITCH BUTTONS (11) or with the JOG WHEEL (13). The maximum pitch bend percentage allowed is +/- 100%. The pitch bend function will work in conjunction with the PITCH SLIDER'S (7) pitch setting. For example, if the PITCH SLIDER (7) is set to a 2% pitch gain the pitch bending process will begin at 2% and will continue to the maximum of +/- 100%.

NOTE: A -100% pitch manipulation will stop playback entirely.

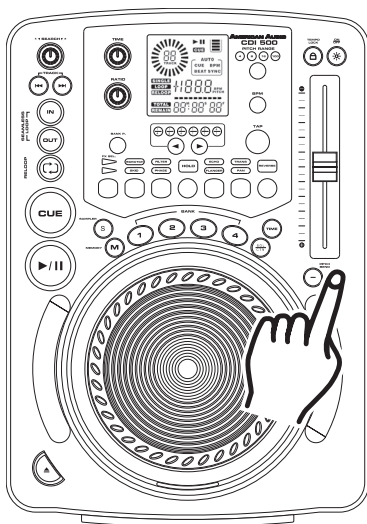

Figure 42

Holding down or tapping on the (+) PITCH BEND BUTTON (11) will provide a speed bump in the playback pitch.

Holding down or tapping on the (-) PITCH BEND BUTTON (11) will provide a slow down in the playback pitch.

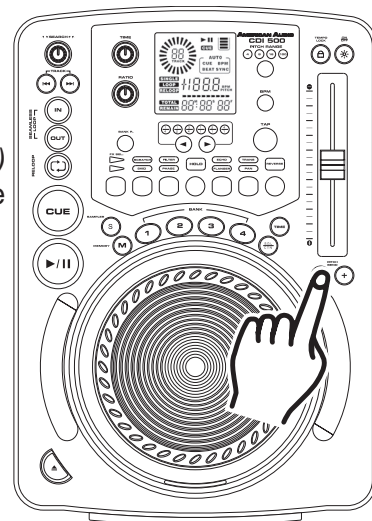

Figure 41

PITCH BEND BUTTONS (11):

The (+) PITCH BEND BUTTON (11) will increase track playback speed and the (-) PITCH BEND BUTTON (11) will decrease track playback speed. The extent to which the speed changes is proportionate to the amount of time the button is pressed. For example, if the (+) PITCH BEND BUTTON (11) is held down continuously as in figure 42, the disc speed will increase and will continue to increase until it reaches a maximum of 100% speed gain. When you release the (+) PITCH BEND BUTTON (11) the disc speed will automatically return to it's previous set speed.

PITCH ADJUSTMENTS

3. JOG WHEEL (13):

The *JOG WHEEL* will temporarily bend the pitch if a track is in playback mode. Rotating the wheel in a clockwise direction will increase your track pitch and rotating the wheel in a counter-clockwise direction will decrease your track pitch. The speed you rotate the *JOG WHEEL* will determine pitch bend percentage (%). For example, if the *JOG WHEEL* is continuously turned in a counter-clockwise direction the playback speed will steadily decrease and will continue to decrease until playback reaches a maximum of -100% and playback stops entirely. When you stop turning the *JOG WHEEL* the disc speed will automatically return to its previous set speed.

NOTE: To use the *JOG WHEEL* in a pitch bend function when the *SCRATCH EFFECT (19)* is activated you must use the outer ring of the jog wheel where the clear rubber insulator is attached.

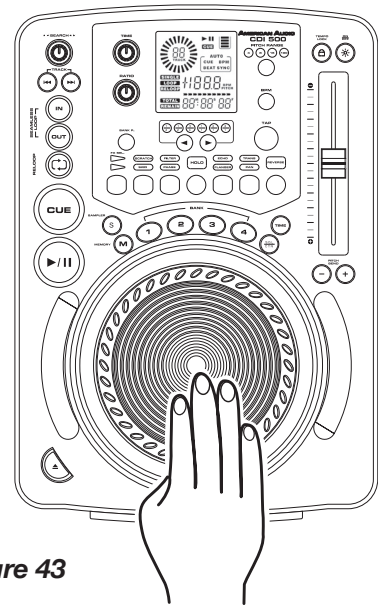

Figure 43

BUILT-IN EFFECTS

The CDI-500™ comes with nine built in effects. These effects can be used one at a time or you may choose to overlap the effects and use up to four at a time. The Built-in effects include Scratch, Skid, Filter, Phase, Flanger, Echo, Robot, Pan, and Trans. It is important to understand that only one effect per an effect bank can be turned on at one time, but all four effects banks can be used at a time. **FOR EXAMPLE:** the Flanger, Echo, and Robot are all stored in the same effects bank but only one can be used at a time. You can choose to use the effects with their default parameters or you may choose to customize each effect by changing the parameters. The parameter values for all the effects will range. Some effects will have more adjustable parameters than others. The parameters have two adjustable values, PR (Parameter Ratio) and PT (Parameter Time). **All parameters will be reset to there default values when power is shut off!**

FX SELECT: The **FX SELECT BUTTON (21)** allows you to toggle back and forth between the two effects banks. When the **FX SELECT BUTTON (21)** LED is glowing green you have access to the top bank of effects which include; scratch, filter, echo, robot, and trans. When the **FX SELECT BUTTON (21)** LED is glowing blue you have access to the bottom bank of effects which include; skid, phase, flanger, and pan. To toggle to the next bank of effects press the **FX SELECT BUTTON (21)** more than once.

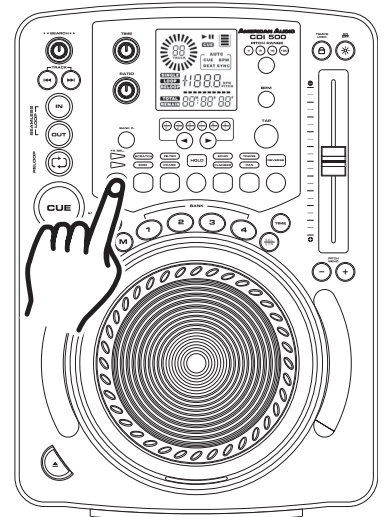
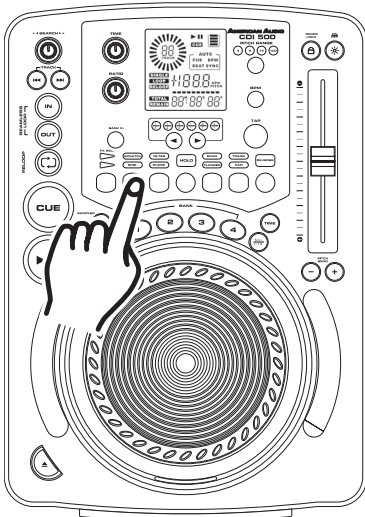

Figure 44



SCRATCH/SKID EFFECT: The Scratch Effect simulates real time turntable scratching. The Skid effect simulates the sudden platter stop of a turntable, like pressing the stop button on a turntable. When the Scratch Effect is activated the SCRATCH LED will flash green. Once the Scratch Effect has been activated the **JOG WHEEL (13)** may be used in the same fashion a turntable platter is used. Use the **JOG WHEEL (13)** to simulate the scratch motion on a turntable platter and to manipulate playback. When the skid effect is activated the SKID LED will flash blue. Both the Skid and Scratch time parameters can be adjusted from 0010 to 9990. 9990 will give you the longest Skid times. The Skid value ranges from a 10ms to ten seconds.

Figure 45

BUILT-IN EFFECTS

FILTER/PHASE EFFECT: The Filter and Phase effects tweak the original sound to add different tonal definition. When the Filter Effect is activated the FILTER LED will flash green, when the Phase Effect is selected the PHASE LED will flash blue.

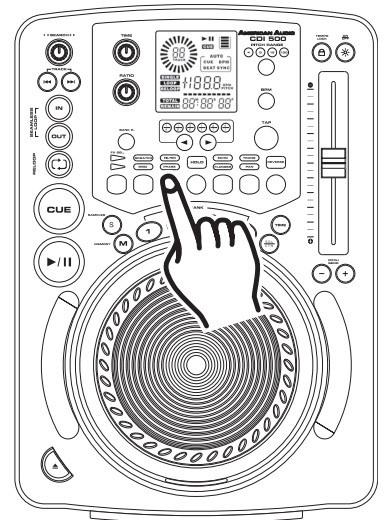

Figure 46

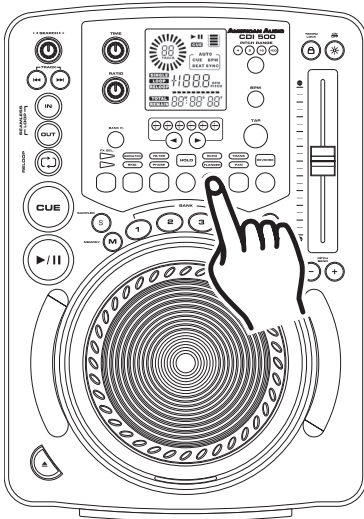

Figure 47

FLANGER/ECHO/ROBOT EFFECT: The Flanger effect distorts the output signal and creates an effect similar to the frequency phasing in and out of each other. The Echo effect adds an echo to your output signal. The Robot effect distorts the output to simulate a sci-fi robot voice. When the Flanger effect is selected the FLANGER LED will flash blue, when the Echo or Robot effect is selected the ECHO LED (19) will flash green.

ROBOT EFFECT: The Robot effect distorts the output to simulate a sci-fi robot voice. The Robot effect is activated in the echo parameters (see "Parameters" in the next section). To activate the Robot effect select the echo effect. After the Echo effect is activated turn the *HOLD* (19) function on. Use the *PARAMETER TIME KNOB* (29) and set the (PT) value to 0010. After "PT" value has been set, use the *PARAMETER RATIO KNOB* (25) to create the effect by turning it back and forth.

FLANGER EFFECT: The Flanger effect distorts the output signal and creates an effect similar to frequencies phasing in and out of each other. The FLANGER Effect has two adjustable parameters, Parameter Time (PT) and Parameter Ratio (PR). The PT will adjust the Flanger Mode and The PR will adjust the Flanger Frequency Range (see "Parameters" in the next section).

ECHO EFFECT: The Echo effect adds an echo to your output signal. The Echo effect has two adjustable parameters, Parameter Time (PT) and Parameter Ratio (PR). The PR will adjust the length of the Echo (drop off time), and the PT will adjust the echo gap length (see "Parameters" in the next section). off time), and the PT will adjust the Echo gap length.

BUILT-IN EFFECTS

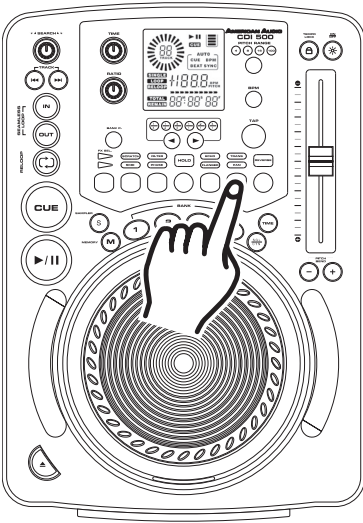

Figure 48

PARAMETERS:

All the effects have adjustable parameters. The parameters change the way the effects will react. To enter the parameter menus for any of the effects, press or turn either of the two *PARAMETER KNOBS (25 OR 29)*. When the parameter mode is selected the time display in the *LCD (30)* will change to indicate the parameter your are adjusting. All effects except the pan effect have two adjustable parameters. *PARAMETER TIME (29)* and *PARAMETER RATIO (25)*. Use these knobs to customize the effects to your liking.

TRANS/PAN EFFECT: The Trans effect simulates a real-time mixer transformer effect. When the "Transformer" effect is activated the TRANS LED will flash green, when the "Pan" effect is selected the PAN LED will flash blue. The Pan effect allows you to pan the output from the left channel to the right channel.

TRANS EFFECT: The Trans effect has two adjustable parameters, Parameter Time and Parameter Ratio. The PT will adjust the Trans Speed and The PR will adjust the Trans Audio Length. The lower the PT value the faster the Trans effect (PT 0500 = 1/2 second, PT 1000 = 1 second).

PAN EFFECT: The Pan effect uses the PT value to pan left to Right. PT 0500 is the default setting which is center pan. The Pan Value ranges from 10ms to ten seconds.

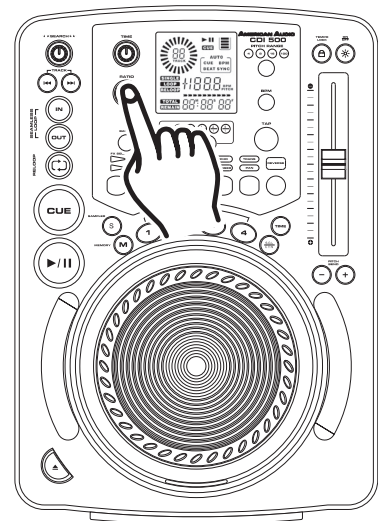

Figure 49

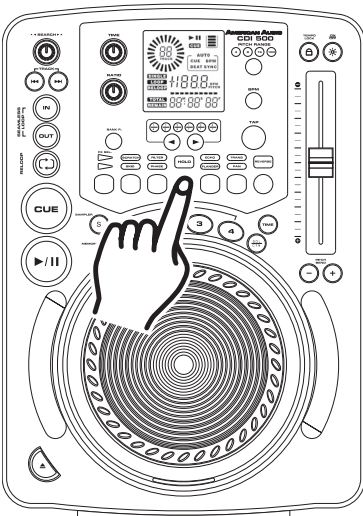

Figure 50

HOLD BUTTON: Use the *HOLD BUTTON (19)* to lock your customized parameters. If the hold button is not activated any changes to your parameters will be momentary. To activate the hold function press the *HOLD BUTTON (19)* as in figure 50. When the hold function becomes activated, the hold button will begin to glow red.

FLIP-FLOP™

FLIP-FLOP™

This feature is a kind of “auto pilot”. When you are using two CDI-500™ players and an American Audio® “Q” Deck™ mixer, you can have one player begin playback when the other ends. You can “Flip-Flop™” single tracks, the entire disc, or a combination of the two.

To FLIP-FLOP™ single tracks:

- 1) Connect your system as described in the connection section on page 8.
- 2) Set your American Audio® “Q” Deck™ mixer’s crossfader to the center position.
- 3) Set your two CDI-500s™ to playback in single mode, *SINGLE (51)* should be indicated in the *LCD (30)*.
- 4) Load your two CDI-500s™ with audio discs.
- 5) After they have both cued, press the *PLAY/PAUSE BUTTON (17)* on one player to begin playback.
- 6) After the first player’s single track has ended the second player’s track will immediately begin playback.
- 7) FLIP-FLOP™ will continue until you stop it or power is interrupted.

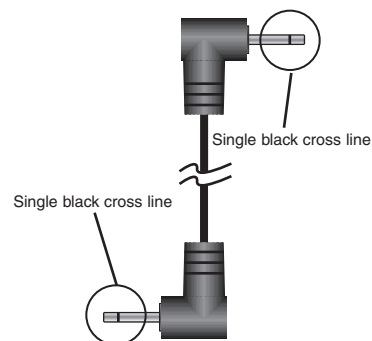

Mono Mini Plug

Figure 53

To Flip-Flop entire CDs:

Be sure your players are both in continuous play mode, make sure *SINGLE MODE (51)* does not appear in the *LCDS (30)* of both players. Follow all directions for single track FLIP-FLOP™ above. When one player’s disc ends the other player will immediately begin playback.

Note: You may combine FLIP-FLOP™ single and continuous playback modes by selecting either single or continuous playback on your units.

Connecting your CDI-500™ to an American Audio® or an American DJ® “Q” Deck™ mixer for “Flip-Flop™” control: Be sure to connect 1/8” mono mini plugs from the control connection on the rear of your CDI-500™ to the 1/8” control jack on the rear of American Audio® “Q” series mixer. That’s it, you’ll be set for FLIP-FLOP™

Sample "Q" Start Set-Up. This set-up will allow "Q" start function and Flip-Flop™ function to operate. Be sure to use 1/8" mono mini plugs only.

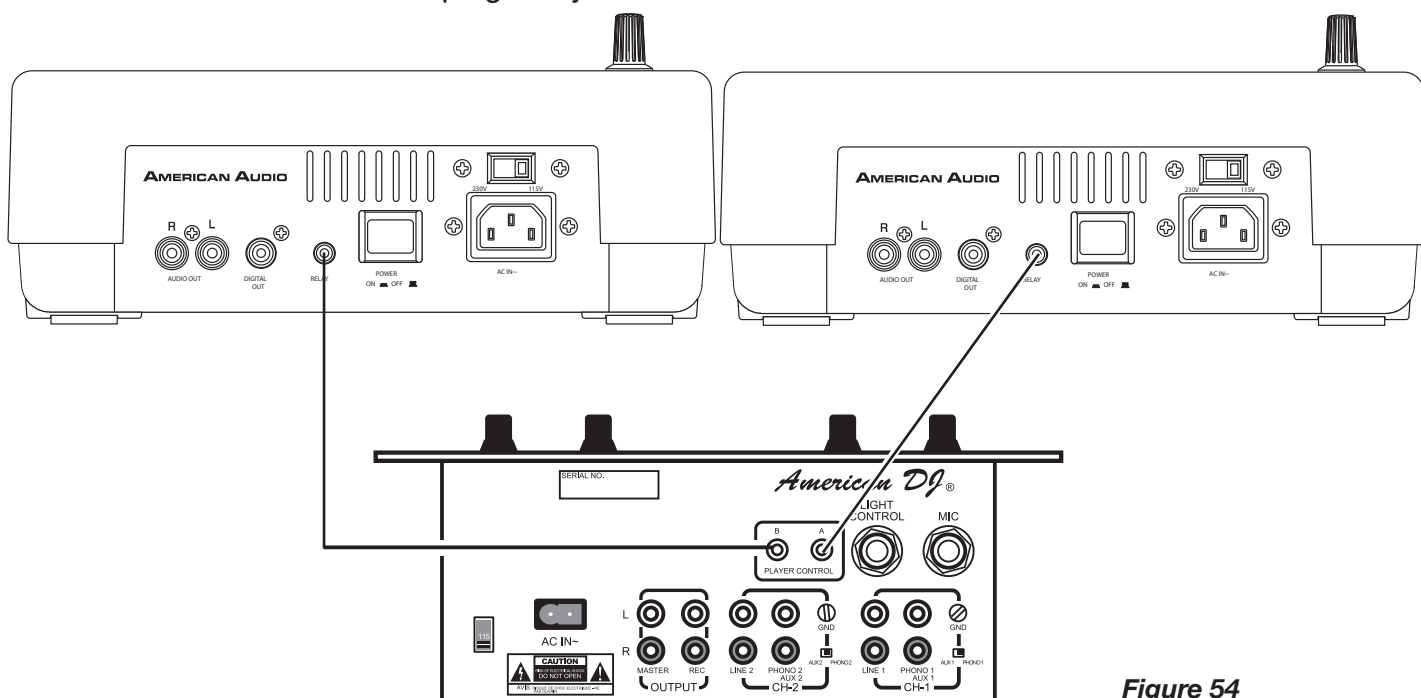

Figure 54

Compatible Q-Deck Mixer

WARRANTY

WARRANTY INFORMATION: The CDI-500™ carries a ONE year (365 days) limited warranty. This warranty covers parts and labor. Please fill out the enclosed warranty card to validate your purchase and warranty. All returned service items whether under warranty or not, must be freight pre-paid and accompany a return authorization (R.A.) number. If the unit is under warranty, you must provide a copy of your proof of purchase invoice. Please contact American Audio® customer support at (800) 322-6337 for a R.A. number. All package not displaying a R.A. number on the outside of the package will be returned to the shipper.

1-YEAR LIMITED WARRANTY

A. American Audio® hereby warrants, to the original purchaser, American Audio® products to be free of manufacturing defects in material and workmanship for a period of 1 Year (365 days) from the date of purchase. This warranty shall be valid only if the product is purchased within the United States of America, including possessions and territories. It is the owner's responsibility to establish the date and place of purchase by acceptable evidence, at the time service is sought.

B. For warranty service, send the product only to the American Audio® factory. All shipping charges must be pre-paid. If the requested repairs or service (including parts replacement) are within the terms of this warranty, American Audio® will pay return shipping charges only to a designated point within the United States. If the entire instrument is sent, it must be shipped in its original package. No accessories should be shipped with the product. If any accessories are shipped with the product, American Audio® shall have no liability whatsoever for loss of or damage to any such accessories, nor for the safe return thereof.

C. This warranty is void if the serial number has been altered or removed; if the product is modified in any manner which American Audio® concludes, after inspection, affects the reliability of the product; if the product has been repaired or serviced by anyone other than the American Audio® factory unless prior written authorization was issued to purchaser by American Audio®; if the product is damaged because not properly maintained as set forth in the instruction manual.

D. This is not a service contract, and this warranty does not include maintenance, cleaning or periodic check-up. During the period specified above, American Audio® will replace defective parts at its expense, and will absorb all expenses for warranty service and repair labor by reason of defects in material or workmanship. The sole responsibility of American Audio® under this warranty shall be limited to the repair of the product, or replacement thereof, including parts, at the sole discretion of American Audio®. All products covered by this warranty were manufactured after January 1, 1990, and bear identifying marks to that effect.

E. American Audio® reserves the right to make changes in design and/or improvements upon its products without any obligation to include these changes in any products theretofore manufactured.

F. No warranty, whether expressed or implied, is given or made with respect to any accessory supplied with products described above. Except to the extent prohibited by applicable law, all implied warranties made by American Audio® in connection with this product, including warranties of merchantability or fitness, are limited in duration to the warranty period set forth above. And no warranties, whether expressed or implied, including warranties of merchantability or fitness, shall apply to this product after said period has expired. The consumer's and or Dealer's sole remedy shall be such repair or replacement as is expressly provided above; and under no circumstances shall American Audio® be liable for any loss or damage, direct or consequential, arising out of the use of, or inability to use, this product.

G. This warranty is the only written warranty applicable to American Audio® Products and supersedes all prior warranties and written descriptions of warranty terms and conditions heretofore published.

SPECIFICATIONS

GENERAL

Model: American Audio® CDI-500™ - Professional CD Player

Type:	Tray loading, digital compact disc audio player.		
Disc type:	Standard size compact discs only (5 in/12 cm and 3in/8cm)		
Pitch Range:	Within +/- 4%, +/- 8%, +/- 16%, +/- 100%		
Pitch Accuracy:	0.1%		
Dimensions:	348mm (W) x 246mm (D) x 106mm (H)		
Installation:	Place on flat surface or mount in flat case		
Weight:	7 Lbs. / 3.2 Kgs		
Power supply:	AC 115/230V, 50/60Hz		
Power consumption:	15W		
Environmental conditions:	Operational temperature:	5 to 35°C (41 to 95°F)	
	Operational humidity:	25 to 85% RH (no condensation)	
	Storage temperature:	-20 to 60°C (4 to 140°F)	
	Accessories:	Connecting RCA Cable (1 set for left and right channels) Control 1/8" miniplug type (3 feet)	

AUDIO SECTION

Quantization:	16 bit linear per channel
Sampling rate:	44.1 kHz at normal pitch
Over sampling rate:	8 times
D/A conversion	16 bit
Frequency response:	+/- 1 dB 20 Hz to 20,000 Hz
Output level:	1.0V +/- 1dB
Load impedance:	47k ohm or more

AUDIO CHARACTERISTICS (TEST DISC: TCD-782, LOAD=47Kohm)

ITEM	NOMINAL	LIMIT	CONDITION
Output level	1Vrms+/-0.5dB	1Vrms+/-1dB	1KHz,0dB
Channel balance	within 0.5dB	within 1dB	1KHz,0dB
Frequency response	20Hz-20KHz, +/-0.5dB	20Hz-20KHz,+/-1.0dB	0dB Output
De-emphasis response	+/-2.5dB	+/-3dB	16KHz,-20dB
Channel separation*	83dB	75dB	1KHz,0dB
T.H.D. + NOISE*1	0.01%	0.03%	1KHz,0dB
S/N ratio (IHF-A)*2	86dB	80dB	1KHz.0dB

NOTE: *1* With 20KHz low pass filter.

*2 With 20KHz low pass filter, "IHF-A" weighted

SEARCHING TIME (TEST DISC: TCD-792)

ITEM	NOMINAL	LIMITS	CONDITION
Short access time	2sec	4sec	Play next track
Long access time	4sec	6sec	Track 1 ->Track 20 Track 20 ->Track 1

PLAYABILITY

ITEM	NOMINAL	LIMIT	CONDITION
Interruption	1mm	0.7mm	TCD-725
Black dot	1mm	0.6mm	TCD-725
Finger prints	75um	65um	TCD-725
Eccentricity	140um	140um	TCD-712 W/O TRACK JUMP
Vertical deviation	1mm	0.5mm	TCD-731R

PICK-UP

System	Object lens drive system optical pick-up
Object lens drive system	2 dimensional parallel drive
Tracking detection	3 spot beam detection
Optical source	Semiconductor laser
Wave length	780nm

NOTES: Specifications and improvements in the design of this unit and this manual are subject to change without any prior written notice.



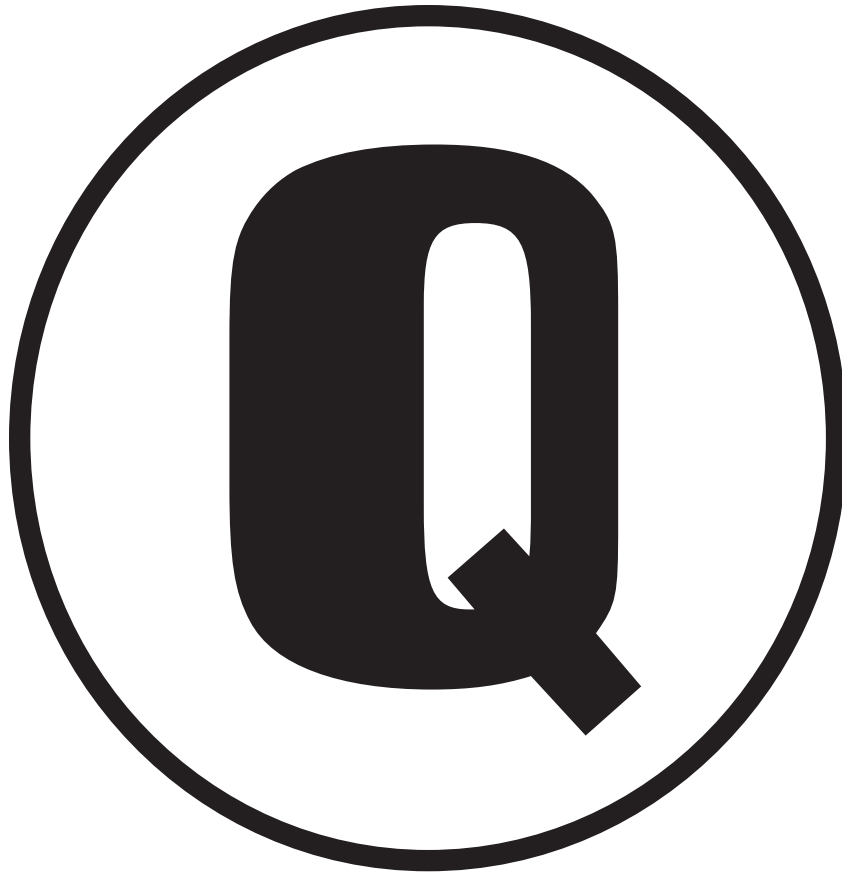

©American Audio® World Headquarters:
4295 Charter Street Los Angeles, CA 90058 USA
Tel: 323-582-3322 Fax: 323-582-3311
Web: www.AmericanAudio.us E-mail: info@americandj.com

Free Manuals Download Website

<http://myh66.com>

<http://usermanuals.us>

<http://www.somanuals.com>

<http://www.4manuals.cc>

<http://www.manual-lib.com>

<http://www.404manual.com>

<http://www.luxmanual.com>

<http://aubethermostatmanual.com>

Golf course search by state

<http://golfingnear.com>

Email search by domain

<http://emailbydomain.com>

Auto manuals search

<http://auto.somanuals.com>

TV manuals search

<http://tv.somanuals.com>