

JVC

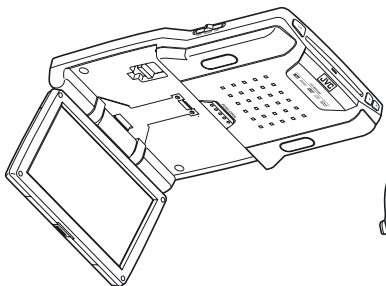

9-INCH WIDESCREEN MONITOR WITH DVD PLAYER

KV-MRD900



DVD
VIDEO

COMPACT
disc
(DIGITAL VIDEO)

dts
ES+DIGITAL OUT

DD **DOLBY**
DIGITAL

WMA MP3

- This system cannot receive television broadcasts. Use the separately sold TV tuner unit KV-C1001 for optional television broadcast reception.

For installation and connections, refer to the separate manual.

INSTRUCTIONS

LVT1341-001B
[E]

WARNINGS

- **DO NOT INSTALL THE MONITOR IN A LOCATION WHICH OBSTRUCTS DRIVING, VISIBILITY, SAFETY DEVICE FUNCTION SUCH AS AIR BAGS OR WHICH IS PROHIBITED BY APPLICABLE LAWS AND REGULATIONS.**
- There may be legal regulations defining the permissible installation locations for the monitor which differ by country or by state. Be sure to install the monitor in a correct location according to such laws.
- The driver must not operate the monitor while driving.
 - * Stop your vehicle in a safe location when operating the monitor.
- The driver must not watch the television or playback pictures while driving. If the driver does it while driving, it may lead to carelessness and cause an accident.
- Keep the monitor at an appropriate sound level while driving. Driving with the sound at a level that prevents you from hearing sounds outside of and around the vehicle may cause an accident.
- Be sure not to let the monitor fall or be strongly impacted since this may cause a malfunction or fire.
- Do not use the monitor with the engine off. Doing so with the engine off will consume battery power and may prevent the engine from starting.
- When not in use, close the liquid crystal panel and store it into the compartment.
- Do not touch the surface of the liquid crystal panel directly.
- Do not hang any object on the monitor or hang down, as this may damage the monitor.



CAUTION:

This monitor should be used on DC 12 V only. To prevent electric shocks and fire hazards, DO NOT use any other power source.

Installation requires some special knowledge.

Do not install the monitor yourself. Consult a dealer having special knowledge of this kind for safe and reliable installation.

CAUTIONS on the supplied headphones —KS-HP2:

- DO NOT leave the headphones in a place exposed to direct sunlight for a long time, such as a dashboard, as they may be damaged.
- Keep the headphones away from a cellular phone to avoid interference.
- DO NOT turn off the power with the volume set at high level, as the sudden blast of sound can damage your hearing and/or headphones next time you use the headphones.
- If you experience a ringing in your ears, reduce volume or stop using the headphones.

Thank you for purchasing a JVC product.

Please read all instructions carefully before operation, to ensure your complete understanding and to obtain the best possible performance from the unit.

IMPORTANT FOR LASER PRODUCTS

1. CLASS 1 LASER PRODUCT
2. **CAUTION:** Do not open the top cover. There are no user serviceable parts inside the unit; leave all servicing to qualified service personnel.
3. **CAUTION:** Visible and invisible laser radiation when open and interlock failed or defeated. Avoid direct exposure to beam.
4. REPRODUCTION OF LABEL: CAUTION LABEL, PLACED OUTSIDE THE UNIT.

CAUTION : Visible and invisible laser radiation when open and interlock failed or defeated. AVOID DIRECT EXPOSURE TO BEAM.	ADVARSEL : Synlig og usynlig laserstråling når maskinen er åben eller interlocken fejler. Undgå direkte eksponering til stråling.	VARNING : Synlig och osynlig laserstråling när den öppnas och spärren är urkopplad. Beträkta ej strålen.	VARO : Avattaessa ja suojalukitus ohitettuna tai viallisena olet alitina näkyville ja näkymättömälle lasersträilylle. Vältä silmien kohdistumista suoraan läheesi. (f)
(e)	(e)	(c)	(s)

This product incorporates copyright protection technology that is protected by U.S. patents and other intellectual property rights. Use of this copyright protection technology must be authorized by Macrovision, and is intended for home and other limited viewing uses only unless otherwise authorized by Macrovision. Reverse engineering or disassembly is prohibited.

Caution on volume setting:
Discs produce very little noise compared with other sources. Lower the volume before playing a disc to avoid damaging the speakers by the sudden increase of the output level.

How to reset your monitor

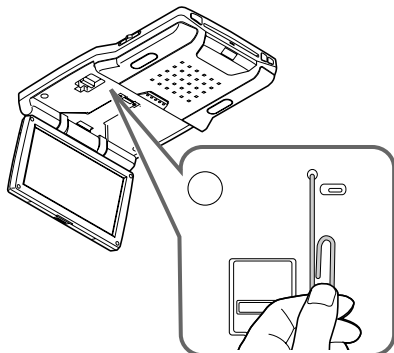

This will reset the microcomputer. Your preset adjustments will also be erased.

How to forcibly eject a disc

If a disc cannot be recognized by the monitor or cannot be ejected...

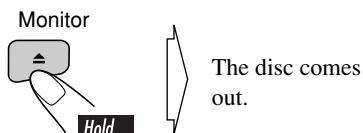

(for about 5 seconds while power is on)

- If this does not work, reset your monitor.
- Be careful not to drop the disc when it ejects.

How to read this manual

The following methods are used to make the explanations simple and easy-to-understand:

- Some related tips and notes are explained in “More about this monitor” (see pages 33 – 35).
- Button operations are mainly explained with the illustrations as follows:

	Press briefly.
	Press repeatedly.
	Press either one.
	Press and hold until your desired response begins.
	Press and hold both buttons at the same time.

Contents

How to reset your monitor.....	4	DVD/VCD/JPEG special functions ...	21
How to forcibly eject a disc.....	4	Selecting audio languages	21
How to read this manual.....	4	Selecting subtitles.....	21
Precautions.....	6	Selecting the multi-angle views.....	21
Widescreen monitor	7	Disc menu operations	22
Parts identification.....	7	Zoom in.....	22
Remote controller — RM-RK230	8	On-Screen disc operations.....	23
Main elements and features	8	Basic on-screen bar operations	24
Headphones — KS-HP2.....	10	Basic control screen operations	26
Main elements and features	10	List screen operations	27
Basic operations	11	DVD setup menu	28
Adjustments	13	Basic setting procedure.....	28
Using the monitor menu	13	Maintenance	31
Changing the aspect ratio	15	Language codes.....	32
Playable discs	17	More about this monitor	33
Disc operations	18	Troubleshooting	37
Playing a disc	18	Specifications.....	39
Starting playback	18		
Basic operations.....	19		

For safety....

- Do not raise the volume level too much, as this will block outside sounds, making driving dangerous.
- Stop the car before performing any complicated operations.

Temperature inside the car....

If you have parked the car for a long time in hot or cold weather, wait until the temperature in the car becomes normal before operating the unit.

Precautions

Cautions for handling the liquid crystal panel

Do not expose the liquid crystal panel to direct sunlight.

- Storage temperature range: -20°C to $+80^{\circ}\text{C}$

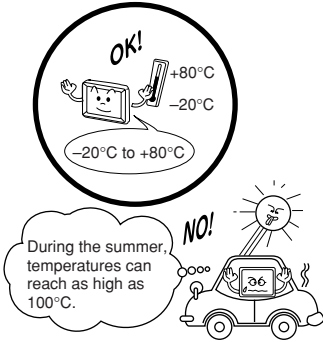

When the liquid crystal panel reaches high temperatures or low temperatures, chemical changes occur within the liquid crystal panel which may cause it to malfunction.

The red spots, blue spots and green spots on the panel surface are a normal characteristic of liquid crystal panels, and not a problem.

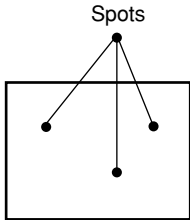

Note:

The liquid crystal panel is built with very high precision technology and has at least 99.99% effective image pixels. Be aware that on 0.01% of the panel there may be missing or constantly lit pixels.

Do not drop the liquid crystal panel or strike it sharply.

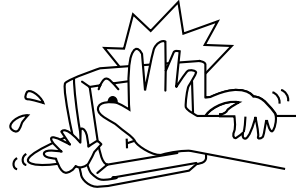

When the temperature is very cold or very hot, the image may not appear clearly or may move slowly.

The image may not be synchronized with the sound or the image quality may decline in such environments. Note that this is not a malfunction or problem.

- Usage temperature range: 0°C to $+40^{\circ}\text{C}$

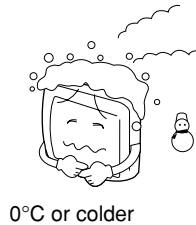

0°C or colder

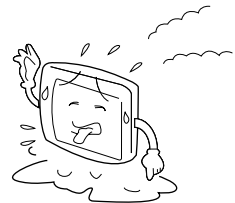

40°C or hotter

Widescreen monitor

Parts identification

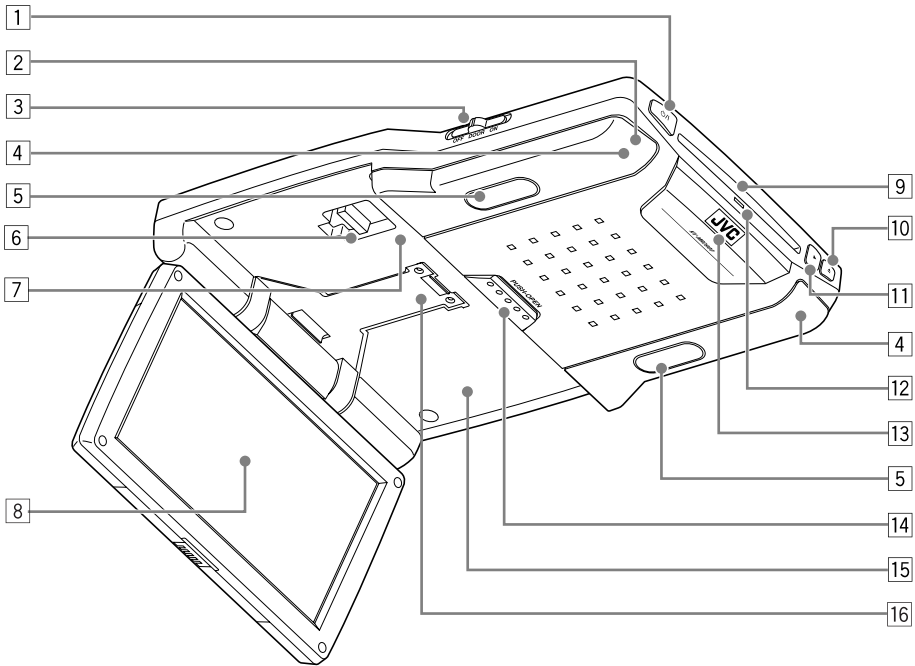

- | | |
|---|--|
| 1 ⏻/⏻ (standby/on) buttons | 8 Screen (Liquid crystal panel) |
| • Turns on the power if pressed. | 9 Disc loading slot |
| • Turns off the power if pressed and held. | 10 ▲ (eject) button |
| 2 Remote sensor | 11 ► (play) button |
| 3 Dome light switch | 12 Disc loading lamp |
| • See “To activate the door sensor” on page 12. | 13 White LED |
| 4 IR transmitters | 14 PUSH-OPEN button |
| 5 Dome lights | 15 Screen compartment |
| 6 Arm lock lever | 16 Screen arm |
| 7 Reset button | |

When you watch the screen at an angle, the picture might not be clear. This is not a malfunction. The finest picture can be seen when you watch the screen straight-on.

Remote controller — RM-RK230

Installing the lithium coin battery (CR2025)

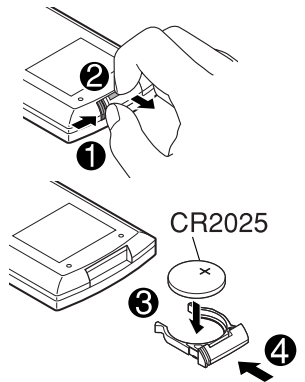

Before using the remote controller:

- Aim the remote controller directly at the remote sensor on the monitor. Make sure there is no obstacle in between.

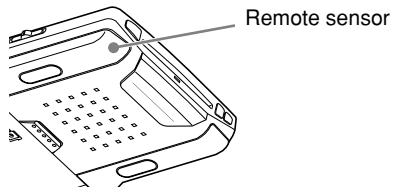

- Do not expose the remote sensor to strong light (direct sunlight or artificial lighting).

Warning:

- Do not install any battery other than CR2025 or its equivalent; otherwise, it may explode.
- Store the battery in a place where children cannot reach to avoid risk of accident.
- To prevent the battery from over-heating, cracking, or starting a fire:
 - Do not recharge, short, disassemble, or heat the battery or dispose of it in a fire.
 - Do not leave the battery with other metallic materials.
 - Do not poke the battery with tweezers or similar tools.
 - Wrap the battery with tape and insulate when throwing away or saving it.

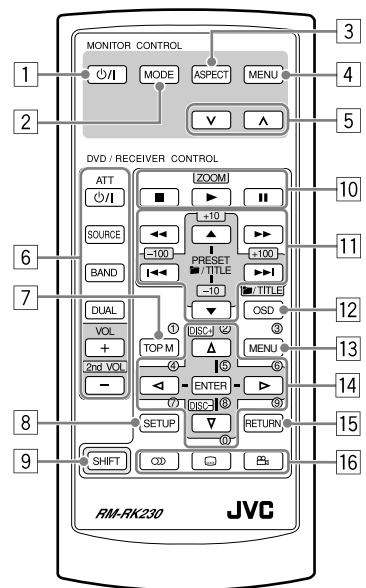

Main elements and features



MONITOR CONTROL

- 1 \odot/I (standby/on) button
 - Turns on the power if pressed.
 - Turns off the power if pressed and held.
- 2 MODE button
 - Selects the playback source.
- 3 ASPECT button
 - Changes the aspect ratio of the screen.
- 4 MENU button
 - Calls up the menu, then selects the adjustable menu items.
- 5 ∇/\wedge buttons
 - Adjust the level of the selected item or select an appropriate setting for selected item.

DVD/RECEIVER CONTROL

- 6 Receiver control buttons*1
 - ϕ /I ATT (standby/on attenuator) button
 - SOURCE button
 - BAND button
 - DUAL button
 - VOL + / - (2nd VOL + / -) buttons
- 7 TOP M (menu) button*2
 - Displays the DVD and VCD*3 disc menu.
- 8 SETUP button*2
- 9 SHIFT button
- 10 Disc basic operation buttons
 - (stop), ► (play), || (pause)
 - ► (play) button functions as ZOOM button when pressed with SHIFT button.
- 11 Advanced disc operation buttons
 - ■/TITLE ▲ / ▼*4
 - Select the titles (for DVD) or folders (for MP3/WMA/JPEG)*5.
 - |◀◀ / ▶▶| (reverse skip/forward skip)*6
 - ◀◀ / ▶▶ (reverse search/forward search)*7
- 12 OSD button
 - Displays the on-screen bar.
 - Also functions as the ■/TITLE button when pressed with SHIFT button.
 - You can directly select folders (for MP3/WMA/JPEG) or titles (for DVD) using the number buttons (see right column).
- 13 MENU button*2
 - Displays the DVD and VCD*3 disc menu.
- 14 Menu operation buttons*2
 - Cursor (Δ , ∇ , \triangleleft , \triangleright) and ENTER
- 15 RETURN button*2
- 16 DVD/VCD special function buttons
 - DVD/VCD:  (audio)
 - DVD:  (subtitle),  (angle)

*1 Controllable only if your car receiver which is connected to this monitor is one of the JVC receivers.

*2 These buttons function as the number buttons when pressed with SHIFT button.

*3 Only when PBC is not in use.

How to select a number

- To select a number from 0 - 9:

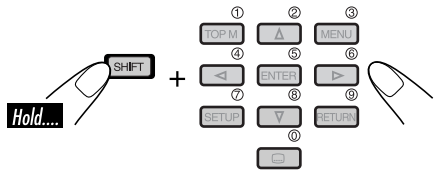

- To select a number greater than 9:

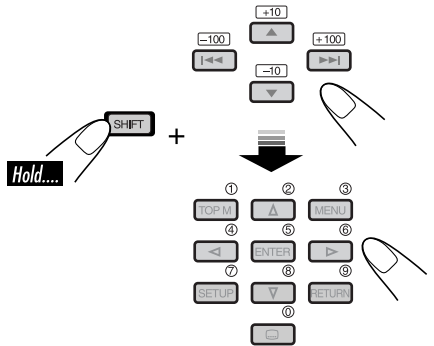

- +100/-100 buttons used only for searching MP3/WMA/JPEG tracks number greater than 99.

*4 These buttons do not function as PRESET ▲ / ▼.

*5 These buttons function as the +10/-10 buttons when pressed with SHIFT button.

*6 These buttons function as the +100/-100 buttons when pressed with SHIFT button.

*7 Not used for MP3/WMA/JPEG operations.

Headphones — KS-HP2

You can listen to the playback sounds with cordless headphones—KS-HP2.

■ Installing the batteries

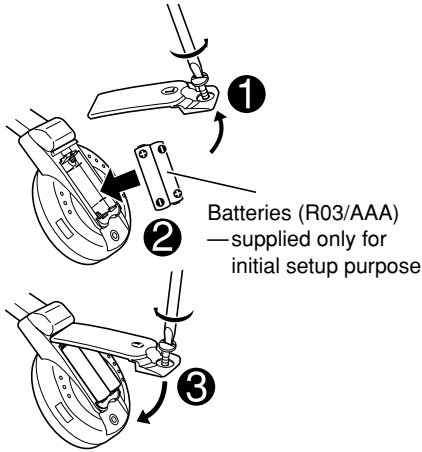

CAUTIONS:

- The supplied batteries are not rechargeable. DO NOT recharge them; otherwise, battery leakage or explosion may result.
- Insert the batteries with the correct polarity “+” and “-” to prevent the battery leakage or explosion.

Before using the cordless headphones:

The headphones give best results when used within about 2 m from the transmitter. These headphones need to receive infrared (IR) signals sent from IR transmitters on the monitor. Therefore, if you use the headphones where the signals cannot be received in a straight line of sight, noises may be generated.

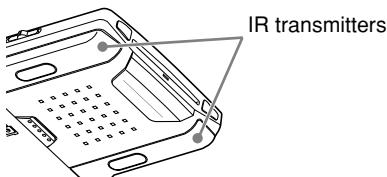

Main elements and features

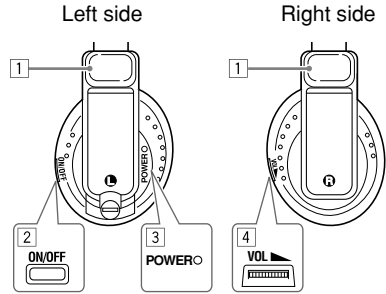

- 1 IR sensors
 - DO NOT cover the IR sensors, as reception will become poor.
- 2 ON/OFF button
 - The power automatically shuts off in the following cases:
 - The headphones are used for about 4 hours.
 - No signal is received for about 4 minutes.
 - You can turn on the power again by pressing the button.
- 3 POWER lamp
- 4 Volume control

Playback sounds are transmitted through IR transmitters to the cordless headphones. When using the headphones, set the monitor menu item “IR” to “ON.” (See page 14.)

WARNING:

DO NOT use the headphones while driving. Shutting out all outside sounds while driving is dangerous and may result in a traffic accident.

Basic operations

Preparation

Before operating the unit, make sure that all external components are correctly connected and installed.

1 Open the liquid crystal panel.

Press PUSH-OPEN until the liquid crystal panel is unlocked, then open the liquid crystal panel by both hands.

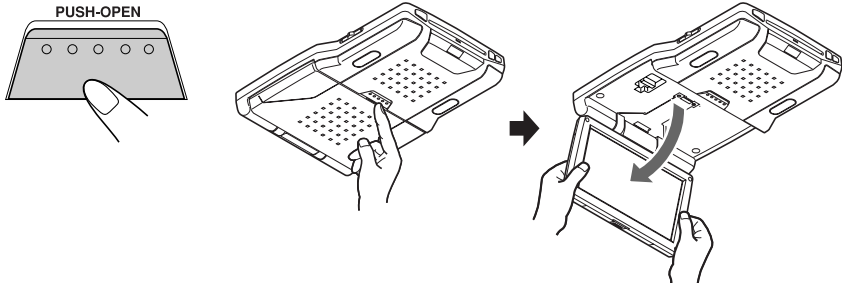

CAUTION:

- When not in use, close the liquid crystal panel and store it into the compartment; otherwise it may obstruct the visibility through the rearview mirror.
- Do not touch the surface of the liquid crystal panel directly.

When closing the liquid crystal panel, store it in the screen compartment until it is locked.

To change the monitor position

You can select a monitor position from the four positions.

- 1 Slide the arm lock lever to RELEASE, then pull down or push up the monitor.
- 2 Slide the arm lock lever to HOLD, then remove the screen arm to the nearest locking position.

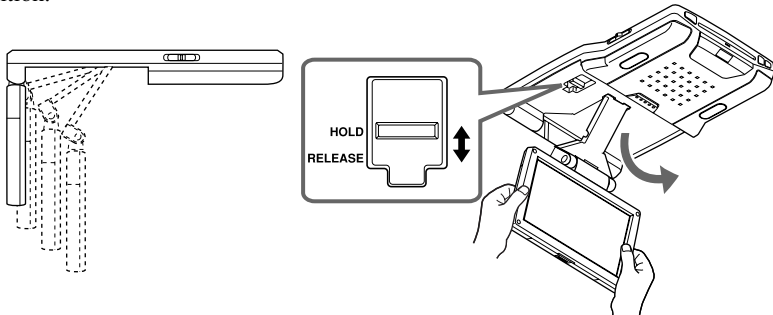

When closing the liquid crystal panel, push up the monitor to the highest position.

To be continued....

2 Turn on the power.

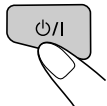

Monitor



Remote control

3 Select the playback source.

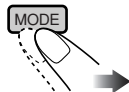

Each time you press the button, the playback source changes as follows:



4 Operate the playback source you selected.

To operate the built-in DVD player, see “Disc operations” on page 18.

To operate the external components, refer to the manuals for the connected components.

5 Adjust the volume on the car receiver.

- When using the headphones, adjust its volume level.

■ To turn off the power

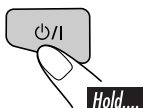

Monitor

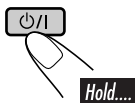

Remote control

- When using the headphones, turn off the power after turning off the headphones.

■ To activate the door sensor

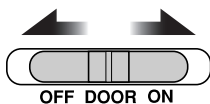

- **OFF:** Turns off the dome lights.
- **DOOR:** Activates the door sensor which turns on the dome lights when a door is open.
- **ON:** Turns on the dome lights.

Using the monitor menu

You can make your own display or sound adjustments using the menu.

- For the adjustable items, see the next page.

*The Remote controller—RM-RK230 has two MENU buttons.
In this section, using MENU button at MONITOR CONTROL.*

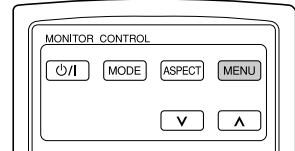

Basic procedure

1 Call up the menu.

MENU

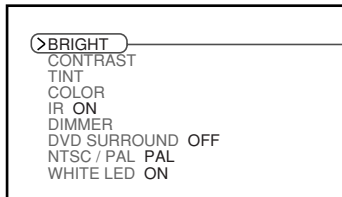

Current menu item

Menu selection goes off if other operations are done or no operation is done for about 5 seconds.

2 Select an item you want to adjust.

MENU



3 Adjust the level of the selected item (or select an appropriate setting for the selected item).

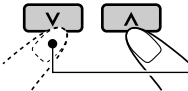

Not used for changing the "DVD SURROUND" setting.

4 Exit from the menu.

Press the button repeatedly until the menu is erased.

MENU



Adjustable items on the monitor menu

BRIGHT:	Adjust this if the picture is too bright or too dark. <ul style="list-style-type: none"> Adjustable range: -10 to +11 Initial level: 0 (center)
CONTRAST:	Control the degree of difference between the lightest and darkest parts of the picture. <ul style="list-style-type: none"> Adjustable range: -10 to +11 Initial level: 0 (center)
TINT:	Adjust this if the human skin color is unnatural. <ul style="list-style-type: none"> Adjustable range: -10 to +11 Initial level: 0 (center)
COLOR:	Adjust the color of the picture—lighter or darker. <ul style="list-style-type: none"> Adjustable range: -10 to +11 Initial level: 0 (center)
IR*:	Set to “ON” when you listen to the playback sounds using the cordless headphones. <ul style="list-style-type: none"> Selectable settings: ON, OFF Initial setting: ON
DIMMER:	Adjust the light of the screen and the white LED when you turn on the headlights. <ul style="list-style-type: none"> Adjustable range: -5 to +5 Initial level: 0 (center)
DVD SURROUND:	This function allows you to get a surround effect from your stereo system. When connecting a receiver incompatible with the multi-channel sources, you can enjoy the virtual surround sound with your 2-channel stereo system. If you turn off the monitor, the setting is initialized. <ul style="list-style-type: none"> Selectable settings: OFF, ACTION, DRAMA, THEATER <ul style="list-style-type: none"> ACTION: Suitable for action movies and sports programs. DRAMA: Creates natural and warm sound. Enjoy movies in a relaxed mood. THEATER: Enjoy sound effects like in a major theater. Initial setting: OFF
NTSC/PAL:	Select the color system to match to the incoming signals. <ul style="list-style-type: none"> Selectable settings: PAL, NTSC Initial setting: PAL Turn off then on the power to activate a new setting when you change the setting.
WHITE LED:	Light on or off the white LED when you turn on the monitor. <ul style="list-style-type: none"> Selectable settings: ON, OFF Initial setting: ON

* Turn off the headphones before changing the “IR” setting.

Changing the aspect ratio

You can select an appropriate aspect ratio for the playback video signals.

Basic procedure

Each time you press the button, aspect ratio change.



Changeable aspect ratio

When incoming 16:9 video signal:

FULL:

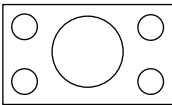

Pictures are fully shown on the screen.

- In some cases, the black bars may be shown at the top and bottom sides of the screen.

NORMAL:

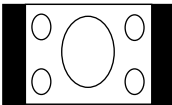

Pictures are reduced horizontally.

- The black bars will be shown at the left and right sides of the screen.
- In some cases, the black bars may be shown also at the top and bottom sides of the screen.

JUST:



The middle of pictures are reduced horizontally, and the left and right side of the picture enlarged horizontally.

- In some cases, the black bars may be shown at the top and bottom sides of the screen.

ZOOM:

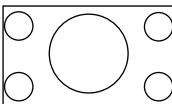

Pictures are enlarged on the screen so that no black bars will be shown on the screen. (The entire picture cannot be shown on the screen.)

To be continued....

When incoming 4:3 video signal:

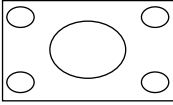
FULL:

Pictures are enlarged horizontally and are fully shown on the screen.

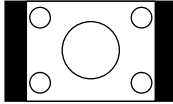
NORMAL:

Pictures are shown at the center of the screen.

- The black bars will be shown at the left and right sides of the screen.

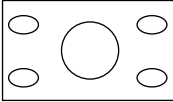
JUST:

Pictures are enlarged horizontally. The extension ratio increases toward the both sides of the screen.

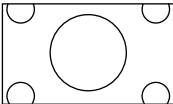
ZOOM:

Pictures are enlarged on the screen so that no black bars will be shown on the screen. (The entire picture cannot be shown on the screen.)

Playable discs

Discs you can play

You can play back the following discs—12 cm and 8 cm—on the built-in DVD player:

- **DVD Video:** Recorded in the PAL color system with Region Code “2” (see below).
 - DVD-R/DVD-RW recorded in the DVD Video format can also be played (see page 33).
- **Video CD (VCD)/audio CD**
- **MP3/WMA/JPEG:** Recorded either in CD-R/CD-RW or DVD-R/DVD-RW/DVD-ROM.
 - CD-R/CD-RW: Compliant with ISO 9660 Level 1, ISO 9660 Level 2, Romeo, and Joliet.
 - DVD-R/DVD-RW/DVD-ROM: Compliant with UDF-Bridge Format*1.

On some discs, the actual operations may be different from what is explained in this manual.

Discs cannot be played back

DVD-Audio, DVD-ROM (data), DVD-RAM, DVD-R/DVD-RW recorded in the DVD-VR format, CD-ROM, CD-I (CD-I Ready), Photo CD, etc.

- Playing back these discs will generate noise and damage the speakers.

Note on Region Code:

DVD players and DVD Video discs have their own Region Code numbers. This unit can only play back DVD discs whose Region Code numbers include “2.”

Examples:



If you insert a DVD Video disc of an incorrect Region Code

“REGION CODE ERROR!” appears on the screen. The disc will eject automatically.

Caution for DualDisc playback

- The Non-DVD side of a “DualDisc” does not comply with the “Compact Disc Digital Audio” standard. Therefore, the use of Non-DVD side of a DualDisc on this product may not be recommended.

Digital audio formats

The unit can play back the following digital audio formats.

Linear PCM: Uncompressed digital audio, the same format used for CDs and most studio masters.

Dolby Digital *2: Compressed digital audio, developed by Dolby Laboratories, which enables multi-channel encode to create the realistic surround sound.

DTS *3 (Digital Theater Systems):

Compressed digital audio, developed by Digital Theater Systems, Inc., which enables multi-channel like Dolby Digital. As the compression ratio is lower than for Dolby Digital, it provides wider dynamic range and better separation.

MPEG Audio: Another compressed digital audio which also enables multi-channel encode to create the realistic surround sound. However, this System downmix the multi-channel signals into 2 channels (decoded PCM) and play it back.

*1 A hybrid file system used to provide compatibility with ISO 9660 for accessing any type of files on the disc. (UDF stands for Universal Disk Format.)

*2 Manufactured under license from Dolby Laboratories. “Dolby” and the double-D symbol are trademarks of Dolby Laboratories.

*3 “DTS” and “DTS 2.0 + Digital Out” are trademarks of Digital Theater Systems, Inc.

“DVD Logo” is a trademark of DVD Format/Logo Licensing Corporation registered in the US, Japan and other countries.

Disc operations

Playing a disc

The disc type is automatically detected, and playback starts automatically (for DVD: automatic start depends on its internal program).

If the current disc is an audio CD, CD Text, MP3/WMA, JPEG, or VCD without PBC, all tracks will be played repeatedly until you change the source or eject the disc.

- If a title list or disc menu appears while playing a DVD or VCD with PBC, see “Disc menu operations” on page 22.

The following marks are used to indicate the playable discs....



DVD Video



Video CD with PBC



Video CD
with/without PBC



Audio CD/
CD Text



MP3/WMA disc



JPEG disc



All discs listed here

Before performing any operations, make sure the following....

- For DVD playback, you can change the setup menu setting as you like. (See pages 28 – 30.)
- For DVD/CD playback, using the remote controller is more attractive. You can enjoy more functions.

If “⊘” appears on the monitor when pressing a button, the disc cannot accept an operation you have tried to do.

- In some cases, without showing “⊘,” operations will not be accepted.

Starting playback

1 Open the liquid crystal panel.

- You can play a disc even if the monitor is closed.

2 Turn on the power.

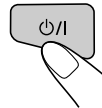

Monitor



Remote control





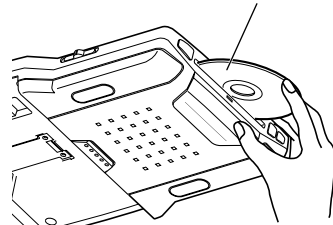





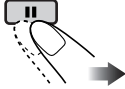
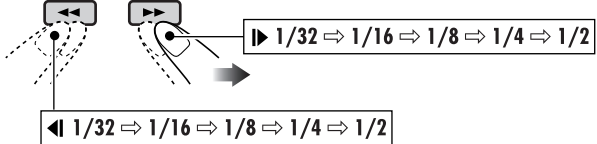

3 Insert a disc into the loading slot.

Playback (shining) side facing down



- When a disc is inserted into the loading slot, the power comes on, then “DISC” is selected as the playback source automatically.

Basic operations

Operations	Next operation
<p>To stop play temporarily</p> 	<p>Playback pauses.</p> <ul style="list-style-type: none"> • For JPEG discs: pressing ENTER will also pause the picture on the monitor.  <hr/> <p>A still picture appears.</p> <p>(A) Frame by frame playback</p>  <p>(B) Slow motion playback</p>  <ul style="list-style-type: none"> • No sound comes out during Slow Motion Playback. • When playing a VCD, Reverse Slow Motion Playback is prohibited. <p>To resume normal play:</p> 
<p>To replay the previous scenes—One Touch Replay</p> 	<p>The playback position moves back about 10 seconds before the current position.</p>  <ul style="list-style-type: none"> • This function works only within the same title. • For some DVDs, this function does not work.
<p>To stop playback</p> 	<p>When you start playback again, playback starts from where it has been stopped (Resume play).</p>    <hr/> <p>When you start playback again, playback starts from the beginning of the last playing track.</p>   

• During play, on-screen guide icons appear on the monitor for a while (see page 35).

To eject the disc



You can eject the disc even when the monitor is turned off.

To be continued....

To go to the next or previous chapters/tracks



- For DVD: During play or pause

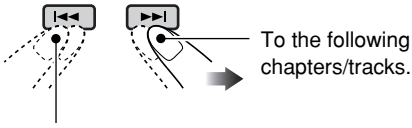

To the following chapters/tracks.

To go back to the beginning of the current chapter/track, then the previous chapters/tracks.

To fast-forward or reverse the chapter / track

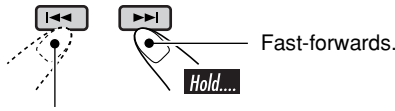

Fast-forwards.

Reverses.

* The search speed changes to x2 ⇔ x10 for all discs (DVD, VCD, CD), but the information shown on the monitor is only for DVD/VCD.

To forward or reverse search the chapter / track

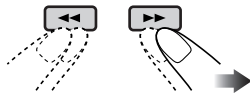

The information shown is only for DVD/VCD:

▶▶ x2 ⇔ x5 ⇔ x10 ⇔ x20 ⇔ x60

◀◀ x2 ⇔ x5 ⇔ x10 ⇔ x20 ⇔ x60

- To resume normal speed



To locate a particular title / chapter / track directly



- For DVD: During play or pause—select a chapter. During stop—select a title.
- For VCD: While PBC (see page 22) is not in use.
- For MP3/WMA/JPEG: Select a track within the same folder.

Select the number corresponding to the item you want (see page 9).

To locate a title / folder

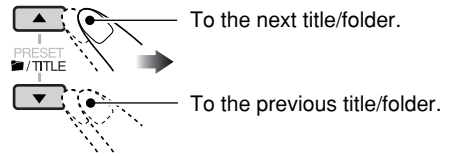

To the next title/folder.

To the previous title/folder.

To locate a particular title / folder

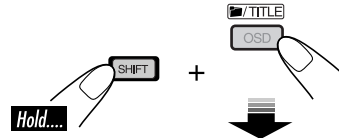

Within 10 seconds, press the number buttons (see page 9).

- For MP3/WMA/JPEG discs: To directly select the folders using the number button(s), it is required that folders be assigned 2 digit numbers at the beginning of their folder names—01, 02, 03, and so on.

DVD/VCD/JPEG special functions

Selecting audio languages

For DVD:

You can select the language to listen to if the disc has multiple audio languages.

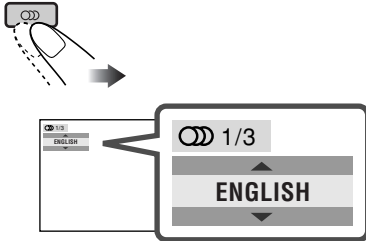

Ex.: When the disc has 3 options

For VCD:

You can select the audio channel to play. (This is convenient when playing a Karaoke VCD.)

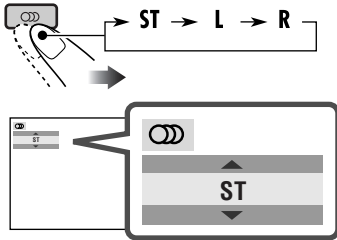

ST: To listen to normal stereo (left/right) playback.

L: To listen to the L (left) audio channel.

R: To listen to the R (right) audio channel.

Selecting subtitles

You can select the language of the subtitle to be shown on the monitor.



- You can set the initial subtitle language using the setup menu (see page 29).

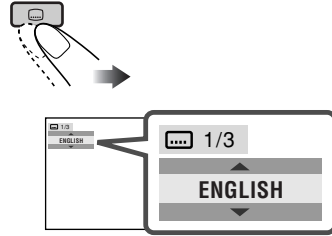

Ex.: When the disc has 3 options

Selecting multi-angle views

You can view the same scene at different angles if the disc has multi-angle views.

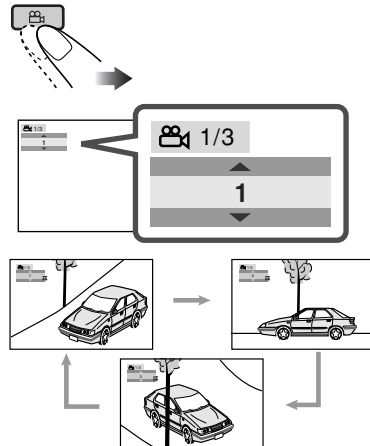

Ex.: When the disc has 3 multi-angle views

- For some DVDs and VCDs, changing the subtitle language, audio language (or audio channel) without using the disc menu is prohibited.

Disc menu operations

Menu-driven playback is possible while playing back a DVD with menu-driven features or a VCD with the PBC (PlayBack Control).

While playing a DVD



A title list or disc menu will appear on the monitor.

2 Select the item you want on the menu.

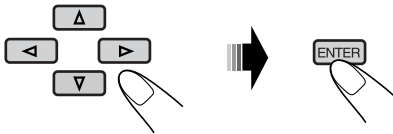

Selected item starts playback.

- On some discs, you can also select items using the corresponding number buttons.

While playing a VCD



- When a list of items is displayed on the monitor.

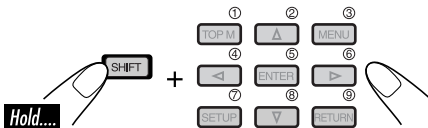

- To select a number greater than 9, see “How to select a number” on page 9.

To return to the previous menus



- For some discs, you can also move between the menus by pressing **◀◀ / ▶▶**.

Canceling the PBC playback

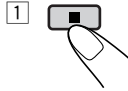

- 2 Select a track to start normal playback using the number buttons (see page 9).

To resume the PBC function

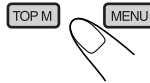

Zoom in

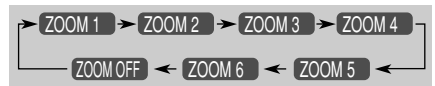
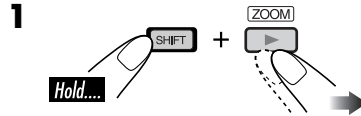

- For JPEG disc (effective only when pausing):

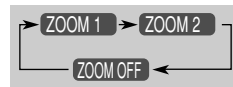

2 Move the zoomed-in portion.

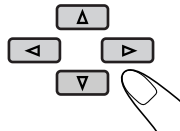

- For JPEG files:

You cannot move the zoomed-in position when the entire picture is displayed on the monitor.

To cancel zoom, select “ZOOM OFF” in step 1.

On-Screen disc operations

About the On-Screen Bar

You can check the disc information and use some functions through the on-screen bar.

- For audio CD, CD Text, and MP3/WMA/JPEG disc you can also use the control screen and list screen (see pages 26 and 27).

On-Screen bars



* Only for DTS audio CD

- 1 Disc type
 - 2 • Audio signal format type (for DVD and DTS audio CD)
 - PBC (only for VCD)
- 3 Playback information
 - T02-C03** Current title/chapter
 - TRACK 01** Current track
 - TOTAL** Elapsed playing time of the disc
 - T. REM** Remaining disc time (for VCD)/remaining title time (for DVD)
 - TIME** Elapsed playing time of the current chapter/track
 - REM** Remaining time of the current chapter/track
- 4 Playback condition
 - Playback
 - Forward/reverse search
 - Forward/reverse slow-motion
 - Pause
 - Stop
- 5 Operation icons
 - TIME** Time indication
 - Time Search—Enter the elapsed playing time of the current title or of the disc.
 - TITLE** Title Search
 - CHAP** Chapter Search
 - TRACK** Track Search
 - Change the audio language or audio channel.
 - Change the subtitle language.
 - Change the view angle.
 - OFF** Repeat play (for DVD)
 - REPEAT** Repeat play (for other discs)
 - INTRO** Intro play
 - RANDOM** Random play
- 6 Current playback mode

To be continued...

Basic on-screen bar operations

1 Display the on-screen bar.

- For DVD/VCD:

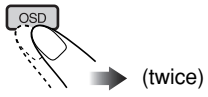

- For other discs:



When a JPEG disc is loaded, skip to step 3.

2 Select an item.

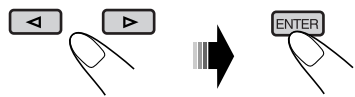

3 Make a selection.

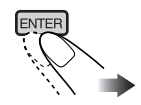

- If pop-up menu appears....

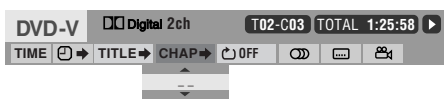
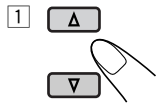

or

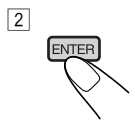
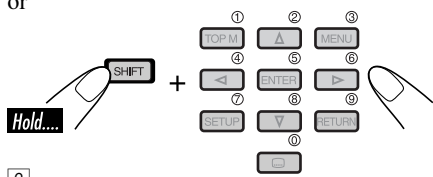

To erase the on-screen bar



- The on-screen bar for a CD or MP3/WMA/JPEG disc automatically disappears in a few seconds after the last operation.
- The selectable options for Repeat/Intro/Random plays:

OFF You can repeat the current title or chapter.

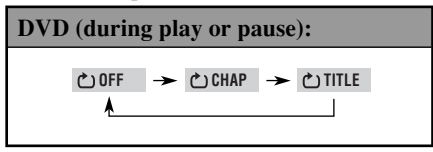

REPEAT You can repeat the current track (except for JPEG) or the tracks in the current folder (only for MP3/WMA/JPEG).

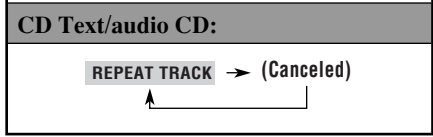
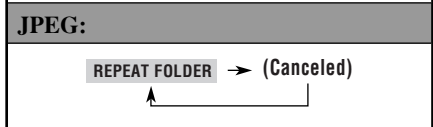
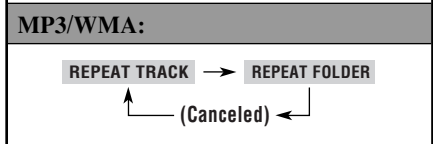
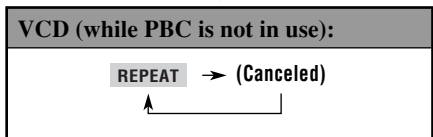

INTRO You can play the first 15 seconds of all tracks in the disc, or in the current folder (only for MP3/WMA).

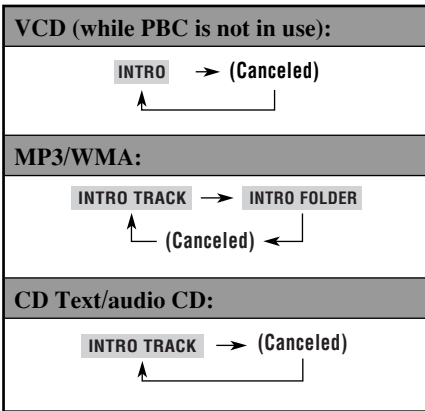

RANDOM You can randomly play all tracks in the disc, or in the current folder (only for MP3/WMA).

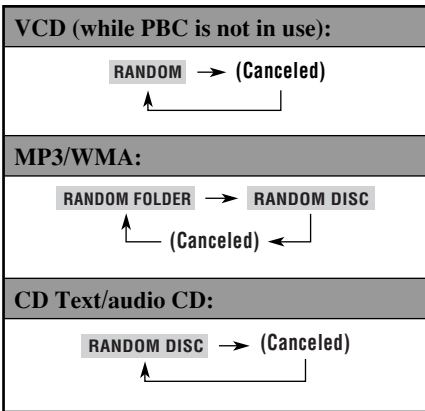

Refer also page 24 for the following operations.

To change the time information

- 1 Select **TIME**.
- 2 Change the time information.

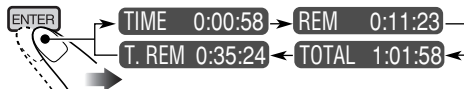

To search for a particular point by playing time

- For VCD: while PBC is not in use.
- 1 Select **▶▶**.
 - 2 Enter the elapsed playing time of the current title or of the disc.

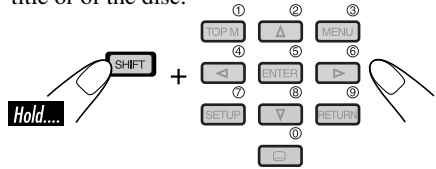

- Ex.:
- To enter 1 (hours): 02 (minutes): 00 (seconds), press 1, 0, 2, 0, then 0.
 - To enter 54 (minutes): 00 (seconds), press 0, 5, 4, 0, then 0.

- It is always required to enter the hour digit (even “0” hour), but it is not required to enter trailing zeros (the last two digits in the examples above).
- To correct a misentry, press...
- You can also specify the elapsed playing time by using Δ / ∇ / \triangleleft / \triangleright .

- 3 Finish the procedure.

To search for a particular title/chapter/track

- 1 Select **TITLE▶**, **CHAP▶**, or **TRACK▶**.
- 2 Enter the number.

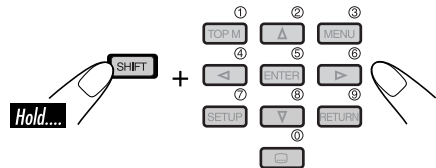

- To correct a misentry, press the number button until the correct number is entered.

- 3 Finish the procedure.

Basic control screen operations

You can search for and play the desired items through the control screen.

For MP3/WMA/CD Text/audio CD:

The control screen automatically appears on the monitor when you insert a disc.

JPEG:

Press TOP M (menu), MENU, or ■. Playback stops and the control screen appears.

To select a folder or track

- 1 Select "Folder" column or "Track" column on the control screen.

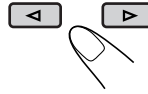

- 2 Select a folder or track.

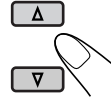

- If playback does not start, press ► or ENTER.

- For JPEG discs: Pressing ENTER will pause the selected picture on the monitor.

MP3/WMA/JPEG control screen

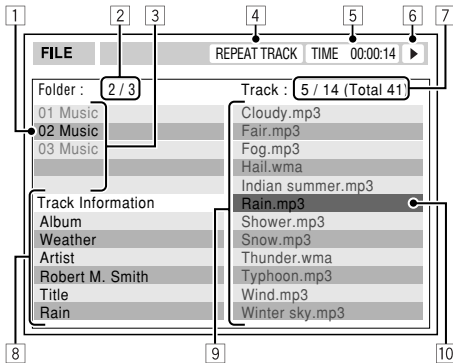

Ex.: Control screen for MP3/WMA

- 1 Current folder
- 2 Current folder number/total folder number
- 3 Folder list
- 4 Selected playback mode
- 5 Elapsed playing time of the current track (only for MP3/WMA)
- 6 Operation mode icon (only for MP3/WMA)
► (play), ■ (stop), || (pause), ►► (fast-forward), ◀◀ (reverse)
- 7 Current track number/total number of tracks in the current folder (total number of tracks on the disc)
- 8 Track information (only for MP3/WMA)
- 9 Track list
- 10 Current track (highlighted bar)

CD Text/audio CD control screen

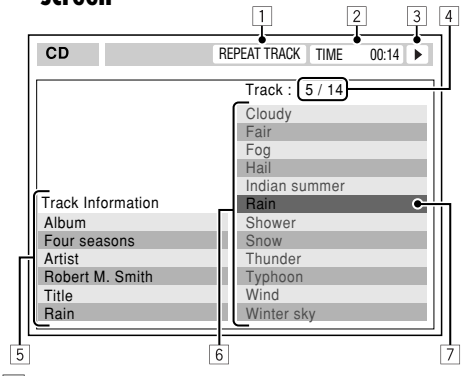

- 1 Selected playback mode
- 2 Elapsed playing time of the current track
- 3 Operation mode icon
► (play), ■ (stop), || (pause), ►► (fast-forward), ◀◀ (reverse)
- 4 Current track number/total number of tracks on the disc
- 5 Track information
- 6 Track list
- 7 Current track (highlighted bar)

To select a track

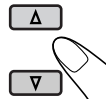

- If playback does not start, press ► or ENTER.

List screen operations

You can display the folder list/track list before starting play. On this list, you can confirm the contents and start playing a disc.

Folder/track list screens



Folder list (MP3/WMA/JPEG)

1	2	3
Folder : 153/240	Track 154/198	Page : 4/6
fol130	fol140	fol150
fol131	fol141	fol151
fol132	fol142	fol152
fol133	fol143	fol153
fol134	fol144	fol154
fol135	fol145	fol155
fol136	fol146	fol156
fol137	fol147	fol157
fol138	fol148	fol158
fol139	fol149	fol159
		fo160
		fo161
		fo162
		fo163
		fo164
		fo165
		fo166
		fo167
		fo168
		fo169
		4

Ex.: Folder list for MP3/WMA

Track list (MP3/WMA/JPEG/CD Text/audio CD)

1	2	3
Folder : 153/240	Track 154/198	Page : 4/6
file0131.mp3	file0141.mp3	file0151.wma
file0132.mp3	file0142.mp3	file0152.mp3
file0133.wma	file0143.mp3	file0153.wma
file0134.mp3	file0144.mp3	file0154.mp3
file0135.mp3	file0145.wma	file0155.mp3
file0136.wma	file0146.mp3	file0156.mp3
file0137.wma	file0147.wma	file0157.mp3
file0138.mp3	file0148.mp3	file0158.wma
file0139.mp3	file0149.wma	file0159.wma
file0140.wma	file0150.wma	file0160.wma
		file0161.wma
		file0162.mp3
		file0163.wma
		file0164.mp3
		file0165.wma
		file0166.wma
		file0167.wma
		file0168.wma
		file0169.mp3
		file0170.wma
		4

Ex.: Track list for MP3/WMA

- 1 Current folder number/total folder number (only for MP3/WMA/JPEG)
- 2 Current track number/total number of tracks in the current folder (for MP3/WMA/JPEG) or in the disc (for CD Text/audio CD)
- 3 Current page/total number of the pages included in the list
- 4 Current folder/track (highlighted bar)

For MP3/WMA/JPEG:

While stop...

1 Display the folder list.

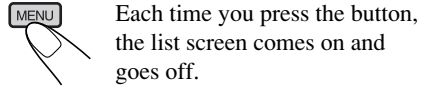

2 Select a folder on the list.

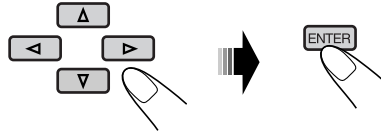

The track list of the selected folder appears.

To go back to the folder list



3 Select a track on the list.

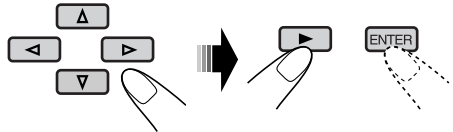

- For JPEG discs: Pressing ENTER will pause the selected picture on the monitor.

For CD Text/audio CD:

While stop...

1 Display the track list.

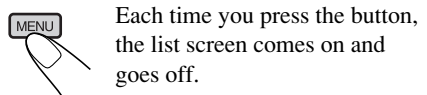

2 Select a track on the list.

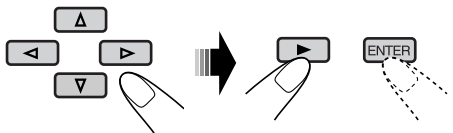

DVD setup menu

You can store the initial disc playback status.

- While playing, no change can be made on the setup menu.
- When shipped from the factory, the on-screen language is set to English. To change the language, see page 29.

Basic setting procedure

While stop...

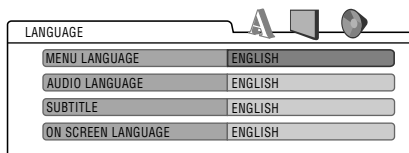
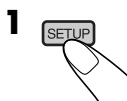

2

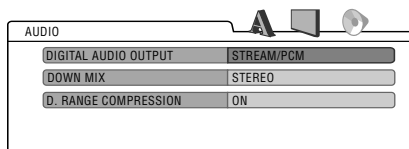
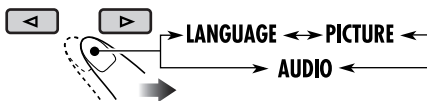

Ex.: When selecting the "AUDIO" menu

3 Select an item you want to set up.

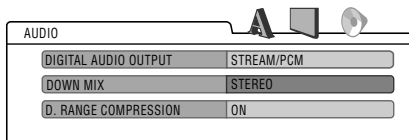
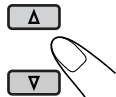

Ex.: When selecting "DOWN MIX"

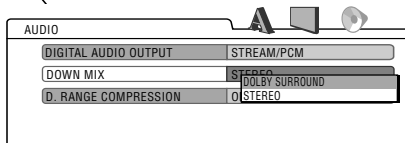

5 Select an option.

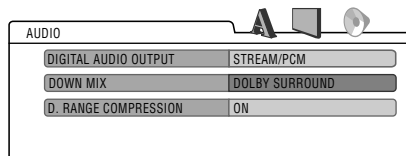
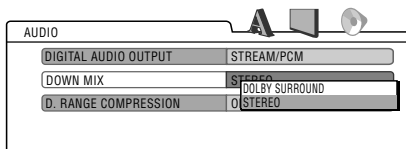
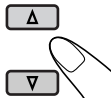

To set other items on the same menu

Repeat steps **3** to **6**.

To set other items on other menus

Repeat steps **2** to **6**.

To return to the normal screen



A LANGUAGE menu

Item	Contents
MENU LANGUAGE	Select the initial disc menu language.
AUDIO LANGUAGE	Select the initial audio language.
SUBTITLE	Select the initial subtitle language or erase the subtitle (OFF).
ON SCREEN LANGUAGE	Select the language for the setup menu and some indications shown on the monitor.

• For the LANGUAGE settings, see also the language codes list on page 32.

PICTURE menu

Item	Contents
<p>MONITOR TYPE</p> <p>16:9 4:3 LETTER BOX</p> <p>4:3 PAN SCAN</p>	<p>Select the monitor type to watch a wide screen picture on your external monitor.</p> <ul style="list-style-type: none"> • 16:9 : Select this when the aspect ratio of your monitor is 16:9. • 4:3 LETTER BOX : Select this when the aspect ratio of your monitor is 4:3. While viewing a wide screen picture, the black bars appear on the top and the bottom of the screen. • 4:3 PAN SCAN : Select this when the aspect ratio of your monitor is 4:3. While viewing a wide screen picture, the black bars do not appear; however, the left and right edges of the pictures will not be shown on the screen.
<p>OSD POSITION</p> <p>Position 1 Position 2</p>	<p>Select the on-screen bar position on the monitor.</p> <ul style="list-style-type: none"> • 1 : Higher position • 2 : Lower position (Help screen under the DVD setup menu disappears.)
<p>MP3/JPEG</p>	<p>If both MP3/WMA files and JPEG files are recorded on a disc, you can select which files to play.</p> <ul style="list-style-type: none"> • MP3 : Select this for playing MP3/WMA files. • JPEG : Select this for playing JPEG files. <p>Eject the disc and insert it again to make the new setting effective.</p>

To be continued....



AUDIO menu

Item	Contents
DIGITAL AUDIO OUTPUT	Select the signal format to be emitted through the DIGITAL OUT (Optical) terminal. For details, see page 36. <ul style="list-style-type: none"> • PCM ONLY : Select this when connecting an amplifier or a decoder incompatible with Dolby Digital, DTS, MPEG Audio, or connecting to a recording device. • DOLBY DIGITAL/PCM : Select this when connecting an amplifier or a decoder compatible with Dolby Digital. • STREAM/PCM : Select this when connecting an amplifier or a decoder compatible with Dolby Digital, DTS, or MPEG Audio.
DOWN MIX	When playing back a multi-channel DVD disc, this setting affects the signals reproduced through the analog terminals—AV-OUT and cordless headphones (and through the DIGITAL OUT terminal when “PCM ONLY” is selected for “DIGITAL AUDIO OUTPUT”). <ul style="list-style-type: none"> • DOLBY SURROUND : Select this when you want to enjoy multi-channel surround audio by connecting an amplifier compatible with Dolby Surround to this monitor. • STEREO : Normally select this.
D. (Dynamic) RANGE COMPRESSION	You can enjoy a powerful sound at low or middle volume levels while playing a Dolby Digital software. <ul style="list-style-type: none"> • AUTO : Select this to apply the effect to multi-channel encoded software (excluding 1-channel and 2-channel software). • ON : Select this to always use this function.

■ To prevent damage to the exterior

- Do not apply pesticides, benzene, thinner or other volatile substances to the monitor. The cabinet surface primarily consists of plastic materials.
- Do not wipe with benzene, thinner or similar substances because this will result in discoloration or removal of the paint.
- When a cloth with a cleansing chemical is used, follow the caution points.
 - Do not leave the unit in contact with rubber or vinyl products for long periods of time.
 - Do not use cleansers which have polishing granules because this could damage the cabinet.

■ Clean off dirt by wiping lightly with a soft cloth

When the cabinet is very dirty, wipe with a well-wrung cloth dipped in a kitchen cleanser (neutral) thinned by water and then go over the same surface with a dry cloth. (Since there is the possibility of water drops getting inside of the unit, do not directly apply cleanser to the surface.)

■ Moisture condensation

Moisture may condense on the lens inside the DVD player in the following cases:

- After starting the heater in the car.
 - If it becomes very humid inside the car.
- Should this occur, the DVD player may malfunction. In this case, eject the disc and leave the unit turned on for a few hours until the moisture evaporates.

■ How to handle discs

When removing a disc from its case, press down the center holder of the case and lift the disc out, holding it by the edges.

Center holder



- Always hold the disc by the edges. Do not touch its recording surface.

When storing a disc into its case, gently insert the disc around the center holder (with the printed surface facing up).

- Make sure to store discs into the cases after use.

■ To keep discs clean

A dirty disc may not play correctly. If a disc does become dirty, wipe it with a soft cloth in a straight line from center to edge.



- Do not use any solvent (for example, conventional record cleaner, spray, thinner, benzene, etc.) to clean discs.

■ To play new discs

New discs may have some rough spots around the inner and outer edges. If such a disc is used, this unit may reject the disc.



To remove these rough spots, rub the edges with a pencil or ball-point pen, etc.

Do not use the following discs:

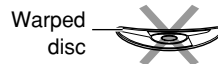

Language codes

Code	Language	Code	Language	Code	Language
AA	Afar	IK	Inupiak	RN	Kirundi
AB	Abkhazian	IN	Indonesian	RO	Rumanian
AF	Afrikaans	IS	Icelandic	RW	Kinyarwanda
AM	Ameharic	IW	Hebrew	SA	Sanskrit
AR	Arabic	JI	Yiddish	SD	Sindhi
AS	Assamese	JW	Javanese	SG	Sangho
AY	Aymara	KA	Georgian	SH	Serbo-Croatian
AZ	Azerbaijani	KK	Kazakh	SI	Singhalese
BA	Bashkir	KL	Greenlandic	SK	Slovak
BE	Byelorussian	KM	Cambodian	SL	Slovenian
BG	Bulgarian	KN	Kannada	SM	Samoan
BH	Bihari	KO	Korean (KOR)	SN	Shona
BI	Bislama	KS	Kashmiri	SO	Somali
BN	Bengali, Bangla	KU	Kurdish	SQ	Albanian
BO	Tibetan	KY	Kirghiz	SR	Serbian
BR	Breton	LA	Latin	SS	Siswati
CA	Catalan	LN	Lingala	ST	Sesotho
CO	Corsican	LO	Laothian	SU	Sundanese
CS	Czech	LT	Lithuanian	SW	Swahili
CY	Welsh	LV	Latvian, Lettish	TA	Tamil
DZ	Bhutani	MG	Malagasy	TE	Telugu
EL	Greek	MI	Maori	TG	Tajik
EO	Esperanto	MK	Macedonian	TH	Thai
ET	Estonian	ML	Malayalam	TI	Tigrinya
EU	Basque	MN	Mongolian	TK	Turkmen
FA	Persian	MO	Moldavian	TL	Tagalog
FI	Finnish	MR	Marathi	TN	Setswana
FJ	Fiji	MS	Malay (MAY)	TO	Tonga
FO	Faroese	MT	Maltese	TR	Turkish
FY	Frisian	MY	Burmese	TS	Tsonga
GA	Irish	NA	Nauru	TT	Tatar
GD	Scots Gaelic	NE	Nepali	TW	Twi
GL	Galician	NO	Norwegian	UK	Ukrainian
GN	Guarani	OC	Occitan	UR	Urdu
GU	Gujarati	OM	(Afan) Oromo	UZ	Uzbek
HA	Hausa	OR	Oriya	VI	Vietnamese
HI	Hindi	PA	Panjabi	VO	Volapuk
HR	Croatian	PL	Polish	WO	Wolof
HU	Hungarian	PS	Pashto, Pushto	XH	Xhosa
HY	Armenian	PT	Portuguese	YO	Yoruba
IA	Interlingua	QU	Quechua	ZU	Zulu
IE	Interlingue	RM	Rhaeto-Romance		

More about this monitor

Basic operations

Turning off the power

- If you turn off the power while listening to a disc, disc play will start automatically, next time you turn on the power.

Disc operations

General

- In this manual, words “track” and “file” are interchangeably used when referring to MP3/WMA/JPEG files and their file names.
- This unit can also playback 8 cm discs.
- This unit can only playback audio CD (CD-DA) files if different type of files are recorded in the same disc.
 - The first track will be skipped if a different type of file is detected first.
- When a disc has been loaded, selecting “DISC” for the playback source starts disc play.

Starting playback

- When a disc is inserted upside down, “NO DISC” appears on the screen, then the disc will automatically eject.
- You can play a disc even if the monitor is closed.

Basic operations

- No sound comes out during slow motion playback. When playing a VCD, reverse slow motion playback is prohibited.
- One Touch Replay works only within the same title. (For some DVDs, this function does not work.)
- When playing a DVD/VCD, no sound comes out during Search.
- Reverse search stops automatically when it reaches the beginning of the disc. Playback resumes at normal speed.

DVD/VCD/JPEG special functions

- For some DVDs and VCDs, changing the subtitle language, audio language (or audio channel) without using the disc menu is prohibited.
- While zoomed in, the picture may look coarse.

Playing a DVD-R/DVD-RW or CD-R/CD-RW

- Use only “finalized” discs.
- This unit can play back only the files of the same type which is first detected if a disc includes both audio CD (CD-DA) files and MP3/WMA/JPEG files.
- This unit can play back either MP3/WMA files or JPEG files if a disc includes both kind of files. Set the playback file type on DVD setup menu (page 29) before playing back a disc containing both kind of files.
- Only for CD-R/CD-RW: This unit can play back multi-session discs; however, unclosed sessions will be skipped while playing.
- Some DVD-R/DVD-RW or CD-R/CD-RW may not play back on this unit because of their disc characteristics, and for the following causes:
 - Discs are dirty or scratched.
 - Moisture condensation occurs on the lens inside the unit.
 - The pickup lens inside the unit is dirty.
 - CD-R/CD-RW on which the files are written with “Packet Write” method.
 - DVD-R/DVD-RW which are not written in UDF-Bridge Format (eg. UDF format or ISO format).
 - There are improper recording conditions (missing data, etc.) or media conditions (stain, scratch, warp, etc.).
- DVD-RW/CD-RW may require a longer readout time since the reflectance of DVD-RW/CD-RW is lower than that of regular discs.

To be continued...

- Do not use the following DVD-R/DVD-RW or CD-R/CD-RW:
 - Discs with stickers, labels, or protective seal stuck to the surface.
 - Discs on which labels can be directly printed by an ink jet printer.
 Using these discs under high temperatures or high humidities may cause malfunctions or damages to discs.
- This unit can play back the files recorded in VBR (variable bit rate).
The files recorded in VBR have a discrepancy in elapsed time display, and do not show the actual elapsed time. Especially, after performing the search function, this difference becomes noticeable.
- This unit cannot play back the following files:
 - MP3 files encoded with MP3i and MP3 PRO format.
 - MP3 files encoded in an unappropriated format.
 - MP3 files encoded with Layer 1/2.
 - WMA files encoded with lossless, professional, and voice format.
 - WMA files which are not based upon Windows Media® Audio.
 - WMA files copy-protected with DRM.
 - WMA files recorded with MBR (Multiple Bit Rate) format.
 - Files which have the data such as WAVE, ATRAC3, etc.

Playing an MP3/WMA disc

- This unit can play back MP3/WMA files with the extension code <.mp3> or <.wma> (regardless of the letter case—upper/lower) recorded in either CD-R/CD-RW or in DVD-R/DVD-RW.
- This unit can show the names of albums, artists (performer), and ID3 Tag (Version 1.0, 1.1, 2.2, 2.3, or 2.4) for MP3 files and WMA files.
- This unit can display only one-byte characters. No other characters can be correctly displayed.
- This unit can play back MP3/WMA files meeting the conditions below:
 - Bit rate: MP3: 32 kbps — 320 kbps
WMA: 32 kbps — 192 kbps
 - Sampling frequency:
 - 48 kHz, 44.1 kHz, 32 kHz (for MPEG-1)
 - 24 kHz, 22.05 kHz, 16 kHz (for MPEG-2)
 - 48 kHz, 44.1 kHz, 32 kHz (for WMA)
 - Disc format: ISO 9660 Level 1/ Level 2, Romeo, Joliet, Windows long file name
- The maximum number of characters for file/ folder names vary among the disc format used (includes 4 extension characters—<.mp3> or <.wma>).
 - ISO 9660 Level 1: up to 12 characters
 - ISO 9660 Level 2: up to 31 characters
 - Romeo: up to 128 characters
 - Joliet: up to 64 characters
 - Windows long file name: up to 128 characters
- This unit can recognize the total of 1100 files, 250 folders (maximum of 999 files per folder).

Playing a JPEG disc

- This unit can play back JPEG files with the extension code <.jpg> (regardless of the letter case—upper/lower) recorded in either CD-R/CD-RW or in DVD-R/DVD-RW.
- It is recommended that you record a file at 640 x 480 resolution. (If a file has been recorded at a resolution of more than 640 x 480, it will take a long time to be shown.)
- This System can play only baseline JPEG files. Progressive JPEG files or lossless JPEG files cannot be played.
 - Baseline JPEG format: Used for digital cameras, web, etc.
 - Progressive JPEG format: Used for web.
 - Lossless JPEG format: An old type and rarely used now.
- If progressive or lossless JPEG files are played back, a black screen appears. In this case, stop playback and select a baseline JPEG file. Note that it may take a long time to select another file.

- Even if you try to pause the current picture, it may be skipped, then the next picture will pause.
- This unit can recognize the total of 1100 files, 250 folders (maximum of 999 files per folder).

Changing the source

- If you change the source, playback also stops (without ejecting the disc).
Next time you select “DISC” for the playback source, disc play starts automatically.

Ejecting a disc









- If the ejected disc is not removed within 15 seconds, the disc is automatically inserted again into the loading slot to prevent it from dust. (Disc will not play this time.)

DVD setup menu

- When the language you have selected is not recorded on a disc, the original language is automatically used as the initial language. In addition, for some discs, the initial languages settings will not work as you set due to their internal disc programming.
- While playing (or pausing), you cannot change these languages.
After you change any of these language settings, eject the disc and insert it (or another disc) again so that your setting takes effect.
- When you select “16:9” for a picture whose aspect ratio is 4:3, the picture slightly changes due to the process for converting the picture width.
- Even if “4:3 PAN SCAN” is selected, the screen size may become “4:3 LETTER BOX” with some DVDs. This depends on how they are recorded.

On-screen guide icons

During play, the following guide icons may appear for a while on the monitor.

-  : Appears at the beginning of a scene containing multi-audio languages (for DVD only).
-  : Appears at the beginning of a scene containing multi-subtitle languages (for DVD only).
-  : Appears at the beginning of a scene containing multi-angle views (for DVD only).
-  : Play
-  : Pause
-  : Forward slow motion playback (for DVD and VCD only)
-  : Reverse slow motion playback (for DVD only)
-  : Forward search
-  : Reverse search

About sounds reproduced through the terminals

- Through the analog terminals (AV-OUT/cordless headphones): 2-channel signal is emitted. When playing a multi-channel encoded disc, multi-channel signals are downmixed. (AUDIO—DOWN MIX: see page 30.)
- Through DIGITAL OUT (optical):
 Digital signals (Linear PCM, Dolby Digital, DTS, MPEG Audio) are emitted through this terminal. (For more details, see table below.)
 To reproduce multi-channel sounds such as Dolby Digital, DTS, and MPEG Audio, connect an amplifier or a decoder compatible with these multi-channel sources to this terminal, and set “DIGITAL AUDIO OUTPUT” correctly. (See page 30.)

Output signals through the DIGITAL OUT terminal

Output signals are different depending on the “DIGITAL AUDIO OUTPUT” setting on the setup menu (see page 30).

Playback Disc	DIGITAL AUDIO OUTPUT	Output Signals		
		STREAM/PCM	DOLBY DIGITAL/PCM	PCM ONLY
DVD	48 kHz, 16/20/24 bits Linear PCM	48 kHz, 16 bits stereo Linear PCM		
	96 kHz, Linear PCM			
	with DTS	DTS bitstream	48 kHz, 16 bits stereo Linear PCM	
	with Dolby Digital	Dolby Digital bitstream		48 kHz, 16 bits stereo Linear PCM
	with MPEG Audio	MPEG bitstream	48 kHz, 16 bits Linear PCM	
Audio CD, Video CD		44.1 kHz, 16 bits stereo Linear PCM		
Audio CD with DTS		DTS bitstream	44.1 kHz, 16 bits stereo Linear PCM	
MP3/WMA		32/44.1/48 kHz, 16 bits Linear PCM		

Troubleshooting

What appears to be trouble is not always serious. Check the following points before calling a service center.

	Symptoms	Causes	Remedies
General	<ul style="list-style-type: none"> Colored spots (red, blue and green) appear on the screen. 	This is a characteristic of liquid crystal panels and is not a malfunction.	See "Note" on page 6.
	<ul style="list-style-type: none"> No picture appears and sound is not heard. 	The cord is not connected correctly to the external component.	Connect the cord correctly.
		Correct input mode is not selected.	Select the correct input mode.
	<ul style="list-style-type: none"> The unit does not work at all. 	The built-in microcomputer may have functioned incorrectly due to noise, etc.	Reset the unit (see page 4).
	<ul style="list-style-type: none"> Remote controller does not work. Cordless headphones do not work. 	The battery has lost its charge.	Install a new battery.
		The sensor is exposed to strong light.	Do not expose the sensor to strong light.
<ul style="list-style-type: none"> Howling occurs from the speakers or the headphones. 	It may be caused by a camcorder connected to the monitor.	Camcorder is now in recording mode. Deactivate the recording mode.	
Disc playback	<ul style="list-style-type: none"> "NO DISC" appears on the screen. 	Disc is inserted upside down.	Insert the disc correctly.
	<ul style="list-style-type: none"> CD-R/CD-RW or DVD-R/DVD-RW cannot be played back. Tracks on the CD-R/CD-RW or DVD-R/DVD-RW cannot be skipped. 	CD-R/CD-RW or DVD-R/DVD-RW is not finalized.	<ul style="list-style-type: none"> Insert a finalized CD-R/CD-RW or DVD-R/DVD-RW. Finalize the CD-R/CD-RW or DVD-R/DVD-RW with the component which you used for recording.
		<ul style="list-style-type: none"> The left and right edges of the picture are missing on the screen. 	"4:3 PAN SCAN" is selected when viewing on a conventional TV (aspect ratio 4:3).

	Symptoms	Causes	Remedies
Disc playback	<ul style="list-style-type: none"> • Sound and picture are sometimes interrupted or distorted. 	You are driving on rough roads.	Stop playback while driving on rough roads.
		Disc is scratched.	Change the disc.
		Connections are incorrect.	Check the cords and connections.
	<ul style="list-style-type: none"> • The playback pictures cannot be shown correctly. 	The color system (NTSC/PAL) is not correct.	Set it correctly (see page 14).
MP3/WMA/JPEG playback	<ul style="list-style-type: none"> • Disc cannot be played back. 	No MP3/WMA/JPEG tracks are recorded on the disc.	Change the disc.
		MP3/WMA/JPEG tracks do not have the extension code <.mp3>, <.wma>, or <.jpg> in their file names.	Add the extension code <.mp3>, <.wma>, or <.jpg> to their file names.
		MP3/WMA/JPEG tracks are not recorded in a compliant format.	Change the disc. Record MP3/WMA/JPEG tracks using a compliant application (see page 17).
		MP3/WMA/JPEG tracks are recorded in DVD+R/DVD+RW media.	Change the disc. Record MP3/WMA/JPEG tracks using DVD-R/DVD-RW media.
	<ul style="list-style-type: none"> • Noise is generated. 	The track played back is not an MP3/WMA file (although it has the extension code <.mp3> or <.wma>).	Skip to another track or change the disc. (Do not add the extension code <.mp3> or <.wma> to non-MP3 or WMA tracks.)
	<ul style="list-style-type: none"> • A longer readout time is required. 	Readout time varies due to the complexity of the folder/file configuration.	Do not use too many hierarchies and folders.
	<ul style="list-style-type: none"> • Tracks cannot be played back as you have intended them to play. 	Playback order is determined when the files are recorded.	_____
<ul style="list-style-type: none"> • Elapsed playing time is not correct. 	This sometimes occurs during play. This is caused by how the tracks are recorded on the disc.	_____	

Specifications

WIDESCREEN MONITOR

Screen:
9 inch liquid crystal panel

Number of pixel:
336 960 pixels
(480 vertical × 234 horizontal × 3)

Drive method:
TFT (Thin Film Transistor) active matrix format

Cordless audio:
Infrared audio transmitter
L-channel: 2.3 MHz
R-channel: 2.8 MHz
Effective listening angle: 30°
Effective range: 2 m

Color system: NTSC/PAL

Input:
Video: RCA pin × 2 circuits
1 V(p-p), 75 Ω
Audio: RCA pin × 2 circuits
1.5 V(rms)

Output:
Video: RCA pin × 1 circuit
1 V(p-p), 75 Ω
Audio: RCA pin × 1 circuit
1.5 V(rms)
DIGITAL OUT: Optical

DVD/CD PLAYER SECTION

Signal detection system: Non-contact optical pickup (semiconductor laser)

Number of channels: 2 channels (stereo)

Frequency response:
DVD, fs=48 kHz/96 kHz: 16 Hz to 22 000 Hz
VCD, CD: 16 Hz to 20 000 Hz

Dynamic range: 93 dB

Signal-to-noise ratio: 95 dB

Wow and flutter: Less than measurable limit

MP3 (MPEG Audio Layer 3):
Max. Bit Rate: 320 kbps

WMA (Windows Media® Audio):
Max. Bit Rate: 192 kbps

GENERAL

Power requirement:
Operating voltage:
DC 14.4 V (11 V to 16 V allowance)

Grounding system: Negative ground

Allowable operating temperature:
0°C to +40°C

Allowable storage temperature:
-20°C to +80°C

Dimensions (W × H × D):
Installation size (approx.):
250 mm × 49 mm × 374 mm

Mass (approx.):
2.9 kg (excluding accessories)

CORDLESS HEADPHONES

Type: Open-air type

Driver unit:
30 mm Mylarcone dynamic speaker

Impedance: 16 Ω

Frequency response: 20 Hz to 20 000 Hz

Infrared wavelength: 850 nm ± 50 nm

Power requirements:
DC 3 V (2.4 V to 3.3 V allowance)
(R03/AAA battery × 2)

Mass (approx.):
170 g (except batteries)

Allowable operating temperature:
-30°C to +65°C

Design and specifications are subject to change without notice.

- Microsoft and Windows Media are either registered trademarks or trademarks of Microsoft Corporation in the United States and/or other countries.



**Having TROUBLE with operation?
Please reset your unit
Refer to page of How to reset your unit**

JVC



EN, GE, FR, NL

© 2005 Victor Company of Japan, Limited

0305MNMDWJEIN

Free Manuals Download Website

<http://myh66.com>

<http://usermanuals.us>

<http://www.somanuals.com>

<http://www.4manuals.cc>

<http://www.manual-lib.com>

<http://www.404manual.com>

<http://www.luxmanual.com>

<http://aubethermostatmanual.com>

Golf course search by state

<http://golfingnear.com>

Email search by domain

<http://emailbydomain.com>

Auto manuals search

<http://auto.somanuals.com>

TV manuals search

<http://tv.somanuals.com>