

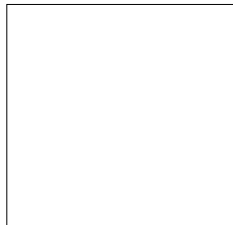

Legacy 36

Electric Range



Users Guide & Installation Instructions

This book contains many important safety messages.

Always read and obey all safety messages.

Installer: Leave these instructions with the appliance

Important - Save the installation instructions for the local electrical inspector's use.

U107501-01

www.aga-ranges.com

Warning

The anti-tip device supplied with this range must be correctly fitted when the appliance is installed. This will reduce risk of tipping of the appliance from abnormal usage or by excessive loading of the oven door

	⚠ WARNING
	<ul style="list-style-type: none">• ALL RANGES CAN TIP• INJURY TO PERSONS COULD RESULT• INSTALL ANTI-TIP BRACKET PACKED WITH RANGE• SEE INSTALLATION INSTRUCTIONS

Contents

General Safety Instructions	Page 8
The Cooktop	Page 10
The Broiler	Page 12
The Ovens	Page 13
The Clock	Page 14
Both ovens	Page 16
Multi-function oven	Page 17
Multi-function oven functions	Page 17
Handyrack	Page 18
Main Oven racks	Page 19
Tall oven racks	Page 19
Oven light	Page 19
Multi-function (Left hand) Oven cooking guide	Page 20
Cooking chart	Page 21
Cleaning your range	Page 22
Troubleshooting	Page 25
Service and spares	Page 27
Installation	Page 29

Read all instructions before using this appliance.

IMPORTANT SAFETY INFORMATION

Save these instructions for future reference.

WARNING

Have your appliance properly installed and grounded by a qualified technician in accordance with the National Electrical Code ANSI/NFPA No. 70—latest edition, and local code requirements.

Install only as described in the installation section of this book.

Ask your dealer to recommend a qualified technician and an authorized repair service. Know how to disconnect the power to the range at the circuit breaker or fuse box in case of an emergency.

WARNING

The anti-tip device supplied with this range must be correctly fitted when the appliance is installed. This will reduce risk of tipping of the appliance from abnormal usage or by excessive loading of the oven door.



WARNING

- ALL RANGES CAN TIP
- INJURY TO PERSONS COULD RESULT
- INSTALL ANTI-TIP BRACKET PACKED WITH RANGE
- SEE INSTALLATION INSTRUCTIONS

To avoid personal injury, do not sit, stand or lean on oven or broiler doors or drawer.

Leaning, sitting or stepping on the doors or drawer of this range can result in serious injuries and also cause damage to the range. Do not allow anyone to climb, stand or hang on any part of the range.

WARNING

To eliminate the risk of burns or fire by reaching over heated surface units cabinet storage space located above the surface units should be avoided. If cabinet storage is to be provided, the rise can be reduced by installing a range hood that projects horizontally a minimum of 5 inches (13cm) beyond the bottom of the cabinets.

WARNING

In Case of Fire

Do not use water on grease fires. Never pick up a flaming pan. Turn the controls off. Smother a flaming pan on a surface unit by covering the pan completely with a well fitting lid or baking tray. If available use a multipurpose dry chemical or foam-type fire extinguisher.

If fire is in the oven or broiler pan, smother by closing oven door. Open doors and windows or if a hood is fitted turn it on to remove smoke and odor.

To Prevent Fire or Smoke Damage

Before using the range make sure all the packing materials have been removed.

Always keep the area around the range free from combustible materials, gasoline, and other flammable vapors and liquids.

If the range is installed near a window, proper precautions should be taken to prevent curtains from blowing over the cooktop.

NEVER leave any items on the range cooktop.

The hot air from the oven or broiler vent may ignite flammable items and may increase pressure in closed containers, which may cause them to burst. Many aerosol-type spray cans are EXPLOSIVE when exposed to heat and may be highly flammable. Avoid their use or storage near an appliance.

Many plastics will burn and most are damaged by heat. Keep plastic items away from parts of

Read all instructions before using this appliance.

IMPORTANT SAFETY INFORMATION

Save these instructions for future reference.

the range that may become warm or hot. Do not leave plastic items on the cooktop as they may burn, melt or soften.

Storage should not be fitted directly above a range. If anything is stored above the range, it should be limited to infrequently used items that can be safely stored in an area subjected to heat from a range. Temperatures may be unsafe for some items, such as volatile liquids, cleaners or aerosol sprays.

Destroy the carton and plastic bags after unpacking the range. Never allow children to play with packaging material.

CAUTION

For safety considerations never use your range for warming or heating the room.

WARNING

User servicing—Do not repair or replace any part of the appliance unless specifically recommended in this User Manual.

All other servicing should be done only by a qualified technician, this may reduce the risk of personal injury and damage to the range.

Never modify or alter the construction of a range by removing leveling legs, panels, wire covers, anti-tip brackets/screws, or any other part of the product.

WARNING

Do Not Leave Children Alone

Babies, toddlers and young children should not be allowed near the range at any time. They should never be allowed to sit or stand on any part of the appliance.

Do not allow children to climb or play around the range. The weight of a child on an open door may cause the range to tip, resulting in serious burns or other injury.

Teach them not to play with controls or any other part of the range.

Never store items of interest to children in the cabinets above a range or on backguard of a range; children climbing on the range to reach them could be seriously injured.

WARNING

Do not use the oven for storage.

This instruction is based on safety considerations

Flammable materials should not be stored in an oven, the broiler chamber, the range storage drawer or near the cooktop. This includes paper, plastic and cloth items, such as cookbooks, plasticware and towels, as well as flammable liquids. Do not store explosives, such as aerosol cans, on or near the appliance.

Flammable materials may explode and result in fire or property damage.

WARNING

To avoid risk of electrical shock, personal injury, or death, make sure your range has been properly grounded and always disconnect it from main power supply before servicing.

CAUTION

Do not touch the cooktop elements or areas near the elements

The cooktop may be hot even if the elements have been off for some time. Areas near the cooktop elements may become hot enough to cause burns. During and after use, do not touch, or let clothing touch or other flammable materials contact the cooktop or areas near the elements until they have had enough time to cool. These areas include the rangetop and backguard.

Read all instructions before using this appliance.

IMPORTANT SAFETY INFORMATION

Save these instructions for future reference.



DO NOT TOUCH HEATING ELEMENTS OR INTERIOR SURFACES OF OVENS

Oven and Broiler heating elements may be hot though they are dark in color. Interior surfaces of an oven or broiler may become hot enough to cause burns. During and after use, do not touch, or let clothing or other flammable materials touch heating elements or interior surfaces of oven until they have had enough time to cool.

Other range surfaces that may become hot enough to cause burns are the oven door and oven vent at the base of the range splashback.

Wear Suitable Clothing

Never wear loose-fitting or hanging clothes while using the range. Be careful when reaching for items stored in cabinets over the cooktop. Flammable material could be ignited if brought in contact with the cooktop or hot surface and may cause severe burns.

Use Only Dry Potholders or Oven Gloves

Moist or damp potholders on hot surfaces may result in burns from steam. Never let a potholder touch hot heating elements.

Do not use a towel or other bulky cloth in place of a glove. They might catch fire if they touch a hot surface.

Use dry oven gloves when applicable - using damp gloves might result in steam burns when you touch a hot surface. Never operate the range with wet hands.



Important Safety Notice and Warning

The California Safe Drinking Water and Toxic Enforcement Act of 1986 (Proposition 65) requires the Governor of California to publish a list of substances known to the State of California to cause cancer or reproductive harm, and requires businesses to warn customers of potential exposures to such substances.

This appliance contains or produces a chemical or chemicals which can cause death or serious illness and which are known to the state of California to cause cancer, birth defects or other reproductive harm.

Users of this appliance are hereby warned that the use of the range can result in low-level exposure to some of the listed substances, including carbon monoxide primarily during the initial heating of the new range. Exposure to these substances can be minimized by properly venting the range to the outdoors.

To reduce the risk from substances make sure this appliance is installed, operated, and maintained according to the instructions in this booklet.

Important: Never keep pet birds in the kitchen or in rooms where the fumes from the kitchen could reach. Birds have a very sensitive respiratory system. Fumes released due to overheated cooking oil, fat, margarine and overheated non-stick cookware may be harmful.

Important - Save the installation instructions for the local electrical inspector's use.

Proper Installation

Be sure your appliance is properly installed and grounded by a qualified technician.



Electric cooktop

Do not cook on broken cooktop - if cooktop should break cleaning solutions and spillovers may penetrate the broken cooktop and cause a risk of electric shock. Contact a qualified technician immediately.

If you find a crack in the cooktop surface immediately disconnect the appliance from the electricity supply and arrange for its repair.

Read all instructions before using this appliance.

IMPORTANT SAFETY INFORMATION

Save these instructions for future reference.



Use the Right Size Pan

This range is equipped with cooktop elements of different sizes.

Use cookware with flat bottoms large enough to cover the heating element (marked with a ring on the cooktop). The use of undersized cookware will expose a portion of the heating element to direct contact and may result in ignition of clothing. Using the proper size cookware will also improve efficiency.

Do not use unstable pans.

Never Leave a pan unattended at high settings.

Pans boiling over can cause smoking and greasy spills may catch on fire.

Do not use aluminum foil on the cooktop.

Glazed Cooking Utensils - Only certain types of glass, glass/ceramic, ceramic, earthenware, or other glazed utensils are suitable for range-top use without breaking due to the sudden change in temperature.

Utensil handles should be turned inward and not over adjacent elements. If handles are left over adjacent elements they will get hot and may burn.

Ovens

Use Care When Opening Door

Let hot air and steam escape before removing or replacing food.

Never heat unopened food containers. Pressure build up may make container burst and cause injury.

Keep oven vent ducts unobstructed.

Placement of Oven Racks

Always place oven racks in desired location while oven is cool. If rack must be moved while oven is hot, do not let a potholder contact hot heating elements in oven.

Protective Liners - Do not use aluminum foil to line oven bottoms. Foil liners may result in a risk of electric shock, or fire and will damage the enamel finish. Never allow aluminum foil to contact the heating elements.

CAUTION

Do not store items of interest to children in cabinets above a range or on the backguard of a range - children climbing on the range to reach items could be seriously injured.

User Servicing

Do not repair or replace any part of the appliance unless specifically recommended in the manual. All other servicing should be referred to a qualified technician.

WARNING

THIS APPLIANCE IS PROVIDED WITH ROLLERS TO FACILITATE MOVEMENT DURING INSTALLATION. THE RANGE SHOULD NOT BE MOVED AFTER INSTALLATION.



Cleaning

Clean cooktop with caution – if a wet sponge or cloth is used to wipe spills on a hot cooking area be careful to avoid steam burn – some cleaners can produce noxious fumes if applied to a hot surface.

Read all instructions before using this appliance.

IMPORTANT SAFETY INFORMATION

Save these instructions for future reference.

General Safety Instructions

This appliance must be installed by a competent person in accordance with the installation instructions. The installation must comply with the relevant regulations and also the local electricity supply company requirements

This appliance is designed for domestic cooking only. Use for any other purpose could invalidate any warranty or liability claim.

The use of a cooking appliance results in the production of heat and moisture in the room in which it is installed. Ensure that the kitchen is well ventilated: keep natural ventilation holes open or install a mechanical ventilation device, (mechanical extractor hood).

Prolonged intensive use of the appliance may call for additional ventilation, for example opening a window, or more effective ventilation, for example increasing the level of mechanical ventilation where present. Use extractor fans or hoods when fitted.

The range should be serviced by a qualified service engineer and only approved spare parts used. Have the installer show you the location of the range control switch. Mark it for easy reference. Always allow the range to cool and then switch off at the mains before cleaning or carrying out any maintenance work, unless specified otherwise in this guide.

All parts of the range become hot with use and will retain heat even after you have stopped cooking.

Take care when touching range, to minimize the possibility of burns, always be certain that the controls are in the OFF position and that it is cool before attempting to clean the range.

In the interests of hygiene and safety the range should be kept clean at all times as a build up in fats and other food stuff could result in a fire.

Clean with caution. If a wet sponge or cloth is used to wipe spills on a hot surface, be careful to avoid steam burns. Some cleansers can produce noxious fumes if applied to a hot surface.

Clean only parts listed in this guide.

Always keep combustible wall coverings or curtains etc. a safe distance away from your range.

Do not spray aerosols in the vicinity of the range while it is in use.

Do not store or use combustible materials, or flammable liquids in the vicinity of this appliance.

Take great care when heating fats and oils, as they will ignite if they get too hot.

Use a deep fat thermometer whenever possible to prevent overheating fat beyond the smoking point.

Never leave a deep fry pan unattended. Always heat fat slowly, and watch as it heats. Deep fry pans should be only one third full of fat. Filling the pan too full of fat can cause spill over when food is added. If you use a combination of oils or fats in frying, stir them together before heating, or as the fats melt.

Foods for frying should be as dry as possible. Frost on frozen foods or moisture on fresh foods can cause hot fat to bubble up and over the sides of the pan. Carefully watch for spills or overheating of foods when frying at high or medium high temperatures. Never try to move a pan of hot fat, especially a deep fry pan. Wait until the fat is cool.

When the broiler is on, do not use the top of the flue (the slot along the back of the range) for warming plates, dishes, drying dish towels or softening butter.

Read all instructions before using this appliance.

IMPORTANT SAFETY INFORMATION

Save these instructions for future reference.

When using an electrical appliance near the cooktop, be sure that the cord of the appliance does not come into contact with the cooktop.

Take care that no water seeps into the appliance

The range is designed for cooking foods only and must not be used for any other purpose.

The oven should NOT be used for heating the kitchen, not only does this waste fuel but the control knobs may become overheated.

When the oven is on DO NOT leave the oven door open for longer than necessary.

When the range is not in use ensure that the control knobs are in the off position.

The specification of this range should not be altered.

This appliance is heavy, take care when moving it.

Using your Range

The Cooktop

When you cook on a electric cooktop its very important to use the right sort of pans...

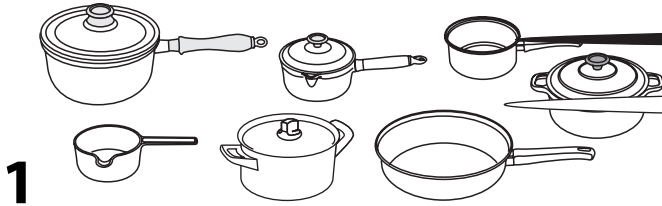

1

Use only pans that are suitable for electric cooktops. We recommend stainless steel and enameled steel pans because pots and pans with copper or aluminum bases leave traces on the cooktop that are difficult to remove. Glass-ceramic cookware and stoneware are not suitable because of their poor conductivity.

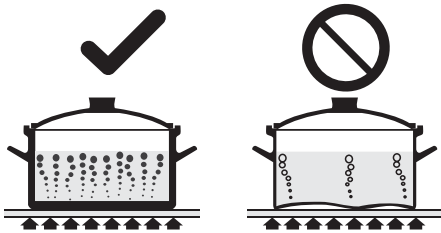

2

Pots and pans should have thick, smooth, flat bottoms. This ensures that there is the maximum heat transfer from the cooktop to the pan, making cooking quick and energy efficient.

Never use a round bottomed Wok even with a stand.

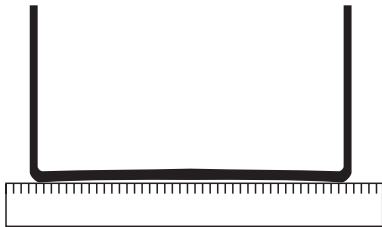

3

The very best pans have bases that are very slightly curved in when cold. If you hold a ruler across the bottom you will see a small gap in the middle. When they heat up the metal expands and lies flat on the cooking surface.

Make sure that the base of the pan is clean and dry to prevent any residue burning onto the cooktop panel. This also helps prevent scratches and deposits (such as lime specks).

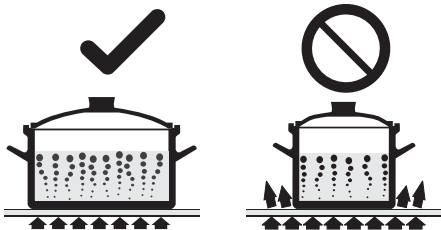

4

Always use pans that are the same size as (or slightly larger than) the areas marked on the cooktop top. Using smaller pans wastes heat, and any spillage will be burnt on. Using a lid will help the contents boil more quickly.

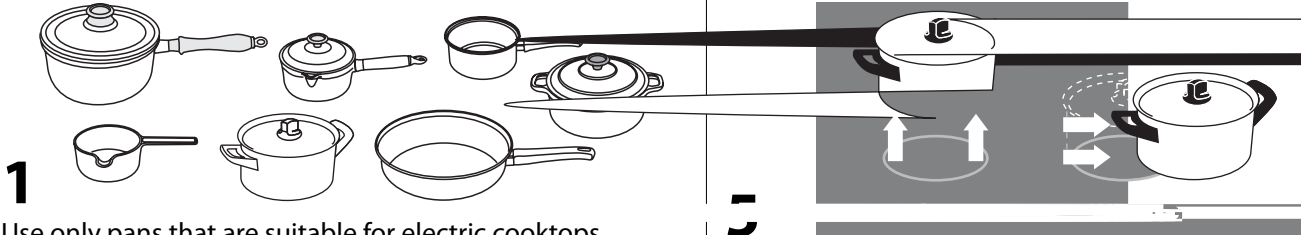

5

Always lift pans off the cooktop. Sliding pans may cause marks and scratches. Always turn the control to the off position before removing a pan.

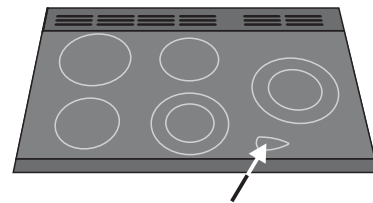

6

There are indicator lights for each of the cooking areas. These come on when a cooktop control is turned on and stay lit while the surface cools.

Always take care before touching the surface even when it is turned off - it may be hotter than you think.

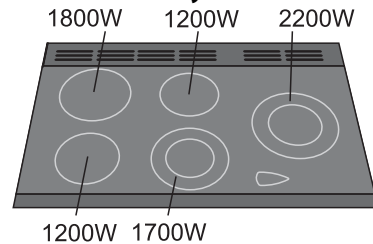

7

The ratings of the cooking areas are shown on the diagram above.

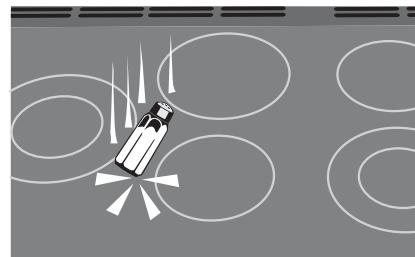

8

Although the cooktop surface is very strong, a heavy or sharp falling object (a salt shaker for example) might cause the surface to crack.

If you find a crack in the surface immediately disconnect the appliance from the supply and arrange for its repair.

Care should be taken that no water seeps into the appliance.

9

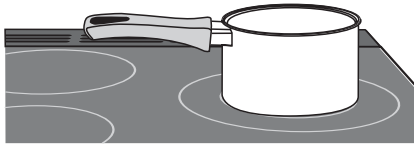

The areas marked with two concentric circles have an inner and an outer element. Push in and turn the control knob clockwise to heat the whole area for larger pans - push in and turn it the other way (counter clockwise) to just heat the inner part for smaller pans.

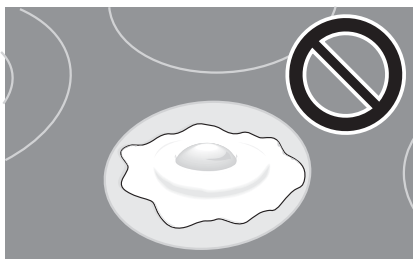
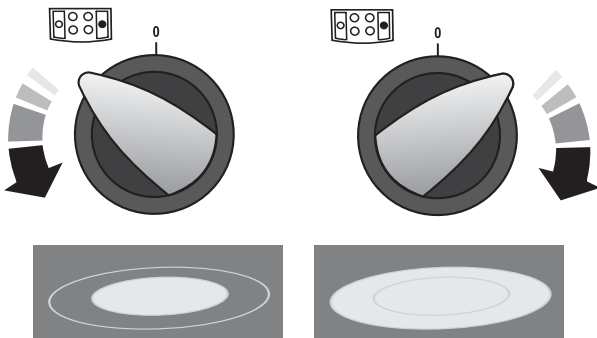

10

Never cook directly on the surface.

The kind of pan you use and the quantity of food affects the setting required. Higher settings are required for larger quantities of food.

Naturally, the surface must be washed after use in order to prevent it from becoming scratched or dirty.

Only scratches in the cooktop surface reported within 14 days of range installation are covered by the warranty. Scratches caused by usage are not covered.

When cooking on the cooktop you may see the cooktop area you are using switch off and on. This is caused by a safety device that limits the temperature of the cooktop. It is quite normal, especially when cooking at high temperatures. If it happens a lot with a particular pan however it may mean the pan is not suitable – perhaps too small or too uneven - for a ceramic cooktop.

Clean with caution. If a wet sponge or cloth is used to wipe spills on a hot surface, be careful to avoid steam burns. Some cleansers can produce noxious fumes if applied to a hot surface.

Sugar spillage will permanently damage the cooktop and therefore must be cleaned off with care immediately. Never let sugar spillage cool before trying to remove it.

If sugar or foods with high sugar content, aluminum foil or plastic items are accidentally allowed to melt on the cooktop surface remove them immediately from the hot cooking area using a scraper to avoid any possible damage to the surface. See 'Cleaning your range'.

Never cut directly on the cooking surface.

Don't cook directly on the cooktop surface i.e. without a pan or utensil

Don't use the cooktop as a work surface

Don't drag or slide utensils across the cooktop surface

Don't place anything between the base of the pan and the cooktop surface (i.e. asbestos mats, aluminum foil, Wok stand)

Don't leave utensils, foodstuffs or combustible items on the cooktop when it is not in use. (e.g. towels, fry pans containing oil)

Don't place plastic or aluminum foil, or plastic containers on the cooktop

Don't leave the cooktop zones switched on unless being used for cooking

Don't place large preserving pans or fish kettles across two heating zones

Don't place utensils partly covering a heating zone. Always place utensils centrally.

Never allow anyone to climb or stand on the cooktop

Using your Range

The Broiler

Before using for the first time, to dispel manufacturing odors, turn on the broiler and run for 30 minutes with the broiler pan in position. To clear the smell make sure the room is well ventilated to the outside air, by opening windows for example.

Caution: Accessible parts may be hot when the broiler is in use. Young children should be kept away.

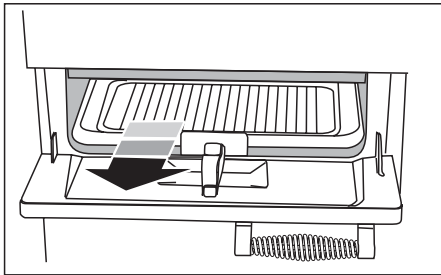

Remove the pan from the bottom of the broiler compartment.

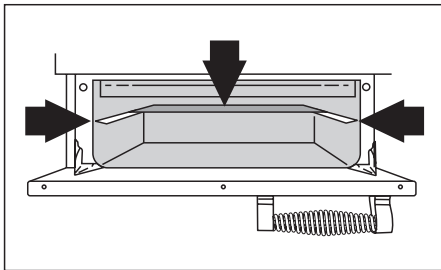

After placing your food on the broiler pan grid, slide the broiler pan onto the side supports just below the elements. Make sure it is pushed right in and touches the backstop.

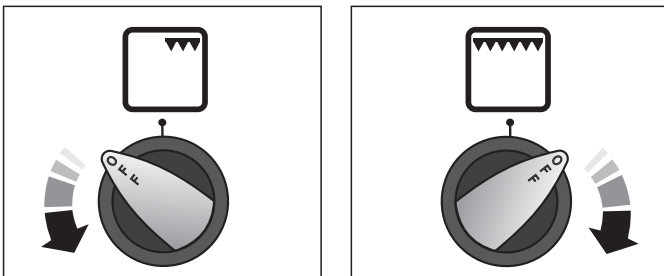

The broiler has two elements that allow either the whole area of the pan to be heated or just the right hand half. Turn the knob to position 3.

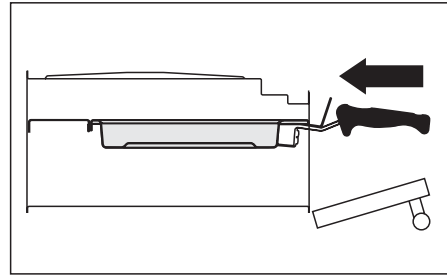

For best results preheat for 2 minutes with the broiler pan in position. After placing your food on the broiler pan grid, slide the broiler pan onto the side supports. Adjust the heat to suit by turning the knob.

Make sure it is pushed right in and touches the back stop.

NEVER CLOSE THE BROILER DOOR WHEN THE BROILER IS ON.

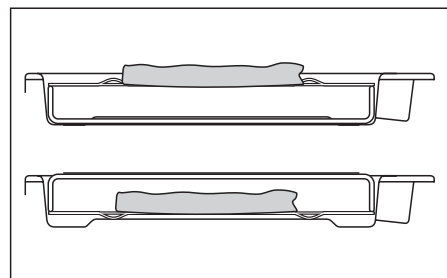

The broiler pan grid can be turned over to give two cooking positions.



Don't leave the broiler on for more than a few moments, without the broiler pan underneath it.

For best results, especially with toast, preheat the broiler with the broiler pan in the cooking position for two minutes before use.

The broiler grid can be removed and the food placed on it while you are waiting for the broiler to preheat.

The broiler pan grid can be turned over to give two cooking positions.

You can brown the top of dishes cooked in the oven, under the broiler by placing the dish onto the base of the broiler pan, which can easily slide along the floor of the broiler cavity.

The clock must be set to the time of day before the ovens will work. See 'The Clock' section for instructions on setting the time of day.

Before using for the first time, to dispel manufacturing odors turn the ovens to 400°F (204°C) and run for an hour. To clear the smell make sure the room is well ventilated to the outside air, by opening windows for example.

During use the appliance becomes hot. Care should be taken to avoid touching the heating elements inside the oven.

The Left Hand Multi-function Oven

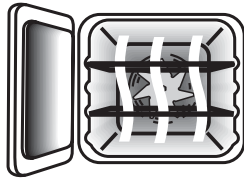

The left hand oven is a Multi-function oven. As well as the oven fan and fan element, it is fitted with two extra heating elements, one visible in the top of the oven and the second under the oven base. Take care to avoid touching the top element and element deflector when placing or removing items from the oven. For more detail on this oven see the section 'Multi-function oven'.

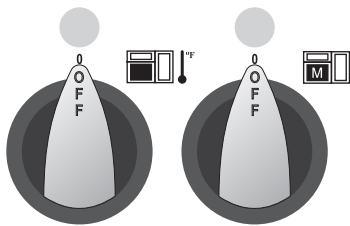

temperature

function

The Multi-function oven has two controls, a function selector and a temperature setting knob.

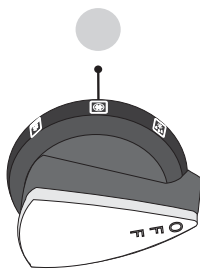

Turn the function selector control to a cooking function. This is the fan oven setting.

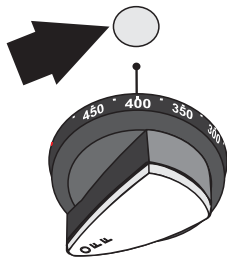

Turn the oven temperature knob to the temperature you need.

The oven heating neon will glow until the oven has reached the temperature you selected. It will then cycle on and off during cooking as the oven maintains the selected temperature.

The Right Hand Tall Oven

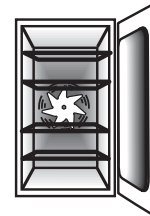

The fan in the right hand Tall oven circulates hot air continuously, which means faster more even cooking. The recommended cooking temperatures for a fanned oven are generally lower than a non-fanned oven.

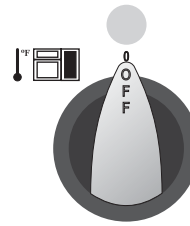

The right hand fan oven control is at the right hand end of the control panel.

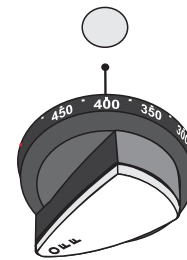

Turn the oven temperature knob to the temperature you need.

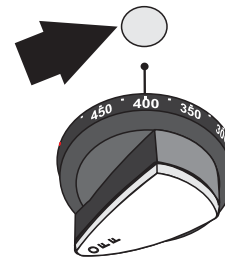

The oven heating neon will glow until the oven has reached the temperature you selected. It will then cycle on and off during cooking as the oven maintains the selected temperature.



Clock Special Features

Key Lock

When the key lock is activated, the clock can be operated as usual but the ovens are locked and will not come on. This means that your child could select a cook program but the program will not be activated and ovens will not switch on.

To activate the key lock

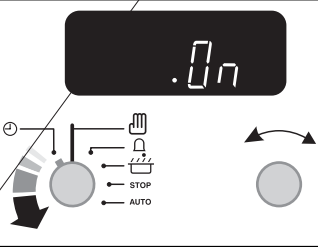
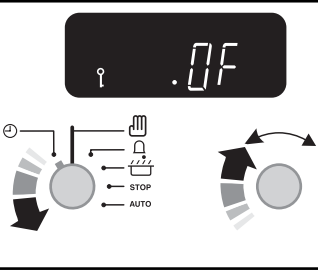
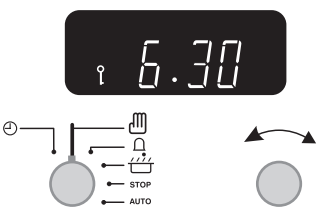
<p>Turn and hold the Setting knob to the clock symbol (⌚) for about 8 seconds. 'On' will appear on the display.</p>	
<p>Keep holding the Setting knob turned to the clock symbol (⌚) and turn the Adjusting knob clockwise until the key symbol (🔑) and 'Of' shows on the display. Let go of the knobs.</p>	
<p>The ovens are now locked. After a few seconds the display will revert to show the time of day and the key symbol.</p>	

To turn off the key lock

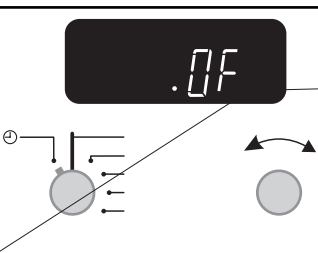
<p>Turn and hold the Setting knob to the clock symbol (⌚) for about 8 seconds. 'Of' will appear on the display.</p>	
<p></p>	<p></p>
<p></p>	<p></p>

Turn the Setting knob to the (STOP) position.
The display will show the current time of day plus the 'cook period' you just set.

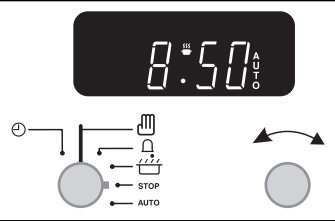

Use the adjustment knob to set the 'Stop time' you need.
'Stop Time' shows.
AUTO will show in the display.

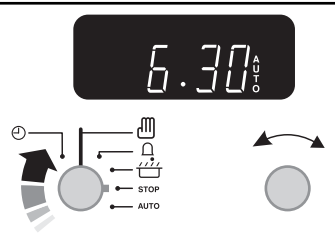

Set the oven(s) to the cooking temperature you need (don't forget to set a function if using the Multi-function oven).

Turn the Setting knob to the (auto) setting.
The clock shows the time of day and 'AUTO'.

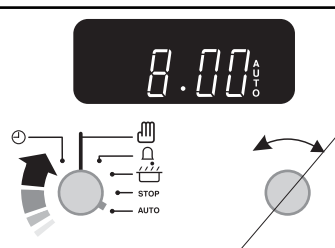

When your cooking is finished the beeper sounds. Turn the Setting knob to the vertical (🔑) to return to manual cooking.

If you are out, don't worry about the beeper going off, it stops after a short while. When you return, turn the Setting knob to the vertical (🔑) to return to manual cooking. Turn the thermostat to the off position.

AUTO is showing, you want to reset to manual cooking.

You can cancel any automatic settings by briefly turning the Setting knob to the manual symbol (🔑).

Using your Range

Cooking using the timer (Delayed baking)

The timer can be used to turn just one oven or both on and off automatically. The start and stop time must be the same for both ovens but different cooking temperatures can be set.

If you want to turn one of the ovens on at the same time as the timer is set for automatic cooking, you must wait until the timer has turned on the oven/ ovens first. Then you can adjust either of them manually in the normal way.

You can set the oven for a combined delay and cook cycle of up to 11 hours 59 minutes.

If you want to cook more than one dish, choose dishes that require approximately the same time. However, dishes can be 'slowed down' slightly by using small containers and covering them with aluminum foil, or 'speeded up' slightly by cooking smaller quantities or placing in larger containers.

Very perishable foods such as pork, dairy products or seafood should be avoided if a long delay period is planned, especially in hot weather.

Don't place warm food in the oven.

Don't use an oven already warm.

Don't use if an adjoining oven is warm.

Avoid using wine or beer if there is a delay period, as fermentation may take place.

To avoid curdling, cream should be added to dishes just before serving.

Fresh vegetables, which may discolor during a delay period, should be coated in melted fat or immersed in a water and lemon juice solution.

Fruit pies, custard tarts or similar wet mixtures on top of uncooked pastry are only satisfactory if there is a short delay period. Dishes containing leftover cooked meat or poultry should not be cooked automatically if there is a delay period.

Whole poultry must be thoroughly defrosted before placing in the oven.

Check that meat and poultry are fully cooked before serving.

Automatic cooking is not recommended for baked items that require a pre-heated oven such as cakes, cookies and breads.

Both ovens

Before using for the first time, to dispel manufacturing odors turn the ovens to 400°F (204°C) and run for an hour. To clear the smell make sure the room is well ventilated to the outside air, by opening windows for example.

The wire racks should always be pushed firmly to the back of the oven.

Bakeware, meat pans etcetera should be placed level centrally on the oven's wire racks. Keep all trays and containers away from the sides of the oven, as overbrowning of the food may occur.

For even browning, the maximum recommended size of a baking sheet is 11 ³/₈" x 13" in the main oven and 9" x 12 ¹/₂" in the Tall oven.

Cooking high moisture content foods can create a 'steam burst' when the oven door is opened. When opening the oven stand well back and allow any steam to disperse.

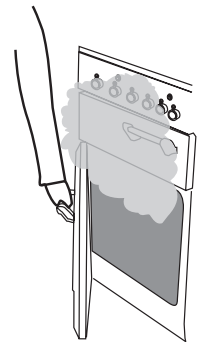

When the oven is on, don't leave the door open for longer than necessary, otherwise the knobs may get very hot.

- Always leave a 'fingers width' between dishes on the same rack. This allows the heat to circulate freely around them.
- Cover meat when cooking to avoid fat splashes.



- To reduce fat splashing when you add vegetables to hot fat around a roast, dry them thoroughly or brush lightly with cooking oil.
- Sufficient heat rises out of the oven while cooking to warm plates in the broiler compartment.
- If you want to brown the base of a pastry dish, preheat the baking sheet for 15 minutes before placing the dish in the centre of the sheet or use the base heat in the Multifunction oven.
- Where dishes may boil and spill over during cooking, place them on a baking sheet.

Multi-function oven

The left hand oven of your range is Multi-function. It has many varied uses. We suggest you keep a careful eye on your cooking until you are familiar with each function. Remember - not all functions will be suitable for all food types.

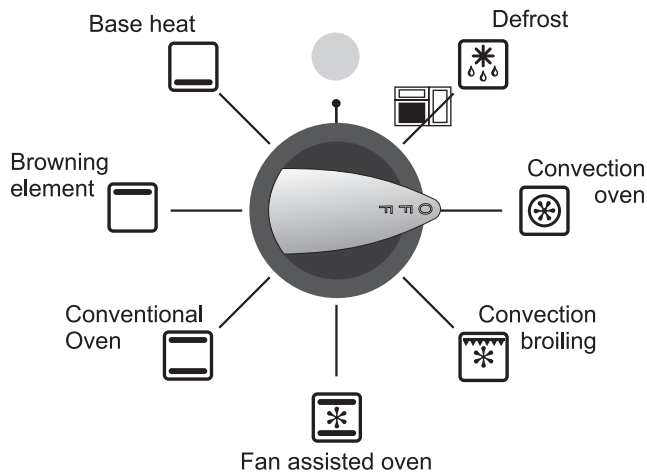

Please remember that all ranges vary - temperatures in your new ovens may differ to those in your previous range.

Multi-function oven functions



Defrost

This function operates the fan to circulate cold air only. No heat is applied. This enables small items such as desserts, cream cakes and pieces of meat, fish and poultry to be defrosted.

Defrosting in this way speeds up the process and protects the food from flies. Pieces of meat, fish and poultry should be placed on a rack, over a tray to catch any drips. Be sure to wash the rack and tray after defrosting.

Defrost with the oven door closed.

Large items, such as whole chickens and meat roasts should not be defrosted in this way. We recommend this be carried out in a refrigerator.

Defrosting should not be carried out in a warm oven or when an adjoining oven is in use or still warm.

Ensure that dairy foods, meat and poultry are completely defrosted before cooking.



Convection oven

This function operates the fan and the heating element around it. An even heat is produced throughout the oven, allowing you to cook large amounts quickly.

Fan oven cooking is particularly suitable for multi-rack cooking and is a good 'all-round' function. It may be necessary to reduce the temperature by approximately 20°F for recipes previously cooked in a conventional oven.

If you wish to pre-heat the oven, wait until the indicator light has gone out before inserting the food.



Convection broiling

This function operates the fan whilst the top element is on. It produces a more even, less fierce heat than a conventional broiler. For best results, place the food to be cooked, on a grid over a roasting tin, which should be smaller than a conventional broiler pan. This allows greater air circulation. Thick pieces of meat or fish are ideal for cooking in this way, as the circulated air reduces the fierceness of the heat from the broiler. The oven door should be kept closed whilst cooking is in progress, so saving energy. You will also find that the food needs to be watched and turned less than for normal broiling. Pre-heat this function before cooking.



Fan assisted oven

This function operates the fan, circulating air heated by the elements at the top and the base of the oven. The combination of fan and conventional cooking (top and base heat) makes this function ideal for cooking large items that need thorough cooking, such as a large meat roast. It is also possible to bake on two racks at one time, although they will need to be swapped over during the cooking time, as the heat at the top of the oven is greater than at the base, when using this function.

This is a fast intensive form of cooking; keep an eye on the food cooking until you have become accustomed to this function.

Using your Range



Conventional oven (top and base heat)

This function combines the heat from the top and base elements. It is particularly suitable for roasting and baking pastry, cakes and biscuits. Food cooked on the top rack will brown and crisp faster than on the lower rack, because the heat is greater at the top of the oven than at the base, as in 'Convection assisted oven' function. Similar items being cooked will need to be swapped around for even cooking. This means that foods requiring different temperatures can be cooked together, using the cooler zone in the lower half of the oven and hotter area to the top.



Browning element

This function uses the element in the top of the oven only. It is a useful function for the browning or finishing of pasta dishes, vegetables in sauce and lasagne, the item to be browned being already hot before switching to the top element.



Base heat

This function uses the base element only. It will crisp up your pizza or quiche base or finish off cooking the base of a pastry case on a lower rack. It is also a gentle heat, good for slow cooking of casseroles in the middle of the oven or for plate warming.

The Browning and Base heat functions are useful additions to your oven, giving you flexibility to finish off items to perfection. With use, you will soon realize how these functions can combine to extend your cooking skills.

Handyrack

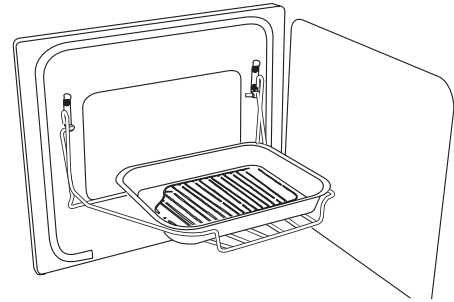

The maximum weight that can be held by the Handyrack is 12lb (5.5kg). It should only be used with the supplied meat tin, which is designed to fit the Handyrack. Any other vessel could be unstable.

The Handyrack fits on the oven door. Food cooking on it is easy to attend to, because it's accessible when the door is open. It can be fitted at two different heights. One of the oven racks must be removed and the other positioned to suit.

When the Handyrack is used in its highest position, other dishes can be cooked on the bottom shelf position of the oven or standing on the base of the oven

When the Handyrack is used in its lowest position, other dishes can be cooked on the second rack position of the oven or standing on the base of the oven.

To fit the Handyrack, locate one side of it on the door bracket.

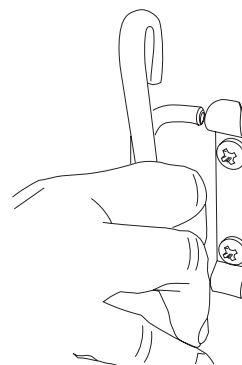
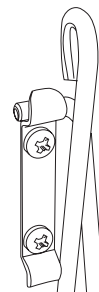

Then spring the other side out to clip it onto the other bracket.

Main Oven racks

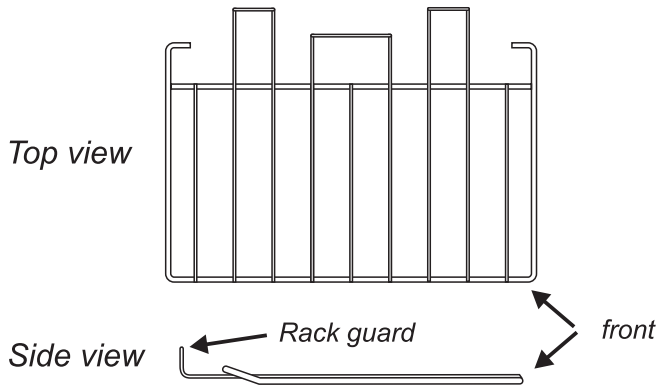

the rack guard should be at the back pointing upwards

As well as the flat racks some models are supplied with drop racks. The drop racks increase the possibilities for oven rack spacing.

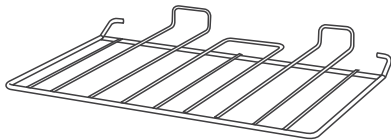

flat rack

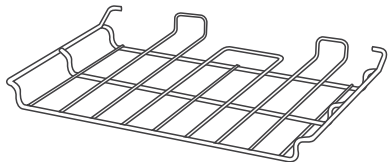

drop rack

The oven racks can be easily removed and refitted.

Pull the rack forward until the back of the rack is stopped by the rack stop bumps in the oven sides.

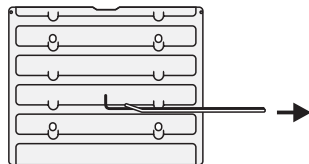

Lift up the front of the rack so the back of the rack will pass under the rack stop and then pull the rack forward.

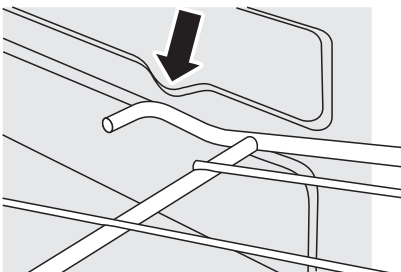
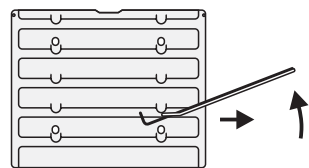

To refit the rack, line up the rack with a groove in the oven side and push the rack back until the ends hit the rack stop. Lift up the front so the rack ends clear the rack stops, and then lower the front so that the rack is level and push it fully back.

Tall oven racks

The tall oven is supplied with four normal cooking racks

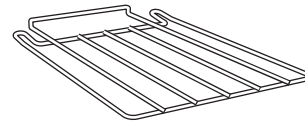

and a plate warming rack.

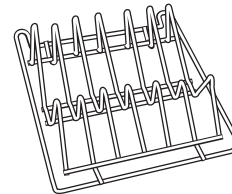

When using the tall oven you can cook on all four racks at the same time; but make sure they are well spaced out to allow the hot air to circulate.

Steam

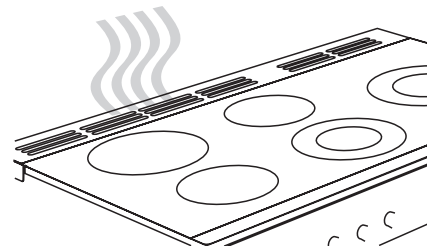

When cooking foods with high water content (e.g. oven fries) there may be some steam visible at the grille at the rear of the cooktop. This is perfectly normal.

Oven light



Press the button to turn on the Main oven light.

If the oven light fails, turn off the power supply before you change the bulb. See the 'Troubleshooting' section for details on how to change an oven light bulb.

Cooking chart



Food	Conventional Oven		Convection Oven	Approximate Cooking Time
	Temp	Rack Position	Temp	
FISH				
	375°F	3	350°F	Fillets 15-20mins.
	375°F	3	350°F	Whole 10mins.per lb + 10mins.
	375°F	3	350°F	Steaks according to thickness.
ROAST MEATS				
Beef with bone	325°F	2-3	300°F	20-25mins. per lb + 20-25mins.
	400°F	2-3	375°F	15-20mins. per lb + 15-20mins.
Beef without bone	325°F	2-3	300°F	30-35mins. per lb + 30-35mins.
	400°F	2-3	375°F	20-25mins. per lb + 20-25mins.
Lamb	325°F	2-3	350°F	30-35mins. per lb + 30-35mins.
	400°F	2-3	375°F	25-35mins. per lb + 25-30mins.
Pork	325°F	2-3	300°F	35-40mins. per lb + 35-40mins.
	400°F	2-3	375°F	25-30mins. per lb + 25-30mins.
Stuffed and rolled - Add approx. 10 mins. per lb to above cooking times or cook at 390°F for 20mins. then 320°F for remainder.				
THOROUGHLY THAW FROZEN MEAT AND POULTRY BEFORE COOKING.				
POULTRY				
Chicken	325°F	2-3	300°F	20-25mins. per lb + 20-25mins.
	400°F	2-3	375°F	15-20mins. per lb + 15-20mins.
Turkey	325°F	1-3	300°F	20-25mins. per lb + 20-25mins.
	400°F	1-3	375°F	15-20mins. per lb + 15-20mins.
Stuffed Poultry - Cook at 390°F or at 390°F for 20mins. then 320°F for remainder. Prepacked (fresh or frozen) follow packers cooking times				
Casserole	300-325°F	2-3	300°F	2-4hrs according to recipe.
Yorkshire Pudding	425°F	4	400°F	Large tin 30-35mins. Individual 10-20mins.
CAKES				
Rich fruit (7")	300°F	2	275°F	2 1/2-3hrs.
Cup Cakes	375°F	3 & 5 or 3	350°F	15-25mins.
Scones (British)	425°F	2 & 4 or 3	400°F	10-15mins.
PASTRY				
Plate Tart	375°F	2 & 4	350°F	45-50mins. Interchange after 25mins.
Fruit Pie	375°F	2 & 4	350°F	35-40mins. Interchange after 25mins.
Tartlets	375°F	4	350°F	15-20mins. according to size.
Puff Pastry	425°F	2,3 or 4	400°F	20-40mins. according to size.
Bread	425°F	2 & 4	400°F	20-30mins. according to size.
Meringues	230°F	3	225°F	2-2 1/2hrs. according to size.
PUDDINGS				
Baked Egg Custard	325°F	3	300°F	45mins.-1hr.
Baked sponge pudding	375°F	3	350°F	40-45mins. according to size.

Using your Range

Cleaning your range

Essential information

Before thorough cleaning isolate the electricity supply. Remember to switch on the electricity supply before use.

Never use paint solvents, washing soda, caustic cleaners, biological powders, bleach, chlorine based bleach cleaners, coarse abrasives or salt. Don't mix different cleaning products - they may react together with hazardous results. Recommended cleaning materials are shown in the table at the end of this section.

All parts of the range can be cleaned with hot soapy water - but take care that no surplus water seeps into the appliance.

For cleaning materials see the 'Cleaning Table' at the end of this section.

Cooktop

Clean with caution. If a wet sponge or cloth is used to wipe spills on a hot surface, be careful to avoid steam burns. Some cleansers can produce noxious fumes if applied to a hot surface.

It's very easy to clean the Cooktop with a recommended cleaner.

CAUTION — Do not use abrasive cleaners or pads, oven aerosols or pads or stain removers on the surface.

Daily care

First of all, be sure that all heat indicator lights are off and the cooking surface is cool. Apply a small dab, about the size of a coin, of electric cooktop cleaning cream in the center of each area to be cleaned. Dampen a clean paper towel and work the cleaning cream on the cooking surface as if you were cleaning a window. As a final step, wipe the cooking surface with a clean, dry paper towel.

Cleaning for spills

For spills and boil-overs that occur while cooking, turn the unit off and wipe the area surrounding the hot zone with a clean paper towel. If a spill (other than a sugary substance) is on the hot zone, do not clean until the unit is completely cooled down and follow the instructions below ("Cleaning for burned-on spills"). If you accidentally melt anything on the cooking or if you spill foods with a high sugar content (preserves, tomato sauce, etc.), REMOVE the spill IMMEDIATELY with a razor scraper, while the unit is still hot.

IMPORTANT: Turn off the cooktop and use an oven glove to protect your hand from potential burns. Take care when using a sharp scraper.

Scrape the major spill or melted material from the cooking zone and push into a cold area, and then allow to cool before cleaning further. After the cooking surface cools down and the heat indicator lights go off, use the daily care procedure as outlined above.

Cleaning for burned-on spills

Be sure that the heat indicator lights are off and the cooktop is cool. Remove excess burned-on substance with a single-edged razor scraper. Hold the scraper at approximately a 30° angle to the surface and scrape off the burned-on matter as you would scrape paint off of a window.

IMPORTANT: Take care when using a sharp scraper.

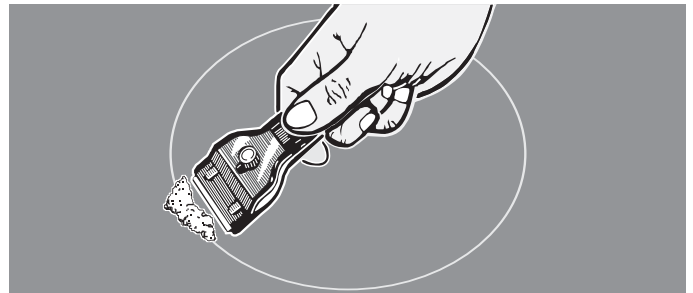

When you have removed as much as possible with the scraper clean using the daily care procedure as described above.

To remove metal rub-off

Sliding pans on the cooktop - especially aluminum or copper pans can leave marks on the surface. These marks often appear like scratches, but can be easily removed using the procedure described above for cleaning spills. If the rub-off marks are especially stubborn, use the cleaning cream together with the razor scraper, using the technique described above.

Broiler

The broiler pan and grid should be washed in hot soapy water. After cooking meats or any foods that soil, leave to soak for a few minutes in the sink immediately after use. Stubborn particles may be removed from the grid by using a nylon brush.

Cleaning chart

All Parts listed here can be cleaned using hot soapy water (dishwashing liquid detergent) and a soft cloth. For more difficult cleaning, follow the appropriate instruction. Check cleaner manufacturers guidelines for compatibility with the material of your range.

Part	Finish	How to clean
Electric Cooktop	Glass with anodised aluminum surround.	Remove any dried baked on food deposits from the cooktop glass with a electric cooktop scraper, available from electrical retailers. Clean with CooktopBrite Homecare Products or Easy-Do Cooktopcare Ceramic and Halogen Cooktop Cleaner and Conditioner Easy-Do Products Ltd and polish with a soft cloth. Do not use cleaners intended for the electric glass cooktop on the matt finished metal cooktop frame. Only use hot soapy water and a soft cloth on the area around the electric glass cooktop.
Sides, Plinth	Painted surface	Hot soapy water and soft cloth.
Control Panel	Porcelain Enamel	Non-abrasive cleaner, soft cloth.
Oven liners, roof and floor, door interior	Porcelain Enamel	Branded oven cleaner suitable for enamel surfaces.
Door Handles	Chrome/Plastic	Non-abrasive cleaner, hot soapy water, soft cloth
Broiler Grid, Handyrack Oven Racks	Chrome	Dishwasher. Hot soapy water and scouring pad.
Meat tin	Porcelain Enamel	Scouring Pad, hot soapy water. Dishwasher
Broiler Pan	Porcelain Enamel	Mildly abrasive cleaner Scouring Pad
Door surround	Porcelain Enamel	Mildly abrasive cleaner such as Bon-Ami® or Soft Scrub® with a soft cloth. Take care to not damage rubber door seal.
Outer Doors and Drawer	Porcelain Enamel	Multi-surface Cleaner, soft cloth

Carefully read and follow the manufacturers instructions on cleaning products.

Using your Range

Control Panel

The control panel and control knobs should only be cleaned with a soft cloth wrung out in clean hot soapy water - but take care that no surplus water seeps into the appliance. Wipe with a clean dampened cloth then polish with a dry cloth.

Oven Doors

The Legacy range is available with either solid doors or window doors.

The oven doors should only be cleaned with a soft cloth wrung out in clean hot soapy water.

Models with Main oven window door

The Main oven door is triple glazed but the oven door front panel can be taken off so that the inside faces of the glass panels can be cleaned.

If necessary move the range forward to gain access to the sides of the door (see the 'Moving the range' section of these instructions).

The door front panel is held by two fixing screws on each side.

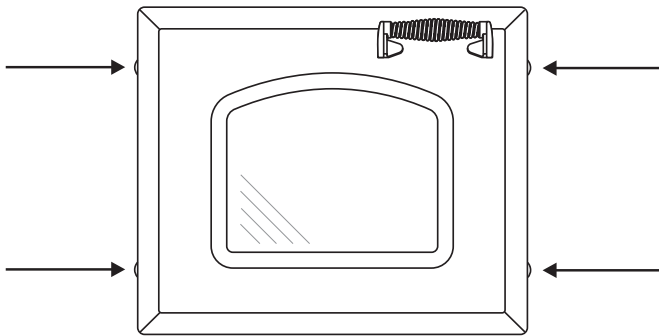

The fixing screws have a recessed hexagon socket in the head. A hexagon key to fit the screw is supplied in the instruction pack.

Open the oven door slightly and use the key to remove the front panel fixing screws from the door sides (two each side).

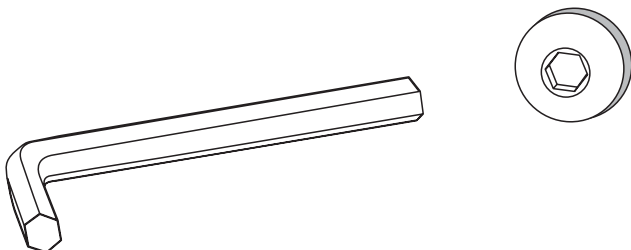

Carefully lift off the outer door panel. The inside face of the glass panels can now be cleaned - take care not to disturb or wet the door insulation. Please note that the door is triple glazed but the inner two panels are fixed. Do not try to remove the glass from the door.

After cleaning carefully refit the outer door panel and replace the side fixing screws.

Main Oven

The main oven side lining panels can be removed for cleaning and for cleaning behind. They can also be put into a dishwasher. Remove the racks first. Each side of the oven is fixed with four fixing screws. You don't have to remove the screws to remove the oven linings. Lift each side panel upwards and they will slide off the screws. Then pull them forwards.

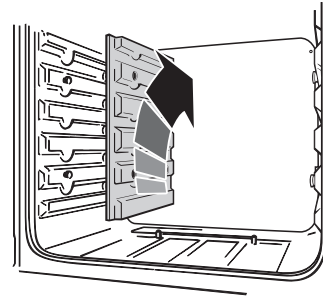

Once the linings are removed, the oven enamel interior can be cleaned.

When replacing the linings fit the side linings first.

Some models also have porcelain enameled oven floor liners in the Main oven. These can be easily slid out for cleaning.

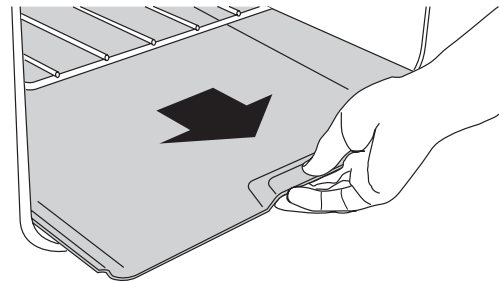

The Tall Oven

To clean the oven sides slide out the racks, unhook the supports from the oven sides and lift out.

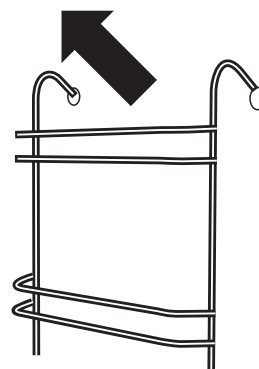

Troubleshooting

A crack has appeared in the Cooktop surface
Disconnect the range immediately from the power supply and arrange for its repair. Don't use the range until after the repair.

See the "Service and spares" section for information about service.

My Cooktop is scratched

Only scratches in the cooktop surface reported within 14 days of range installation are covered by the warranty. Scratches caused by usage are not covered.

Have you used the correct cleaning methods?

Pots and pans with rough bottoms, or coarse particles (salt or sand) between the pan and the surface of the cooktop may cause scratches.

Use the recommended cleaning methods. Make sure pan bottoms are smooth and clean. Tiny scratches are not removable but will become less visible in time as a result of cleaning.

Metal markings on the Cooktop

Do not slide aluminum or copper pans across the surface. Marks from aluminum and copper pans as well as mineral deposits from water or food can be removed with the cleaning cream.

Steam is coming from the oven

When cooking foods with a high water content (e.g. oven fries) there may be some steam visible at the rear grille. Take care when opening the oven door, as there may be a momentary puff of steam when the oven door is opened. Stand well back and allow any steam to disperse.

The oven fan is noisy

The note of the oven fan may change as the oven heats up - this is perfectly normal.

What cleaning materials are recommended for the range?

See the 'Cleaning' section for a full list of recommended cleaning materials. We do not recommend corrosive or caustic cleaners as these may damage your range.

The knobs get hot when I use the oven or the broiler, can I avoid this?

Yes, this is caused by heat rising from the oven or the broiler, and heating them up. Don't leave the oven door open. Make sure that the broiler pan is pushed right back to the 'backstop' when broiling.

If there is an installation problem and I don't get my original installer to come back to fix it who pays?

You do. Service organizations will charge for their call outs if they are correcting work carried out by your original installer. It's in your interest to track down your original installer.

Current Operated Ground Fault Circuit Breaker

Where the range installation is protected by a 30 milliamp sensitivity residual current device (RCD), the combined use of your range and other domestic appliances may occasionally cause nuisance tripping. In these instances the range circuit may need to be protected by fitting 100mA device. This work should be carried out by a qualified electrician.

Food is cooking too slowly, too quickly, or burning

Cooking times may differ from your previous oven. Check that you are using the recommended temperatures and rack positions. See pages 16 -17. The oven control settings and cooking times are intended to be used only as a guide. Individual tastes may require the temperature to be altered either way, to get the results you want. Try cooking at a higher temperature setting. Is the oven roof in?

The oven is not cooking evenly

Do not use a tin or tray larger than 11 ³/₈" x 13" in the main oven or 9" x 12 ¹/₂" in the Tall oven.

If you are cooking a large item, be prepared to turn it round during cooking.

If two racks are used, check that space has been left for the heat to circulate. When a baking sheet is put into the oven, make sure it is placed centrally on the rack.

Check that the door seal is not damaged and that the door catch is adjusted so that the door is held firmly against the seal.

A dish of water when placed on the rack should be the same depth all over. (For example, if it is deeper at the back, then the back of the range should be raised up or the front lowered). If the range is not level arrange for your supplier to level it for you.

Using your Range

Oven not coming on when turned on manually

Is the power on? Is the clock illuminated?

If not there may be something wrong with the power supply. Is the range supply on at the isolator switch?

Has the time of day been set?

If using the Multi-function oven have you set a cooking function?

Is the key symbol (Ⓚ) showing in the display? See the Clock section of the instructions for more information on the key lock feature of the clock.

Oven not coming on when automatic cooking

Timer set correctly but oven knob left OFF by mistake?

Is the key symbol (Ⓚ) showing in the display? See the Clock section of the instructions for more information on the key lock feature of the clock.

If using the Multi-function oven have you set a cooking function?

Oven temperature getting hotter as the range gets older

If turning the knob down has not worked or only worked for a short time then you may need a new thermostat. This should be fitted by a service person.

Broiler not cooking properly

Are you using the pan and grid supplied with the range? Is the pan being used on the runners, not the floor of the compartment? Is the broiler tray pushed fully back to stop?

The oven light is not working

The bulb has probably burnt out. You can buy a replacement bulb (which is not covered under the warranty) from a good electrical shop. Ask for a Edison screw fitting, 15w 125-130v lamp, FOR OVENS. It must be a special bulb, heat resistant to 300°C (570°F).

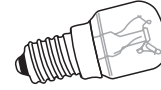

Turn off the power supply.

Make sure the oven is cool. Open the oven door and remove the oven racks.

Unscrew the bulb cover by turning counter clockwise. It may be very stiff.

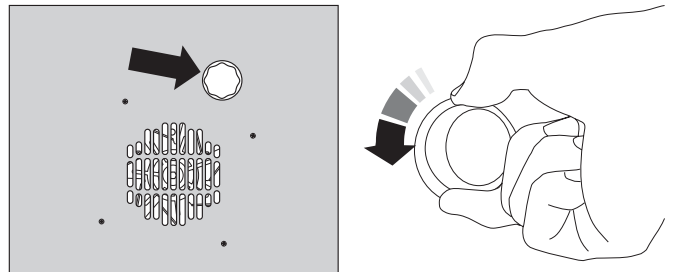

Taking care to protect your fingers in case the bulb should shatter, unscrew the old bulb.

Screw in the new bulb, screw back the bulb cover. Turn on the electricity supply and check that the bulb now lights.

Service and spares

Please complete the appliance details below and keep them safe for future reference - this information will enable us to accurately identify your particular appliance and help us to help you. Filling this in now will save you time and inconvenience if you later have a problem with your appliance. It may also be of benefit to keep your purchase receipt with this leaflet. You may be required to produce the receipt to validate a warranty field visit.

Fuel Type: Ceramic Electric
Appliance Name: AGA Legacy 36
Appliance Color*:
Appliance Serial Number*:
Retailers Name & Address:
Date of Purchase:
Installers Name & Address:
Date of Installation:

* This information is on the appliance data badge.

If you have a problem

In the unlikely event that you have a problem with your appliance, please refer to the rest of this booklet, especially the problem solving section, first to check that you are using the appliance correctly.

If you are still having difficulty, contact : -

Technical Services Dept. AGA-Ranges Inc.
110 Woodcrest Road
Cherry Hill, NJ 08003

Telephone Number 1-800-633-9200

Email support@aga-ranges.com

Please note

If your appliance is outside the warranty period, our service provider may charge for this visit.

If you request an sevicer to visit and the fault is not the responsibility of the manufacturer, our service provider reserves the right to make a charge.

Appointments not kept by you may be subject to a charge.

Out of Warranty

We recommend that our appliances are serviced regularly throughout their life to maintain the best performance and efficiency.

Service work should only be carried out by technically competent and suitably qualified personnel.

Spare Parts

To maintain optimum and safe performance, only use genuine spare parts. Do not use re-conditioned or unauthorised controls. Contact your retailer.

Read all instructions before installing or using this appliance.

Installation Instructions

Save these instructions for future reference.

Read all instructions before installing or using this appliance.

Installation Instructions

Save these instructions for future reference.

Installation

This book contains many important safety messages.

Always read and obey all safety messages.

Installer: Leave these instructions with the appliance

Important - Save the installation instructions for the local electrical inspector's use.

Warning

The anti-tip device supplied with this range must be correctly fitted when the appliance is installed. This will reduce risk of tipping of the appliance from abnormal usage or by excessive loading of the oven door

	<p>⚠ WARNING</p> <ul style="list-style-type: none">• ALL RANGES CAN TIP• INJURY TO PERSONS COULD RESULT• INSTALL ANTI-TIP BRACKET PACKED WITH RANGE• SEE INSTALLATION INSTRUCTIONS
---	--

Installation

Installation	Page 31
Regulations	Page 32
Tools	Page 32
Materials	Page 32
Installation Safety Instructions	Page 33
Dimensions and clearances	Page 33
Location guidelines	Page 34
Moving the Range	Page 35
Checking the parts	Page 36
Leveling the Range	Page 36
Anti-Tip Device	Page 36
Electrical Connection	Page 37
Assemble the range	Page 40
Range operational checks	Page 42
How To Remove the Range for Servicing	Page 43
Schematic diagram of the Range	Page 44
Schematic diagram of the Range	Page 45
Technical Data	Page 46

Read all instructions before installing or using this appliance.

Installation Instructions

Save these instructions for future reference.

Regulations

This range has been design-certified by CSA International according to UL858, latest edition.

Read the instructions before installing or using this appliance. This range becomes hot in use. Take safety precautions - see the safety warnings in the User Guide, which should be read together with this installation guide.

Installation of this range must conform with local and national codes.

The range must be electrically grounded in accordance with local codes or, in the absence of local codes, in accordance with the National Electrical Code (ANSI/NFPA 70, latest edition). See 'Electrical Connection' in this section.

Important

- Observe all governing codes and ordinances.
- The range must be properly grounded.
- Save these instructions for the local electrical inspector's use.

For Your Safety

Do not store or use combustible materials, gasoline or other flammable vapors and liquids in the vicinity of this or any other appliance.

Tools

You will need the following tools

1. Electric drill
2. Safety glasses
3. Masonry drill bit & anchors (only required if fitting the range on a stone or concrete floor)
4. Steel tape measure
5. Phillips head screwdriver
6. Flat head screwdriver
7. 4mm & 3mm Allen keys
8. Level
9. Pencil and ruler

Materials

Additional materials you may need:

- To protect any floor covering under the range a sheet of 1/4" thick ply wood or equivalent large enough to stand the range on

Read all instructions before installing or using this appliance.

Installation Instructions

Save these instructions for future reference.

Installation Safety Instructions

Warning!

Improper installation, adjustment, alteration, service or maintenance can cause injury or property damage. Refer to this manual. For assistance or additional information, consult a qualified installer, service agency or manufacturer (dealer).

Important

Remove all packing material and literature from oven before connecting the electrical supply to range.

- Have your range installed by a qualified installer.
- Your range must be electrically grounded in accordance with local codes or, in the absence of local codes, in accordance with the National Electrical Code (ANSI/NFPA 70, latest edition).
- Before installing your range on linoleum or any other synthetic floor covering, make sure the floor covering can withstand 180°F without shrinking, warping or discoloring. Do not install the range over carpeting unless a sheet of 1/4" thick plywood or similar insulator is placed between the range and carpeting.
- Make sure the wall coverings around the range can withstand heat generated by the range up to 200°F.
- Avoid placing cabinets above the range. There must be a gap of at least 30" (76cm) between the top of the range and any combustible surface above it.
- To eliminate the risk of burns or fire by reaching over heated surface units cabinet storage space located above the surface units should be avoided. If cabinet storage is to be provided, the rise can be reduced by installing a range hood that projects horizontally a minimum of 5 inches (13cm) beyond the bottom of the cabinets.

If a ventilating hood is installed above the range follow the installation instructions supplied with the hood.

Caution

Items of interest to children should not be stored above a range - children climbing on the range to reach items could be seriously injured.

Dimensions and clearances

Provide adequate clearances between the range and adjacent combustible surfaces. These dimensions must be met for safe use of your range.

Positioning the Range

The diagrams below show the minimum recommended distance from the range to nearby surfaces.

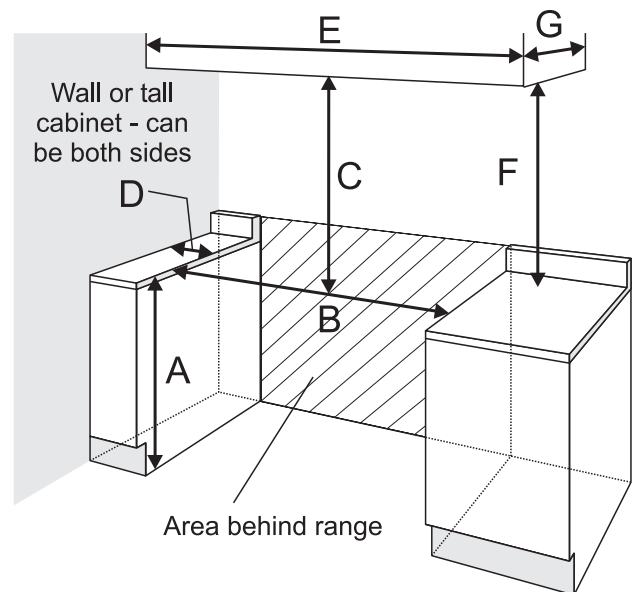

A Min 35 ³/₈" (89.8cm) Max 36 ⁷/₁₆" (92.5cm)

B Min. 35 ¹³/₁₆" (91cm)

C Min. 30" (76cm)

D Min. 3" (7.5cm) **but see below about door opening.**

E Min. 50" (127cm)

F Min 18" (43cm)

G Maximum 13" (33cm)

The cooktop surround should be level with, or above, any adjacent work surface. Above cooktop level a gap of 3" should be left between each side of the range and any adjacent vertical surface.

For non-combustible surfaces (such as unpainted metal or ceramic tiles) this can be reduced to 1".

A minimum space of 30" is required between the top of the cooktop and a horizontal combustible surface.

The maximum depth for cabinets installed above cooktops is 13".

The standard depth of the range is 26³/₄" overall.

Read all instructions before installing or using this appliance.

Read all instructions before installing or using this appliance.

Installation Instructions

Save these instructions for future reference.

Moving the Range

The range is very heavy. Take great care. We recommend two people maneuver the range. Ensure that the floor covering is firmly attached, or removed to prevent it being disturbed when moving the range around. You will need the leveling tool.

From the back tilt the range forward and remove the rear half of the polystyrene base pack.

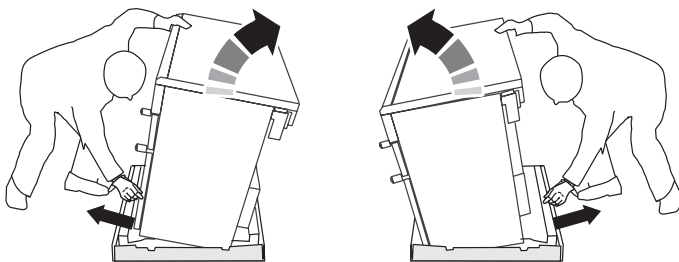

Repeat from the front and remove the front half of the polystyrene base.

LOWER THE TWO REAR ROLLERS.

First fit the leveling tool on the hexagonal adjusting nut as shown below.

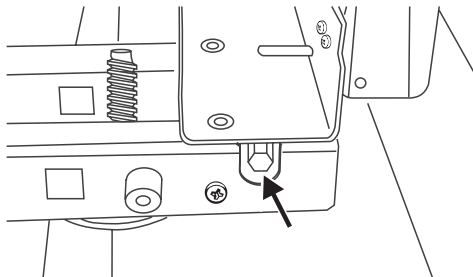

Make 10 complete (360°) turns clockwise. (This means turning and removing the leveling tool 20 times).

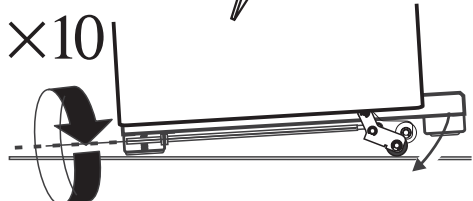
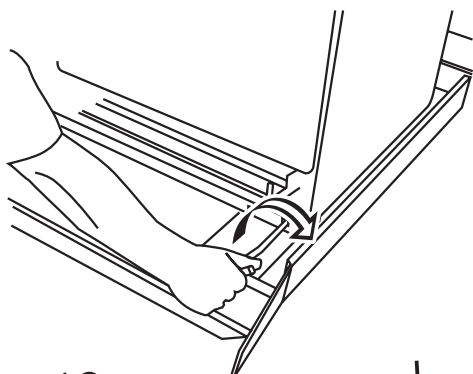

Make sure you lower BOTH REAR ROLLERS. There are two adjusting nuts, one for each roller, at both the front bottom corners of the range.

Note the rollers are only intended to aid installation - the range should not be moved once it is installed.

Unfold the rear edge of pack base tray. Open the broiler door and the Tall oven door. Grip under the control panel and lift the front of the range.

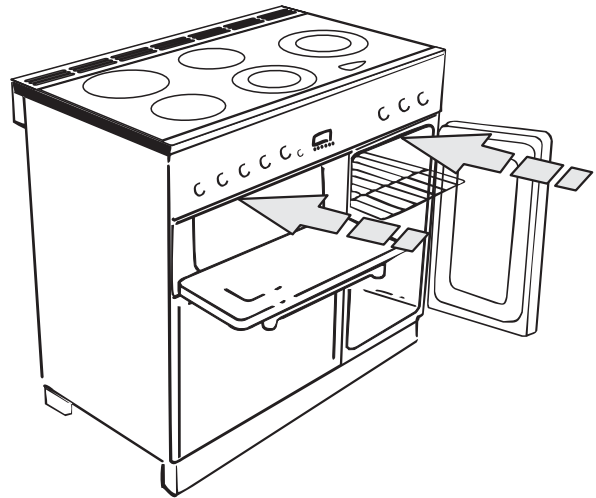

Carefully push the range backwards off the pack base. Remove the pack base tray. Position the range close to its final position leaving just enough space to get behind it.

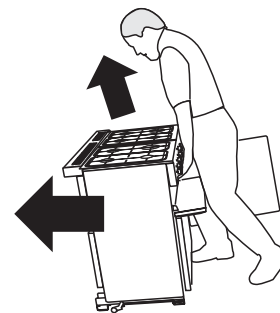

Do not use the door handles or control knobs to maneuver the range. Use the cooktop and bowl areas.

IMPORTANT!

Remove all tape and packaging. Take the accessory pack out of the oven. Check to be sure that no range parts have come loose during shipping.

Read all instructions before installing or using this appliance.

Installation Instructions

Save these instructions for future reference.

Checking the parts

Check that the range has the following parts.

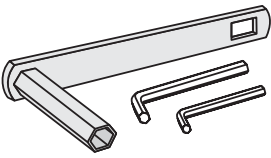
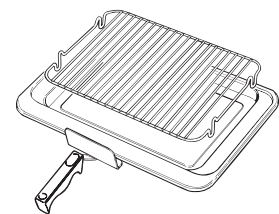
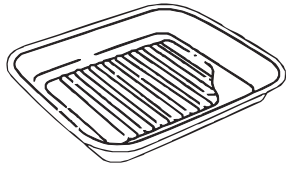
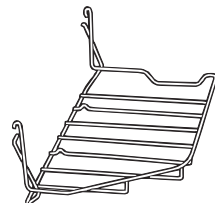
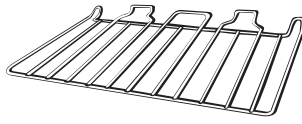
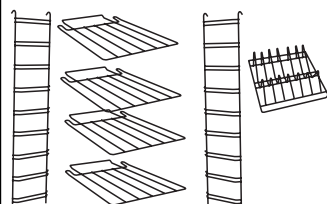
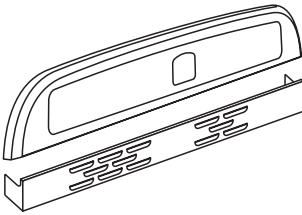
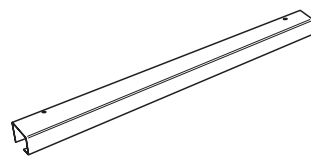
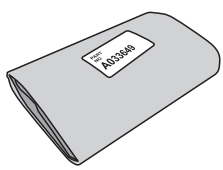
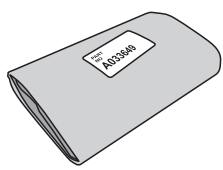
<p><i>Leveling tool & Allen keys</i></p> 	<p><i>Broiler pan and trivet</i></p> 
<p><i>Meat tin</i></p> 	<p><i>Handyrack</i></p> 
<p><i>3 Main oven racks</i></p> 	<p><i>Tall oven racks & rack supports</i></p> 
<p><i>Splashback & Plinth</i></p> 	<p><i>Rear spacer</i></p> 
<p><i>anti tip device kit</i></p> 	<p><i>Miscellaneous parts pack (rear spacer end caps, fixings, ground strap ect.)</i></p> 

Leveling the Range

Place the range in its intended position taking care not to twist it within the gap between the kitchen units as damage may occur to the range or the units. Install the oven shelves in the oven. Check for levelness by placing a spirit level or a cup, partially filled with water, on one of the oven grids. If using a spirit level, take two readings-with the level placed diagonally first in one direction and then the other.

The front feet and rear rollers can be adjusted to level the range. To adjust the height of the rear of the range use the leveling tool supplied to turn the adjusting nuts at the front bottom corners of the range. To set the front feet turn the bases to raise or lower.

Anti-Tip Device

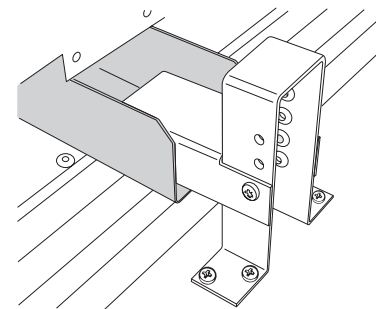

WARNING

Range must be secured by the Anti-Tip bracket supplied. See instructions to install (supplied with bracket). Unless properly installed, the range could be tipped by leaning on the door. Injury might result from spilled hot liquids or from the range itself.

Installing the Anti-Tip Device

The Anti-Tip bracket is supplied with instructions for installation in a variety of locations. The instructions include all necessary information to complete the installation. Read the Safety Instructions and the instructions that fit your situation before beginning installation.

Read all instructions before installing or using this appliance.

Installation Instructions

Save these instructions for future reference.

Electrical Connection

When installed the range must be electrically grounded in accordance with local codes or; in the absence of local codes with the National Electrical Code ANSI/NFPA 70, latest edition.

Electrical Power Supply Requirements

Electrical Requirements

CAUTION: FOR PERSONAL SAFETY, DO NOT USE AN EXTENSION CORD WITH THIS APPLIANCE. REMOVE HOUSE FUSE OR OPEN CIRCUIT BREAKER BEFORE BEGINNING INSTALLATION.

This appliance must be supplied with the proper voltage and frequency, and connected to an individual, properly grounded branch circuit, protected by a circuit breaker or time-delay fuse, as noted on the rating plate.

Wiring must conform to National Electric Codes. If the electric service provided does not meet the above specifications, have a licensed electrician install an approved outlet.

Because range terminals are not accessible after range is in position, flexible service conduit or cord must be used.

Provide Proper Electrical Supply

This range must be supplied with 208/240 volt, 60 Hz., and connected to an individual, properly grounded branch circuit protected by a circuit breaker or time-delay fuse (50 ampere). The receptacle must be NEMA 14-50R to accept the 4-prong plug supplied with the range.

If the electrical service provided does not meet the above specifications, it is recommended that a licensed electrician install an approved outlet.

Locate the electric supply as illustrated.

Connecting using the supplied cord and plug

Your range is shipped with a 4-prong plug to be used in a NEMA 14-50R receptacle.

Recommended Electrical Outlet Locations

Space behind the range is limited. Position the electrical connection to the side of the range. When connecting using a NEMA 14-50R receptacle, if possible position it so that it can be accessed while the range is in fitted. The range can then be easily disconnected for servicing etc.

Plug the range power cord into a properly grounded wall receptacle.

Connecting if the supplied cord and plug is not suitable.

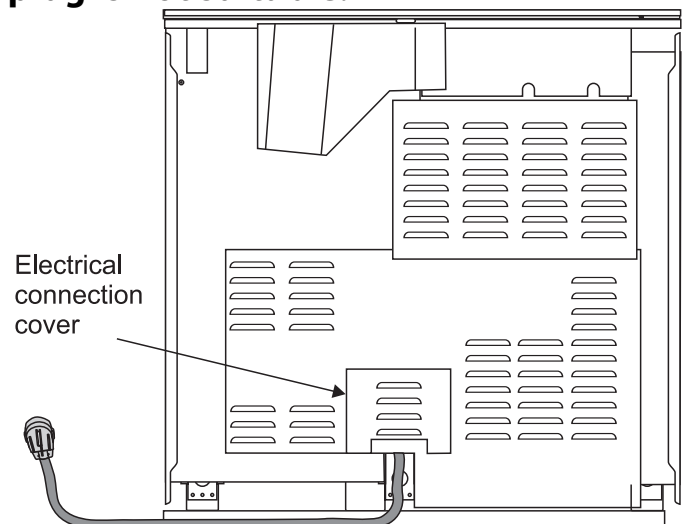

To remove the electrical connection cover first remove the screws on the bottom edge. Slide the cover down to free the top tags.

When refitting the cover first locate it on the top tags and then replace the screws.

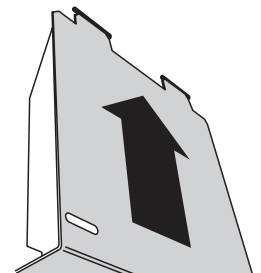

Read all instructions before installing or using this appliance.

Installation Instructions

Save these instructions for future reference.

The neutral or ground wire of the power cord must be connected to the neutral terminal located in the center of the connector block. The power leads must be connected to the outside terminals.

Make sure the connections are tight. Now tighten the strain relief device to clamp the power cord.

Refit the electrical connection cover

3-Wire Conduit Installation

Disconnect the supplied power cord from the terminal block and ground post. Keep the terminal block parts; you will need them. Remove the strain relief clamp from the power cord and remove the power cord and strain relief clamp from the mounting bracket.

The range is shipped with reducer plates to give a 1 1/8" diameter opening for conduit connection. Find the reducer plates in the miscellaneous parts pack and fit them to the mounting bracket.

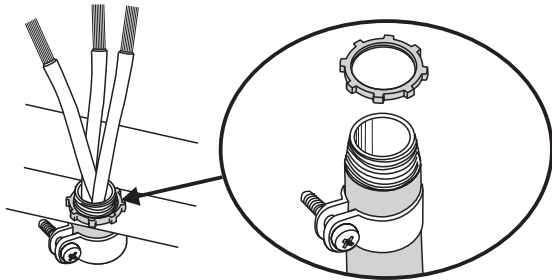

Fit a squeeze connector (not supplied with the range), to your conduit. Insert the conduit through the reducer plates on the mounting bracket. Allow enough slack to easily attach the wires to the terminal block.

NOTE: Do not install the conduit without a squeeze connector.

A Ground strap is supplied in the miscellaneous parts pack.

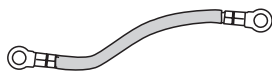

ground strap. (grey)

Fit the Ground strap to the ground and center terminal of the connector block - see the figure.

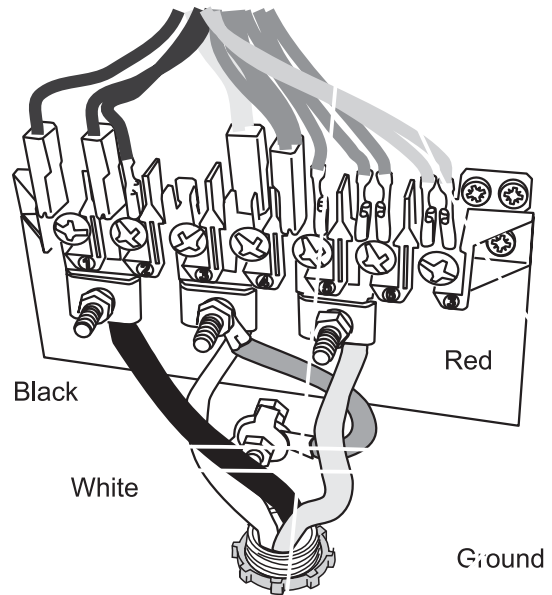

Read all instructions before installing or using this appliance.

Installation Instructions

Save these instructions for future reference.

Assemble the range

Fit the Door Handles

Remove the 4mm Hex headed screws from the doors with the hexagon key tool. Use the screws to fit the door handles.

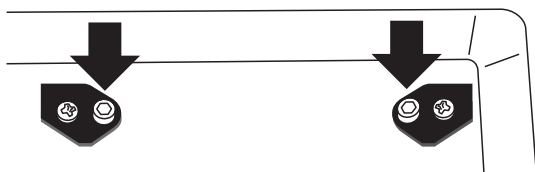

The handles should be above the fixings.

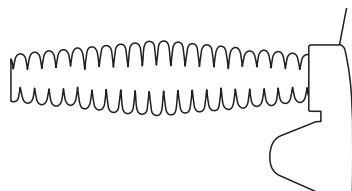

Read all instructions before installing or using this appliance.

Installation Instructions

Save these instructions for future reference.

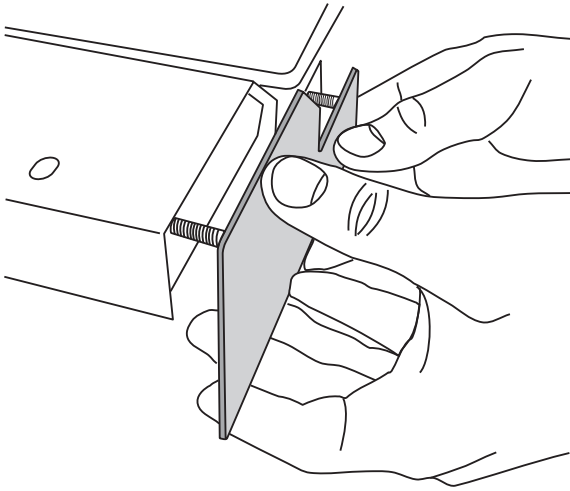

Fit the new end caps to the rear spacer and flue grille and hold in place with the nuts and spring washers supplied.

Fit the splash back (optional)

If the rear spacer is not fitted.

Hold the splash back in position.

The splash is fitted using 4 screws in the rear edge of the flue grille, two at each end. Fit the splash back over the inner screws and then refit the outer two screws. (see figure).

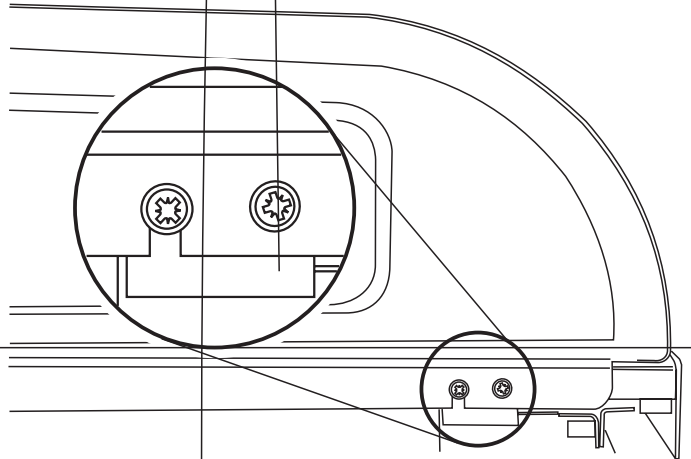

From the rear refit the 2 fixing screws and nuts.

If the rear spacer is fitted

Hold the splash back in position. Fit using the two fixing screws (3mm hexagonal socket head) and nuts that pass through the top of the rear spacer.

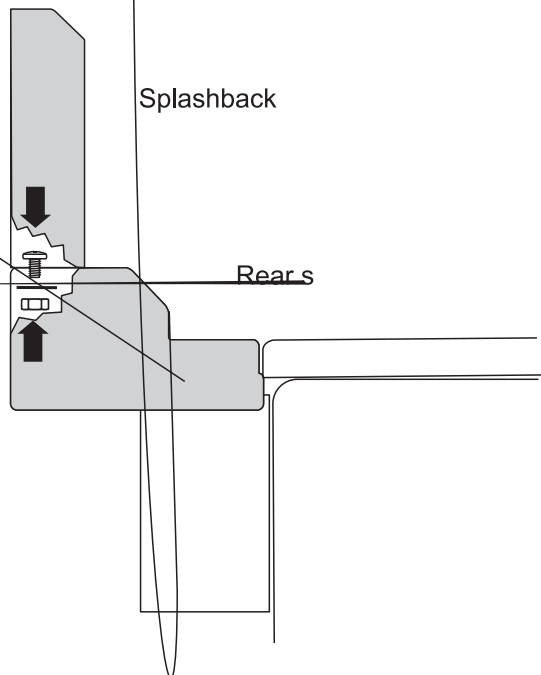

The plinth is held in place by magnetic catches. Fit it in place.

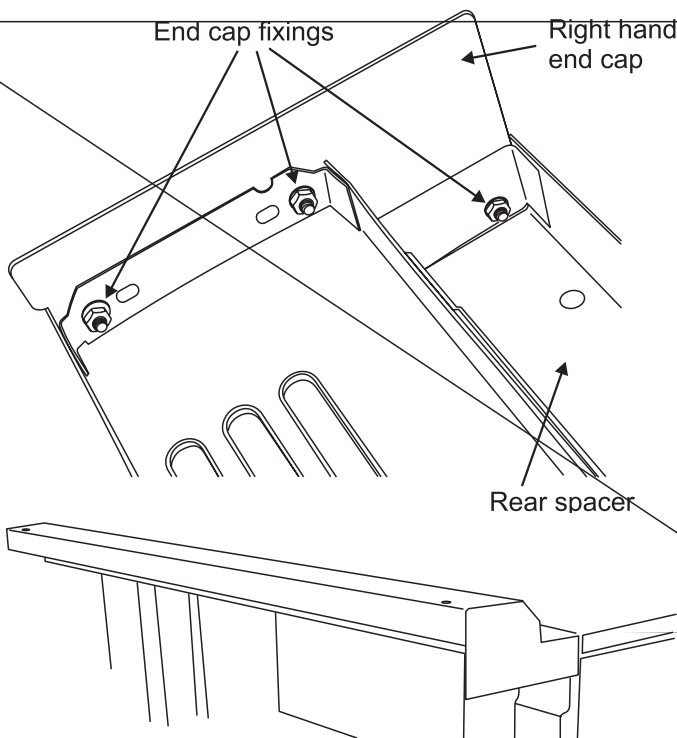

If you are not fitting the splashback the splashback mounting holes can be blocked with the extra screws supplied.

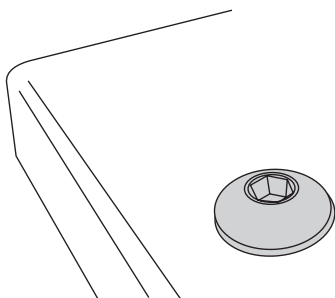

Read all instructions before installing or using this appliance.



Installation Instructions

Save these instructions for future reference.

Range operational checks

Oven check

Set the clock to the time of day - the ovens will not work if the clock is not set.

When the clock is first connected the display will flash () and () alternately.

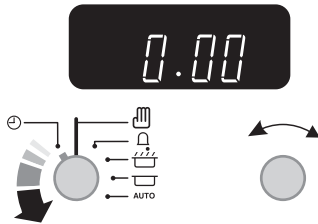

To set the clock to read the time of day turn and hold the Setting knob to the clock symbol (⌚) and at the same time turn the Adjusting knob left or right until the clock shows the time of day. This is a 12 hour clock. Let go of the Setting knob and it will spring back to the vertical () oven manual setting.

Turn on the oven and check that the oven fan starts to turn and that the oven starts to heat up. Turn off the oven.

Broiler

Open the broiler compartment door. Turn on the broiler control and check that the broiler heats up.

Oven Light

Press the Main oven light switch and check that the light is working.

Note. The oven light bulb is not included in the warranty

Cooktop

Push in and turn on each of the cooktop controls and check that the cooking areas heat up.

MAKE SURE THE FLOW OF VENTILATION AIR TO THE RANGE IS UNOBSTRUCTED.

MAKE SURE ALL CONTROLS ARE LEFT IN THE OFF POSITION.

Customer care

Please inform the user how to operate the range and hand over the Instruction book.

Thank you.

Read all instructions before installing or using this appliance.

Installation Instructions

Save these instructions for future reference.

How To Remove the Range for Servicing

Follow these procedures to remove appliance for servicing:

The range is very heavy. Take great care. We recommend two people maneuver the range. Ensure that the floor covering is firmly attached, or removed to prevent it being disturbed when moving the range around.

There are two leveling rollers at the back and also two screw down leveling feet at the front.

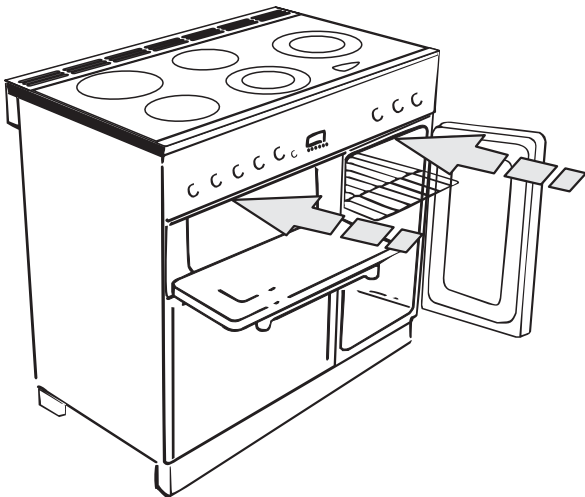

Open the broiler door and right hand oven door so that you can get a good grip on the bottom of the control panel as you move the oven.

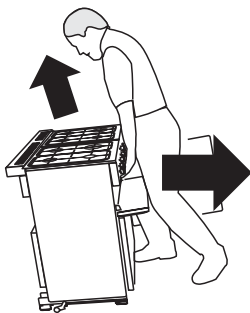

Do not move the range by pulling the door handles or knobs. Lift the front slightly and slide the range forward to disengage from the anti-tip bracket.

Move the range a bit at a time, checking behind it to make sure the electric cord is not caught. Make sure the electricity cable has sufficient slack to move the range forward as you go along

Disconnect electrical supply to appliance and unplug the electrical supply cord.

Reverse procedure to reinstall.

If your range is removed for any reason, make sure the anti-tip device is re-engaged properly when the range is replaced. Failure to take this precaution could result in tipping of the range and cause injury.

Read all instructions before installing or using this appliance.

Installation Instructions

Save these instructions for future reference.

Schematic diagram of the Range

Caution: Label all wires prior to disconnection when servicing controls. Wiring errors can cause improper and dangerous operation. Verify proper operation after servicing.

AGA Legacy 36 Inch Circuit Key

Code	Description	Code	Color
REC	Right hand end cooktop element controller	BK	Black
RFC	Right front cooktop element controller	BL	Blue
RRC	Right rear cooktop element controller	BR	Brown
LFC	Left front cooktop element controller	GY	Grey
LRC	Left rear cooktop element controller	O	Orange
REE	Right hand end cooktop element - 2200W	R	Red
RFE	Right front cooktop element - 1700W	V	Violet
RRE	Right rear cooktop element - 1200W	W	White
LFE	Left front cooktop element - 1200W	W/BK	White & Black
LRE	Left rear cooktop element - 1800 W	Y	Yellow
BRE	Broiler Elements		
BSB	Broiler Switch Block		
BTC	Broiler Temperature Control		
TCO	Temperature Cut Out		
OFM	Oven Fan Motor		
OLS	Oven Light Switch		
OVL	Oven Light 120 Volts		
NLI	Neon Light		
L2	L2 Supply (Red)		
N	Neutral Supply (White)		
L1	L1 Supply (Black)		
OTL	Oven Temperature Control Left		
LBE	Left Oven Bottom Element		
LTO	Left Oven Top Element		
LTI	Left Oven Top Inner Element		
LFE	Left Oven Fan Element		
LOS	Left Oven Switch Block		
TCK	Oven Control Clock		
CFM	Cooling Fan Motor		
OTR	Oven Temperature Control Right		
RSB	Right Oven Switch Block		
ROE	Right Oven Fan element		

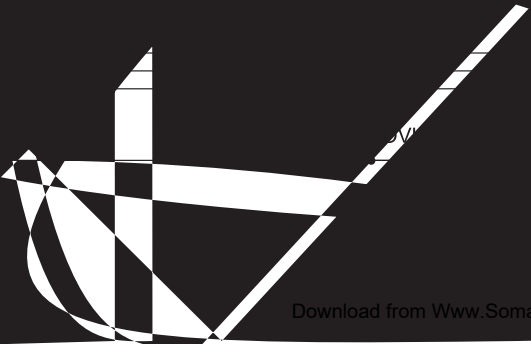
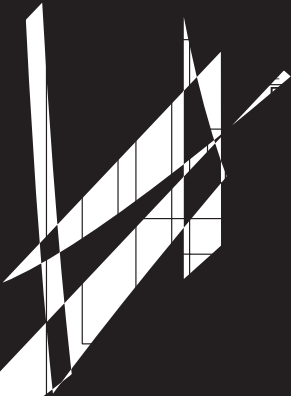
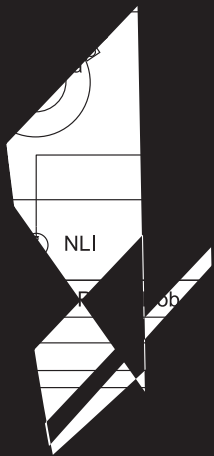

Read all instructions before installing or using this appliance.

Installation Instructions

Save these instructions for future reference.

Technical Data

INSTALLER: Please leave these instructions with the User.

DATA BADGE LOCATION: Under the Main oven. Remove the plinth by pulling forward (it is held in place by magnetic catches) and pull forward on the sheet metal tag under the center of the oven to swing out the badge plate.

Dimensions

Overall height (splash not fitted)	minimum 35 3/8" (89.8 cm)	maximum 36 7/16" (92.5 cm)
Overall width	35 1/2" (90cm) See 'Positioning the Range'	
Overall depth with spacer	28 3/4" (73cm)	
Space for fixing	See 'Positioning the Range'	
Minimum space above cooktop	30" (76cm)	

Connections

Electric: 208 - 240 V 60 Hz (120volt oven lights / 120volt neons)

Ratings

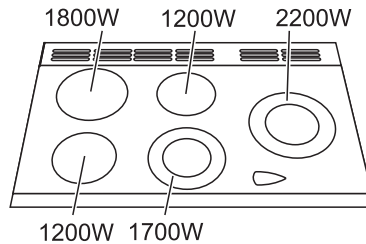

Ovens	Left hand Multifunction Oven	Right hand Fan Oven
Fan element	2500W	2500W
Top element	1200W	
Browning Element	1150W	
Bottom element	1000W	

Broiler	2300W
----------------	-------

Maximum total electrical load at 240V 15500W (approximate total including oven lights, oven fan etc.)

Recommended power cord rating 50 ampere in line with Nation Electrical code ANSI/NFPA 70

Total current draw approximately 64.6A

Read all instructions before installing or using this appliance.

Installation Instructions

Save these instructions for future reference.



Aga Ranges
110 Woodcrest Road
Cherry Hill, NJ 08003 USA
1.866.4AGA.4USA
www.aga-ranges.com
Email support@aga-ranges.com

Free Manuals Download Website

<http://myh66.com>

<http://usermanuals.us>

<http://www.somanuals.com>

<http://www.4manuals.cc>

<http://www.manual-lib.com>

<http://www.404manual.com>

<http://www.luxmanual.com>

<http://aubethermostatmanual.com>

Golf course search by state

<http://golfingnear.com>

Email search by domain

<http://emailbydomain.com>

Auto manuals search

<http://auto.somanuals.com>

TV manuals search

<http://tv.somanuals.com>