

**PPC-A84/A120-X5X**  
**NS GXm/GX1 processor-based**  
**Panel PC with 8.4"/12.1" LCD**  
**flat panel display**  
**User's Manual**

## **Copyright notice**

This document is copyrighted June, 2001 by Advantech Co., Ltd. All rights are reserved. Advantech Co., Ltd. reserves the right to make improvements to the products described in this manual at any time without notice.

No part of this manual may be reproduced, copied, translated or transmitted in any form or by any means without the prior written permission of Advantech Co., Ltd. Information provided in this manual is intended to be accurate and reliable. However, Advantech Co., Ltd assumes no responsibility for its use, nor for any infringements upon the rights of third parties which may result from its use.

All brand and product named mentioned herein are trademarks or registered trademarks of their respective holders.

Part No. 2008000030

1st Edition Printed in Taiwan January 2001

## FCC Class B notes

This equipment has been tested and found to comply with the limits for a Class B digital device, pursuant to Part 15 of the FCC Rules. These limits are designed to provide reasonable protection against harmful interference in a residential installation. This equipment generates, uses, and can radiate radio frequency energy and, if not installed and used in accordance with the instructions, may cause harmful interference to radio communications. However, there is no guarantee that interference will not occur in a particular installation. If this equipment does cause harmful interference to radio or television reception, which can be determined by turning the equipment off and on, the user is encouraged to try to correct the interference by one or more of the following measures:

- Reorient or relocate the receiving antenna
- Increase the separation between the equipment and receiver
- Connect the equipment into an outlet on a circuit different from that to which the receiver is connected
- Consult the dealer or an experienced radio/TV technician for help

*Warning: Any changes or modifications made to the equipment which are not expressly approved by the relevant standards authority could void your authority to operate the equipment.*

## Packing List

---

Before you begin system installation, please make sure that the following materials have been shipped:

- PPC-A84-X5X/PPC-A120-X5X
- User's manual
- Accessories for PPC-A84/A120
  - External FDD flat cable for FDD (34-pin)
  - External IDE cable for HDD or CD-ROM (40-pin)
  - Power cable for external FDD or IDE device (4-pin)
  - DC Power inlet cable (180 cm)
  - Assembly mounting screws
  - "Drivers and Utilities" CD-ROM disk
  - Hard drive disk carrier and connector
  - Male contact pin x 3 and female contact pin x 3
- A pair of DC power insulators with hood

If any of these items is missing or damaged, contact your distributor or sales representative immediately.

*Note: If the unit you bought is basic system (ie. without a hard driver), you will find a HDD carrier kit in the accessory box.*

## Additional Information and Assistance

---

1. Visit the Advantech web site at [www.advantech.com.tw](http://www.advantech.com.tw) where you can find the latest information about the product.
2. Contact your distributor, sales representative, or Advantech's customer service center for technical support if you need additional assistance. Please have the following information ready before you call:
  - Product name and serial number
  - Description of your peripheral attachments
  - Description of your software (operating system, version, application software, etc.)
  - A complete description of the problem
  - The exact wording of any error messages

# Safety Instructions

---

1. Read these safety instructions carefully.
2. Keep this installation reference guide for later reference.
3. Disconnect this equipment from any AC outlet or DC adapter before cleaning. Do not use liquid or spray detergents for cleaning. Use a damp cloth.
4. For pluggable equipment, the power outlet must be installed near the equipment and must be easily accessible.
5. Keep this equipment away from humidity.
6. Put this equipment on a reliable surface during installation. Dropping it or letting it fall could cause damage.
7. There are no openings on the enclosure. Please keep it in air convection environment. Protect the equipment from overheating.
8. Make sure the voltage of the power source is correct before connecting the equipment to the power outlet.
9. Position the power cord so that people cannot step on it. Do not place anything over the power cord.
10. All cautions and warnings on the equipment should be noted.
11. If the equipment is not used for a long time, disconnect it from the power source to avoid damage by transient over-voltage.
12. Never open the equipment. For safety reasons, the equipment should be opened only by qualified service personnel.
13. If any of the following situations arises, get the equipment checked by service personnel:
  - a. The power cord or plug is damaged.
  - b. Liquid has penetrated into the equipment.
  - c. The equipment has been exposed to moisture.
  - d. The equipment does not work well, or you cannot get it to work according to the installation reference guide.
  - e. The equipment has been dropped and damaged.
  - f. The equipment has obvious signs of breakage.
14. **DO NOT LEAVE THIS EQUIPMENT IN AN UNCONTROLLED ENVIRONMENT WHERE THE STORAGE TEMPERATURE IS BELOW -20°C (-4°F) OR ABOVE 60°C (140°F). IT MAY DAMAGE THE EQUIPMENT.**

The sound pressure level at the operator's position according to IEC 704-1:1982 is equal to or less than 70 dB(A).

**DISCLAIMER:** This set of instructions is given according to IEC 704-1. Advantech disclaims all responsibility for the accuracy of any statements contained herein.

## Wichtige Sicherheitshinweise

---

1. Bitte lesen sie Sich diese Hinweise sorgfältig durch.
2. Heben Sie diese Anleitung für den späteren Gebrauch auf.
3. Vor jedem Reinigen ist das Gerät vom Stromnetz zu trennen. Verwenden Sie Keine Flüssig- oder Aerosolreiniger. Am besten dient ein angefeuchtetes Tuch zur Reinigung.
4. Die Netzanschlussteckdose soll nahe dem Gerät angebracht und leicht zugänglich sein.
5. Das Gerät ist vor Feuchtigkeit zu schützen.
6. Bei der Aufstellung des Gerätes ist auf sicheren Stand zu achten. Ein Kippen oder Fallen könnte Verletzungen hervorrufen.
7. Die Belüftungsöffnungen dienen zur Luftzirkulation die das Gerät vor überhitzung schützt. Sorgen Sie dafür, daB diese Öffnungen nicht abgedeckt werden.
8. Beachten Sie beim. AnschluB an das Stromnetz die AnschluBwerte.
9. Verlegen Sie die Netzanschlubleitung so, daB niemand darüber fallen kann. Es sollte auch nichts auf der Leitung abgestellt werden.
10. Alle Hinweise und Warnungen die sich am Geräten befinden sind zu beachten.
11. Wird das Gerät über einen längeren Zeitraum nicht benutzt, sollten Sie es vom Stromnetz trennen. Somit wird im Falle einer Überspannung eine Beschädigung vermieden.
12. Durch die Lüftungöffnungen dürfen niemals Gegenstände oder Flüssigkeiten in das Gerät gelangen. Dies könnte einen Brand bzw. elektrischen Schlag auslösen.
13. Öffnen Sie niemals das Gerät. Das Gerät darf aus Gründen der elektrischen Sicherheit nur von autorisiertem Servicepersonal geöffnet werden.
14. Wenn folgende Situationen auftreten ist das Gerät vom Stromnetz zu trennen und von einer qualifizierten Servicestelle zu überprüfen:
  - a. Netzkabel oder Netzstecker sind beschädigt.
  - b. Flüssigkeit ist in das Gerät eingedrungen.
  - c. Das Gerät war Feuchtigkeit ausgesetzt.
  - d. Wenn das Gerät nicht der Bedienungsanleitung entsprechend funktioni ert oder Sie mit Hilfe dieser Anleitung keine Verbesserung erzielen.
  - e. Das Gerät ist gefallen und/oder das Gehäuse ist beschädigt.
  - f. Wenn das Gerät deutliche Anzeichen eines Defektes aufweist.
15. Bitte lassen Sie das Gerät nicht unbehehrt hinten unter -20° C (-4° F) oder oben 60° C (140° F), weil diesen Temperaturen das Gerät zerstören könnten.

Der arbeitsplatzbezogene Schalldruckpegel nach DIN 45 635 Teil 1000 beträgt 70 dB(A) oder weiger.

DISCLAIMER: This set of instructions is given according to IEC704-1. Advantech disclaims all responsibility for the accuracy of any statements contained herein.

# Contents

<b>Chapter 1 General Information .....</b>	<b>1</b>
<b>1.1 Introduction .....</b>	<b>2</b>
<b>1.2 Specifications .....</b>	<b>3</b>
General .....	3
Standard SBC functions (PCM-5821) .....	3
LCD Specification .....	4
PCMCIA module (Optional) .....	6
Environmental specifications .....	6
<b>1.3 Front View .....</b>	<b>7</b>
Power Indicator .....	7
<b>1.4 Dimensions .....</b>	<b>8</b>
<b>1.5 Cutout Dimensions(Suggestion) .....</b>	<b>9</b>
<b>1.6 Panel Mounting.....</b>	<b>10</b>
<b>1.7 Universal Mounting Arm (Optional) .....</b>	<b>11</b>
<b>1.8 Important Notice .....</b>	<b>13</b>
<b>Chapter 2 System Setup .....</b>	<b>15</b>
<b>2.1 A Quick Tour of the Panel PC .....</b>	<b>16</b>
<b>2.2 Preparing For First-time Usage .....</b>	<b>21</b>
<b>2.3 Installation Procedures.....</b>	<b>21</b>
2.3.1 Connecting the power inlet cable (180 cm) .....	21
2.3.2 Connecting the insulator to your power sources .....	22
2.3.3 Installing a primary 2.5" HDD (plug-in) .....	25
2.3.4 Installing DRAM (SODIMM) .....	25
<b>2.4 Installing I/O Equipment .....</b>	<b>27</b>
2.4.1 Installing one external IDE (3.5" HDD/CD-ROM) device and an external FDD .....	27
2.4.2 PS/2 keyboard and PS/2 mouse .....	28



2.4.3 Mic-in, line-in, speaker out .....	28
2.4.4 External VGA .....	29
2.4.5 Two serial COM ports .....	29
2.4.6 USB ports .....	29
2.4.7 Parallel port .....	30
2.4.8 Ethernet .....	30
<b>2.5 How to Install Software to the HDD .....</b>	<b>31</b>
2.5.1 Method 1: Use the Ethernet .....	31
2.5.3 Method 3: Use the COM or parallel port .....	31
2.5.4 Method 4: Use a 3.5" HDD or CD-ROM .....	31
<b>2.6 Running the BIOS Setup Program .....</b>	<b>32</b>
<b>2.7 Installing System Software .....</b>	<b>32</b>
<b>2.8 Installing the Drivers .....</b>	<b>33</b>

## **Chapter 3 The Engine of the PPC-A84/A120-X5X (PCM-5821)..... 35**

<b>3.1 Introduction .....</b>	<b>36</b>
<b>3.2 Features .....</b>	<b>37</b>
<b>3.3 Jumpers and Connectors .....</b>	<b>38</b>
3.3.1 Setting jumpers .....	38
3.3.2 Jumpers .....	39
3.3.3 Connectors .....	40
<b>3.4 Wake on LAN Selection (Reserved) (JP1) .....</b>	<b>43</b>
<b>3.5 CMOS Clear (JP2) .....</b>	<b>43</b>
<b>3.6 Watchdog Timer Configuration .....</b>	<b>43</b>
3.6.1 Watchdog activity selection (JP2) .....	44
<b>3.7 COM2 RS-232/422/485 setting (JP3, JP4,JP5) .....</b>	<b>44</b>
<b>3.8 Buzzer enable (JP10) .....</b>	<b>45</b>

## **Chapter 4 PCI Bus Ethernet Interface ..... 47**

<b>4.1 Introduction .....</b>	<b>48</b>
<b>4.2 Installation of Ethernet Driver .....</b>	<b>48</b>
4.2.1 Installation for WINDOWS 95 .....	49

4.2.2 Installation for WINDOWS 98 .....	53
4.2.3 Installation for WINDOWS NT .....	54
<b>4.3 Further Information .....</b>	<b>59</b>

## **Chapter 5 PCI SVGA Setup ..... 61**

<b>5.1 Introduction .....</b>	<b>62</b>
5.1.1 Chipset .....	62
5.1.2 Display memory .....	62
5.1.3 Display types .....	62
<b>5.2 Installation of SVGA Driver .....</b>	<b>62</b>
5.2.1 Installation for Windows 95 .....	64
5.2.2 Installation for WINDOWS 98 .....	68
5.2.3 Installation for WINDOWS NT .....	71
<b>5.3 Further Information .....</b>	<b>73</b>

## **Chapter 6 Touchscreen ..... 75**

<b>6.1 Introduction .....</b>	<b>76</b>
<b>6.2 Installation of Touch Screen Driver for the PPC-A84 .....</b>	<b>76</b>
6.2.1 Installation for MS-DOS .....	77
6.2.2 Installation for Windows 95 .....	78
6.2.3 Installation for Windows 98 .....	80
6.2.4 Installation for Windows NT .....	82
<b>6.3 Installation for Touch Screen Driver for the PPC-A120 .....</b>	<b>84</b>
6.3.1 Installation for Windows 95 .....	85
6.3.2 Installation for Windows 98 .....	87
6.3.3 Installation for Windows NT .....	89

## **Chapter 7 Audio Setup ..... 93**

<b>7.1 Introduction .....</b>	<b>94</b>
<b>7.2 Installation of Audio Driver .....</b>	<b>94</b>
7.2.1 Installation for Windows 95 .....	95

7.2.3 Installation for WINDOWS NT .....	98
7.2.2 Installation for Windows 98 .....	98
<b>7.3 Further Information .....</b>	<b>101</b>
<b>Chapter 8 Award BIOS Setup .....</b>	<b>103</b>
8.1 Award BIOS Setup .....	104
8.2 CMOS Setup Utility .....	104
8.3 Standard CMOS Setup .....	105
8.3.1 Hard Disk Configurations .....	106
8.4 BIOS Features Setup .....	107
8.5 Chipset Features Setup .....	110
8.6 Power Management Setup .....	111
8.7 PNP/PCI Configuration Setup .....	113
8.8 Load BIOS Defaults .....	114
8.9 Load Setup Defaults .....	115
8.10 Integrated Peripherals .....	115
WDT Active When Power ON .....	117
8.11 Password Setting .....	118
8.12 IDE HDD Auto Detection .....	118
8.13 Save and Exit Setup .....	119
8.14 Exit Without Saving .....	119
<b>Appendix A Programming the Watchdog Timer .....</b>	<b>121</b>
A.1 Programming the Watchdog Timer .....	122
<b>Appendix B Full Disassembly Procedures .....</b>	<b>125</b>
B.1 Full Disassembly Procedures .....	126
<b>Appendix C Pin Assignments .....</b>	<b>133</b>
C.1 Inverter Power Connector (J1) .....	134
C.2 Flat Panel Display Connector (J2) .....	134
C.3 Primary IDE Connector (J3) .....	135

<b>C.4 Keyboard Connector (J4)</b> .....	<b>136</b>
<b>C.5 Internal Touchscreen Connector(J5)</b> .....	<b>137</b>
<b>C.6 ComapctFlash™ Disk Secondary IDE Connector (CN2)</b> <b>138</b>	
<b>C.7 CD IN (CN3)</b> .....	<b>139</b>
<b>C.8 Power Fan Power Connector (CN4)</b> .....	<b>139</b>
<b>C.9 External KBT2 Connector (CN7)</b> .....	<b>139</b>
<b>C.10 CPU Fan Power Connector (CN8)</b> .....	<b>140</b>
<b>C.11 Power Switch Connector (CN10)</b> .....	<b>140</b>
<b>C.12 Speaker and Microphone Connector (CN20)</b> .....	<b>141</b>
<b>C.13 Power Test Connector (PS1)</b> .....	<b>141</b>
<b>C.14 COM2</b> .....	<b>142</b>
<b>C.15 External IDE Connector</b> .....	<b>143</b>
<b>C.16 External Floppy Drive Connector</b> .....	<b>144</b>
<b>C.17 External FDD and HDD Power Connector</b> .....	<b>145</b>
<b>C.18 System I/O ports</b> .....	<b>145</b>

# Figures

<b>Figure 1-1: Front view of the PPC-A84 .....</b>	<b>7</b>
<b>Figure 1-2a: Dimensions of the PPC-A84 .....</b>	<b>8</b>
<b>Figure 1-2b: Dimensions of the PPC-A120 .....</b>	<b>8</b>
<b>Figure 1-3a: Dimensions of cutout and panel mounting holes (A84) ...</b>	<b>9</b>
<b>Figure 1-3b: Dimensions of cutout and panel mounting holes (A120) .</b>	<b>9</b>
<b>Figure1-4: Panel mounting .....</b>	<b>10</b>
<b>Figure 1-5: Mounting with universal arm ( I ) .....</b>	<b>11</b>
<b>Figure1-6: Mounting with universal arm (II) .....</b>	<b>12</b>
<b>Figure1-7: Mounting with universal arm (III) .....</b>	<b>12</b>
<b>Figure 2-1: Front view of the PPC-A84 .....</b>	<b>16</b>
<b>Figure 2-2: Top side view of the PPC-A84 .....</b>	<b>17</b>
<b>Figure 2-3: Rear view of the PPC-A84 .....</b>	<b>18</b>
<b>Figure 2-4: I/O section of the PPC-A84/A120 .....</b>	<b>19</b>
<b>Figure 2-5: Install or remove the power supply,HDD drive,and PCMCIA module (A84) .....</b>	<b>20</b>
<b>Figure 3-1: Locating jumpers and connectors on PCM-5821 (front side) .....</b>	<b>41</b>
<b>Figure 3-2: Locating jumpers and connectors PCM-5821 (rear side) .....</b>	<b>42</b>
<b>Figure 8-1: Setup program initial screen .....</b>	<b>104</b>
<b>Figure 8-2: CMOS setup screen .....</b>	<b>105</b>
<b>Figure 8-3: BIOS features setup screen .....</b>	<b>107</b>
<b>Figure 8-4: Chipset features setup screen .....</b>	<b>110</b>
<b>Figure 8-5: Power Management setup screen .....</b>	<b>111</b>
<b>Figure 8-6: PNP/PCI configuration setup screen .....</b>	<b>113</b>
<b>Figure 8-7: Load BIOS defaults screen .....</b>	<b>114</b>
<b>Figure 8-8: Integrated peripherals screen .....</b>	<b>115</b>
<b>Figure 8-9: Save and exit setup screen .....</b>	<b>119</b>
<b>Figure B-1: Disassembly steps 1 - 4 .....</b>	<b>127</b>
<b>Figure B-2: Disassembly steps 5 - 7 .....</b>	<b>129</b>
<b>Figure B-3: Disassembly steps 8 - 12 .....</b>	<b>131</b>

# Tables

Table 3-1: Jumpers and their functions .....	39
Table 3-2: Panel PC connectors .....	40
Table 3-3: Wake-on LAN selection (JP1) .....	43
Table 3-4: Clear CMOS/External RTC (JP2) .....	434
Table 3-5: Watchdog activity selection (JP2) .....	44
Table 3-6: COM2 RS-232/422/485 setting (JP3, JP4) .....	44
Table 3-7: COM2 RS-232/422/485 setting (JP5) .....	45
Table 3-8: Buzzer enable (JP10) .....	45
Table C-1: Inverter power connector (J1) .....	134
Table C-2: Flat panel display connector (J2) .....	134
Table C-3: Primary IDE connector (J3) .....	135
Table C-4: Keyboard Connector (J4) .....	136
Table C-5: Internal Touchscreen Connector (J5) .....	137
Table C-6: CompactFlash™ Disk Secondary IDE Connector (CN2) .....	138
Table C-7: CD IN (CN3) .....	139
Table C-8: Power Fan Power Connector (CN6) .....	139
Table C-9: CPU Fan Power Connector (CN7) .....	139
Table C-10: CPU fan power connector (FAN1) .....	140
Table C-11: Power Switch Connector (CN10) .....	140
Table C-12: Speaker and Microphone Connector (CN20) .....	141
Table C-13: Power Test Connector (PS1) .....	141
Table C-14: COM2 .....	142
Table C-15: External IDE connector .....	143
Table C-16: External floppy drive connector .....	144
Table C-17: External FDD and HDD Power Connector .....	145
Table C-18: System I/O ports .....	145

# CHAPTER 1

## General Information

This chapter gives background information on the PPC-A84-X5X/PPCA120-X5X

Sections include:

- Introduction
- Specifications
- Front View
- Dimensions
- Cutout Dimensions
- Panel Mounting
- Universal Mounting Arm

# 1.1 Introduction

---

Advantech's PPC-A84-X5X/PPC-A120-X5X is a new generation 8.4"/12.1" LCD panel PC with NS GXm/GX1 CPU. It is specially designed for HMI applications, such as factory, machinery automation, transportation, and health care. The PPC-A84-X5X/PPC-A120-X5X is designed with advanced breakthrough concepts. It is a modularized PC within aluminum die-cast housing. When installed in an open space, no fan is required. These powerful features assist system integration, allowing more flexibility in applications.

## **Die-cast housing**

The completely sealed housing protects the system in tough, harsh environments. The die-cast housing also acts as a heat sink, to prevent the system from overheating. The front panel is compliant with IP65 standard.

## **No ventilation hole**

With a heat pipe for ventilation, the system's MTBF has been extended. With no ventilation holes, the enclosure is completely sealed, thereby protecting the system from dust

## **Modularized accessories**

The power supply, HDD drive and PCMCIA module are easily removable for maintenance or exchange. The modularized design allows easier and quicker replacement of accessories.



## 1.2 Specifications

---

### General

- **Construction:** Aluminium die-cast housing with a plastic front mask
- **Dimensions (W x H x D):**
  - A84:** 271 x 212 x 84.4mm (10.07"x8.35"x3.32")
  - A120:** 339 x 268 x 94.3mm (13.35"x10.55"x3.71")
- **Weight:** 3.4 kg (7.5 lbs)
- **Free air cooling cause no fan noise**
- **Resistive touchscreen friendly user interface**

### Standard SBC functions (PCM-5821)

- **CPU:**
  - A84:** NS MediaGX™ MMX™ -enhanced processor; on board 352 BGA package.
  - A120:** NS GX1 300 MHz processor; on board 352 BGA package.
- **Chipset:** NS CX 5530 352-terminal BGA package; display subsystem extensions for CRT/TFT LCD interface.
- **BIOS:** Award 256KB Flash memory; support LCD brightness control, intellectual cooling fan control, PnP, suspend to disk/memory, ACPI/APM sub-function, boot ROM, boot from CD-ROM drive, boot from LS-120 and ZIP driver, on board health monitor function; Y2K compliance.
- **Battery:** 3 V @ 195 mA Lithium battery for CMOS backup
- **RAM:** One 144-pin SODIMM socket, accepts 16 ~ 128 MB 3.3V SODIMM module.
- **PCI bus master IDE interface:** Supports two channels. Each channel can support two IDE devices with PIO mode 0 ~ 4, DMA mode 0 ~ 2, and Ultra DMA33 simultaneously.
- **Watchdog timer:** Generates a system reset after an adjustable period

up to 62 seconds. Can be software enabled/disabled. Default factory setting is disabled.

- **Audio chip:** AD1819A, fully compliant AC 97 analog I/O component, 16-bit stereo full-duplex codec, audio interface for Microphone-in, line-in and speaker-out.
- **PCI Ethernet chip:** Realtek RTL8139C PCI local bus Ethernet controller full compliance with IEEE 802.3u 10/100 Base-T specification. Supports both boot ROM function and software drivers.

## LCD Specification

- **LCD Display type:** 18 bits TFT 8.4"/TFT 12.1"
  - **Display Mode:** 64 gray scales, 256 K colors; Transmissive type.
  - **Max. resolution:** 800 x 600
  - **Pixel size:**  
**A84:** 0.213mm x 0.213 mm  
**A120:** 0.31mm x 0.31mm
  - **View angle:**  
**A84:** 60°  
**A120:** 100°
  - **Luminance:**  
**A84:** 120 cd/m<sup>2</sup>  
**A120:** 200 cd/m<sup>2</sup>
  - **Temperature:** 0° ~ 50° C
  - **Simultaneous mode:** Yes
  - **LCD MTBF:** 50,000 hours
  - **Backlight MTBF:**  
**A84:** 10,000 hours  
**A120:** 25,000 hours
- Touchscreen
- **Type of Touch Screen:**  
**A84:** Dynapro resistive touch sensor and Ronics control board, drivers.

**A120:** Elo resistive touch sensor and Elo control board.

- **Backing Panel:** Chemical strengthened glass (4 times stronger than non-strengthened glass to guard against breakage).
- **Resolution:** 1024 x 1024
- **Contact Bounce:** <10 ms
- **Linearity:** +/- 2%
- **Light transmission:** 72% @ 550 nm
- **Chemical Resistance:** Yes
- **Actuation force:** 10 grams for stylus pen, 30-45 grams for finger
- **Operating temperature:** -20 ~ +60° C
- **Controller:** A84: PS/2 interface  
A120: COM4 serial port interface
- **Power consumption:** +5 V @ 200 mA
- **Software driver:** Supports DOS, WINDOWS 95/98/NT 4.0
- **Lifetime:** More than 3 million touches

**PC Input Power Supply Module (12 Volt or 24 Volt)**

		12 V Pwr Supply	24 V Pwr Supply
<b>Input voltage range</b>		10.6 ~ 16.0 volt	19.0 ~ 27.0 volt
<b>Input current</b>		6 A	3 A
<b>Output Current</b>	5 V	6 A	6 A
	12 V	1 A	1 A
	-12 V	0.3 A	0.3 A
	5 V Standby	0.25 A	0.25 A
<b>Efficiency</b>		better than 73%	better than 76%
<b>Operating temp.</b>		0 ~ 50 C	0 ~ 50 C
<b>Storage temp.</b>		-40 ~ 100 C	-40 ~ 100 C
<b>MTBF</b>		100,000 hr	100,000 hr

*Notes: The 24V<sub>DC</sub> power module is standard, while the 12V<sub>DC</sub> power module is optional upon the customers' requirement.*

## **PCMCIA module (Optional)**

- **Chipset:** TI PCI1225
- 1997 PC Card™ Standard Compliant
- Supports two PC Card or CardBus slots with hot insertion and removal.
- Mixed-and-match 5 V/3.3 V 16-bit PC Cards and 3.3 V CardBus slots
- PCI local bus specification revision 2.2 compliant

*Note: The PCMCIA driver is an option which does not come with the PPC-A84 system. For more information, contact your local dealer or our sales representative.*

## **Environmental specifications**

- **Operating temperature:** 0 ~ 40° C (32 ~ 104° F)
- **Relative humidity:** 0 ~ 95% RH (non-condensing), 40° C
- **FCC Class B, CE approved**
- **Shock:** 10 G peak acceleration ( 11 msec duration)

## 1.3 Front View

---

The front view of the PPC-A84 is shown below:



**Figure 1-1: Front view of the PPC-A84**

## 1.4 Dimensions

The PPC-A84-X5X/PPC-A120-X5X can be placed on a shelf or a table, or mounted into a panel. Cutout panel dimensions are as follows:

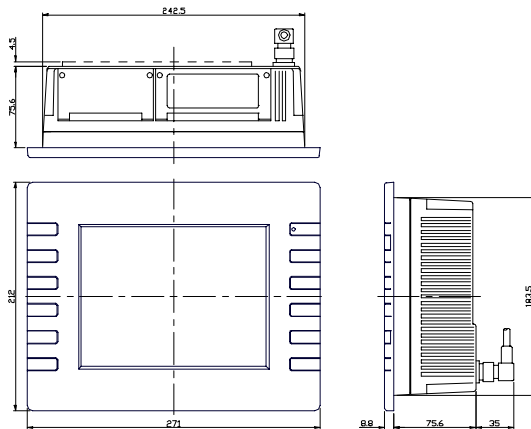


Figure 1-2a: Dimensions of the PPC-A84

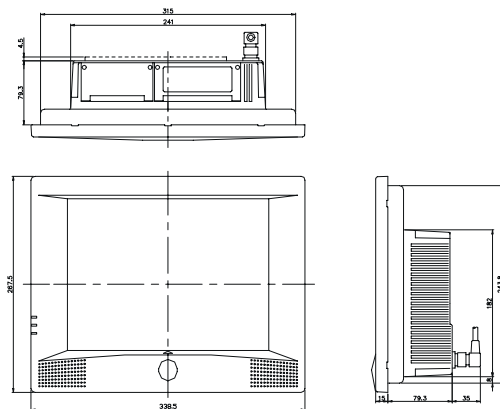


Figure 1-2b: Dimensions of the PPC-A120

# 1.5 Cutout Dimensions(Suggestion)

The PPC-A84-X5X/PPC-A120-X5X will stand on a shelf or a table, or you can mount it into a panel. Cutout panel dimensions are the following:

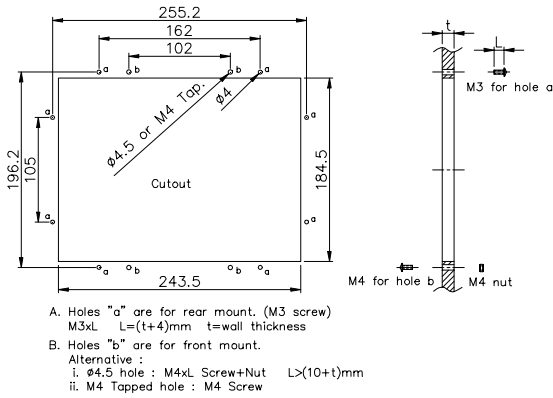


Figure 1-3a: Dimensions of cutout and panel mounting holes (A84)

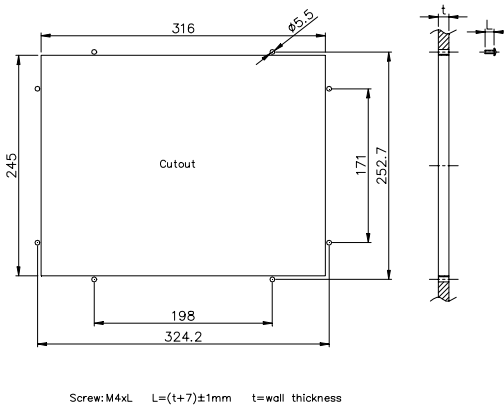


Figure 1-3b: Dimensions of cutout and panel mounting holes (A120)

## 1.6 Panel Mounting

---

If you decide to panel mount your PPC-A84-X5X/PPC-A120-X5X, Please find four screws and four nuts in the accessory box.

To mount the PPC-A84 into a panel:

1. Removed the four caps from the front mask, unsew it and remove the front bezel.
2. Insert the screws into the holes in the front side and tighten with the nuts in the back side. (In case of tapped hole, nuts are necessary).
3. Screw back the front bezel.
4. Put the four caps back to the front panel.

**Note:** *The panel thickness should not exceed 10 mm.*



**Figure1-4: Panel mounting**



## 1.7 Universal Mounting Arm (Optional)

---

The universal arm of PPC-A84-X5X/PPC-A120-X5X allows you to easily cope with different applications restraints while installing the system. Simply grasp the PPC-A84-X5X/PPC-A120X5X, position it to remove glare, adjust to the most comfortable viewing angle, fix it with screws and everything is done.

### **Suspend mounting :**

With the universal arm, the PPC-A84-X5X/PPC-A120X5X can be suspend mounted for those applications with limit space, such as the computing applications in vehicles.



**Figure 1-5: Mounting with universal arm (I)**

**Wall mounting :**

The PPC-A84-X5X/PPC-A120-X5X can be mounted on a wall by using the universal arm for those applications requiring convenient and easy access, such as the warehousing and logistics.



**Figure1-6: Mounting with universal arm (II)**

**Stand mounting :**

The PPC-A84-X5X/PPC-A120-X5X can be held on the movable stand for those applications with mobility and flexibility considerations, such as the bedside monitoring system in the hospitals.



**Figure1-7: Mounting with universal arm (III)**

## 1.8 Important Notice

---

*Please be advised that for the remainder of this manual PPC-A84-X5X/PPC-A120-X5X will be referred to as PPC-A84/A120.*



# CHAPTER 2

## System Setup

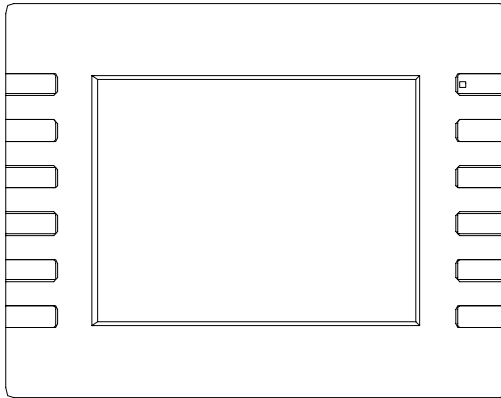
- A Quick Tour of the Panel PC
- Preparing for First-time Usage
- Installation Procedure
- Installing I/O Equipment
- How to Install the software to HDD
- Running the BIOS Setup Program
- Installing the System Software
- Installing the Drivers

## 2.1 A Quick Tour of the Panel PC

---

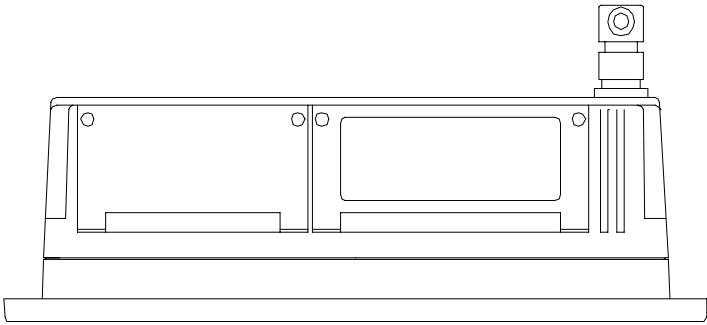
Before you start to set up the panel PC, take a moment to become familiar with the locations and purposes of the controls, drives, connectors and ports, which are illustrated in the figures below.

When you place the panel PC upright on the desktop, its front panel appears as shown in Figure 2-1.



**Figure 2-1: Front view of the PPC-A84**

When you look at the top side of the panel PC, you will see two door for DC power supply, hard disk drive, and PCMCIA expansion sockets, as shown in Fig. 2-2.



**Figure 2-2: Top side view of the PPC-A84**

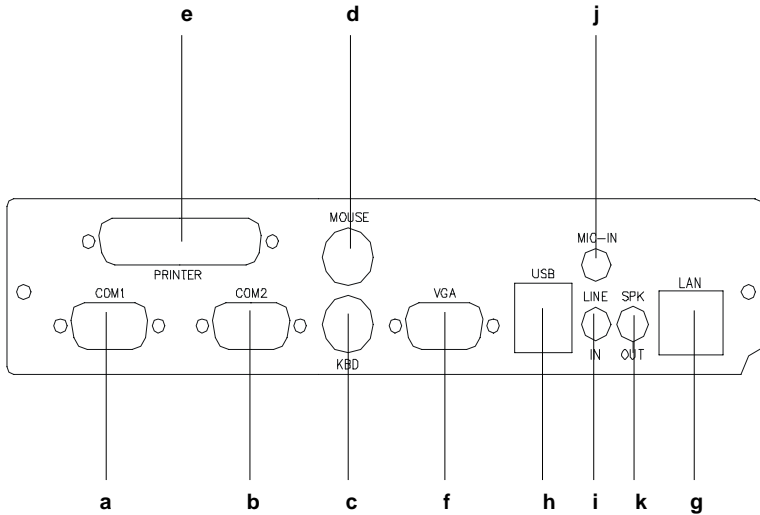
When you turn the panel PC around and look at its rear cover, you will find the FDD/IDE expansion connectors located in the center side. These connectors are covered by a metal cover. The sunken I/O section is at the bottom of the panel PC, as shown in Fig. 2-3 and Fig.2-4. (The I/O section includes various I/O ports, including serial ports, parallel port, the Ethernet port, USB ports, the microphone jack, and so on.)



**Figure 2-3: Rear view of the PPC-A84**

- a. Heatsink
- b. Power switch button
- c. Power inlet connector
- d. 34-pin FDD connector
- e. 4-pin power connector for FDD/IDE devices
- f. 40-pin IDE connector for 3.5" HDD or CD-ROM

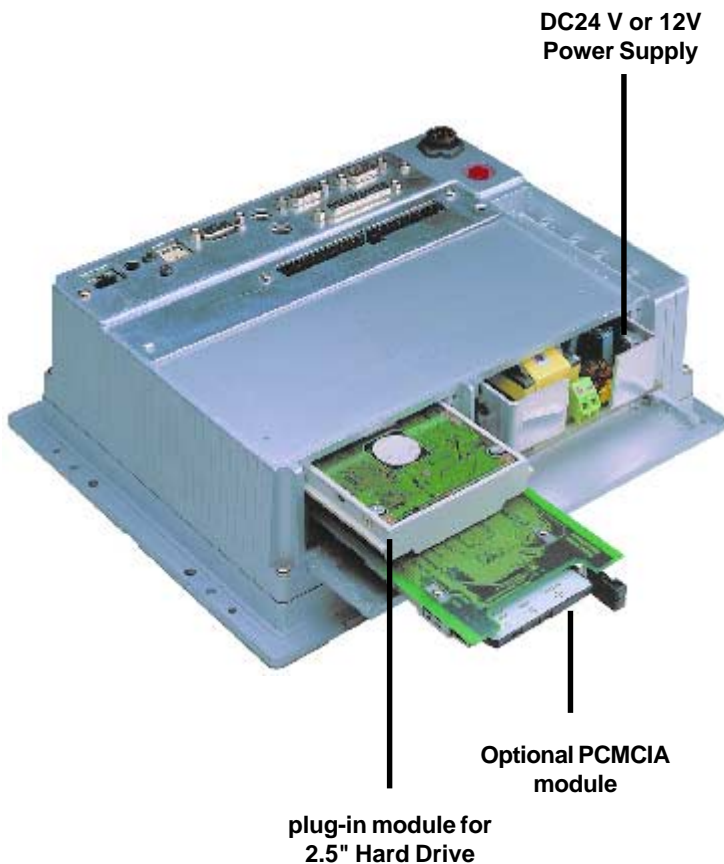




**Figure 2-4: I/O section of the PPC-A84/A120**

- |                            |                  |
|----------------------------|------------------|
| a. Serial COM1 port        | f. VGA port      |
| b. Serial COM2 port        | g. Ethernet port |
| c. PS/2 keyboard connector | h. USB port      |
| d. mouse connector         | i. Line in       |
| e. Parallel port           | j. Microphone in |
|                            | k. Speaker out   |

The power supply, HDD drive and PCMCIA module are removable and easy to change and maintain.



**Figure 2-5: Install or remove the power supply,HDD drive,and PCMCIA module (A84)**

## 2.2 Preparing For First-time Usage

---

Before you start to set up the panel PC system, you should have at least the following items ready:

- Power inlet cable (in the accessory box)
- Male contact pin x 3 and female contact pin x 3 (in the accessory box)
- A pair of DC power insulator with hood (in the accessory box)
- 34-pin external FDD flat cable for FDD (in the accessory box)
- 40-pin external IDE cable for HDD or CD-ROM (in the accessory box)
- 4-pin power cable for external FDD or IDE device (in the accessory box)
- AT keyboard
- PS/2 or serial mouse (for system software installation i.e. Microsoft Windows, NT, etc.....).

## 2.3 Installation Procedures

---

### 2.3.1 Connecting the power inlet cable (180 cm)

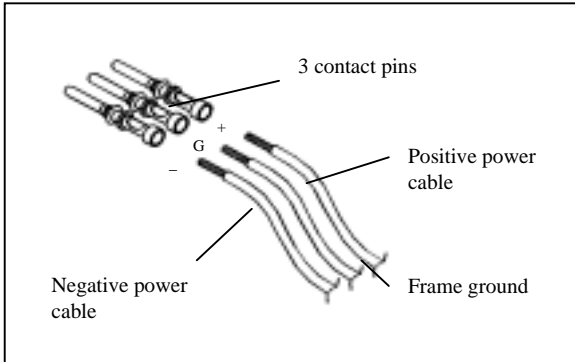
The panel PC can only be powered by DC 24 volts (DC 12 volts optional) sources. Follow these procedures in order:

1. Connect the power inlet cable to power inlet connector of the panel PC.
2. Fasten the inlet tightly.

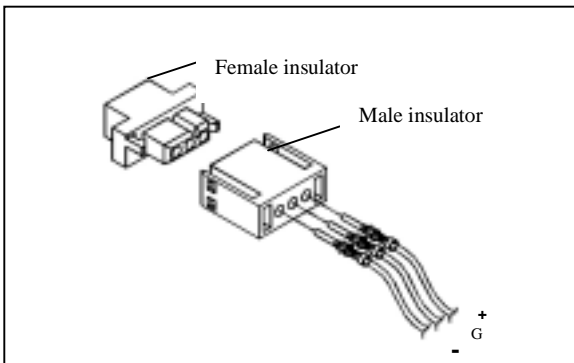
*Note: The red wire of power inlet cable for positive power source, the green wire is for frame ground and the black is for negative power source.*

### 2.3.2 Connecting the insulator to your power sources

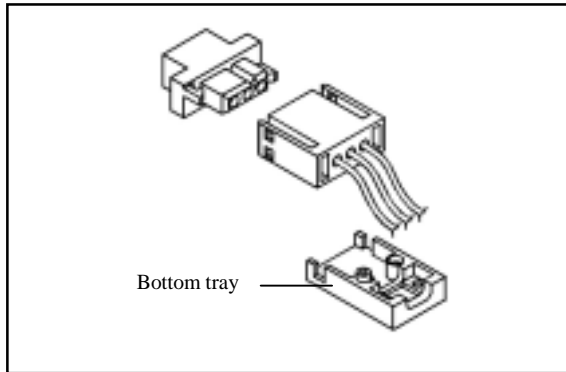
There are three male contact pins, three female contact pins and a pair of insulators in the accessory box. The installation procedure is described as follows:



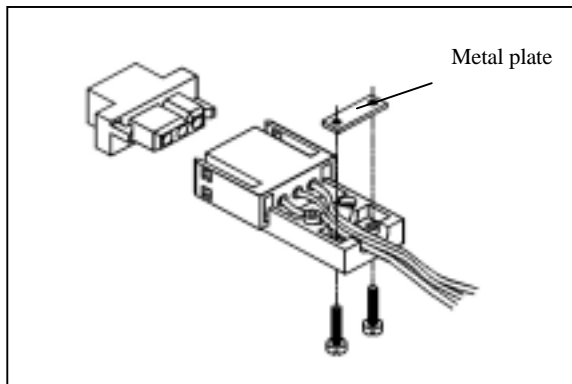
**STEP 1.** Connect the three contact pins individually to the negative and positive power cables of the power adaptor, as well as to the frame ground cable. Solder firmly.



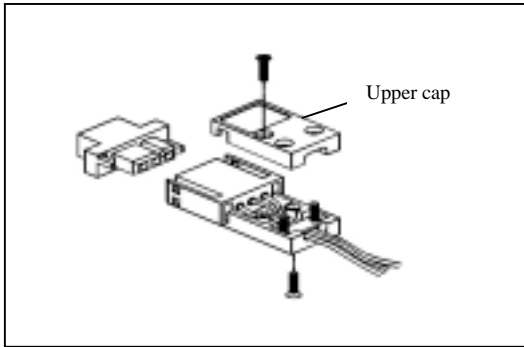
**STEP 2.** Align the soldered pins and their cables with the corresponding polarization marks on the front part of the male insulator (+ / G / -). Now plug the pins separately into the holes of the male insulator. Pin 1 should go into the positive DC power input (+), pin 2 connects to the frame ground (G), and pin 3 should be plugged into the negative DC power input (-).



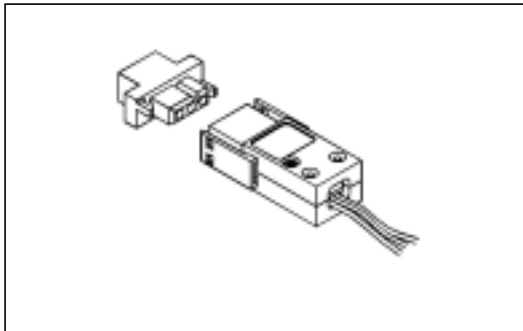
**STEP 3:** Mount the front part of the male insulator onto the bottom tray.



**STEP 4:** Use the metal plate and the two screws to secure the cables to the bottom tray. Please refer to the illustration above.



**STEP 5:** Attach the upper cap to the bottom tray and secure it with the screws.



**STEP 6:** Now that you have completed the assembly of the male insulator, plug it into the female insulator.

### 2.3.3 Installing a primary 2.5" HDD (plug-in)

You can attach one enhanced Integrated Device Electronics (IDE) hard disk drive to the PPC-A84/A120's internal controller which uses a PCI local-bus interface. The advanced IDE controller supports faster data transfer rates and allows the IDE hard drive to exceed 528MB. The following are instructions for installation:

1. Find the black HDD carrier, the 44-pin transfer connector and four pieces of M3x4 screws, and two long screws for the 44-pin transfer connector in the accessory box.
2. Connect the transfer connector to 2.5" HDD, screw the two screws to fix the transfer with the HDD.
3. Put the HDD inside the black carrier. Screw the 4 screws to fix the HDD to carrier from two sides of the carrier.
4. Unscrew the two screws of the cover on the top side of PPC-A84/A120 (See Fig.2-5). Open the cover.
5. Plug in the HDD carrier.
6. Close the cover and screw the two screws.

*Note: Make sure the power source to the PPC-A84/A120 has been disconnected, before you plug in or remove the HDD drive.*

### 2.3.4 Installing DRAM (SODIMM)

You can install anywhere from 16 MB to 128 MB of on-board DRAM memory using 16, 32, 64 or 128 MB 144-pin SODIMM (Small Outline Dual In-line Memory Modules).

The procedure for installing SODIMM appears below. Please follow these steps carefully.

1. Ensure that all power supplies to the system are switched Off.
2. Slip the SODIMM into the socket at a 45 degree angle and carefully fit the bottom of the card against the connectors.
3. Gently push the SODIMM into a perpendicular position until the clips on the ends of the SODIMM sockets snap into place.
4. Check to ensure that the SODIMM is correctly seated and all connector contacts touch. The SODIMM should not move around in its socket.

*Note: The modules can only fit into a socket one way and their gold pins must point down into the SODIMM socket.*



## 2.4 Installing I/O Equipment

---

### 2.4.1 Installing one external IDE (3.5" HDD/CD-ROM) device and an external FDD

Three connectors are located on the rear panel above the PPC-A84/A120's I/O output connectors. The 40-pin connector is for an external slave IDE devices (3.5 hard drive or CD-ROM). A 34-pin FDD connector is for an external FDD. Any combination of 5 1/4" (360 KB and 1.2 MB) and/or 3 1/2" (720 KB, 1.44 MB, and 2.88 MB) drives can be attached. The 4-pin connector provides +5 Vdc and +12 Vdc to both IDE device and FDD.

The following are instructions for installation:

1. Adjust the jumper setting of your IDE device to be a slave IDE device.
2. Unscrew the two attachment screws and detach the metal cover.
3. Connect the single end of the appropriate 40-pin cable to the PPC-A84/A120 and connect the remaining end to your IDE device.
4. Connect one end of a 34-pin daisy-chain drive connector cable to the PPC-A84/A120 and connect the remaining end to your FDD.
5. Connect the 4-pin Y-power cable to PPC-A84/A120, and the remaining two ends to your IDE device and FDD.

*Note: The 40-pin connector is a Primary Slave channel. The jumper setting of the IDE device should be adjusted to be a slave.*

## 2.4.2 PS/2 keyboard and PS/2 mouse

The PPC-A84/A120 provides two PS/2 connectors that support a PS/2 style keyboard and a PS/2 mouse. In most cases, especially in embedded applications, a keyboard is not used. The standard PC/AT BIOS will report an error or failure during power-on self-test (POST) after a reset if the keyboard is not present. The BIOS standard setup menu allows you to select\* "All , But Keyboard" under the "Halt On" selection. This allows no-keyboard operation in embedded system applications without the system halting under POST. Note that the mouse port on the PPC-A84/A120 is a PS/2 mouse port.

\* Note: "All, But keyboard" is the default setting.

## 2.4.3 Mic-in, line-in, speaker out

The PPC-A84/A120 is equipped with a high quality audio interface, which provides 16-bit CD quality recording and playback as well as OPL3 compatible FM music. It is supported by all major operating systems and is completely compatible with Sound Blaster Pro.

The audio interface includes three jacks: microphone in, line out and line in. (See Fig. 2-4.) Their functions are:

**Microphone in:** Use an external microphone to record voice and sound.

**Line out:** Output audio to external devices such as speakers or earphones.

**Line in:** Input audio from an external CD player or radio.

1. Connect the audio device to the system.
2. Install the driver before you use the device.

## 2.4.4 External VGA

The PPC-A84/A120 can be connected to an external CRT monitor. To connect an external CRT monitor, connect the monitor's VGA cable to the PPC-A84/A120's VGA port and connect the monitor's power cable to an AC outlet. The PPC-A84/A120's external CRT display (VGA) connector is a standard 15-pin D-SUB connector commonly used for VGA.

## 2.4.5 Two serial COM ports

There are two serial COM ports on the bottom of the rear cover. You can easily attach a serial device to the panel PC, such as an external modem or mouse. Follow these instructions:

1. Be sure the panel PC and any other peripheral devices you may have connected to the panel PC are turned off.
2. Attach the interface cable of the serial device to the panel PC's serial port. If necessary, attach the other end of the interface cable to your serial device. Fasten any retaining screws.
3. Turn on any other peripheral devices you may have connected to the panel PC, and then turn on the panel PC.
4. Refer to the manual(s) which accompanied your serial device(s) for instructions on configuring your operating environment to recognize the device(s).
5. Run the BIOS setup program and configure the jumper settings to change the mode of the COM ports.

## 2.4.6 USB ports

The external USB device may be connected to the system through the 4-pin USB ports located on the rear side of the system unit.

1. Connect the external device to the system.
2. The USB ports support hot plug-in connection. You should install the device driver before you use the device.

## 2.4.7 Parallel port

The panel PC supports the latest EPP and ECP parallel port protocols for improved performance and versatility with compatible printers or other devices.

To connect the panel PC to a printer or other devices:

1. Be sure both the panel PC and the printer/devices are turned off.
2. Connect the 25-pin male connector of the printer cable to the 25-pin female port on the panel PC labelled "parallel port".
3. If necessary, attach the other end of your printer cable to your printer, and fasten any retaining screws.
4. Turn on the printer and any other peripheral devices you may have connected to the panel PC, and then turn on the panel PC.
5. If necessary, run the panel PC's BIOS setup program to configure the parallel port to respond as required by your printer and software operating environment.

## 2.4.8 Ethernet

The PPC-A84/A120 is equipped with a high performance 32-bit Ethernet chipset which is fully compliant with the IEEE 802.3 100 Mbps CSMA/CD standards. It is supported by major network operating systems. It is also both 100Base-T and 10Base-T compatible. The medium type can be configured via the RSET8139.EXE program included on the utility disk.

The Ethernet port provides a standard RJ-45 jack. The network boot feature can be utilized by incorporating the boot ROM image files for the appropriate network operating system. The boot ROM BIOS files are combined with system BIOS, which can be enabled/disabled in the BIOS setup.

## 2.5 How to Install Software to the HDD

---

Installing software requires an installed HDD. Software can be loaded in the PPC-A84/A120 using any of four methods:

### 2.5.1 Method 1: Use the Ethernet

You can use the Ethernet port to download software to the HDD.

### 2.5.2 Method 2: Use an FDD

The FDD port is located on the rear panel. Unscrew the two screws and detach the metal plate. Attach a communication cable and a power cable to the FDD port, then attach them to an FDD drive. Insert a disk containing the software in FDD drive to proceed the installation.

### 2.5.3 Method 3: Use the COM or parallel port

You can use Lap Link 6 or similar transmission software. Connect another PC to the PPC-A84/A120 with an appropriate cable and transmit the software to the PPC-A84/A120.

### 2.5.4 Method 4: Use a 3.5" HDD or CD-ROM

Please refer to Section 2.4.1 "Installing one external IDE (3.5" HDD/CD-ROM) device".

## 2.6 Running the BIOS Setup Program

---

Your panel PC is likely to have been properly set up and configured by your dealer prior to delivery. You may still find it necessary to use the panel PC's BIOS (Basic Input-Output System) setup program to change system configuration information, such as the current date and time or your type of hard drive. The setup program is stored in read-only memory (ROM). It can be accessed either when you turn on or reset the panel PC, by pressing the "Del" key on your keyboard immediately after powering on the computer.

The settings you specify with the setup program are recorded in a special area of memory called CMOS RAM. This memory is backed up by a battery so that it will not be erased when you turn off or reset the system. Whenever you turn on the power, the system reads the settings stored in CMOS RAM and compares them to the equipment check conducted during the power on self-test (POST). If an error occurs, an error message will be displayed on screen, and you will be prompted to run the setup program.

If you want to change the setup of BIOS, refer to Chapter 8 for more detailed information.

## 2.7 Installing System Software

---

Recent releases of operating systems from major vendors include setup programs which load automatically and guide you through hard disk preparation and operating system installation. The guidelines below will help you determine the steps necessary to install your operating system on the panel PC hard drive.

*Note: Some distributors and system integrators may have already pre-installed system software prior to shipment of your panel PC.*

If required, insert your operating system's installation or setup diskette into the diskette drive until the release button pops out.

The BIOS of the panel PC supports system boot-up directly from the CD-ROM drive. You may also insert your system installation CD-ROM into the CD-ROM drive. Refer to Chapter 8 - BIOS Setup if you wish to change the BIOS settings.

Power on your panel PC or reset the system by pressing the "Ctrl"+"Alt"+"Del" keys simultaneously. The panel PC will automatically load the operating system from the diskette or CD-ROM.

If you are presented with the opening screen of a setup or installation program, follow the instructions on screen. The setup program will guide you through preparation of your hard drive, and installation of the operating system.

If you are presented with an operating system command prompt, such as A:\>, then you must partition and format your hard drive, and manually copy the operating system files to it. Refer to your operating system user's manual for instructions on partitioning and formatting a hard drive.

## 2.8 Installing the Drivers

---

After installing your system software, you will be able to set up the Ethernet, SVGA, audio, and touchscreen functions. All the drivers are stored in a CD-ROM disc entitled "Drivers and Utilities" which can be found in your accessory box.

The standard procedures for installing the Ethernet, SVGA, audio, and touchscreen drivers are described in Chapters 4, 5, 6 and 7 respectively.

The various drivers and utilities in the CD-ROM disc have their own text files which help users install the drivers and understand their functions. These files are a very useful supplement to the information in this manual.

**Note:** *The drivers and utilities used for the PPC-A84/A120 panel PCs are subject to change without notice. If in doubt, check Advantech's web site or contact our application engineers for the latest information regarding drivers and utilities.*





## **The Engine of the PPC-A84/A120 (PCM-5821)**

- Introduction
- Features
- Jumpers and Connectors
- Wake on LAN selection
- CMOS clear
- Watchdog timer configuration
- COM2 RS-232/422/485 setting
- Buzzer enable

## 3.1 Introduction

---

The PCM-5821 is a highly reliable single board computer based on the NS GXm 233/GX1 300MHz CPU. It offers built-in functionality comparable to a complete industrial PC system, including a VGA/LCD controller, network communications, compact flash disk in a small 8" x 5.75" form factor.

For maximum performance, the PCM-5821 also supports an SDRAM SODIMM socket that can accept up to 128 MB memory. On-board features include an Ethernet interface, audio interface, socket for Compact Flash Card, Enhanced IDE interface with up to Ultra DMA transfer protocol, one parallel port, two serial ports (RS-232 and RS-232/422/485) with DB-9 connector as COM1, and a mini-DIN PS/2 keyboard/mouse interface. An SVGA/LCD display controller (LCD, and CRT displays) allows LCD screen resolutions up to 1024 x 768 and CRT resolutions up to 1280 x 1024 @ 16 M colors.

The PCM-5821 complies with the "Green Function" standard and supports three types of power saving features: Normal, Doze, and Sleep modes.

The display type configuration is done through software. A single Flash chip holds the system BIOS and the VGA BIOS. This minimizes the number of chips and eases configuration. You can change the display BIOS simply by programming the Flash chip.

It also offers faster data access and longer MTBF than mechanical disk drives and is an ideal solution for critical commercial or industrial applications. The watchdog timer ensures the system will be reset if it stops due to a program bug or EMI problem.

## 3.2 Features

---

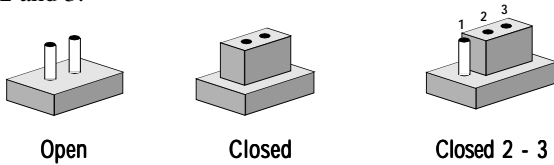
- Ultra-compact size single board computer as small as a 3 1/2" hard disk drive (145 mm x 102 mm)
- On-board NS GXm 233/GX1 300 MHz CPU
- Up to 128 MB system memory by SODIMM (SDRAM)
- On-board VGA/LCD controller
- On-board 10/100Base-T Ethernet interface
- Supports on-board CompactFlash™ socket
- Built-in Enhanced IDE (AT bus) hard disk drive interface
- Two serial ports: one RS-232, one RS-232/422/485 or infrared selectable (uses 16C550 UARTs with 16 byte FIFO)
- Green engine with sleep mode and low power consumption
- Single +5 V power supply

## 3.3 Jumpers and Connectors

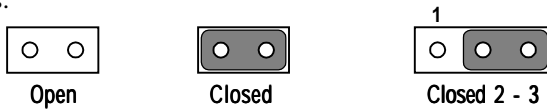
---

### 3.3.1 Setting jumpers

You can configure your panel PC to match the needs of your application by setting jumpers. A jumper is the simplest kind of electrical switch. It consists of two metal pins and a small metal clip (often protected by a plastic cover) that slides over the pins to connect them. To “close” a jumper, you connect the pins with the clip. To “open” a jumper you remove the clip. Sometimes a jumper will have three pins, labeled 1, 2, and 3. In this case, you would connect either pins 1 and 2 or pins 2 and 3.



The jumper settings are schematically depicted in this manual as follows:



A pair of needle-nose pliers may be helpful when working with jumpers.

If you have any doubts about the best hardware configuration for your application, contact your local distributor or sales representative before you make any changes.

### 3.3.2 Jumpers

The motherboard of the panel PC has a number of jumpers that allow you to configure your system to suit your applications. The table below lists the function of each of the board jumpers.

---

Table 3-1: Jumpers and their functions

---

<b>Label</b>	<b>Function</b>
JP1	Power type of Lan
JP2	CMOS Clear and Watchdog Timer action
JP3	COM2 RS-232/422/485 Setting
JP4	COM2 RS-232/422/485 Setting
JP5	COM2 RS-232/422/485 Setting
JP10	Buzzer enable

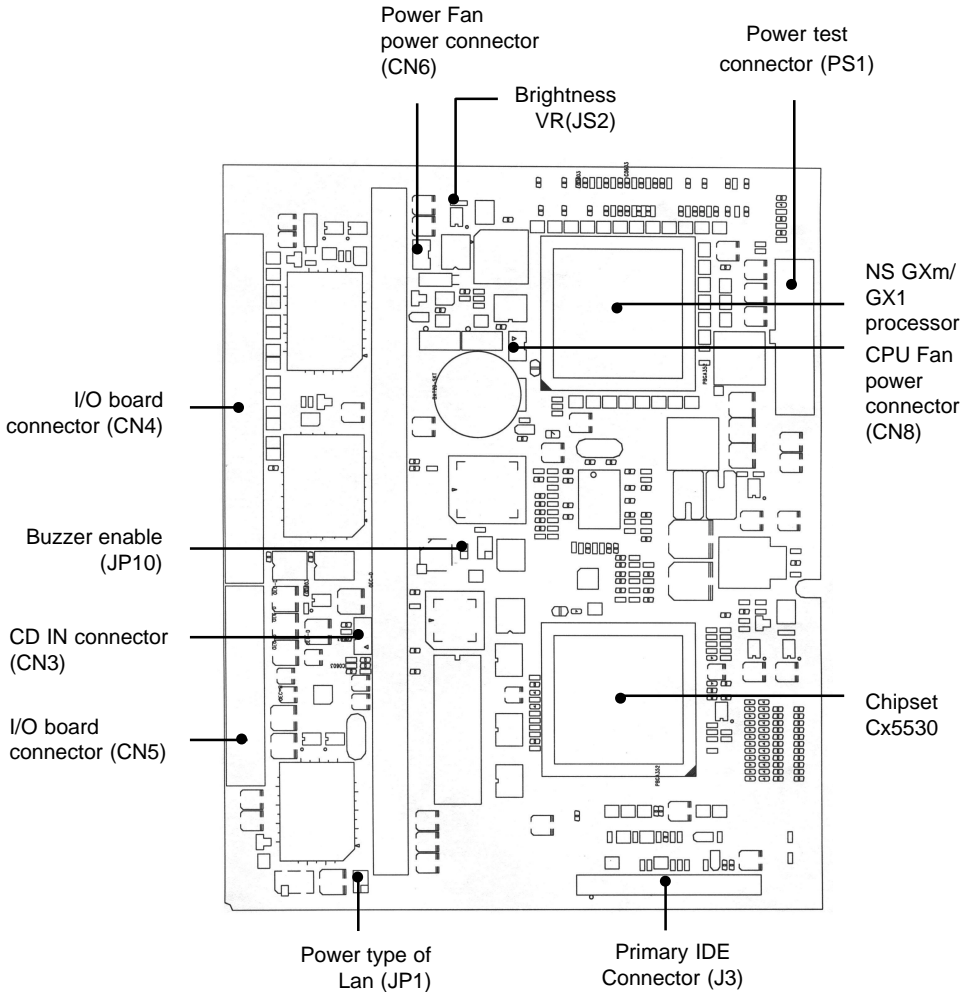
---

### 3.3.3 Connectors

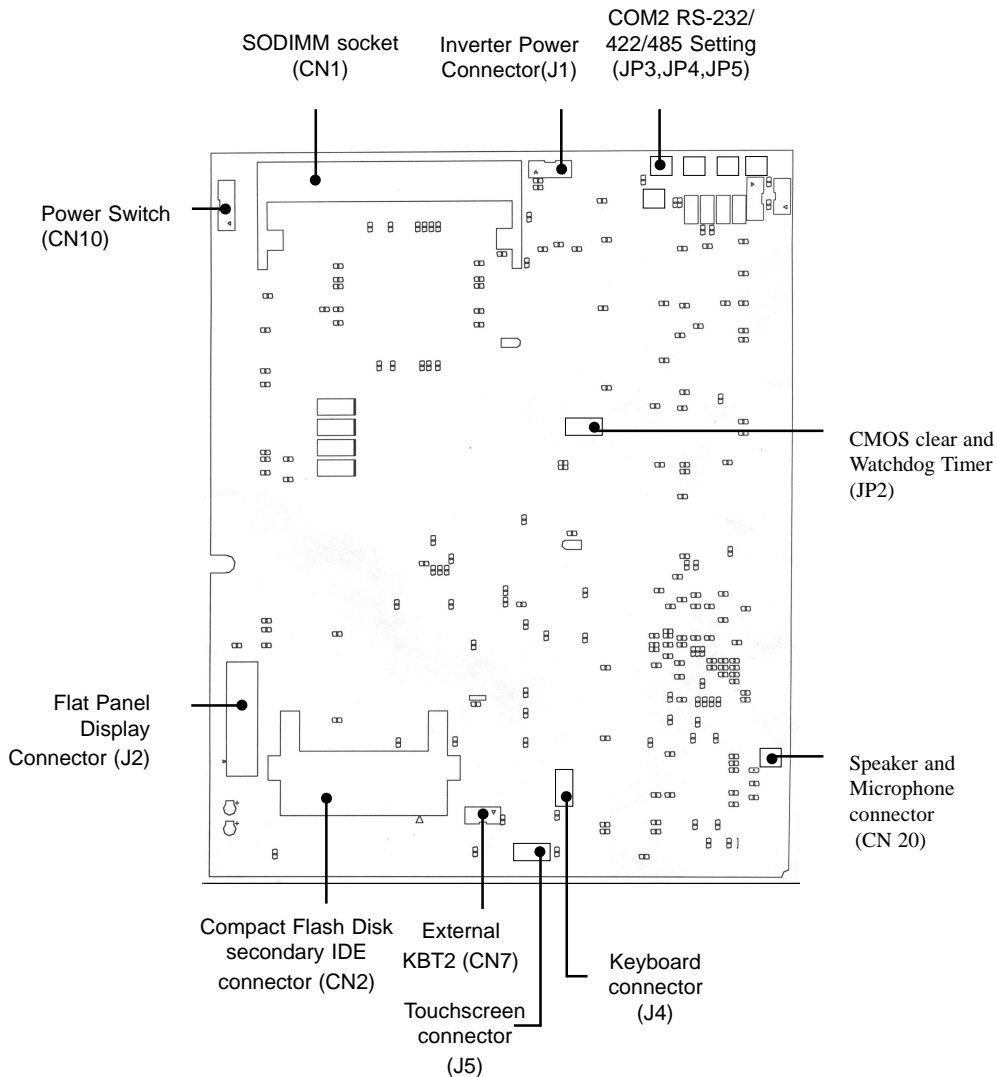
Onboard connectors link the panel PC to external devices such as hard disk drives or floppy drives. The table below lists the function of each of the board's connectors.

Table 3-2: Panel PC connectors

<b>Label</b>	<b>Function</b>
J1	Inverter power connector
J2	Flat panel display connector
J3	Primary IDE hard drive connector
J4	Keyboard connector
J5	Internal touchscreen connector
CN1	SODIMM socket
CN2	Compact Flash Disk secondary IDE connector
CN3	CD IN
CN4	I/O board connector
CN5	I/O board connector
CN6	Power FAN power connector
CN7	External KBT2
CN8	CPU FAN power connector
CN10	Power Switch
CN20	Speaker and Microphone connector (Reserved)
PS1	Power test connector (Reserved)
JS2	Brightness VR (Reserved)



**Figure 3-1: Locating jumpers and connectors on PCM-5821 (front side)**



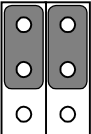
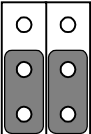
**Figure 3-2: Locating jumpers and connectors PCM-5821 (rear side)**



### 3.4 Wake on LAN Selection (Reserved) (JP1)

The PCM-5821 provides Wake-on LAN function when ATX power is used. To enable Wake-on LAN function, the JP1 should be set as shown below:

Table 3-3: Wake-on LAN selection (JP1)


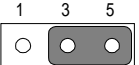
*Normal Power		Wake-on LAN	
1		1	
3		3	
5		5	
2		2	
4		4	
6		6	

\* default setting

### 3.5 CMOS Clear (JP2)

*Warning:* To avoid damaging the computer, always turn off the power supply before setting "Clear CMOS". Set the jumper back to "Normal operation" before turning on the power supply.

Table3-4: Clear CMOS/External RTC (JP2)

*Normal operation	Clear CMOS
	
1 3 5	1 3 5

\* default setting

### 3.6 Watchdog Timer Configuration

An onboard watch timer reduces the chance of disruptions which EMP (electromagnetic pulse) interference can cause. This is an invaluable protective device for standalone or unmanned applications. Setup involves one jumper and running the control software. (Refer to Appendix A.)

### 3.6.1 Watchdog activity selection (JP2)

When the watchdog timer activates (i.e. CPU processing has come to a halt), it can reset the system or generate an interrupt on IRQ11. This can be set via jumper JP2 as shown below:

Table3-5: Watchdog activity selection (JP2)

System reset			IRQ11		
2	4	6	2	4	6
<input checked="" type="checkbox"/>	<input checked="" type="checkbox"/>	<input type="checkbox"/>	<input type="checkbox"/>	<input checked="" type="checkbox"/>	<input checked="" type="checkbox"/>

\* default setting

## 3.7 COM2 RS-232/422/485 setting (JP3, JP4,JP5)

COM2 can be configured to operate in RS-232/422/485 mode. This is done via JP3,JP4,and JP5.

Table 3-6: COM2 RS-232/422/485 setting (JP3, JP4)

		*RS-232			RS-422/485		
JP4	2	<input checked="" type="checkbox"/>	<input checked="" type="checkbox"/>	<input type="checkbox"/>	2	<input type="checkbox"/>	<input checked="" type="checkbox"/>
	1	<input checked="" type="checkbox"/>	<input checked="" type="checkbox"/>	<input type="checkbox"/>	1	<input type="checkbox"/>	<input checked="" type="checkbox"/>
JP3	2	<input checked="" type="checkbox"/>	<input checked="" type="checkbox"/>	<input type="checkbox"/>	2	<input type="checkbox"/>	<input checked="" type="checkbox"/>
	1	<input checked="" type="checkbox"/>	<input checked="" type="checkbox"/>	<input type="checkbox"/>	1	<input checked="" type="checkbox"/>	<input checked="" type="checkbox"/>

\* default setting

Table 3-7: COM2 RS-232/422/485 setting (JP5)

*RS-232	RS-422	RS-485																											
<table border="1"> <tr> <td>2</td> <td>4</td> <td>6</td> </tr> <tr> <td></td> <td></td> <td></td> </tr> <tr> <td>1</td> <td>3</td> <td>5</td> </tr> </table>	2	4	6				1	3	5	<table border="1"> <tr> <td>2</td> <td>4</td> <td>6</td> </tr> <tr> <td></td> <td></td> <td></td> </tr> <tr> <td>1</td> <td>3</td> <td>5</td> </tr> </table>	2	4	6				1	3	5	<table border="1"> <tr> <td>2</td> <td>4</td> <td>6</td> </tr> <tr> <td></td> <td></td> <td></td> </tr> <tr> <td>1</td> <td>3</td> <td>5</td> </tr> </table>	2	4	6				1	3	5
2	4	6																											
1	3	5																											
2	4	6																											
1	3	5																											
2	4	6																											
1	3	5																											

\*default setting

### 3.8 Buzzer enable (JP10)

Table 3-8: Buzzer enable (JP10)

*Enable	Disable

\* default setting



# CHAPTER 4

## PCI Bus Ethernet Interface

This chapter provides information on Ethernet configuration.

- Introduction
- Installation of Ethernet Driver
  - Installation for WINDOWS 95
  - Installation for WINDOWS 98
  - Installation for WINDOWS NT
- Further Information

## 4.1 Introduction

---

The PPC-A84/A120 is equipped with a high performance 32-bit Ethernet chipset which is fully compliant with IEEE 802.3 100 Mbps CSMA/CD standards. It is supported by major network operating systems. It is also both 100Base-T and 10Base-T compatible. The medium type can be configured via the RSET8139.exe program included on the utility disk.

The Ethernet port provides a standard RJ-45 jack. The network boot feature can be utilized by incorporating the boot ROM image files for the appropriate network operating system. The boot ROM BIOS files are combined with system BIOS, which can be enabled/disabled in the BIOS setup.

## 4.2 Installation of Ethernet Driver

---

Before installing the Ethernet driver, note the procedures below. You must know which operating system you are using in your PPC-A84/A120, and then refer to the corresponding installation flow chart. Then just follow the steps described in the flow chart. You will quickly and successfully complete the installation, even if you are not familiar with instructions for WINDOWS.

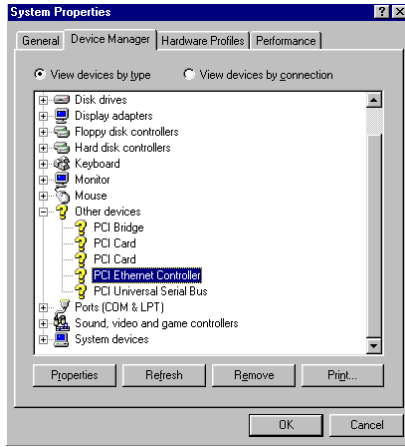
*Note 1: The windows illustrations in this chapter are examples only. You must follow the flow chart instructions and pay attention to the instructions which then appear on your screen.*

*Note 2: The CD-ROM drive is designated as "D" throughout this chapter.*

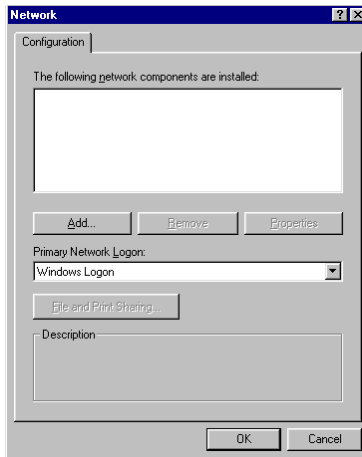
*Note 3: <Enter> means pressing the "Enter" key on the keyboard.*

## 4.2.1 Installation for WINDOWS 95

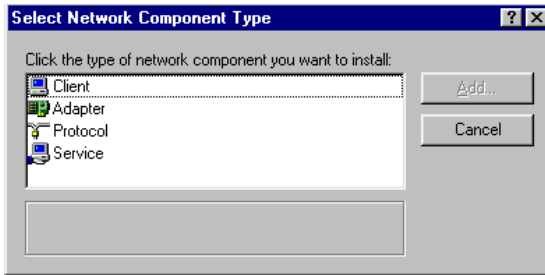
1. a. Select "Start," "Settings" and "Control Panel"
- b. Click "Device Manager," "Other Devices"
- c. Remove "PCI Ethernet Controller" item



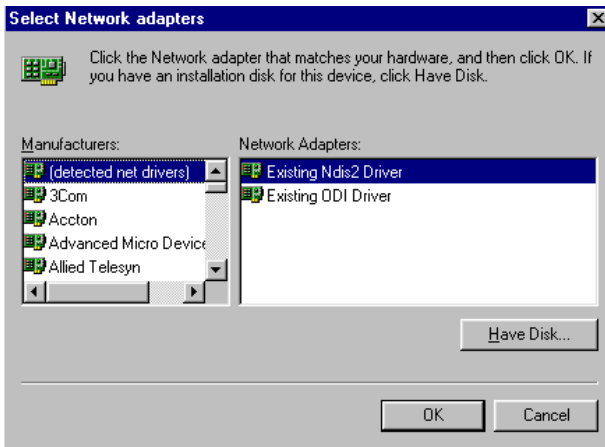
2. a. Select "Start", "Settings," "Control Panel" and "Network"
- b. Click "Add"



3. Select "Adapter" and then click "OK"



4. Press "Have Disk..."

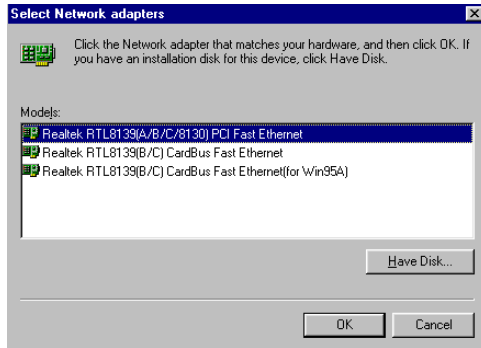


5. a. Type the path "D:\WIN95\LAN"  
b. Click "OK"

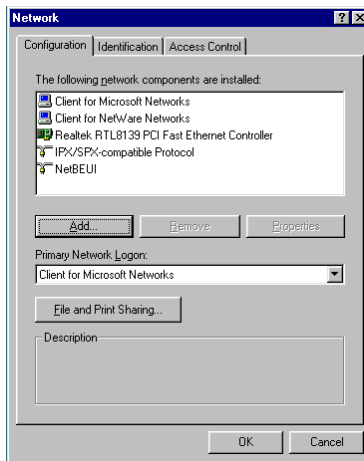




6. a. Select "Realtek RTL8139(A\B\C\8130) PCI Fast Ethernet"
- b. Click "OK"



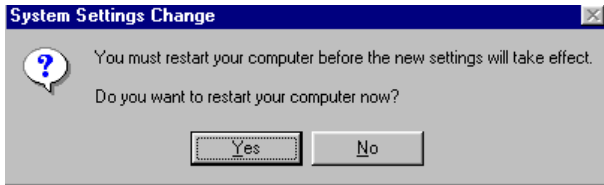
7. Click "OK"



8. a. Insert "Win95" CD to load related file
- b. Click "OK"



9. Press "Yes" to start computer.

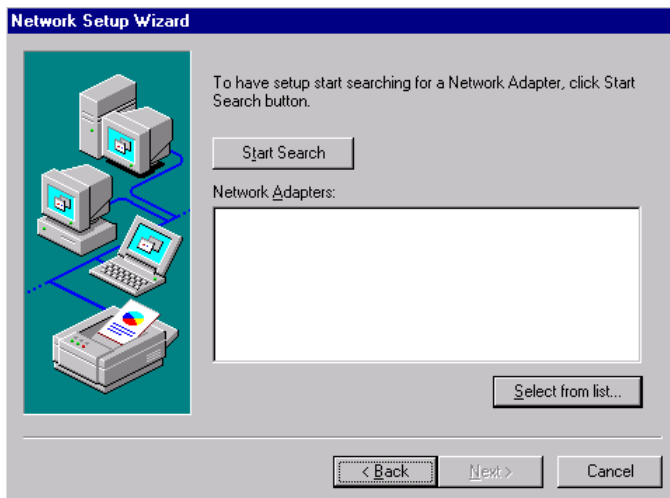


## **4.2.2 Installation for WINDOWS 98**

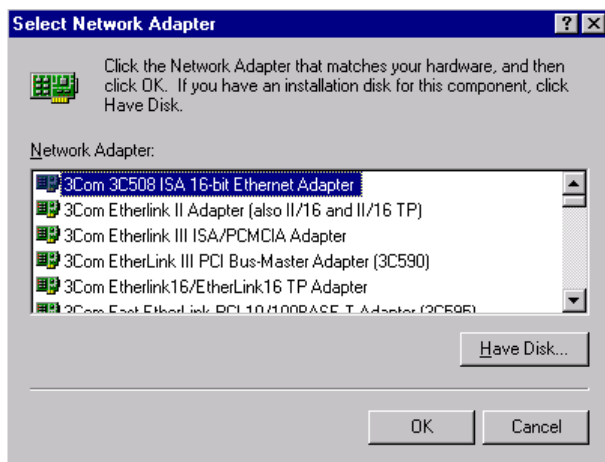
Note that installation of the LAN drivers for Windows 98 is automatic and installation of the PCI Ethernet card is Plug-and-Play. No further instruction is necessary.

## 4.2.3 Installation for WINDOWS NT

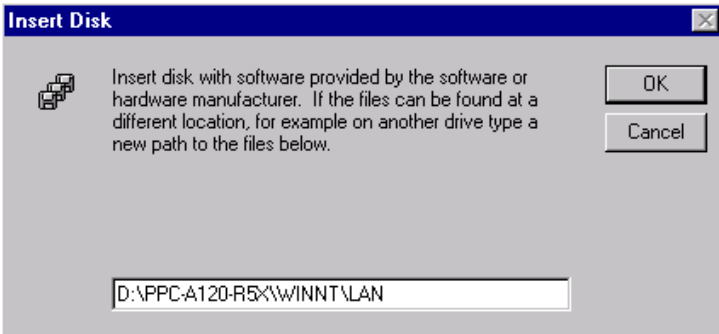
1. a. Select "Start," "Settings," "Control Panel" and double click "Network"
- b. Select from the list



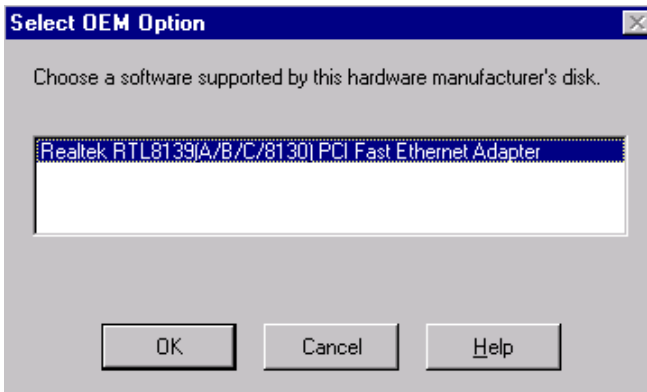
2. Press "Have Disk..."



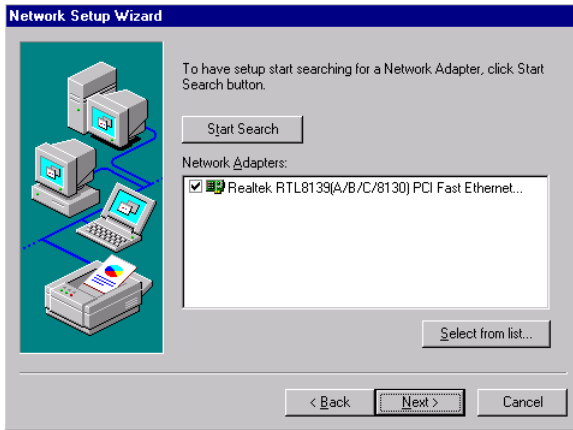
3. a. Insert the "Drivers and Utilities" CD
- b. Enter the path "D:\PPC-A120-R5X\WINNT\LAN"
- c. Press "OK"



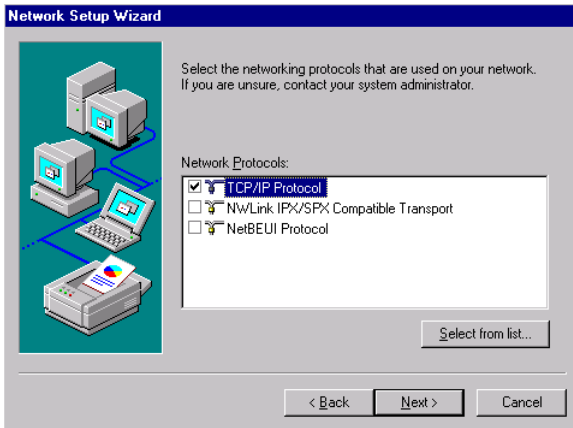
4. a. Choose "The TL8139 Fast Ethernet/Adapter"
- b. Click "OK"



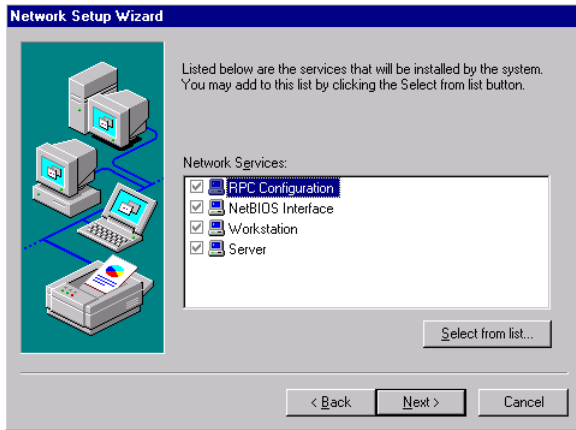
5. Click "Next"



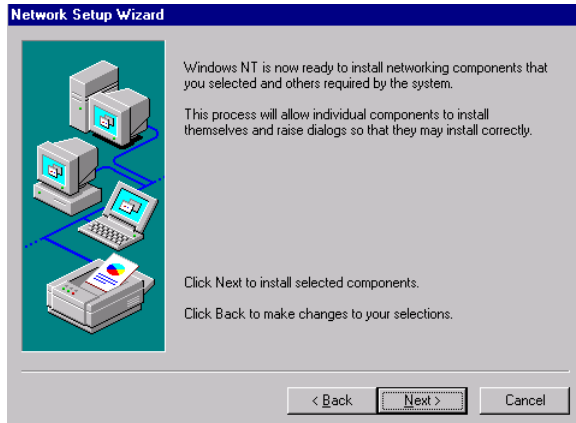
6. Click "Next"



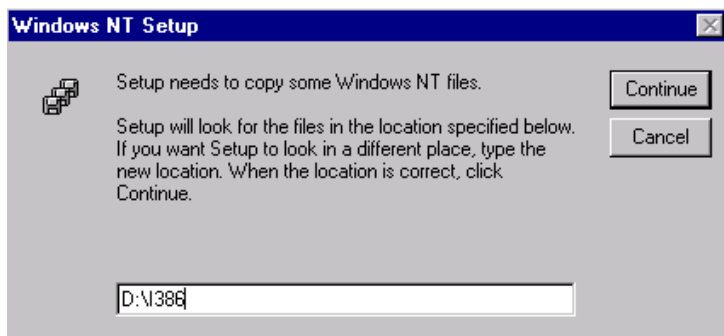
## 7. Click "Next"



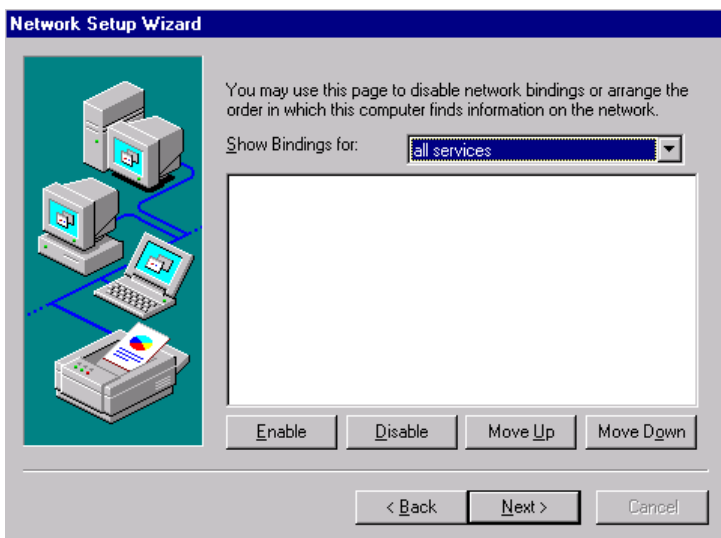
## 8. Click "Next"



9. a. Insert "WINNT" CD
- b. Click "Continue"

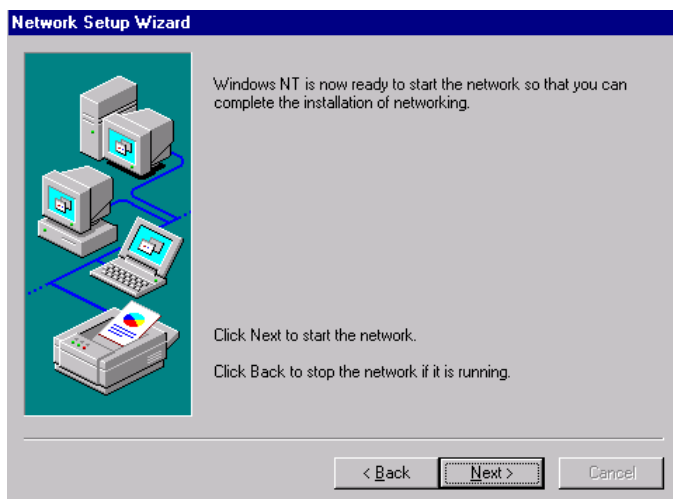


10. Click "Next"





## 11. Click "Next"



## 4.3 Further Information

---

Realtek web site: [www.realtek.com.tw](http://www.realtek.com.tw)

Advantech web site: [www.advantech.com](http://www.advantech.com)  
[www.advantech.com.tw](http://www.advantech.com.tw)



# CHAPTER 5

## PCI SVGA Setup

- Introduction
- Installation of SVGA Driver
  - Installation for Windows 95
  - Installation for Windows 98
  - Installation for Windows NT
- Further Information

## 5.1 Introduction

---

The PPC-A84/A120 has an on-board PCI flat panel/VGA interface. The specifications and features are described as follows:

### 5.1.1 Chipset

The PPC-A84/A120 Series uses a NS CX5530 chipset for its SVGA controller. It supports many popular 18-bit LCD displays and conventional analog CRT monitors. The VGA BIOS supports LCD. In addition, it also supports interlaced and non-interlaced analog monitors (color and monochrome VGA) in high-resolution modes while maintaining complete IBM VGA compatibility. Digital monitors (i.e. MDA, CGA, and EGA) are NOT supported. Multiple frequency (multisync) monitors are handled as if they were analog monitors.

### 5.1.2 Display memory

With 2 ~ 4 MB share memory, the VGA controller can drive CRT displays or color panel displays with resolutions up to 1024 x 768 at 64 K colors. The display memory can be expanded to 4 MB in BIOS for true-color resolution of 1024 x 768.

### 5.1.3 Display types

CRT and panel displays can be used simultaneously. The PPC-A84/120 can be set in one of three configurations: on a CRT, on a flat panel display, or on both simultaneously. The system is initially set to simultaneous display mode.

## 5.2 Installation of SVGA Driver

---

Complete the following steps to install the SVGA and audio driver. Follow the procedures in the flow chart that apply to the operating system that you are using within your PPC-A84/A120 .

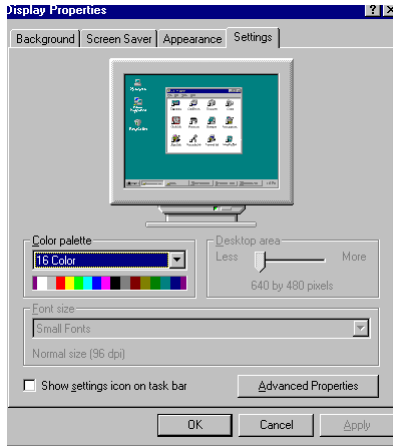
*Note1: The following windows illustrations are examples only. You must follow the flow chart instructions and pay attention to the instructions which then appear on your screen.*

*Note2: The CD-ROM drive is designated as "D" throughout this chapter.*

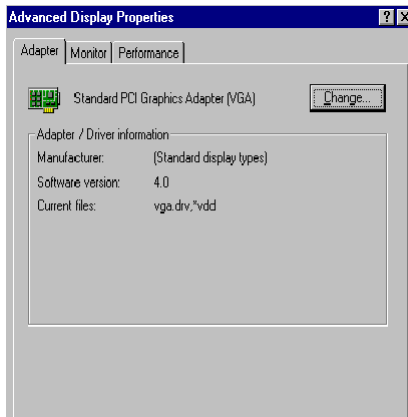
*Note3: <Enter> means pressing the "Enter" key on the keyboard.*

## 5.2.1 Installation for Windows 95

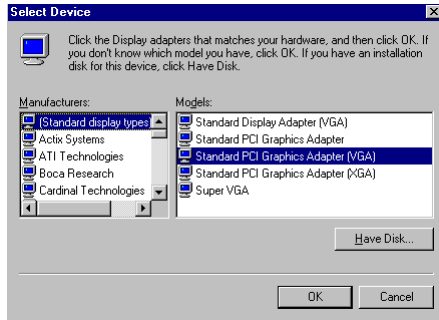
1. a. Select "Start," "Settings," "Control Panel," "Display," "Settings"
- b. Press "Advanced Properties"



2. a. Choose "Adapter" tab
- b. Press the "Change..." button



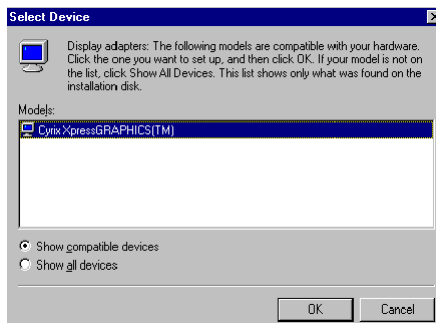
3. Press the "Have Disk" button.



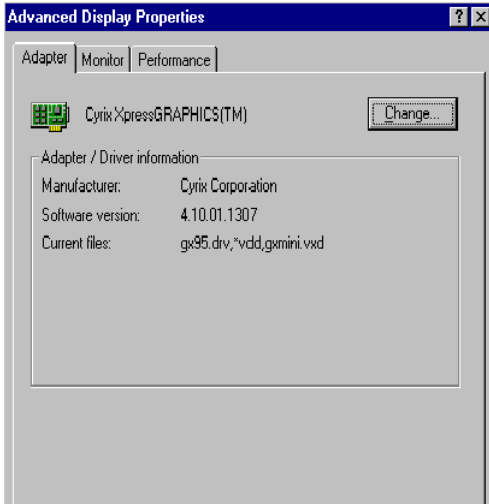
4. a. Insert the utility disk into the CD-ROM drive
- b. Type "D:\WIN95\VGA"
- c. Press "OK"



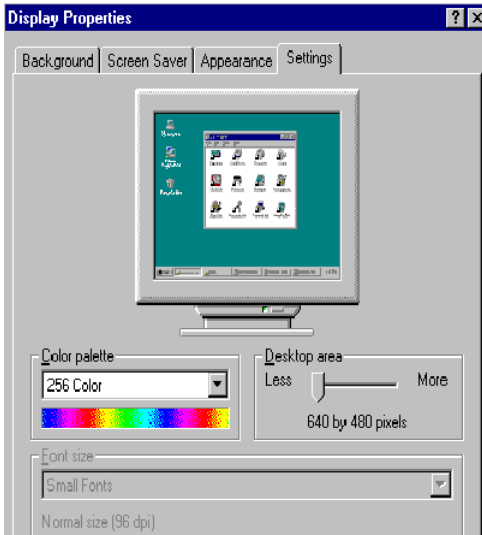
5. a. Select the highlighted "Control Panel" item
- b. Click the "OK" button.



6. a. Cyrix Xpress Graphics™ appears in the adapter tab
- b. Click "Apply" and then "OK"

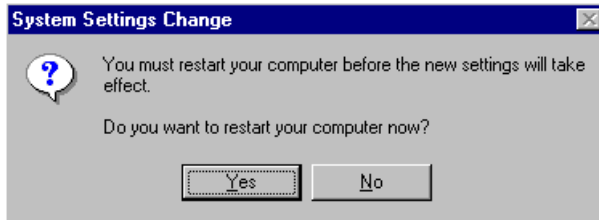


7. Press "close"



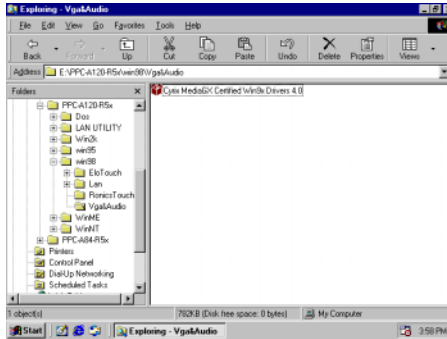


8. Press "Yes" to reboot

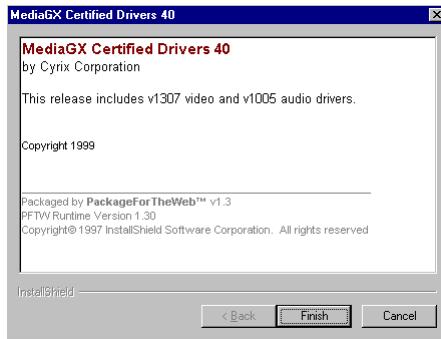


## 5.2.2 Installation for WINDOWS 98

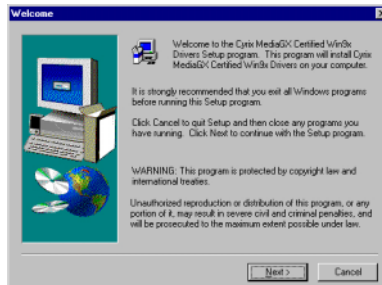
1. Click the EXE file



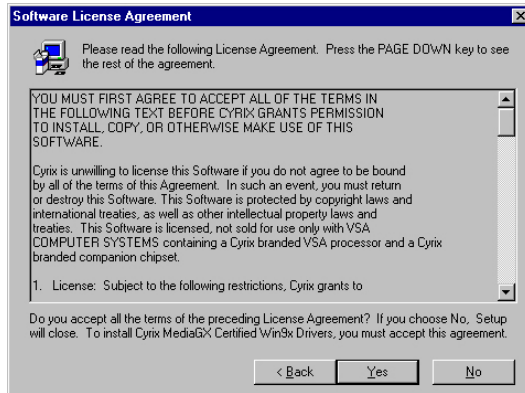
2. Press "Finish"



3. Press "Next"

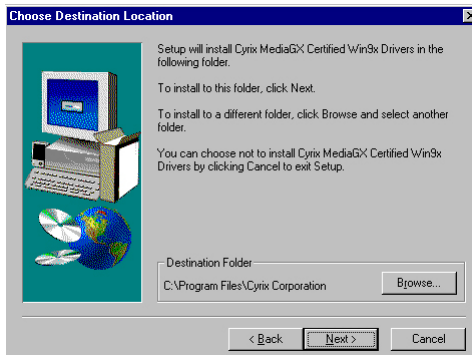


#### 4. Click "Yes"

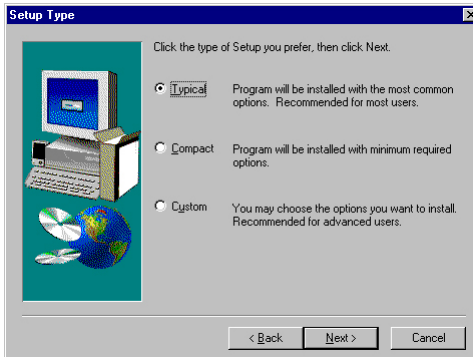


#### 5. a. Insert "Windows 98 CD-ROM"

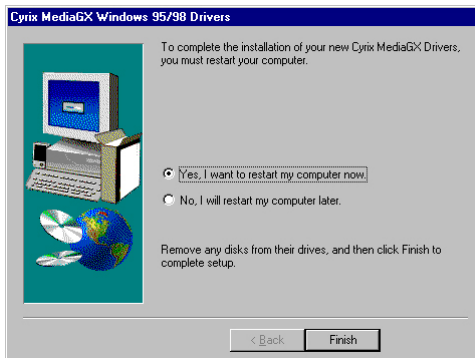
#### b. Click "Next"



6. Click "Typical"



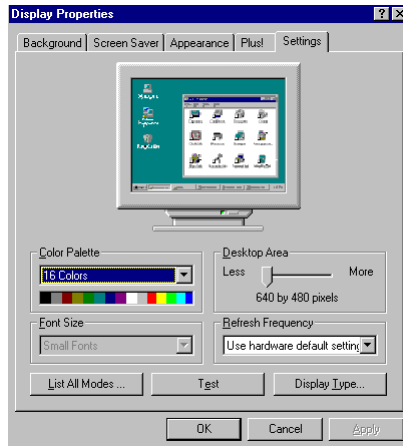
7. Click "Finish" to complete installation



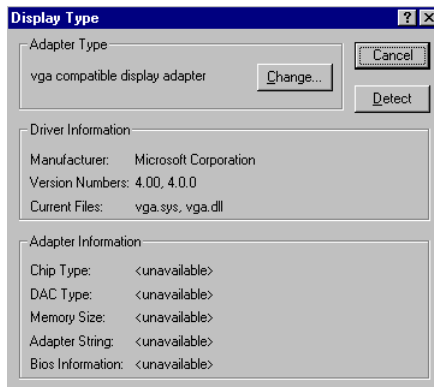
*Note: A common driver for Windows98 is used on both SVGA and Audio. While installing the SVGA driver for Windows98, as seen in the above procedure, the Audio driver will also be installed simultaneously.*

## 5.2.3 Installation for WINDOWS NT

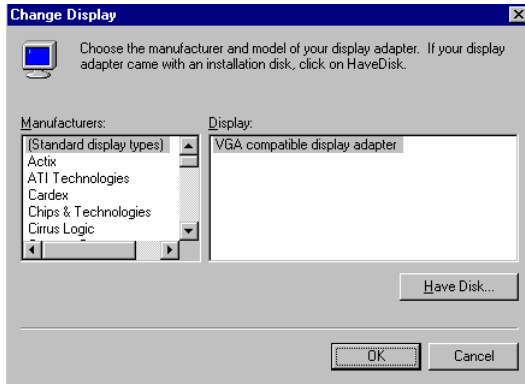
1. a. Select "Start," "Settings," "Control Panel"
- b. Double click "Display"
- c. Choose the "Settings" tab
- d. Press "Display Type"



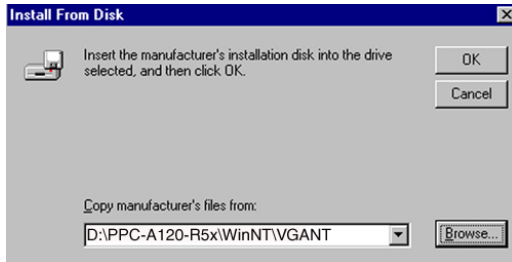
2. Press "Change..."



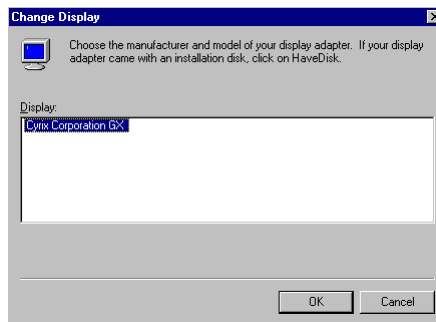
3. Click "Have Disk"



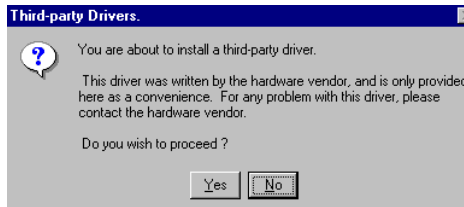
- 4. a. Insert the disk into the CD-ROM drive
- b. Type the driver path
- c. Press "OK"



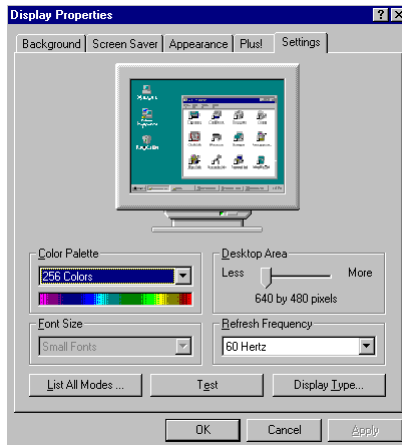
- 5. a. Select the highlighted item
- b. Press "OK"



6. Press "Yes"



- 7. a. Repeat Step 1
- b. Adjust resolution and color
- c. Click "Test" to see the result
- d. Click "OK"



## 5.3 Further Information

For further information about the PCI/SVGA and audio installation in your PPC-A84/A120, including driver updates, troubleshooting guides and FAQ lists, visit the following web resources:

- NS web site: [www.nsc.com](http://www.nsc.com)
- Advantech web sites: [www.advantech.com](http://www.advantech.com)  
[www.advantech.com.tw](http://www.advantech.com.tw)





## Touchscreen

- Introduction
- Installation of Touchscreen Driver
  - Installation for DOS
  - Installation for Windows 95
  - Installation for Windows 98
  - Installation for Windows NT

## 6.1 Introduction

---

The PPC-A84/A120 optional touch screen incorporates advanced second-generation 4-wire resistive technology. They allow 72% light transmission respectively. The resistive model has an antiglare surface. Anyway, this produces greatly enhanced visual resolution. They also have a newly improved scratch-resistant features. Please refer to the chapter 1. All of the specifications of touchscreens can be found in chapter 1.2.

## 6.2 Installation of Touch Screen Driver for the PPC-A84

---

The touchscreen driver for Windows 95 contains a native, 32-bit driver designed for Windows 95/98 and a 32-bit control panel program for the PPC-A84 system.

To facilitate the installation of the touchscreen driver, you should read the instructions in this chapter carefully before you attempt installation.

*Note 1: The PPC-A84 uses the Dynapro 4-wire resistive touchscreen equipped with Ronics controller board and drivers. When installing the touchscreen drivers, you will find the drivers in RonicsTouch directory.*

*Note 2: The following windows illustrations are examples only. You must follow the flow chart instructions and pay attention to the instructions which then appear on your screen.*

*Note 3: The CD-ROM drive is designated as "D" throughout this chapter.*

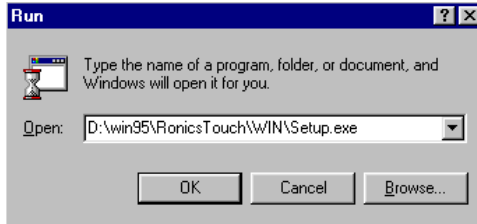
*Note 4: <Enter> means pressing the "Enter" key on the keyboard.*

### **6.2.1 Installation for MS-DOS**

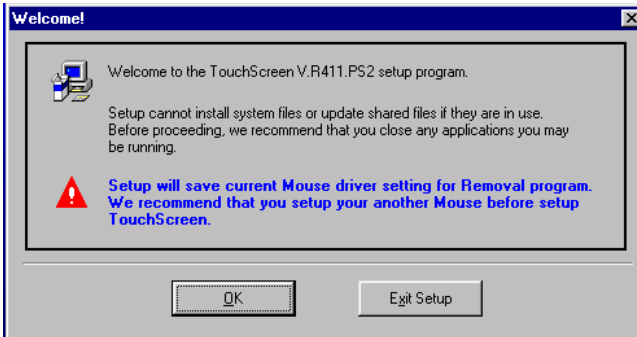
1. Change the directory to D:\DOS\RONICSTOUCH\
2. Type the command "Install C:" [Enter]. Installing system software automatically creates a directory named: "TSR411.PS2" in C drive.
3. Change the directory to C:\TSR411.PS2\.
4. Type "M" in the directory (TSR411.PS2) to install touchscreen driver.
5. Type "S" to calibrate the touchscreen.

## 6.2.2 Installation for Windows 95

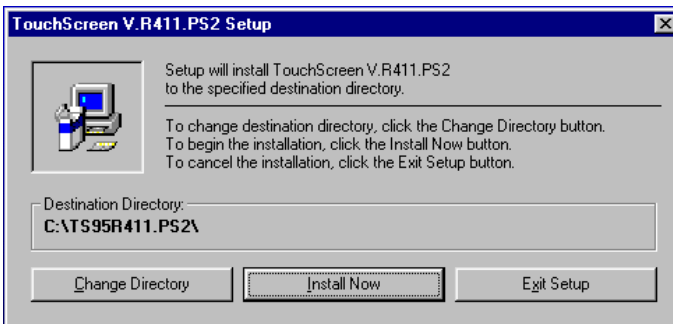
1. a. Insert "Drivers and Utilities" CD
  - b. Click "Start" and "Run"
  - c. Enter "D:\Win95\RonicsTouch\Setup.exe"



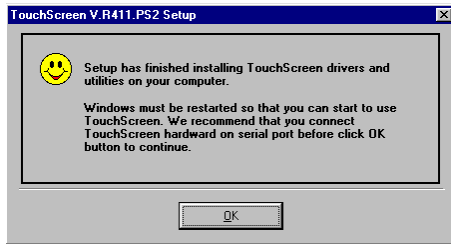
2. Click "OK"



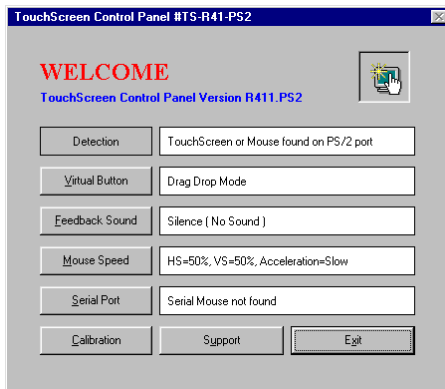
3. Press "Intall Now"



4. Click "OK" to restart the computer



5. Click the touchscreen Control Panel version "R411.PS2" icon

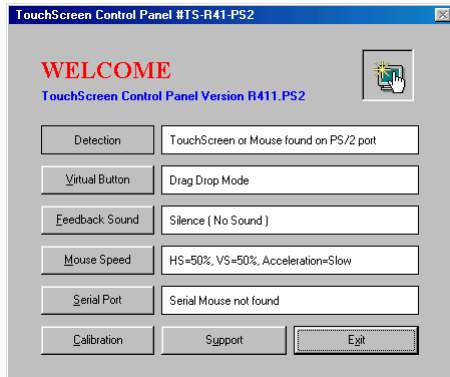


6. Press "Calibration" to calibrate the touchscreen



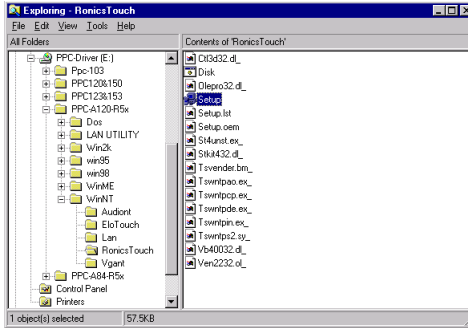


#### 4. Press "Calibration"

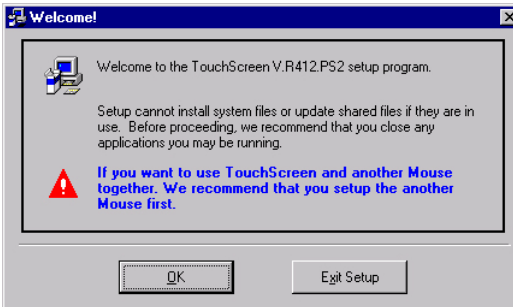


## 6.2.4 Installation for Windows NT

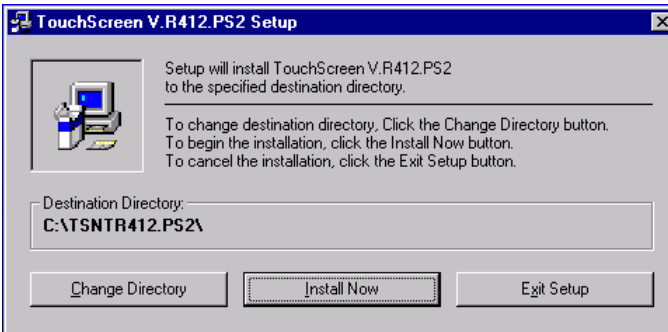
### 1. Double click "Setup.exe"



### 2. Press "OK"

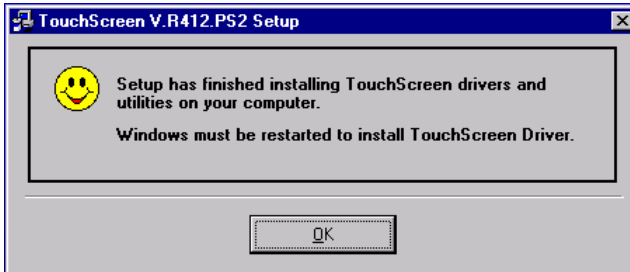


### 3. Click "Install Now"

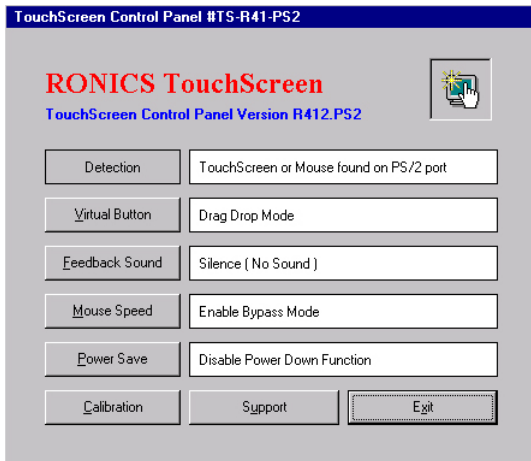




4. Click "Yes" to restart your computer



5. Press "Calibration"



## 6.3 Installation for Touch Screen Driver for the PPC-A120

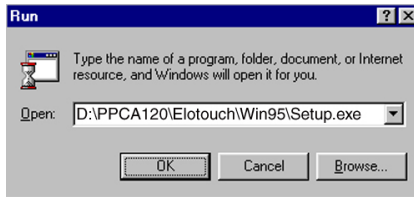
---

The PPC-A120's optional touchscreen incorporates advanced second-generation 5-wire resistive technology. They allow 75% light transmission. The resistive model has an antiglare surface. All models provide greatly enhanced visual resolution. They also have new improved scratch-resistant features.

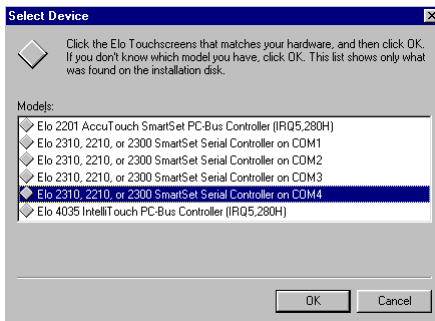
The touchscreen is manufactured from UL-recognized components. When properly installed, the touchscreen's ball impact resistance meets the UL 1950 standard. Its fire resistance meets the UL-746C, 19 mm (0.75") flame test standard. Systems incorporating the touchscreen, controllers, and cables have been approved to FCC Class B and Class B standards.

### 6.3.1 Installation for Windows 95

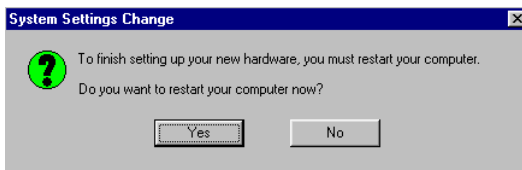
1. a. Insert the “Driveres and Utilities” CD  
b. Click the “Start” button and then “Run”  
c. Type the path “D:\PPCA-120\Elotouch\Win95\Setup.exe”



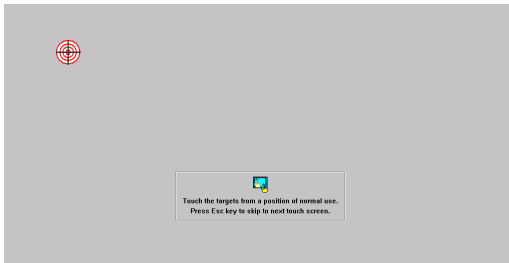
2. Click “Yes”.



- 3 a. Select the “SmartSet Serial Controller on COM4” item.  
b. Press “OK”

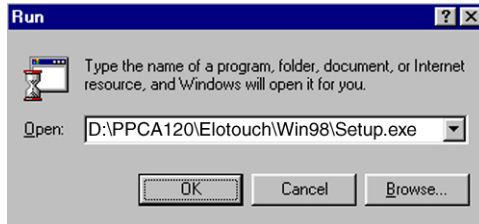


5. Touch targets to calibrate the touchscreen controller.

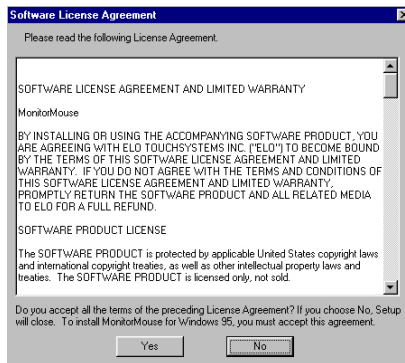


## 6.3.2 Installation for Windows 98

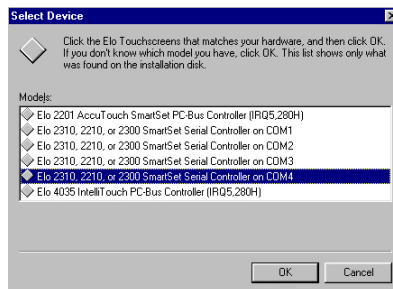
- a. Insert the “Drivers and Utilites” CD.
- b. Click the “Start” button and then “Run”
- c. Type the path “D:\PPCA120\Elotouch\Win98\Setup.exe”



2. Click “Yes”



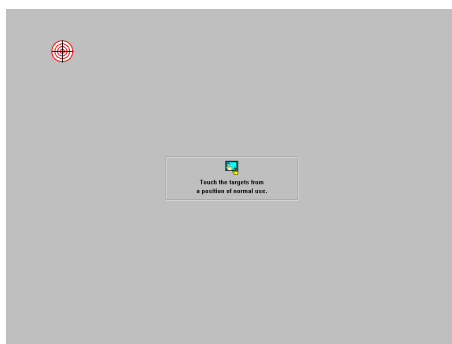
3. a. Select the “SmartSet Serial Controller on COM4” item.
- b. Press the “OK” button.



4. Click the “Yes” button to restart your computer.

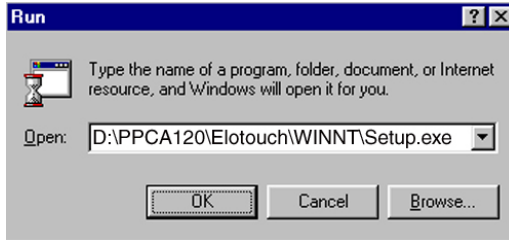


5. Touch target to calibrate the touchscreen controller.

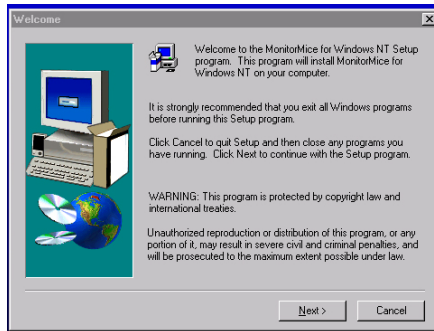


### 6.3.3 Installation for Windows NT

1. a. Select "Start" and "Run"
- b. Type the path "D:\PPCA120\Elotouch\WINNT\Setup.exe"



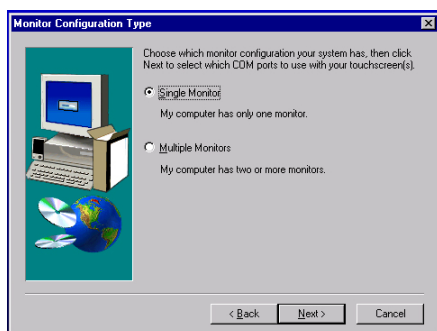
2. Press the "Next" button.



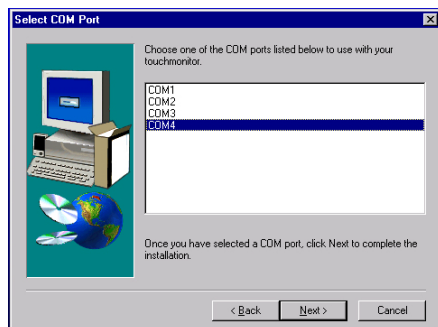
3. Set the directory path.



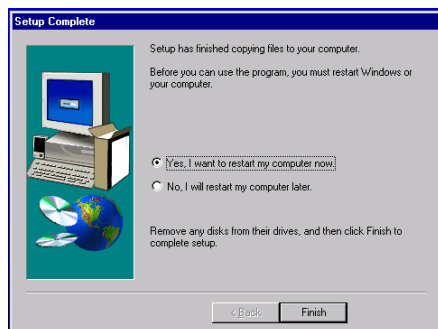
4. Choose a suitable item.



- 5.a. Choose "COM4"
- b. Press "Next"

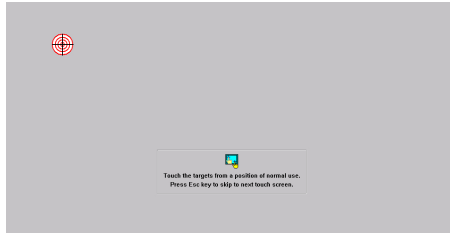


6. Click "Finish" to restart your computer.





## 7. Calibrate the touchscreen





# CHAPTER 7

## Audio Setup

- Introduction
- Installation of Audio Driver
  - Installation for Windows 95
  - Installation for Windows 98
  - Installation for Windows NT
- Further Information

## 7.1 Introduction

---

The PCM-5821 on-board audio interface provides high-quality stereo sound and FM music synthesis (ESFM) by using the NS CX5530 audio controller from National Semiconductor Corporation. The audio interface can record, compress, and play back voice, sound, and music with a built-in mixer control. The PCM-5821 on board audio interface also supports the Plug and Play (PnP) standard and provides PnP configuration for audio, FM, and MPU-104 logical devices. It is compatible with Sound Blaster, Sound Blaster Pro version 3.01, voice, and music functions. The ESFM synthesizer is register compatible with the OPL3 and has extended capabilities.

## 7.2 Installation of Audio Driver

---

Before installing the audio driver, please take note of the procedures detailed below. You must know which operating system you are using in your panel PC, and then refer to the corresponding installation flow chart. Just follow the steps in the flow chart. You can quickly and successfully complete the installation, even though you are not familiar with instructions for WINDOWS.

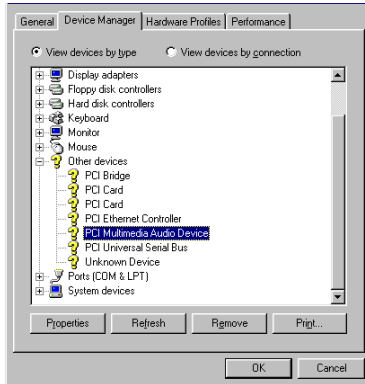
*Note 1: The following windows illustrations are examples only. You must follow the flow chart instructions and pay attention to the instructions which then appear on your screen.*

*Note 2: The CD-ROM drive is designated as "D" throughout this chapter.*

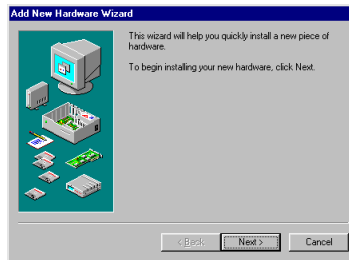
*Note 3: <Enter> means pressing the "Enter" key or the keyboard.*

## 7.2.1 Installation for Windows 95

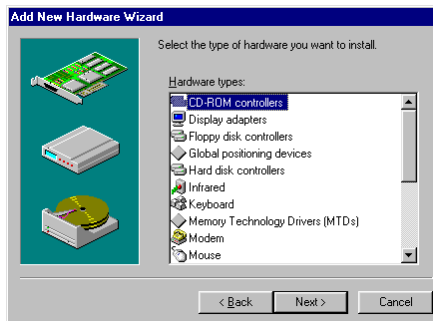
1. a. Remove "PCI Multimedia Audio Device" and "Unknown Device" from Device Manager
- b. Click "Close"



2. Click "Add new hardware" and "Next"



3. Select "No" and then click "Next"

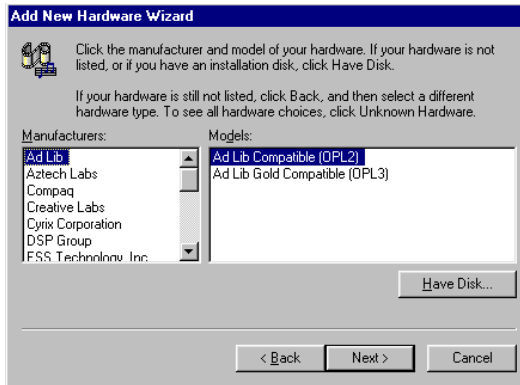


4. a. Choose "Sound, video and game controllers"

b. Click "Next"



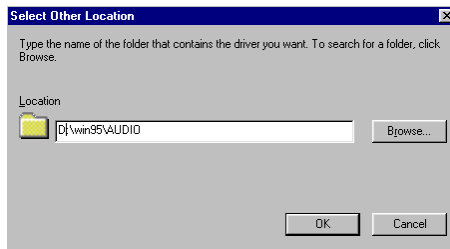
5. Press "Have Disk"



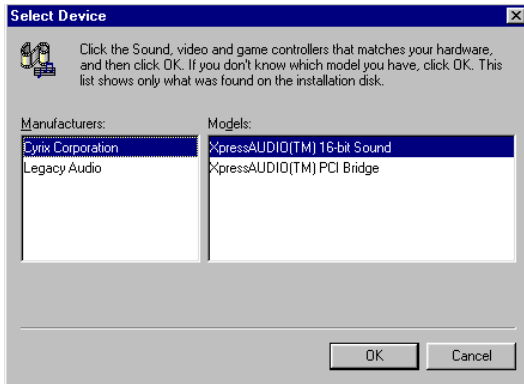
6. a. Click "Add new hardware" and "Next"

b. Enter "D:\WIN95\Audio"

c. Click "OK"



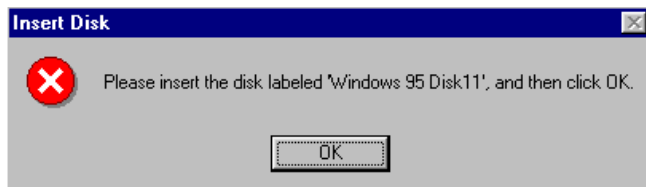
7. a. Select "Xpress Audio™ 16-bit sound"
- b. Press "OK"



8. Click "Finish"



9. a. Insert "Win95" CD to load related files
- b. Click "OK"

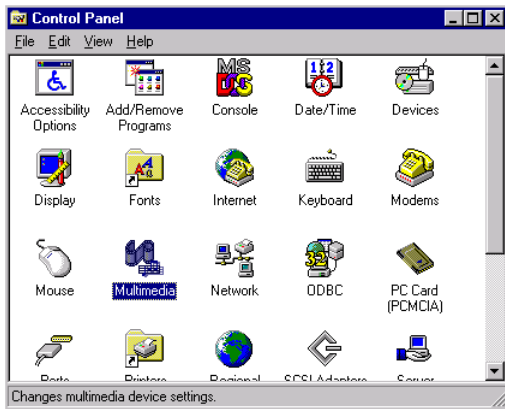


## 7.2.2 Installation for Windows 98

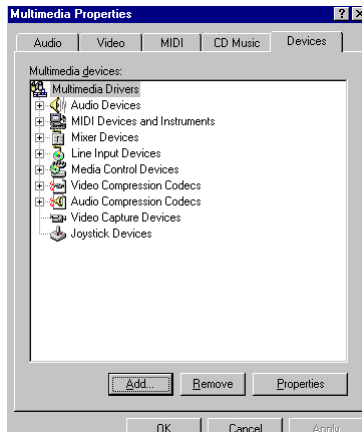
The audio driver is automatically installed after the VGA driver is installed. Further installation information is not needed.

## 7.2.3 Installation for WINDOWS NT

1. a. Select "Start," "Settings," "Control Panel"
- b. Double click "Multimedia"

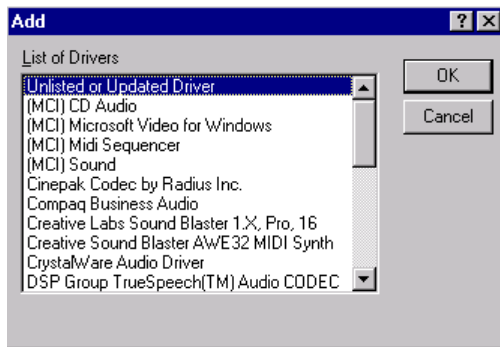


2. a. Select "Devices"
- b. Click "Add..."

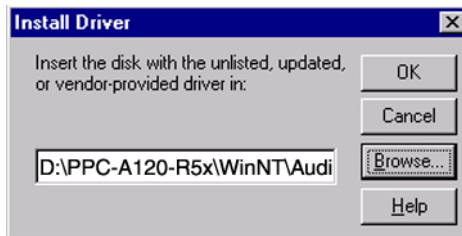




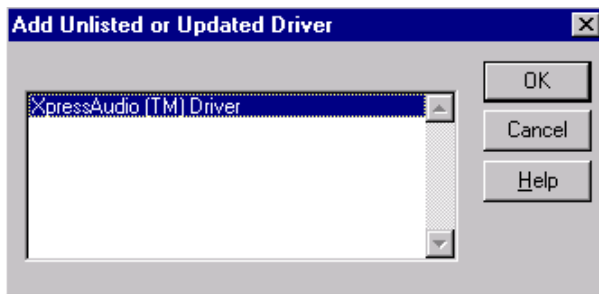
3. a. Choose "Unlisted or Updated Driver"
- b. Click "OK"



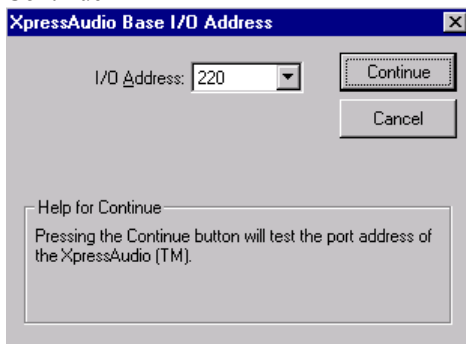
4. a. Insert "Drivers and Utilities" CD-ROM
- b. Enter the path name
- c. Click "OK"



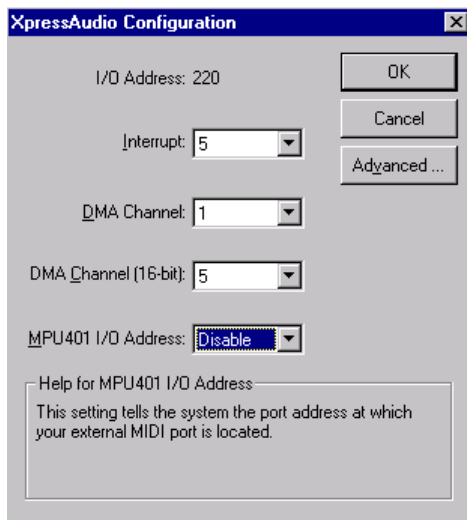
5. a. Select the highlighted item
- b. Press "OK"



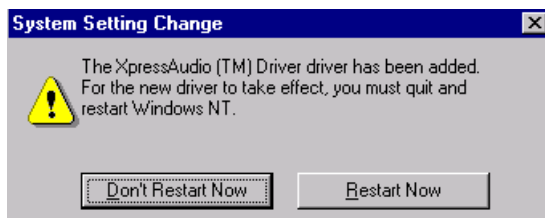
6. Click "Continue"



7. a. Change MPU 40 O/O address to disable by pull down window  
b. Press "OK"



8. Press "Restart Now"



## 7.3 Further Information

---

For further information about the audio installation in your PPC-A84/A120, including driver updates, troubleshooting guides and FAQ lists, visit the following web resources:

NS web site: **[www.nsc.com](http://www.nsc.com)**

Advantech web site: **[www.advantech.com](http://www.advantech.com)**  
**[www.advantech.com.tw](http://www.advantech.com.tw)**



# CHAPTER 8

## Award BIOS Setup

This chapter describes how to set BIOS configuration data.

## 8.1 Award BIOS Setup

---

The PPC-A84/A120 comes with an Award BIOS chip that contains the ROM setup for your system. This chip serves as an interface between the processor and the rest of the mainboard's components. This chapter explains the information contained in the setup program and tells you how to modify the settings according to your system configuration. Some setup items will not be explained, because it is recommended that users do not change such items.

*Note:* Values for the various setup items that appear on your own screen (including default values) may not be the same as the values shown on the screen figures in this chapter. This is because the BIOS is revised and updated from time to time. If in doubt, check Advantech's web site for the latest BIOS versions and related information.

## 8.2 CMOS Setup Utility

---

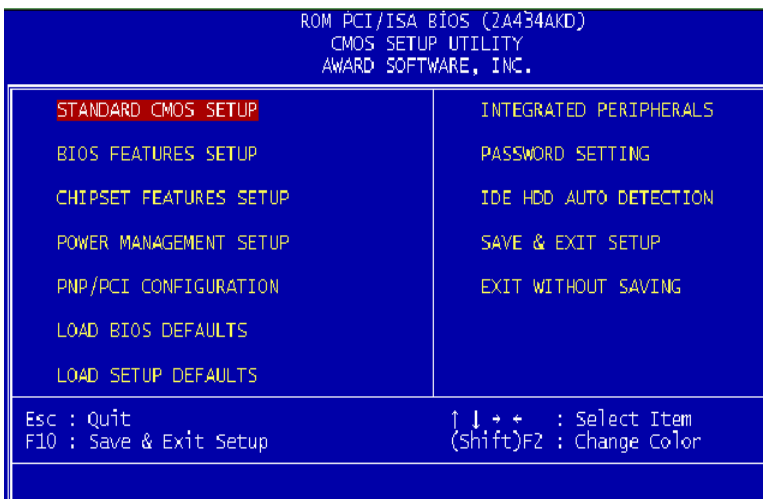
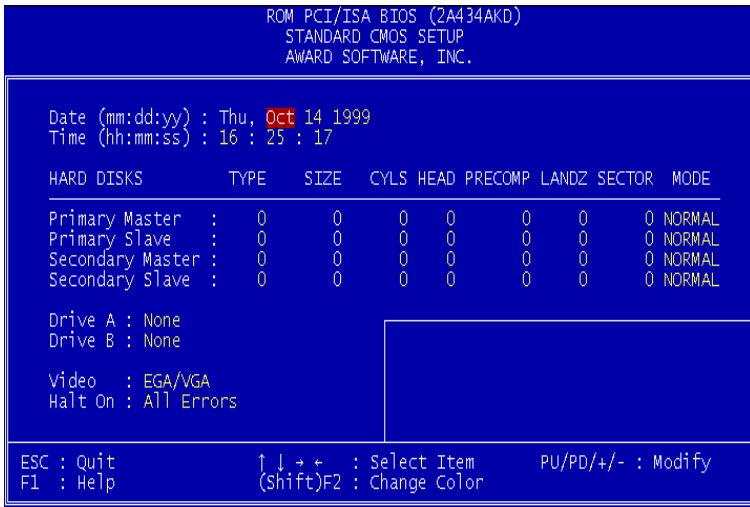


Figure 8-1: Setup program initial screen

A setup program, built into the system BIOS, is stored in the CMOS RAM that allows the configuration settings to be changed. This program is executed when the user changes the system configuration; when the user changes the system backup battery; or when the system detects a configuration error and asks the user to run the setup program. At power-on RAM testing, the message "Press DEL to enter Setup" appears. After pressing the "DEL" key, the CMOS setup utility screen will appear as shown in Fig. 8-1. Use the arrow keys to select and press "Enter" to run the selected program.

### 8.3 Standard CMOS Setup



**Figure 8-2: CMOS setup screen**

The standard CMOS setup screen is shown above. System BIOS automatically detects memory size, so no changes are necessary. It has a few items requiring setting. Each item may have one or more optional settings. System BIOS allows you to change the system date and time, IDE hard disk, floppy disk drive types for drives A: and B:, boot-up video display mode, and POST error handling selection. Use

the arrow keys to highlight the item and then use the "PgUp" or "PgDn" keys to select the value you want for each item.

### **8.3.1 Hard Disk Configurations**

**TYPE:**

Select from 1 to 45 to fill the remaining fields with predefined values for disk drives. Select "User" to fill the remaining fields. Select "Auto" to detect the HDD type automatically.

**SIZE:**

Hard disk size. The unit is megabytes (MB).

**CYLS:**

The cylinder number of the hard disk.

**HEAD:**

The read/write head number of the hard disk.

**PRECOMP:**

The cylinder number at which the disk drive changes the write timing.

**LANDZ:**

The cylinder number where the disk drive heads (read/write) are seated when the disk drive is parked.

**SECTOR:**

The sector number of each track defined on the hard disk.

**MODE:**

Select "Auto" to detect the mode type automatically. If your hard disk supports the LBA mode, select "LBA" or "Large". However, if your hard disk supporting cylinder is more than 1024 MB and does not support the LBA function, you have to select "Large". If your hard disk supporting cylinder is below 1024 MB, select "Normal".



## 8.4 BIOS Features Setup

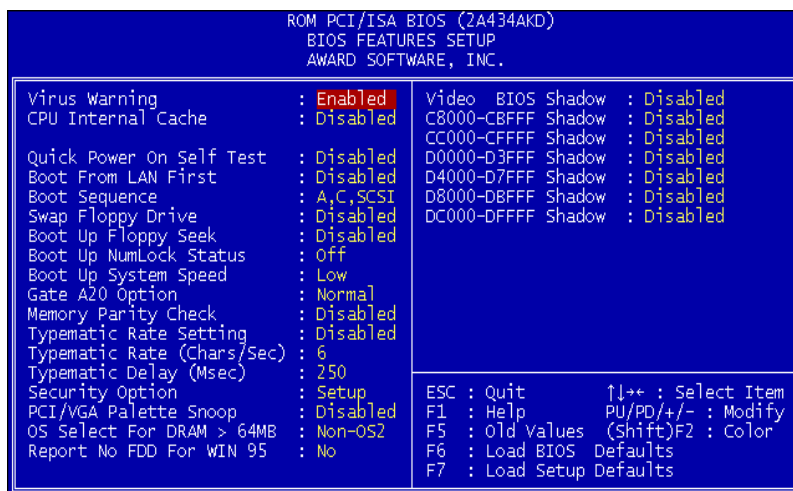


Figure 8-3: BIOS features setup screen

Moving around the BIOS Features and Chipset Features setup programs works the same way as moving around the Standard CMOS setup program. (Refer to the next section for Chipset Features setup.) The BIOS Features setup program is shown above. Users are not encouraged to run the BIOS and Chipset Features setup programs. Your system should have been fine-tuned before shipping. Improper setup may cause the system to fail, so consult your dealer before making any changes.

### Virus Warning

When enabled, it assigns the BIOS to monitor the master boot sector and the DOS sector of the first hard disk drive.

The options are: Disabled (Default), Enabled.

**CPU Internal Cache**

When enabled, it improves system performance. Disable this item when testing or troubleshooting.

The options are: Enabled (Default), Disabled.

**Quick Power On Self Test**

When enabled, allows the BIOS to bypass the extensive memory test.

The options are: Disabled (Default), Enabled.

**Boot Sequence**

Allows the system BIOS to first try to boot the operating system from the selected disk drive.

The options are: A, C, SCSI; C, A, SCSI (default); LS120, C; C (only); SCSI, C, A; SCSI, A,C; F, A, SCSI; E, A, SCSI; D, A, SCSI; CD-ROM, C, A; C, CD-ROM, A.

**Swap Floppy Drive**

When enabled, allows you to switch the order in which the operating system accesses the floppy drives during boot-up.

The options are: Disabled (Default), Enabled.

**Boot Up Floppy Seek**

When enabled, assigns the BIOS to perform floppy disk drive tests by issuing seek commands. Note that such tests are time-consuming.

The options are: Enabled (Default), Disabled.

**Boot Up NumLock Status**

When set to "On", allows the BIOS to automatically enable the NumLock function when the system boots up.

The options are: On (Default), Off.

**Memory Parity Check**

The options are: Disabled (Default), Enabled.

**Typematic Rate Setting**

The term typematic means that when a keyboard key is held down, the

character is repeatedly entered until the key is released. When this item is enabled, you may change the typematic repeat rate.

The options are: Disabled (Default), Enabled.

#### **Typematic Rate (Chars/Sec)**

Sets the rate of a character repeat when the key is held down.

The options are: 6 (Default), 8, 10, 12, 15, 20, 24, 30.

#### **Typematic Delay (msec)**

Sets the delay time before a character is repeated.

The options are: 250 (Default), 500, 750, 1000 milliseconds.

#### **Security Option**

Allows you to set the security level of the system.

The options are: Setup (Default), System.

#### **PCI/VGA Palette Snoop**

When enabled, allows you to install an enhanced graphics adapter card. If your graphics adapter card does not support the Palette Snoop function, set at "Disabled" to avoid system malfunctions.

The options are: Disabled (Default), Enabled.

#### **OS Select For DRAM > 64MB**

If your operating system (OS) is OS2, select "OS2". Otherwise, stay with the default setting Non-OS2.

#### **Video BIOS Shadow**

When enabled, allows the BIOS to copy the video ROM code of the add-on video card to the system memory, giving faster access.

The options are: Enabled (Default), Disabled.

#### **C8000-CBFFF Shadow through to DC000-DFFFF Shadow**

When enabled, allows the BIOS to copy the BIOS ROM code of the add-on card to the system memory for faster access. It may improve the performance of the add-on card. Some add-on cards will not

function properly if their BIOS ROM codes are shadowed. To use this option correctly, you need to know the memory address range used by the BIOS ROM of each add-on card. The options are: Disabled (Default), Enabled.

## 8.5 Chipset Features Setup

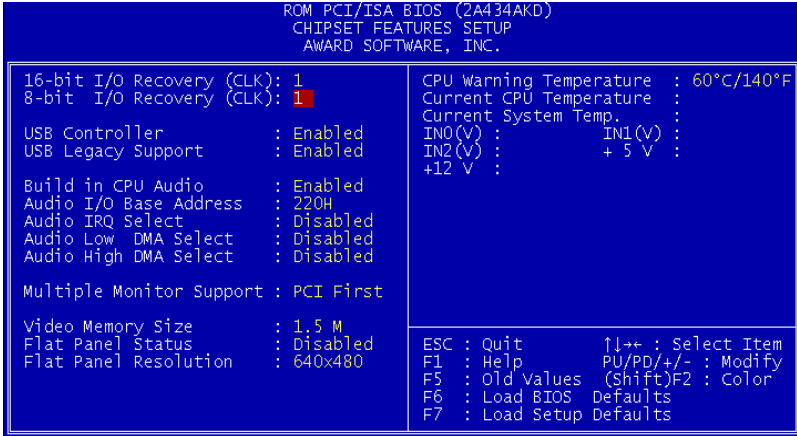


Figure 8-4: Chipset features setup screen

### 16-bit/8-bit I/O Recovery (CLK)

The options are: 1(Default), 2,...16

### USB Controller/ USB Legacy Support

When enabled, the USB devices are activated.

The options are: Disabled (Default), Enabled.

### Build in CPU Audio

When enabled, allows the system to use the CPU build-in audio function.

The options are: Enabled (Default), Disabled.

If enable build-in CPU audio , go on the other audio settings .

Audio I/O Base Address: 220H(Default), 240H, 260H and 280H.

Audio IRQ Select: Disable, IRQ 5, IRQ 7, IRQ 10.

Audio Low DMA Select: Disable, DMA 0, DMA 1, DMA 3.

Audio High DMA Select: Disable, DMA 5, DMA 6, DMA 7.

Video Memory Size

The video memory size is set by the manufacturer, depend on how many video memory on board.

The options are: 1.5M (Default), 2.5M.

### Flat Panel Status

The system will support 18-bit TFT LCD signal output, because this option is designed as " Enable".

### Flat Panel Resolution

The options are: 800 x 600 (default).

## 8.6 Power Management Setup

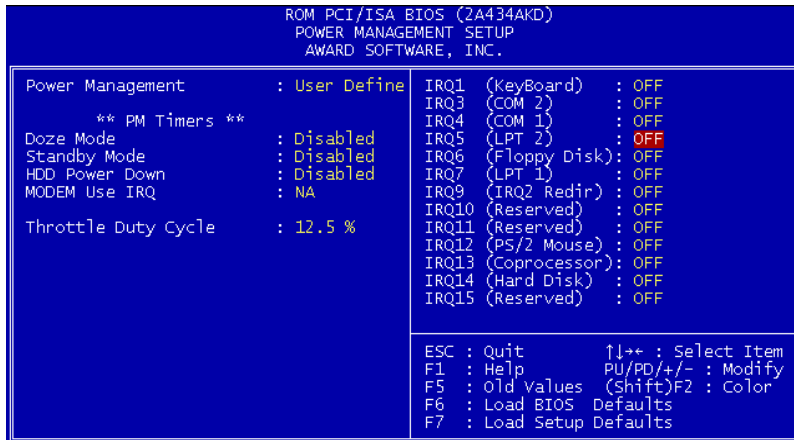


Figure 8-5: Power Management setup screen

**Power Management**

When enabled, allows you to use Power Management features.  
The options are: Disabled (Default), Max Saving, Min Saving, User define.

**Doze Speed (div by)**

The options are: 2 (Default), 1, 3, 4, 5, 6, 7, 8.

**Stdby Speed (div by)**

The options are: 3 (Default), 1, 2, 4, 5, 6, 7, 8.

**MODEM Use IRQ**

This feature allows you to select the IRQ# to meet your modem's IRQ#.

The options are: 3 (Default), 4, 5, 7, 9, 10, 11, NA.

**Throttle Duty Cycle**

The options are: 12.5%, 25%, 33.3%, 50%, 75%.

**IRQ# Activity**

After the time period which you set in the Suspend Mode feature elapses, the system advances from Doze Mode to Suspend Mode, in which the CPU clock stops and the screen display is off. At this moment, if the IRQ activity which is defined as enabled occurs, the system goes directly back to Full-on Mode.

If the IRQ activity which is defined as "Disabled" occurs, the system enters another low power state, Dream Mode. In Dream Mode, the system will function the same as in Full-on Mode, except that the screen display remains off until the corresponding IRQ handler finishes, whereupon the system reverts to Suspend Mode.

For instance, if the system is connected to a LAN and receives an interruption from its file server, the system will enter Dream Mode to execute the corresponding calling routine.

The options are: Enabled, Disabled.

The default values of IRQ3, 4, 5, 6, 7, 9, 10, 11, 12, 13, 14, 15 are all: Enabled.

The default value of IRQ8 is: Disabled.

*Note: Under certain operating systems such as WINDOWS NT 4.0 (Build 1381), the CD auto-insertion feature might have some effect on power management. It is recommended that the CD-ROM drive use the secondary channel, and that the following Power Management Setup features be set:  
HDD & FDD: Off  
IRQ15 (Reserved): Secondary*

## 8.7 PNP/PCI Configuration Setup

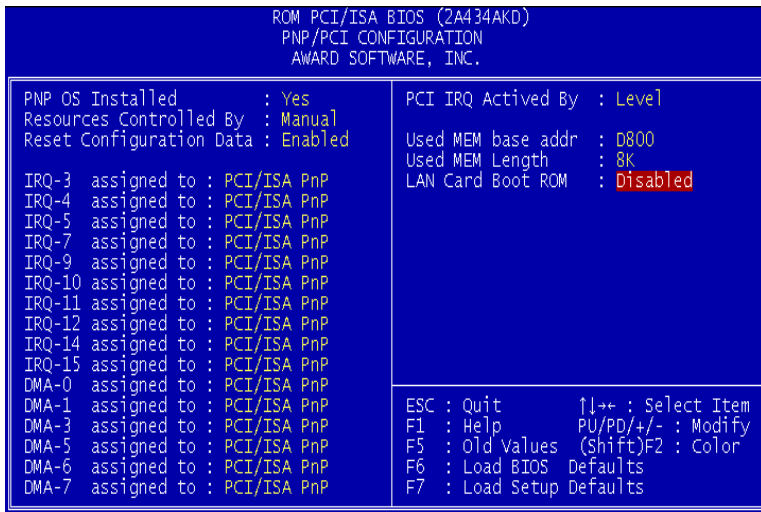


Figure 8-6: PNP/PCI configuration setup screen

### Resources Controlled By

If set at "Auto", the BIOS automatically arranges all system resources for you. If there are conflicts or you are not satisfied with the configuration, simply set all the resources listed in the above figure by selecting

"Manual".

The options are: Manual (Default), Auto. The manual options assigned to IRQ-/DMA- are: Legacy ISA, PCI/ISA PnP.

### Reset Configuration Data

When enabled, this feature allows the system to clear the last BIOS configuration data and then reset the data with the default BIOS configuration data.

The options are: Disabled (Default), Enabled.

### PCI IRQ Activated By

If your IDE card is triggered by edge, set it at "Edge".

The options are: Level (Default), Edge.

### Lan card Boot ROM

When enabled, your system will be able to boot up through the Ethernet.

The options are: Disabled (Default), Enabled.

## 8.8 Load BIOS Defaults

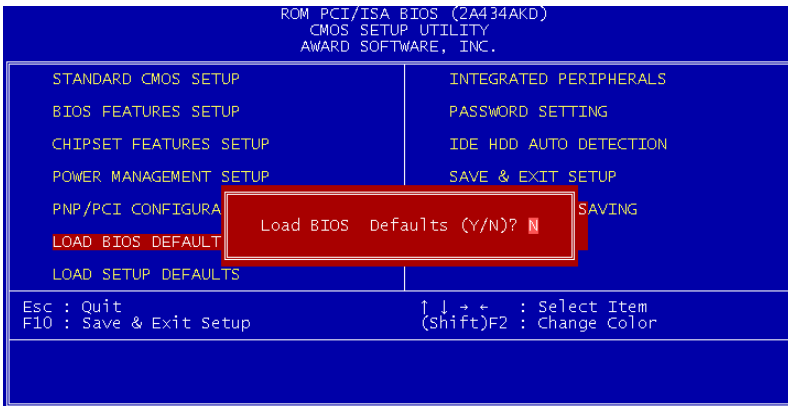


Figure 8-7: Load BIOS defaults screen



The BIOS defaults screen contains the most appropriate values of the system parameters that allow minimum system performance.

## 8.9 Load Setup Defaults

Selecting this field loads the factory defaults for BIOS and Chipset Features. The system will automatically detect these defaults.

## 8.10 Integrated Peripherals

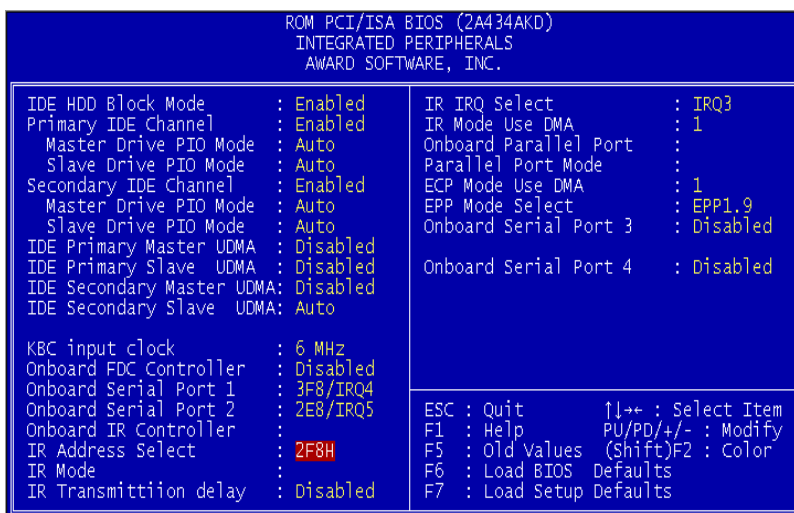


Figure 8-8: Integrated peripherals screen

**IDE HDD Block Mode**

This allows your hard disk controller to use the fast block mode to transfer data to and from your hard disk drive (HDD).

The options are: Enabled (Default), Disabled.

**IDE Primary/Secondary Master/Slave PIO**

IDE hard disk drive controllers can support up to separate hard drives.

These drives have a master/slave relationship which is determined by the cabling configuration used to attach them to the controller. Your system supports two IDE controllers - a primary and a secondary - so you have the ability to install up to four separate hard disks.

PIO means Programmed Input/Output. Rather than having the BIOS issue a series of commands to effect a transfer to or from the disk drive, PIO allows the BIOS to tell the controller what it wants and then let the controller and the CPU perform the task by themselves.

Your system supports five modes, numbered from 0 through 4, which differ primarily in timing. When "Auto" is selected, the BIOS will choose the best available mode.

The options are: Auto, (Default), Disabled.

**Primary/Secondary Master/Slave Ultra DMA**

DMA means Direct Memory Access. Ultra DMA is faster than DMA. DMA is a method of transferring data to or from memory at a fast rate, without involving the CPU.

When you select "Auto", the BIOS will choose the best available mode.

The options are: Auto (Default), Disabled.

**KBC input clock**

Set the keyboard controller input clock.

The options are: 6MHz, 8MHz, 12MHz, 16MHz

**Onboard FDD Controller**

When enabled, the floppy disk drive (FDD) controller is activated.

The options are: Enabled (Default), Disabled.

## **WDT Active When Power ON**

This is Advantech's patented watchdog function which can reboot the system should the computer hang in the BIOS checkup.

The options are: 62 sec (Default), Disabled, 31 sec, 15 sec.

### **Onboard Serial Ports 1 & 2**

If the serial ports use the onboard I/O controller, you can modify your serial port parameters.

The options for Port 1 are: 3F8/IRQ4 (Default), 2E8/IRQ3, Disabled, 2F8/IRQ3, 3E8/IRQ4.

The options for Port 2 are: 2F8/IRQ3 (Default), 3E8/IRQ4, 2E8/IRQ3, Disabled, 3F8/IRQ4.

### **IR Address Select**

When enabled, the infrared receptor is activated.

The options are: Disabled (Default), Enabled.

### **Onboard Parallel Port**

If the parallel port uses the onboard I/O controller, you can modify your parallel port parameters. When you select "Disabled", the next two setup items will disappear.

The options are: 378/IRQ7 (Default), 3BC/IRQ7, 278/IRQ5, Disabled.

### **Parallel Port Mode**

You can choose different data transfer modes for your system.

The options are: ECP & EPP (Default), SPP, EPP, ECP.

### **ECP Mode Use DMA**

You can choose different DMA modes for data transfer.

The options are: 3 (Default), 1.

### **Onboard Serial Ports 3 & 4**

If the serial ports use the onboard I/O controller, you can modify your serial port parameters.

The options for Port 3 are: 3E8/IRQ10 (Default), 2E8/IRQ5, Disabled.

The options for Port 4 are: 2E8/IRQ5 (Default), Disabled, 3E8/IRQ10.

## 8.11 Password Setting

---

To enable the password setting, select the item from the Standard CMOS Setup. You will be prompted to create your own password. Type your password up to eight characters and press "Enter". You will be asked to confirm the password. Type the password again and press "Enter". You may also press "Esc" to abort the selection and not enter a password. To disable the password, press "Enter" when you are prompted to enter the password. A message will appear, confirming the password is disabled.

Under the BIOS Features setup, if "System" is selected under the Security Option field and the Supervisor Password is enabled, you will be prompted for the supervisor password every time you try to enter the CMOS Setup utility. If "System" is selected and User Password is enabled, you will be requested to enter the user password every time you reboot the system. If "Setup" is selected under the Security Option field and User Password is enabled, you will be prompted only when you reboot the system.

## 8.12 IDE HDD Auto Detection

---

The IDE Hard Disk Drive Auto Detection feature automatically configures your new hard disk. Use it for quick configuration of new hard disk drives. This feature allows you to set the parameters of up to four IDE HDDs. The option with "(Y)" is recommended by the system BIOS. You may also key in your own parameters instead of setting them according to the system BIOS. After keying in all settings, press "Esc" to return to the main menu. For confirmation, enter the Standard CMOS Setup feature.

## 8.13 Save and Exit Setup

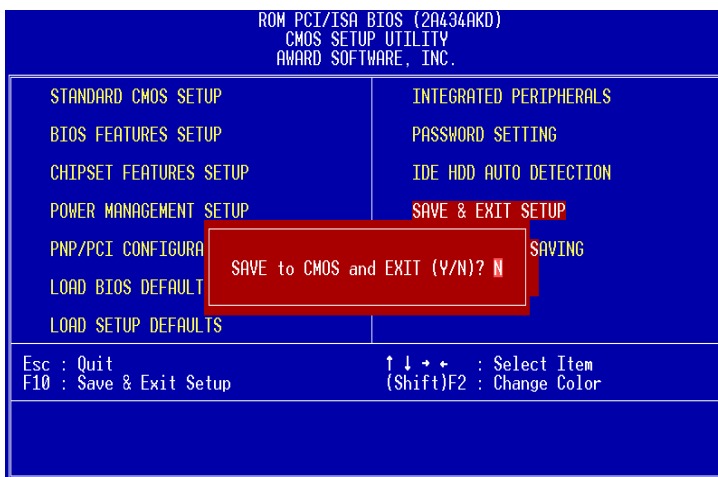


Figure 8-9: Save and exit setup screen

After you have made changes in the BIOS setup, press "Esc" to return to the main menu. Move the cursor to "Save and Exit Setup", or press "F10" and then press "Y", to change the CMOS Setup. If you did not change anything, press "Esc" again or move the cursor to "Exit Without Saving" and press "Y" to retain the setup settings. The following message will appear at the center of the screen to allow you to save data to CMOS and exit the setup utility:

```
SAVE to CMOS and EXIT (Y/N)?
```

## 8.14 Exit Without Saving

If you select this feature, the following message will appear at the center of the screen to allow you to exit the setup utility without saving CMOS modifications:

```
Quit Without Saving (Y/N) ?
```



## **Programming the Watchdog Timer**

The PPC-A84/A120 is equipped with a watchdog timer that resets the CPU or generates an interrupt if processing comes to a standstill for any reason. This feature ensures system reliability in industrial standalone or unmanned environments.

# A.1 Programming the Watchdog Timer

---

To program the watchdog timer, you must write a program which writes I/O port address 443 (hex). The output data is a time interval value. The value range is from 01 (hex) to 3E (hex), and the related time interval is from 1 sec. to 62 sec.

<b>Data</b>	<b>Time Interval</b>
01	1 sec.
02	2 sec.
03	3 sec.
04	4 sec.
•	•
•	•
•	•
3E	62 sec.

After data entry, your program must refresh the watchdog timer by rewriting the I/O port 443 (hex) while simultaneously setting it. When you want to disable the watchdog timer, your program should read I/O port 443 (hex).



The following example shows how you might program the watchdog timer in BASIC:

```
10      REM  Watchdog timer example program
20      OUT &H443, data REM  Start and restart the
      watchdog
30      GOSUB 1000 REM  Your application task #1,
40      OUT &H443, data REM  Reset the timer
50      GOSUB 2000 REM  Your application task #2,
60      OUT &H443, data REM  Reset the timer
70      X=INP (&H443) REM, Disable the watchdog timer
80      END

1000     REM  Subroutine #1, your application task
      .
      .
      .
1070     RETURN
2000     REM  Subroutine #2, your application task
      .
      .
      .
2090     RETURN
```



APPENDIX

# B

## Full Disassembly Procedures

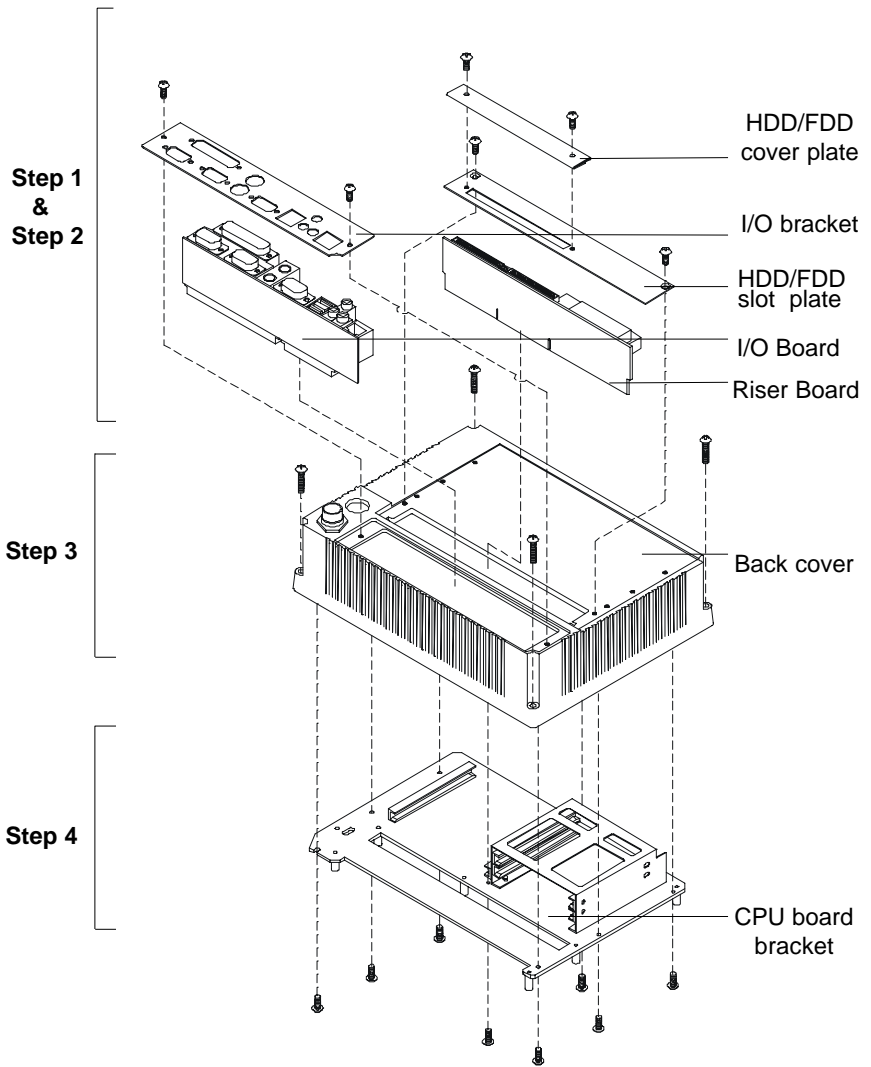
## B.1 Full Disassembly Procedures

---

If you want to completely disassemble the panel PC, follow the step-by-step procedures below. Users should be aware that Advantech Co., Ltd. takes no responsibility whatsoever for any problems or damage caused by the user disassembly of the panel PC. Make sure the power cord of the panel PC is unplugged before you start disassembly.

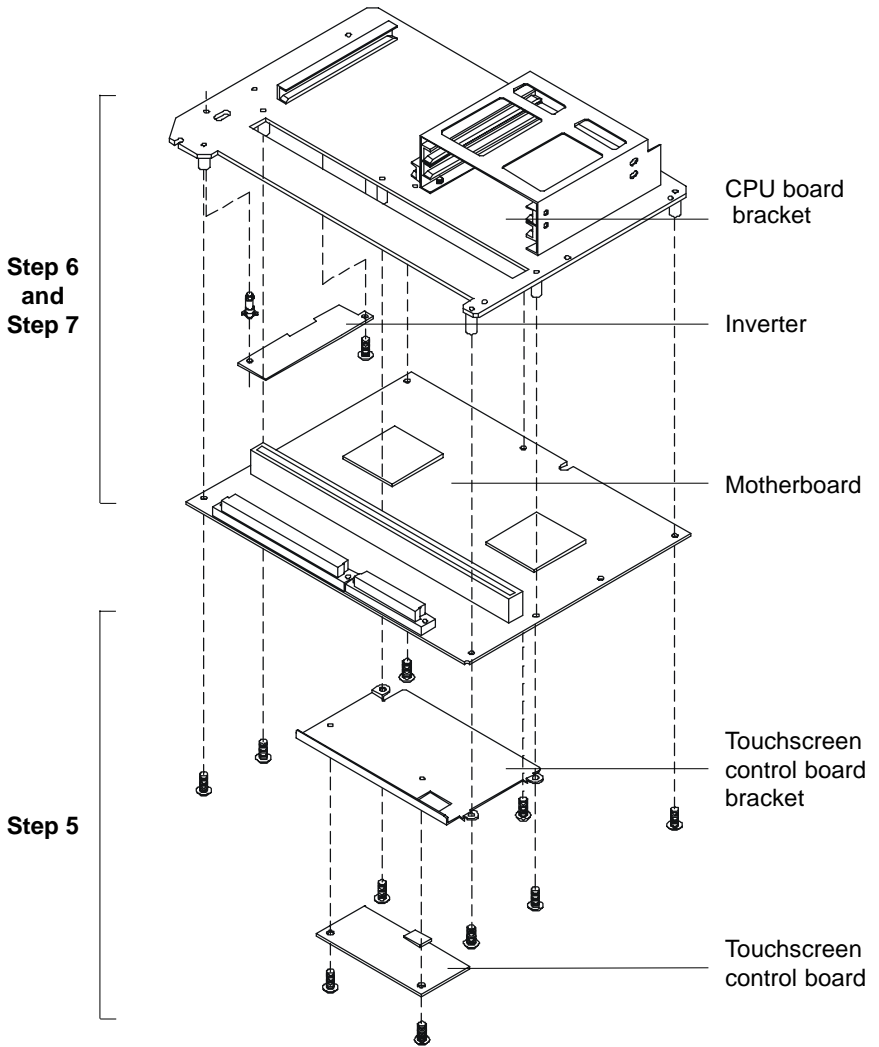
The following procedures do not include the detailed disassembly procedures for the power supply, HDD drive, or PCMCIA module. You can refer to Chapter 2-1 if you would like to remove the power supply, HDD drive or PCMCIA module.

1. Unscrew two screws on HDD/FDD cover plate and two screws on slot plate, remove both the HDD/FDD cover and slot plates, then carefully detach the riser board with either a screwdriver or pliers.
2. Unscrew the eight hexagonal and two flat screws of the I/O bracket, then you can remove the I/O bracket. Likewise, detach the I/O board carefully either with a screwdriver or pliers.
3. Unscrew the four screws located on the corners of the back cover to separate the back cover from the front panel kit, then detach the flat cables of the LCD, touchscreen, LCD backlight, and LED. You can disassemble the back cover and the front panel kit.
4. Unscrew the eight screws on the CPU board bracket. You can remove the CPU board bracket from the back cover. Before this step, you should disassemble the motherboard from the CPU board bracket. You will be able to find the procedure on the next page.



**Figure B-1: Disassembly steps 1 - 4**

5. Unscrew the five screws on the touchscreen control board and touchscreen control board bracket, then remove both components.
6. Detach the inverter by unscrewing the screw located on the right corner of the inverter.
7. Unscrew the rest of the screws on the motherboard to disassemble the motherboard from the CPU board bracket.

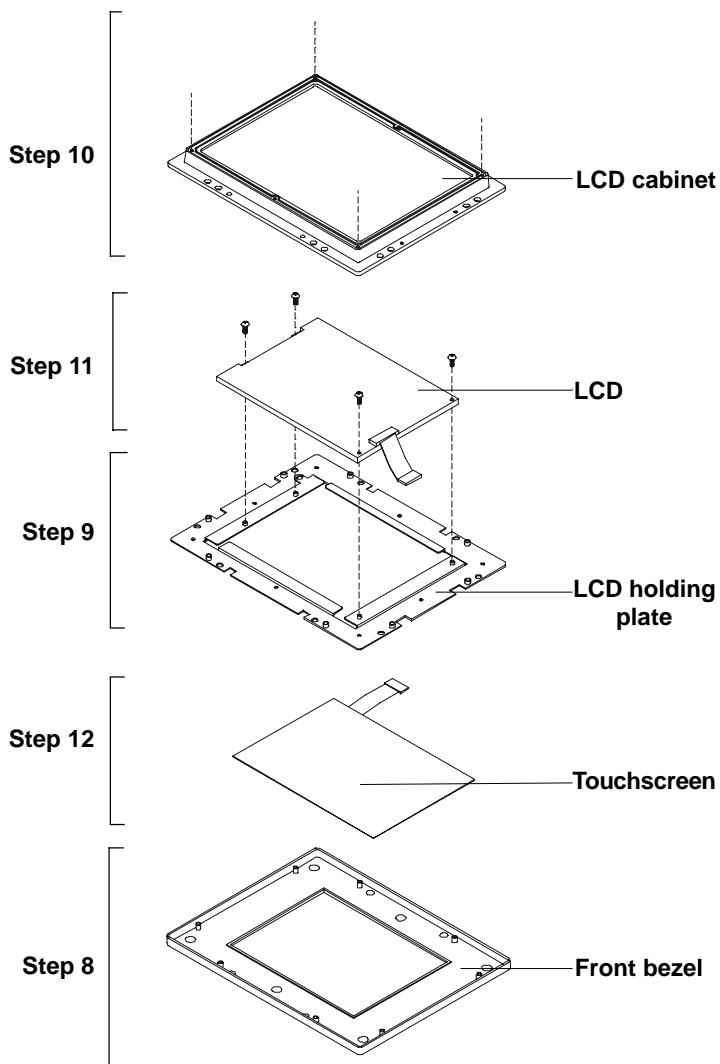


**Figure B-2: Disassembly steps 5 - 7**

8. Remove the front bezel carefully by a flat screwdriver.
9. Unscrew the six screws on the LCD holding plate to separate the LCD cabinet and LCD holding plate.
10. Detach the LCD cabinet.
11. Detach the LCD by unscrewing the four screws located on each of the corners.
12. The touchscreen is stuck on the LCD holding plate by a strongly double-side adhesive tape. We do not recommend you to remove it unless the touchscreen is defective and you would like to replace it.

*Note: Because of the modular design of the LCD and touchscreen, you do not disassemble the whole system step by step if you would like to replace the defective LCD or touchscreen. You just start disassembling the module from step 8. Then, you can easily remove the LCD and touchscreen by step 9 to step 12.*





**Figure B-3: Disassembly steps 8 - 12**



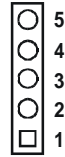
## Pin Assignments

- Inverter Power Connector (J1)
- Flat Panel Display Connector (J2)
- Primary IDE Connector (J3)
- Keyboard Connector (J4)
- Internal Touchscreen Connector (J5)
- CompactFlash™ Disk Secondary IDE Connector (CN2)
- CD IN (CN3)
- Power Fan Power Connector (CN6)
- External KBT2 (CN7)
- CPU Power Fan Connector (CN8)
- Power Switch Connector (CN10)
- Speaker and Microphone Connector (CN20)
- Power Test Connector (PS1)
- COM2
- External IDE Connector
- External Floppy Drive Connector
- External HDD and FDD Power Connector
- System I/O ports

## C.1 Inverter Power Connector (J1)

Table C-1: Inverter power connector (J1)

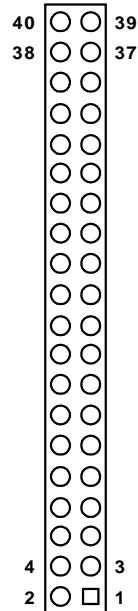
Pin	Signal
1	+12 V
2	GND
3	ENABKL
4	VBR
5	Vcc



## C.2 Flat Panel Display Connector (J2)

Table C-2: Flat panel display connector (J2)

Pin	Signal	Pin	Signal
1	VDDSAFE5	2	VDDSAFE5
3	GND	4	GND
5	VDDSAFE3	6	VDDSAFE3
7	Vcon	8	GND
9	NC	10	NC
11	P0	12	P1
13	P2	14	P3
15	P4	16	P5
17	NC	18	NC
19	P6	20	P7
21	P8	22	P9
23	P10	24	P11
25	NC	26	NC
27	P12	28	P13
29	P14	30	P15
31	P16	32	P17
33	GND	34	GND



35	SHFCLK	36	FLM
37	M/DE	38	LP
39	EVEN CLK	40	ENABKL

### C.3 Primary IDE Connector (J3)

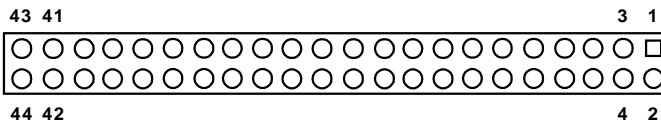


Table C-3: Primary IDE connector (J3)

Pin	Signal	Pin	Signal
1	IDE RESET #	2	GND
3	DATA 7	4	DATA 8
5	DATA 6	6	DATA 9
7	DATA 5	8	DATA 10
9	DATA 4	10	DATA 11
11	DATA 3	12	DATA 12
13	DATA 2	14	DATA 13
15	DATA 1	16	DATA 14
17	DATA 0	18	DATA 15
19	SIGNAL GND	20	CABLE SELECT
21	HDD DREQ	22	GND
23	IO WRITE	24	GND
25	IO READ	26	GND

27	HD READY	28	Cable Select
29	HDACK 0 #	30	GND
31	IRQ14	32	N/C
33	ADDR 1	34	N/C
35	ADDR 0	36	ADDR 2
37	HDD SELECT 0 #	38	HDD SELECT 1 #
39	IDE ACTIVE 0 #	40	GND
41	V <sub>CC</sub>	42	V <sub>CC</sub>
43	GND	44	N/C

# low active

## C.4 Keyboard Connector (J4)

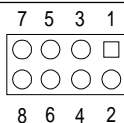


Table C-4: Keyboard Connector (J4)

Pin	Signal
1	V <sub>CC</sub>
2	EXT_KBDAT2
3	PC_KBDAT
4	EXT_KBDAT1
5	PC_KBCLK
6	EXT_KBCLK1
7	GND
8	EXT_KBCLK2

## C.5 Internal Touchscreen Connector(J5)

Table C-5: Internal Touchscreen Connector (J5)

Pin	Signal			
1	-DCD4	1	□	2
2	-DSR4	3	○	4
3	RX4B		○	
4	-RTS4		○	
5	TX4		○	
6	-CTS4	13	○	14
7	-DTR4	15	○	16
8	-R14			
9	GND			
10	GND			
11	PC_MS DAT			
12	EXT_MS DAT			
13	PC_MS CLK			
14	EXT_MS CLK			
15	V <sub>CC</sub>			
16	V <sub>CC</sub>			

## C.6 ComapctFlash™ Disk Secondary IDE Connector (CN2)

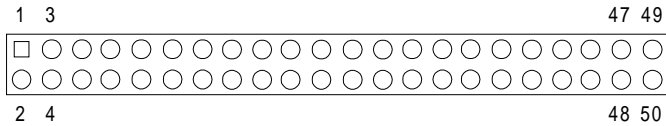


Table C-6: CompactFlash™ Disk Secondary IDE Connector (CN2)

Pin	Signal	Pin	Signal
1	GND	26	GND
2	DATA3	27	DATA11
3	DATA4	28	DATA12
4	DATA5	29	DATA13
5	DATA6	30	DATA14
6	DATA7	31	DATA15
7	-CS0S	32	-CS1S
8	NC	33	NC
9	GND	34	-IIOR1
10	NC	35	-IIOW1
11	NC	36	GND
12	NC	37	IIRQ15
13	V <sub>cc</sub>	38	V <sub>cc</sub>
14	NC	39	GND
15	NC	40	NC
16	NC	41	-IRST
17	NC	42	IIRDY1
18	A2	43	IDRQ1
19	A1	44	-IIACK1
20	A0	45	-HDLED
21	DATA0	46	NC
22	DATA1	47	DATA8
23	DATA2	48	DATA9
24	NC	49	DATA10
25	GND	50	GND



## C.7 CD IN (CN3)

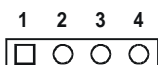


Table C-7: CD IN (CN3)

Pin	Signal
1	CD_INR
2	CD_GND
3	CD_INL
4	CD_GND

## C.8 Power Fan Power Connector (CN4)

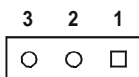


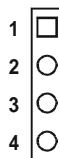
Table C-8: Power Fan Power Connector (CN6)

Pin	Signal
1	FAN_CTL
2	12 V
3	FAN_DET

## C.9 External KBT2 Connector (CN7)

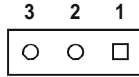
Table C-9: CPU Fan Power Connector (CN7)

Pin	Signal
1	$V_{CC}$
2	EXT_KBDAT2
3	EXT_KBCKL2
4	GND



## C.10 CPU Fan Power Connector (CN8)

---



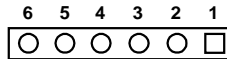
---

Table C-10: CPU fan power connector (FAN1)

Pin	Signal
1	GND
2	+12 V
3	FAN_DET

## C.11 Power Switch Connector (CN10)

---



---

Table C-11: Power Switch Connector (CN10)

Pin	Signal
1	V <sub>cc</sub>
2	GND
3	SUS_LED
4	-FPRST
5	-FPSW
6	-FPSLP

## C.12 Speaker and Microphone Connector (CN20)

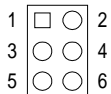


Table C-12: Speaker and Microphone Connector (CN20)

Pin	Signal
1	LINOUT_L
2	GNDADD
3	GNDADD
4	LINOUT_R
5	GNDADD
6	MIC_IN

## C.13 Power Test Connector (PS1)

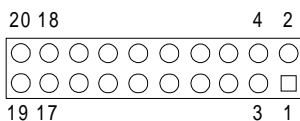
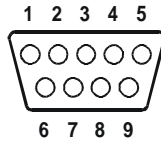


Table C-13: Power Test Connector (PS1)

Pin	Signal	Pin	Signal
1	$V_{cc}$ 3ATX	11	$V_{cc}$ 3ATX
2	$V_{cc}$ 3ATX	12	-12 V
3	GND	13	GND
4	$V_{cc}$	14	-PSON
5	GND	15	GND
6	$V_{cc}$	16	GND
7	GND	17	GND
8	-PWROK	18	-5 V
9	5 VSB	19	$V_{cc}$
10	12 V	20	$V_{cc}$

## C.14 COM2

---



---

Table C-14: COM2

Pin	Signal		
	RS-232	RS-422	RS-485
1	DCD	TX-	DATA-
2	RX	TX+	DATA+
3	TX	RX+	---
4	DTR	RX-	---
5	GND	GND	---
6	DSR	---	---
7	RTS	---	---
8	CTS	---	---
9	RI	---	---

## C.15 External IDE Connector

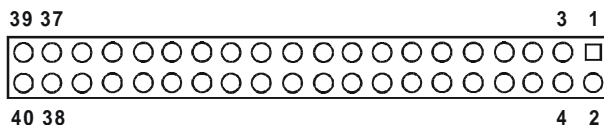


Table C-15: External IDE connector

Pin	Signal	Pin	Signal
1	IDE RESET#	2	GND
3	DATA7	4	DATA8
5	DATA6	6	DATA9
7	DATA5	8	DATA10
9	DATA4	10	DATA11
11	DATA3	12	DATA12
13	DATA2	14	DATA13
15	DATA1	16	DATA14
17	DATA0	18	DATA15
19	SIGNAL GND	20	N/C
21	HDD 0	22	GND
23	IO WRITE	24	GND
25	IO READ	26	GND
27	HD READY	28	N/C
29	HDACK 0#	30	GND
31	IRQ14	32	N/C
33	ADDR1	34	N/C
35	ADDR 0	36	ADDR 2
37	HDD SELECT 0#	38	HDD SELECT 1#
39	IDE ACTIVE 0#	40	GND

\* Low active

## C.16 External Floppy Drive Connector

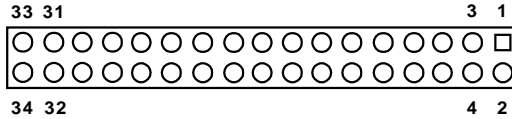


Table C-16: External floppy drive connector

Pin	Signal	Pin	Signal
1	GND	2	DENSITY SELECT*
3	GND	4	N/C
5	GND	6	DRIVE TYPE
7	GND	8	INDEX*
9	GND	10	MOTOR 0*
11	GND	12	DRIVE SELECT 1*
13	GND	14	DRIVE SELECT 0*
15	GND	16	MOTOR 1*
17	GND	18	DIRECTION*
19	GND	20	STEP*
21	GND	22	WRITE DATA*
23	GND	24	WRITE GATE*
25	GND	26	TRACK 0*
27	GND	28	WRITE PROTECT*
29	GND	30	READ DATA*
31	GND	32	HEAD SELECT*
33	GND	34	DISK CHANGE*

\* Low active

## C.17 External FDD and HDD Power Connector

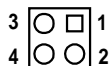


Table C-17: External FDD and HDD Power Connector

Pin	Signal
1	+12 V
2	GND
3	GND
4	V <sub>cc</sub>

## C.18 System I/O ports

Table C-18: System I/O ports

Addr. range (Hex)	Device
000-01F	DMA controller
020-021	Interrupt controller 1, master
022-023	Chipset address
040-05F	8254 timer
060-06F	8042 (keyboard Controller)
070-07F	Real-time clock, non-maskable interrupt (NMI) mask
080-09F	DMA page register,
0A0-0BF	Interrupt controller 2
0C0-0DF	DMA controller
0F0	Clear math co-processor
0F1	Reset math co-processor
0F8-0FF	Math co-processor
1F0-1F8	Fixed disk
200-207	Game I/O
278-27F	Parallel printer port 2 (LPT 3)
2F8-2FF	Serial port 2
300-31F	Prototype card
360-36F	Reserved
378-37F	Parallel printer port 1 (LPT 2)
380-38F	SDLC, bisynchronous 2

3A0-3AF	Bisynchronous 1
3B0-3BF	Monochrome display and printer adapter(LPT1)
3C0-3CF	Reserved
3D0-3DF	Color/graphics monitor adapter
3F0-3F7	Diskette controller
3F8-3FF	Serial port 1

*Note: Audio I/O map range from 220 ~ 250H (16 bytes).*



## Free Manuals Download Website

<http://myh66.com>

<http://usermanuals.us>

<http://www.somanuals.com>

<http://www.4manuals.cc>

<http://www.manual-lib.com>

<http://www.404manual.com>

<http://www.luxmanual.com>

<http://aubethermostatmanual.com>

Golf course search by state

<http://golfingnear.com>

Email search by domain

<http://emailbydomain.com>

Auto manuals search

<http://auto.somanuals.com>

TV manuals search

<http://tv.somanuals.com>