

PCA-6186

Full-size socket 478 Intel
Pentium® 4/ Celeron™
processor-based PCI/ISA
CPU card

User's Manual

Copyright Notice

This document is copyrighted, 2002, by Advantech Co., Ltd. All rights are reserved. Advantech Co., Ltd. reserves the right to make improvements to the products described in this manual at any time without notice. No part of this manual may be reproduced, copied, translated or transmitted in any form or by any means without the prior written permission of Advantech Co., Ltd. Information provided in this manual is intended to be accurate and reliable. However, Advantech Co., Ltd. assumes no responsibility for its use, nor for any infringements upon the rights of third parties which may result from its use.

Acknowledgements

- AWARD is a trademark of AWARD Software, Inc.
- IBM and PC are trademarks of International Business Machines Corporation.
- Intel®, Pentium® 4, and Celeron™ are trademarks of Intel Corporation.
- WinBond is a trademark of Winbond Corporation.

All other product names or trademarks are the properties of their respective owners.

Part No. 2002618600
Printed in Taiwan

1st. Edition
August 2002

A Message to the Customer

Advantech customer services

Each and every Advantech product is built to the most exacting specifications to ensure reliable performance in the harsh and demanding conditions typical of industrial environments. Whether your new Advantech equipment is destined for the laboratory or the factory floor, you can be assured that your product will provide the reliability and ease of operation for which the name Advantech has come to be known. Your satisfaction is our primary concern. Here is a guide to Advantech's customer services. To ensure you get the full benefit of our services, please follow the instructions below carefully.

Technical support

We want you to get the maximum performance from your products. So if you run into technical difficulties, we are here to help. For the most frequently asked questions, you can easily find answers in your product documentation. These answers are normally a lot more detailed than the ones we can give over the phone.

So please consult this manual first. If you still cannot find the answer, gather all the information or questions that apply to your problem, and with the product close at hand, call your dealer. Our dealers are well trained and ready to give you the support you need to get the most from your Advantech products. In fact, most problems reported are minor and are able to be easily solved over the phone.

In addition, free technical support is available from Advantech engineers every business day. We are always ready to give advice on application requirements or specific information on the installation and operation of any of our products.

PCA-6186 series comparison table					
Model	PCA-6186LV-00A1	PCA-6186VE-00A1	PCA-6186E2-00A1	PCA-6186VG-00A1	PCA-6186G2-00A1
CPU: Single socket 478 Intel® Pentium® 4/ Celeron™	V	V	V	V	V
Chipset	845GL	845G	845G	845G	845G
Front Side Bus	400 MHz	400/533 MHz	400/533 MHz	400/533 MHz	400/533 MHz
System chipset: Intel 845G	845GL	V	V	V	V
AGP4X	X	V	V	V	V
USB Port	2	2	6	2	6
PS/2 KB & Mouse Port	1	1	2	1	1
VGA: Intel 845G Integrated	V	V	V	V	V
Dual 10/100Base-T Ethernet LAN Intel 82562 & 82551	X	Single	Dual	X	X
Dual 10/100/1000 Base-T Ethernet LAN Intel 82540	X	X	X	Single	Dual

Product warranty

Advantech warrants to you, the original purchaser, that each of its products will be free from defects in materials and workmanship for two years from the date of purchase.

This warranty does not apply to any products which have been repaired or altered by persons other than repair personnel authorized by Advantech, or which have been subject to misuse, abuse, accident or improper installation. Advantech assumes no liability under the terms of this warranty as a consequence of such events.

If an Advantech product is defective, it will be repaired or replaced at no charge during the warranty period. For out-of-warranty repairs, you will be billed according to the cost of replacement materials, service time and freight. Please consult your dealer for more details.

If you think you have a defective product, follow these steps:

1. Collect all the information about the problem encountered. (For example, type of PC, CPU speed, Advantech products used, other hardware and software used, etc.) Note anything abnormal and list any on-screen messages you get when the problem occurs.
2. Call your dealer and describe the problem. Please have your manual, product, and any helpful information readily available.
3. If your product is diagnosed as defective, obtain an RMA (return material authorization) number from your dealer. This allows us to process your return more quickly.
4. Carefully pack the defective product, a fully-completed Repair and Replacement Order Card and a photocopy proof of purchase date (such as your sales receipt) in a shippable container. A product returned without proof of the purchase date is not eligible for warranty service.
5. Write the RMA number visibly on the outside of the package and ship it prepaid to your dealer.

Initial Inspection

Before you begin installing your card, please make sure that the following materials have been shipped:

- PCA-6186 Pentium ® 4/Celeron™ processor-based single board computer
- 1 PCA-6186 Startup Manual
- 1 CD with driver utility and manual (in PDF format)
- 1 FDD cable, P/N: 1700340640
- 2 Ultra ATA 100 HDD cables, P/N: 1701400452
- 1 printer (parallel port) cable & COM port cable kit, P/N: 1701260305
- 1 ivory cable for PS/2 keyboard and PS/2 mouse, P/N: 1700060202 (Y cable is not available for PCA-6186E2-00A1)
- 1 single-slot bracket, P/N: 1962159010 (optional)
- 1 USB cable adapter, P/N: 1700100170 (optional)

If any of these items are missing or damaged, contact your distributor or sales representative immediately.

We have carefully inspected the PCA-6186 mechanically and electrically before shipment. It should be free of marks and scratches and in perfect working order upon receipt.

As you unpack the PCA-6186, check it for signs of shipping damage. (For example, damaged box, scratches, dents, etc.) If it is damaged or it fails to meet the specifications, notify our service department or your local sales representative immediately. Also notify the carrier. Retain the shipping carton and packing material for inspection by the carrier. After inspection, we will make arrangements to repair or replace the unit.

Contents

Chapter 1	Hardware Configuration	2
1.1	Introduction	2
1.2	Features	3
1.3	Specifications	4
1.3.1	System.....	4
1.3.2	Memory.....	4
1.3.3	Input/Output.....	4
1.3.4	VGA interface.....	5
1.3.5	Ethernet LAN.....	5
1.3.6	Industrial features	5
1.3.7	Mechanical and environmental specifications.....	5
1.4	Jumpers and Connectors.....	6
	Table 1.1:Jumpers.....	6
	Table 1.2:Connectors.....	6
1.5	Board Layout: Jumper and Connector Locations.....	8
	Figure 1.1:Jumper and connector locations	8
	Figure 1.2:Extension I/O daughter board (for PCA-6186E2-00A1)	9
	Figure 1.3:Extension I/O daughter board (for PCA-6186G2-00A1).....	9
1.6	Safety Precautions	10
1.7	Jumper Settings	10
1.7.1	How to set jumpers	10
1.7.2	CMOS clear (J1)	11
	Table 1.3:CMOS (J1).....	11
1.7.3	Watchdog timer output (J2)	11
	Table 1.4:Watchdog timer output (J2).....	12
1.8	System Memory	12
	Table 1.5:DIMM module allocation table	12
1.8.1	Sample calculation: DIMM memory capacity.....	13
	Table 1.6:DIMM memory capacity sample calculation	13
1.9	Memory Installation Procedures	13
1.10	Cache Memory	13
1.11	CPU Installation	14
Chapter 2	Connecting Peripherals	16
2.1	Introduction	16
2.2	Primary (CN1) and Secondary (CN2) IDE Connectors..	16
2.3	Floppy Drive Connector (CN3).....	17
2.4	Parallel Port (CN4).....	17

2.5	USB Ports (CN6, CN31, and CN32).....	18
2.6	VGA Connector (CN7)	18
2.7	10/100Base-T Ethernet Connectors (CN8 and CN34)....	19
2.8	Serial Ports (CN9: COM1; CN10: COM2).....	19
2.9	PS/2 Keyboard and Mouse Connectors (CN11 and CN33)	20
2.10	External Keyboard Connector (CN12).....	20
2.11	Infrared (IR) Connector (CN13)	21
2.12	CPU Fan Connector (CN14)	21
2.13	Front Panel Connectors (CN16, 17, 18, 19, 21&22).....	22
	2.13.1 Power LED and Keyboard Lock (CN16)	22
	2.13.2 External speaker (CN17)	22
	2.13.3 Reset (CN18)	23
	2.13.4 HDD LED (CN19).....	23
	2.13.5 ATX soft power switch (CN21).....	23
2.14	ATX Power Control Connectors (CN20 and 21).....	23
	2.14.1 ATX feature connector (CN20) and soft power switch connector (CN21)	23
	2.14.2 Controlling the soft power switch.....	24
2.15	SM Bus Connector (CN29).....	24
2.16	Connecting to SNMP-1000 remote manager	25
2.17	AC-97 Audio Interface.....	25
2.18	Auxiliary 4-pin power connector (CN46 and CN47).....	25
Chapter 3	Award BIOS Setup.....	28
3.1	Introduction	28
3.2	Entering Setup.....	28
	Figure 3.1: Award BIOS Setup initial screen	28
3.3	Standard CMOS Setup	29
	Figure 3.2: Standard CMOS features screen	29
3.3.1	CMOS RAM backup	29
3.4	Advanced BIOS Features.....	30
	Figure 3.3: Advanced BIOS features screen.....	30
3.4.1	Virus Warning.....	31
3.4.2	L1 & L2 Cache	31
3.4.3	Quick Power On Self Test	31
3.4.4	First/Second/Third/Other Boot Device.....	31
3.4.5	Swap Floppy Drive	31
3.4.6	Boot UP Floppy Seek	31
3.4.7	Boot Up NumLock Status.....	31
3.4.8	Gate A20 Option.....	31
3.4.9	Typematic Rate Setting.....	31
3.4.10	Typematic Rate (Chars/Sec).....	31
3.4.11	Typematic Delay (msec).....	32

3.4.12	Security Option	32
3.4.13	APIC Mode	32
3.4.14	MPS Version Control For OS	32
3.5	Advanced Chipset Features	33
	Figure 3.4:Advanced chipset features screen	33
3.5.1	DRAM Timing Selectable	33
3.5.2	CAS Latency Time	33
3.5.3	Active to Precharge Delay	33
3.5.4	DRAM RAS# to CAS# Delay	34
3.5.5	RAS# Precharge Time	34
3.5.6	System BIOS Cacheable	34
3.5.7	Video Bios Cacheable	34
3.5.8	Memory Hole At 15M-16M	34
3.5.9	Delayed Transaction	34
3.5.10	Delay Prior to Thermal	34
3.5.11	AGP Aperture Size (MB)	34
3.5.12	On-Chip VGA	34
3.5.13	On-Chip Frame Buffer Size	35
3.5.14	Boot Display	35
3.6	Integrated Peripherals.....	35
3.6.1	IDE Primary (Secondary) Master/Slave PIO/UDMA Mode,	35
3.6.2	On-Chip Secondary PCI IDE.....	35
	Figure 3.5:Integrated peripherals (1)	35
3.6.3	USB Controller	36
3.6.4	USB Keyboard/Mouse Support	36
3.6.5	AC97 Audio.....	36
3.6.6	Init Display First	36
3.6.7	Onboard LAN1 Control	36
3.6.8	Onboard LAN2 Control	36
3.6.9	IDE HDD Block Mode	36
3.6.10	Onboard FDC Controller	36
3.6.11	Onboard Serial Port 1	36
3.6.12	Onboard Serial Port 2	36
3.6.13	UART Mode Select	37
	Figure 3.6:Integrated peripherals (2)	37
3.6.14	RxD, TxD Active	37
3.6.15	IR Transmission Delay	37
3.6.16	UR2 Duplex Mode.....	37
3.6.17	Onboard Parallel Port.....	37
3.6.18	Parallel Port Mode	37
3.6.19	EPP Mode Select	38
3.6.20	ECP Mode Use DMA	38
3.7	Power Management Setup.....	38
	Figure 3.7:Power management setup screen (1).....	38

3.7.1	Power-Supply Type	38
3.7.2	ACPI function	38
3.7.3	Power Management	39
3.7.4	Video Off In Suspend	39
3.7.5	Modem Use IRQ	39
3.7.6	HDD Power Down	39
3.7.7	Soft-Off by PWR-BTTN	39
3.7.8	CPU THRM-Throttling	39
3.7.9	PowerOn By LAN	39
3.7.10	PowerOn By Modem	40
3.7.11	PowerOn By Alarm	40
3.7.12	Primary IDE 0 (1) and Secondary IDE 0 (1)	40
3.7.13	FDD, COM, LPT PORT	40
3.7.14	PCI PIRQ [A-D]#	40
	Figure 3.8:Power management setup screen (2)	40
3.8	PnP/PCI Configurations	41
3.8.1	PnP OS Installed	41
	Figure 3.9:PnP/PCI configurations screen	41
3.8.2	Reset Configuration Data	41
3.8.3	Resources controlled by:	41
3.8.4	PCI/VGA Palette Snoop	41
3.9	PC Health Status	42
3.9.1	CPU Warning Temperature	42
	Figure 3.10:PC health status screen	42
3.9.2	Current CPU Temperature	42
3.9.3	Current CPUFAN Speed	42
3.9.4	+5V/+12V/-12V/-5V	42
3.10	Password Setting	43
3.11	Save & Exit Setup	43
3.12	Exit Without Saving	44
Chapter 4	Chipset Software Installation Utility	46
4.1	Before you begin	46
4.2	Introduction	46
4.3	Installing the CSI Utility	47
Chapter 5	AGP VGA Setup	48
5.1	Introduction	48
5.2	Dynamic Video Memory Technology	48
5.3	Installation	49
Chapter 6	LAN Configuration	54
6.1	Introduction	54
6.2	Features	54
6.3	Installation	55
6.4	Windows 98/2000 Drivers Setup Procedure (Intel 82540	

	and 82562/82551)	55
	6.5 Windows NT Drivers Setup Procedure (Intel 82540).....	61
	6.6 Windows NT Wake-on-LAN Setup Procedure.....	64
Chapter	7 USB 2.0 Configuration	68
	7.1 Introduction	68
	7.2 Features	68
	7.3 Installation	68
Chapter	8 Ultra ATA Storage Driver Setup.....	76
	8.1 Introduction	76
	8.2 Features	76
	8.3 Window 2000 Setup Procedure.....	77
	8.4 Displaying Driver Information.....	80
	8.5 NT Setup Procedure	81
Chapter	9 Onboard Security Setup	86
	9.1 Introduction	86
	9.2 Windows 9X Drivers Setup Procedure	87
	9.3 Windows 2000/NT Drivers Setup Procedure.....	89
	9.4 Using the OBS Hardware Doctor Utility	92
Appendix A	Programming the watchdog timer	94
	A.1 Programming the Watchdog Timer.....	94
	A.1.1 Watchdog timer overview.....	94
	A.1.2 Reset/ Interrupt selection	94
	A.1.3 Programming the Watchdog Timer	94
	A.1.4 Example Program	97
Appendix B	Pin Assignments	104
	B.1 IDE Hard Drive Connector (CN1, CN2).....	104
	Table B-1:IDE hard drive connector (CN1, CN2)	104
	B.2 Floppy Drive Connector (CN3).....	105
	Table B-2:Floppy drive connector (CN3)	105
	B.3 Parallel Port Connector (CN4)	106
	Table B-3:Parallel port connector (CN4)	106
	B.4 USB Connector (CN6)	107
	Table B-4:USB1/USB2 connector (CN6)	107
	B.5 VGA Connector (CN7)	107
	Table B-5: VGA connector (CN7)	107
	Table B-6:Ethernet 10/100Base-T RJ-45 connector (CN8, CN34).....	108
	B.7 COM1/COM2 RS-232 Serial Port (CN9, CN10).....	108
	Table B-7:COM1/COM2 RS-232 serial port (CN9, CN10).....	108
	B.8 Keyboard and Mouse Connector (CN11).....	109

	Table B-8:Keyboard and mouse connector (CN11) ..	109
B.9	External Keyboard Connector (CN12).....	109
	Table B-9:External keyboard connector (CN12).....	109
B.10	IR Connector (CN13).	110
	Table B-10:IR connector (CN13)	110
B.11	CPU Fan Power Connector (CN14).....	110
	Table B-11:CPU fan power connector (CN14)	110
B.12	Power LED and Keyboard Lock (CN16).....	111
	Table B-12:Power LED and keylock connector (CN16)	111
B.13	External Speaker Connector (CN17).....	111
	Table B-13:External speaker (CN17)	111
B.14	Reset Connector (CN18)	112
	Table B-14:Reset connector (CN18)	112
B.15	HDD LED Connector (CN19).....	112
	Table B-15:HDD LED connector (CN19).....	112
B.16	ATX Feature Connector (CN20).....	113
	Table B-16:ATX feature connector (CN20).....	113
B.17	ATX Soft Power Switch (CN21))	113
	Table B-17:ATX soft power switch (CN21)	113
B.18	H/W Monitor Alarm (CN22).....	113
	Table B-18:H/W monitor alarm (CN22)	113
B.19	Extension I/O Board Connector (CN27).....	114
	Table B-19:Extension I/O board connector (CN27)...	114
B.20	Extension I/O Board Connector (CN28).....	114
	Table B-20:Extension I/O board connector (CN28)..	114
B.21	SM Bus Connector (CN29).....	115
B.22	SM Bus Connector (CN 29).....	115
B.23	PS/2 Mouse Connector (CN33).....	115
	Table B-21:PS/2 mouse connector (CN33)	115
B.24	AC-97 Audio Interface (CN43).....	116
	Table B-22:System I/O ports	116
B.25	System I/O Ports.....	116
B.26	DMA Channel Assignments.....	117
	Table B-23:DMA channel assignments.....	117
B.27	Interrupt Assignments	117
	Table B-24:Interrupt assignments.....	117
B.28	1st MB Memory Map.....	118
	Table B-25:1st MB memory map	118
B.29	PCI Bus Map.....	118
	Table B-26:PCI bus map	118

General Information

This chapter gives background information on the PCA-6186. It then shows you how to configure the card to match your application and prepare it for installation into your PC.

Sections include:

- Introduction
- Features
- Specifications
- Board Layout
- Jumpers and Connectors
- Safety Precautions
- Jumper Settings
- System Memory
- Memory Installation Procedures
- Cache Memory
- CPU Installation

Chapter 1 Hardware Configuration

1.1 Introduction

Advantech's PCA-6186 full-size CPU card is designed with Intel 845G chipset and supports socket 478 Pentium 4/Celeron processor (FSB 400/533MHz) up to 2.4GHz and above. In addition to high-speed processor, PCA-6186 supports up to 2GB DDR memory with 2 DIMM socket on board. It provides maximum computing power and productivity which is ideal for high-performance demanding application. Intel's 845G integrated VGA provides superior 3D performance with AGP 4X. Dual Intel 82551/82562 10/100Base-T Ethernet controller or dual Intel 82540 10/100/1000Base-T Ethernet controller are available in PCA-6186 series. The high reliability and excellent performance provided by Intel Ethernet controller are crucial for various network applications. PCA-6186 also offers an exclusive feature of USB 2.0 and which provides high speed data transfer rate up to 480 Mb/sec. In addition to onboard two USB connectors, flexible I/O expansion board allows customer to optimize their need for additional four USB port.

A backup of CMOS data is stored in the Flash memory, which protects data even after a battery failure. Also included is a 255-level watchdog timer, which resets the CPU or generates an interrupt if a program cannot be executed normally. This enables reliable operation in unattended environments.

The remote management interface enables the PCA-6186 to be managed through Ethernet when it is connected to the SNMP-1000 Remote HTTP/SNMP System Manager..

Note: *Some of the features mentioned above are not available with all models. For more information about the specifications of a particular model, see Section 1.3: Specifications.*

1.2 Features

1. **Fan status monitoring and alarm:** To prevent system overheating and damage, the CPU fan can be monitored for speed and failure. The fan is set for its normal RPM range and alarm thresholds.
2. **Temperature monitoring and alert:** To prevent system overheating and damage, the CPU card supports processor thermal sensing and auto-protection.
3. **Voltage monitoring and alert:** System voltage levels are monitored to ensure stable current flows to critical components. Voltage specifications will become even more critical for processors of the future. Thus monitoring will become ever more necessary to ensure proper system configuration and management.
4. **ATX soft power switch:** Through the BIOS, the power button can be defined as the "Standby" (aka "Suspend" or "Sleep") button or as the "Soft-Off" button (see Section 3.7.8 Soft-off by PWR-BTN). Regardless of the setting, pushing the power button for more than 4 seconds will enter the Soft-Off mode.
5. **Power-on by modem (requires modem):** This allows a computer to be turned on remotely through an internal or external modem. Users can thus access information on their computers from anywhere in the world.
6. **Power-on by LAN:** This allows you to remotely power up your system through your network by sending a wake-up frame or signal. With this feature, you can remotely upload/ download data to/ from systems during off-peak hours.
7. **Message LED:** Chassis LEDs now act as information providers. The way a particular LED illuminates indicates the stage the computer is in. A single glimpse provides useful information to the user.
8. **CMOS RAM backup:** When BIOS CMOS setup has been completed, data in the CMOS RAM is automatically backed up to the Flash ROM. This is particularly useful in industrial environments which may cause soft errors. Upon such an error occurring, BIOS will check the data, and automatically restore the original data for booting.

9. More:

- **Power On by Alarm:** Powers up your computer at a certain time.
- **Virus warning:** During and after system boot-up, any attempt to write to the boot sector or partition table of the hard disk drive will halt the system. In this case, a warning message will be displayed. You can then run your anti-virus program to locate the problem

1.3 Specifications

1.3.1 System

- **CPU:** PCA-6186 supports Intel Pentium® 4/ Celeron™ up to 2.4GHz and the above, FSB 400/533 MHz (PCA-6186LV-00A1 only supports 400MHz).
- **Firmware hub:** Provides security enhancements on computer platforms by supporting Random Number Generator (RNG)
- **BIOS:** Award Flash BIOS (4Mb Flash Memory)
- **System Chipset:** Intel® 845G chipset (Intel 845GL for PCA-6186LV-00A1)
- **PCI enhanced IDE hard disk drive interface:** Supports up to four IDE (AT-bus) large hard disk drives or other enhanced IDE devices. Supports PIO mode 4 (16.67 MB/s data transfer rate) and Ultra ATA 100/66/33 (100/66/33 MB/s data transfer rate). BIOS enabled/disabled
- **Floppy disk drive interface:** Supports up to two floppy disk drives, 5¼" (360 KB and 1.2 MB) and/or 3½" (720 KB, 1.44 MB). BIOS enabled/disabled

1.3.2 Memory

- **RAM:** Up to 2GB in two 184-pin DIMM sockets. Supports DDR200/266 SDRAM.
- **ECC:** DRAM not supported

1.3.3 Input/Output

- **Bus interface:** PCI/ISA bus, PICMG compliant
- **Enhanced parallel port:** Configurable to LPT1, LPT2, LPT3, or disabled. Standard DB-25 female connector provided. Supports EPP/SPP/ECP
- **Serial ports:** Two RS-232 ports with 16C550 UARTs (or compatible) with 16-byte FIFO buffer. Supports speeds up to 115.2 Kbps. Ports can be individually configured to COM1, COM2 or disabled

- **Keyboard and PS/2 mouse connector:** One 6-pin mini-DIN connector is located on the mounting bracket for easy connection to a keyboard or PS/2 mouse. An onboard keyboard pin header connector is also available
- **USB port:** Supports up to six USB 2.0 and transmission rate up to 480Mbps. (Six USB ports are available in PCA-6186E2-00A1 and PCA-6186G2-00A1)
- **ISA driver current:** 64 mA (High Drive)

1.3.4 VGA interface

- **Supports AGP 4X**
- **Controller:** Intel 845G chipset integrated
- **Display memory:** shared from system memory up to 8-64MB SDRAM

1.3.5 Ethernet LAN

- **Supports dual 10/100Base-T networking (or dual 10/100/1000Base-T Ethernet networking)**
- **Chipset:** Dual Intel® 82562 and 82551 chipset for 10/100Base-T LAN or (Dual Intel 82540 chipset for GbE LAN)

1.3.6 Industrial features

- **Watchdog timer:** Can generate a system reset or IRQ11. The watchdog timer is programmable, with each unit equal to one minute (255 levels).

1.3.7 Mechanical and environmental specifications

- **Operating temperature:** 0°~60° C (32° ~ 140° F, Depending on CPU)
- **Storage temperature:** -20°~ 70° C (-4° ~ 158° F)
- **Humidity:** 20 ~ 95% non-condensing
- **Power supply voltage:** +5 V, ±12 V
- **Power consumption:** Typical: +5V @8.7A, +12V @310mA (Pentium(R) 4 2GHz, 256 MB DDR266)
- **Board size:** 338 x 122 mm (13.3" x 4.8")
- **Board weight:** 0.5 kg (1.2 lb)

1.4 Jumpers and Connectors

Connectors on the PCA-6186 board link it to external devices such as hard disk drives and a keyboard. In addition, the board has a number of jumpers used to configure your system for your application.

The tables below list the function of each of the board jumpers and connectors. Later sections in this chapter give instructions on setting jumpers. Chapter 2 gives instructions for connecting external devices to your card..

Table 1.1: Jumpers

Label	Function
J1	CMOS Clear
J2	Watchdog timer output selection

Table 1.2: Connectors

Label	Function
CN1	Primary IDE connector
CN2	Secondary IDE connector
CN3	Floppy drive connector
CN4	Parallel port
CN6	USB port
CN7	VGA connector
CN8	10/100/1000Base-T Ethernet connector 1
CN9	Serial port: COM1
CN10	Serial port: COM2
CN11	PS/2 keyboard and mouse connector
CN12	External keyboard connector
CN13	Infrared (IR) connector
CN14	CPU FAN connector
CN16	Power LED and Keyboard Lock
CN17	External speaker
CN18	Reset connector

<i>Table 1.2: Connectors</i>	
CN19	HDD LED connector
CN20	ATX feature connector
CN21	ATX soft power switch
CN22	HW Monitor Alarm Close: Enable OBS Alarm Open: Disable OBS Alarm
CN27	Extension I/O board connector
CN28	Extension I/O board connector
CN29	SM BUS Connector PIN1: SMB_DATA PIN2: SMB_CLOCK
CN31	USB 0,1
CN32	USB 2, 3
CN33	PS/2 Keyboard and Mouse connector
CN34	10/100/1000Base-T Ethernet connector 2
CN43	AC-97 Audio connector
CN46	Auxiliary 4-pin power connector
CN47	Auxiliary 4-pin power connector

1.5 Board Layout: Jumper and Connector Locations

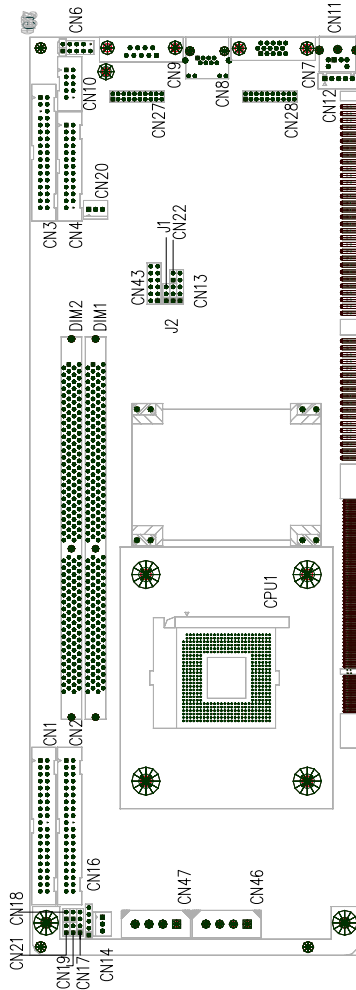

Figure 1.1: Jumper and connector locations

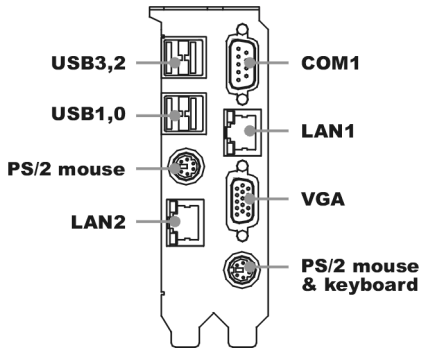

Figure 1.2: Extension I/O daughter board (for PCA-6186E2-00A1)

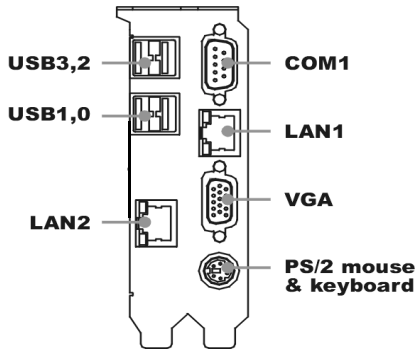

Figure 1.3: Extension I/O daughter board (for PCA-6186G2-00A1)

1.6 Safety Precautions

Warning! Always completely disconnect the power cord from your chassis whenever you work with the hardware. Do not make connections while the power is on. Sensitive electronic components can be damaged by sudden power surges. Only experienced electronics personnel should open the PC chassis.

Caution! Always ground yourself to remove any static charge before touching the CPU card. Modern electronic devices are very sensitive to static electric charges. As a safety precaution, use a grounding wrist strap at all times. Place all electronic components on a static-dissipative surface or in a static-shielded bag when they are not in the chassis.

Caution! The computer is provided with a battery-powered Real-time Clock circuit. There is a danger of explosion if battery is incorrectly replaced. Replace only with same or equivalent type recommended by the manufacturer. Discard used batteries according to manufacturer's instructions.

1.7 Jumper Settings

This section provides instructions on how to configure your card by setting the jumpers. It also includes the card's default settings and your options for each jumper.

1.7.1 How to set jumpers

You configure your card to match the needs of your application by setting the jumpers. A jumper is a metal bridge that closes an electrical circuit. It consists of two metal pins and a small metal clip (often protected by a plastic cover) that slides over the pins to connect them. To “close” (or turn ON) a jumper, you connect the pins with the clip. To “open” (or turn

OFF) a jumper, you remove the clip. Sometimes a jumper consists of a set of three pins, labeled 1, 2, and 3. In this case you connect either pins 1 and 2, or 2 and 3. A pair of needle-nose pliers may be useful when setting jumpers.

1.7.2 CMOS clear (J1)

The PCA-6186 CPU card contains a jumper that can erase CMOS data and reset the system BIOS information. Normally this jumper should be set with pins 1-2 closed. If you want to reset the CMOS data, set J1 to 2-3 closed for just a few seconds, and then move the jumper back to 1-2 closed. This procedure will reset the CMOS to its default setting.

Table 1.3: CMOS (J1)

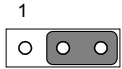
Function	Jumper Setting
* Keep CMOS data 1-2 closed	 <p>A diagram of a 3-pin jumper. The pins are labeled 1, 2, and 3 from left to right. A dark grey bar connects pins 1 and 2, while pin 3 is open.</p>
Clear CMOS data 2-3 closed	 <p>A diagram of a 3-pin jumper. The pins are labeled 1, 2, and 3 from left to right. Pin 1 is open, and a dark grey bar connects pins 2 and 3.</p>

* default setting

1.7.3 Watchdog timer output (J2)

The PCA-6186 contains a watchdog timer that will reset the CPU or send a signal to IRQ11 in the event the CPU stops processing. This feature means the PCA-6186 will recover from a software failure or an EMI problem. The J2 jumper settings control the outcome of what the computer will do in the event the watchdog timer is tripped.

Table 1.4: Watchdog timer output (J2)

Function	Jumper Setting
----------	----------------

IRQ11	1-2 closed
-------	------------

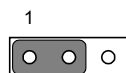

* Reset	2-3 closed
---------	------------

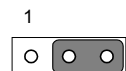

* default setting

Note: *The interrupt output of the watchdog timer is a low level signal. It will be held low until the watchdog timer is reset.*

1.8 System Memory

The top-left edge of the PCA-6186 contains two sockets for 184-pin dual in-line memory modules (DIMMs). Both two sockets use 3.3 V unbuffered synchronous DRAMs (DDR SDRAM). DIMMs are available in capacities of 64, 128, 256, 512 MB, or 1 GB. The sockets can be filled in any combination with DIMMs of any size, giving your PCA-6186 single board computer between 64 MB and 2 GB of memory. Use the following table to calculate the total DRAM memory within your computer:

Table 1.5: DIMM module allocation table

Socket number	184-pin DIMM memory
1	64, 128, 256, 512 MB, or 1GB)
2	64, 128, 256, 512 MB, or 1GB)

1.8.1 Sample calculation: DIMM memory capacity

Suppose you install a 512 MB DIMM into your PCA-6186's socket 1 and a 512 MB DIMM into sockets 2. Your total system memory is 1 GB, calculated as follows:

Table 1.6: DIMM memory capacity sample calculation

Socket number	184-pin DIMM memory	Total Memory
1	512 MB x 1	512 MB
2	512 MB x 1	512 MB
Total memory	1 GB	

1.9 Memory Installation Procedures

To install DIMMs, first make sure the two handles of the DIMM socket are in the "open" position. i.e. The handles lean outward. Slowly slide the DIMM module along the plastic guides on both ends of the socket. Then press the DIMM module right down into the socket, until you hear a click. This is when the two handles have automatically locked the memory module into the correct position of the DIMM socket. To remove the memory module, just push both handles outward, and the memory module will be ejected by the mechanism in the socket.

1.10 Cache Memory

Since the second-level (L2) cache has been embedded into the Intel® socket 478 Pentium® 4/Celeron™ processor, you do not have to take care of either SRAM chips or SRAM modules. The built-in second-level cache in the processor yields much higher performance than the external cache memories. The cache size in the Intel® Pentium® 4 processor is 512 KB. In the Celeron CPU, the cache size is 128KB.

1.11 CPU Installation

The PCA-6186 is designed for Intel Pentium® 4 processor/Celeron™ (socket 478)

Note: Slim Heatsink & Fan is available from Advantech. Part number is 1759252100. Please contact with Advantech's sales representative if needed.

CHAPTER 2

Connecting Peripherals

This chapter tells how to connect peripherals, switches, and indicators to the PCA-6186 board.

Chapter 2 Connecting Peripherals

2.1 Introduction

You can access most of the connectors from the top of the board while it is installed in the chassis. If you have a number of cards installed or have a packed chassis, you may need to partially remove the card to make all the connections.

2.2 Primary (CN1) and Secondary (CN2) IDE Connectors

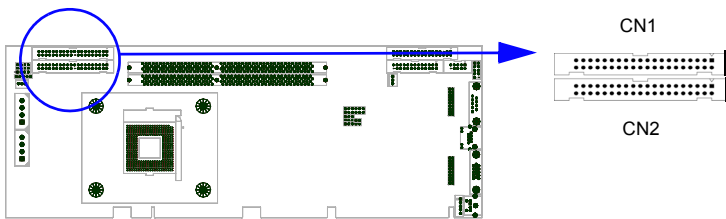

You can attach up to four IDE (Integrated Drive Electronics) drives to the PCA-6186's built-in controller. The primary (CN1) and secondary (CN2) connectors can each accommodate two drives.

Wire number 1 on the cable is red or blue and the other wires are gray. Connect one end to connector CN1 or CN2 on the CPU card. Make sure that the red/blue wire corresponds to pin 1 on the connector (in the upper right hand corner). See Chapter 1 for help finding the connector.

Unlike floppy drives, IDE hard drives can connect in either position on the cable. If you install two drives to a single connector, you will need to set one as the master and the other as the slave. You do this by setting the jumpers on the drives. If you use just one drive per connector, you should set each drive as the master. See the documentation that came with your drive for more information.

Connect the first hard drive to the other end of the cable. Wire 1 on the cable should also connect to pin 1 on the hard drive connector, which is labeled on the drive circuit board. Check the documentation that came with the drive for more information.

Connect the second hard drive to the remaining connector (CN2 or CN1), in the same way as described above.

2.3 Floppy Drive Connector (CN3)

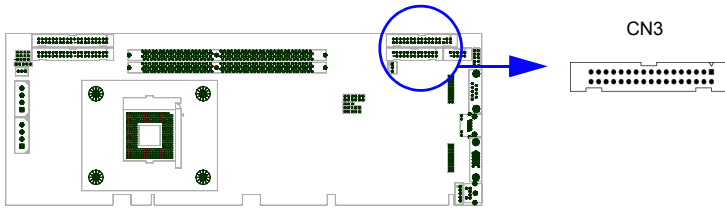

You can attach up to two floppy disk drives to the PCA-6186's onboard controller. You can use 3.5" (720 KB, 1.44 MB) drives.

The card comes with a 34-pin daisy-chain drive connector cable. On one end of the cable is a 34-pin flat-cable connector. On the other end are two sets of 34-pin flat-cable connector (usually used for 3.5" drives). The set on the end (after the twist in the cable) connects to the A: floppy drive. The set in the middle connects to the B: floppy drive.

2.4 Parallel Port (CN4)

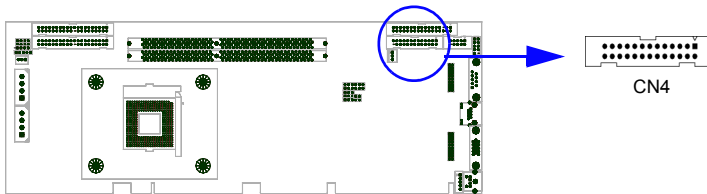

The parallel port is normally used to connect the CPU card to a printer. The PCA-6186 includes an onboard parallel port, accessed through a 26-pin flat-cable connector, CN4. The card comes with an adapter cable which lets you use a traditional DB-25 connector. The cable has a 26-pin connector on one end and a DB-25 connector on the other, mounted on a retaining bracket. The bracket installs at the end of an empty slot in your chassis, giving you access to the connector.

To install the bracket, find an empty slot in your chassis. Unscrew the plate that covers the end of the slot. Screw in the bracket in place of the plate. Next, attach the flat-cable connector to CN4 on the CPU card. Wire 1 of the cable is red or blue, and the other wires are gray. Make sure that wire 1 corresponds to pin 1 of CN4. Pin 1 is on the upper right side of CN4.

2.5 USB Ports (CN6, CN31, and CN32)

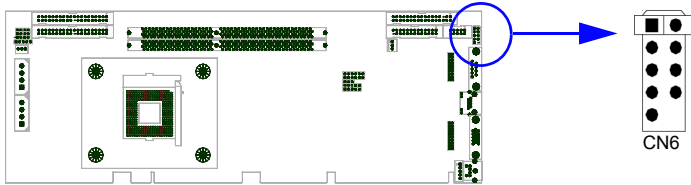

The PCA-6186 provides up to six ports of USB (Universal Serial Bus) interface, which gives complete Plug & Play and hot swapping for up to 127 external devices. The USB interface complies with USB Specification Rev. 2.0 support transmission rate up to 480 Mbps and is fuse-protected. The USB interface can be disabled in the system BIOS setup.

2.6 VGA Connector (CN7)

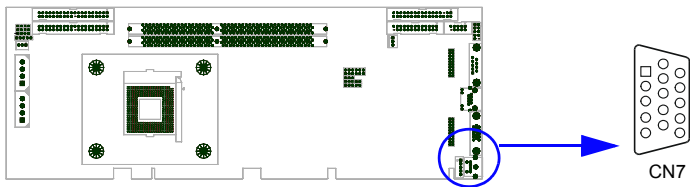

The PCA-6186 includes a VGA interface that can drive conventional CRT displays. CN7 is a standard 15-pin D-SUB connector commonly used for VGA. Pin assignments for CRT connector CN7 are detailed in Appendix B.

2.7 10/100Base-T Ethernet Connectors (CN8 and CN34)

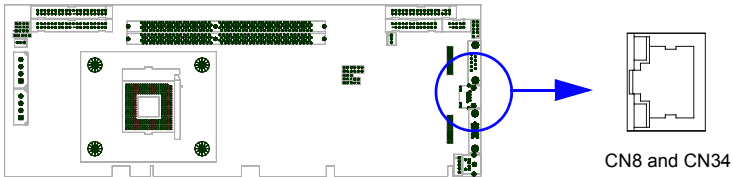

The PCA-6186 is equipped with one or two high-performance 32-bit PCI-bus Ethernet interfaces, which are fully compliant with IEEE 802.3/u 10/100 Mbps CSMA/CD standards. Also, PCA-6186 provides the option of supporting single or dual 10/10/1000 Mbps Ethernet LANs. They are supported by all major network operating systems. The RJ-45 jacks on the rear plate provide convenient 10/100/1000 Base-T RJ-45 operation. If users use dual LANs, the second LAN port, CN34, is located at top slot of the I/O expansion ports.

2.8 Serial Ports (CN9: COM1; CN10: COM2)

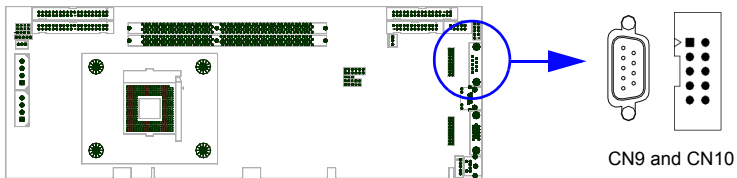

The PCA-6186 offers two serial ports, CN9 as COM1 and CN10 as COM2. These ports can connect to serial devices, such as a mouse or a printer, or to a communications network.

The IRQ and address ranges for both ports are fixed. However, if you want to disable the port or change these parameters later, you can do this in the system BIOS setup.

Different devices implement the RS-232 standard in different ways. If you are having problems with a serial device, be sure to check the pin assignments for the connector.

2.9 PS/2 Keyboard and Mouse Connectors (CN11 and CN33)

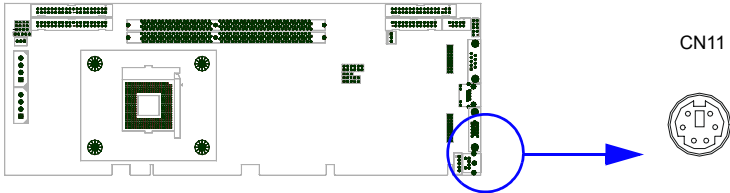

Two 6-pin mini-DIN connectors (CN11 and CN33) on the card mounting bracket provide connection to a PS/2 keyboard and a PS/2 mouse, respectively. CN11 can also be connected to an adapter cable (P/N: 1700060202, available from Advantech) for connecting to both a PS/2 keyboard and a PS/2 mouse.

2.10 External Keyboard Connector (CN12)

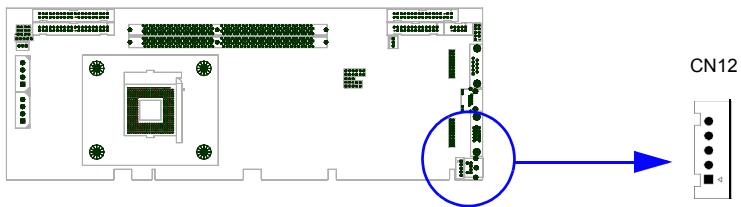

In addition to the PS/2 mouse/keyboard connector on the PCA-6186's ear plate, there is also an extra onboard external keyboard connector. This gives system integrators greater flexibility in designing their systems.

2.11 Infrared (IR) Connector (CN13)

This connector supports the optional wireless infrared transmitting and receiving module. This module mounts on the system case. You must configure the setting through the BIOS setup (see Chapter 3).

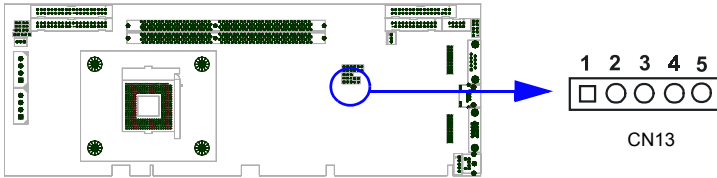

2.12 CPU Fan Connector (CN14)

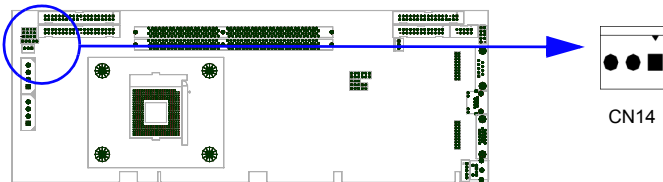

If fan is used, this connector supports cooling fans of 500mA (6W) or less.

2.13 Front Panel Connectors (CN16, 17, 18, 19, 21&22)

There are several external switches to monitor and control the PCA-6186.

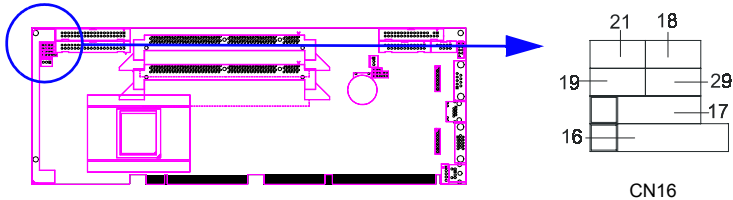

2.13.1 Power LED and Keyboard Lock (CN16)

CN16 is a 5-pin connector for the keyboard lock and power on LED. Refer to Appendix B for detailed information on the pin assignments. If a PS/2 or ATX power supply is used, the system's power LED status will be as indicated below:

Table 2.1: PS/2 or ATX power supply LED status

Power mode	LED (PS/2 power)	LED (ATX power)
System On	On	On
System Suspend	Fast flashes	Fast flashes
System Off	Off	Slow flashes

2.13.2 External speaker (CN17)

CN17 is a 4-pin connector for an external speaker. If there is no external speaker, the PCA-6186 provides an onboard buzzer as an alternative. To enable the buzzer, set pins 3-4 as closed

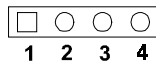

2.13.3 Reset (CN18)

Many computer cases offer the convenience of a reset button. Connect the wire from the reset button



2.13.4 HDD LED (CN19)

You can connect an LED to connector CN19 to indicate when the HDD is active.



2.13.5 ATX soft power switch (CN21)

If your computer case is equipped with an ATX power supply, you should connect the power on/off button on your computer case to CN21. This connection enables you to turn your computer on and off.

2.14 ATX Power Control Connectors (CN20 and 21)

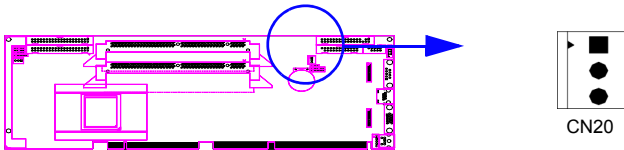

Note: Refer to the diagram on the previous page for the location of CN21.

2.14.1 ATX feature connector (CN20) and soft power switch connector (CN21)

The PCA-6186 can support an advanced soft power switch function if an ATX power supply is used. To enable the soft power switch function:

1. Take the specially designed ATX-to-PS/2 power cable out of the PCA-6186's accessory bag.

2. Connect the 3-pin plug of the cable to CN20 (ATX feature connector).
3. Connect the power on/off button to CN21. (A momentary type of button should be used.)

Note: *If you will not be using an ATX power connector, make sure that pins 2-3 of CN20 are closed.*

Warnings:

1. *Make sure that you unplug your power supply when adding or removing expansion cards or other system components. Failure to do so may cause severe damage to both your CPU card and expansion cards.*
2. *ATX power supplies may power on if certain motherboard components or connections are touched by metallic objects.*

Important: *Make sure that the ATX power supply can take at least a 720 mA load on the 5 V standby lead (5VSB). If not, you may have difficulty powering on your system and/or supporting the "Wake-on-LAN" function.*

2.14.2 Controlling the soft power switch

Users can also identify the current power mode through the system's power LED.

2.15 SM Bus Connector (CN29)

This connector is reserved for Advantech's SNMP-1000 HTTP/SNMP Remote System Manager. The SNMP-1000 allows users to monitor the internal voltages, temperature and fans from a remote computer through an Ethernet network.

CN29 can be connected to CN19 of SNMP-1000. Please be careful about the pin assignments, pin 1 must be connected to pin 1 and pin2 to pin 2 on both ends of cable.

2.16 Connecting to SNMP-1000 remote manager

Use the 6-pin to 8-pin cable to connect the CPU card to SNMP-1000. This cable comes with the SNMP-1000.



2.17 AC-97 Audio Interface

The PCA-6186 provides AC-97 audio through PCA-AUDIO-00A1 module from Advantech.

2.18 Auxiliary 4-pin power connector (CN46 and CN47)

To ensure the sufficiency of power supply for Pentium(R) 4 CPU card, two auxiliary 4 pin power connector are available in PCA-6186. It is strongly suggested to use auxiliary 4 pin power connector for adequate power supply.

CHAPTER 3

Award BIOS Setup

This chapter describes how to set the card's BIOS configuration data.

Chapter 3 Award BIOS Setup

3.1 Introduction

Award's BIOS ROM has a built-in setup program that allows users to modify the basic system configuration. This type of information is stored in battery-backed memory (CMOS RAM) so that it retains the setup information when the power is turned off.

3.2 Entering Setup

Turn on the computer and check for the “patch code”. If there is a number assigned to the patch code, it means that the BIOS supports your CPU.

If there is no number assigned to the patch code, please contact Advantech's applications engineer to obtain an up-to-date patch code file. This will ensure that your CPU's system status is valid.

After ensuring that you have a number assigned to the patch code, press to allow you to enter the setup.

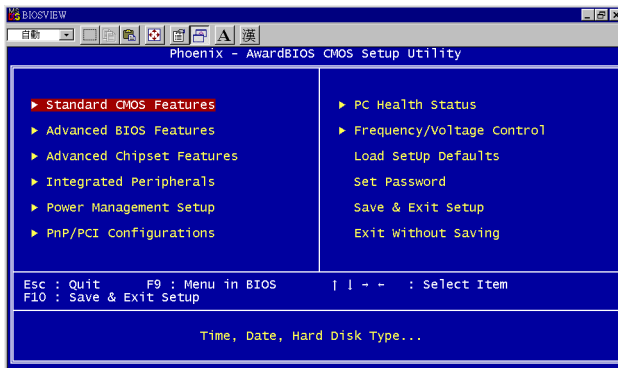

Figure 3.1: Award BIOS Setup initial screen

3.3 Standard CMOS Setup

Choose the “Standard CMOS Features” option from the “Initial Setup Screen” menu, and the screen below will be displayed. This menu allows users to configure system components such as date, time, hard disk drive, floppy drive, display, and memory.

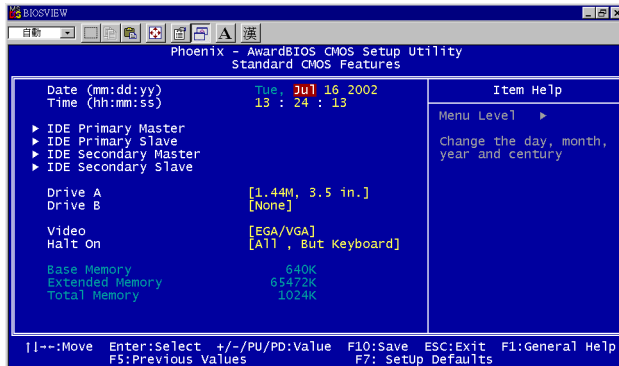

Figure 3.2: Standard CMOS features screen

3.3.1 CMOS RAM backup

The CMOS RAM is powered by an onboard button cell battery.

When BIOS CMOS Setup has been completed, CMOS RAM data is automatically backed up to Flash ROM. If conditions in a harsh industrial environment cause a soft error, BIOS will recheck the data and automatically restore the original data for booting.

3.4.1 Virus Warning

If enabled, a warning message and alarm beep activates if someone attempts to write here. The commands are “Enabled” or “Disabled.”

3.4.2 L1 & L2 Cache

Enabling this feature speeds up memory access. The commands are “Enabled” or “Disabled.”

3.4.3 Quick Power On Self Test

This option speeds up the Power-On Self Test (POST) conducted as soon as the computer is turned on. When enabled, BIOS shortens or skips some of the items during the test. When disabled, the computer conducts normal POST procedures.

3.4.4 First/Second/Third/Other Boot Device

The BIOS tries to load the OS with the devices in the sequence selected. Choices are: Floppy, LS/ZIP, HDD, SCSI, CDROM, LAN, Disabled.

3.4.5 Swap Floppy Drive

Logical name assignments of floppy drives can be swapped if there is more than one floppy drive. The commands are “Enabled” or “Disabled.”

3.4.6 Boot UP Floppy Seek

Selection of the command “Disabled” will speed the boot up. Selection of “Enabled” searches disk drives during boot up.

3.4.7 Boot Up NumLock Status

This feature selects the “power on” state for NumLock. The commands are “Enabled” or “Disabled.”

3.4.8 Gate A20 Option

Normal: A pin in keyboard controller controls GateA20

Fast (Default): Chipect controls GateA20.

3.4.9 Typematic Rate Setting

The typematic rate is the rate key strokes repeat as determined by the keyboard controller. The commands are “Enabled” or “Disabled.” Enabling allows the typematic rate and delay to be selected.

3.4.10 Typematic Rate (Chars/Sec)

BIOS accepts the following input values (characters/second) for typematic rate: 6, 8, 10, 12, 15, 20, 24, 30.

3.4.11 Typematic Delay (msec)

Typematic delay is the time interval between the appearance of two consecutive characters, when holding down a key. The input values for this category are: 250, 500, 750, 1000 (msec).

3.4.12 Security Option

This setting determines whether the system will boot up if the password is denied. Access to Setup is always limited.

System The system will not boot, and access to Setup will be denied if the correct password is not entered at the prompt.

Setup The system will boot, but access to Setup will be denied if the correct password is not entered at the prompt.

Note: *To disable security, select "PASSWORD SETTING" in the main menu. At this point, you will be asked to enter a password. Simply press <Enter> to disable security. When security is disabled, the system will boot, and you can enter Setup freely.*

3.4.13 APIC Mode

This setting allows selecting an OS with greater than 64MB of RAM. Commands are "Non-OS2" or "OS2."

3.4.14 MPS Version Control For OS

This reports if an FDD is available for Windows 95. The commands are "Yes" or "No."

3.5 Advanced Chipset Features

By choosing the “Advanced Chipset Features” option from the “Initial Setup Screen” menu, the screen below will be displayed. This sample screen contains the manufacturer’s default values for the PCA-6186, as shown in Figure 3-4:

Note: *DRAM default timings have been carefully chosen and should ONLY be changed if data is being lost. Please first contact technical support.*

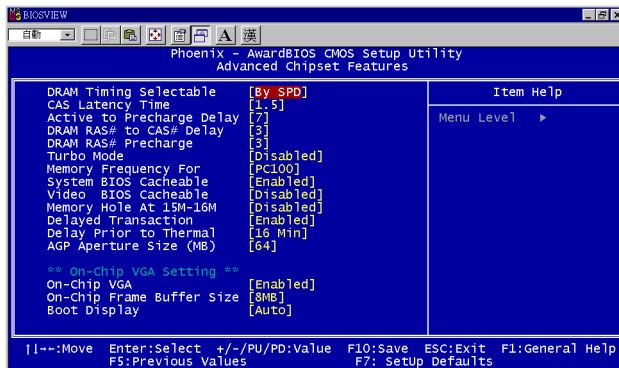

Figure 3.4: Advanced chipset features screen

3.5.1 DRAM Timing Selectable

This item allows you to control the DRAM speed.

3.5.2 CAS Latency Time

This controls the latency between DDR RAM read command and the time that the data actually becomes available. Leave this on the default setting.

3.5.3 Active to Precharge Delay

This item allows you to select the value in this field, depending on whether the board has paged DRAMs or EDO (extended data output) DRAMs. The Choice: EDO 50ns, EDO 60ns, Slow, Medium, Fast, Turbo.

3.5.4 DRAM RAS# to CAS# Delay

In order to improve performance, certain space in memory is reserved for ISA cards. This memory must be mapped into the memory space below 16MB. The Choice: 15M-16M, Disabled.

3.5.5 RAS# Precharge Time

This controls the idle clocks after issuing a precharge command to DRAM. Leave this on the default setting.

3.5.6 System BIOS Cacheable

Selecting Enabled allows caching of the system BIOS ROM at F0000h-FFFFFh, resulting in better system performance. However, if any program writes to this memory area, a system error may occur. The Choices: Enabled, Disabled.

3.5.7 Video Bios Cacheable

Selecting Enabled allows caching of the video BIOS, resulting in better system performance. However, if any program writes to this memory area, a system error may occur. The Choices: Enabled, Disabled.

3.5.8 Memory Hole At 15M-16M

Enabling this feature reserves 15 MB to 16 MB memory address space for ISA expansion cards that specifically require this setting. This makes memory from 15 MB and up unavailable to the system. Expansion cards can only access memory up to 16 MB. The default setting is "Disabled."

3.5.9 Delayed Transaction

The chipset has an embedded 32-bit posted write buffer to support delay transactions cycles. Select Enabled to support compliance with PCI specification version 2.1. The Choice: Enabled, Disabled.

3.5.10 Delay Prior to Thermal

Select Enabled if user wants to lower the CPU speed when CPU temperature is too high. The choice: Enabled, Disabled.

3.5.11 AGP Aperture Size (MB)

Select the size of Accelerated Graphics Port (AGP) aperture. The aperture is a portion of the PCI memory address range dedicated for graphics memory address space. Host cycles that hit the aperture range are forwarded to the AGP without any translation.

3.5.12 On-Chip VGA

User can disable onboard VGA controller by selecting "Disabled"

3.5.13 On-Chip Frame Buffer Size

User can select frame buffer size. Option is 8MB and 1MB.

3.5.14 Boot Display

User can select VGA controller when system is power on. The choice: Auto, PCI, AGP. PCI (external VGA card). AGP (onboard VGA controller).

3.6 Integrated Peripherals

3.6.1 IDE Primary (Secondary) Master/Slave PIO/UDMA Mode,

IDE Primary (Secondary) Master/Slave PIO/UDMA Mode (Auto) Each channel (Primary and Secondary) has both a master and a slave, making four IDE devices possible. Because each IDE device may have a different Mode timing (0, 1, 2, 3, 4), it is necessary for these to be independent. The default setting “Auto” will allow autodetection to ensure optimal performance.

3.6.2 On-Chip Secondary PCI IDE

If you enable IDE HDD Block Mode, the enhanced IDE driver will be enabled. Leave IDE HDD Block Mode on the default setting.

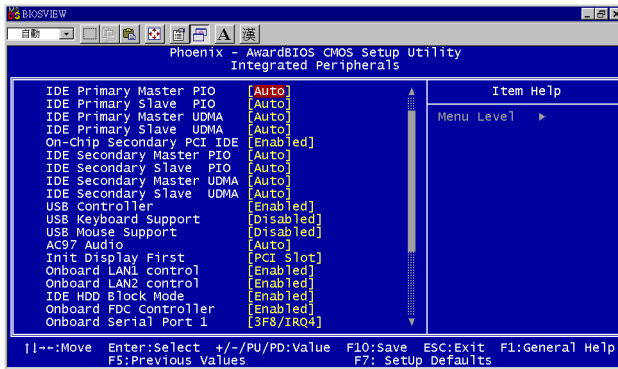

Figure 3.5: Integrated peripherals (1)

3.6.3 USB Controller

Select Enabled if your system contains a Universal Serial Bus (USB) controller and you have USB peripherals. The choices: Enabled, Disabled.

3.6.4 USB Keyboard/Mouse Support

Select Enabled if user plan to use an USB keyboard. The choice: Enabled, Disable.

3.6.5 AC97 Audio

Select Disable if you do not want to use AC-97 audio. Option is Auto, Disable.

3.6.6 Init Display First

This item allows you to choose which one to activate first, PCI Slot or on-chip VGA. The choices: PCI Slot, Onboard.

3.6.7 Onboard LAN1 Control

Option is Enable and Disable. Select Disable if user does not want to use onboard LAN controller1

3.6.8 Onboard LAN2 Control

Option is Enable and Disable. Select Disable if user does not want to use onboard LAN controller2

3.6.9 IDE HDD Block Mode

You can enable the Primary IDE channel and/or the Secondary IDE channel. Any channel not enabled is disabled. This field is for systems with only SCSI drives.

3.6.10 Onboard FDC Controller

When enabled, this field allows you to connect your floppy disk drives to the onboard floppy disk drive connector instead of a separate controller card. If you want to use a different controller card to connect the floppy disk drives, set this field to Disabled.

3.6.11 Onboard Serial Port 1

The settings are 3F8H/IRQ4, 2F8H/IRQ3, 3E8H/IRQ4, 2E8H/ IRQ10, and Disabled for the on-board serial connector.

3.6.12 Onboard Serial Port 2

The settings are 3F8H/IRQ4, 2F8H/IRQ3, 3E8H/IRQ4, 2E8H/ IRQ10, and Disabled for the on-board serial connector.

3.6.13 UART Mode Select

This item allows you to select UART mode. The choices: IrDA, ASKIR, Normal.

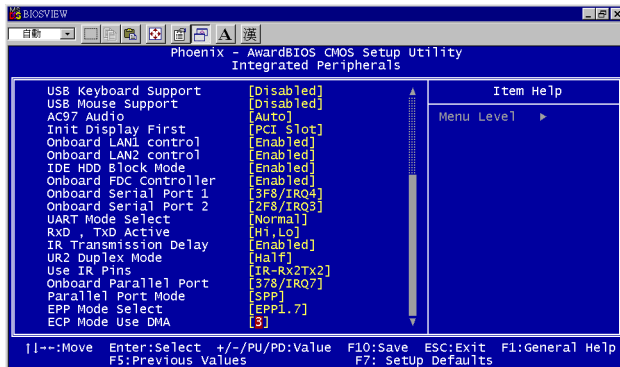

Figure 3.6: Integrated peripherals (2)

3.6.14 RxD, TxD Active

This item allows you to determine the active of RxD, TxD. The Choices: “Hi, Hi,” “Lo, Lo,” “Lo, Hi,” “Hi, Lo.”

3.6.15 IR Transmission Delay

This item allows you to enable/disable IR transmission delay. The choices: Enabled, Disabled.

3.6.16 UR2 Duplex Mode

This item allows you to select the IR half/full duplex function. The choices: Half, Full.

3.6.17 Onboard Parallel Port

This field sets the address of the on-board parallel port connector. You can select either 3BCH/IRQ7, 378H/IRQ7, 278H/IRQ5 or Disabled. If you install an I/O card with a parallel port, make sure there is no conflict in the address assignments. The CPU card can support up to three parallel ports, as long as there are no conflicts for each port.

3.6.18 Parallel Port Mode

This field allows you to set the operation mode of the parallel port. The setting “Normal” allows normal speed operation, but in one direction only. “EPP” allows bidirectional parallel port operation at maximum

speed. “ECP” allows the parallel port to operate in bi-directional mode and at a speed faster than the maximum data transfer rate. “ECP + EPP” allows normal speed operation in a two-way mode.

3.6.19 EPP Mode Select

This field allows you to select EPP port type 1.7 or 1.9. The choices: EPP1.7, 1.9.

3.6.20 ECP Mode Use DMA

This selection is available only if you select “ECP” or “ECP + EPP” in the Parallel Port Mode field. In ECP Mode Use DMA, you can select DMA channel 1, DMA channel 3, or Disable. Leave this field on the default setting.

3.7 Power Management Setup

The power management setup controls the CPU card’s “green” features to save power. The following screen shows the manufacturer’s defaults::

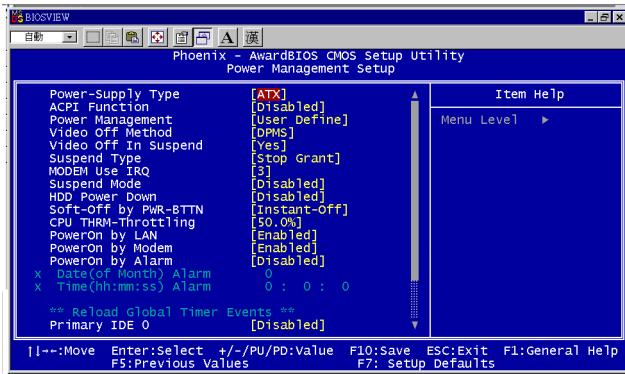

Figure 3.7: Power management setup screen (1)

3.7.1 Power-Supply Type

Choose AT or ATX power supply

3.7.2 ACPI function

The choice: Enabled, Disabled.

3.7.3 Power Management

This category allows you to select the type (or degree) of power saving and is directly related to the following modes:

1. HDD Power Down
2. Suspend Mode

There are four selections for Power Management, three of which have fixed mode settings.

Min. Power Saving	Minimum power management., Suspend Mode = 1 hr., and HDD Power Down = 15 min.
Max. Power Saving	Maximum power management., Suspend Mode = 1 min., and HDD Power Down = 1 min.
User Defined (Default)	Allows you to set each mode individually. When not disabled, each of the ranges are from 1 min. to 1 hr. except for HDD Power Down which ranges from 1 min. to 15 min. and disable.

3.7.4 Video Off In Suspend

When system is in suspend, video will turn off.

3.7.5 Modem Use IRQ

This determines the IRQ in which the MODEM can use. The choices: 3, 4, 5, 7, 9, 10, 11, NA.

3.7.6 HDD Power Down

You can choose to turn the HDD off after one of the time intervals listed, or when the system is in “suspend” mode. If the HDD is in a power saving mode, any access to it will wake it up.

3.7.7 Soft-Off by PWR-BTTN

If you choose “Instant-Off”, then pushing the ATX soft power switch button once will switch the system to “system off” power mode. You can choose “Delay 4 sec.” If you do, then pushing the button for more than 4 seconds will turn off the system, whereas pushing the button momentarily (for less than 4 seconds) will switch the system to “suspend” mode.

3.7.8 CPU THRM-Throttling

This field allows you to select the CPU THRM-Throttling rate. The choices: 12.5%, 25.0%, 37.5%, 50.0%, 62.5%, 75.0%, 87.5%.

3.7.9 PowerOn By LAN

This item allows you to wake up the system via LAN from the remote-host. The choices: Enabled, Disabled.

3.7.10 PowerOn By Modem

When Enabled, an input signal on the serial Ring Indicator (RI) line (in other words, an incoming call on the modem) awakens the system from a soft off state. The choices: Enabled, Disabled.

3.7.11 PowerOn By Alarm

When Enabled, your can set the date and time at which the RTC (real-time clock) alarm awakens the system from Suspend mode. The choices: Enabled, Disabled.

3.7.12 Primary IDE 0 (1) and Secondary IDE 0 (1)

When Enabled, the system will resume from suspend mode if Primary IDE 0 (1) or Secondary IDE 0 (1) is active. The choice: Enabled, Disabled.

3.7.13 FDD, COM, LPT PORT

When Enabled, the system will resume from suspend mode if FDD, COM port, or LPT port is active. The choice: Enabled, Disabled.

3.7.14 PCI PIRQ [A-D]#

When Enabled, the system will resume from suspend mode if interrupt occurs. The choice: Enabled, Disabled.

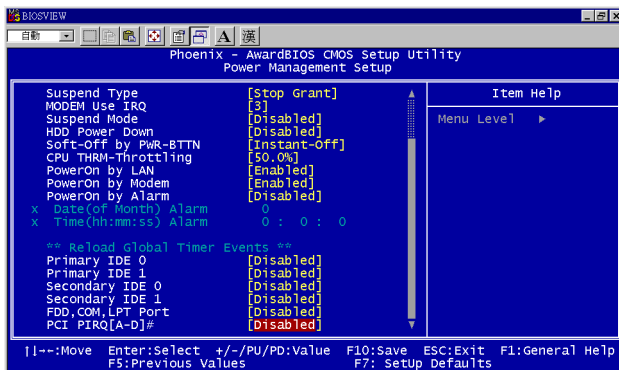

Figure 3.8: Power management setup screen (2)

3.9 PC Health Status

3.9.1 CPU Warning Temperature

This item will prevent the CPU from overheating. The choices: 30~120.

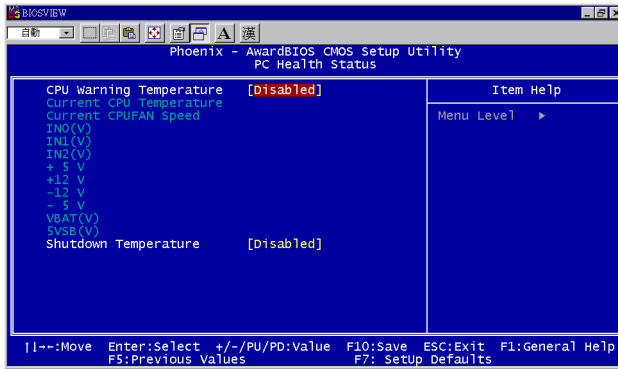

Figure 3.10: PC health status screen

3.9.2 Current CPU Temperature

This shows you the current CPU temperature.

3.9.3 Current CUFAN Speed

This shows you the current CUFAN operating speed.

3.9.4 +5V/+12V/-12V/-5V

This shows you the voltage of +5V/+12V/-12V/-5V

3.10 Password Setting

To change the password:

1. Choose the “Set Password” option from the “Initial Setup Screen” menu and press <Enter>.

The screen will display the following message:



Please Enter Your Password

Press <Enter>.

2. If the CMOS is good or if this option has been used to change the default password, the user is asked for the password stored in the CMOS. The screen will display the following message:



Please Confirm Your Password

Enter the current password and press <Enter>.

3. After pressing <Enter> (ROM password) or the current password (user-defined), you can change the password stored in the CMOS. The password must be no longer than eight (8) characters.

Remember, to enable the password setting feature, you must first select either “Setup” or “System” from the “Advanced BIOS Features” menu.

3.11 Save & Exit Setup

If you select this and press <Enter>, the values entered in the setup utilities will be recorded in the CMOS memory of the chipset. The microprocessor will check this every time you turn your system on and compare this to what it finds as it checks the system. This record is required for the system to operate.

3.12 Exit Without Saving

Selecting this option and pressing <Enter> lets you exit the setup program without recording any new values or changing old ones.

Chipset Software Installation Utility

This utility software installs to the Windows INF files that outline to the operating system how the components will be configured. This utility has to be installed before other drivers.

Chapter 4 Chipset Software Installation Utility

4.1 Before you begin

To facilitate the installation of the enhanced display device drivers and utility software, you should read the instructions in this chapter carefully before you attempt installation. The device drivers for the PCA-6186 board are located on the software installation CD. The auto-run function of the driver CD will guide and link you to the utilities and device drivers under a Windows system. The Intel® Chipset Software Installation Utility is not required on any systems running Windows NT 4.0. Updates are provided via Service Packs from Microsoft*.

Note: The files on the software installation CD are compressed. Do not attempt to install the drivers by copying the files manually. You must use the supplied SETUP program to install the drivers.

Before you begin, it is important to note that most display drivers need to have the relevant software application already installed in the system prior to installing the enhanced display drivers. In addition, many of the installation procedures assume that you are familiar with both the relevant software applications and operating system commands. Review the relevant operating system commands and the pertinent sections of your application software's user's manual before performing the installation.

4.2 Introduction

The Intel® Chipset Software Installation (CSI) utility installs to the target system the Windows INF files that outline to the operating system how the chipset components will be configured. This is needed for the proper functioning of the following features:

- Core PCI and ISA PnP services.
- AGP support.
- IDE Ultra ATA 100/66/33 interface support.
- USB 1.1 support (USB 2.0 driver needs to be installed separately)

- Identification of Intel ® chipset components in the Device Manager.
- Integrates superior video features. These include filtered sealing of 720 pixel DVD content, and MPEG-2 motion compensation for software DVD

Note: This utility is used for the following versions of Windows system, and it has to be installed before installing all the other drivers:

Windows 98SE

Windows 2000

Windows Me

Windows XP

4.3 Installing the CSI Utility

1. Insert the driver CD into your system's CD-ROM drive. In a few seconds, the software installation main menu appears. Move the mouse cursor over the "Auto" button under the "CSI UTILITY" heading, a message pops up telling you to install the CSI utility before other device drivers, as shown in the following figure. Click on this button.



2. Click "Next" when you see the following message.

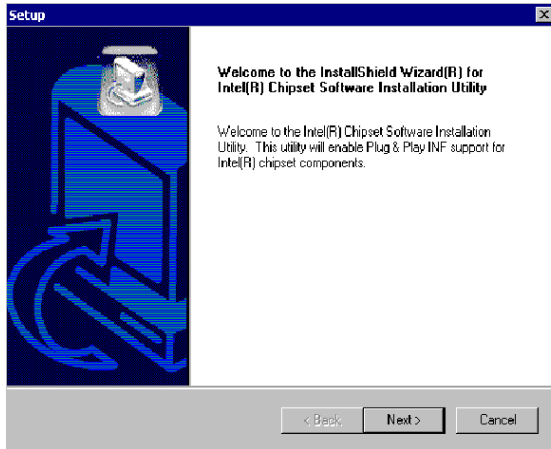

3. Click "Yes" when you see the following message.

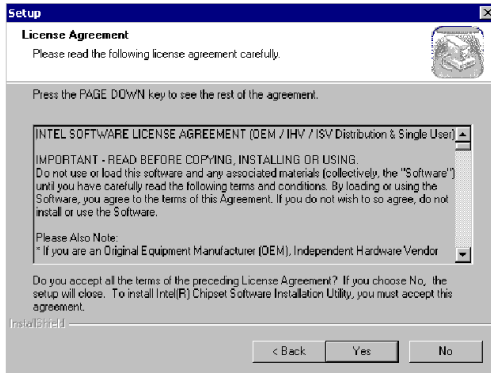

4. Click "Next" when you see the following message.

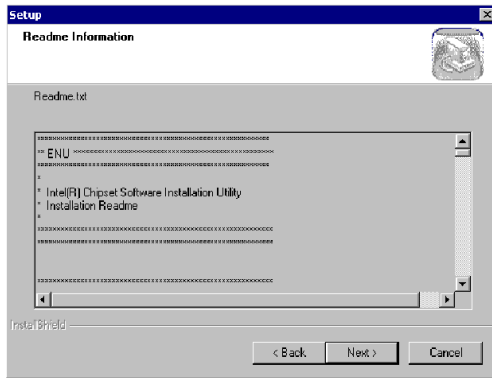

5. When the following message appears, click "Finish" to complete the installation and restart Windows.

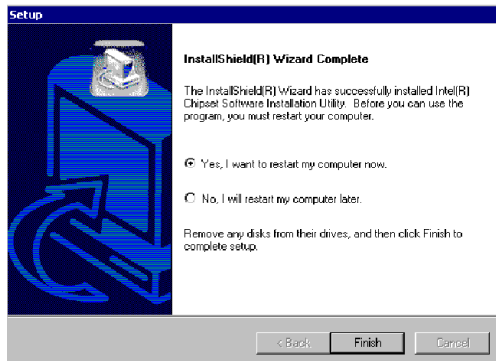

CHAPTER 5

AGP VGA Setup

The PCA-6186 features an integrated AGP VGA interface. This chapter provides instructions for installing the AGP VGA drivers from the driver CD included in your package.

Chapter 5 AGP VGA Setup

5.1 Introduction

As quoted from "Intel® 845G chipset Graphics Chipset Controller Hub (GMCH) Rev. 1.0 May 2002.":

The Intel® 845G Graphics Memory Controller Hub (the 845G GMCH) is Intel's first memory controller hub with integrated graphics for the Intel Pentium® 4 processor. The 845G GMCH, with its new architecture graphics engine, delivers not only high 2D/3D graphics performance, but also provides efficient, high bandwidth communication channels connecting the processor, the memory, the I/O subsystem, and other components together to deliver a stable mainstream desktop platform solution. The features include:

- Built-in 2D/3D AGP VGA controller.
- Integrated 350MHz RAMDAC that can directly drive a progressive scan analog monitor up to a resolution of 2048x1536 at 60MHz
- Up to 1600 x 1200 x 32 resolution at 85 Hz refresh.
- H/W motion compensation assistance for s/w MPEG 2 decoding.
- Software DVD at 30 fps Full Screen.

5.2 Dynamic Video Memory Technology

The following is quoted from "Intel® 845G/845GL Chipset Dynamic Video Memory Technology" Rev. 1.2 June 2002":

Dynamic Video Memory Technology (DVMT) is an enhancement of the UMA concept, wherein the optimum amount of memory is allocated for balanced graphics and system performance, through Direct AGP known as Non-Local Video Memory (NLVM), and a highly efficient memory utilization scheme. DVMT ensures the most efficient use of available memory ñ regardless of frame buffer or main memory sizing ñ for maximum 2D/3D Graphics performance. DVMT dynamically responds to system requirements, and applications demands, by allocating the proper amount of display, texturing and buffer memory after the operating system has booted. For example, a 3D application when launched may require more vertex buffer memory to enhance the complexity of objects, or more texture memory to enhance the richness of the 3D environment. The operating system views the integrated graphics driver as an applica-

tion, which uses Direct AGP to request allocation of additional memory for 3D applications, and returns the memory to the operating system when no longer required.

The Intel Extreme Graphics Driver determines the size of the pre-allocated memory needed and will make additional Non-Local Video Memory requests to achieve the amount needed for the display and application requirement. The video memory size in the Intel(R) 845G/GL chipset varies and is determined using several factors. The key factors are system resources and system activity. The maximum video memory is up to 64MB SDRAM

5.3 Installation

Note: Before installing this driver, make sure the CSI utility has been installed in your system. See Chapter 4 for information on installing the CSI utility

1. Insert the driver CD into your system's CD-ROM drive. In a few seconds, the software installation main menu appears, as shown in the following figure. Under the "VGA DRIVERS" heading, click on one of the buttons (labeled "WIN9X," "WIN2000," and "WINNT40" respectively) according to the operating system you are using. The following installation procedure is for Windows 2000. For other operating systems, please follow the on-screen installation guide



2. You will see a welcome window. Please click on "Next" to continue the installation.

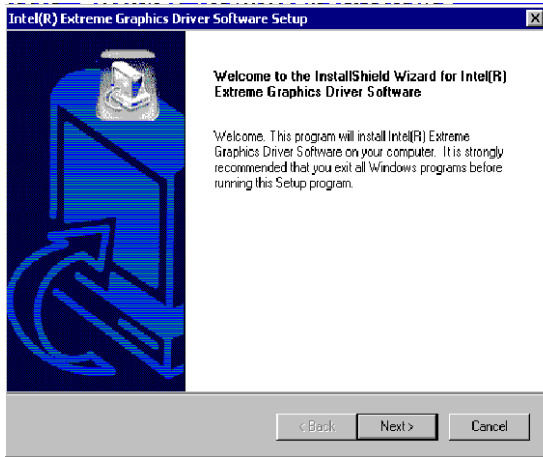

3. Click "Yes" when you see the following message.

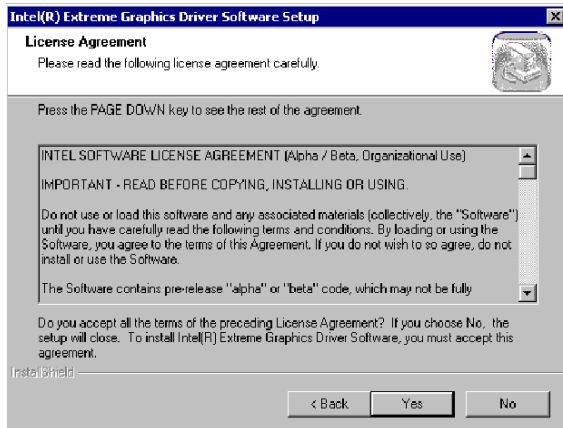

4. Click on "Yes" to continue the installation

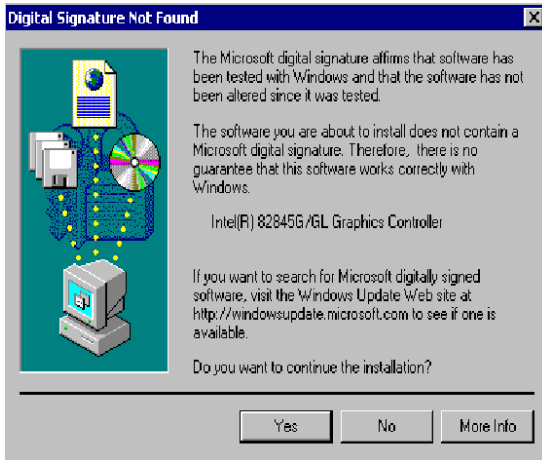

5. VGA driver is now installing



6. When the following message appears, you can choose to restart the computer now or later.

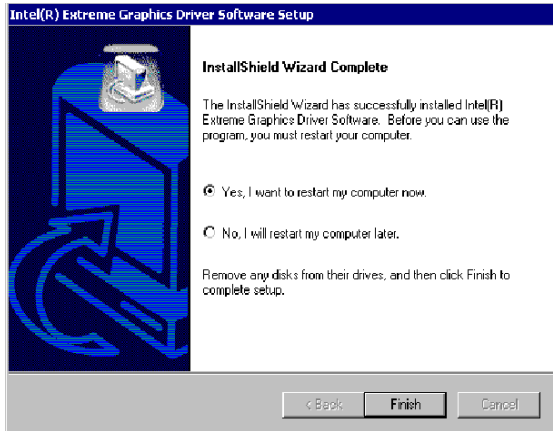

LAN Configuration

The PCA-6186 supports dual 10/100Base-T (or dual 10/100/1000Base-T) Ethernet networking with Intel 82562/82551 Ethernet controller (or 82540 for Gigabit LAN). This chapter gives detailed information on Ethernet configuration. It shows you how to configure the card to match your application requirements. Sections include:

- Introduction
- Features
- Installation
- Windows 2000 Drivers Setup Procedure
- Windows NT Drivers Setup Procedure
- Windows Wake-on-LAN Setup

Chapter 6 LAN Configuration

6.1 Introduction

The PCA-6186 features the 32-bit 10/100/1000 Mbps Ethernet network interface. This interface supports bus mastering architecture and auto-negotiation features. Therefore standard twisted-pair cabling with RJ-45 connectors for 10 Mbps, 100 Mbps and 1000 Mbps connections can be used. Extensive driver support for commonly-used network systems is also provided.

6.2 Features

- Dual Intel 82562/82551 10/100Base-T Ethernet LAN controller
- Optional dual Intel 82540 10/100/1000 Base-T Ethernet LAN controller
- Supports Wake-on-LAN remote control function.
- PCI Bus Master complies with PCI Rev. 2.2
- MAC & PHY (10/100/1000 Mbps) interfaces.
- Complies with 1000Base-T, 100Base-TX, and 10Base-T applications the order is reverse.
- Fully supports 1000Base-T, 100Base-TX, and 10Base-T operation.
- Single RJ-45 connector gives auto-detection of 10 Mbps, 100 Mbps, or 1000 Mbps network data transfer rates and connected cable types.
- Plug and Play.
- Enhancements on ACPI & APM.
- Complies with PCI Bus Power Management Interface Rev. 1.1,
- ACPI Rev. 2.0, and Device Class Power Management Rev. 1.0.

6.3 Installation

Note: Before installing the LAN drivers, make sure the CSI utility has been installed in your system. See Chapter 4 for information on installing the CSI utility.

The PCA-6186's onboard Ethernet interface supports all major network operating systems. However, the installation procedure varies with different operating systems. In the following sections, refer to the one that provides driver setup procedure for the operating system you are using.

6.4 Windows 98/2000 Drivers Setup Procedure (Intel 82540 and 82562/82551)

Note: The CD-ROM drive is designated as "D" throughout this section.

1. From the desktop of Windows 2000, click on "Start" and select "Settings." Then click on the "Control Panel" icon to select "System."

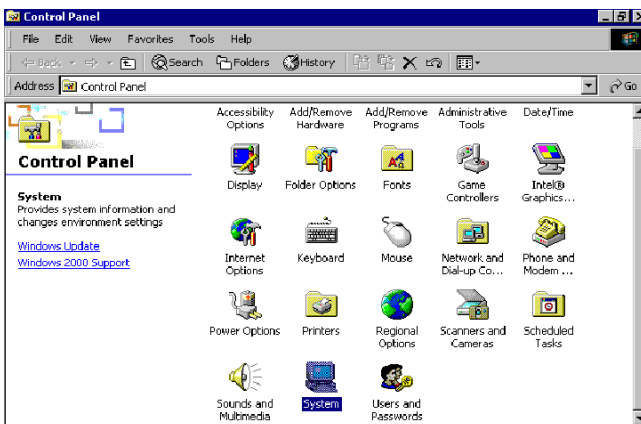

2. In the "PCI Ethernet Controller Properties" window, select the "Driver" tab. Then click on "Update Driver..."



3. In the "Upgrade Device Driver Wizard" window, click on "Next."

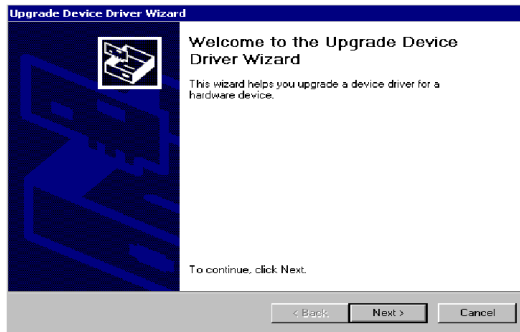

4. In the "Upgrade Device Driver Wizard" window, select "Display a list of known drivers for this device so that I can choose a specific driver." Then click on "Next."

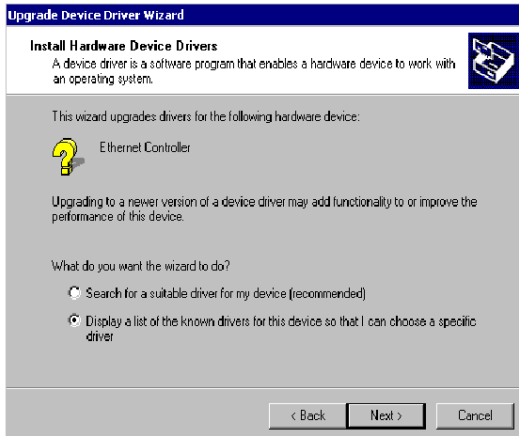

5. In the following "Upgrade Device Driver Wizard" window, click on Network Adapter and then "Next".

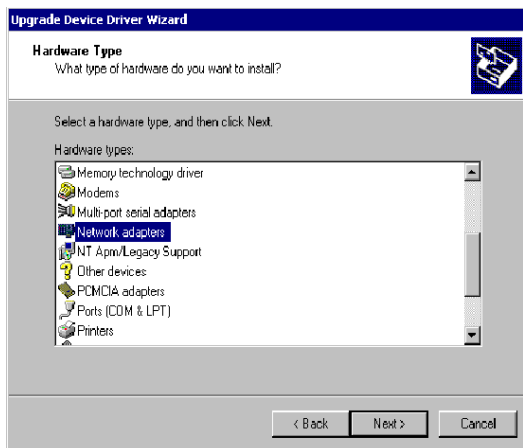

- In the "Upgrade Device Driver Wizer" Window, click on "Have Disk" and then "Next".

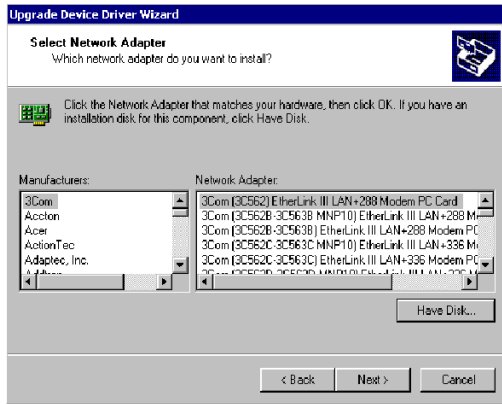

- In the following "Upgrade Device Driver Wizard" window, specify the location at "D:\Drv_Lan\82540" for 10/100/1000Base-T or D:\Drv_Lan\82562 for 10/100Base-T Ethernet LAN.

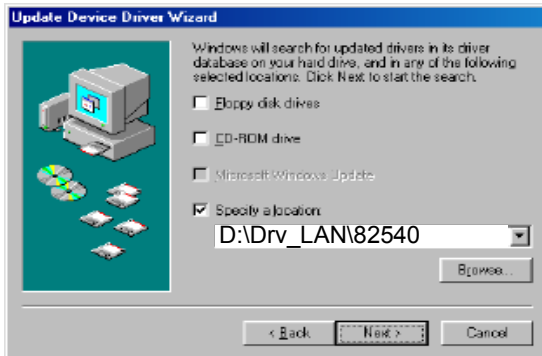

8. In the following "Update Device Driver Wizard" window, choose "Intel 82540OEM Based Network Connection" and click on "Next". If your board is with 10/100Base-T Ethernet controller onboard, please choose "Intel 8255x Based Fast Ethernet Version".

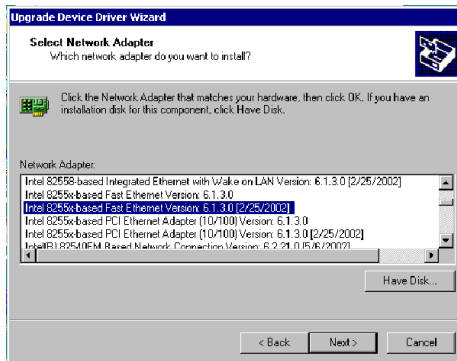
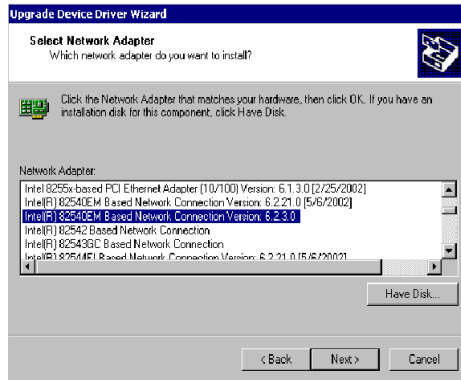

9. In the following "Update Device Driver Wizard" window, click on "Next"

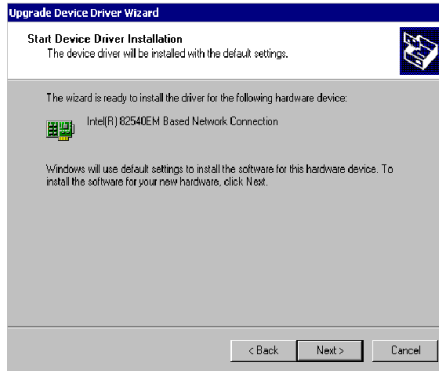

10. Intel 82540 LAN driver is completed installed. Click on "Finish" to complete the installation.



6.5 Windows NT Drivers Setup Procedure (Intel 82540)

Note: The CD-ROM drive is designated as "D" throughout this section.

1. From the desktop of Windows NT, click on "Start" and select "Settings." Then click on the "Control Panel" icon to select "System."



2. In the "Network" window, select the "Adapters" tab. Then click on "Add..."

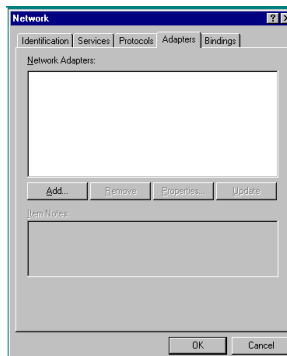

3. In the "Select Network Adapter" window, click on "Have Disk..."

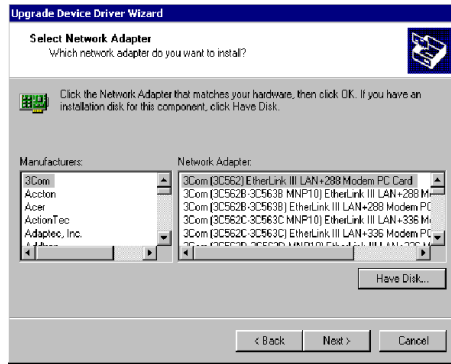

4. When the "Insert Disk" window appears, insert the driver CD into the CD-ROM drive and type in D:\Drv_Lan\82540. When you have the correct file path, click on "OK."

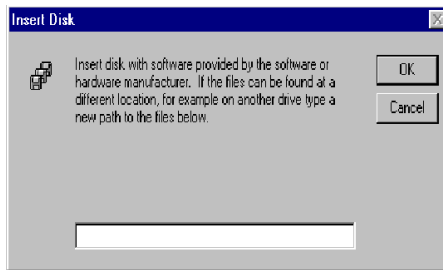

- In the "Select OEM Option" window, select Intel Pro 1000 Family Adapter and click on "OK"

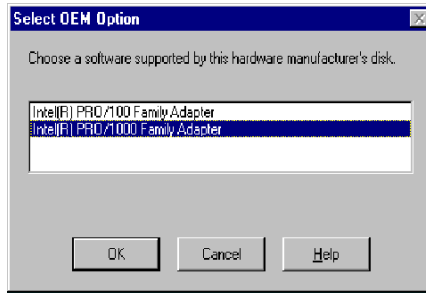

- In the "Network" window, select the "Adapters" tab. Under "Network Adapters," highlight "[1] Intel® PRO/1000MT Network Connection Management Adapter" and "[2] Intel® PRO/1000 MT Network Connection." Then click on "Close."

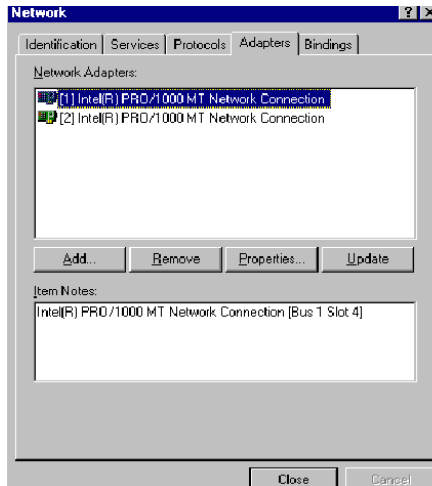

3. In the "Reboot Required" window, click on "Yes."

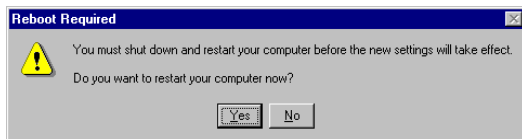

CHAPTER 7

USB 2.0 Configuration

The PCA-6186 supports USB 2.0 device. From this chapter, you will find detail information regarding Windows 2000 USB 2.0 driver setup procedure.

Chapter 7 USB 2.0 Configuration

7.1 Introduction

The PCA-6186 is designed with Intel ICH4 which supports both USB1.1 and USB 2.0 high-speed transmission. It still remains the compatibility with today's USB device. High-speed USB 2.0 provides data transfer up to 480Mb/s which is 40 times faster than USB 1.1. It is ideal for today's speed-demanding I/O peripherals.

7.2 Features

- Provides data transmission rate up to 480Mb/s
- Offer 40 greater bandwidth than USB 1.1
- Offers complete compatibility with current USB device

7.3 Installation

Note: Before installing this driver, make sure the CSI utility has been installed in your system. See Chapter 4 for information on installing the CSI utility.

Note: USB 2.0 driver is not available for Windows 98SE/ME from PCA-6186 driver CD. Under these operating systems, the USB device will operate at USB 1.1 speeds.

1. From Windows 2000, select Start and click on Setting. In the window of Setting, click on icon System.

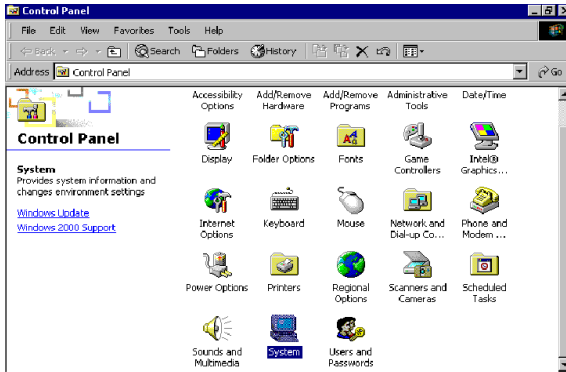

2. Choose the option "Hardware", and then click on "Device Manager"

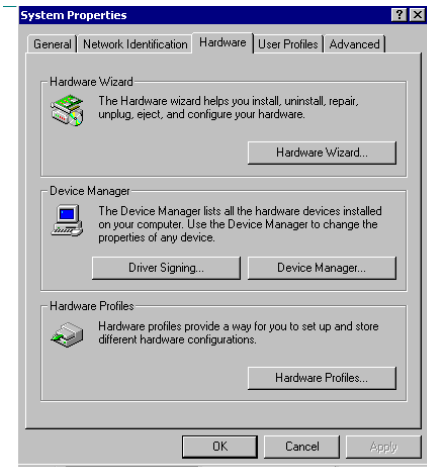

3. In Device Manager, choose "USB Controller" and then double click.

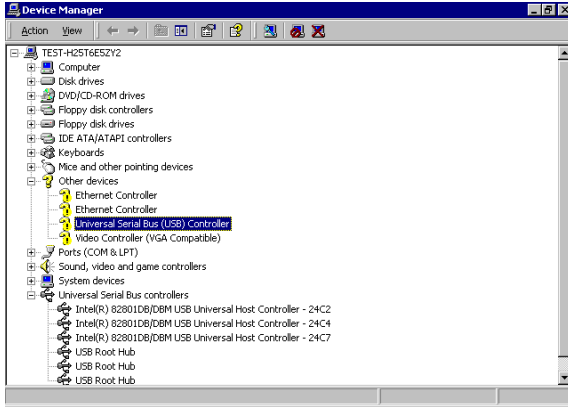

4. Choose the option "Driver" and then click on "Update Driver".



5. In Upgrade Device Driver Wizard, click on "Next".



6. In Upgrade Device Wizard, choose "search for a suitable device for my driver" and then click on " Next".

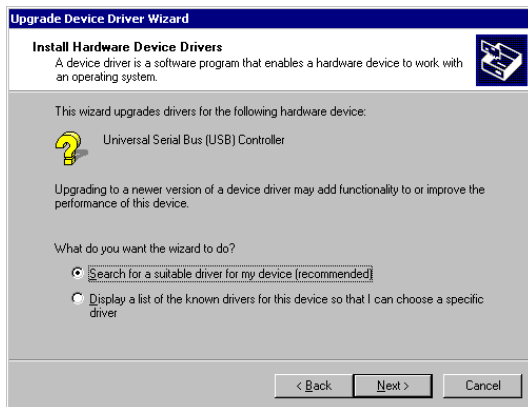

7. Tick "Specify a location" and click "Next"

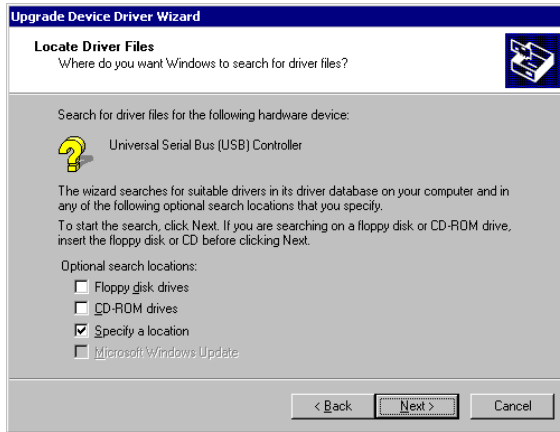

8. In the following windows, please specify the location "D:\Drv_USB\w2k" and then click on "OK".



9. In the following window, please click on "Finish" to complete USB driver installation.



Ultra ATA Storage Driver Setup

This driver must be installed to use the Intel® Ultra ATA controller to improve storage subsystem performance and overall system performance.

Chapter 8 Ultra ATA Storage Driver Setup

8.1 Introduction

This driver takes advantage of the latest Intel ® Ultra ATA controller features to improve both storage subsystem performance and overall system performance. A useful diagnostic tool, Intel Ultra ATA Companion® , shows technical information of the ATA subsystem.

8.2 Features

- The driver enables fast Ultra ATA transfers by default.
- Users no longer have to manually enable DMA transfers for each ATA and/or ATAPI peripheral devices.
- Each ATA channel has independent device timings/transfers which allows PIO-only and DMA-capable devices to share the same ATA controller cable, where one is the master and the other the slave, without restricting transfer mode to PIO-only for both devices.
- Technical details of the ATA subsystem can be viewed via use of the application.
- Drivers are optimized.

8.3 Window 2000 Setup Procedure

Note: Before installing this driver, make sure the CSI utility has been installed in your system. See Chapter 4 for information on installing the CSI utility.

1. Insert the driver CD into your system's CD-ROM drive. In a few seconds, the software installation main menu appears, as shown in the following figure. Under the "IDE DRIVERS" heading, click on the "Install" button.



2. Click on "Next" when you see the following message.

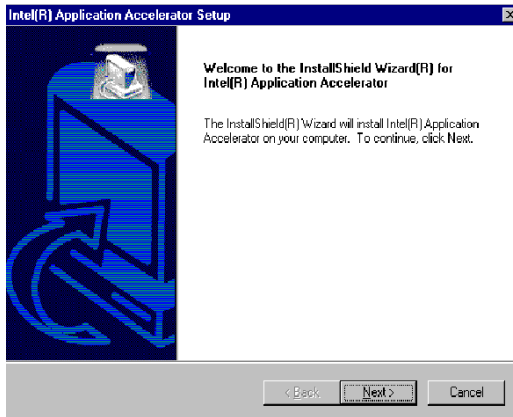

3. When you see the following message, click on "Yes" to accept the License Agreement.

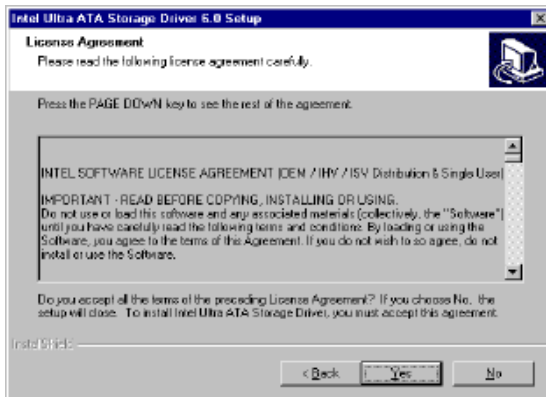

4. Click on "Next" when you see the following message.

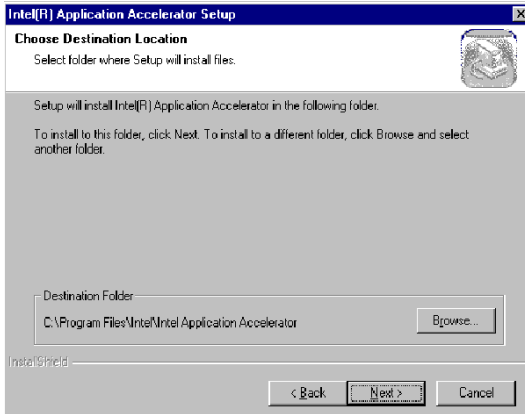

5. When the following message appears, click "Finish" to complete the installation and restart Windows.

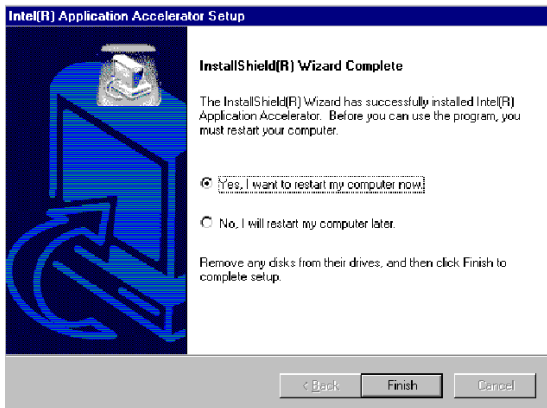

8.5 NT Setup Procedure

1. Insert the driver CD into your system's CD-ROM drive. In a few seconds, the software installation main menu appears, as shown in the following figure. Under the "IDE DRIVERS" heading, click on the "Install" button.



2. Click on "Next" when you see the following message.

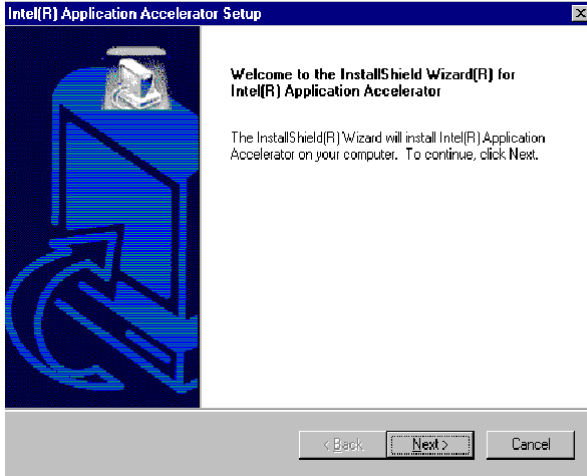

3. When you see the following message, click on "Yes" to accept the License Agreement.

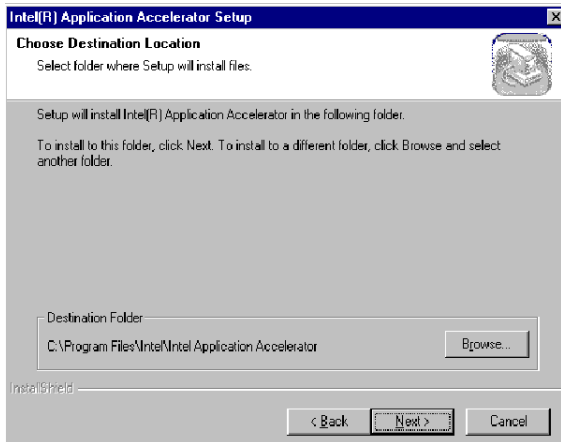

4. When the following message appears, click "Finish" to complete the installation and restart Windows.

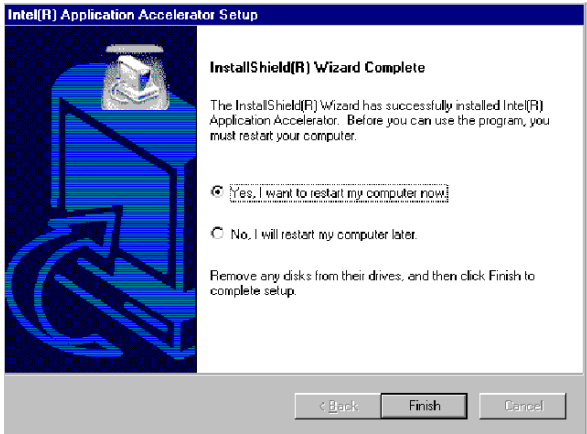

Onboard Security Setup

This chapter explains OBS concepts and provides instructions for installing the relevant software drivers. This is done using the driver CD included in your PCA-6186 package.

Chapter 9 Onboard Security Setup

9.1 Introduction

The PCA-6186's hardware monitor is designed with Winbond W83782D. Onboard security (OBS) functions monitor key hardware. They help you maintain your system's stability and durability. The PCA-6186 can monitor 5 sets of system positive voltages, 2 sets of system negative voltages, CPU cooling fan speed, and CPU temperature. The positive system voltage sets which can be monitored include:

- CPU core voltage: 1.3 V ~ 3.3 V, according to Intel specifications.
- Transmission voltage from CPU to chipset: typically 1.8 V.
- Chipset voltage: typically 3.3 V.
- Main voltage: +5 V, +12 V.

The negative system voltage sets which can be monitored include:

- Main voltage: -5 V, -12 V.

9.2 Windows 9X Drivers Setup Procedure

1. Insert the driver CD into your system's CD-ROM drive. In a few seconds, the software installation main menu appears, as shown in the following figure. Click on the "WIN 9X" button under the "OBS DRIVERS" heading.



2. When you will see the following message, make sure you have closed all other programs, then click on "OK."



3. Click on the square graphics button when you see the following message.

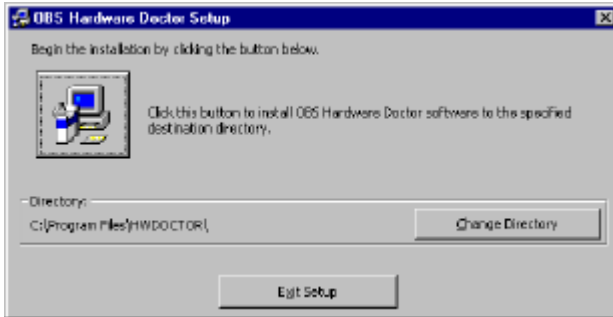

4. When you see the following message, click on "OK" to complete the installation.



9.3 Windows 2000/NT Drivers Setup Procedure

1. Insert the driver CD into your system's CD-ROM drive. In a few seconds, the software installation main menu appears, as shown in the following figure. Click on the "WIN NT" button under the "OBS DRIVERS" heading.



2. Click "Next" when you see the following message.

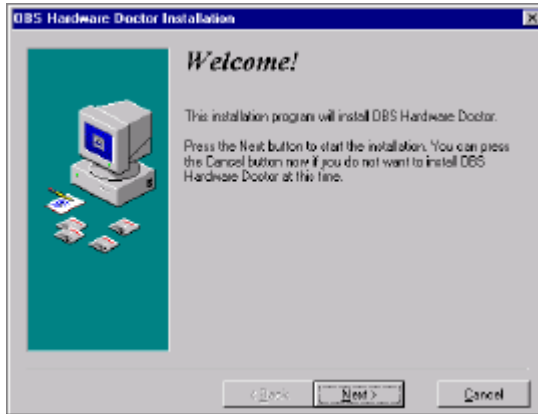

3. Click "Next" when you see the following message.

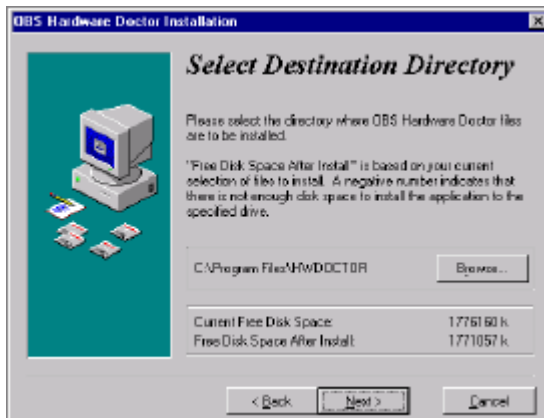

- Click "Next" when you see the following message.

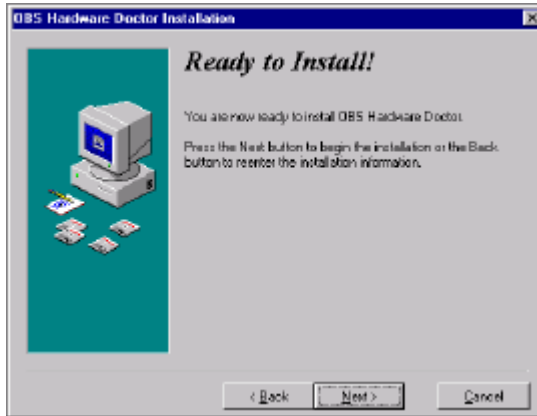

- Click "Finish" when you see the following message.

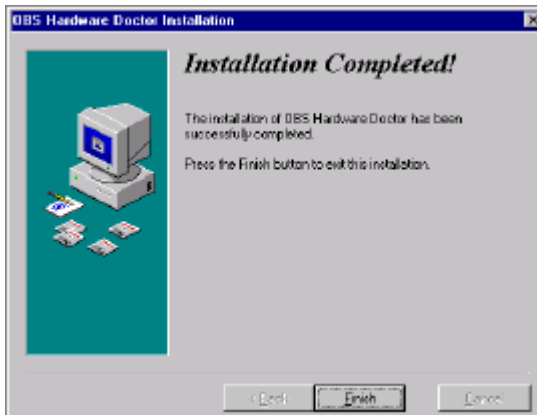

6. Click "OK" to restart Windows.

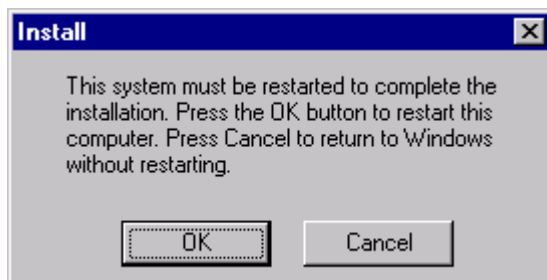

9.4 Using the OBS Hardware Doctor Utility

After completing the setup, all the OBS functions are permanently enabled. When a monitored reading exceeds safe limits, a warning message will be displayed and an error beep tone will activate to attract your attention.

OBS Hardware Doctor will show an icon on the right side of the bottom window bar. This icon is the "Terminate and Stay Resident" (TSR) icon. It will permanently remain in the bottom window bar, and will activate warning signals when triggered by the onboard security system.

You can view or change values for various OBS settings by running this utility:

1. From the desktop of Windows, click on "Start" and select "Programs" and then "OBS Hardware Doctor."

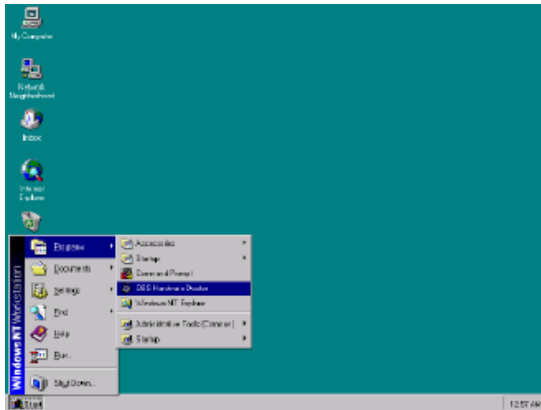

2. It is recommended that you load the default values for all the OBS settings. However, if desired, you can establish new conditions for voltage, fan speed, and temperature. For TRANS_VCC, low limit and high limit have to be adjusted manually. Please set low limit at 1.70V and high limit at 1.90V.

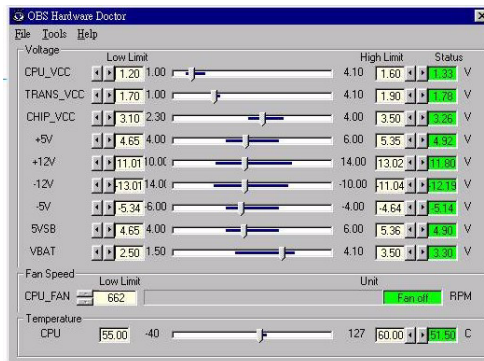

Programming the Watchdog Timer

The PCA-6186 is equipped with a watchdog timer that resets the CPU or generates an interrupt if processing comes to a standstill for any reason. This feature ensures system reliability in industrial standalone or unmanned environments.

Appendix A Programming the watchdog timer

A.1 Programming the Watchdog Timer

The PCA-6186's watchdog timer can be used to monitor system software operation and take corrective action if the software fails to function after the programmed period. This section describes the operation of the watchdog timer and how to program it.

A.1.1 Watchdog timer overview

The watchdog timer is built-in the super I/O controller W83627HF. It provides the following functions for user programming:

- Can be enabled and disabled by user's program.
- Timer can be set from 1 to 255 seconds or 1 to 255 minutes.
- Generates an interrupt or resets signal if the software fails to reset the timer after time-out.

A.1.2 Reset/ Interrupt selection

The J2 jumper is used to select reset or interrupt (IRQ 11) in the event the watchdog timer is tripped. See Chapter 1 for detailed jumper settings.

Note: The interrupt output of the watchdog timer is a low level signal. It will be held low until the watchdog timer is reset.

A.1.3 Programming the Watchdog Timer

The I/O port address of the watchdog timer is 2E(hex) and 2F(hex).

2E (hex) is the address port. 2F(hex) is the data port.

You must first assign the address of register by writing address value into address port 2E(hex), then write/read data to/from the assigned register through data port 2F (hex).

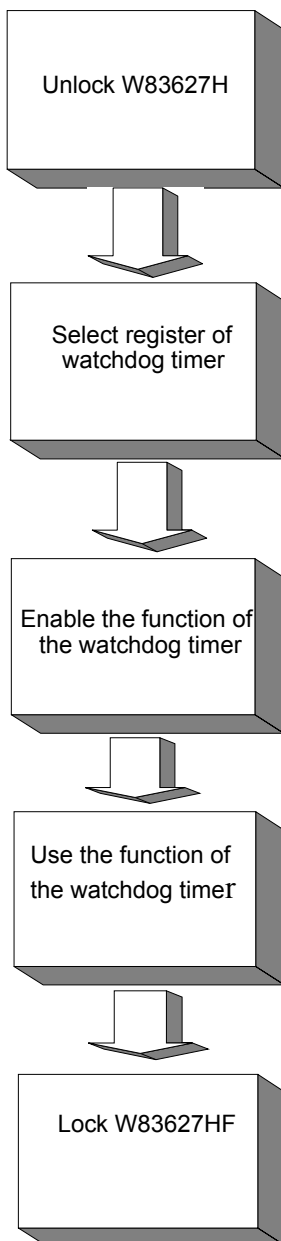

Watchdog Timer Registers		
Address of register (2E)	Attribute	
Read/Write	Value (2F) and description	
87 (hex)	----	Write this address to I/O address port 2E (hex) twice to unlock the W83627HF
07 (hex)	write	Write 08 (hex) to select register of watchdog timer.
30 (hex)	write	Write 01 (hex) to enable the function of the watchdog timer. Disabled is set as default.
F5 (hex)	write	Set seconds or minutes as units for the timer.
Write 0 to bit 3: set second as counting unit. [default]		
Write 1 to bit 3: set minute as counting unit		
F6 (hex)	write	0: stop timer [default] 01~FF (hex): The amount of the count, in seconds or minutes, depends on the value set in register F5 (hex). This number decides how long the watchdog timer waits for strobe before generating an interrupt or reset signal. Writing a new value to this register can reset the timer to count with the new value.

F7 (hex)	read/write	Bit 6: Write 1 to enable keyboard to reset the timer, 0 to disable.[default] Bit 5: Write 1 to generate a timeout signal immediately and automatically return to 0. [default=0] Bit 4: Read status of watchdog timer, 1 means timer is "time out" .
AA (hex)	----	Write this address to I/O port 2E (hex) to lock the watchdog timer.2

Table A.1: Watchdog timer registers

A.1.4 Example Program

1. Enable watchdog timer and set 10 sec. as timeout interval

```

;-----
Mov dx,2eh                ; Unlock W83627HF
Mov al,87h
Out dx,al
Out dx,al
;-----
Mov al,07h                ; Select registers of watchdog timer
Out dx,al
Inc dx
Mov al,08h
Out dx,al
;-----
Dec dx                    ; Enable the function of watchdog timer
Mov al,30h
Out dx,al
Inc dx
Mov al,01h
Out dx,al

```

Dec dx ; Set second as counting unit

Mov al,0f5h

Out dx,al

Inc dx

In al,dx

And al,not 08h

Out dx,al

Dec dx ; Set timeout interval as 10 seconds and start counting

Mov al,0f6h

Out dx,al

Inc dx

Mov al,10

Out dx,al

Dec dx ; lock W83627HF

Mov al,0aah

Out dx,al

2. Enable watchdog timer and set 5 minutes as timeout interval

Mov dx,2eh ; unlock W83627H

Mov al,87h

Out dx,al

Out dx,al

Mov al,07h ; Select registers of watchdog timer

Out dx,al

Inc dx

Mov al,08h

Out dx,al

```

;-----
Dec dx          ; Enable the function of watchdog timer
Mov al,30h
Out dx,al
Inc dx
Mov al,01h
Out dx,al
;-----
Dec dx          ; Set minute as counting unit
Mov al,0f5h
Out dx,al
Inc dx
In al,dx
Or al,08h
Out dx,al
;-----
Dec dx          ; Set timeout interval as 5 minutes and start counting
Mov al,0f6h
Out dx,al
Inc dx
Mov al,5
Out dx,al
;-----
Dec dx          ; lock W83627HF
Mov al,0aah
Out dx,al
3. Enable watchdog timer to be reset by mouse
;-----
Mov dx,2eh     ; unlock W83627H
Mov al,87h
Out dx,al

```

```

Out dx,al
;-----
Mov al,07h      ; Select registers of watchdog timer
Out dx,al
Inc dx
Mov al,08h
Out dx,al
;-----
Dec dx          ; Enable the function of watchdog timer
Mov al,30h
Out dx,al
Inc dx
Mov al,01h
Out dx,al
;-----
Dec dx          ; Enable watchdog timer to be reset by mouse
Mov al,0f7h
Out dx,al
Inc dx
In al,dx
Or al,80h
Out dx,al
;-----
Dec dx          ; lock W83627HF
Mov al,0aah
Out dx,al
4. Enable watchdog timer to be reset by keyboard
;-----
Mov dx,2eh     ; unlock W83627H
Mov al,87h
Out dx,al

```

```

Out dx,al
;-----
Mov al,07h      ; Select registers of watchdog timer
Out dx,al
Inc dx
Mov al,08h
Out dx,al
;-----
Dec dx          ; Enable the function of watchdog timer
Mov al,30h
Out dx,al
Inc dx
Mov al,01h
Out dx,al
;-----
Dec dx          ; Enable watchdog timer to be strobed reset by keyboard
Mov al,0f7h
Out dx,al
Inc dx
In al,dx
Or al,40h
Out dx,al
;-----
Dec dx          ; lock W83627HF
Mov al,0aah
Out dx,al
5.   Generate a time-out signal without timer counting
;-----
Mov dx,2eh      ; unlock W83627H
Mov al,87h
Out dx,al

```

```

Out dx,al
;-----
Mov al,07h      ; Select registers of watchdog timer
Out dx,al
Inc dx
Mov al,08h
Out dx,al
;-----
Dec dx          ; Enable the function of watchdog timer
Mov al,30h
Out dx,al
Inc dx
Mov al,01h
Out dx,al
;-----
Dec dx          ; Generate a time-out signal
Mov al,0f7h
Out dx,al      ; Write 1 to bit 5 of F7 register
Inc dx
In al,dx
Or al,20h
Out dx,al
;-----
Dec dx          ; lock W83627HF
Mov al,0aah
Out dx,al

```

I/O Pin Assignments

This appendix contains information of a detailed or specialized nature. It includes:

- IDE Hard Drive Connector
- Floppy Drive Connector
- Parallel Port Connector
- USB Connector
- VGA Connector
- Ethernet 10/100/1000Base-T RJ-45 Connector
- Keyboard and Mouse Connector
- External Keyboard Connector
- IR Connector
- CPU Fan Power Connector
- Power LED Connector and Keyboard Lock
- External Speaker Connector
- Reset Connector
- HDD LED Connector
- ATX Feature Connector
- ATX Soft Power Switch
- H/W Monitor Alarm
- SM Bus Connector
- Extension I/O Board Connector
- PS/2 Mouse Connector
- AC-97 Audio Interface
- System I/O Ports
- DMA Channel Assignments
- Interrupt Assignments
- 1st MB Memory Map

Appendix B Pin Assignments

B.1 IDE Hard Drive Connector (CN1, CN2)

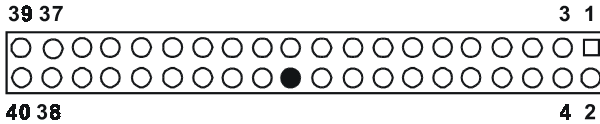

Table B.1: IDE hard drive connector (CN1, CN2)

Pin	Signal	Pin	Signal
1	IDE RESET*	2	GND
3	DATA 7	4	DATA 8
5	DATA 6	6	DATA 9
7	DATA 5	8	DATA 10
9	DATA 4	10	DATA 11
11	DATA 3	12	DATA 12
13	DATA 2	14	DATA 13
15	DATA 1	16	DATA 14
17	DATA 0	18	DATA 15
19	SIGNAL GND	20	N/C
21	DISK DMA REQUEST	22	GND
23	IO WRITE	24	GND
25	IO READ	26	GND
27	IO CHANNEL READY	28	GND
29	HDACKO*	30	GND
31	IRQ14	32	N/C
33	ADDR 1	34	N/C
35	ADDR 0	36	ADDR 2
37	HARD DISK SELECT 0*	38	HARD DISK SELECT 1*
39	IDE ACTIVE*	40	GND

* low active

B.2 Floppy Drive Connector (CN3)

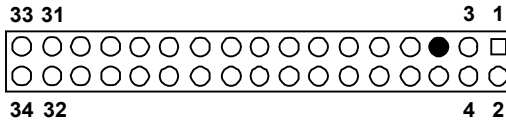

Table B.2: Floppy drive connector (CN3)

Pin	Signal	Pin	Signal
1	GND	2	FDHDIN*
3	GND	4	N/C
5	N/C	6	FDEDIN*
7	GND	8	INDEX*
9	GND	10	MOTOR 0*
11	GND	12	DRIVE SELECT 1*
13	GND	14	DRIVE SELECT 0*
15	GND	16	MOTOR 1*
17	GND	18	DIRECTION*
19	GND	20	STEP*
21	GND	22	WRITE DATA*
23	GND2	4	WRITE GATE*
25	GND	26	TRACK 0*
27	GND	28	WRITE PROTECT*
29	GND	30	READ DATA*
31	GND	32	HEAD SELECT*
33	GND	34	DISK CHANGE*

* low active

B.3 Parallel Port Connector (CN4)

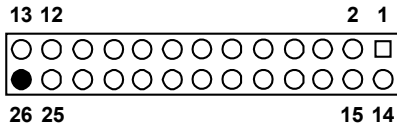

Table B.3: Parallel port connector (CN4)

Pin	Signal	Pin	Signal
1	STROBE*	14	AUTOFD*
2	D0	15	ERR
3	D1	16	INIT*
4	D2	17	SLCTINI*
5	D3	18	GND
6	D4	19	GND
7	D5	20	GND
8	D6	21	GND
9	D7	22	GND
10	ACK*	23	GND
11	BUSY	24	GND
12	PE	25	GND
13	SLCT	26	N/C

* low active

B.4 USB Connector (CN6)

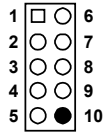

Table B.4: USB1/USB2 connector (CN6)

Pin	USB1 Signal	Pin	USB2 Signal
1	+5 V	6	+5 V
2	UV-	7	UV-
3	UV+	8	UV+
4	GND	9	GND
5	Chassis GND	10	N/C

B.5 VGA Connector (CN7)

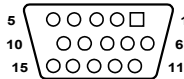
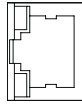

Table B.5: Table B-6: VGA connector (CN7)

Pin	Signal	Pin	Signal
1	RED	9	VCC
2	GREEN	10	GND
3	BLUE	11	N/C
4	N/C	12	SDT
5	GND	13	H-SYNC
6	GND	14	V-SYNC
7	GND	15	SCK

B.6 Ethernet 10/100Base-T RJ-45 Connector (CN8, CN34)



CN8 and CN34

Table B.6: Ethernet 10/100Base-T RJ-45 connector (CN8, CN34)

Pin	Signal	Pin	Signal
1	XMT+	5	N/C
2	XMT-	6	RCV-
3	RCV+	7	N/C
4	N/C	8	N/C

B.7 COM1/COM2 RS-232 Serial Port (CN9, CN10)

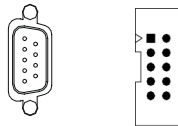

Table B.7: COM1/COM2 RS-232 serial port (CN9, CN10)

Pin	Signal
1	DCD
2	RXD
3	TXD
4	DTR
5	GND
6	DSR
7	RTS
8	CTS
9	RI

B.8 Keyboard and Mouse Connector (CN11)

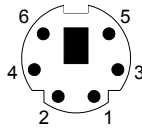

Table B.8: Keyboard and mouse connector (CN11)

Pin	Signal
1	KB DATA
2	MS DATA
3	GND
4	VCC
5	KB CLOCK
6	MS CLOCK

B.9 External Keyboard Connector (CN12)

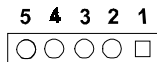

Table B.9: External keyboard connector (CN12)

Pin	Signal
1	CLK
2	DATA
3	NC
4	GND
5	VCC

B.10 IR Connector (CN13).

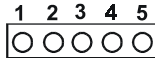

Table B.10: IR connector (CN13)

Pin	Signal	Pin	Signal
1	+5 V	2	N/C
3	IR_RX	4	GND
5	IR_TX		

B.11 CPU Fan Power Connector (CN14)



Table B.11: CPU fan power connector (CN14)

Pin	Signal
1	GND
2	+12 V
3	Detect

B.12 Power LED and Keyboard Lock (CN16)

You can use an LED to indicate when the CPU card is on. Pin 1 of CN16 supplies the LED's power, and Pin 3 is the ground.

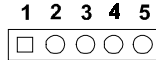

Table B.12: Power LED and keylock connector (CN16)

Pin	Function
1	LED power (+5 V)
2	NC
3	GND
4	Keyboard Lock
5	GND

B.13 External Speaker Connector (CN17)

The CPU card has its own buzzer. You can also connect it to the external speaker on your computer chassis.

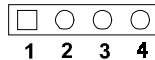

Table B.13: External speaker (CN17)

Pin	Function
1	+5 VCC
2	GND
3	Internal buzzer
4	Speaker out

B.14 Reset Connector (CN18)



Table B.14: Reset connector (CN18)

Pin	Signal
1	RESET
2	GND

B.15 HDD LED Connector (CN19)



Table B.15: HDD LED connector (CN19)

Pin	Signal
1	Vcc(LED+)
2	LED0 (LED-)

B.16 ATX Feature Connector (CN20)



Table B.16: ATX feature connector (CN20)

Pin	Signal
1	PS-ON
2	VCC
3	VCCSB

B.17 ATX Soft Power Switch (CN21)



Table B.17: ATX soft power switch (CN21)

Pin	Signal
1	5VSB
2	PWR-BTN

B.18 H/W Monitor Alarm (CN22)

Table B.18: H/W monitor alarm (CN22)

Pin	Signal
1	Enable OBS alarm
2	Disable OBS alarm

B.19 Extension I/O Board Connector (CN27)

Table B.19: Extension I/O board connector (CN27)

Pin	Signal	Pin	Signal
1	D+ (USB3)	11	D- (USB1)
2	D+ (USB2)	12	D- (USB0)
3	D- (USB3)	13	Vcc (USB1)
4	D- (USB2)	14	Vcc (USB0)
5	Vcc (USB3)	15	GND (USB1)
6	Vcc (USB2)	16	GND (USB0)
7	GND (USB3)	17	5VSB
8	GND (USB2)	18	ACT LED (LAN2)
9	D+ (USB1)	19	LINK (LAN 2)
10	D+ (USB0)	20	SPEED-100Mbps(LAN 2)

B.20 Extension I/O Board Connector (CN28)

Table B.20: Extension I/O board connector (CN28)

Pin	Signal	Pin	Signal
1	TXC+ (DVI)	11	TX0+ (DVI)
2	TXC- (DVI)	12	TX0- (DVI)
3	FP_SDAT (DVI)	13	TXD+ (LAN2)
4	FP_SCLK (DVI)	14	GND
5	H_DEC (DVI)	15	RXIN+ (LAN2)
6	FP_VCC (DVI)	16	TXD- (LAN2)
7	TX2+ (DVI)	17	MS DATA (PS/2 MS)
8	TX2- (DVI)	18	RXIN- (LAN2)
9	TX1+ (DVI)	19	MS CLOCK (PS/2 MS)
10	TX1- (DVI)	20	MS_VCC (PS/2 MS)

B.21 SM Bus Connector (CN29)



B.22 SM Bus Connector (CN 29)

Pin	Signal
1	SMB_DATA
2	SMB_CLK

B.23 PS/2 Mouse Connector (CN33)

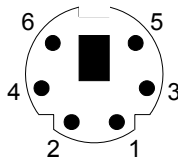

Table B.21: PS/2 mouse connector (CN33)

Pin	Signal
1	MS DATA
2	N/C
3	GND
4	VCC
5	MS CLOCK
6	N/C

B.24 AC-97 Audio Interface (CN43)

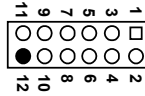

Table B.22: System I/O ports

1 VCC	2 GND
3 SYNC	4 BITCLK
5 SDOUT	6 SDIN
7 SDIN2	8 -ACRST
9 +12V	10 GND

B.25 System I/O Ports

Table B.23: System I/O ports

Addr. range (Hex) Device

000-01F	DMA controller
020-021	Interrupt controller 1, master
022-023	Chipset address
040-05F	8254 timer
060-06F	8042 (keyboard controller)
070-07F	Real-time clock, non-maskable interrupt (NMI) mask
080-09F	DMA page register
0A0-0BF	Interrupt controller 2
0C0-0DF	DMA controller
0F0	Clear math co-processor
0F1	Reset math co-processor
0F8-0FF	Math co-processor
1F0-1F8	Fixed disk
200-207	Game I/O
278-27F	Parallel printer port 2 (LPT3)
290-297	On-board hardware monitor
2F8-2FF	Serial port 2
300-31F	Prototype card
360-36F	Reserved

378-37F	Parallel printer port 1 (LPT2)
380-38F	SDLC, bisynchronous 2
3A0-3AF	Bisynchronous 1
3B0-3BF	Monochrome display and printer adapter (LPT1)
3C0-3CF	Reserved
3D0-3DF	Color/graphics monitor adapter
3F0-3F7	Diskette controller
3F8-3FF	Serial port 1

B.26 DMA Channel Assignments

Table B.24: DMA channel assignments

Channel	Function
0	Available
1	Available
2	Floppy disk (8-bit transfer)
3	Available
4	Cascade for DMA controller 1
5	Available
6	Available
7	Available

B.27 Interrupt Assignments

Table B.25: Interrupt assignments

Priority	Interrupt#	Interrupt source
1	NMI	Parity error detected
2	IRQ0	Interval timer
3	IRQ1	Keyboard
-	IRQ2	Interrupt from controller 2 (cascade)
4	IRQ8	Real-time clock
5	IRQ9	Cascaded to INT 0A (IRQ 2)
6	IRQ10	Available
7	IRQ11	Available
8	IRQ12	PS/2 mouse
9	IRQ13	INT from co-processor
10	IRQ14	Fixed disk controller
11	IRQ15	Available

12	IRQ3	Serial communication port 2
13	IRQ4	Serial communication port 1
14	IRQ5	Parallel port 2
15	IRQ6	Diskette controller (FDC)
16	IRQ7	Parallel port 1 (print port)

B.28 1st MB Memory Map

Table B.26: 1st MB memory map

Addr. range (Hex)	Device
F0000h - FFFFFh	System ROM
C8000h - EFFFFh	Unused
C0000h - C7FFFh	VGA BIOS
B8000h - BFFFFh	CGA/EGA/VGA text
B0000h - B7FFFh	Unused
A0000h - AFFFFh	EGA/VGA graphics
00000h - 9FFFFh	Base memory

B.29 PCI Bus Map

Table B.27: PCI bus map

Function	Signals:		
	Device ID	INT# pin	GNT# pin
Onboard LAN1	AD24	INT E	
Onboard LAN2	AD21	INT H	GNT A
Bridge	AD22		GNT F
PCI slot 1	AD31	INT B, C, D, A	GNT A
PCI slot 2	AD30	INT C, D, A, B	GNT B
PCI slot 3	AD29	INT D, A, B, C	GNT C
PCI slot 4	AD28	INT A, B, C, D	GNT D

Free Manuals Download Website

<http://myh66.com>

<http://usermanuals.us>

<http://www.somanuals.com>

<http://www.4manuals.cc>

<http://www.manual-lib.com>

<http://www.404manual.com>

<http://www.luxmanual.com>

<http://aubethermostatmanual.com>

Golf course search by state

<http://golfingnear.com>

Email search by domain

<http://emailbydomain.com>

Auto manuals search

<http://auto.somanuals.com>

TV manuals search

<http://tv.somanuals.com>