

LAVAMAT LN 79680A3
LAVAMAT LN 79689A3

User manual

Washing Machine

Thank you for choosing one of our high-quality products.

To ensure optimal and regular performance of your appliance please read this instruction manual carefully. It will enable you to navigate all processes perfectly and most efficiently. To refer to this manual any time you need to, we recommend you to keep it in a safe place. And please pass it to any future owner of the appliance.

We wish you much joy with your new appliance.

CONTENTS

OPERATING INSTRUCTIONS	3	Interrupting a programme	13
SAFETY INFORMATION	3	Cancelling a programme	13
General safety	3	Opening the door after the programme has started	14
Installation	4	At the end of the programme	14
Use	4	WASHING PROGRAMMES	15
Child Safety	4	HELPFUL HINTS AND TIPS	19
PRODUCT DESCRIPTION	5	Sorting out the laundry	19
Detergent dispenser drawer	6	Before loading the laundry	19
CONTROL PANEL	6	Removing stains	19
Symbols:	7	Detergents and additives	20
FIRST USE	8	Quantity of detergent to be used	20
PERSONALIZATION	8	Degrees of water hardness	21
Acoustic signals	8	CARE AND CLEANING	21
Child safety lock	8	Descaling	21
DAILY USE	9	After each wash	21
Load the laundry	9	Maintenance wash	21
Measure out the detergent and the fabric softener	9	External cleaning	21
Turn the programme dial (1) to set the required programme	10	Detergent dispenser drawer	21
Select the desired TEMPERATURE (Button 2)	10	Washing drum	22
Select the spin speed, NIGHT CYCLE or RINSE HOLD option (button 3)	11	Door seal	22
Programme option buttons	11	Drain pump	22
PREWASH option	11	Cleaning the water inlet filters	24
STAIN option	12	Frost precautions	25
SENSITIVE option	12	Emergency emptying out	25
EXTRA RINSE option (additional rinse)	12	WHAT TO DO IF...	26
Select the TIME SAVING option (button 6)	12	TECHNICAL DATA	29
Select the START/PAUSE (button 7)	12	CONSUMPTION VALUES	30
Select the DELAY START (button 8)	13	INSTALLATION INSTRUCTIONS	30
Altering an option or a running programme	13	INSTALLATION	30
		Unpacking	30
		Positioning and levelling	33
		Rubber feet kit (4055126249)	33
		Water inlet	33
		Water-stop device	34

Water drainage	34	Packaging materials	36
ELECTRICAL CONNECTION	35	Ecological hints	36
ENVIRONMENT CONCERNS	36		

Subject to change without notice

OPERATING INSTRUCTIONS



SAFETY INFORMATION



Read carefully & keep for future reference.

- The safety of Your appliance complies with the industry standards and with legal requirements on the safety of appliances. However, as manufacturers, we feel it is our duty to provide the following safety notes.
- It is most important that this instruction book should be retained with the appliance for future reference. Should the appliance be sold or transferred to another owner, or should you move house and leave the appliance, always ensure that the book is supplied with the appliance in order that the new owner can get to know the functioning of the appliance and the relevant warnings.
- You **MUST** read them carefully before installing or using the appliance.
- Before first starting up, check the appliance for any damage incurred during transport. Never connect up a damaged appliance. If parts are damaged, contact your supplier.
- If the appliance is delivered in the winter months when there are minus temperatures. Store it at room temperature for 24 hours before using for the first time.

General safety

- It is dangerous to alter the specifications or attempt to modify this product in any way.
- During high temperature wash programmes the door glass may get hot. Do not touch it!
- Make sure that small pets and children do not climb into the drum. To avoid this, please check into the drum before using.
- Any objects such as coins, safety pins, nails, screws, stones or any other hard, sharp material can cause extensive damage and must not be placed into the machine.
- Only use the advised quantities of fabric softener and detergent. Damage to the fabric can ensue if you over-fill. Refer to the manufacturer's recommendations of quantities.
- Wash small items such as socks, laces, washable belts etc in a washing bag or pillow case as it is possible for such items to slip down between the tub and the inner drum.
- Do not use your washing machine to wash articles with whalebones, material without hems or torn material.
- Always unplug the appliance and turn off the water supply after use, cleaning and maintenance.
- Under no circumstances should you attempt to repair the machine yourself. Repairs carried out by inexperienced people may cause injury or serious malfunctioning. Contact your local Service Centre. Always insist on genuine spare parts.

Installation

- This appliance is heavy. Care should be taken when moving it.
- When unpacking the appliance, check that it is not damaged. If in doubt, do not use it and contact the Service Centre.
- All packing and transit bolts must be removed before use. Serious damage can occur to the product and to property if this is not adhered to. See relevant section in the user manual.
- After having installed the appliance, check that it is not standing on the inlet and drain hose and the worktop is not pressing the electrical supply cable against the wall.
- If the machine is situated on a carpeted floor, please adjust the feet in order to allow air to circulate freely under the appliance.
- Always be sure, that there is no water leakage from hoses and their connections after the installation.
- If the appliance is installed in a location subject to frost, please read the "dangers of freezing" chapter.
- Any plumbing work required to install this appliance should be carried out by a qualified plumber or competent person.
- Any electrical work required to install this appliance should be carried out by a qualified electrician or competent person.

Use

- This appliance is designed for domestic use. It must not be used for purposes other than those for which it was designed.
- Only wash fabrics which are designed to be machine washed. Follow the instructions on each garment label.
- Do not overload the appliance. See the Washing Programme Table.
- Before washing, ensure that all pockets are empty and buttons and zips are fastened. Avoid washing frayed or torn articles and treat stains such as paint, ink, rust, and grass before washing. Underwired bras must NOT be machine washed.
- Garments which have been in contact with volatile petroleum products should not be machine washed. If volatile cleaning fluids are used, care should be taken to ensure that the fluid is removed from the garment before placing in the machine.
- Never pull the power supply cable to remove the plug from the socket; always take hold of the plug itself.
- Never use the appliance if the power supply cable, the control panel, the working surface or the base are damaged so that the inside of the washing machine is accessible.

Child Safety

- This appliance is not intended for use by person (including children) with reduced physical sensory or mental capabilities or lack of experience and knowledge unless they have been given supervision or instruction concerning use of the appliance by a person responsible for their safety.
- Children should be supervised to ensure that they do not play with the appliance.
- The packaging components (e.g. plastic film, polystyrene) can be dangerous to children - danger of suffocation! Keep them out of children's reach.
- Keep all detergents in a safe place out of children's reach.

- Make sure that children or pets do not climb inside the drum. To prevent children or pets becoming trapped inside the drum the machine incorporates a special feature. To activate this device, rotate the button (without pressing it) inside the door clockwise until the groove is horizontal. If necessary use a coin. To disable this device and restore the possibility of closing the door, rotate the button anticlockwise until the groove is vertical.

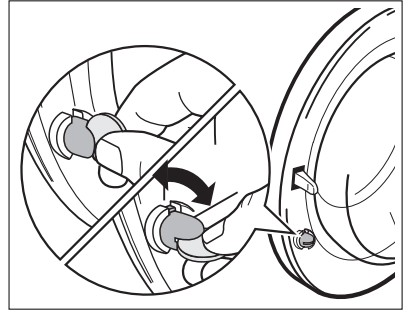

PRODUCT DESCRIPTION

Your new appliance meets all modern requirements for effective treatment of laundry with low water, energy and detergent consumption. The NEW JET system allows total use of detergent and reduces water consumption so saving energy.

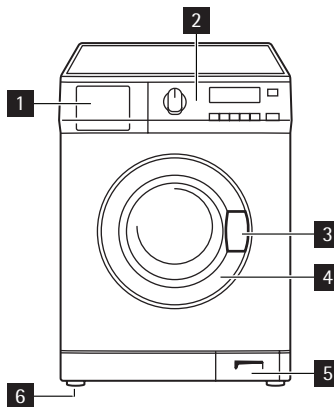

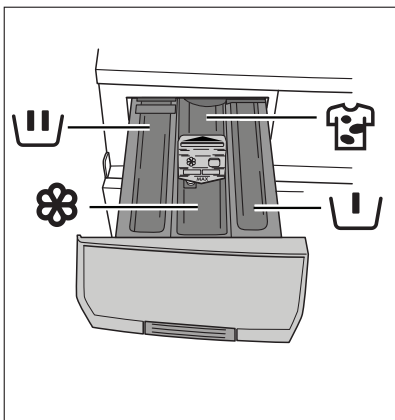

- 1 Detergent dispenser drawer
- 2 Control panel
- 3 Door opening handle
- 4 Rating plate
- 5 Drain pump
- 6 Adjustable feet

Detergent dispenser drawer



 Compartment for detergent used for **prewash**. The prewash detergent is added at the beginning of the wash programme.

 Compartment for powder or liquid detergent used for **main wash**.

 Compartment for **liquid additives** (fabric softener, starch).

 Compartment for stain remover used for main wash with **STAIN-option**.

CONTROL PANEL

 Below is a picture of the control panel. It shows the programme selector dial as well as the buttons and the display. These are presented by relevant numbers on the following pages.

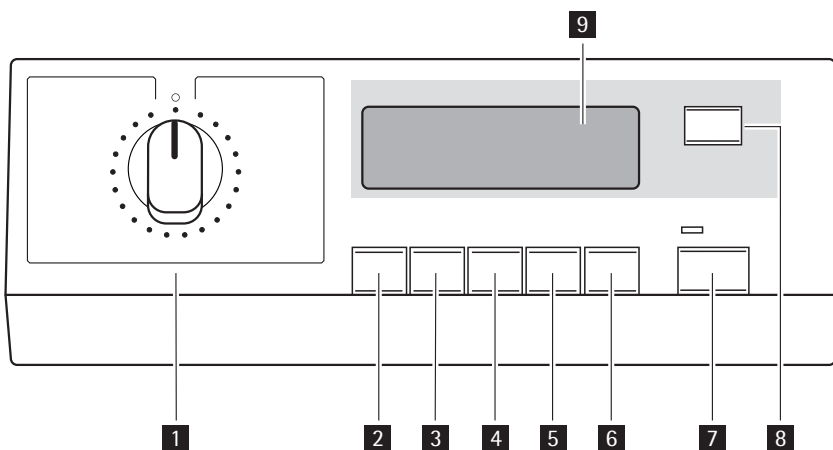

1 Programme selector dial

2 TEMPERATURE button

- 3 SPIN reduction button
- 4 OPTIONS button
- 5 OK button
- 6 TIME SAVING button
- 7 START/PAUSE button
- 8 DELAY START button
- 9 Display

Symbols:

- Handwash;
- Child Lock.

DISPLAY





- 9.1 - Temperature indicator and COLD ❄️ symbol
- 9.2 - Spin Speed indicator, RINSE HOLD 🛑, NIGHT CYCLE 🌙 - symbols
- 9.3 - Programme progress display: PREWASH 🛑, MAIN WASH 🛑, RINSE 🛑, SPIN 🌀, DRAIN 🚰, OVERDOSAGE 🙅
- The programme progress display shows the washing phases of the selected programme.
- During a washing cycle, a black line blinks under the washing phase symbol of the running programme. At the end of each washing phase, the line under the corresponding symbol becomes fixed.



If the OVERDOSAGE symbol lights up at the end of the programme, it indicates that too much detergent has been used.

- 9.4 - Options: PREWASH 🛑, STAIN 🧼, SENSITIVE 🍃, EXTRA RINSE 🛑
- 9.5 - DOOR 🔑 - symbol (Door locked)
 - This symbol indicates if the door can be opened:
 - the symbol is on: the door cannot be opened. The appliance is performing a washing programme.
 - the symbol is blinking: the door is opening
 - the symbol is off: the door can be opened. The washing programme is finished.
- 9.6 - TIME SAVING ⌚ - option symbol
- 9.7 - The display shows the following information:
 - Duration of the selected programme

- After selecting a programme, the duration is displayed in hours and minutes (for example **2.05**. The duration is calculated automatically on the basis of the maximum recommended load for each type of fabric.
 - After the programme has started, the time remaining is updated every minute.
 - Delay start
 - The selected delay (20 hours max) set by means of the relevant button appears on the display for about 3 seconds (for example **90'**), then the duration of the previously selected programme is displayed.
 - The DELAY START symbol will appear on the display.
 - The delay time value decreases by one unit every hour and then, when remains 1 hour, the time decreases every minute.
 - Incorrect option selection
 - If an option which is not compatible with the set wash programme is selected, the message **Err** is displayed for about 2 seconds and the yellow light of button **7** starts blinking.
 - Alarm codes
 - In the event of operating problems, some alarm codes can be displayed, for example **E20** (see chapter «What to do if...»).
 - End of the programme
 - When the programme has finished a blinking zero **0** is displayed, the DOOR symbol disappears and the door can be opened.
- 9.8** - DELAY START  - symbol
- 9.9** - CHILD SAFETY LOCK  - symbol

FIRST USE



- Ensure that the electrical and water connections comply with the installation instructions.
- Remove the polystyrene block and any material from the drum.
- Before the first wash, run a cotton cycle at the highest temperature without any laundry in the machine, to remove any manufacturing residue from the drum and tub. Pour 1/2 a measure of detergent into the main wash compartment and start the machine.

PERSONALIZATION

Acoustic signals

The machine is provided with an acoustic device, which sounds in the following cases:

- at the end of the cycle
- in the event of operating problems.

By pressing the **3** and **4** buttons simultaneously for about 6 seconds, the acoustic signal is deactivated (except for the events of operating problems). By pressing these two buttons again, the acoustic signal is reactivated.

Child safety lock

This device permits you to leave the appliance unattended and not to worry that children might be injured by or cause damage to the appliance.

This function remains able also when the washing machine is not working.

To enable (or disable) this option press simultaneously for about 6 seconds buttons **4** and **5** until the Child Lock symbol appears on (or disappears from) the display.

There are two different ways to set this option:

- Before pressing button **7**: it will be impossible to start the machine.
- after pressing button **7**: it will be impossible to change any other programme or option.

DAILY USE

Load the laundry

1. Open the door by carefully pulling the door handle outwards. Place the laundry in the drum, one item at a time, shaking them out as much as possible.
2. Close firmly the door. You must hear a click during closing.



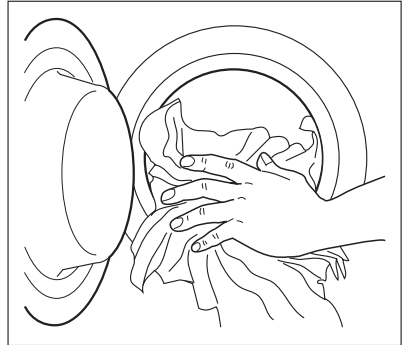

WARNING!

Do not embed the laundry between the door and the rubber joint.





Measure out the detergent and the fabric softener

Your new appliance was designed to reduce water, energy and detergent consumption.

1. Pull out the dispenser drawer until it stops. Measure out the amount of detergent required, pour it into the main wash compartment  and, if you wish to carry out the **prewash** phase, pour the detergent into the compartment marked .

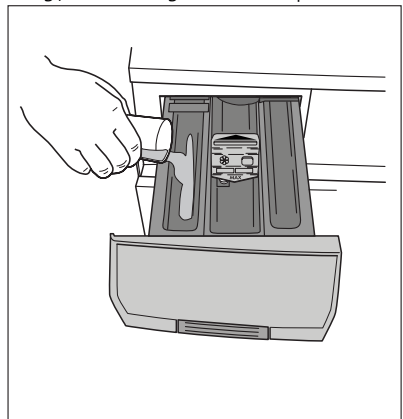
If you wish to perform the **stain** function, pour the stain remover into the compartment  marked with an arrow.



- If required, pour fabric softener into the compartment marked  (the amount used must not exceed the **MAX** mark in the drawer).

Close the drawer gently.

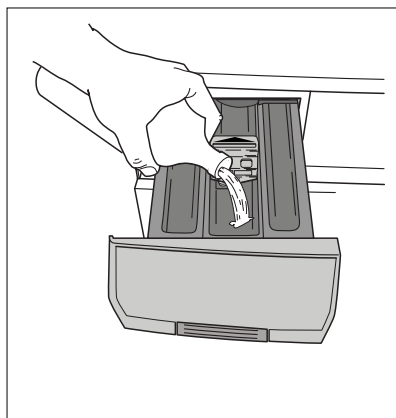

Turn the programme dial (1) to set the required programme

You can choose the right programme for any type of laundry following the descriptions on the washing programme tables (see «Washing Programmes»).

Turn the programme dial to the required programme. The programme dial determines the type of washing cycle (e.g. water level, drum movement, number of rinses) and the washing temperature according to the type of laundry.

The light of button **7** starts blinking and the display shows the duration of the selected programme.

The programme dial can be turned either clockwise or anticlockwise.

Position  = Reset programme / Switching OFF of the machine.

At the end of the programme the selector dial must be turned to position , to switch the machine off.

-  If you turn the programme selector dial to another programme when the machine is working, the yellow pilot light of button **7** will blink 3 times and the message **Err** is displayed on the display to indicate a wrong selection. The machine will not perform the new selected programme.

Select the desired TEMPERATURE (Button 2)

-  When selecting a programme, the appliance automatically proposes the default temperature provided for that programme.

Press this button repeatedly to increase or decrease the temperature, if you want your laundry to be washed at a temperature different from the one proposed by the washing machine.

The symbol of cold wash corresponds to -- ().

-  For the maximum and the minimum available wash water temperature, see «Washing programmes».

Select the spin speed, NIGHT CYCLE or RINSE HOLD option (button 3)



When the required programme has been selected, your appliance automatically proposes the maximum spin speed provided for that programme.

Press this button repeatedly to change the spin speed, if you want your laundry to be spun at a speed different from the one proposed by the washing machine.

RINSE HOLD: by selecting this option the water of the last rinse is not emptied out to prevent the fabrics from creasing. At the end of the programme, and RINSE HOLD symbol appear on the display, DOOR symbol (door locked) remains lit, the pilot light of button **7** goes off and the door is blocked to indicate that the water must be emptied out.

NIGHT CYCLE: by selecting this option, the machine will not drain the water of the last rinse, so as not to wrinkle the laundry. As all spinning phases are suppressed, this washing cycle is very noiseless and it can be selected at night or in times with a more economical power rate. In some programmes the rinses will be performed with more water. At the end of the programme, and RINSE HOLD symbol appear on the display, the DOOR symbol remains lit, the pilot light of button **7** goes off and the door is blocked to indicate that the water must be emptied out.

To empty out the water, please read chapter «At the end of the programme».

Programme option buttons

Depending on the programme, different functions can be combined.



WARNING!

Not all the options are compatible among themselves. The symbols of the incompatible options disappear.

Anyway, if an option, which is not compatible with the set washing programme or any other option, is selected, the **Err** message is displayed for few seconds and the yellow pilot of button **7** light starts blinking.

You must select the options after you have selected the programme but before pressing the button **7**. Press the button **4**: all the option symbols appear on the display.

To scroll all the available options, press the button **4**. The corresponding symbol appears on the display and starts blinking.

Press the button **5** to activate and confirm your choice. A black dash appears under the selected symbol to indicate that this option has been set. Press the same button to deactivate the option.

After selecting the options, wait about few seconds until the display gets back to the default status. The selected options appear on the display.



For the compatibility among the options and the washing programmes see chapter «Washing Programmes».

PREWASH option

Select this option if you wish your laundry to be prewashed at 30°C before the main wash. The Prewash ends with a short spin in programmes for cotton and synthetic fabrics, whereas in the programmes for delicate fabrics the water is only drained.

The relevant symbol will appear on the display.

This option is recommended for heavily soiled laundry.

STAIN option

Select this option to treat heavily soiled or stained laundry with stain remover (extended main wash with time optimized stain action phase). The relevant symbol will appear on the display.

This option is **not** available with a temperature lower than 40°C.

If you wish to perform a programme with the stain option, pour stain remover into stain compartment  marked with an arrow.

SENSITIVE option

By selecting this option the washing intensity will be reduced. The machine adds one rinse in the programmes for cottons and synthetics. The relevant symbol will appear on the display.

This option cannot be selected together with Extra Rinse option.

This option is recommended for non fast coloured items and for frequently washed items.

EXTRA RINSE option (additional rinse)

This appliance is designed for saving water. However, for people with a very delicate skin (allergic to detergents) it may be necessary to rinse the laundry using an extra quantity of water (extra rinse). The relevant symbol will appear on the display and this option is active for selected washing programme.

If you wish to activate this option permanently press simultaneously buttons **2** and **3** for some seconds: the relevant symbol appears on the display. If you wish to cancel it press the same buttons until the symbol disappears.

Select the TIME SAVING option (button 6)

This option allows you to modify the washing time, automatically proposed by the appliance.

By pressing this button you can select the following options:

DAILY: by pressing button **6** once, the corresponding symbol appears on the display and the washing duration will be reduced to wash daily soiled laundry. Reduced washing time is presented on the display.

SUPER QUICK: by pressing button **6** twice, the corresponding symbol remains lit on the display and the washing duration will be reduced to wash lightly soiled laundry or items that have been used or worn for a short time. Reduced washing time is presented on the display.

Select the START/PAUSE (button 7)

To start the selected programme, press the button **7**, the corresponding red pilot light stops blinking.

The **DOOR** symbol appears on the display to indicate that the appliance has started operating and the door is locked.

To interrupt a programme which is running, press the button **7**: the corresponding red pilot light starts blinking.

To restart the programme from the point at which it was interrupted, press the button **7** again. If you have chosen a delayed start the machine will begin the countdown.

If an incorrect option is selected, the yellow pilot light of the button **7** blinks 3 times and the message **Err** is displayed for a few seconds.

Select the DELAY START (button 8)

Before you start the programme, if you wish to delay the start, press the button repeatedly, to select the desired delay.

The corresponding symbol will appear on the display. The wash programme can be delayed from 30 min - 60 min - 90 min, 2 hours and then by 1 hour up to a maximum of 20 hours by means of this button.

The selected delay time value will appear on the display for about 3 seconds, then the duration of the programme will appear again.

You must select this option after you have set the programme and before you press the button **7**.

You can modify or cancel the delay time at any moment, before you press the button **7**.

The door will be locked throughout the delay time. If you wish to add laundry in the machine during the delay time, press the button **7** to set the machine to pause. When the Door symbol disappears, the door can be opened. Add the laundry, close the door and press the button **7** again.

Selecting the delayed start.

- Select the programme and the required options.
- Select the delay start.
- Press button **7**: the appliance starts its hourly countdown. The programme will start after the selected delay has expired.

Cancelling the delayed start

- Set the washing machine to PAUSE by pressing the button **7**;
- Press button **8** until the symbol  is displayed;
- Press the button **7** again to start the programme.



The selected delay can be changed only after selecting the washing programme again.

The Delay Start can not be selected with Drain programme.

Altering an option or a running programme

It is possible to change some options before the programme carries them out. Before you make any change, you must pause the washing machine by pressing the button **7**.

Changing a running programme is possible **only by resetting it**. Turn the programme selector dial to  and then to the new programme position. Start the new programme by pressing the **7** button again. The washing water in the tub will not emptied out.

Interrupting a programme

Press the button **7** to interrupt a programme which is running, the corresponding light starts blinking. Press the button again to restart the programme.

Cancelling a programme

Turn the selector dial to  to cancel a programme which is running. Now you can select a new programme.

Opening the door after the programme has started

When the machine is working and throughout the delay time the door is locked. If, for any reason, you wish to open the door, set firstly the machine to pause by pressing the button **7**.

- If the DOOR symbol blinks and after a few minutes disappears, the door can be opened;
- If the DOOR symbol doesn't go off, it means that the machine is already heating or that the water level is too high. In this case the door cannot be opened;
- If you cannot open the door but you need to open it, you have to switch the machine off by turning the selector dial to . After a few minutes the door can be opened (**pay attention to the water level and temperature!**);



After closing the door, it is necessary to select the programme again and to press button **7**.

At the end of the programme

The machine stops automatically, the light of button **7** goes off. A blinking  appears on the display and the acoustic signal sounds for some minutes.

If you have chosen a programme or an option that ends with water in the tub, follow the below instruction to empty the water out. The drum continues to run at regular intervals until the water draining.

To empty the water out:





- turn the programme selector dial to 
- set the DRAINING or SPINNING programme
- if needed, press the relevant button to reduce the spin speed
- press the button **7**
- when the programme has finished the display shows a blinking . On the display the DOOR symbol disappears. The door can be opened.





Turn the programme selector dial to  to switch the machine off. Remove the laundry from the drum and carefully check that the drum is empty.







If you do not intend to carry out another wash, close the water tap. Leave the door open to prevent the formation of mildew and unpleasant smells.







Stand by : once the programme has finished after a few minutes the energy saving system will be enabled. The brightness of the display is reduced. By pressing any button the appliance will come out of the energy saving status.



WASHING PROGRAMMES

Programme Maximum and Minimum Temperature Cycle Description Maximum Fabrics Load Type of Laundry	Options	Detergent Compartment
<p>COTTON 95°- Cold Main wash - Rinses - Long spin at maximum spin speed Max. load 8 kg - Reduced load 4 kg For white and coloured cotton (normally soiled items).</p>	SPIN reduction / NIGHT CYCLE / RINSE HOLD PREWASH ¹⁾ STAIN ²⁾ SENSITIVE EXTRA RINSE TIME SAVING ³⁾	
<p>SANITISE 60° Main wash - Rinses - Long spin at maximum spin speed Max. load 8 kg The washing programme for white cottons. This program eliminates the micro-organisms thanks to the washing by 60 °C and an additional rinse. In this way the action is more effective. Put into the compartment Stain a special additive for hygiene and select the option Stain.</p>	SPIN reduction / RINSE HOLD PREWASH ¹⁾ STAIN	
<p>40- 60 MIX 40° Main wash - Rinses - Long spin at maximum spin speed Max. load 8 kg White and coloured cotton This programme can be used for laundry, which should be washed at 40 °C or 60 °C separately. The maximum load capacity can be put into the drum in order to save energy and water. The same good washing result will be obtained as for normal programme at 60 °C.</p>	SPIN reduction / NIGHT CYCLE / RINSE HOLD PREWASH ¹⁾ STAIN SENSITIVE EXTRA RINSE	
<p>JEANS 60° - Cold Main wash - Rinses - Long spin at 1200 rpm Max. load 4 kg With this programme it is possible to wash items like pants, shirts or jackets in Jeans and also jersey realized with hi-tech materials. (The Extra Rinse option will be activated automatically).</p>	SPIN reduction / NIGHT CYCLE / RINSE HOLD PREWASH ¹⁾	

Programme Maximum and Minimum Temperature Cycle Description Maximum Fabrics Load Type of Laundry	Options	Detergent Compartment
SYNTHETICS 60°- Cold Main wash - Rinses - Short spin at 1200 rpm Max. load 4 kg - Reduced load 2 kg Synthetic or mixed fabrics: underwear, coloured garments, non-shrink shirts, blouses.	SPIN reduction / NIGHT CYCLE / RINSE HOLD PREWASH ¹⁾ STAIN ²⁾ SENSITIVE EXTRA RINSE TIME SAVING ³⁾	
EASY IRON 60°- Cold Main wash - Rinses - Short spin at 1200 rpm Max. load 1.5 kg Synthetic fabrics to be gentle washed and spun. Selecting this programme the laundry is gently washed and spun to avoid any creasing. In this way ironing is easier. Furthermore the machine will perform additional rinses.	SPIN reduction / RINSE HOLD PREWASH ¹⁾ EXTRA RINSE	
DELICATES 40°- Cold Main wash - Rinses - Short spin at 1200 rpm Max. load kg 4 - Reduced load kg 2 Delicate fabrics: acrylics, viscose, polyester.	SPIN reduction / NIGHT CYCLE / RINSE HOLD PREWASH ¹⁾ STAIN ²⁾ EXTRA RINSE TIME SAVING ³⁾	
VISCOSE 40°- Cold Main wash - Rinses - Short spin at 1200 rpm Max. load kg 4 Special gentle programme for fabrics such a viscose, cupro, lyocell. It performs an cleaning action more intensive than the handwash programme.	SPIN reduction / NIGHT CYCLE / RINSE HOLD PREWASH ¹⁾ STAIN ²⁾ EXTRA RINSE	
DELICATE RINSES Rinses - Short spin at 1200 rpm Max. load 8 kg With this programme it is possible to rinse and spin cotton garments which have been washed by hand. The machine performs some rinses, followed by a final spin.	SPIN reduction / NIGHT CYCLE / RINSE HOLD EXTRA RINSE	

Programme Maximum and Minimum Temperature Cycle Description Maximum Fabrics Load Type of Laundry	Options	Detergent Compartment
DRAIN Draining of water Max. load 8 kg For emptying out the water of the last rinse in programmes with the Rinse Hold or Night Cycle option selected.		
SPIN Drain and long spin at maximum spin speed Max. load 8 kg Separate spin for hand washed cotton garments and after programmes with the Rinse Hold or Night Cycle option selected. Before selecting this programme the selector dial must be turned to  . You can choose the spin speed by pressing the relevant button to adapt it to the fabrics to be spun.	SPIN reduction	
BLANKET 40° - 30° Main wash - Rinses - Short spin at 800 rpm Max. load 2 kg Special programme for a single synthetic blanket, duvet, bedspread and so on.	SPIN reduction	
WOOL PLUS / SILK /HANDWASH  40° - Cold Main wash - Rinses - Short spin at 1200 rpm Max. load 2 kg; silk: max. load 1 kg Washing programme for machine washable wool as well as for hand washable woollens and delicate fabrics. Note: A single or bulky item may cause imbalance. If the appliance doesn't perform the final spin phase, add more items, redistribute the load manually and then select the spinning programme.	SPIN reduction / NIGHT CYCLE / RINSE HOLD	
LINGERIE  40° - Cold Main wash - Rinses - Short spin at 1200 rpm Max. load 1 kg This programme is suitable for very delicate items, as lingerie, bras and underwear etc.	SPIN reduction / NIGHT CYCLE / RINSE HOLD	

Programme Maximum and Minimum Temperature Cycle Description Maximum Fabrics Load Type of Laundry	Options	Detergent Compartment
SPORT JACKETS 40° - Cold Main wash - Rinses - Short spin at 800 rpm Max. load 2 kg Special program for sport clothes. By selecting this program, do not add any additives.	SPIN reduction / RINSE HOLD EXTRA RINSE	
SPORT INTENSIVE 40° - Cold Prewash - Main wash - Rinses - Short spin at 1200 rpm Max. load 2 kg Special programme is suitable for washing heavily soiled sport items. The machine will add automatically a prewash phase before the main wash to eliminate mud stains. We recommend you NOT to put the detergent into the  compartment of the detergent drawer.	SPIN reduction / NIGHT CYCLE / RINSE HOLD EXTRA RINSE	
20 MIN. - 3KG 30° Main wash - Rinses - Short spin at 1200 rpm Max. load 3 kg This programme may be used for a quick washing of sport items or cotton and synthetic items, lightly soiled or worn once.	SPIN reduction	
QUICK INTENSIVE 60° - 40° Main wash - Rinses - Short spin at 1200 rpm Max. load 5 kg Quick washing programme, to be used for lightly soiled white/fast coloured cottons and mixed fabrics.	SPIN reduction / RINSE HOLD EXTRA RINSE	
SUPER ECO Cold Main wash - Rinses - Short spin at 1200 rpm Max. load 3 kg Mixed fabrics (cotton and synthetic). Cold wash programme designed for saving energy, water and time. This programme is suitable with detergents that becomes effective at low temperature. The detergent must be used with the supplied or a suitable detergent dosing cap (use the amount of the detergent recommended by detergent's manufacturer). The appliance automatically runs a short heating phase if the water temperature is lower than 6°C only.	SPIN reduction / RINSE HOLD EXTRA RINSE	

Programme Maximum and Minimum Temperature Cycle Description Maximum Fabrics Load Type of Laundry	Options	Detergent Compartment
COTTON ECONOMY 60° Main wash - Rinses - Long spin at maximum spin speed Max. load 8 kg White and fast coloured cotton. This programme can be selected for slightly or normally soiled cotton items. The temperature will decrease and the washing time will be extended. This allows to obtain a good washing efficiency so saving energy.	SPIN reduction / RINSE HOLD / NIGHT CYCLE PREWASH ¹⁾ STAIN SENSITIVE EXTRA RINSE	
 / OFF For cancelling the programme which is running or to switch the machine off .		

1) If using liquid detergents, a programme without prewash must be selected.

2) Stain option can be selected only at the temperature of 40°C or higher.

3) If you select the Super Quick option by pressing button **6**, we recommend that you reduce the maximum load as indicated. Full loading is possible however with somewhat reduced cleaning results.

HELPFUL HINTS AND TIPS

Sorting out the laundry

Follow the wash code symbols on each garment label and the manufacturer's washing instructions. Sort the laundry as follows: whites, coloureds, synthetics, delicates, woollens.

Before loading the laundry

Never wash whites and coloureds together. Whites may lose their «whiteness» in the wash. New coloured items may run in the first wash; they should therefore be washed separately the first time.

Button up pillowcases, close zip fasteners, hooks and poppers. Tie any belts or long tapes. Remove persistent stains before washing.

Rub particularly soiled areas with a special detergent or detergent paste.

Treat curtains with special care. Remove hooks or tie them up in a bag or net.

Removing stains

Stubborn stains may not be removed by just water and detergent. It is therefore advisable to treat them prior to washing.

Blood: treat fresh stains with cold water. For dried stains, soak overnight in water with a special detergent then rub in the soap and water.

Oil based paint: moisten with benzine stain remover, lay the garment on a soft cloth and dab the stain; treat several times.

Dried grease stains: moisten with turpentine, lay the garment on a soft surface and dab the stain with the fingertips and a cotton cloth.

Rust: oxalic acid dissolved in hot water or a rust removing product used cold. Be careful with rust stains which are not recent since the cellulose structure will already have been damaged and the fabric tends to hole.

Mould stains: treat with bleach, rinse well (whites and fast coloureds only).

Grass: soap lightly and treat with bleach (whites and fast coloureds only).

Ball point pen and glue: moisten with acetone¹⁾, lay the garment on a soft cloth and dab the stain.

Lipstick: moisten with acetone as above, then treat stains with methylated spirits. Treat any residual marks with bleach.

Red wine: soak in water and detergent, rinse and treat with acetic or citric acid, then rinse. Treat any residual marks with bleach.

Ink: depending on the type of ink, moisten the fabric first with acetone¹⁾, then with acetic acid; treat any residual marks on white fabrics with bleach and then rinse thoroughly.

Tar stains: first treat with stain remover, methylated spirits or benzine, then rub with detergent paste.

Detergents and additives

Good washing results also depend on the choice of detergent and use of the correct quantities to avoid waste and protect the environment.

Although biodegradable, detergents contain substances which, in large quantities, can upset the delicate balance of nature.

The choice of detergent will depend on the type of fabric (delicates, woollens, cottons, etc.), the colour, washing temperature and degree of soiling.

All commonly available washing machine detergents may be used in this appliance:

- powder detergents for all types of fabric
- powder detergents for delicate fabrics (60°C max) and woollens
- liquid detergents, preferably for low temperature wash programmes (60°C max) for all types of fabric, or special for woollens only.

The detergent and any additives must be placed in the appropriate compartments of the dispenser drawer before starting the wash programme.

If using liquid detergents, a programme **without** prewash must be selected.

Your appliance incorporates a recirculation system which allows an optimal use of the concentrated detergent.

Follow the product manufacturer's recommendations on quantities to use and do **not exceed the «MAX» mark in the detergent dispenser drawer.**

Quantity of detergent to be used

The type and quantity of detergent will depend on the type of fabric, load size, degree of soiling and hardness of the water used.

Follow the product manufacturers' instructions on quantities to use.

Use less detergent if:

- you are washing a small load
- the laundry is lightly soiled
- large amounts of foam form during washing.

1) do not use acetone on artificial silk

Degrees of water hardness

Water hardness is classified in so-called "degrees" of hardness. Information on hardness of the water in your area can be obtained from the relevant water supply company, or from your local authority. If the water hardness degree is medium or high we suggest you to add a water softener following always the manufacturer's instructions. When the degree of hardness is soft, readjust the quantity of the detergent.

CARE AND CLEANING

You must DISCONNECT the appliance from the electricity supply, before you can carry out any cleaning or maintenance work.

Descaling

The water we use normally contains lime. It is a good idea to periodically use a water softening powder in the machine. Do this separately from any laundry washing, and according to the softening powder manufacturer's instructions. This will help to prevent the formation of lime deposits.

After each wash

Leave the door open for a while. This helps to prevent mould and stagnant smells forming inside the appliance. Keeping the door open after a wash will also help to preserve the door seal.

Maintenance wash

With the use of low temperature washes it is possible to get a build up of residues inside the drum.

We recommend that a maintenance wash be performed on a regular basis.

To run a maintenance wash:

- The drum should be empty of laundry.
- Select the hottest cotton wash programme.
- Use a normal measure of detergent, must be a powder with biological properties.

External cleaning

Clean the exterior cabinet of the appliance with soap and water only, and then dry thoroughly.



Do not use methylated spirits, solvents or similar products to clean the cabinet.

Detergent dispenser drawer

The detergent dispenser drawer should be cleaned regularly.

1. Remove the detergent dispenser drawer by pulling it firmly.

2. Remove the conditioner insert from the middle compartment.
3. Clean all parts with water.
4. Put the conditioner insert in as far as it will go, so that it is firmly in place.

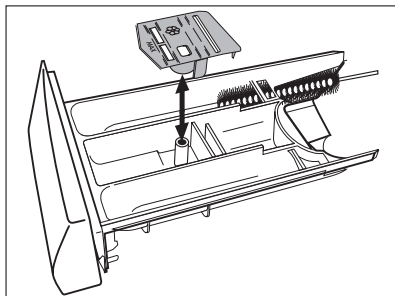

5. Clean all parts of the washing machine, especially the nozzles in the top of the washing-in chamber, with a brush.
6. Insert the detergent dispenser drawer in the guide rails and push it in.

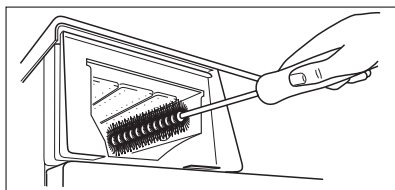

Washing drum

Rust deposits in the drum may occur due to rusting foreign bodies in the washing or tap water containing iron.



Do not clean the drum with acidic descaling agents, scouring agents containing chlorine or iron or steel wool.

1. Remove any rust deposits on the drum with a cleaning agent for stainless steel.
2. Run a washing cycle without any washing to clean off any cleaning agent residues.

Programme: Short Cotton Programme at maximum temperature and add approx. 1/4 measuring cup of detergent.

Door seal

Check from time to time the door seal and objects that could be trapped in the fold.

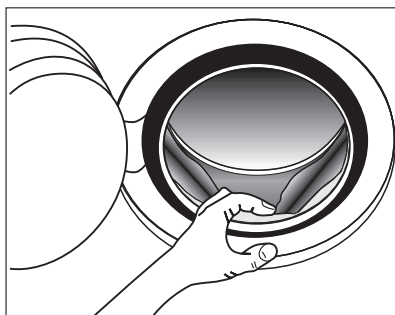

Drain pump

The pump should be inspected regularly and particularly if:

- the appliance does not empty and/or spin;

- the appliance makes an unusual noise during draining due to objects such as safety pins, coins etc. blocking the pump;
- a problem with water draining is detected (see chapter "What to do if..." for more details).

**WARNING!**

Before opening the pump door, switch the appliance off remove the mains plug from the socket.

Proceed as follows:

1. Unplug the appliance.
2. If necessary wait until the water has cooled down.
3. Open the pump door.
4. Pull flap forward to remove.
5. Place a container close to the pump to collect any spillage.

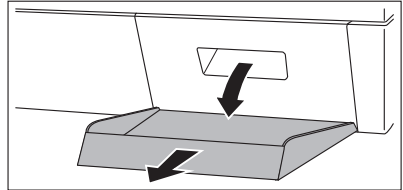

6. Pull out the emergency emptying hose, place it in the container and remove its cap.

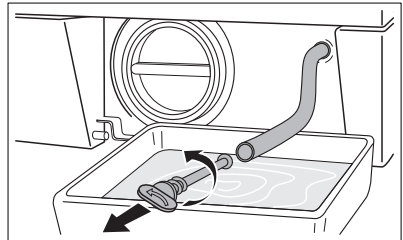
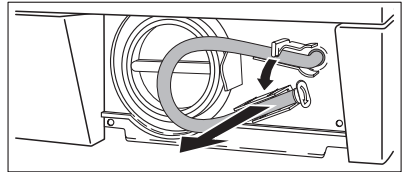

7. When no more water comes out, unscrew the pump cover by turning it anti-clockwise and remove the filter. Use pliers, if necessary. Always keep a rag nearby to dry up any water spillages when removing the cover.

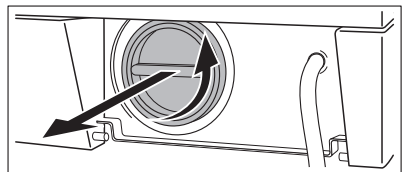

Clean the filter under a tap, to remove any traces of fluff.

8. Remove foreign bodies and fluff from the filter seat and from the pump impeller.
9. Check carefully whether the pump impeller rotates (it rotates jerkily). If it doesn't rotate, please contact your Service Centre.
10. Put the cap back on the emergency emptying hose and place the latter back in its seat.
11. Replace the filter into the pump by inserting it correctly into the special guides. Screw the pump cover firmly by turning it clockwise.
12. Refit the flap and close the pump door.

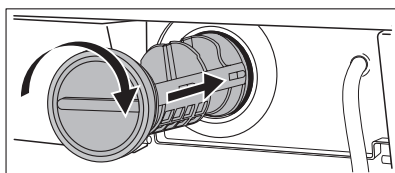
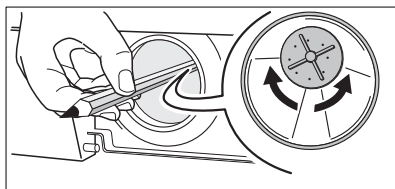
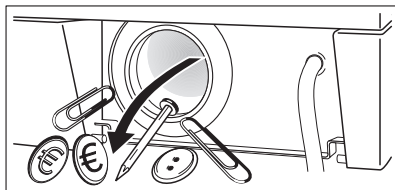

WARNING!

When the appliance is in use and depending on the programme selected there can be hot water in the pump.

Never remove the pump cover during a wash cycle, always wait until the appliance has finished the cycle, and is empty. When refitting the pump cover, ensure it is securely re-tightened so as to stop leaks and young children being able to remove it.

Cleaning the water inlet filters



If the appliance doesn't fill, it takes a long time to fill with water, the starting button blinks yellow or the display (if available) shows the relevant alarm (see chapter "What to do if..." for more details), check if the water inlet filters are blocked.

To clean the water inlet filters:

1. Turn off the water tap.
2. Unscrew the hose from the tap.
3. Clean the filter in the hose with a stiff brush.
4. Screw the hose back onto the tap. Make sure the connection is tight.

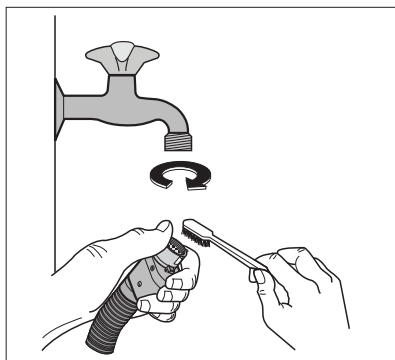

5. Unscrew the hose from the machine. Keep a towel nearby because some water may flow.
6. Clean the filter in the valve with a stiff brush or with the piece of cloth.

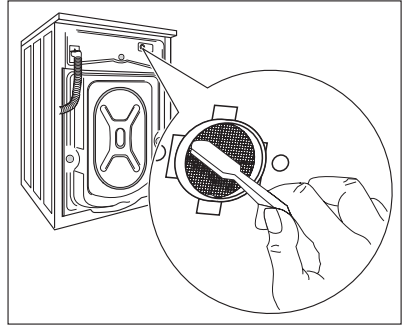

7. Screw the hose back to the machine and make sure the connection is tight.
8. Turn on the water tap.

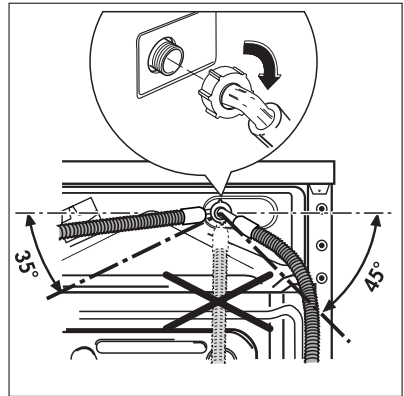

Frost precautions

If the machine is installed in a place where the temperature could drop below 0°C, proceed as follows:

1. close the water tap and unscrew the water inlet hose from the tap;
2. place the end of the emergency emptying hose and that of the inlet hose in a bowl placed on the floor and let water drain out;
3. screw the water inlet hose back on and reposition the emergency emptying hose after having put the cap on again.

By doing this, any water remaining in the machine is removed, avoiding ice forming and consequently damage to the appliance.

When you use the machine again, make sure that the ambient temperature is above 0°C.

Note!

This appliance is made for use in normal inside temperature.

Manufacturer is not responsible for freezing damages.

Emergency emptying out

If the water is not discharged, proceed as follows to empty out the machine:

1. pull out the plug from the power socket;
2. close the water tap;
3. if necessary, wait until the water has cooled down;
4. open the pump door;

5. place a bowl on the floor and place the end of the emergency emptying hose into the bowl. Remove its cap. The water should drain by gravity into the bowl. When the bowl is full, put the cap back on the hose. Empty the bowl. Repeat the procedure until water stops flowing out;
6. clean the pump if necessary as previously described;
7. replace the emergency emptying hose in its seat after having plugged it;
8. screw the pump again and close the door.

WHAT TO DO IF...

Certain problems are due to lack of simple maintenance or oversights, which can be solved easily without calling out an engineer. Before contacting your local Service Centre, please carry out the checks listed below.

During machine operation it is possible that the **yellow** pilot light of button **7** blinks, one of the following alarm codes appears on the display and at the same time some acoustic signals sound every 20 seconds to indicate that the machine is not working:

- **E10** : problem with the water supply
- **E20** : problem with the water draining
- **E40** : door open
- **EFO** : anti-flooding system has activated

Once the problem has been eliminated, press the button **7** to restart the programme. If after all checks, the problem persists, contact your local Service Centre.

Problem	Possible cause/Solution
<p>The washing machine does not start:</p>	<p>The door has not been closed. E40</p> <ul style="list-style-type: none"> • Close the door firmly. <p>The plug is not properly inserted in the power socket.</p> <ul style="list-style-type: none"> • Insert the plug into the power socket. <p>There is no power at the socket.</p> <ul style="list-style-type: none"> • Please check your domestic electrical installation. <p>The main fuse has blown.</p> <ul style="list-style-type: none"> • Replace the fuse. <p>The selector dial is not correctly positioned and the button 7 has not been depressed.</p> <ul style="list-style-type: none"> • Please turn the selector dial and press the button 7 again. <p>The delay start has been selected.</p> <ul style="list-style-type: none"> • If the laundry is to be washed immediately, cancel the delay start. <p>The Child Safety lock has been activated.</p> <ul style="list-style-type: none"> • Deactivate this device.

Problem	Possible cause/Solution
The machine does not fill:	<p>The water tap is closed. <i>E10</i></p> <ul style="list-style-type: none"> • Open the water tap. <p>The inlet hose is squashed or kinked. <i>E10</i></p> <ul style="list-style-type: none"> • Check the inlet hose connection. <p>The filter in the inlet hose or the inlet valve filter are blocked. <i>E10</i></p> <ul style="list-style-type: none"> • Clean the water inlet filters (see "Cleaning the water inlet filters" for more details). <p>The door is not properly closed. <i>E40</i></p> <ul style="list-style-type: none"> • Close the door firmly.
The machine fills then empties immediately:	<p>The end of the drain hose is too low.</p> <ul style="list-style-type: none"> • Refer to relevant paragraph in «Water drainage» section.
The machine does not empty and/or does not spin:	<p>The drain hose is squashed or kinked. <i>E20</i></p> <ul style="list-style-type: none"> • Check the drain hose connection. <p>The drain filter is clogged. <i>E20</i></p> <ul style="list-style-type: none"> • Clean the drain filter. <p>An option or a programme that ends with the water still in the tub or a that eliminates all the spinning phases has been selected.</p> <ul style="list-style-type: none"> • Select the draining or the spinning programme. <p>The laundry is not evenly distributed in the drum.</p> <ul style="list-style-type: none"> • Redistribute the laundry.
There is water on the floor:	<p>Too much detergent or unsuitable detergent (creates too much foam) has been used.</p> <ul style="list-style-type: none"> • Reduce the detergent quantity or use another one. <p>Check whether there are any leaks from one of the inlet hose fittings. It is not always easy to see this as the water runs down the hose; check to see if it is damp.</p> <ul style="list-style-type: none"> • Check the water inlet hose connection. <p>The drain hose is damaged.</p> <ul style="list-style-type: none"> • Change it with a new one. <p>The cap on the emergency emptying hose has not been replaced or the filter has not been properly screwed in after cleaning action.</p> <ul style="list-style-type: none"> • Put the cap back on the emergency emptying hose or screw the filter fully in.

Problem	Possible cause/Solution
Unsatisfactory washing results:	<p>Too little detergent or unsuitable detergent has been used.</p> <ul style="list-style-type: none"> • Increase the detergent quantity or use another one. <p>Stubborn stains have not been treated prior to washing.</p> <ul style="list-style-type: none"> • Use commercial products to treat the stubborn stains. <p>The correct temperature was not selected.</p> <ul style="list-style-type: none"> • Check if you have selected the correct temperature. <p>Excessive laundry load.</p> <ul style="list-style-type: none"> • Introduce into the drum less laundry.
The door will not open:	<p>The programme is still running.</p> <ul style="list-style-type: none"> • Wait the end of washing cycle. <p>The door lock has not been released.</p> <ul style="list-style-type: none"> • Wait until the door symbol 9.5 has gone off. <p>There is water in the drum.</p> <ul style="list-style-type: none"> • Select drain or spin programme to empty out the water.
The machine vibrates or is noisy:	<p>The transit bolts and packing have not been removed.</p> <ul style="list-style-type: none"> • Check the correct installation of the appliance. <p>The support feet have not been adjusted</p> <ul style="list-style-type: none"> • Check the correct levelling of the appliance. <p>The laundry is not evenly distributed in the drum.</p> <ul style="list-style-type: none"> • Redistribute the laundry. <p>Maybe there is very little laundry in the drum.</p> <ul style="list-style-type: none"> • Load more laundry.
Spinning starts late or the machine does not spin:	<p>The electronic unbalance detection device has cut in because the laundry is not evenly distributed in the drum. The laundry is redistributed by reverse rotation of the drum. This may happen several times before the unbalance disappears and normal spinning can resume. If, after some minutes, the laundry is still not evenly distributed in the drum, the machine will not spin.</p> <ul style="list-style-type: none"> • Redistribute the laundry. <p>The load is too small.</p> <ul style="list-style-type: none"> • Add more items, redistribute the load manually and then select the spinning programme.

Problem	Possible cause/Solution
The machine makes an unusual noise:	The machine is fitted with a type of motor which makes an unusual noise compared with other traditional motors. This new motor ensures a softer start and more even distribution of the laundry in the drum when spinning, as well as increased stability of the machine.
No water is visible in the drum:	Machines based on modern technology operate very economically using very little water without affecting performance.
The display shows the alarm code <i>EFO</i> :	Anti-flooding system has activated. <ul style="list-style-type: none"> • Pull out the plug from the power socket, close the water tap and contact the Service Force Centre.

If you are unable to identify or solve the problem, contact our service centre. Before telephoning, make a note of the model, serial number and purchase date of your machine: the Service Centre will require this information.

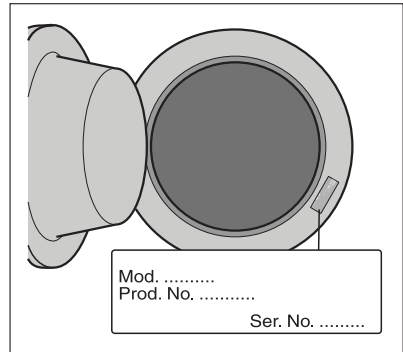

TECHNICAL DATA

Dimensions	Width Height Depth	60 cm 85 cm 63 cm
Electrical connection Voltage - Overall power - Fuse	Information on the electrical connection is given on the rating plate, on the inner edge of the appliance door.	
Water supply pressure	Minimum Maximum	0,05 MPa 0,8 MPa
Maximum Load	Cotton	8 kg
Spin Speed	Maximum	1600 rpm

CONSUMPTION VALUES

Programme ¹⁾	Energy consumption (KWh) ²⁾	Water consumption (litre) ²⁾
White Cottons 95 °C	2.5	65
Cottons 60 °C	1.7	63
Cottons 40 °C	1.0	62
Synthetics 40 °C	0.55	51
Delicates 40 °C	0.50	68
Wool/ Handwash 30 °C	0.30	64

1) Refer to the display for the programme time.

2) The consumption information shown in this chart is indicative. It can vary depending on the quantity and the type of laundry, on the temperature of the water supply and on the ambient temperature.

Standard programmes for the Energy Label consumption values

The cotton 60 °C economy and cotton 40 °C economy are the standard cotton programmes for normally soiled cotton laundry. They are suitable to clean normally soiled cotton laundry and they are the most efficient programmes in terms of combined energy and water consumption for washing that type of cotton laundry.

They agree with EN60456.



The actual water temperature may differ from the declared cycle temperature.

INSTALLATION INSTRUCTIONS

INSTALLATION

Unpacking

All transit bolts and packing must be removed before using the appliance.

You are advised to keep all transit devices so that they can be refitted if the machine ever has to be transported again.

1. After removing all the packaging, carefully lay machine on its back to remove the polystyrene base from the bottom.

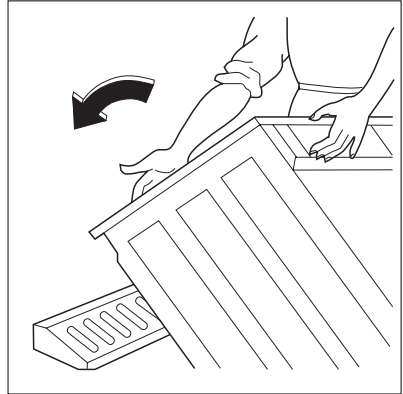

2. Remove the power supply cable and the draining hose from the hose holders on the rear of the appliance.

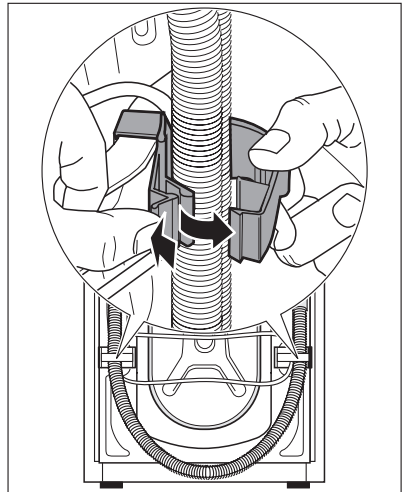

3. Unscrew the three bolts using the key supplied with the machine.

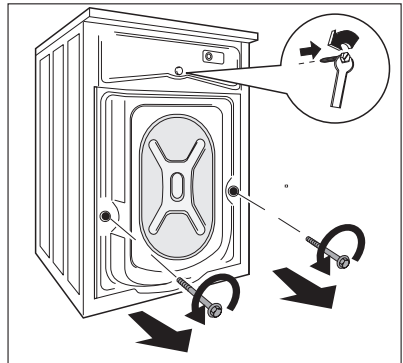

- Slide out the relevant plastic spacers.

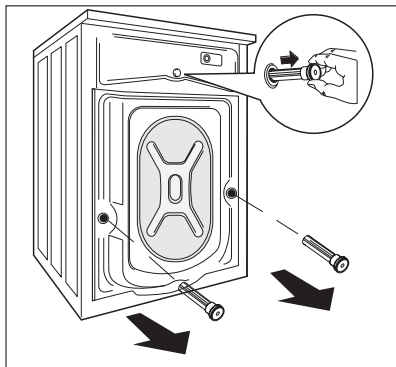

- Open the porthole, take out the inlet hose from the drum and remove the polystyrene block fitted on the door seal.

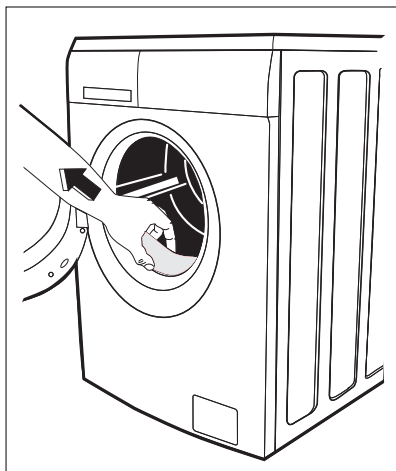

- Fill the smaller upper hole and the two large ones with the corresponding plastic plug caps supplied in the bag containing the instruction booklet.
- Connect the water inlet hose as described under the paragraph «Water inlet».

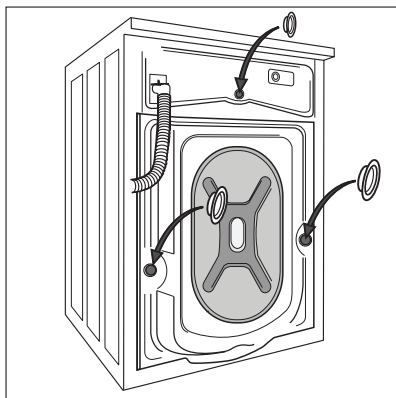

Positioning and levelling

Install the machine on a flat hard floor.

Make sure that air circulation around the machine is not impeded by carpets, rugs etc.

Before placing it on small tiles, apply a rubber coating.

Never try to correct any unevenness in the floor by putting pieces of wood, cardboard or similar materials under the machine.

If it is impossible to avoid positioning the machine next to a gas cooker or coalburning stove, an insulating panel covered with aluminium foil on the side facing the cooker or stove, must be inserted between the two appliances.

The machine must not be installed in rooms where the temperature can drop below 0°C.

The water inlet hose and the drain hose must not be kinked.

Please ensure that when the appliance is installed, it is easily accessible for the engineer in the event of a breakdown.

Carefully level by screwing the adjustable feet in or out. Never place cardboard, wood or similar materials under the machine to compensate for any unevenness in the floor.

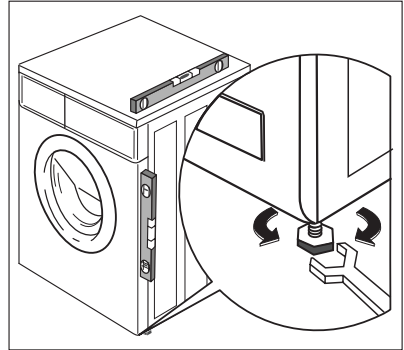

Rubber feet kit (4055126249)

Available from your authorized dealer.

The rubber feet are particularly recommended on floating, slippery and wooden floors.

Mount the rubber feet to prevent vibration, noises and displacement of the appliance during operation.

Read carefully the instructions supplied with the kit.

Water inlet

An inlet hose is supplied and can be found inside the machine drum.

This appliance must be connected to a cold water supply.

Do not use the hose from your previous machine to connect to the water supply.

1. Open the porthole and extract the inlet hose.
2. Connect the hose with the angled connection to the machine.



Do not place the inlet hose downwards. Angle the hose to the left or right depending on the position of your water tap.

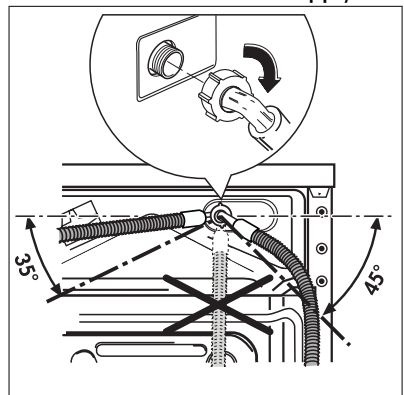

- Set the hose correctly by loosening the ring nut. After positioning the inlet hose, be sure to tighten the ring nut again to prevent leaks.
- Connect the hose to a tap with a 3/4" thread. Always use the hose supplied with the appliance.

The inlet hose must not be lengthened. If it is too short and you do not wish to move the tap, you will have to purchase a new, longer hose specially designed for this type of use.

Note ! Check if the water connections are tight.

Installation should comply with local water authority and building regulations requirements. Check the minimum water pressure required for safe operation of the appliance in the chapter "Technical Data".

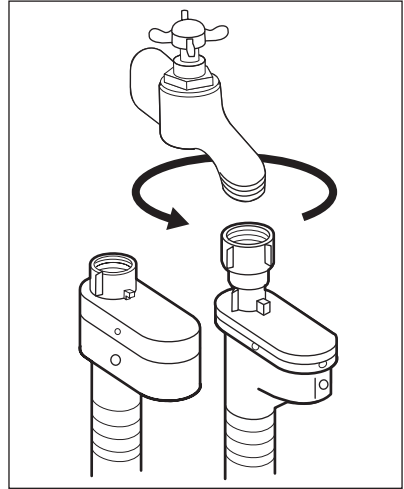

Water-stop device

The inlet hose is provided with a water stop device, which protects against damage caused by water leaks in the hose which could develop due to natural ageing of the hose. This fault is shown by a red sector in the window «A». Should this occur, turn the water tap off and refer to your Service Centre to replace the hose.

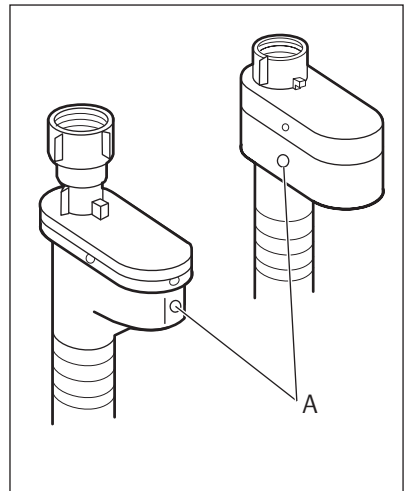

Water drainage

The end of the drain hose can be positioned in three ways:

- Hooked over the edge of a sink using the plastic hose guide supplied with the machine.**

In this case, make sure the end cannot come unhooked when the machine is emptying.

This could be done by tying it to the tap with a piece of string or attaching it to the wall.

2. **In a sink drain pipe branch.** This branch must be above the trap so that the bend is at least 60 cm above the ground.
3. **Directly into a drain pipe at a height** of not less than 60 cm and not more than 90 cm.

The end of the drain hose must always be ventilated, i.e. the inside diameter of the drain pipe must be larger than the outside diameter of the drain hose.

The drain hose must not be kinked.

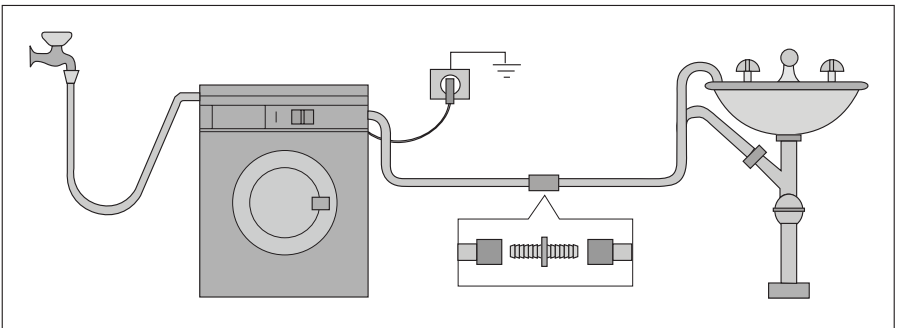
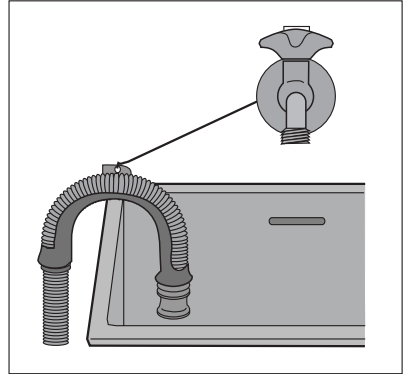

The drain hose may be extended to a maximum of 4 metres. An additional drain hose and joining piece is available from your local Service Centre.

ELECTRICAL CONNECTION

Information on the electrical connection is given on the rating plate on the inner edge of the appliance door.

Check that your domestic electrical installation can take the maximum load required, also taking into account any other appliances in use.



WARNING!

Connect the machine to an earthed socket.



WARNING!

The manufacturer does not accept any responsibility for damage or injury through failure to comply with the above safety precaution.



WARNING!

The power supply cable must be easily accessible after installing the machine.

**WARNING!**

Should the appliance power supply cable need to be replaced, this must be carried out by a Service Centre.

ENVIRONMENT CONCERNS

The symbol  on the product or on its packaging indicates that this product may not be treated as household waste. Instead it should be taken to the appropriate collection point for the recycling of electrical and electronic equipment. By ensuring this product is disposed of correctly, you will help prevent potential negative consequences for the environment and human health, which could otherwise be caused by inappropriate waste handling of this product. For more detailed information about recycling of this product, please contact your local council, your household waste disposal service or the shop where you purchased the product.

Packaging materials

The materials marked with the symbol  are recyclable.

>PE<=polyethylene

>PS<=polystyrene

>PP<=polypropylene

This means that they can be recycled by disposing of them properly in appropriate collection containers.

Ecological hints

To save water, energy and to help protect the environment, we recommend that you follow these tips:

- Normally soiled laundry may be washed without prewashing in order to save detergent, water and time (the environment is protected too!).
- The machine works more economically if it is fully loaded.
- With adequate pre-treatment, stains and limited soiling can be removed; the laundry can then be washed at a lower temperature.
- Measure out detergent according to the water hardness, the degree of soiling and the quantity of laundry being washed.



www.aeg.com/shop



132943471-A-282011

Free Manuals Download Website

<http://myh66.com>

<http://usermanuals.us>

<http://www.somanuals.com>

<http://www.4manuals.cc>

<http://www.manual-lib.com>

<http://www.404manual.com>

<http://www.luxmanual.com>

<http://aubethermostatmanual.com>

Golf course search by state

<http://golfingnear.com>

Email search by domain

<http://emailbydomain.com>

Auto manuals search

<http://auto.somanuals.com>

TV manuals search

<http://tv.somanuals.com>