

ÖKO-LAVAMAT 76760 update

The environmentally friendly washing machine

User information



Dear Customer,

Please read this user information carefully.

Pay particular attention to the section "Safety" on the first Info pages.

Please keep this user information in a safe place for later reference.

Pass it on to any future owners of the unit.



The warning triangle and /or signal words (**Warning!**, **Caution!**, **Important!**) emphasise information which is important for your safety or for the unit's functional reliability. It is imperative that this information is observed.



1. This symbol guides you step by step through the operation of the appliance.

2. ...



Next to this symbol you will find additional information and practical tips on using the appliance.



Tips and information on economical and environmentally responsible use of the unit are identified with the clover leaf.

For any faults which occur, this user information contains information on how to remedy these faults yourself. See the section "What to do if ..."

Printed on recycled paper.

Thinking ecologically means acting ecologically.

Contents

Operating Instructions	6
Safety	6
Disposal	8
Environmental tips	9
Unit description	10
Front view	10
Drawer for detergent and care agent	10
Control panel	11
Program Selector	11
Additional program buttons	13
Consumption values	14
Running time display	14
What does "UPDATE" mean?	15
Water Protection Aqua Control	15
Before the First Wash	15
Prepare washing cycle	16
Sort washing and prepare	16
Types of Washing and Care Symbols	17
Washing Detergents and Care Agents	18
Which washing detergent and care agent?	18
How much washing detergent and care agent?	18
Water softener	18
Run a washing cycle	19
Brief instructions	19
Setting the Washing Program	20
Changing the spin speed/Selecting the rinse hold function	21
Set the Delay Timer/Soaking Duration	21
Opening and Closing the Filling Door	22
Add the washing	22
Add Washing Detergent/Care Agent	23
Starting the washing program	24
Completion of the Washing Program	25
Wash cycle complete/removing the washing	26

Program tables	28
Washing	28
Separate conditioning/starching/impregnation	29
Separate rinse	29
Separate spin	29
Cleaning and Care	30
Control panel	30
Detergent Drawer	30
Washing Drum	31
Main door	31
What to do if	32
Remedying Faults	32
If the washing results are not satisfactory	36
Carrying out emergency drainage	37
Drain pump	38
Additional rinsing cycle (RINSE+)	40
Water Cooling	41
Additional Rinse and Water Cooling	41
Child Safety Feature	42
Installation and connection instructions	43
Installation Safety Precautions	43
Installation of the appliance	44
Transporting the appliance	44
Remove transport packaging	44
Prepare the installation place	46
Installation on a concrete base	46
Installation on vibrating floors	46
Compensate for floor unevenness	47

Electrical connection	48
Water connection	48
Permissible water pressure	48
Water inflow	49
Water drain	50
Delivery heads over 1m	50
Technical data	51
Dimensions	51
Warranty conditions / Customer service centres	52
Index	58
Service	59

Operating Instructions



Safety

The safety aspects of AEG electrical appliances comply with accepted technical standards and the German Appliance Safety Law. However, as manufacturers we regard it as our responsibility to inform you about the following safety instructions.

Before Using for the First Time

- Refer to the "Installation and Connection Instructions" further on in this user information.
- If units are delivered in the winter months at minus temperatures: Store the washing machine at room temperature for a few hours before putting it into operation.

Correct Use

- The washing machine is only intended for washing normal domestic washing. If the appliance is used for a wrong purpose or wrongly operated, the manufacturer cannot assume any liability for any damages.
- Additions or modifications to the washing machine are strictly forbidden due to safety reasons.
- Use only detergent which is suitable for washing machines. Refer to the detergent manufacturer's instructions.
- The washing must not contain any flammable solvents. Also bear this in mind when washing pre-cleaned washing.
- Do not use the washing machine for dry-cleaning.
- Dyes /dye-removing agents may only be used in the washing machine if the manufacturer expressly permits use of these products. We cannot accept liability for any damage.
- Use only water from the water mains. Use rain water or service water only if it meets the requirements defined in DIN 1986 and DIN 1988.
- Frost damage is not covered by the warranty! If the washing machine is in a room subject to possible frost hazards, emergency emptying must be carried out if there is a risk of frost (see the Section "Carrying out emergency emptying").

Safety of Children and Infirm Persons

- Packaging materials (e.g. films, polystyrene) can be dangerous for children. Risk of suffocation! Keep packaging away from children.
- The appliance is not intended for use by young children or infirm persons without supervision.
- Children frequently cannot recognise hazards involved in handling electrical appliances. Therefore, ensure that they are properly supervised during operation and never allow children to play with the washing machine – there is a risk that they can lock themselves inside it.
- Ensure that children or small animals do not climb into the washing machine's drum.
- When disposing of washing machines pull out the mains plug, destroy the door lock, cut off the electrical supply lead and dispose of the plug and remaining cable. This means that playing children cannot shut themselves in and cannot encounter a potentially lethal hazard.

General Safety

- Repairs to the washing machine may only be carried out by qualified specialists. Incorrect repairs may result in significant risk to the user. If repairs are necessary, consult our customer service or your specialist dealer.
- Never use the washing machine if the mains cable is damaged or the control panel, work surface or base panel area are so badly damaged that the interior of the unit is openly accessible.
- Switch off the washing machine before carrying out cleaning, care and maintenance work. Also pull the mains plug out of the socket or, – if it is permanently connected, – switch off the circuit breaker at the household power distribution box or completely remove the screw-in fuse.
- If operation is stopped, disconnect the appliance from the mains supply and shut off the tap.
- Never pull the cable to remove the plug from the socket. Always pull the plug itself.
- Multiple connectors, couplings and extension cables must not be used. **There is a risk of fire with overheating!**
- Do not spray down the washing machine with a water jet. Risk of electric shock!
- The glass in the door becomes hot in the case of wash programmes with high temperatures. Do not touch!

- Allow the washing solution to cool before carrying out an emergency emptying operation or cleaning the drain pump.
- Small animals can chew the power cables and water hoses. Risk of electric shock and danger of water damage! Keep small animals away from the washing machine.



Disposal

Disposing of the Packaging Material!

Dispose of the packaging of your washing machine correctly. All packaging materials used are environmentally-compatible and recyclable.

- Plastic parts are identified with internationally standardised abbreviations:
 - >PE< for polyethylene, e.g. packing films.
 - >PS< for polystyrene, e.g. cushion parts (always CFC-free)
 - >POM< for polyoxymethylene, e.g. plastic clips.
- Cardboard packaging is manufactured from recycled paper and should be deposited in the waste paper collection for recycling.

Disposing of your old appliance!

When you put your unit out of operation one day, please bring it to your nearest recycling centre or to your dealer.



Environmental tips

- A pre-wash cycle is not necessary in the case of washing which is not excessively dirt. This saves detergent, water and time (and is gentle on the environment.)
- If the indicated load capacities are taken full advantage of, the washing machine is especially efficient.
- For small loads, use only one half to one third of the recommended detergent quantity.
- Suitable pre-treatment enables marks and limited amounts of dirt to be removed. You can then wash at a lower temperature.
- Wash slightly to normally dirty cottons with the energy-saving program.
- There is often no need for the softener. Try it once! If you use a drier, your washing will become soft and fluffy even without a softener.
- In the case of medium to high water hardness (hardness range runs to upwards, see "Detergent and care agents"), you should use a water softener. The detergent can then always be metered for hardness range I (= soft).

Unit description

Front view

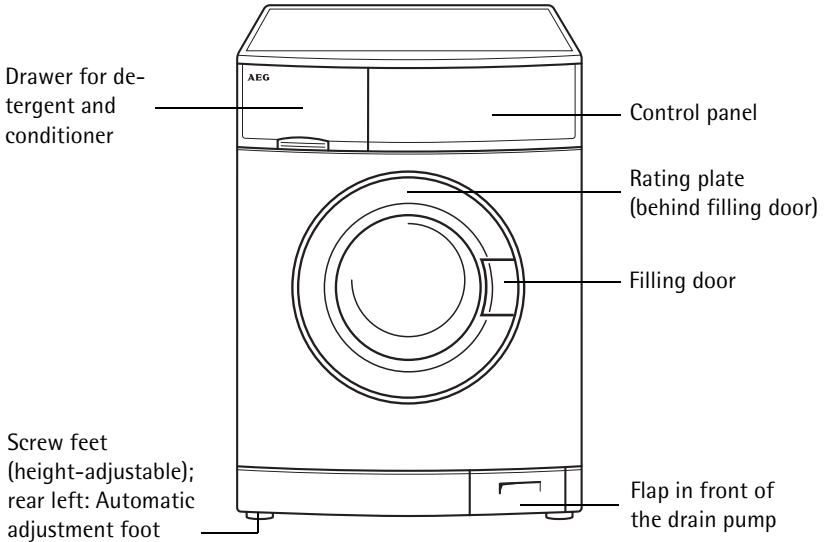

Drawer for detergent and care agent

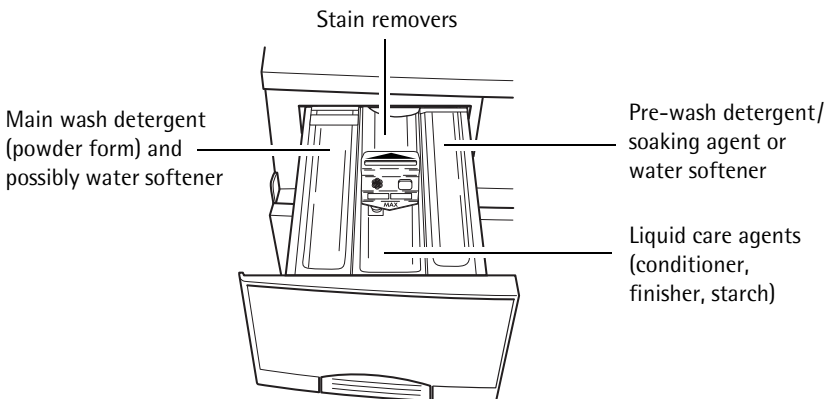

Control panel

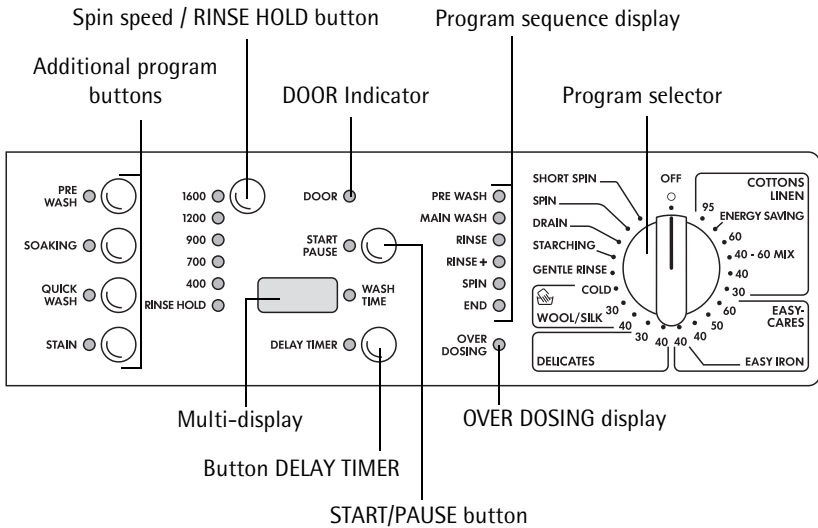

Program Selector

The program selector determines the type of washing cycle (e.g. water level, drum movement, number of rinses, spin speed) according to the type of garments being washed, and also the washing solution.

OFF

Switches off the washing machine. All other positions are "switched on".

To amend programme settings selected by mistake, turn the selector to OFF. This restores the original settings.

COTTONS/LINEN

Main washing cycle Cottons/Linen at 30 °C to 95 °C.



ENERGY SAVING position: Energy-saving program at approx. 67 °C for slightly to normally dirty cottons, extended washing time (cannot be combined with QUICK WASH and STAIN).

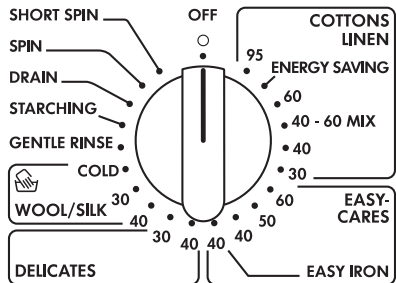

40 - 60 MIX position: Programme for coloureds when various wash temperatures are indicated for the items to be washed.

Various items which according to the care labels are usually washed separately at 40 °C or 60 °C can be washed together in the 40°-60° MIX programme. In this way the drum capacity is better used and energy is saved as a result.

Due to the extended wash time a wash result the same as that as for a normal 60°C programme is achieved.

EASY-CARES

Main washing cycle for easy-care textiles (mixed fabrics) at 40 °C to 60 °C.

EASY IRON position: Main washing cycle at 40 °C for easy-care textiles which, with the aid of this program, only have to be either gently ironed or not ironed at all.

DELICATES

Main washing cycle for delicates at 30 °C or 40 °C.

WOOL/SILK/ (Handwash)

Main washing cycle (cold up to 40 °C) for machine-washable woollens and for hand-washable wool textile and silk with the care symbol  (handwash).

GENTLE RINSE

Separate gentle rinse e.g. for rinsing hand-washed textiles (2 rinses, liquid care agent from rinsing compartment  is added, short spin).

STARCHING

Separate starching, separate conditioner, separate impregnation of damp washing (1 rinse, liquid care agent from the rinsing compartment  is added, spin).

PUMP OUT

Pumping off the water after a rinse hold (without spin).



RINSE HOLD means: The washing remains lying in the last rinsing water. It is not spun.

SPIN

Pumping off the water after a rinse hold and spin, or separate spin of hand-washed cottons/linen.

SHORT SPIN

Pumping off the water after a rinse hold and short spin or separate short spin of sensitive textiles (easy-care washing, delicates, woollens).

Additional program buttons

The additional program buttons are for adapting the washing program to the dirtiness of the washing. Additional programs are not required for washing which is not excessively dirty. Various functions can be combined with each other, depending on the program.

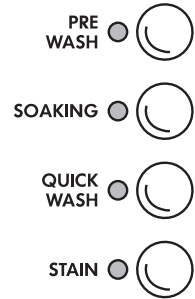

PRE WASH

Cold pre wash before the main washing cycle which follows on automatically; with intermediate spin at COTTONS/LINEN and EASY CARES, without intermediate spin for DELICATES.

SOAKING

Approx. 1 hour at 30 °C or 40 °C, depending on the set program. Can be extended by max. 19 hours with the button DELAY TIMER. This is followed by the main washing cycle.

QUICK WASH

Shorter washing cycle for slightly dirty washing.

STAIN

For treating very dirty washing or stained washing. (In-wash stain treatment is added during the program on a time-optimized basis)



With the WOOL/SILK/ (Hand wash) program, it is not possible to select the additional programs (any buttons pressed have no effect).

Consumption values

The values for selected programs in the following tables were determined under normal conditions. However, there is a helpful orientation aid for domestic operation.

Program selector / temperature	Load in kg	Water in Litres	Energy in kWh
COTTONS/LINEN 95	6	50	2,05
COTTONS/LINEN 60 ¹⁾	6	49	1,14
COTTONS/LINEN 40	6	58	0,66
EASY CARES 40	3	52	0,55
DELICATES 30	3	56	0,36
WOOL/SILK  (handwash) 30	2	42	0,18

1) Note: Program setting for a test in accordance with EN 60 456. The consumption values deviate from the stated values depending on the water pressure, water hardness, water inlet temperature, room temperature, washing type and quantity, the detergent used, fluctuations in the mains voltage and the selected additional functions.

Running time display



The durations of the washing programs depend on the washing habits and ambient conditions at the installation location. E. g. the washing type, washing quantity, type of detergent, water temperature and room temperature etc. can influence the duration of the washing program.

The washing machine saves from each program the running times of the last wash cycles and calculates from them the average running time for a washing cycle. This average running time is shown by the Multi-display during the next wash.

After several washes, the running time shown in the multi display is thereby adapted to the usual washing practice and the ambient conditions at the installation location.



What does "UPDATE" mean?

Your washing machine's washing programs are controlled by software. New types of textiles or new detergents may require new washing programs in the future. In most cases, the software can be adapted to this. For further information on the "update", please consult the Customer Service. You can also enquire about the costs for an "update" with your Customer Service.

Water Protection Aqua Control

In the event of damage to the supply hose, the system blocks the further supply of water to the unit directly at the water tap. If water escapes elsewhere, the drainage pump automatically pumps off – even if the unit is switched off. The washing machine merely has to be connected to the electricity mains.

Before the First Wash

-  Carry out a washing operation without washing (COTTONS 95 °C, with half the quantity of washing powder/liquid). This removes residues left over from production on the drum and solution container.

Prepare washing cycle

Sort washing and prepare

- Sort the washing according to the care symbol and type (see "Washing types and care codes").
- Empty all pockets.
- Remove metal objects (paper clips, safety pins etc.).
- To prevent damage to the washing and tangled washing: Close zip fasteners, button bed and pillow covers closed, tie up loose strings e.g. of aprons.
- Turn articles with double layered textiles inside out (sleeping bags, anoraks etc.).
- In the case of knitted coloured textiles and also with wool and textiles with jewelry attached: turn inside out.
- Wash small and sensitive items (e.g. baby socks, tights and stockings, bras etc.) in a washing net, a cushion with a zip fastener or in larger socks.
- Handle curtains with particular care. Metal rollers or burred, plastic rollers must be removed or tied into a net or bag. We cannot accept liability for damage.
- Coloureds and white items must not be washed together in a washing cycle. This could discolour white washing or turn it grey.
- There is often excess dye in new, coloured items. It is best to wash such items separately the first time.
- Mix small and large items. This improves the washing effect and the washing is more favourably distributed during spinning.
- Fluff washing before placing into the washing machine.
- Do not place folded washing into the drum.
- Pay attention to the care instruction "wash separately" and "wash separately several times".

Types of Washing and Care Symbols

Care symbols help you to choose the correct wash programme. Washing should be sorted by type, and according to their care symbols. The temperature indicated on the care symbol is the maximum wash temperature.

Cottons

Cotton and linen items with this care symbol are not sensitive to machine washing or high temperatures. The COTTONS/LINEN programme is suitable for this type of washing.

Linen

Cotton and linen items with this care symbol are not sensitive to machine washing. The COTTONS/LINEN programme is suitable for this type of washing.

Easy-Cares

Materials such as fine cotton, wool-blend fabrics, viscose, and synthetics with these care symbols require gentler treatment. The EASY-CARES/EASY IRON programmes are suitable for this type of washing.

Delicates

Materials such as layered fibres, microfibres, viscose, synthetics, and net curtains with this care symbol require particularly careful treatment. The DELICATES programme is suitable for this type of washing.

Wool/silk and especially sensitive materials

Woollens, wool blends and silk with these care symbols are particularly sensitive to machine washing. The WOOL/SILK  (Handwash) programme is suitable for this type of washing.

Important! Materials with the care symbol  (Not machine-washable!) should not be washed in the washing machine.

Washing Detergents and Care Agents

Which washing detergent and care agent?

Use only washing detergents and care agents which are suitable for use in washing machines. Always follow the manufacturer's instructions.

How much washing detergent and care agent?

The amount to be used depends on:

- the dirtiness of the washing
- the hardness category of the mains water supply
- the filling quantity



If the detergent manufacturer gives no details of the dosing quantities for minimum loads, add one third less for half loads and, in the case of very small loads and for EASY IRON, only half the amount of detergent recommended for a full load.

Refer to the detergent/care agent manufacturer's instructions on use and dosage.

Water softener

For medium to high water hardness (hardness class II upwards), you should use softener. Refer to the manufacturer's instructions. Then always add the appropriate amount of detergent for hardness class I (= soft). The responsible water works will provide information on the local water hardness.



Since the water softener is rinsed in before the main detergent (water pre-softening), 80% of the stated quantity of softener shown on the package is sufficient.

Water hardness details

Hardness class	Water hardness in °dH (German hardness scale)	Water hardness in mmol (millimol per litre)
I - soft	0 - 7	to 1.3
II - medium hard	7 - 14	1.3 - 2.5
III - hard	14 - 21	2.5 - 3.8
IV - very hard	greater than 21	greater than 3.8

Run a washing cycle

Brief instructions

A washing cycle is run in the following steps:

1. Set the correct washing program:
 - Set the program and temperature with the program selector.
 - Set any additional program(s).
2. If necessary, change the spin speed/select RINSE HOLD.
3. Set the DELAY TIMER if necessary.
4. Open the filling door and fill with washing.
5. Close the filling door.
6. Add the detergent/care agent.
7. Start the washing program with the START/PAUSE button.

After the washing program ends:

Important! If the washing cycle ended with a rinse hold, perform PUMP OUT), SPIN or SHORT SPIN before opening the filling door.

8. Open the filling door and remove the washing.
9. Switch off the washing machine: Set the program selector to OFF.

Setting the Washing Program

i For the suitable program, the correct temperature and possible additional programs for the particular washing type, refer to the "Program tables".

1. Set the program selector to the required washing program with the required temperature.

The probable duration of the set program in minutes is shown in the multi display.

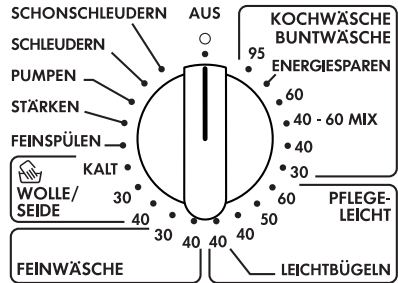

2. If necessary, select additional program(s):
The display of the selected auxiliary program lights up.

- To change the selection, press another button.
- To deselect, press the button again.



Changing the spin speed/Selecting the rinse hold function

If required, change the spin speed for the final spin/select rinse hold:

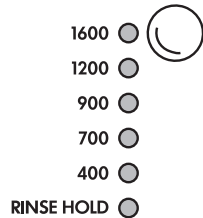

Changing the spin speed



Press the spin speed/RINSE HOLD button as often as necessary, until the indicator for the desired spin speed is illuminated.



If you do not change the spin speed, the final spin will be adjusted automatically depending on the type of wash cycle:

- COTTONS/LINEN 1600 revolutions per minute
- EASY CARES/EASY IRON 1200 revolutions per minute
- DELICATES 1200 revolutions per minute
- WOOL/SILK / (Hand Wash) 1200 revolutions per minute

The speed for the intermediate spin cycle is dependent on the wash cycle selected and cannot be altered.

Selecting the rinse hold function



Press the spin speed/RINSE HOLD button as often as necessary, until the RINSE HOLD indicator is illuminated.



If RINSE HOLD is selected, the washing will remain in the final rinse water and will not be spun.

Set the Delay Timer/Soaking Duration

Delay Timer

The button DELAY TIMER allows the start of a washing program to be advanced by 1 to a maximum of 19 hours.



To do this, press the button DELAY TIMER as often as necessary until the required start delay is shown in the multidisplay, e.g. *12h* for a program start delay of 12 hours.

If *19h* is shown and you press again the run time of the set washing program appears (display in minutes, e.g. *120*).

In this state, the delay timer is not set.

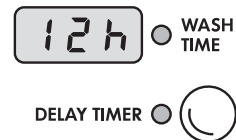

Soaking Duration

With the SOAKING button pressed, you can extend the soaking duration by 1 to a maximum of 19 hours.

i Without delay timer, the soaking duration is approx. 1 hour.

Opening and Closing the Filling Door

☞ Open: Pull on the handle of the filling door.

☞ Close: Press the filling door firmly closed.

DOOR 

The indicators DOOR and START/PAUSE show whether the door can be opened while the appliance is switched on:

START/PAUSE 

Indicator DOOR	Indicator START/PAUSE	Opening door possible?
Glowes green	Flashes red	Yes
Glowes red	Glowes red	No ¹⁾

1) The filling door is locked because of a high water level or a high temperature.

i If

- the error code **E₁** is shown in the multi-display and
- the indicators PRE WASH, RINSE and RINSE+ flash

you tried to start a washing program without first closing the filling door properly. In this case push the door shut firmly and restart the washing program.

Add the washing

i For the maximum filling quantities, see the "Program tables". See "Sort and prepare washing" for information on correctly preparing the washing.

- ☞** 1. Sort and prepare the washing according to type.
2. Open the filling door: Pull on the handle of the filling door.
3. Fill with washing.

Important! When closing the door, make sure no items of washing get stuck! This could damage textiles and the unit.

4. Close the filling door securely.

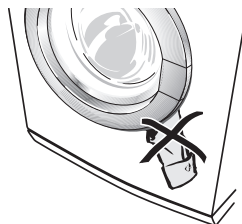

Add Washing Detergent/Care Agent

i Refer to the information on washing detergents and care agents, see section "Washing Detergents and Care Agents".

- 1.** Open the washing detergent drawer: grip inside the flap on the drawer at the bottom (1) and pull out the drawer as far as it will go (2).

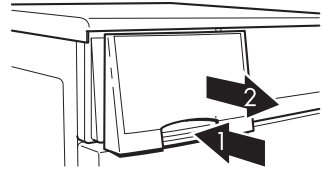

- 2.** Fill with washing detergent/ care agent

Compartment for in-wash stain treatment

Compartment for main washing powder

(If you use water softener and need the right compartment for the pre-wash/soaking agent, add the water softener to the main washing detergent in the left compartment.)

Compartment for liquid care agent

(Conditioner, finisher, starch)

Attention! Do not fill the compartment above the MAX mark. If necessary, dilute viscous agent up to the MAX mark, and dissolve powder starch.

Note: It is normal for a small amount of water to be left in the compartment for liquid care agent; this will not affect the wash results.

Compartment for pre-wash agent/soaking agent (only for additional programs PRE WASH and SOAKING or for water softener

- 3.** Push the drawer fully in.

i If using liquid detergent / tablets

Add liquid detergent / tablets in the quantity recommended by the washing detergent manufacturer. Add liquid detergent with dosage containers provided by the detergent manufacturer.

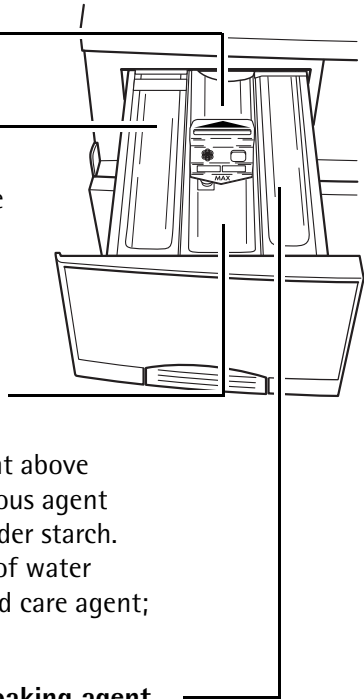

Starting the washing program

1. Check that the water tap is open.
2. Start the washing program:
Press the START/PAUSE button
The washing program is started or starts at the end of the time delay set.



- i** The door is not correctly closed if, when the button START/PAUSE is pressed,
- the error code **E d** is shown in the multi-display and
 - the indicators PRE WASH, RINSE and RINSE+ flash
- In this case, press the door firmly closed and again press the START/PAUSE button.

If the delay timer has been set:

The start time delay set on the time delay counts down; the time remaining until the program starts is displayed in the multi-display (in hours remaining, e.g. **5h**). During this time you can add washing and change or stop the delay timer.

- Load the washing: Press the START/PAUSE button. The door can be opened. Then close the door and press the START/PAUSE button again.
- Changing or stopping delay timer: Press the DELAY TIMER button repeatedly until the desired time is displayed. When the program duration is displayed (display in minutes e. g. **120**) the washing program starts without delay.

Completion of the Washing Program

Program sequence display

Before the start, the program steps to be carried out are indicated by the Program sequence display. The current program step is displayed during the wash program.

PRE WASH ●
 MAIN WASH ●
 RINSE ●
 RINSE + ●
 SPIN ●
 END ●

Multi-display

The expected remaining run time (in minutes) is shown in the multi-display until the program ends.

 ● WASH TIME



With automatic program adaptation by the controller of the washing machine (quantity of washing, type of washing, imbalance recognition, special rinse etc.), it is possible to stop or correct the counting of the remaining run time.

Change the Spin Speed

During the wash program, the spin speed can still be changed or RINSE HOLD can be set.

Other settings cannot be changed.

Abort program



To prematurely abort the washing program, turn the program selector to OFF.



With the button START/PAUSE, it is possible at any time to interrupt the washing program and to continue it again by pressing the button again.

Wash cycle complete/removing the washing

When a wash programme is complete:

When a wash programme has come to an end, END is illuminated in the programme progress display.

 **3.** Open the door.

As soon as the DOOR indicator shows green, the door can be opened.

4. Remove the washing.

5. Turn the programme selector to OFF .

6. After the wash, pull out the detergent drawer slightly to allow it to dry. Leave the door slightly open to allow the inside of the washing machine to air.

If RINSE HOLD was selected:

If a programme finishes with RINSE HOLD, the indicator next to the START/PAUSE button will flash.

 **1.** After a rinse hold, the water must first be drained:

– Press either the START/PAUSE button

(the water is drained and the washing is spun in accordance with the finished programme; the number of spin revolutions can still be altered during the spin cycle using the spin revolution/RINSE HOLD button),

or

– Turn the programme selector to OFF, and then to PUMP, and press the START/PAUSE button

(the water will be drained without the spin cycle taking place),

or

– Turn the programme selector to OFF, and then to SPIN or SHORT SPIN, and press the START/PAUSE button

(the water will be drained and the washing is spun or briefly spun).

After this programme cycle is complete, the END indicator illuminates. The wash programme is complete.

2. Open the door and remove the washing.

3. Turn the programme selector to OFF.

If the EASY IRON programme was selected:

With EASY IRON, a crease prevention cycle of approx. 30 minutes takes place after the programme is complete. The multi-display shows the time remaining (e.g. 1 minute) and the END indicator illuminates.

You can remove the washing at any time during the crease prevention cycle.

1. To do this, press the START/PAUSE button.
The door can now be opened and the washing removed.
2. Finally, turn the programme selector to OFF.
The wash programme is complete.



If the display OVER DOSING lights up, too much washing detergent was used in the washing program just ended. During the next wash, pay attention to the dosing information of the washing detergent manufacturer and pay attention to the filling quantity!











OVER
DOSING 

Attention! If the washing machine is not used for a long time: Close the water tap and disconnect the washing machine from the electricity mains. (The Aqua Control water protection does not function if the power supply is interrupted).

Program tables

Washing

Not all possible settings are listed below, only those which are normal and appropriate in everyday use.

Type of washing; care symbol	Max. load ¹⁾ (dry weight) ²⁾	Program selector; temperature [°C]	Possible additional programs
Cottons 	6 kg	COTTONS/LINEN 95	PRE WASH SOAKING QUICK WASH STAIN)
Energy-saving program: Cottons 	6 kg	COTTONS/LINEN ENERGY SAVING	PRE WASH SOAKING
Linen ³⁾  	6 kg	COTTONS/LINEN 30, 40, 60	PRE WASH SOAKING QUICK WASH STAIN ⁴⁾
		COTTONS/LINEN 40 - 60 MIX	
Easy Cares  	3 kg	EASY CARES 40, 50, 60	PRE WASH SOAKING QUICK WASH STAIN
	1 kg	EASY IRON ⁵⁾ 40	
Delicates 	3 kg (or 15-20m ² curtains)	DELICATES 30, 40	PRE WASH SOAKING QUICK WASH STAIN ⁴⁾
Woolens/Silk /Hand Wash   	2 kg	 WOOL / SILK COLD, 30, 40	

- 1) The load amount inquiry operates in accordance with the EN 60456 standard load.
- 2) A 10 litre bucket holds approximately 2.5 kg of dry washing (cotton).
- 3) Programme settings for testing in accordance with or in support of EN 60 456 and IEC 60 456 are described in the chapter "Consumption Values".
- 4) In the case of the STAINS, a minimum temperature of 40°C is required for the stain remover to become effective.
- 5) Creases in the washing are only largely prevented if the filling quantity of 1 kg is maintained. 5 to 7 easy-care men's shirts are equivalent to approximately 1 kg of dry washing.

Separate conditioning/starching/impregnation

Type of washing	Max. Filling quantity (dry weight)	Program selector
Cottons/Linen	6 kg	STARCHING

Separate rinse

Type of washing	Max. Filling quantity (dry weight)	Program selector
Cottons/Linen	6 kg	GENTLE RINSE
Easy Cares	3 kg	
Delicates	3 kg	
Woolens/Silk/ Hand Wash	2 kg	

Separate spin

Type of washing	Max. Filling quantity (dry weight)	Program selector
Cottons/Linen	6 kg	SPIN
Easy Cares	3 kg	SHORT SPIN
Delicates	3 kg	
Woolens/Silk/ Hand Wash	2 kg	

Cleaning and Care

Control panel

Important! Do not use any furniture cleaning agents or aggressive cleaning agents in order to clean panel and control parts.

- ☞ Wipe control panels with a damp cloth. When doing so, use warm water.

Detergent Drawer

The detergent drawer should be cleaned from time to time.

- ☞ 1. Pull the detergent drawer out as far as it will go.
- 2. Remove the detergent drawer by pulling sharply.
- 3. Take the conditioner insert out of the middle compartment.
- 4. Clean the conditioner insert under running water.

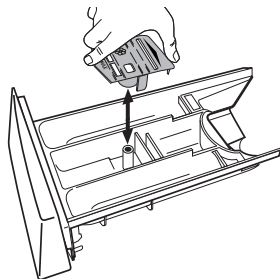

- 5. Clean the compartments with warm water from the rear side. It is best to use a flat brush.

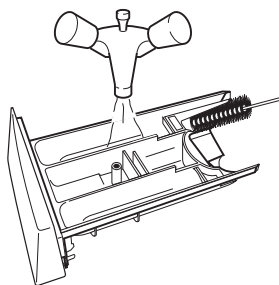

- 6. Push on the conditioner insert as far as it will go so that it is securely in place.

7. Use a brush to clean the entire rinsing-in section of the washing machine, particularly also the nozzles on the top side of the rinsing-in chamber.

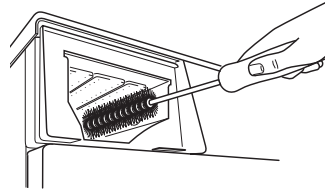

8. Set the detergent drawer into the guide tracks and push in.

Washing Drum

The washing drum is made of stainless steel. Rusting foreign bodies in the washing can cause rust deposits on the drum.

Important! Do not clean the stainless steel drum with decalcifying agents containing acids, scouring agents containing chlorine or iron, or steel wool. Our Customer Service can provide suitable agents.

- ☞ Remove any rust deposits on the drum using a stainless steel cleaning agent.

Main door

- ☞ Check on a regular basis to see if deposits or foreign objects are present in or at the rubber sleeve behind the door, and remove.

What to do if ...

Remedying Faults

In the event of a fault, try to solve the problem yourself with the aid of the information provided here. If you call Customer Service to deal with one of the faults listed here or to remedy an operating fault, the customer service technician's visit will not be free of charge, even during the warranty period.

- If the fault code **E1**, **E2** or **E4** is shown in the multidisplay, you may be able to remedy the fault yourself (see Faults Table below). When you have remedied the fault, press the START/PAUSE button.



- With all other displayed faults (**E** plus number or letter): switch appliance off and on again. Reset the wash programme and press the START/PAUSE button.

If the fault code is displayed again, please contact the Customer Service department quoting the fault code.

Problem	Possible Cause	Remedy
The washing machine does not work.	The mains plug is not plugged in.	Plug in the mains plug.
	The fuse of the building's wiring is not in order.	Replace the fuse.
	The filling door is not correctly closed.	Close the filling door; The lock must engage audibly.
	Button START/PAUSE not pressed for long enough.	Press the button START/PAUSE until the program starts.
The filling door cannot be closed.	The child safety feature is set	Cancel the child safety feature (see Section "Child Safety Feature").
Error code E4 is shown in the multi-display. The indicators PRE WASH, RINSE and RINSE+ flash.	The filling door is not correctly closed.	Close the filling door correctly. Restart the program.

Problem	Possible Cause	Remedy
Water is not running. Error code E1 is shown in the multi-display.	Water tap closed.	Open the water tap.
	Filter in screw connection of the intake hose blocked.	Close the water tap. Unscrew the hose from the tap, remove the sieve and clean under running water
	Water tap is blocked with limescale or is faulty.	Check water tap and have it repaired if necessary.
The washing machine vibrates during operation or it is on an uneven surface.	The transport packaging has not been removed.	Remove transport packaging according to the installation and connection instructions.
	The height-adjustable screw feet are not correctly set.	Adjust the feet in accordance with the installation and connection instructions.
	There is not much washing in the drum (e.g. only one dressing gown).	This does not impair the function.
	The water could not be completely pumped off before spinning because The drainage hose is bent or The drain pump is blocked.	Check the laying of the drainage hose and eliminate the bend if necessary, or clean the drain pump and, if required, remove foreign bodies from the pump housing.
The washing solution of the main wash froths up a lot.	Too much detergent was probably used.	Meter the detergent exactly in accordance with the manufacturer's information.

Problem	Possible Cause	Remedy
Water runs out under the washing machine.	The screw connection on the intake hose is leaky.	Tighten the intake hose screw connection.
	The drainage hose is leaky.	Check the drainage hose and replace it if necessary.
	The drain pump cover is not correctly closed.	Close cover correctly.
	Washing is caught in the filling door.	Abort program, remove washing from the filling door. Restart the program.
	The emergency drainage hose is not correctly closed or leaks.	Close the emergency drainage hose correctly (see the section "Carry out emergency drainage"). Call Customer Service if the emergency drainage hose leaks.
The drain pump for the washing machine runs constantly - even when the appliance is switched off.	The Aqua Control anti-flood system has been activated.	Turn off the tap, then remove the plug from the mains and inform Customer Service.
Conditioner was not washed in, compartment  for care agents is filled with water.	The conditioner insert in the compartment for care agents is not correctly attached or is blocked.	Clean the detergent drawer, attach the conditioner insert securely.
Washing heavily creased.	Too much washing probably put in.	Pay attention to the maximum filling quantity (see Program tables). In the case of easy-care textiles, select the program EASY IRON.
The washing has not been spun as dry as usual.	The washing was not able to be distributed evenly in the drum prior to spinning.	Always load the drum as full as possible with a combination of large and small items.

Problem	Possible Cause	Remedy
Washing is not well spun. Residual water is still visible in the drum. Error code E2 is shown in the multi-display.	Drainage hose bent.	Remove the bend.
	Maximum pumping height (discharge height 1 m from the unit's standing surface) is exceeded.	Contact your customer service. For pumping heights over 1m he can offer you a conversion kit as a special accessory.
	Drain pump is blocked.	Switch off the unit and pull out the mains plug. Clean the drain pump.
	If a siphon is connected: Siphon blocked.	Clean the siphon.
The main door cannot be opened while the appliance is turned on.	The filling door is locked because of a high water level or a high temperature. The DOOR indicator lights red.	Wait until the DOOR indicator lights up green. Should it nevertheless be necessary to open the main door: Turn the programme knob to OFF; turn the programme knob to PUMP OUT. Press button START/PAUSE. The main door can be opened after the water has been pumped out.
	Power failure! (All indicators have gone off.) For safety reasons the door remains locked for 4 to 10 minutes.	If water can be seen through the window in the door, first carry out emergency emptying (see section "Carrying out Emergency Emptying Operation"). After approx. 4 to 10 minutes the door can be opened again by pulling the handle.
Remnants of detergent are building up in the detergent drawer.	Water tap not fully opened.	Open the water tap fully.
	Filter in the screw connection of the intake hose on the water tap or on the unit is blocked.	Close the water tap. Unscrew the inlet hose from the water tap and from the unit and clean the filter.

Problem	Possible Cause	Remedy
The rinsing water is murky.	The cause is probably a detergent with a high silicate content.	No negative influence on the rinsing result. Use liquid detergent if necessary.
The corresponding indicator does not light up when one of the additional program buttons is pressed.	The selected additional program cannot be combined with the set program.	Make another selection.

If the washing results are not satisfactory

If the washing has turned grey and if limescale is deposited in the drum, then

- Too little detergent was used.
- The wrong detergent was used.
- Special soiling was not pre-treated.
- Program or temperature not set correctly.
- If multi-component detergents are used, the individual components were not used in the correct ratio.

If there are still grey spots on the washing,

- Washing soiled with ointments, grease or oils was washed with too little detergent.
- Too lower temperature was used for washing.
- A frequent cause is that softener - particularly that in concentrated form - has reached the washing. Wash out such spots quickly and use the softener concerned carefully.

If at the end of the last rinse foam is still visible

- Modern detergents can also cause foam in the last rinse. However, the washing is still sufficiently rinsed.

If there are white remnants on the washing

- These are insoluble components of modern detergents. They are not the result of an insufficient rinsing effect. Shake or brush out the washing. In future, perhaps you should turn the washing inside out before washing it. Examine your choice of detergent and if necessary use liquid detergent.

Carrying out emergency drainage

- If the washing machine no longer pumps off the washing solution, emergency drainage must be performed.
- If the washing machine is in a room where there is a risk of frost, emergency drainage must be performed if there is a possibility of frost.

In addition: unscrew the inlet hose from the water tap and place it on the floor. Empty the drainage hose.



Warning! Switch off the washing machine before performing emergency drainage and pull out the mains plug.

Caution! The washing solution escaping from the emergency drainage hose may be hot. There is a risk of scalding! Allow the washing solution to cool down before performing emergency drainage.

1. Place a flat collecting vessel in order to collect the washing solution which is draining off.
2. Fold open the flap in the right section of the base outwards and pull it off.

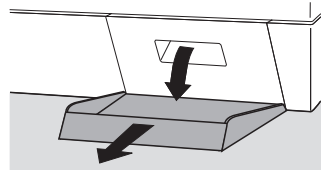

3. Remove the emergency drainage hose from its holder.

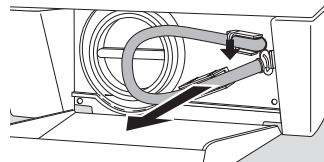

4. Place the container under the hose.
5. Detach the plug of the emergency drainage hose by turning it anticlockwise and pull it out.

The washing solution runs out. Depending on the amount of solution, it may be necessary to empty the collecting vessel several times. To do this, close the emergency drainage hose temporarily with the plug.

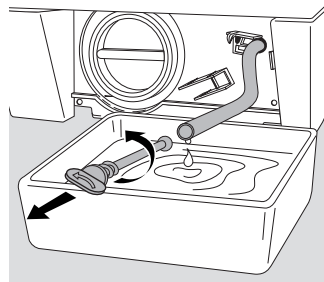

When the water is completely drained:

6. Push the plug securely into the emergency drainage hose and turn it clockwise to secure it.
7. Replace the emergency drainage hose in its holder.
8. Put on the flap and close.

Drain pump

The drain pump is maintenance free. The cover of the drain pump must only be opened in the event of a malfunction when no more water is being pumped out, e.g. if the pump is blocked.

Before loading the machine, please always ensure that there are no foreign objects left in the pockets or in between the items to be washed. Paper clips, nails etc. which may find their way into the washing machine along with the washing will remain in the drain pump housing.

To restart the drain pump when it is blocked, please proceed as follows:



Warning! Switch off the washing machine and remove the mains plug before cleaning the drain pump!

1. First carry out an emergency emptying procedure (see section "Carrying out emergency emptying").
2. Place a cloth on the floor in front of the cover of the drain pump. Residual water may run out.
3. Unscrew the drain pump cover in an anti-clockwise direction and pull it out.

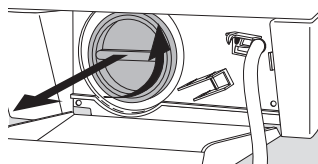

4. Remove any foreign objects and fabric lint from the pump housing.

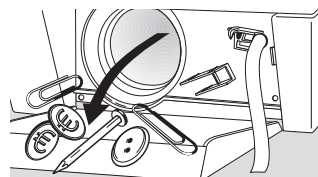

5. Replace the pump cover. Laterally insert the webs on the cover into the guide slots and screw on the cover in a clockwise direction.

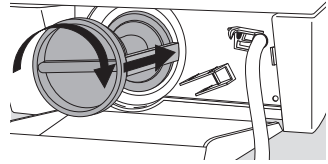

6. Close the emergency emptying hose and place it in the holder.

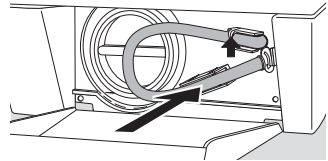

7. Close the flap.

Additional rinsing cycle (RINSE+)

The washing machine is set for extremely economical water consumption. However, for persons who suffer from allergies, it can be helpful to rinse with more water.



If this function is set, an additional rinsing cycle is run with the programs COTTONS/LINEN, EASY CARES/EASY IRON and DELICATES. No additional rinse is set when the unit is delivered.

Set additional rinse:



1. Turn program selector to SHORT SPIN.
2. Keep the button SOAKING pressed for at least 5 seconds. After the button has been pressed for 5 seconds, RINSE+ flashes on the program sequence display for 5 seconds.
3. While RINSE+ is flashing, release the button SOAKING. After the flashing stops, the additional rinse cycle is set. It is active until it is cancelled again. If an additional rinse cycle is set, the display RINSE+ lights up on the program sequence display before the program start and during the additional rinse cycle.
4. If you wish to check whether the additional rinse function is enabled:
 - Turn program selector to SHORT SPIN.
 - Briefly press the button SOAKING.

The additional rinse cycle is set when RINSE+ flashes on the program sequence display.

Cancel additional rinse:



1. Turn program selector to SHORT SPIN.
2. Keep the button SOAKING pressed for at least 5 seconds. RINSE+ flashes on the program sequence display as soon as the button is pressed. After 5 seconds, RINSE+ stops flashing and lights up constantly for a further 5 seconds.
3. While RINSE+ lights up constantly, release the button SOAKING. After RINSE+ has stopped lighting up, the additional rinse cycle is cancelled.



An additional rinse cycle increases water consumption and the program duration.

Water Cooling

It may be necessary to cool down the washing solution before pumping it out in order to prevent thermal damage to plastic drainage pipes.



The washing solution is cooled down before pumping out at the end of the washing cycle (by the addition of cold water).
(This setting is only effective with COTTONS/LINEN with a temperature of over 40 °C.)

As supplied from the factory, the water cooling function is not enabled.

Enabling the water cooling function:



1. Turn program selector to SHORT SPIN.
2. Keep the button PRE-WASH pressed for at least 5 seconds.
After the button has been pressed for 5 seconds, MAIN WASH flashes on the program sequence display for 5 seconds.
3. While MAIN WASH is flashing, release the button PRE WASH.
After the flashing has stopped, the solution cooling is set. It is active until it is cancelled again.
4. If you wish to check whether the water cooling function is enabled:
 - Turn program selector to SHORT SPIN.
 - Briefly press the button PRE-WASH.
 If MAIN WASH flashes on the program sequence display, the solution cooling is set.

Disabling the water cooling function:



1. Turn program selector to SHORT SPIN.
2. Keep the button PRE-WASH pressed for at least 5 seconds.
As soon as the button is pressed, MAIN WASH flashes on the program sequence display. After 5 seconds, MAIN WASH stops flashing and lights up constantly for 5 seconds.
3. While MAIN WASH lights up constantly release the button PRE-WASH.
After MAIN WASH has stopped lighting up, the solution cooling is cancelled.



Solution cooling increases water consumption and the program duration.

Additional Rinse and Water Cooling

The additional rinse cycle and the solution cooling can be combined. Setting as under "Additional rinsing cycle" and "Water cooling".

Child Safety Feature

If the child safety feature is set, the filling door can no longer be closed and no washing program can be started.

Setting the child safety feature



Use a coin to turn the rotary knob on the inside of the filling door clockwise as far as it will go.

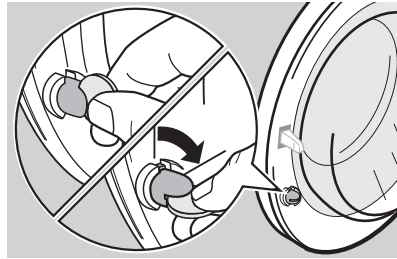

Warning! The rotary knob must not be in a vertical position after adjustment, otherwise the child safety feature is not active. The rotary knob must project as shown in the diagram

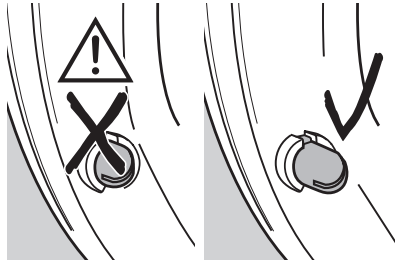

Cancelling the child safety feature



Turn the rotary knob anticlockwise as far as it will go.

Installation and connection instructions

Installation Safety Precautions

- Do not tilt the washing machine onto its front or onto its right side (viewed from the front). Electronic components can get wet.
- Check the washing machine for transport damages. A damaged unit must never be put into operation under any circumstances. In the event of damage, please contact your supplier.
- Ensure that all parts of the transport safeguard are removed and that the unit is splash protected, see "Removing transport safeguard". Otherwise, the units or neighbouring furniture can be damaged when spinning.
- Always insert the plug into a correctly installed earthed socket.
- In the case of permanent connection: A permanent connection may only be made by an authorised specialist.
- Before putting the machine into operation, ensure that the mains voltage and current type shown on the unit's rating plate correspond with those at the place where the machine is being installed. The fuse rating is also found on the rating plate.
- Should work be carried out on the water supply installations in order to allow the machine to be connected properly to the water supply, this work must be carried out by an authorised installer.
- Should work be carried out on the mains supply in order to allow the machine to be connected properly to the electricity supply, this work must be carried out by an authorised electrician.
- The mains lead may only be replaced by the customer service or by an authorised electrician.

Installation of the appliance

i Washing machines with curved panels are not suitable for installing under units.

Transporting the appliance

- Do not place the washing machine on its front or on its right side (viewed from the front). Otherwise, electrical components can get wet.
- Never transport the unit without the transport safeguard. Do not remove the transport safeguard until the appliance is at the installation location. Transporting the unit without the transport safeguard can damage it.
- Lift the appliance neither by an open filling door nor by the base.

When transporting the unit with a sack trolley:

- Attach the sack trolley only at the side. The sack trolley shovel must not be longer than 24 cm, otherwise the float switch can be destroyed.

Remove transport packaging

Important! It is essential to remove the transport packaging before putting the appliance into operation. Keep all parts of the transport packaging in a safe place for future use.

- 1.** Open both hose holders on the appliance's rear side and remove the hoses and mains cable.

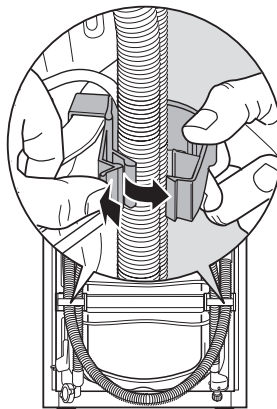

2. Pull both hose holders off the appliance with a strong pull.

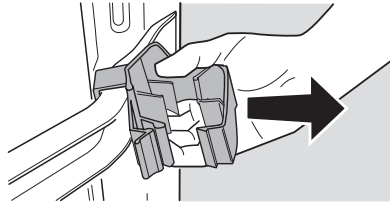

The special spanner (A) and the caps (B) (2 each) and (C) (1 each) are supplied with it.

3. Remove the screw D, including the compression spring with the special spanner A.

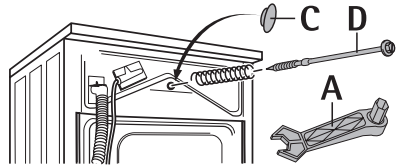

4. Cover the hole with the cap C.

Important! When fitting the plastic caps, press until they snap into the rear panel securely.

5. Remove the two screws (E) with the special spanner (A).

6. Remove the 4 screws (F).

7. Remove the transit bar (G).

8. Screw the 4 screws (F) back in for safe keeping.

9. Close the 2 large holes with the caps (B).

Important! When fitting the plastic caps, press until they snap into the rear panel securely.

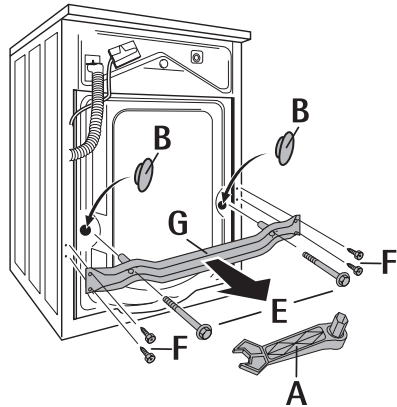

Prepare the installation place

- The installation surface must be clean and dry, free of floor polish residues and other greasy coatings so that the unit does not slip away. Do not use lubricants as a sliding aid.
- Installation on a high-veil carpet or floor tiles with soft sponge backs is not recommended because the standing safety of the appliance is then no longer ensured.
- By installation surfaces with small-format tiles, lay a conventional rubber mat underneath.
- Minor unevenness of the floor surface should never be levelled out by laying pieces of wood, card or similar materials, but rather should always be compensated for by adjusting the screw feet.
- If, for space reasons, it is not possible to avoid setting up the unit directly next to a gas or coal-fired cooker: install a thermal insulation panel between the cooker and washing machine (85 x 57cm) which must have an aluminium film on the side against the cooker.
- The washing machine must not be set up in a room where there is a danger of frost. Frost hazard!
- Flexible feed and drain tubings may not be crinkled or squeezed.

Installation on a concrete base

If the unit is set up on a concrete base, for safety reasons it is essential to fit stand plates in which the washing machine is adjusted. The stand plates are available from Customer Service under the spare parts number 645 425 058.

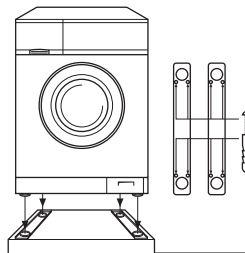

Installation on vibrating floors

Where the floor vibrates, particularly in the case of wooden beam floors with pliable boards, securely screw a water-resistant wooden panel at least 15mm thick onto at least 2 floor planks. If possible, set up the unit in the corner of a room, as the wooden floor is optimally restrained there and is therefore least likely to be subject to resonance vibrations.

Compensate for floor unevenness

i **Automatic adjustment foot:** The rear left foot of your washing machine is designed as a spring leg. This means that it guarantees that your unit will stand securely even at high spin speeds.

If, nevertheless, the washing machine is unstable during spinning, please proceed as follows:

- 1.** Set the three adjusted feet at the nominal value of 10 mm. To do this, use the supplied special spanner to remove the transport safeguard.

If the automatically adjusting foot does not reach the floor:

- 2.** Automatic adjustment foot (rear left) manually for extending the required dimension.
- 3.** If necessary, check the setting with a spirit level.

Caution! Never use wood, card or similar underlays to level out minor floor unevenness. Instead, always adjust the adjustment foot.

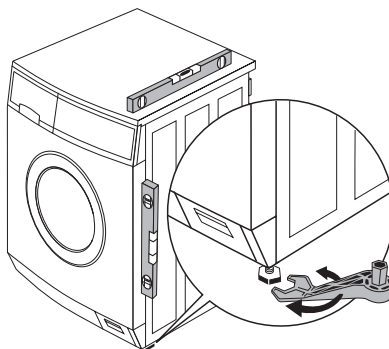

Electrical connection

Details of the mains voltage, current type and required fuses can be found on the rating plate. The rating plate is located at the top above the filling door.

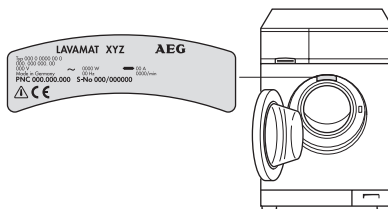

For permanent electrical connection within the electrical circuit, provisions must be made which allow for electrical disconnection of the appliance from the mains with a contact opening of at least 3 mm at all poles. Suitable devices include circuit breakers, fuses (threaded fuses must be entirely removed from the socket), ground fault circuit interrupters and contactors. Permanent connection may only be carried out by an authorised electrician.

- CE** This appliance complies with the following EC directives:
- The "Low Voltage Directive" 72/23/EU with changes
 - The "EMC Directive" 89/336/EU with changes

Water connection

i The washing machine has safety features which prevent back-contamination of the drinking water and which conform to the national regulations of the water authorities (e.g. for Germany: DVGW guidelines). This means that additional protective measures in the installation are not necessary.

Important!

- Units for connecting to cold water must not be connected to hot water.
- Use only new hose sets for the connection.

Permissible water pressure

The water pressure must be at least 1 bar (= 10 N/cm² = 0.1 Mpa), maximum 10 bar = 100 N/cm² = 1 Mpa).

- If more than 10 bar: Connect a pressure-reduction valve upstream.
- If less than 1 bar: Unscrew the inlet hose on the unit side at the solenoid intake valve and remove the flow regulator (to do this, remove the filter with pointed pliers and take out the rubber washer behind). Replace the filter.

Water inflow

A pressure hose 1.5m in length is supplied.

If a longer inflow hose is required, only a VDE-approved, complete set of hoses with fitted hose screw connections offered by our Customer Service is permissible.

- Hose sets in lengths of 2.2m, 3.5m and 5m are available for washing machines without Aqua-Control.
- Hose sets in lengths of 2.0m, 2.9m and 3.9m are available for washing machines with Aqua-Control.

Caution! Never cut into pieces in order to extend the hoses!



Sealing rings are supplied either in the plastic nuts of the hose screw connection or in the enclosed pack. Do not use other seals!



1. Connect the hose with the angled connection to the machine.

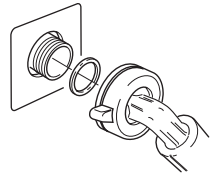

Caution!

- Do not lay the infeed hose vertically downwards. Instead, turn it to the right or left as shown in the diagram.
- Tighten the hose connection only by hand.

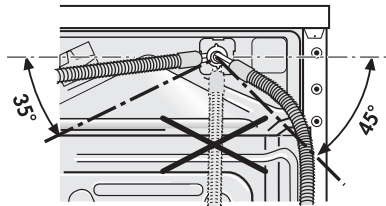

2. Connect the hose with the straight connection to a water tap with a R 3/4 (inch) screw thread.

Caution! Only tighten the screw connection manually.

3. By slowly opening the water tap before putting the washing machine into operation, check that the connection is free of leaks.

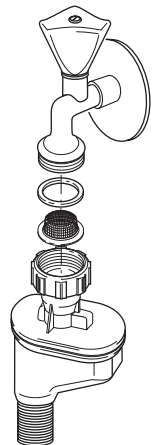

Water drain

The drainage hose can either be connected to a siphon or hung in a wash basin or discharge basin or a bath tub.

Only original hoses may be used for extensions (max. 3m laid on the floor and then up to 80cm high). Customer Service stocks drainage hoses in lengths of 2.7 and 4m.

Important! It is essential to lay the drainage hose without kinks.

Water drain-off inside a siphon

The grommet on the hose end fits all standard siphon types.



Secure the connection between the grommet and siphon with a hose clamp.

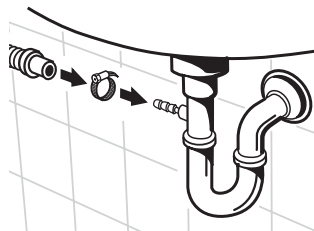

Water drain-off inside a basin

Important!

- Small basins are not suitable for drainage. Water could overflow!
- The end of the drainage hose must not be submerged in the pumped-out water. Otherwise, the water could be sucked back into the unit.
- When hanging in a wash basin or a bath tub, the drainage hose must be secured with the supplied attachable bend to prevent it slipping. The back-surge force of the escaping water could otherwise force the hose out of the basin.

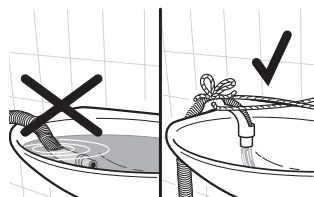

Tie the bend to the tap or the wall using a piece of string.

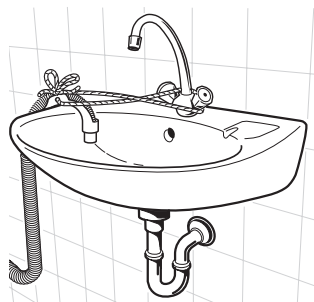

Delivery heads over 1m

To pump off the washing / rinsing solution, every washing machine has a drain pump which carries liquids up to a height of 1m via the drainage hose, calculated from the machine's standing surface.

Please contact Customer Service for delivery heads of over 1m.

Technical data

Adjustment possibility
Filling quantity (program-dependent)
Area of use
Drum speed, spinning
Water pressure

Approx. +10 / -5mm
max. 6kg
Domestic
See rating plate
1-10 bar (= 10 - 100 N/cm²
= 0.1 - 1.0 Mpa)

Dimensions

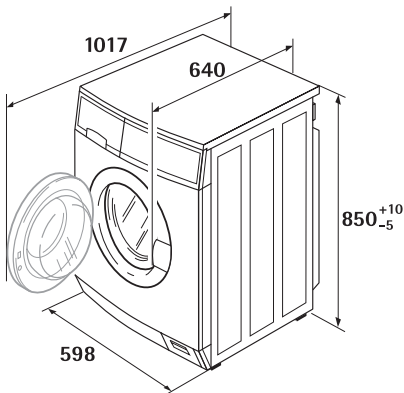

(dimensions in mm)

Warranty conditions / Customer service centres

Weitere Kundendienststellen im Ausland

In diesen Ländern gelten die Garantiebedingungen der örtlichen Partner. Diese können dort eingesehen werden.

Further after-sales service agencies overseas

In these countries our AEG agents' own guarantee conditions are applicable. Please obtain further details direct.

Autres agences étrangères assurant le service après-vente

Dans ces pays, les conditions de garantie des concessionnaires de la région sont valables. Vous pouvez les consulter sur place.

Otros puntos de Postventa en el extranjero

En estos países rigen las condiciones de nuestros representantes locales. las cuales pueden ser consultadas allí mismo.

Ulteriori uffici del servizio tecnico assistenza clienti all'estero

In questi paesi sono valide le condizioni di garanzia dei partner locali. Queste condizioni possono essere esaminate sul luogo.

Serviços de assistência técnica no estrangeiro

Nestes países são válidas as condições de garantia dos concessionários locais, podendo aí ser consultadas.

További vevőszolgálati irodák külföldön

Ezekben az országokban a mi AEG vevőszolgálatainknál saját jótállási feltételek alkalmazhatók. A további adatokat kérjük közvetlenül szerezzék be.

Servisne službe

Na garancijskem listu boste našli seznam pooblaščenih servisnih služb AEG.

U.A.E. Abu Dhabi

Universal Trading Company
P.O. Box 43 99
Tel.: 335331

Jordan

Jordan Household
Supply Co. Ltd.
P.O. Box 3/68
Amman/Tel.: 69 70 50

Malta

ITC
International Trading Company
White House Building
Mountbatte Street
Blata L-Bajda/Tel.: 220644

Egypt

Middle East Commercial
Center
P.O. Box 19
Kairo-Heliopolis
Tel.: 29917/31634

Kanada

EURO-LINE Appliances
2150 Winston PARK Drive 20
Oakville, Ontario L6H 5V1
Tel.: 905 829 3980
Fax: 905 829 3985

Mauritius

Happy World Centre Ltd.
P.O. 7 54
1 Chausee Street
Port Louis
Tel.: 25355

Australia

ANDI-Co Pty. Ltd
9 Kingston Town Close
Oakleigh VIC 3166
Tel.: (03) 9569 1235
Fax: (03) 9569 1450

Bahrain/Arabian Gulf

A.A. Zayani & Sons
P.O. Box 9 32
Bahrain
Tel.: 261060

Bulgaria

Electrolux Bulgaria E.O.O.D.
91 Levski Blvd.
1000 Sofia
Tel.: 2 806676
Fax. 2 980 5276

Cyprus

Hadjikyrlakos & Sons Ltd.
Prodromou 121
P.O. Box 21587
Nicosia 1511
Service Telephones:
Nicosia 02 481226
Limassol 05 562182
Larnaca 04 633929
Paphos 06 932 699

Estonia

Electrolux Estonia Ltd.
Mustamäe tee 24
EE0006 Tallinn
Tel.: (372) 6 650 090
Fax: (372) 6 650 092

Hongkong

Wo Kee Services Ltd.
585-609 Castle Peak Road
Kwai Chung N.T.
Hongkong
Tel.: 2494 4000

Korea (South)

Core Incorp.
3/F Chewoo Bldg.
200 Nonhyun-Dong
Kangnam-Ku
Seoul
Telefon 82 2 549 89 61

Croatia

Electrolux D.O.O.
Suplova 7
10000 Zagreb
Tel.: 1 61 19512
Fax: 1 61 19513

Kuwait/Arabian Gulf

Ali Al-Ghanim Est.
P.O. Box 10 83
Tel.: 5322463
Fax: 5242114

Lebanon

Adib & Assaferi
P.O. Box 539
Tripoli

Latavia

Electrolux Latavia Ltd.
Terlaton Street 42/44
1011 Riga
Tel.: 371 2 297821
Fax: 371 2 821286

Lthuania

Electrolux Lthuania
Verkui 29
2600 Vilnius
Tel.: 372 272 3326
Fax: 372 272 3366

Namibia

AEG NAMIBIA (PTY) LIM-
ITED-Jeppe Street
Northern Industrial Area
Windhoek
Tel.: (061) 21-6082/4
Fax: (061) 217838

New Zealand

Euro-Life New Zealand Ltd.
Privat Bag
58 Symonds Street
Auckland
Tel.: (09) 525 2222

Nouvelle Caledonie

Socometra N.C.
B.P. 483
Nouman
Tel.: 275444

Oman

Moshin Haider Darwish
P.O. Box 1 35
Muscat
Tel.: 703743

Poland

Electrolux Poland Sp. zo.o.
ul. Domaniewska 41
02-034 Warszawa
tel.: 022 874 33 33
fax: 022 874 33 00

Russia

Electrolux Russia Ltd.
16 Olympiysky prospekt
129090 Moscow
Tel.: (095) 937 7837
Fax: (095) 926 5513

Israel

Electricity & Electronic
Services-Evis LTD.
19 Hataasia st.
Raanana,
Industrial area 43654
Tel: 972-9-7448118
Fax: 972-9-7603618
e-mail: evis@evis.co.il

Malaysia

Arzbergh Engineering
No. 49A/B, Jalan Petaling
Utama 7
4600 Petaling Jaya
Tel.: 3 795 1084
Fax: 3 795 1082

Saudi Arabia

Alia Trading Corporation
P.O. Box 4101
King Abdul Aziz Street
Riyadh
Tel.: 4645977
Al Nahas Est.
Musaidia Market I
P.O. Box 1 15 29
Jeddah
Tel.: 6606852

Japan

Electrolux Japan Ltd.
Domestic Appliances Depart-
ment
Maruzen Showa Warehouse
Building
Tookai 4-5-12, Ota-ku
143-006 Tokyo
Tel.: 0120-13-7117
Fax: 03-3790-5257

Singapore

Arzbergh Engineering
19 Tanglin Road 06-07
Singapore 247909
Tel.: 65 7356572
Fax: 7351124

Slovenia

Electrolux Slovenia D.O.O.
Traska Ul. 132
1000 Ljubljana
Tel.: 61 1234 137
Fax: 61 1234 238

Thailand

OLYMPIA Thai Ltd.
44 Ratchadapisek Road
10320 Bangkok
Tel.: 2 513 6111
Fax: 2 513 2574

Slovakia Rep.

Electrolux Slovakia S.R.O.
Seberiniho 1
821 03 Bratislava
Tel.: 02 4333 4322, 4355
Fax: 02 4333 6976

South Africa

AEG (Pty) Ltd.
55, 12th Road
P.O. Box 1 02 64
Kew/Johannesburg 2000
Tel.: 8069111

Hungary

Electrolux Lehel KFT
(AEG Div)
Erzsébet Királyné útja 87.
1142 Budapest
Tel.: 00361/467-3200

USA

ANDI Co. Appl. Inc. East
65 Campus Plaza
Edison, New Jersey 0837
USA/Tel.: (201) 2258839

Syria

Masri & Shami
P.O. Box 24 96
Damascus
Tel.: 214080

Index

A

- Abort program 25
- Aqua Control 15, 27, 34
- Automatic adjustment foot 10, 47

C

- Care agent 10, 18, 23
- Child safety feature 32, 42
- Conditioner 10, 12, 19, 23, 29
- Cottons 11, 17, 28, 29
- Curtains 16, 28
- Customer Service 15, 31, 32, 59

D

- Delay timer 11, 21, 24
- Delicates 12, 17, 28
- Detergent 10, 18, 19, 23
- Detergent drawer 10, 23
- Door opening 22, 35
- Drain
 - water 26
- Drain pump 10, 38
- Draining 26

E

- Easy iron 12, 26, 28, 34
- Easy-cares 12, 17, 28
- Emergency drainage 37
- Energy saving 11, 28

G

- Gentle rinse 12, 29

H

- Hand wash 12, 28, 29

I

- In-wash stain treatment 10, 23

L

- Linen 11, 17, 28, 29
- Load 14

M

- Multi-display 11, 21, 24, 25, 32, 59

O

- Open the door 26
- Over-dosed 27

P

- Pre wash 13, 20, 23, 28

- Pre-wash detergent 10, 23
- Program sequence display 11, 25
- Pump out 12

Q

- Quick wash 13, 20, 28

R

- Rating plate 10, 48, 59
- Rinse + 40
- Rinse hold 12, 21, 26
- Risk of frost 6, 37
- Run time 14, 25

S

- Silk 12, 17
- Soaking 13, 20, 22, 23, 28
- Soaking agent 23
- Spin 12, 19, 21, 25, 29
- Spots 28
- Stain 9, 10, 13, 20, 36
- Starching 12, 29

U

- Update 15

W

- Warranty 6, 32, 52
- Washing
 - coloureds 16
 - lightly soiled 9
 - normally dirty 9
- Washing powder 10, 18
- Water
 - hardness 9, 18
 - pump off 12
 - softener 9, 10, 18, 23
- Water cooling 41
- Wool 17
- Woollens 12, 28, 29
 - hand-washable 12, 28

 **From the Electrolux Group. The world's No. 1 choice.**

The Electrolux Group is the world's largest producer of powered appliances for kitchen, cleaning and outdoor use. More than 55 million Electrolux Group products (such as refrigerators, cookers, washing machines, vacuum cleaners, chain saws and lawn mowers) are sold each year to a value of approx. USD 14 billion in more than 150 countries around the world.

AEG Hausgeräte GmbH
Postfach 1036
D-90327 Nürnberg

<http://www.aeg.hausgeraete.de>

© Copyright by AEG

822 943 636-01-150503-01

Subject to change without notice

Free Manuals Download Website

<http://myh66.com>

<http://usermanuals.us>

<http://www.somanuals.com>

<http://www.4manuals.cc>

<http://www.manual-lib.com>

<http://www.404manual.com>

<http://www.luxmanual.com>

<http://aubethermostatmanual.com>

Golf course search by state

<http://golfingnear.com>

Email search by domain

<http://emailbydomain.com>

Auto manuals search

<http://auto.somanuals.com>

TV manuals search

<http://tv.somanuals.com>