

LAVATHERM 57320 electronic

Condenser Dryer

Operating Instructions



Dear customer,

Please read these operating instructions through carefully.

Please make sure you read the safety instructions on the first pages of these operating instructions! Keep the operating instructions for future reference. Pass them on to any future owners.



With the warning triangle and/or by means of key words (**Danger!**, **Caution!**, **Attention!**), information is emphasized which is important for your safety or the correct functioning of the appliance. It is essential that this information is observed.



This symbol guides you step by step when operating the appliance.



Next to this symbol you receive additional information and practical tips on using the appliance.



Tips and information about the economical and environmentally friendly use of the machine are marked with the clover.

- These operating instructions contain information about how to independently solve any problems which may arise. See "Something not working".

Printed on environmentally friendly paper ...
Whoever thinks ecologically also acts ecologically.

Content

Important Safety Information	5
General Information	7
Disposal	8
Packaging	8
Environmental protection tips	9
The key features of your appliance	11
Description of the appliance	12
Front view	12
The program selector	14
Before using the appliance for the first time	14
Brief instructions	15
Drying	16
Prepare the laundry	16
Open the door	16
Load the laundry	16
Closing the door	16
Select the drying program	16
Start the drying program	18
Removing laundry or loading laundry when necessary	18
End of the drying process	18
Removing the laundry	18
Empty the water reservoir	19
Cleaning the door seal	19
Clean the fluff filter	20
Cleaning the condenser	21
Switch-off the dryer	21
Program tables	22
A small glossary of textile information	24
Care symbols	24

Cleaning and maintenance	25
Cleaning the condenser	25
Cleaning the filter area	25
Cleaning the drum	26
Cleaning the panel and operating parts	26
Cleaning the door seal	26
Something not working?	27
Replace the interior light	29
Door Reversal Instructions	30
Technical data	32
Installation and electrical connection	32
Information for the electrician	32
Special accessories	33
Drainage kit	33
Stacking kit	33
Content	34
Service	35



Important Safety Information

The safety of AEG electrical appliances complies with the established technical principles and statutory equipment safety regulations. Nevertheless, as manufacturer we have to draw your attention to the following safety instructions.

General safety

- Repairs of the dryer may be carried out only by trained personnel. Incompetently carried out repairs can entail considerable hazards for the user. Please get in touch with our customer service or with an authorised AEG dealer when repair is necessary.
- Before commencing operation please make sure that the nominal voltage and type of supply specified on the type plate of the appliance correspond to the actual nominal voltage and supply type at the place of utilisation. The fuse rating is also specified on the type plate.
- Never operate the dryer when the mains cable is damaged or when the operator control mask, work plate or base shrouding are damaged such that there is direct access to the interior of the appliance.
- Switch-off the dryer before carrying out any cleaning, care and maintenance tasks! You are quite safe if you disconnect the mains plug from the power outlet or – if the electrical connection is permanent – if you switch-off the circuit breaker in the fusebox or screw the fuse cartridge right out of its holder.
- Never pull on the cable to disconnect the mains plug from the power outlet. Always grasp and pull-out the plug.
- Don't lean on the opened door; this could make the appliance fall over.
- Don't use a water jet to spray-down the appliance. Danger of electric shock!
- The covering hood for the filament lamp bulb for drum illumination must be screwed-on.
- When closing the door, please check that the washing is not caught in it.
- If you interrupt the drying process to take out laundry, bear in mind that the laundry and the drum could be hot.
- Adaptors and extension cables must not be used. There is risk of fire because of overheating!

Safety of children

- Children are often not aware of the dangers involved when handling electrical equipment. Therefore provide the necessary supervision of children when operating the appliance and do not let children play with the dryer – there is a danger that children could become trapped inside the appliance.
- Packaging parts (e.g. films, styropore) can be dangerous for children. Danger of suffocation! Keep packaging parts out of reach of children.
- Make sure that children or small animals do not climb into the drum of the dryer. For this purpose keep the door of the dryer closed when the appliance is not in use.

Utilisation in accordance with the intended purpose

- Conversions or modifications of the dryer are forbidden for safety reasons.
- Use the dryer only to dry ordinary household laundry! The manufacturer accepts no liability for any damage resulting from incorrect operation or utilisation for an unintended purpose.
- Dry only laundry which has been washed in water. In particular, textiles which have been treated with inflammable cleaning agents and solvents (petrol-ether, alcohol, stain remover and similar materials) must not be dried in the dryer. Danger of fire! Explosion hazard!
- Laundry items containing sponge rubber or rubber-like materials must not be dried in the dryer. Danger of fire!
- Washing that is in poor condition (heavily worn) and items with loose fillings (cushions) that could break open must not be dried or refreshed. There is a risk of fire!
- Washing with rigid components (foot mats) will cover the air slots; the slots will also be covered if the drum is overfilled. Observe the maximum load of 5 kg. There is a risk of overheating which could cause a fire!
- Only dry washing that does not contain any explosive objects (fire lighters, spray cans). There is a risk of fire or an explosion!
- Clean the fluff filter after each drying procedure.
- Clean the condenser regularly.
- In the case of washer / dryer tower combinations, do not place any objects on the dryer during use as they could drop down.

Installation and connection

- Check the dryer for Transportation damage. Never connect-up a damaged appliance! Contact your supplier if the appliance is damaged.
- If the tumble dryer has to be carried, first remove the plinth!
- Do not set-up the dryer in frost-endangered rooms!
- Set-up the dryer horizontal!
- If the dryer is placed adjacent to a gas, coal or electric cooking stove, interpose a thermally insulating non-combustible plate between the dryer and the stove (dimensions: 85x57,5cm).
- Do not place the dryer on high-pile carpet floors!
This would hinder air circulation at the ventilation slots!
- The electric power plug connector of the appliance must remain accessible even after erection.
- Check that the tumble dryer is not standing on the mains cable.
- The technical conditions of the electric power supply company for making fixed connections of electrical appliances to the mains require that such connections may only be made by an authorised electrician.

i General Information

- Starched washing leaves traces of starch on the drum and therefore should not be placed in the tumble dryer.
- If you exceed the maximum load stipulated in the program table your washing is more likely to get creased! For very delicate fabrics you should only fill in 1.5kg washing at the most.
- For your information: 70 per cent of fabric wear is caused by being worn, 20 per cent by washing and only 10 per cent by being dried in a tumble dryer. As the fabric is worn down, fluff gathers in the fluff filter. When using a tumble dryer, only approx. 0.03g fluff per kilogramme washing is produced.



Disposal

Packaging

Dispose of the packaging material!

Dispose of the packaging material of your tumble dryer correctly. All the packaging materials used are harmless to the environment and can be recycled.

- Plastic parts are marked with standard international abbreviations:
 - >PE< for polyethylene, e.g. sheet wrapping material
 - >PS< for polystyrene, e.g. padding material (always CFC-free)
 - >POM< for polyoxymethylene, e.g. plastic clips

Cardboard packaging is manufactured from recycled paper and should be deposited in the waste paper collection for recycling.

Disposal of the old appliance!

When you eventually stop using your tumble dryer please bring it to the nearest recycling centre or to your dealer who will take it back for a small fee.



Warning! When disposing of the tumble dryer, pull out the plug, cut off the flex, dispose of the plug and remaining flex and destroy the door lock. This hinders children from locking themselves in and endangering their lives.

The materials can be recycled in accordance with their markings. Standard tools (crosshead screwdriver, hammer) are sufficient to dismantle the old appliance.



Environmental protection tips

- Your laundry will become light and soft in the tumble dryer even without a fabric softening agent.
- Loosen your laundry before loading it into the dryer. This helps to prevent lengthy running times and creasing. Ensure your laundry is well spun.
- Remove as much water as possible from the washing before drying! This is based on the principle: the better you spin the washing before drying the more economical the dryer is.

In the following table we give an overview of specific electric consumption data depending on the spinning speed. This information is valid for 5kg laundry dried with the program COTTONS CUPBOARD DRY (KATOEN KAST-DROOG):

Spinning/wringing out:			Drying cycle:	
Revolutions per minute	Residual dampness		Time required in minutes	Energy requirement in kWh
	in litres	in %		
800	3.5	70	90	3.5
1000	3.0	59	85	3.0
1200	2.7	53	75	2.7
1400	2.5	50	70	2.6
1600	2.2	44	65	2.5



- Never obstruct the ventilation slits at the base of the dryer!
- Ensure that the room is well ventilated!
- Observe the maximum load instructions. Whenever possible, dry full loads.

- Select the appropriate drying program for the type and quantity of laundry. The dryer will then operate as economically as possible. Some typical consumption values:

Drying program	Fill weight in kg	Duration in Minutes	Power consumption in kWh
COTTONS CUPBOARD DRY ¹ (KATOEN KAST-DROOG)	5	90	3.5
COTTONS HAND IRON ¹ (KATOEN STRIJK-DROOG )	5	70	2.8
DELICATES CUPBOARD DRY ² (MENGWEEFSELS KAST-DROOG)	2.5	35	1.3

1) spun at 800 revolutions per minute

2) spun at 1000 revolutions per minute

If the amount of laundry is not enough for a particular degree of drying (e.g. HAND IRON; STRIJK-DROOG ) , you should dry it in stages for best economy: Fill the dryer and select the program HAND IRON (STRIJK-DROOG ) ; after the end of this program take out your laundry for ironing. Finally dry the remaining laundry with the program CUPBOARD DRY (KAST-DROOG).

- Only use the SPECIAL CARE (LAGE TEMP.) button for loads up to 2.5kg.
- Clean the fluff filter after every drying program!
- Empty the water reservoir after every drying process!

You can use the collected condensed water as distilled water in the household, but first pour it through a paper filter bag.



Caution! The condensed water is not suitable for drinking or for use with foodstuffs.

- Clean the condenser regularly!

The dryer will operate more economical ly if you clean the condenser regularly.

The key features of your appliance

- **Program** or **time setting** via the program selector
- **SPECIAL CARE (LAGE TEMP.) button** for gentle drying of sensitive fabrics
- **AUDIBLE SIGNAL (ZOEMER)** can be selected in addition; an intermittent audible signal is sounded after the end of the program.
- **Program run display**

Description of the appliance

Front view

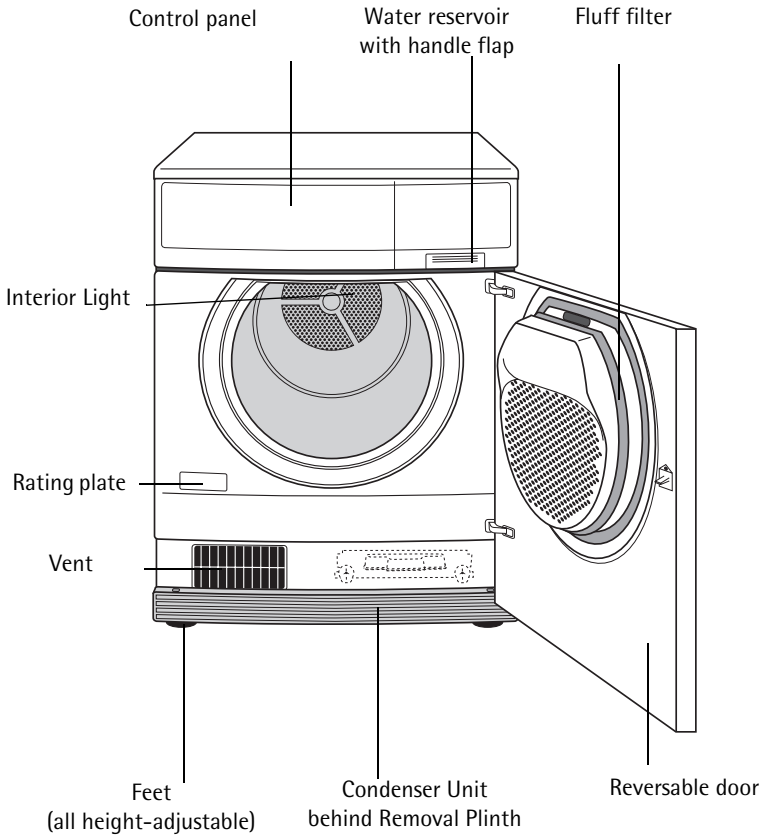

Control panel

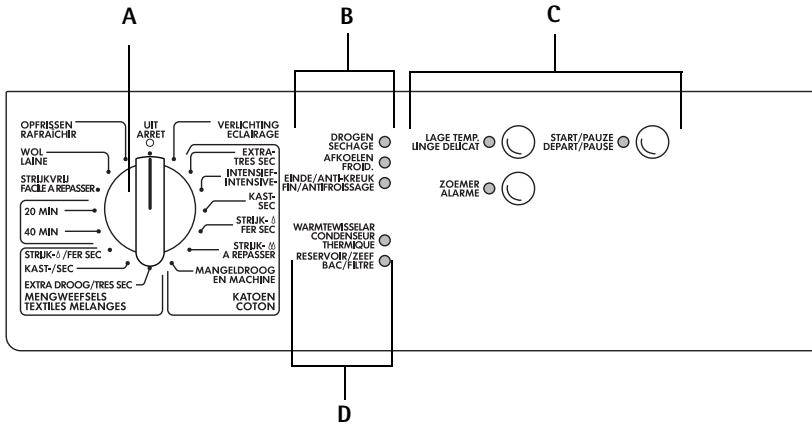

A Program selector: for setting the drying program

B Program run display: The currently running phase of the drying process is indicated.

C Buttons and display block

- SPECIAL CARE (LAGE TEMP.) button: For sensitive fabrics
- AUDIBLE SIGNAL (ZOEMER) button: When switched-on, an audible signal is sounded at the end of the drying program; then take-out the laundry
- START/PAUSE (START/PAUZE) button: To start or interrupt a programme.

D Instructions for the user:

- Indication CONDENSER (WARMTEWISSELMER): Clean the condenser (in the base of the appliance)!
- EMPTY WATER/CLEAN FILTER (RESERVOIR/ZEEF) display: Empty the water reservoir, clean the fluff filter!

The program selector

- **OFF (UIT):**
The tumble dryer is switched off.
- **LIGHT (VERLICHTING):**
The drum light switches on when the door is opened.
- **Program group COTTON (KATOEN):**
Programs for drying cotton and linen fabrics;
maximum load 5 kg.
- **Program group DELICATES (MENGWEEFSELS):**
Programs for drying mixed fabrics and synthetics;
maximum load 2.5 kg.
- **Time programs:**
For additional drying or for drying loads of less than 1 kg.
- **Program EASY IRON (STRIJKVRIJ):**
Special drying program with anti-crease mechanism for easy-care fabrics;
maximum load 1 kg.
- **Program WOOL (WOL):**
To freshen up woollen fabrics after they have been line dried;
maximum load 1 kg.
- **REFRESHING (OPFRISSEN) programme**
for optimum results when refreshing items of clothing and gently cleaning textiles with the aid of commercially available dry-cleaning products
(please follow the manufacturer's instructions for use);
Programme duration: 35 minutes;
maximum load 1 kg.

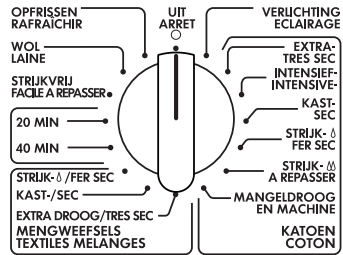

Before using the appliance for the first time

- ☞ Wipe out the drum using a damp cloth or else insert damp cloths and carry out a short drying procedure (20 mins.).

Brief instructions

- Ensure the laundry is well spun before tumble drying.
- Prepare the laundry.
- Open the door and insert washing.
- Shut the door.
Attention! Do not catch washing in the door.
- Select the drying program
 - on the program selector.
 - If required press the buttons SPECIAL CARE (LAGE TEMPERATUUR), AUDIBLE SIGNAL (ZOEMER).
- Start the program by pressing the START/PAUSE (START/PAUZE)-button.
While the program is running you can open the door to take-out laundry or add more laundry.
At the end of the program (END/CREASE GUARD (EINDE/ANTI-KREUK) display is illuminated, acoustic signal is sounded, if set, the anti-crease phase begins):
- Remove the laundry.
- Empty the water reservoir.
- Clean the fluff filter.
If the indicator CONDENSER (WARMTEWISSELAR) is highlighted:
- It is essential to clean the condenser!
- Switch-off the dryer by turning the programme selector to the OFF (UIT) position.

Drying

Prepare the laundry

- To prevent tangled bundles of laundry: Close zip fasteners; button-up bed linen and pillow cases; tie-together loose tapes, e.g. aprons.
- Empty all pockets.
- Remove all metal objects (paper clips, pins, etc.).
- Turn clothing consisting of double-layer fabric inside out (such as cotton-lined anoraks with the cotton layer facing outwards). The fabrics will dry better.
- Loosen the laundry.

Open the door

To open the door:

- Press firmly against the door (Press position ).

Load the laundry

- Load the prepared laundry into the dryer.

Closing the door

Closing the door:

- apply pressure to the door until it clicks audibly into place.





Caution! Ensure the laundry does not get caught in the door when the door is closed! This could damage the laundry!

Select the drying program

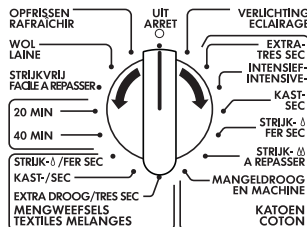

Select the suitable drying program using the program selector (see "Program tables").



 If required, select the button SPECIAL CARE (LAGE TEMPERATUUR), AUDIBLE SIGNAL (ZOEMER).

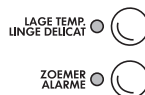

- **SPECIAL CARE (LAGE TEMPERATUUR) button**
This program operates with reduced heat. Press the SPECIAL CARE (LAGE TEMPERATUUR) button for fabrics bearing the care symbol . Gentle drying is advisable for heat-sensitive fabrics (such as acrylic and viscose).
- **AUDIBLE SIGNAL (ZOEMER) button**
During the crease-protection phase (immediately after the drying process), an acoustic signal is sounded at certain intervals (see "End of drying process").

Start the drying program

 Press the button START/PAUSE (START/PAUZE).



The drying programme begins. You can check the progress of the drying procedure in the programme progress display.



Removing laundry or loading laundry when necessary

You can interrupt the drying process at any time to remove some of the laundry or to add more laundry.

 Open the door.



Caution! The laundry and the drum may be hot.

 Remove or add more laundry.

 Close the door.

 Press the START/PAUSE (START/PAUZE) button to resume the drying process.

End of the drying process

The **cooling phase** starts shortly before the end of the drying process: The heater is switched-off during this phase. After the cooling phase the END/CREASE GUARD (EINDE/ANTI-KREUK) display is illuminated. You can now remove the washing from the tumble dryer.

The **crease guard phase** follows automatically after the drying process. For 30 minutes the drum rotates intermittently. This keeps your laundry loose and crease-free.

If you have pressed the AUDIBLE SIGNAL (ZOEMER) button, an acoustic signal is sounded intermittently during this phase.

You should remove the washing at the latest towards the end of the anti-crease phase to avoid creasing.

Removing the laundry

 Open the door and remove the laundry.

Empty the water reservoir

 **Caution!** The condensed water is not suitable for drinking or for use with foodstuffs.

The water reservoir should be emptied after every drying programme. This avoids interruption of a programme when the water reservoir is full.

 Grasp the handle flap of the water reservoir and pull-out completely.

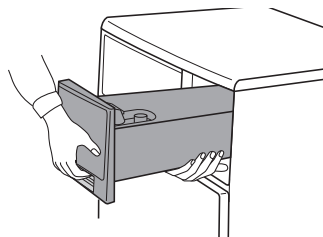

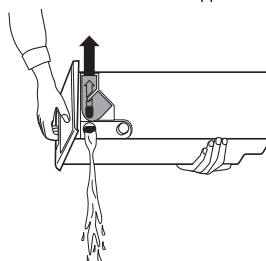

 Push the cover of the water reservoir to the side and pour-out the condensed water.



 Re-insert the water reservoir into the control panel.

If the drying cycle has not yet ended:

 Press the **START/PAUSE (START/PAUZE)** button to resume the drying process.

 The water reservoir has a capacity of approx. 3.8 litres. This is sufficient for a laundry load of 5 kg which has been machine spun at 800 revolutions per minute.

Cleaning the door seal

 Rub the door seal with a damp cloth.

Clean the fluff filter

To ensure efficient operation of the tumble dryer, clean the fluff filter after each drying program.

Also check whether there are any remnants or fluff from the washing in the drum; remove immediately.

- ➡ Press the catch of the filter lid downwards.

The filter lid will open.

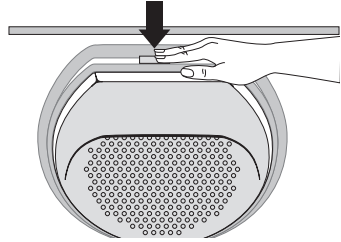

- ➡ Take-out the fluff filter.

- ➡ Remove fluff out of the fluff filter, with a moistened hand.

- ➡ Re-insert the fluff filter.

- ➡ Press against the filter lid until it catches into the locking device.

- i** The filter lid cannot catch shut without the fluff filter in place and the door cannot be closed.

- !** **Warning!** The dryer must not be operated with a damaged or blocked fluff filter.

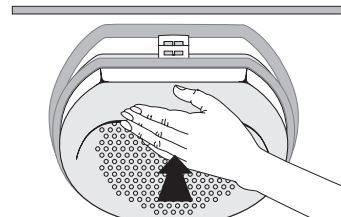
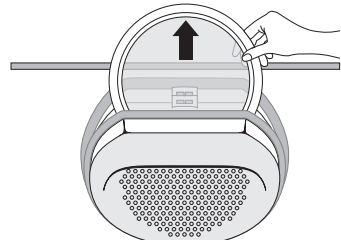



Cleaning the condenser

 **Important!** When the CONDENSER (WARMTEWISSELAR) display lights, it is essential to clean the condenser. Otherwise your dryer might suffer damage. In addition energy consumption will be increased if the condenser unit is covered with fluff.

 Open the door.

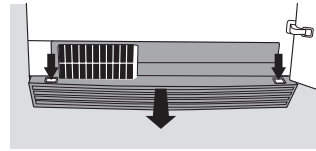
 Press on the two tabs to unlatch and take off the removable plinth.



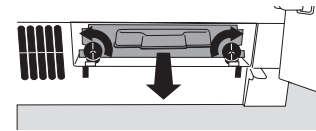

 Turn the two securing disks through a quarter turn each outwards.



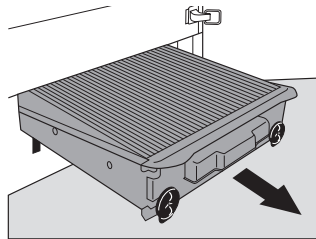

 Pull the condenser out of the base by the handle.

 Clean the condenser, best with a hand-held brush or by rinsing with a hand-held shower head. The water removal slits on the rear of the condenser must be free too.



 **Important!** Do not use any sharply pointed objects to clean the condenser. They could make it leak.

 Reinsert and push in and turn each one of the two securing disks through a quarter turn inwards. The words "top – oben – en haut" must be at the top.

 Re-mount the plinth.

 **Important!** The dryer must not be operated without condenser.

Switch-off the dryer

 Turn the program selector to the OFF (UIT) position.

Program tables

Program group COTTONS (KATOEN) care symbols ☺, ☺¹, ☺; maximum load 5 kg

Program	Laundry Type	Examples for
EXTRA DRY (EXTRA DROOG)	Heavy weight or mult-layered fabrics	Towelling material, bath robes
VERY DRY (INTENSIEFDROOG)	thick textiles that are to be thoroughly dried.	Towelling, terry towels
CUPBOARD DRY (KASTDROOG)	Fabrics of medium weight, articles not made up of mult-layers	Towel laundry, hand towels
DAMP (STIJKDROOG Δ)	Lightweight materials requiring ironing	Cotton shirt and underwear
HAND IRON (STIJKDROOG ΔΔ)	Normal cotton and linen articles	Sheets and pillowcases, tablecloths
MACHINE IRON (MANGELDROOG)	Cotton and linen articles, to be ironed by rotary ironer or starched laundry	Cotton sheets and pillowcases, tablecloths

Program group DELICATES (MENGWEEFSELS) care symbols ☺, ☺¹, ☺; maximum load 2.5kg



Program	Laundry Type	Examples for
EXTRA DRY (EXTRA DROOG)	Heavy weight or mult-layered fabrics	Sweatshirts, bed linen and table linen
CUPBOARD DRY (KASTDROOG)	Lightweight materials which do not require ironing	Easycare fabric shirts, table linen, baby clothes, socks and underwear
DAMP (STIJKDROOG Δ)	Lightweight synthetics and cotton/polyester mixtures requiring ironing	Bed and table linen, easycare fabric shirts and blouses

1) Press the SPECIAL CARE (LAGE TEMPERATUUR) button!

TIME programs**care symbols** , ¹, ; **loads less than 1 kg**

You can select 20 and 40 minutes program duration for additional drying of individual pieces of laundry or to dry small quantities.

1) Press the SPECIAL CARE (LAGE TEMPERATUUR) button!

Program EASY IRON (STRIJKVRIJ)**care symbols** , ¹, ; **maximum load 1 kg (approx. 5-6 shirts)**

For drying fabrics such as shirts and blouses; minimal ironing required.

Result depends on type and finish of fabric.

Recommendation: spin fabrics in the washing machine at a speed of about 1200 revolutions and then transfer immediately to the dryer. Remove fabrics immediately after drying and hang on a hanger.

1) Press the SPECIAL CARE (LAGE TEMPERATUUR) button!

Program WOOL (WOL)**maximum load 1 kg**

To freshen up the wool fibres of woollen garments after they have been line dried, worn or stored for longer periods they can be treated briefly using warm air. The wool emerges beautifully soft.

Recommendation: remove fabrics immediately after drying.

REFRESHING (OPFRISSEN) program**maximum load 1 kg**





For optimum results when refreshing items of clothing and gently cleaning textiles with the aid of commercially available dry-cleaning products (please follow the manufacturer's instructions for use);

Programme duration: 35 minutes.

A small glossary of textile information

Care symbols

Ensure articles to be dried are suitable for tumble drying. If they are one of the following symbols should be present on the care label:

-  This fabric can be tumble dried. The fabric manufacturer does not stipulate if the piece of laundry should be dried on a normal or gentle program.
-  Normal drying
-  Drying with special care (press the SPECIAL CARE (LAGE TEMPERATUUR) button!)
-  This fabric can be tumble dried. The fabric manufacturer does not stipulate if the piece of laundry should be dried on a normal or gentle program.
-  Do not tumble dry

If you do not find any of these care symbols:

Dry whites and coloureds as well as mixed fabrics at normal temperature. Press the SPECIAL CARE (LAGE TEMPERATUUR) button if you are drying delicate fabrics.

- Wool
Do not dry any woollen items in the dryer.
As a follow-up treatment for woollen fabrics in quantities up to 1 kg select the WOOL programme.
- Fabrics sensitive to temperatures
Dry fabrics sensitive to temperatures (such as acrylic or viscose) and textiles with the care label  with the SPECIAL CARE (LAGE TEMPERATUUR) button selected.
- Cotton jersey and hosiery have a tendency to shrink! Do not dry these fabrics excessively.
- New coloured textiles
To avoid the possibility of dye transference do not dry new coloured textiles together with light-coloured laundry.

Cleaning and maintenance

Cleaning the condenser

! **Important!** When the CONDENSER (WARMTEWISSELAR) display lights, it is essential to clean the condenser. Otherwise your dryer might suffer damage. In addition energy consumption will be increased if the condenser unit is covered with fluff.

For information on cleaning the condenser see section "Cleaning and maintenance, cleaning the condenser".

Cleaning the filter area

! **Important!** A small amount of fluff may reach the area around the filter in spite of the fluff filter. Therefore you should clean the entire filter area from time to time, or at least every three months.

- ☞** Remove the fluff filter.
- ☞** Hold the filter lid by the top and pull it forwards until it is released from both holders.
- ☞** Remove the fluff from the entire filter area – preferably with a vacuum cleaner.
- ☞** Press both pins of the filter lid into the holders on the door until they click in.
- ☞** Reinsert the fluff filter.
- ☞** Press against the filter lid until it clicks into the lock.

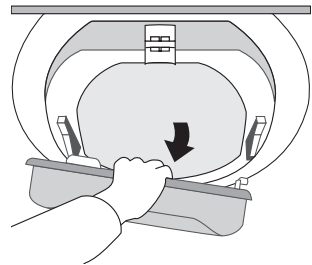

Cleaning the drum



Warning! Do not clean the stainless steel drum with abrasive detergents or steel wool!

Fabric softeners or lime in the water can cause a scarcely visible deposit to form on the drum. The dryer is then no longer reliably able to recognise how dry the washing is. When the washing is removed from the dryer it will be damper than you expect.



Wipe the inside of the drum and the drum fins with white vinegar to avoid a build up of residues/deposits effecting the sensors. This is particularly important if you regularly use fabric conditioning sheets or dry starched items in the dryer.

Cleaning the panel and operating parts



Warning! Do not use household furniture polish or aggressive detergents.



Wipe over the panel and operating parts with a damp cloth. Only use warm water.

Cleaning the door seal



Rub the door seal with a damp cloth immediately after the drying procedure.

Something not working?

If the tumble dryer is not working correctly please carry out the following checks before calling an engineer.

Symptom	Possible cause	Solution
The tumble dryer will not start	The appliance is not plugged in	Plug in the appliance
	The fuse has blown	Check the fuse
	The START/PAUSE (START/PAUZE) button has not been pressed	Press the START/PAUSE (START/PAUZE) button
	No program has been selected	Select the required program
	The door is not properly closed	Close the door
The results are unsatisfactory	The wrong program has been selected	Select a different program
	Fluff filter blocked	Clean the fluff filter
	Condenser covered with fluff	Clean the condenser
	The tumble dryer has been overloaded	Observe the maximum loads stated for each program
	Laundry not sufficiently spun prior to tumble drying	Ensure the wash load is well spun before tumble drying
	The vent in the base of the appliance is covered	Ensure the vent is clear
	A residue may have formed on the drum interior, blocking the sensors	Clean the inside of the drum with white vinegar
The drying process takes unusually long	The condenser unit is covered with fluff	Clean the condenser unit
	Fluff filter is clogged	Clean the fluff filter

Symptom	Possible cause	Solution
The door cannot be closed	Fluff filter has not been inserted correctly and/or the filter lid not closed	Replace the fluff filter and ensure the filter lid is closed
The drum illumination does not work	The program selector is in the OFF (UIT) position	Turn the program selector dial to LIGHT (VERLICHTING)
	The bulb needs replacing	Replace bulb
Display EMPTY WATER/CLEAN FILTER (RESERVOIR/ZEEF) is lit	Condensate container full	Empty the condensate container
	Fluff filter is clogged	Clean the fluff filter
EMPTY WATER/CLEAN FILTER (RESERVOIR/ZEEF) indicator illuminated, even though the container has already been emptied and the filter has been cleaned	Foreign bodies, e. g. animal hairs, can block the inlet nozzle as well as the valve on the end of the container	With the container pulled out, switch on the appliance momentarily. The blockage can be removed from the container shaft or the hair cleaned out of the valve
The dryer terminates the drying process automatically: END (EINDE) is displayed shortly after program start	Too dry or too little laundry filled-in for the selected program	Select time program or higher drying stage (e.g. EXTRA DRY (EXTRA-DROOG) instead of VERY DRY (INTENSIEF-DROOG))
The drying process takes unusually long. 4.5 hours after the beginning of the drying process: - END (EINDE) display is illuminated - acoustic signal sounds - discontinuation of the drying process - Program run display is flashing	SPECIAL CARE (LAGE TEMPERATUUR) button pressed and too much laundry filled-in	Check the program selection: SPECIAL CARE (LAGE TEMPERATUUR) button appropriate only for laundry amounts up to 2.5kg
	Too much laundry filled-in	Reduce the amount of laundry filled-in
	Laundry too damp	Pre-dry the laundry more thoroughly

If you do not find the required information in this manual to remedy a disturbance, please call the customer service.

Replace the interior light

 A replacement bulb can be purchased through your local AEG Service Force Centre (Part No: 647072580).

 **Warning!** Never use standard light bulbs in your Lavatherm.

 Isolate the appliance from the mains supply.

 Screw-off the bulb cover. (The bulb is located at the top behind the door; see *Front view*).

 Replace the defective bulb.

 Screw-on the bulb cover.

 **Warning!** For safety reasons the bulb cover must be screwed-on. The dryer must not be operated, without the cover in place.

Door Reversal Instructions







The door opening direction can be changed if required.

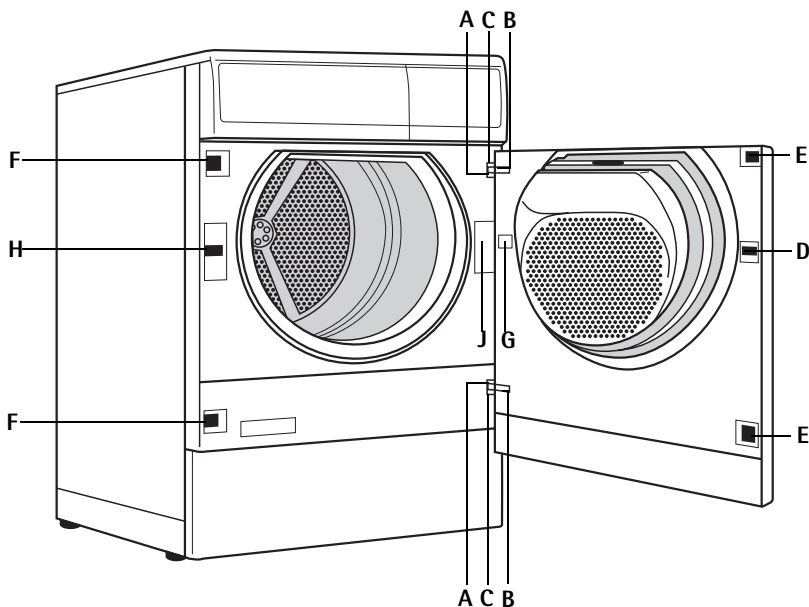





Warning! Before reversing the door, isolate the appliance from the mains supply.

Proceed as follows to reverse the door opening direction:



-  Un-screw the screws A on the front panel of the appliance.
-  Take-off the door by displacing it horizontally.
-  Un-screw the screws B on the inside of the door and take-off the hinges C.
-  Unscrew and take-off the locking block D.
-  Release the coverplates E, F and G with a thin screwdriver by pressing on the latching device, displace them to the side. Take them out and insert them again on the opposite side.
-  Screw-on the hinges C and the locking block D on the opposite side of the door.
-  Screw-off the door catch H and remove it.

-  Take-out the latched catch covering J.
 -  Connect the door catch H and the catch covering J on the respective opposite side to the plug and screw-down or latch into position.
 -  Push the door with the hinges into the breakouts provided for them in the front panel of the appliance and firmly attach it with the screws.
-  **Warning!** The appliance is safe again for operation only when all plastic parts have been mounted.

Technical data

Height x Width x Depth	85x60x60cm
Depth with the door open	117cm
Height adjustable from	1.0/-0.4cm
Empty weight	approx. 46 kg
Load (depending on the program)	max. 5kg
	(Different loads in some countries are due to different measuring methods)
Power consumption in acc. with IEC 1121 s.e.	3.5 kWh
	(5 kg Cotton, spun at 800 revolutions per minute, program COTTON CUPBOARD DRY)
Area of use	Household
Permissible ambient temperature	+5°C up to +35°C

- CE** This appliance complies with the following EC directives:
- 73/23/EEC of 19/2/1973 'Low voltage directive'
 - 89/336/EEC of 3/5/1989 'EMC directive' including the Modification directive 92/31/EEC

Installation and electrical connection

Please refer to the type plate for specifications about the power supply. The nominal voltage stated on the type plate and type of current must be identical with the nominal voltage and type of current at the point of installation. Also refer to the type plate for the fuse required.

Information for the electrician

When connecting the appliance without a plug, care must be taken that this is done correctly. Please follow the relevant information in the section on installing and connecting the appliance.

For appliances with variable voltage settings, the switch-over diagram can be found on the cover of the connection box at the back of the appliance.

Special accessories

You can obtain the following special accessories from your retailer.

Drainage kit

With this kit (E-No. 916 019 000) you can lead the condensate directly into a drain (sink, siphon, drain grating) with a maximum feed height of 1 m above the floor on which the dryer is standing (3m Length).

Emptying the condensate container is then no longer necessary.

You can then ignore the EMPTY WATER (RESERVOIR) indicator at the end of each program. However, the condensate container must be inserted correctly in the operator control mask.

Stacking kit

With these kits you can combine your laundry dryer with any LAVAMAT automatic washing machine to a washing and drying column. The appliances are stacked in space-economising manner in this arrangement, the washing machine at the bottom and the laundry dryer at the top.

The following two kits are available:

- | | |
|---------------------------------|-------------------|
| - without plate | E-No. 916 018 900 |
| - with extendible deposit plate | E-No. 916 018 901 |

Content

A

Acrylate	17
Acrylic	24
Anorak	16
AUDIBLE SIGNAL	17, 18

C

Children, safety	6
Closing the door	20
Condenser	21, 25
Connection	7
Control panel	13
Cool-down phase	18
COTTON	14
Crease protection phase	18
Creasing	7
Customer service	35

D

Delicate fabric	7
Disposal	8
Door Reversal	30

E

EASY IRON	14, 23
Easy-care fabrics	24
Environmental protection	9

F

Fabric softeners	26
Fabric wear when drying	7
Fluff filter	20
Fluff quantity	7
Full load, specified	7
Furniture polish	26

G

Glossary	24
----------------	----

I

Interior light	29
Ironing	10

L

Lime	26
------------	----

O

Opening the door	16
------------------------	----

P

Packaging	8
-----------------	---

R

REFRESHING	14, 23
Repair	5

S

Safety Information	5
Solvent(s)	6
SPECIAL CARE	10, 17
Sponge rubber	6
Stacking kit	33
Starched washing	7
START	18

T

Transportation damage	7
Two-layer fabric	16

V

Viscose	24
---------------	----

W

Water reservoir	19
WOOL	14, 23
Wool	24

Service

In the chapter "Something not working" some disturbances have been summarised, which you can solve yourself. If you do not find any helpful information there, please contact your local customer service centre. It is nearby and if necessary can reach you quickly. (Addresses and phone numbers can be found in the Warranty Conditions/Service Departments)

Be well prepared before you phone. This facilitates the diagnosis and the decision as to whether a customer service visit is necessary. With our checklist you can gather important information before making your call:

Make a note of the PNC number and the S number. They are both on the rating plate behind your tumble dryer's door.

PNC

S-No

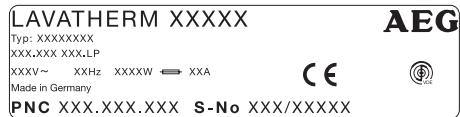

If possible establish:

- How is the disturbance evident?
- Under what circumstances does the disturbance occur?

When do you incur costs even during the warranty period?

- if you could have solved the disturbance yourself with the help of the Troubleshooting table (see section "Something not working"),
- if the customer service engineer has to make several journeys because he did not receive all the necessary important information before his visit and now e.g. has to fetch spares. You can avoid these extra trips by preparing your telephone call properly in the way described above.

AEG Hausgeräte GmbH
Postfach 1036
D-90327 Nürnberg

<http://www.aeg.hausgeraete.de>

© Copyright by AEG

822 944 107-00- 0102/PRO

Subject to change without notice

Free Manuals Download Website

<http://myh66.com>

<http://usermanuals.us>

<http://www.somanuals.com>

<http://www.4manuals.cc>

<http://www.manual-lib.com>

<http://www.404manual.com>

<http://www.luxmanual.com>

<http://aubethermostatmanual.com>

Golf course search by state

<http://golfingnear.com>

Email search by domain

<http://emailbydomain.com>

Auto manuals search

<http://auto.somanuals.com>

TV manuals search

<http://tv.somanuals.com>