

*The Xerox
DocuPrint NC60
Color Laser Printer*

**System
Administrator
Guide**

Version 1.0

Copyright protection claimed includes all forms and matters of copyrightable materials and information now allowed by statutory or judicial law or hereinafter granted, including without limitation, material generated from the software programs which are displayed on the screen such as styles, templates, icons, screen displays, looks, etc.

Printed in the United States of America.

XEROX® and all Xerox product names and product numbers mentioned in this publication are registered trademarks of the Xerox Corporation. Other company trademarks are also acknowledged. PCL is a trademark of the Hewlett-Packard Company. MS, MS-DOS, Windows NT, Microsoft LAN Manager, Windows 95 and Windows 98 are trademarks of Microsoft Corporation. Adobe, Adobe Type Manager, Adobe PageMaker, and PostScript are trademarks of the Adobe Systems, Inc. TrueType and Apple ColorSync are trademarks of Apple Computer, Inc. OS/2 is a trademark of International Business Machines Corporation. SunOS and Solaris are trademarks of Sun Corporation. MacroMedia FreeHand is a trademark of MacroMedia Corporation. QuarkXpress is a trademark of Quark Corporation.

This printer contains an emulation of the Hewlett Packard PCL 5C command language (recognized HP PCL 5C commands) and processes these commands in a manner compatible with Hewlett Packard LaserJet printer products.

Changes are periodically made to this document. Technical updates will be included in subsequent editions.

© 1999 by Xerox Corporation. All rights reserved.

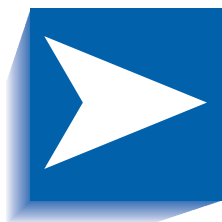

Contents

Chapter 1	Configuring the Printer	1-1
	Control Panel Features.....	1-2
	The Display.....	1-3
	The Indicator Lights.....	1-4
	The Keys	1-5
	Navigating the Menu System.....	1-10
	Menu Symbols	1-12
	Setting a Menu Option.....	1-13
	Access to Special Operating Modes	1-15
	Control Panel Locks	1-16
	Main Menu	1-17
	Job Menu	1-19
	Password Menu	1-22
	Tray Menu	1-25
	PCL Menu	1-29
	System Menu	1-34
	Color Adjust Menu.....	1-42
	Imaging Menu	1-46

	<i>Parallel Menu</i>	1-50
	<i>Serial Menu</i>	1-53
	<i>Ethernet Menu</i>	1-57
	<i>Token Ring Menu</i>	1-69
	<i>Novell Menu</i>	1-83
	<i>Print Menu</i>	1-91
	<i>Media Server Menu</i>	1-96
	<i>Service Menu</i>	1-99
	<i>Reset Menu</i>	1-109
Chapter 2	<i>Managing Printer Usage</i>	2-1
	<i>Network Printer Services</i>	2-2
	<i>CentreWare DP</i>	2-3
	<i>CentreWare Internet Services</i>	2-4
	<i>Setup</i>	2-4
Chapter 3	<i>Using the Hard Drive</i>	3-1
	<i>Hard Drive Considerations</i>	3-2
	<i>Disk Initialization</i>	3-2
	<i>Downloading Fonts and Macros</i>	3-3
	<i>FSDOWNLOAD Command</i>	3-4
	<i>FSDELETE Command</i>	3-7
	<i>Using the Hard Disk Drive for Secure and Proof Jobs</i>	3-8
	<i>Creating Secure Jobs</i>	3-8
	<i>Creating Proof Jobs</i>	3-10
	<i>Printing or Deleting Secure or Proof Jobs</i>	3-12
Chapter 4	<i>Maintaining the Printer</i>	4-1
	<i>Regular Printer Maintenance</i>	4-3
	<i>Cleaning the Printer</i>	4-4
	<i>Cleaning the Print Drum Charger</i>	4-4
	<i>Cleaning the Grounding Roller and Feed Rollers</i>	4-5

<i>Adjusting Density and Color Balance</i>	4-8
<i>Printing a Test Page</i>	4-9
<i>Interpreting the Test Print</i>	4-10
<i>What To Look For</i>	4-11
<i>Making Adjustments</i>	4-12
<i>Adjustment Recovery</i>	4-15
<i>Upgrading the Printer Software</i>	4-16
<i>Before You Upgrade</i>	4-17
<i>Upgrade Methods</i>	4-18
<i>Printer Controller Upgrade Process</i>	4-19
<i>Determining a Successful Upgrade</i>	4-20
<i>After the Upgrade</i>	4-20
<i>Procedure A</i>	4-21
<i>Procedure B</i>	4-22
<i>Procedure C</i>	4-24
<i>Procedure D</i>	4-26
<i>Procedure E</i>	4-28
<i>Procedure F</i>	4-29
<i>Procedure G</i>	4-31
<i>General Troubleshooting</i>	4-32
Chapter 5 <i>Troubleshooting</i>	5-1
<i>Control Panel Messages</i>	5-2

1

Configuring the Printer

<i>Control Panel Features</i>	1-2
<i>Navigating the Menu System</i>	1-10
<i>Main Menu</i>	1-17
<i>Job Menu</i>	1-19
<i>Password Menu</i>	1-22
<i>Tray Menu</i>	1-25
<i>PCL Menu</i>	1-29
<i>System Menu</i>	1-34
<i>Color Adjust Menu</i>	1-42
<i>Imaging Menu</i>	1-46
<i>Parallel Menu</i>	1-50
<i>Serial Menu</i>	1-53
<i>Ethernet Menu</i>	1-57
<i>Token Ring Menu</i>	1-69
<i>Novell Menu</i>	1-83
<i>Print Menu</i>	1-91
<i>Media Server Menu</i>	1-96
<i>Service Menu</i>	1-99
<i>Reset Menu</i>	1-109

Control Panel Features

The DocuPrint NC60 Control Panel (Figure 1.1) serves two purposes:

1. It displays information about the status of the printer (or the job in process) and
2. It provides the means for changing printer settings to control how the DocuPrint NC60 operates.

Figure 1.1 DocuPrint NC60 Control Panel

- 1 On Line LED
- 2 Press Enter LED
- 3 Two line, user interface display
- 4 Color Process LEDs
- 5 On Line/Off Line key
Password #0
- 6 Enter key
Password #1
- 7 Menu Up key
Password #2
- 8 Menu Down key
Password #3
- 9 Item Up key
Password #4
- 10 Item Down key
Password #5
- 11 Value Up key
Password #6
- 12 Value Down key
Password #7

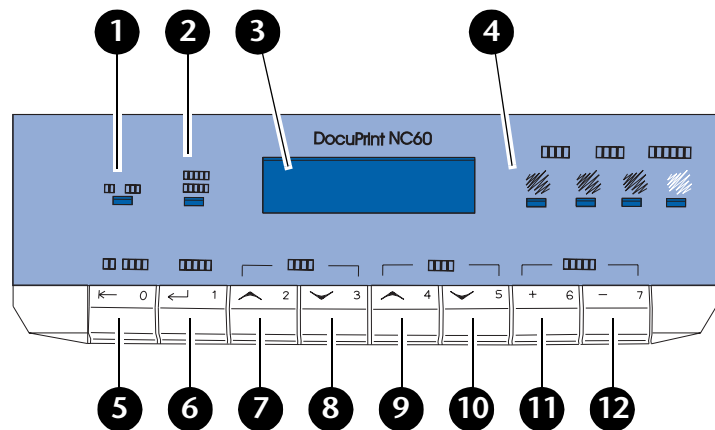

The Display

The Control Panel's display performs two functions.

- It informs you of printer status conditions, such as when toner is low, when a paper tray is empty, when a job is in process, and so on. For example, when you turn on the printer, you see the following message on the display:

Ready

This message appears whenever the printer is on-line and ready to accept print jobs. The display will also show:

Processing...

when processing data, and:

Waiting

when waiting for more data.

- It presents a hierarchy of menu options and settings to configure and control the printer.

For example, when you press **Menu Up** or **Menu Down**, you will see the following two-line message on the display:

Menus
Item Menu

(such as **System Menu** or **Job Menu**)

See the section “Menu Symbols” (page 1-12) for more information on indicators.

See the section “Main Menu” (page 1-17) for information on the Menu system hierarchy.

The Indicator Lights

The Control Panel contains six indicator lights. Table 1.1 describes the function of each light.

Table 1.1 Control Panel indicator lights and their functions

Light	Description
Online	When the printer is On-line the light is On. When the printer is Off-line, it is OFF. When transitioning from On-line to Off-line, it flashes at a rate of 2 times per second. It also flashes to indicate that data are being processed by Postscript, PCL or PJJ, or are being spooled to the disk (e.g. secure or proof job).
Press Enter	The light is flashing when the Enter key should be pressed to: <ul style="list-style-type: none">• Release a print job sent as a Hold Job.• Release a PCL job where no End of Job has been received (PCL Form Feed).
Black Cyan Magenta Yellow	Each light is on while the engine is processing the corresponding toner color. When an out of toner condition is encountered, the LED corresponding to the low toner flashes.

The Keys The Control Panel keypad consists of eight keys, identified with international symbols and/or labeled in English. The keys are also numbered 0 - 7. (Control Panel overlays are available in some languages and are supplied with the printer where applicable.)

Table 1.2 describes the function of each key.

Table 1.2 Control Panel keys and their functions

Key	Description
Online	<ul style="list-style-type: none"> • If the Printer is On-line and not in the Menu system, pressing this key causes a transition to Off-line. All pages currently in the paper path are printed and then printing pauses until the printer is placed On-line. Status information via SNMP is provided while in the Off-line state. Data are still accepted over all network interfaces, and page formatting continues as long as memory is available. The exception is the Parallel port running in the Compatibility mode, or the Serial port. In Parallel, Off-line forces the "Select" line false and forces the "Fault" line true. In Serial, Off-line sends an XOFF if this handshaking mode is selected, and forces the DTR line false. • If the printer is On-line and in the Menu system, pressing this key exits the menu system. The printer remains On-line. • If the printer is Off-line and not in the Menu system, pressing this key causes the printer to change to the On-line state, provided no operator intervention condition exists. This key is ignored if an operator intervention condition exists. • If the printer is Off-line and in the Menu system, pressing this key exits the Menu system. The printer state changes to On-line, provided no operator intervention condition exists. • If in the Password menu, and the display indicates "Enter Password", pressing this key causes a password digit "0" to be entered.
Table 1.2 Page 1 of 5	

Table 1.2 Control Panel keys and their functions (continued)

Key	Description
Enter	<ul style="list-style-type: none"> • If the current display is a value for an item, pressing this key causes the value to be entered as the default value for this item. The currently displayed value is immediately loaded in NVRAM. The display then returns to indicate the current menu on the top line and the current item on the bottom line. • Some values require a power cycle before taking effect. • If the current display is an action to be invoked (e. g. "PCL Font List", "Restart Printer"), pressing this key causes the action to take place. Following the action, the display returns to indicate "Ready" on the top line. • If not in the Menu system, and the "Press Enter" LED indicates that a partial page exists, pressing this key causes an implied PCL reset and the partial page is printed. • If a paper mismatch condition exists, and a request to load paper is displayed, pressing this key causes printing on the media currently loaded in the selected tray (Print Anyway). See Value Up or Value Down for more information. • If in the Password menu, and the display indicates "Enter Password", pressing this key causes a password digit "1" to be entered.
Menu Up (^)	<ul style="list-style-type: none"> • If in the menu system, pressing this key causes the Control Panel to scroll through the menus in order bottom to top unless a higher priority message is displayed, which preempts menu navigation. Menu scrolling is available without going to the Off-line state. Scrolling wraps, such that if the displayed menu is the top menu, pressing this key scrolls to the bottom menu. • If an item, value or action is displayed, pressing this key returns to the top of the current menu and removes the display of the item, value or action. • If not in the menu system, pressing this key enters the menu system and displays the first menu, Job Menu. • If in the Password menu, and the display indicates "Enter Password", pressing this key causes a password digit "2" to be entered.

Table 1.2 Page 2 of 5

Table 1.2 Control Panel keys and their functions (continued)

Key	Description
Menu Down (v)	<ul style="list-style-type: none"> • If in the menu system, pressing this key causes the Control Panel to scroll through the menus in order top to bottom unless a higher priority message is displayed, which preempts menu navigation. Menu scrolling is available without going to the Off-line state. Scrolling wraps, such that if the displayed menu is the bottom menu, pressing this key scrolls to the top menu. If an item, value or action is displayed, pressing this key returns to the top of the current menu and removes the display of the item, value or action. • If not in the menu system, pressing this key enters the menu system and displays the last menu. • If in the Password menu, and the display indicates "Enter Password", pressing this key causes a password digit "3" to be entered.
Item Up (^)	<ul style="list-style-type: none"> • If in the menu system, pressing this key causes the Control Panel to scroll through the items in the current menu in order bottom to top unless a higher priority message is displayed, which preempts menu navigation. Scrolling wraps, such that if the displayed item is the top item, pressing this key scrolls to the bottom item. If a value is displayed, pressing this key returns to the current item in the current menu and removes the value from the display. • If not in the menu system, this key is ignored. • If in the Password menu, and the display indicates "Enter Password", pressing this key causes a password digit "4" to be entered.

Table 1.2 Page 3 of 5

Table 1.2 Control Panel keys and their functions *(continued)*

Key	Description
Item Down (v)	<ul style="list-style-type: none"> • If in the menu system, pressing this key causes the Control Panel to scroll through the items in the current menu in order top to bottom unless a higher priority message is displayed, which preempts menu navigation. Scrolling wraps, such that if the displayed item is the bottom item, pressing this key scrolls to the top item. If a value is displayed, pressing this key returns to the current item in the current menu and removes the value from the display. • If not in the menu system, this key is ignored. • If in the Password menu, and the display indicates "Enter Password", pressing this key causes a password digit of "5" to be entered.
Value Up (+)	<ul style="list-style-type: none"> • If in the menu system, and an item is displayed, pressing this key causes the Control Panel to scroll through the values for the current item in order bottom to top unless a higher priority message is displayed, which preempts menu navigation. Scrolling wraps, such that if the displayed value is the top value, pressing this key scrolls to the bottom value. If no value for the current item is displayed (Item key was pressed but Value key not yet pressed for this item), pressing this key displays the default value for the current item. When setting a numeric value, pressing this key increases the value by the step amount. It is subject to auto-repeat if held down for more than 1 second, after which the value scrolls repeatedly until the key is released. The increment for each step may be greater than that for a single key press. • If not in the menu system, and a paper mismatch condition does not exist, this key is ignored. • If a Paper Mismatch condition exists, pressing this key scrolls through the alternate media that may be used instead of the requested media. • If in the Password menu, and the display indicates "Enter Password", pressing this key causes a password digit "6" to be entered.

Table 1.2 Page 4 of 5

Table 1.2 Control Panel keys and their functions (continued)

Key	Description
Value Down (-)	<ul style="list-style-type: none"> • If in the menu system, and an item is displayed, pressing this key causes the Control Panel to scroll through the values for the current item in order top to bottom unless a higher priority message is displayed (e.g. operator intervention required, etc.), which preempts menu navigation. Scrolling wraps, such that if the displayed value is the bottom value, pressing this key scrolls to the top value. If no value for the current item is displayed (Item key was pressed but Value key not yet pressed for this item), pressing this key displays the default value for the current item. When setting a numeric value, this key decreases the value by the step amount. It is subject to auto-repeat if held down by more than 1 second, after which the value scrolls repeatedly until the key is released. The decrement for each step may be greater than that for a single key press. • If not in the menu system, and a paper mismatch condition does not exist, this key is ignored. • If a Paper Mismatch condition exists, pressing this key scrolls through the alternate media that may be used instead of the requested media. • If in the Password menu, and the display indicates "Enter Password", pressing this key causes a password digit "7" to be entered.
Table 1.2 Page 5 of 5	

Navigating the Menu System

The Control Panel contains two menu structures.

1. Main Menu and its submenus.

- Job Menu
- Password Menu (when the Hard Disk Drive is installed)
- Tray Menu
- PCL Menu
- System Menu
- Color Adjust Menu
- Imaging Menu
- Parallel Menu
- Serial Menu
- Ethernet Menu
- Token Ring Menu (when the Token Ring Card is installed)
- Novell Menu
- Print Menu
- Media Server Menu (when the optional Media Server is installed)
- Service Menu

Press **Menu Up** or **Menu Down** to access the Main Menu. Each of the submenus may have other submenus, settings, actions or functions.

2. Reset Menu and its functions.

- Factory Defaults
- Network Defaults
- CRU Resets
- Restart Printer
- Delete All Jobs (requires Hard Disk Drive option)
- Disk Initialize (requires Hard Disk Drive option)
- Disk Format (requires Hard Disk Drive option)



*The Reset Menu is included in the menu list by simultaneously holding down **Online** and **Enter** when the printer is being powered up. See the section “Reset Menu” (page 1-109) for more information.*

Menu Symbols

Two menu symbols (= and *) are used to furnish information about menus and settings. The purpose of each symbol is described in Table 1.3 below.

Table 1.3 Symbols found in the Control Panel Menu systems

Symbol	Purpose	Example
=	<p>When at a point where a value may be changed, the item name is displayed on the top line with the = symbol in the last character position, and the selected value is displayed on the bottom line.</p> <p>The example at the right tells you that Language is an option that takes a specific setting. One setting for the Language option is Français. Another setting is English. (The list of available settings is displayed one setting at a time on the bottom line of the display as you press Value Up or Value Down.)</p>	<p>Language = Français</p>
*	<p>When first arriving at a point where a setting may be changed, the current value is displayed on the bottom line and a * symbol appears next to it in the last character position. Pressing Up Value or Down Value scrolls through the possible values. Whenever the current value is displayed, the * is displayed in the last character position. Pressing Enter causes the * to display in the last character position for the new value. Since pressing Enter causes the display to indicate the current menu and current item, the asterisk may not be seen until the item and current value is displayed again by pressing a Value key.</p> <p>The example at the right tells you that Language is currently set to English.</p>	<p>Language = English *</p>

Setting a Menu Option

To set an option or to invoke a function, follow the steps below:

- 1 Press **Menu Up** or **Menu Down** to scroll through the available submenus until you locate the one you want.

You will see:

```
Menu
Menu Name
```

Where *Menu Name* is the current submenu displayed.

- 2 Press **Item Up** or **Item Down** to scroll through the items of the submenu (all submenus except the Password Menu).

You will see:

```
Menu Name
Item Name
```

Where *Item Name* is the current item displayed. For the Job, Print, Service and Reset (with the exception of the Language option) Menus, the bottom line of the display indicates the action to be taken (e.g., Config. Sheet or PCL Font List).

- 3 Press **Value Up** or **Value Down** to select the appropriate value for this item.

You will see:

```
Item Name      =  
Current Value*
```

If a list of many values exists (e.g., 1 through 99 for number of copies), you can scroll quickly by holding down **Value Up** or **Value Down**.

When you see the value you want, press **Enter** to accept it.

- 4 If necessary, repeat Step 2 and Step 3 to go through other menus, options, actions, functions and values.

After you press **Enter** to accept a value, the menu will display:

```
Menu Name  
Item Name
```

You may either continue to work in the Menu system by repeating the steps above, or exit and return to normal operation by pressing **Online**.



*If you press **Online** at any time prior to pressing **Enter** the new value will not be saved and the Menu system is exited.*



The printer automatically exits the Menu system after 60 seconds of inactivity (i.e., no key has been pressed).

Access to Special Operating Modes

The printer may be placed in special diagnostic or other operating modes by turning on power while holding down two keys on the Control Panel. The following are the key combinations for each mode:

Table 1.4 Access to special operating modes

Key Combinations	Mode
On-line and Enter (Keys numbered 0 and 1)	Sets a flag in RAM so that the Control Panel enables the "Reset" menu.
Menu Up and Menu Down (Keys numbered 2 and 3)	Forces the "Software Update" mode on the Parallel port.

Control Panel Locks

Some of the menus in the Control Panel may be “locked” to prevent unauthorized access and changes to system parameters. This is accomplished with the PJL “CPLOCK” command. If the user scrolls to a locked menu, pushing either “Item” key will cause the menu name to appear on the top line, and “Menu Locked” to appear on the second line. Menus are unlocked only with the corresponding PJL “CPLOCK” command. Only the following menus are available from the Control Panel when locked:

- Job Menu
- Password Menu (if optional Hard Disk is installed)
- Tray Menu
- Print Menu
- Media Server Menu (if Media Server is installed)
- Reset Menu

If you do not want users to have access to the Reset Menu, power OFF and power ON the printer.

Main Menu

The Main Menu is a system of submenus, each containing options designed to configure the printer for your environment. The Main Menu hierarchy is depicted in Table 1.5 on page 1-18.



In this chapter, a boldfaced value followed by an asterisk () indicates the factory default for that value. See the section “Reset Menu” (page 1-109) for information on how to revert to factory settings.*

Items and values in italics are available only when the applicable option is installed and operational.

Table 1.5 Main Menu hierarchy

Main Menu	Hierarchy and Factory Settings
Job Menu	See "Job Menu" (page 1-19).
Password Menu ¹	See "Password Menu" (page 1-22).
Tray Menu	See "Tray Menu" (page 1-25).
PCL Menu	See "PCL Menu" (page 1-29).
System Menu	See "System Menu" (page 1-34).
Color Adjust Menu	See "Color Adjust Menu" (page 1-42)
Imaging Menu	See "Imaging Menu" (page 1-46)
Parallel Menu	See "Parallel Menu" (page 1-50).
Serial Menu	See "Serial Menu" (page 1-53)
Ethernet Menu	See "Ethernet Menu" (page 1-57).
Token Ring Menu ²	See "Token Ring Menu" (page 1-69)
Novell Menu	See "Novell Menu" (page 1-83).
Print Menu	See "Print Menu" (page 1-91)
Media Server Menu	See "Media Server Menu" (page 1-96)
Service Menu	See "Service Menu" (page 1-99)
Reset Menu ³	See "Reset Menu" (page 1-109).

¹ Appears only when the Hard Disk Drive is installed.

² Appears only when the option is present.

³ Appears only when **Online** and **Enter** are simultaneously held down at power ON.

Job Menu

Use the Job Menu to cancel the job currently being processed, force a form feed on a partially formatted job in PCL, or restart the printer. The menu hierarchy is shown in Figure 1.2.

Figure 1.2 Job Menu hierarchy

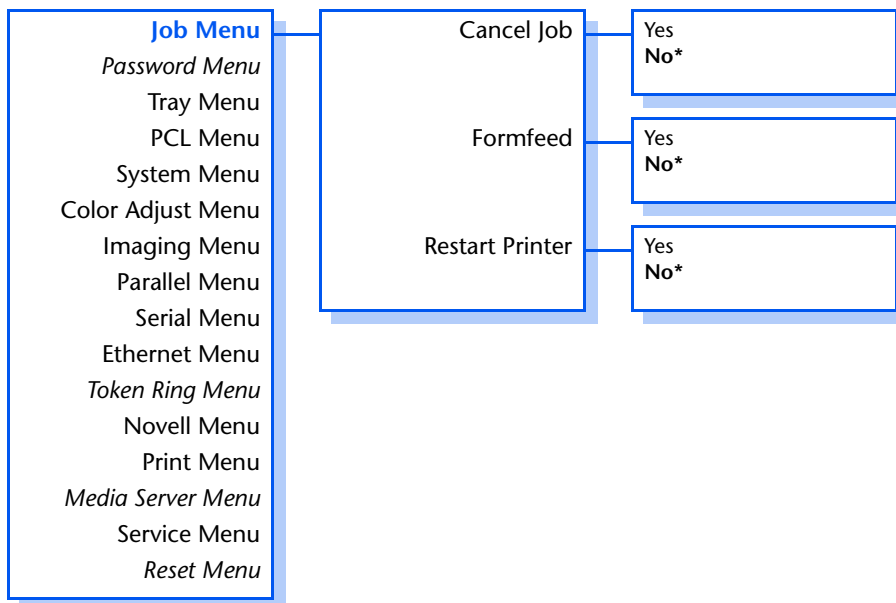

Refer to Table 1.6 on page 1-20 for step-by-step instructions.

Table 1.6 Job Menu functions

Menu Item and Function	Keystrokes	Display Reads
<p>Cancel Job</p> <p>Cancel the job currently printing (Postscript or PCL).</p> <p>The available values are:</p> <p>Yes No*</p>	1. Press Menu Up or Menu Down until you see:	Menus Job Menu
	2. Press Item Up or Item Down until you see:	Job Menu Cancel Job
	3. Press Value Up or Value Down until you see:	Cancel Job Yes
	4. Press Enter . You will see:	Cancelling Job Filename
	5. When done, you will see:	Ready
<p>Form Feed</p> <p>Eject a partial PCL page when the "Press Enter" LED is ON.</p> <p>The available values are:</p> <p>Yes No*</p>	1. Press Menu Up or Menu Down until you see:	Menus Job Menu
	2. Press Item Up or Item Down until you see:	Job Menu Form Feed
	3. Press Value Up or Value Down until you see:	Form Feed Yes
	4. Press Enter . You will see:	Job Menu Form Feed
	5. Press Online . You will see:	Ready

Table 1.6 Page 1 of 2

Table 1.6 Job Menu functions (continued)

Menu Item and Function	Keystrokes	Display Reads
Restart Printer Reinitialize the printer as if the power was cycled, but bypassing power on diagnostics. The available values are: Yes No*	1. Press Menu Up or Menu Down until you see:	Menus Job Menu
	2. Press Item Up or Item Down until you see:	Job Menu Restart Printer
	3. Press Value Up or Value Down until you see:	Restart Printer Yes
	4. Press Enter . You will see:	[Startup Messages]
	5. When the action is complete, you will see:	Ready
Table 1.6 Page 2 of 2		

Password Menu

Use the Password Menu (available only when the optional Hard Drive is installed) to print or delete secure or proof jobs. Secure and proof jobs are enabled by drivers.

The menu hierarchy is shown in Figure 1.3.

Figure 1.3 Password Menu hierarchy

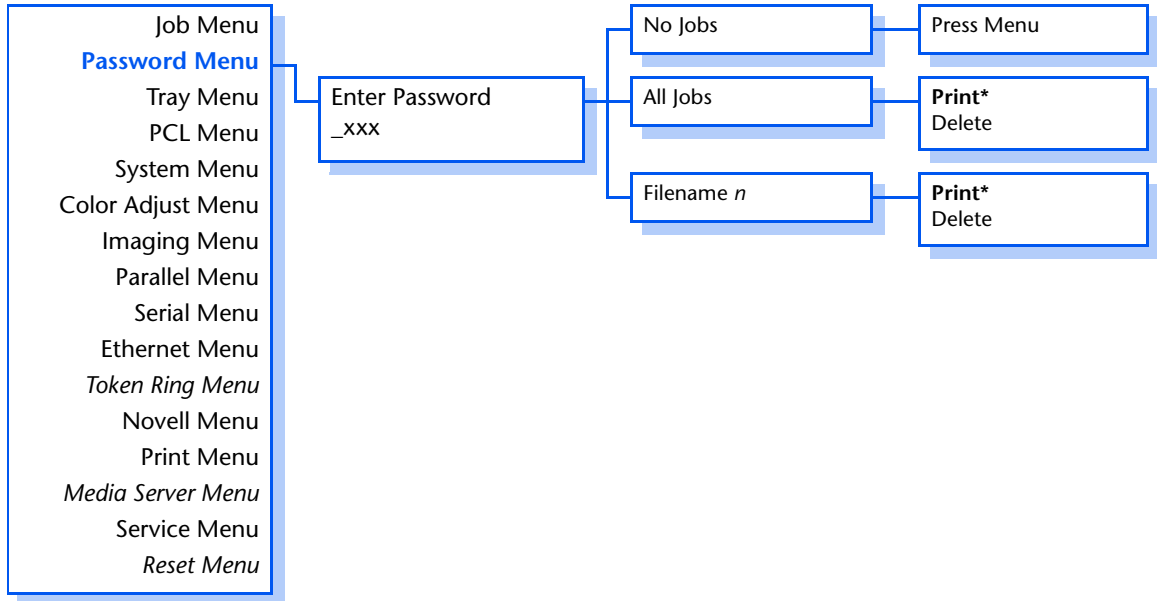

Refer to Table 1.7 on page 1-23 for step-by-step procedures.

Table 1.7 Password Menu functions

Menu Item and Function	Keystrokes	Display Reads
All Jobs Print Print all jobs sent with a specific password.	1. Press Menu Up or Menu Down until you see:	Menus Password Menu
	2. Press Item Up or Item Down . You will see:	Enter Password _xxx
	3. Enter four-digit password using the numbers on the Control Panel keys. You will see:	All Jobs Print
	4. Press Enter . When print is completed you will see:	Ready
Filename n Print Print one or more jobs out of several sent with a specific password. A job with a name assigned to it will replace the "Job n" with that name.	1. Press Menu Up or Menu Down until you see:	Menus Password Menu
	2. Press Item Up or Item Down . You will see:	Enter Password _xxx
	3. Enter four-digit password using the numbers on the Control Panel keys. You will see:	All Jobs Print
	4. Press Item Up or Item Down until you see:	Filename n Print
	5. Press Enter . You will see:	Printing Filename n
	6. Repeat Steps 4 and 5 until you have identified all the jobs you wish to print. When done, press Online . You will see:	Ready

Table 1.7 Page 1 of 2

Table 1.7 Password Menu functions (continued)

Menu Item and Function	Keystrokes	Display Reads
All Jobs Delete Delete all jobs sent with a specific password.	1. Press Menu Up or Menu Down until you see:	Menus Password Menu
	2. Press Item Up or Item Down . You will see:	Enter Password _xxx
	3. Enter four-digit password using the numbers on the Control Panel keys. You will see:	All Jobs Print
	4. Press Value Up or Value Down until you see:	All Jobs Delete
	5. Press Enter . You will see:	Ready
Filename n Delete Delete one or more jobs out of several sent with a specific password.	1. Press Menu Up or Menu Down until you see:	Menus Password Menu
	2. Press Item Up or Item Down . You will see:	Enter Password _xxx
	3. Enter four-digit password using the numbers on the Control Panel keys. You will see:	All Jobs Print
	4. Press Item Up or Item Down until you see:	Filename n Print
	5. Press Value Up or Value Down until you see:	Filename n Delete
	6. Press Enter . You will see:	All Jobs Print
	7. Repeat Steps 4 to 6 until you have deleted all the jobs you wish to print. When done, press Online . You will see:	Ready

Table 1.7 Page 2 of 2

Table 1.8 Tray Menu functions

Menu Item and Function	Keystrokes	Display Reads
<p>Tray1 Cust. Size</p> <p>Define the paper size loaded into Tray 1.</p> <p>The available values are:</p> <p>Statmt(5.5x8.5) 8x10 Folio(8.5x13) SPFolio(216x315)* A5(148x210) B5-ISO(176x250)</p> <p>The factory default for paper size is SPFolio, regardless of the "Defaults" setting in the System Menu.</p>	1. Press Menu Up or Menu Down until you see:	Menus Tray Menu
	2. Press Item Up or Item Down until you see:	Tray Menu Tray1 Cust. Size
	3. Press Value Up or Value Down until you see:	Tray1 Cust. Size New Value
	4. Press Enter . You will see:	Tray Menu Tray1 Cust. Size
	5. Press Online . You will see:	Ready
<p>Tray2 Cust. Size</p> <p>Define the paper size loaded into the optional Tray 2.</p> <p>The available values are:</p> <p>Statmt(5.5x8.5) 8x10 Folio(8.5x13) SPFolio(216x315)* A5(148x210) B5-ISO(176x250)</p> <p>The factory default for paper size is SPFolio, regardless of the "Defaults" setting in the System Menu.</p>	1. Press Menu Up or Menu Down until you see:	Menus Tray Menu
	2. Press Item Up or Item Down until you see:	Tray Menu Tray2 Cust. Size
	3. Press Value Up or Value Down until you see:	Tray2 Cust. Size New Value
	4. Press Enter . You will see:	Tray Menu Tray2 Cust. Size
	5. Press Online . You will see:	Ready

Table 1.8 Page 1 of 3

Table 1.8 Tray Menu functions (continued)

Menu Item and Function	Keystrokes	Display Reads
Tray1 Type Define the type of paper installed in Tray 1. The available values are: Plain* Transparency Bond Recycled Color	1. Press Menu Up or Menu Down until you see:	Menus Tray Menu
	2. Press Item Up or Item Down until you see:	Tray Menu Tray1 Type
	3. Press Value Up or Value Down until you see:	Tray1 Type New Value
	4. Press Enter . You will see:	Tray Menu Tray1 Type
	5. Press Online . You will see:	Ready
Tray2 Type Define the type of paper installed in the optional Tray 2. The available values are: Plain* Transparency Bond Recycled Color	1. Press Menu Up or Menu Down until you see:	Menus Tray Menu
	2. Press Item Up or Item Down until you see:	Tray Menu Tray2 Type
	3. Press Value Up or Value Down until you see:	Tray2 Type New Value
	4. Press Enter . You will see:	Tray Menu Tray2 Type
	5. Press Online . You will see:	Ready

Table 1.8 Page 2 of 3

Table 1.8 Tray Menu functions *(continued)*

Menu Item and Function	Keystrokes	Display Reads
<p>Tray Sequence</p> <p>Define the order in which trays are used when more than one tray meets the size and type requirements.</p> <p>The available values are:</p> <p>1-2 2-1 Off*</p> <p>Tray switching is only available when the optional Tray 2 is installed.</p> <p>The first tray of a sequence is used until it runs out of paper, at which time the next tray in the sequence is used (if it has the correct paper size and type).</p>	1. Press Menu Up or Menu Down until you see:	Menus Tray Menu
	2. Press Item Up or Item Down until you see:	Tray Menu Tray Sequence
	3. Press Value Up or Value Down until you see:	Tray Sequence = New Value
	4. Press Enter . You will see:	Tray Menu Tray Sequence
	5. Press Online . You will see:	Ready
Table 1.8 Page 3 of 3		

PCL Menu

Use the PCL Menu to establish the default configuration for the printer when printing PCL jobs. The menu hierarchy is shown in Figure 1.5.

Figure 1.5 PCL Menu hierarchy

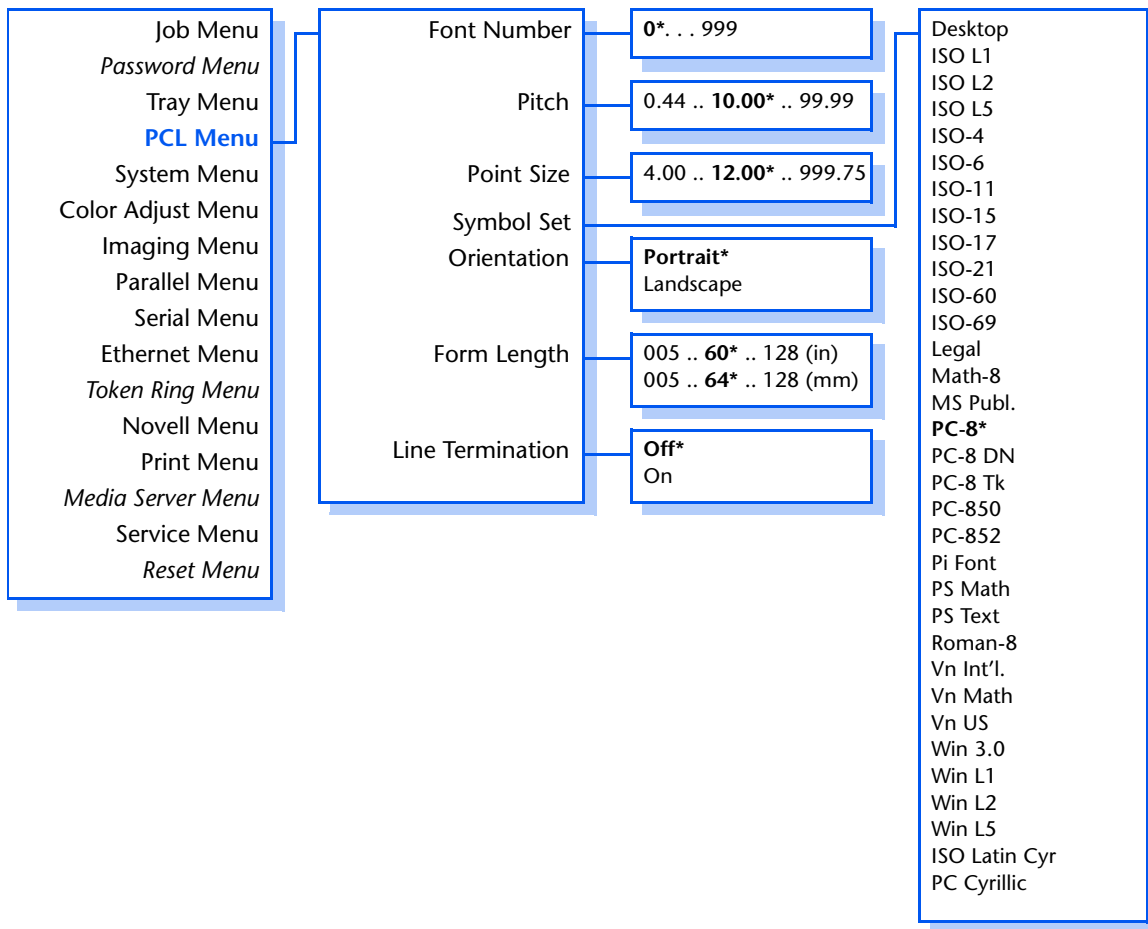

Refer to Table 1.9 on page 1-30 for step-by-step procedures.

Table 1.9 PCL Menu functions

Menu Item and Function	Keystrokes	Display Reads
<p>Font Number</p> <p>Set the ID of the default font in PCL.</p> <p>The available values are: 0* - 999</p> <p>To see the assigned font numbers, print a PCL Font List.</p> <p>The font number changes incrementally to the next valid ID each time either Value Up or Value Down is pressed. Holding down Value Up or Value Down causes continuous scrolling through the font numbers.</p>	1. Press Menu Up or Menu Down until you see:	Menus PCL Menu
	2. Press Item Up or Item Down until you see:	PCL Menu Font Number
	3. Press Value Up or Value Down until you see:	Font Number = New Value
	4. Press Enter . You will see:	PCL Menu Font Number
	5. Press Online . You will see:	Ready
<p>Pitch</p> <p>Set the pitch when the font selected is a scaleable fixed pitch font. Pitch is measured in characters per inch or c.p.i.</p> <p>The available values are: .44 - 99.99 (10.00*)</p> <p>The pitch changes incrementally by .01 each time either Value Up or Value Down is pressed. Holding down Value Up or Value Down causes continuous scrolling through the Pitch values.</p>	1. Press Menu Up or Menu Down until you see:	Menus PCL Menu
	2. Press Item Up or Item Down until you see:	PCL Menu Pitch
	3. Press Value Up or Value Down until you see:	Pitch = New Value
	4. Press Enter . You will see:	PCL Menu Pitch
	5. Press Online . You will see:	Ready

Table 1.9 Page 1 of 4

Table 1.9 PCL Menu functions (continued)

Menu Item and Function	Keystrokes	Display Reads																																	
<p>Point Size</p> <p>Set the point size when the font selected is a scaleable font. Point size is measured in parts per 72 of an inch.</p> <p>The available values are:</p> <p>4.00 - 999.75 (12.00*)</p> <p>The point size changes incrementally by .25 each time either Value Up or Value Down is pressed. Holding down Value Up or Value Down causes continuous scrolling through the point sizes.</p>	1. Press Menu Up or Menu Down until you see:	Menus PCL Menu																																	
	2. Press Item Up or Item Down until you see:	PCL Menu Point Size																																	
	3. Press Value Up or Value Down until you see:	Point Size = New Value																																	
	4. Press Enter . You will see:	PCL Menu Point Size																																	
	5. Press Online . You will see:	Ready																																	
<p>Symbol Set</p> <p>Set the default font symbol set used in PCL.</p> <p>The available values are:</p> <table border="0"> <tr> <td>Desktop</td> <td>ISO-69</td> <td>PS Text</td> </tr> <tr> <td>ISO L1</td> <td>Legal</td> <td>Roman-8</td> </tr> <tr> <td>ISO L2</td> <td>Math-8</td> <td>Vn Int'l.</td> </tr> <tr> <td>ISO L5</td> <td>Ms Publ.</td> <td>Vn Math</td> </tr> <tr> <td>ISO-4</td> <td>PC-8*</td> <td>Vn US</td> </tr> <tr> <td>ISO-6</td> <td>PC-8 DN</td> <td>Win 3.0</td> </tr> <tr> <td>ISO-11</td> <td>PC-8 Tk</td> <td>Win L1</td> </tr> <tr> <td>ISO-15</td> <td>PC-850</td> <td>Win L2</td> </tr> <tr> <td>ISO-17</td> <td>PC-852</td> <td>Win L5</td> </tr> <tr> <td>ISO-21</td> <td>Pi Font</td> <td>ISO Latin Cyr</td> </tr> <tr> <td>ISO-60</td> <td>PS Math</td> <td>PC Cyrillic</td> </tr> </table> <p>The symbol set is a collection of characters available for a font, including uppercase and lowercase alphabets, punctuation marks, and special characters such as open and close quotation marks or international characters.</p>	Desktop	ISO-69	PS Text	ISO L1	Legal	Roman-8	ISO L2	Math-8	Vn Int'l.	ISO L5	Ms Publ.	Vn Math	ISO-4	PC-8*	Vn US	ISO-6	PC-8 DN	Win 3.0	ISO-11	PC-8 Tk	Win L1	ISO-15	PC-850	Win L2	ISO-17	PC-852	Win L5	ISO-21	Pi Font	ISO Latin Cyr	ISO-60	PS Math	PC Cyrillic	1. Press Menu Up or Menu Down until you see:	Menus PCL Menu
	Desktop	ISO-69	PS Text																																
	ISO L1	Legal	Roman-8																																
	ISO L2	Math-8	Vn Int'l.																																
	ISO L5	Ms Publ.	Vn Math																																
ISO-4	PC-8*	Vn US																																	
ISO-6	PC-8 DN	Win 3.0																																	
ISO-11	PC-8 Tk	Win L1																																	
ISO-15	PC-850	Win L2																																	
ISO-17	PC-852	Win L5																																	
ISO-21	Pi Font	ISO Latin Cyr																																	
ISO-60	PS Math	PC Cyrillic																																	
2. Press Item Up or Item Down until you see:	PCL Menu Symbol Set																																		
3. Press Value Up or Value Down until you see:	Symbol Set = New Value																																		
4. Press Enter . You will see:	PCL Menu Symbol Set																																		
5. Press Online . You will see:	Ready																																		

Table 1.9 Page 2 of 4

Table 1.9 PCL Menu functions (continued)

Menu Item and Function	Keystrokes	Display Reads
<p>Orientation</p> <p>Set the default orientation used in PCL.</p> <p>The available values are:</p> <p>Portrait* Landscape</p>	1. Press Menu Up or Menu Down until you see:	Menus PCL Menu
	2. Press Item Up or Item Down until you see:	PCL Menu Orientation
	3. Press Value Up or Value Down until you see:	Orientation = New Value
	4. Press Enter . You will see:	PCL Menu Orientation
	5. Press Online . You will see:	Ready
<p>Form Length</p> <p>Set the default text length (number of lines on a page) used in PCL.</p> <p>The available values are:</p> <p>005 - 128 (60* when Default units = inches) (64* when Default units = millimeters)</p> <p>Form Length is automatically adjusted when Paper Size is changed. The Form Length is recalculated using the formula: Form Length = ((page length in inches - 1 inch) * 6).</p> <p>The Form Length value changes incrementally by 1 each time either Value Up or Value Down is pressed. Holding down Value Up or Value Down causes continuous scrolling through the Form Length values.</p> <p>The value of this setting after performing a Factory Reset depends on the value of the Default units (inches, millimeters).</p>	1. Press Menu Up or Menu Down until you see:	Menus PCL Menu
	2. Press Item Up or Item Down until you see:	PCL Menu Form Length
	3. Press Value Up or Value Down until you see:	Form Length = New Value
	4. Press Enter . You will see:	PCL Menu Form Length
	5. Press Online . You will see:	Ready

Table 1.9 Page 3 of 4

Table 1.9 PCL Menu functions (continued)

Menu Item and Function	Keystrokes	Display Reads
Line Termination Set to add a Carriage Return after every Line Feed appearing in PCL text. The available values are: Off* On This setting enables the <LF>=<CR><LF> line termination mode in PCL as the default.	1. Press Menu Up or Menu Down until you see:	Menus PCL Menu
	2. Press Item Up or Item Down until you see:	PCL Menu Line Terminat.
	3. Press Value Up or Value Down until you see:	Line Terminat. = New Value
	4. Press Enter . You will see:	PCL Menu Line Terminat.
	5. Press Online . You will see:	Ready

Table 1.9 Page 4 of 4

System Menu

Use the System Menu to set general printer features. The menu hierarchy is shown in Figure 1.6.

Figure 1.6 System Menu hierarchy with factory settings

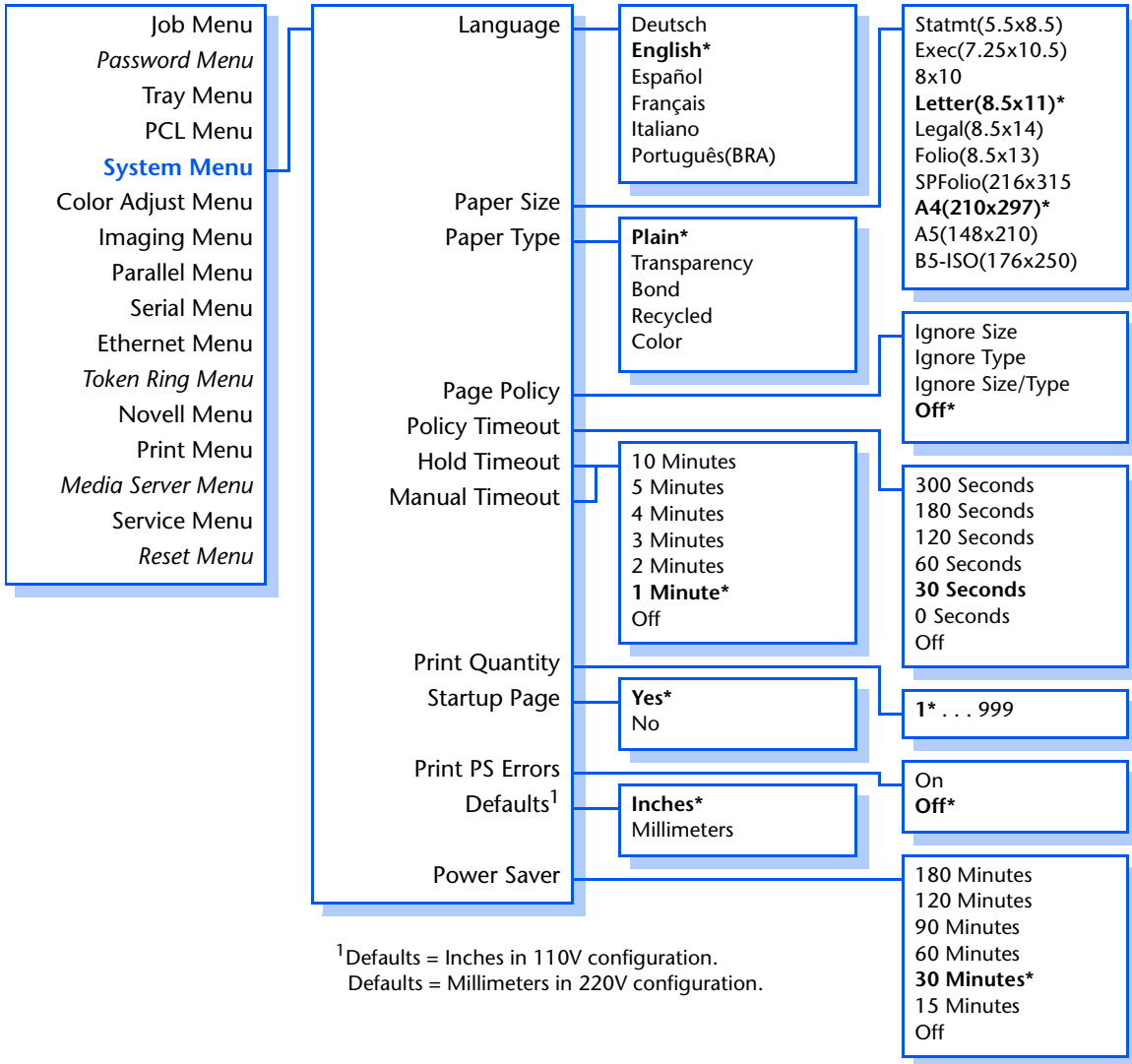

Refer to Table 1.10 on page 1-35 for step-by-step instructions.

Table 1.10 System Menu functions

Menu Item and Function	Keystrokes	Display
<p>Language</p> <p>Set the spoken language used for Control Panel display messages, Configuration Sheets, Font Lists, Demo Pages, etc.</p> <p>The available values are:</p> <p>Deutsch English* Español Français Italiano Português(BRA)</p> <p>The value of this setting is not affected by performing a "Factory Default" reset; therefore it does not have a default value apart from the initial value of <i>English</i> that is used when the printer is powered up for the first time.</p>	1. Press Menu Up or Menu Down until you see:	Menus System Menu
	2. Press Item Up or Item Down until you see:	System Menu Language
	3. Press Value Up or Value Down until you see:	Language = New Value
	4. Press Enter . You will see:	System Menu Language
	5. Press Online . You will see:	Ready (in the language just set)

Table 1.10 Page 1 of 7

Table 1.10 System Menu functions (continued)

Menu Item and Function	Keystrokes	Display
<p>Paper Size</p> <p>Set the default paper size used in PostScript and PCL.</p> <p>The available values are:</p> <p>Statmt(5.5x8.5) Exec(7.25x10.5) 8x10 Letter(8.5x11)* Legal(8.5x14) Folio(8.5x13) SPFolio(216x315) A4(210x297)* A5(148x210) B5-ISO(176x250)</p> <p>The factory default is a function of the Defaults setting (units=in/mm) in the System menu.</p>	1. Press Menu Up or Menu Down until you see:	Menus System Menu
	2. Press Item Up or Item Down until you see:	System Menu Paper Size
	3. Press Value Up or Value Down until you see:	Paper Size = New Value
	4. Press Enter . You will see:	System Menu Paper Size
	5. Press Online . You will see:	Ready
<p>Paper Type</p> <p>Set the default paper type used in PostScript and PCL.</p> <p>The available values are:</p> <p>Plain* Transparency Bond Recycled Color</p>	1. Press Menu Up or Menu Down until you see:	Menus System Menu
	2. Press Item Up or Item Down until you see:	System Menu Paper Type
	3. Press Value Up or Value Down until you see:	Paper Type = New Value
	4. Press Enter . You will see:	System Menu Paper Type
	5. Press Online . You will see:	Ready

Table 1.10 Page 2 of 7

Table 1.10 System Menu functions (continued)

Menu Item and Function	Keystrokes	Display
<p>Page Policy</p> <p>Allow the printer to automatically select an alternate paper size and/or type if the requested size and/or type is not loaded.</p> <p>The available values are:</p> <p>Ignore Size Ignore Type Ignore Size/Type Off*</p> <p>If the requested paper (size/type) is not installed, you will be prompted to load the requested paper. If the Page Policy is <i>Off</i> or the Page Policy does not satisfy the request, the printer will wait indefinitely until one of the following actions is taken:</p> <ul style="list-style-type: none"> • The job is cancelled from the Control Panel. • From the Control Panel, Value Up or Value Down is pressed to select an alternative tray to print from and then Enter is pressed. • A sheet of paper of any size or type is inserted into the Manual Bypass Feeder slot. • The proper paper (size/type) is loaded in the specified tray and the tray designation for type and size is corrected. See “Tray Menu” (page 1-25). <p>If a Page Policy is set, the printer will wait a time specified by the Policy Timeout (page 1-38) before invoking the Page Policy.</p>	1. Press Menu Up or Menu Down until you see:	Menu System Menu
	2. Press Item Up or Item Down until you see:	System Menu Page Policy
	3. Press Value Up or Value Down until you see:	Page Policy = New Value
	4. Press Enter . You will see:	System Menu Page Policy
	5. Press Online . You will see:	Ready

Table 1.10 Page 3 of 7

Table 1.10 System Menu functions (continued)

Menu Item and Function	Keystrokes	Display
<p>Policy Timeout</p> <p>Set how long the printer will wait before taking the action defined by the setting of Page Policy (page 1-37).</p> <p>The available values, in seconds, are:</p> <p>300 180 120 60 30* 0 Off</p> <p>0 means immediately invoke Page Policy. Off means never invoke Page Policy (i.e., wait indefinitely).</p>	1. Press Menu Up or Menu Down until you see:	Menus System Menu
	2. Press Item Up or Item Down until you see:	System Menu Policy Timeout
	3. Press Value Up or Value Down until you see:	Policy Timeout = New Value
	4. Press Enter . You will see:	System Menu Policy Timeout
	5. Press Online . You will see:	Ready
<p>Hold Timeout</p> <p>Set the length of time a print job is to be held at the printer when designated as a Hold Job by the printer driver.</p> <p>The available values, in minutes, are:</p> <p>10 5 4 3 2 1* Off</p> <p>The Control Panel display will indicate "HOLD JOB" and the job filename. The job will be released by pressing the Enter key if the Hold Timeout value has not been reached. If the timeout value is exceeded, the job will print.</p>	1. Press Menu Up or Menu Down until you see:	Menus System Menu
	2. Press Item Up or Item Down until you see:	System Menu Hold Timeout
	3. Press Value Up or Value Down until you see:	Hold Timeout = New Value
	4. Press Enter . You will see:	System Menu Hold Timeout
	5. Press Online . You will see:	Ready

Table 1.10 Page 4 of 7

Table 1.10 System Menu functions (continued)

Menu Item and Function	Keystrokes	Display
<p>Manual Timeout</p> <p>Set time to force printing of a job designated by the print driver to use media fed from the manual feeder. If media is not inserted into the manual feeder before timeout, the job will be printed on the media present based on printer settings.</p> <p>The available values, in minutes, are:</p> <p>10 5 4 3 2 1* Off</p>	1. Press Menu Up or Menu Down until you see:	Menus System Menu
	2. Press Item Up or Item Down until you see:	System Menu Manual Timeout
	3. Press Value Up or Value Down until you see:	Manual Timeout = New Value
	4. Press Enter . You will see:	System Menu Manual Timeout
	5. Press Online . You will see:	Ready
<p>Print Quantity</p> <p>Set the number of times each page is printed (uncollated). The setting is usually overridden by the job stream.</p> <p>The available values are:</p> <p>1* - 999</p> <p>The number of copies changes incrementally by 1 each time either Value Up or Value Down is pressed. Holding down Value Up or Value Down causes continuous scrolling through the number of copies.</p>	1. Press Menu Up or Menu Down until you see:	Menus System Menu
	2. Press Item Up or Item Down until you see:	System Menu Print Quantity
	3. Press Value Up or Value Down until you see:	Print Quantity = New Value
	4. Press Enter . You will see:	System Menu Print Quantity
	5. Press Online . You will see:	Ready

Table 1.10 Page 5 of 7

Table 1.10 System Menu functions (continued)

Menu Item and Function	Keystrokes	Display
Startup Page Set to determine if a special startup page shall be printed at each power on. The available values are: Yes* No	1. Press Menu Up or Menu Down until you see:	Menus System Menu
	2. Press Item Up or Item Down until you see:	System Menu Startup Page
	3. Press Value Up or Value Down until you see:	Startup Page = New Value
	4. Press Enter . You will see:	System Menu Startup Page
	5. Press Online . You will see:	Ready
Print PS Errors Set to control the use of the built in error handler or debugger in the PostScript interpreter. The available values are: On Off* When <i>On</i> , PostScript error information is printed. When <i>Off</i> , the job flushes and no information is provided.	1. Press Menu Up or Menu Down until you see:	Menus System Menu
	2. Press Item Up or Item Down until you see:	System Menu Print PS Errors
	3. Press Value Up or Value Down until you see:	Print PS Errors= New Value
	4. Press Enter . You will see:	System Menu Print PS Errors
	5. Press Online . You will see:	Ready

Table 1.10 Page 6 of 7

Table 1.10 System Menu functions (continued)

Menu Item and Function	Keystrokes	Display
<p>Defaults</p> <p>Sets default units. This is not changed when a “Factory Default” is performed.</p> <p>The available values are:</p> <p>Inches* (for 110V configuration) Millimeters (for 220V configuration)</p> <p>The following defaults are affected by changing this setting:</p> <ul style="list-style-type: none"> • System Menu>Paper Size • PCL Menu>FormLength. 	1. Press Menu Up or Menu Down until you see:	Menus System Menu
	2. Press Item Up or Item Down until you see:	System Menu Defaults
	3. Press Value Up or Value Down until you see:	Defaults = New Value
	4. Press Enter . You will see:	System Menu Defaults
	5. Press Online . You will see:	Ready
<p>Power Saver</p> <p>Set the time the printer will remain idle before low power mode is activated.</p> <p>The available values, in minutes, are:</p> <p>180 120 90 60 30* 15 Off (never enter Power Saver mode)</p>	1. Press Menu Up or Menu Down until you see:	Menus System Menu
	2. Press Item Up or Item Down until you see:	System Menu Power Saver
	3. Press Value Up or Value Down until you see:	Power Saver = New Value
	4. Press Enter . You will see:	System Menu Power Saver
	5. Press Online . You will see:	Ready

Table 1.10 Page 7 of 7

Color Adjust Menu

Use the Color Adjust Menu to control and adjust color density, black density, and color balance. The menu hierarchy is shown in Figure 1.7.

Figure 1.7 Color Adjust Menu hierarchy

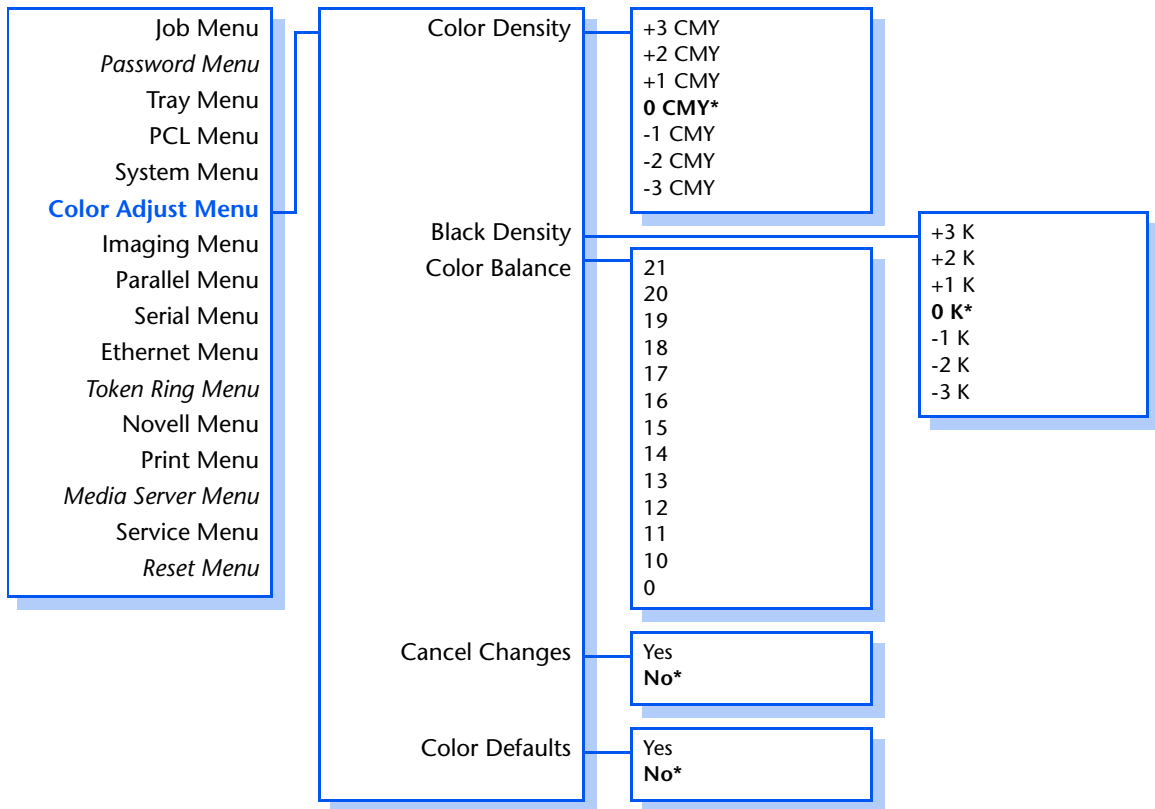

Refer to Table 1.11 on page 1-43 for step-by-step instructions.

Table 1.11 Color Adjust Menu functions

Menu Item and Function	Keystrokes	Display
Color Density Set to allow fine adjustment to the color density. The available values are: +3 CMY +2 CMY +1 CMY 0 CMY* -1 CMY -2 CMY -3 CMY A change to Color Density (i.e. pressing Enter after a value change) will cause a test print output, based upon the changed value.	1. Press Menu Up or Menu Down until you see:	Menus Color Adjust
	2. Press Item Up or Item Down until you see:	Color Adjust Color Density
	3. Press Value Up or Value Down until you see:	Color Density New Value
	4. Press Enter . You will see:	Color Adjust Color Density
	5. Press Online . You will see:	Ready
Black Density Set to allow fine adjustment of the black density. The available values are: +3 K +2 K +1 K 0 K* -1 K -2 K -3 K A change to Black Density (i.e. pressing Enter after a value change) will cause a test print output, based upon the changed value.	1. Press Menu Up or Menu Down until you see:	Menus Color Adjust
	2. Press Item Up or Item Down until you see:	Color Adjust Black Density
	3. Press Value Up or Value Down until you see:	Black Density New Value
	4. Press Enter . You will see:	Color Adjust Black Density
	5. Press Online . You will see:	Ready

Table 1.10 Page 1 of 3

Table 1.11 Color Adjust Menu functions (continued)

Menu Item and Function	Keystrokes	Display														
<p>Color Balance</p> <p>Set to allow fine adjustment to the color balance.</p> <p>The available values are:</p> <table border="0"> <tr> <td>21</td> <td>14</td> </tr> <tr> <td>20</td> <td>13</td> </tr> <tr> <td>19</td> <td>12</td> </tr> <tr> <td>18</td> <td>11</td> </tr> <tr> <td>17</td> <td>10</td> </tr> <tr> <td>16</td> <td>0</td> </tr> <tr> <td>15</td> <td></td> </tr> </table> <p>A change to Color Balance (i.e. pressing Enter after a value change) will cause a test print output, based upon the changed value.</p>	21	14	20	13	19	12	18	11	17	10	16	0	15		1. Press Menu Up or Menu Down until you see:	Menus Color Adjust
	21	14														
	20	13														
	19	12														
	18	11														
17	10															
16	0															
15																
2. Press Item Up or Item Down until you see:	Color Adjust Color Balance															
3. Press Value Up or Value Down until you see:	Color Balance New Value															
4. Press Enter . You will see:	Color Adjust Color Balance															
5. Press Online . You will see:	Ready															
<p>Cancel Changes</p> <p>Set to cancel all changes made to Color Adjustment during the current session.</p> <p>The available values are:</p> <p>Yes No*</p> <p>This operation cancels any changes made to the Color Density, Black Density, and Color Balance values during a "session" in the Color Adjust Menu. The values current at the entrance to the Color Adjust Menu are restored. Note that this cancellation also includes canceling Color Defaults. Cancel Changes will not cause a test print output. This operation cannot be undone.</p>	1. Press Menu Up or Menu Down until you see:	Menus Color Adjust														
	2. Press Item Up or Item Down until you see:	Color Adjust Cancel Changes														
	3. Press Value Up or Value Down until you see:	Cancel Changes New Value														
	4. Press Enter . You will see:	Color Adjust Cancel Changes														
	5. Press Online . You will see:	Ready														

Table 1.11 Color Adjust Menu functions (continued)

Menu Item and Function	Keystrokes	Display
Color Defaults Set to allow "resetting" all color adjustment (Color Density, Black Density, and Color Balance) to their factory default values. The available values are: Yes No* Executing Color Defaults will reset to factory defaults values and cause a test print output, based upon those factory default values.	1. Press Menu Up or Menu Down until you see:	Menus Color Adjust
	2. Press Item Up or Item Down until you see:	Color Adjust Color Defaults
	3. Press Value Up or Value Down until you see:	Color Defaults New Value
	4. Press Enter . You will see:	Color Adjust Color Defaults
	5. Press Online . You will see:	Ready
Table 1.10 Page 3 of 3		

Imaging Menu

Use the Imaging Menu to set imaging features as printer defaults. The menu hierarchy is shown in Figure 1.8.

Figure 1.8 Imaging Menu hierarchy

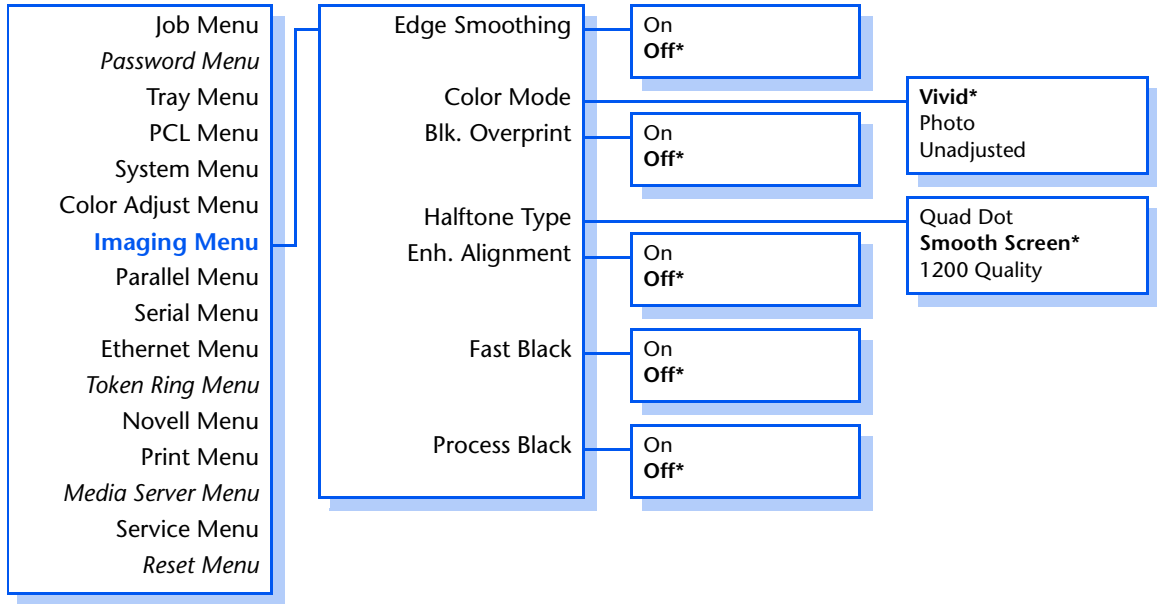

Refer to Table 1.12 on page 1-47 for step-by-step instructions.

Table 1.12 Imaging Menu functions

Menu Item and Function	Keystrokes	Display
Edge Smoothing Set the default image (resolution) enhancement mode used in PCL and PostScript. The available values are: On Off* Edge Smoothing cannot be used when the Halftone Type is set to <i>1200 Quality</i> .	1. Press Menu Up or Menu Down until you see:	Menus Imaging Menu
	2. Press Item Up or Item Down until you see:	Imaging Menu Edge Smoothing
	3. Press Value Up or Value Down until you see:	Edge Smoothing = New Value
	4. Press Enter . You will see:	Imaging Menu Edge Smoothing
	5. Press Online . You will see:	Ready
Color Mode Set to allow adjustment to the color mode. The available values are: Vivid* Photo Unadjusted	1. Press Menu Up or Menu Down until you see:	Menus Imaging Menu
	2. Press Item Up or Item Down until you see:	Imaging Menu Color Mode
	3. Press Value Up or Value Down until you see:	Color Mode = New Value
	4. Press Enter . You will see:	Imaging Menu Color Mode
	5. Press Online . You will see:	Ready
Blk. Overprint Set to select Black Overprint operation. The available values are: On Off*	1. Press Menu Up or Menu Down until you see:	Menus Imaging Menu
	2. Press Item Up or Item Down until you see:	Imaging Menu Blk. Overprint
	3. Press Value Up or Value Down until you see:	Blk. Overprint = New Value
	4. Press Enter . You will see:	Imaging Menu Blk. Overprint
	5. Press Online . You will see:	Ready

Table 1.10 Page 1 of 3

Table 1.12 Imaging Menu functions (continued)

Menu Item and Function	Keystrokes	Display
<p>Halftone Type</p> <p>Set the halftoning method.</p> <p>The available values are:</p> <p>Quad Dot Smooth Screen* 1200 Quality</p>	1. Press Menu Up or Menu Down until you see:	Menus Imaging Menu
	2. Press Item Up or Item Down until you see:	Imaging Menu Halftone Type
	3. Press Value Up or Value Down until you see:	Halftone Type = New Value
	4. Press Enter . You will see:	Imaging Menu Halftone Type
	5. Press Online . You will see:	Ready
<p>Enh. Alignment</p> <p>Set to improve image registration by enabling a skip pitch printing mode.</p> <p>The available values are:</p> <p>On Off*</p>	1. Press Menu Up or Menu Down until you see:	Menus Imaging Menu
	2. Press Item Up or Item Down until you see:	Imaging Menu Enh. Alignment
	3. Press Value Up or Value Down until you see:	Enh. Alignment = New Value
	4. Press Enter . You will see:	Imaging Menu Enh. Alignment
	5. Press Online . You will see:	Ready
<p>Fast Black</p> <p>Enable or disable printing on the transfer drum seam when in monochrome mode.</p> <p>The available values are:</p> <p>On Off*</p> <p>Image quality will be enhanced by not allowing printing on seam.</p>	1. Press Menu Up or Menu Down until you see:	Menus Imaging Menu
	2. Press Item Up or Item Down until you see:	Imaging Menu Fast Black
	3. Press Value Up or Value Down until you see:	Fast Black = New Value
	4. Press Enter . You will see:	Imaging Menu Fast Black
	5. Press Online . You will see:	Ready

Table 1.10 Page 2 of 3

Table 1.12 Imaging Menu functions (continued)

Menu Item and Function	Keystrokes	Display
Process Black Set to select process black operation. The available values are: On Off*	1. Press Menu Up or Menu Down until you see:	Menus Imaging Menu
	2. Press Item Up or Item Down until you see:	Imaging Menu Process Black
	3. Press Value Up or Value Down until you see:	Process Black = New Value
	4. Press Enter . You will see:	Imaging Menu Process Black
	5. Press Online . You will see:	Ready
Table 1.10 Page 3 of 3		

Parallel Menu

Use the Parallel Menu to set options for the parallel port connection. The menu hierarchy is shown in Figure 1.9.

Figure 1.9 Parallel Menu hierarchy

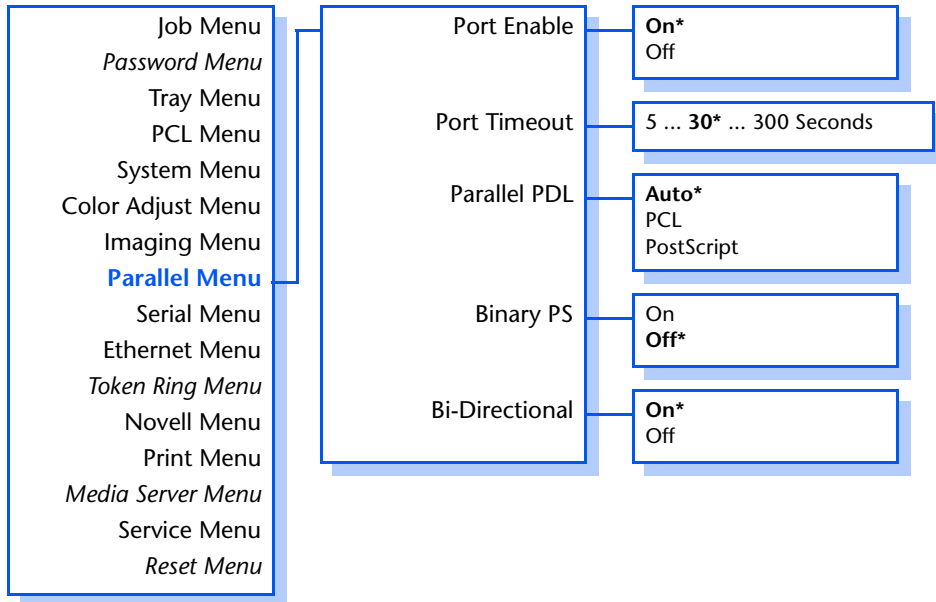

Refer to Table 1.13 on page 1-51 for step-by-step instructions.

Table 1.13 Parallel Menu functions

Menu Item and Function	Keystrokes	Display
Port Enable Enable or disable the parallel port. The available values are: On* Off	1. Press Menu Up or Menu Down until you see:	Menus Parallel Menu
	2. Press Item Up or Item Down until you see:	Parallel Menu Port Enable
	3. Press Value Up or Value Down until you see:	Port Enable = New Value
	4. Press Enter . You will see:	Parallel Menu Port Enable
	5. Press Online . You will see:	Ready
Port Timeout Set the time for determining when to end an incomplete print job and poll the next port in the polling sequence. The available values are: 5 - 300 seconds (30*) This item also causes an implicit job end such as Control D in PostScript or <ESC> E in PCL, and invokes the emulation functions associated with this action (e.g., formfeed, reset, etc.). The time changes incrementally by 1 second each time either Value Up or Value Down is pressed. Holding down Value Up or Value Down causes continuous scrolling through the values.	1. Press Menu Up or Menu Down until you see:	Menus Parallel Menu
	2. Press Item Up or Item Down until you see:	Parallel Menu Port Timeout
	3. Press Value Up or Value Down until you see:	Port Timeout = New Value
	4. Press Enter . You will see:	Parallel Menu Port Timeout
	5. Press Online . You will see:	Ready

Table 1.13 Page 1 of 2

Table 1.13 Parallel Menu functions *(continued)*

Menu Item and Function	Keystrokes	Display
<p>Parallel PDL</p> <p>Set the default emulation for the parallel port.</p> <p>The available values are:</p> <p>Auto* PCL PostScript</p>	1. Press Menu Up or Menu Down until you see:	Menus Parallel Menu
	2. Press Item Up or Item Down until you see:	Parallel Menu Parallel PDL
	3. Press Value Up or Value Down until you see:	Parallel PDL = New Value
	4. Press Enter . You will see:	Parallel Menu Parallel PDL
	5. Press Online . You will see:	Ready
<p>Binary PS</p> <p>Enable or disable the binary mode of PostScript.</p> <p>The available values are:</p> <p>On Off*</p>	1. Press Menu Up or Menu Down until you see:	Menus Parallel Menu
	2. Press Item Up or Item Down until you see:	Parallel Menu Binary PS
	3. Press Value Up or Value Down until you see:	Binary PS = New Value
	4. Press Enter . You will see:	Parallel Menu Binary PS
	5. Press Online . You will see:	Ready
<p>Bidirectional</p> <p>Enable or disable bidirectional communications through the parallel port.</p> <p>The available values are:</p> <p>On* Off</p>	1. Press Menu Up or Menu Down until you see:	Menus Parallel Menu
	2. Press Item Up or Item Down until you see:	Parallel Menu Bidirectional
	3. Press Value Up or Value Down until you see:	Bidirectional = New Value
	4. Press Enter . You will see:	Parallel Menu Bidirectional
	5. Press Online . You will see:	Ready

Serial Menu

Use the Serial Menu to set options for the serial port connection. The menu hierarchy is shown in Figure 1.10.

Figure 1.10 Serial Menu hierarchy

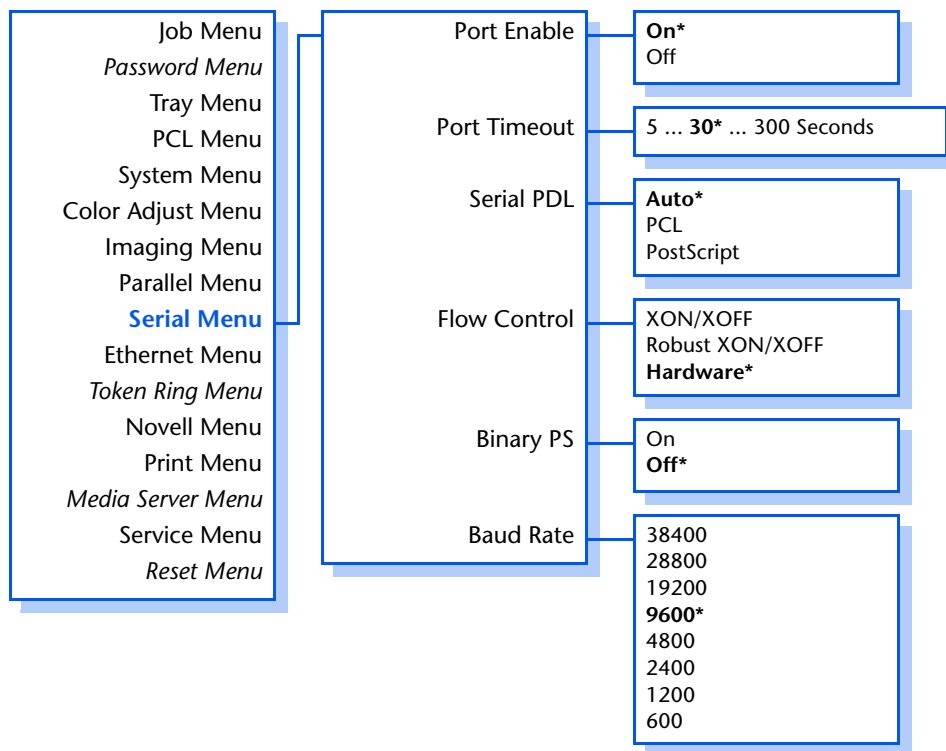

Refer to Table 1.14 on page 1-54 for step-by-step instructions.

Table 1.14 Serial Menu functions

Menu Item and Function	Keystrokes	Display
Port Enable Enable or disable the serial port. The available values are: On* Off	1. Press Menu Up or Menu Down until you see:	Menus Serial Menu
	2. Press Item Up or Item Down until you see:	Serial Menu Port Enable
	3. Press Value Up or Value Down until you see:	Port Enable = New Value
	4. Press Enter . You will see:	Serial Menu Port Enable
	5. Press Online . You will see:	Ready
Port Timeout Set the time for determining when to end an incomplete print job and poll the next port in the polling sequence. The available values are: 5 - 300 seconds (30*) This item also causes an implicit job end such as Control D in PostScript or <ESC> E in PCL, and invokes the emulation functions associated with this action (e.g., formfeed, reset, etc.). The time changes incrementally by 1 second each time either Value Up or Value Down is pressed. Holding down Value Up or Value Down causes continuous scrolling through the values.	1. Press Menu Up or Menu Down until you see:	Menus Serial Menu
	2. Press Item Up or Item Down until you see:	Serial Menu Port Timeout
	3. Press Value Up or Value Down until you see:	Port Timeout = New Value
	4. Press Enter . You will see:	Serial Menu Port Timeout
	5. Press Online . You will see:	Ready

Table 1.14 Page 1 of 3

Table 1.14 Serial Menu functions (continued)

Menu Item and Function	Keystrokes	Display
Serial PDL Set the default emulation for the serial port. The available values are: Auto* PCL Postscript	1. Press Menu Up or Menu Down until you see:	Menus Serial Menu
	2. Press Item Up or Item Down until you see:	Serial Menu Serial PDL
	3. Press Value Up or Value Down until you see:	Serial PDL = New Value
	4. Press Enter . You will see:	Serial Menu Serial PDL
	5. Press Online . You will see:	Ready
Flow Control Set the handshaking parameters for the serial port. The available values are: XON/XOFF Robust XON/XOFF Hardware*	1. Press Menu Up or Menu Down until you see:	Menus Serial Menu
	2. Press Item Up or Item Down until you see:	Serial Menu Flow Control
	3. Press Value Up or Value Down until you see:	Flow Control = New Value
	4. Press Enter . You will see:	Serial Menu Flow Control
	5. Press Online . You will see:	Ready
Binary PS Enable or disable the binary mode of PostScript. The available values are: On Off*	1. Press Menu Up or Menu Down until you see:	Menus Parallel Menu
	2. Press Item Up or Item Down until you see:	Parallel Menu Binary PS
	3. Press Value Up or Value Down until you see:	Binary PS = New Value
	4. Press Enter . You will see:	Parallel Menu Binary PS
	5. Press Online . You will see:	Ready

Table 1.14 Page 2 of 3

Table 1.14 Serial Menu functions *(continued)*

Menu Item and Function	Keystrokes	Display
Baud Rate Set the baud rate for the serial port. The available values are: 38400 28800 19200 9600* 4800 2400 1200 600	1. Press Menu Up or Menu Down until you see:	Menus Serial Menu
	2. Press Item Up or Item Down until you see:	Serial Menu Baud Rate
	3. Press Value Up or Value Down until you see:	Baud Rate = New Value
	4. Press Enter . You will see:	Serial Menu Baud Rate
	5. Press Online . You will see:	Ready

Table 1.14 Page 3 of 3

Ethernet Menu

Use the Ethernet Menu to set options for the Ethernet port. The menu hierarchy is shown in Figure 1.11 on page 1-58.

Refer to Table 1.15 on page 1-59 for step-by-step instructions.

Figure 1.11 Ethernet Menu hierarchy

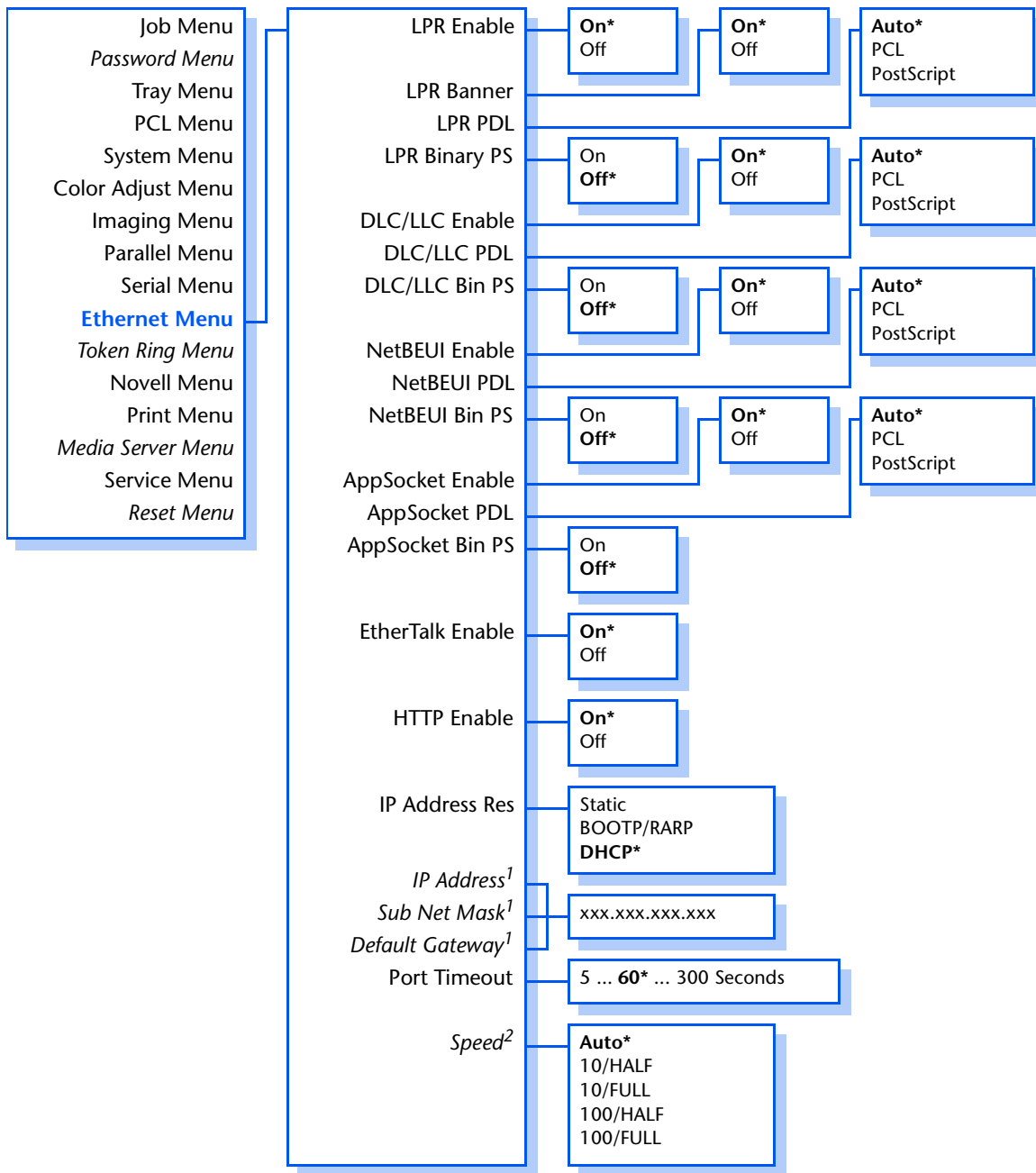

¹ Appears only if IP Address Res = Static.

² Appears only if 10/100 Ethernet option is installed.

Table 1.15 Ethernet Menu functions

Menu Item and Function	Keystrokes	Display
LPR Enable Enable or disable the Ethernet LPR protocol. The available values are: On* Off	1. Press Menu Up or Menu Down until you see:	Menus Ethernet Menu
	2. Press Item Up or Item Down until you see:	Ethernet Menu LPR Enable
	3. Press Value Up or Value Down until you see:	LPR Enable = New Value
	4. Press Enter . You will see:	Ethernet Menu LPR Enable
	5. Press Online . You will see:	Ready
LPR Banner Enable or disable the LPR banner sheet. The available values are: On Off*	1. Press Menu Up or Menu Down until you see:	Menus Ethernet Menu
	2. Press Item Up or Item Down until you see:	Ethernet Menu LPR Banner
	3. Press Value Up or Value Down until you see:	LPR Banner = New Value
	4. Press Enter . You will see:	Ethernet Menu LPR Banner
	5. Press Online . You will see:	Ready
LPR PDL Set the default emulation for the Ethernet LPR protocol. The available values are: Auto* PCL PostScript	1. Press Menu Up or Menu Down until you see:	Menus Ethernet Menu
	2. Press Item Up or Item Down until you see:	Ethernet Menu LPR PDL
	3. Press Value Up or Value Down until you see:	LPR PDL = New Value
	4. Press Enter . You will see:	Ethernet Menu LPR PDL
	5. Press Online . You will see:	Ready

Table 1.15 Page 1 of 10

Table 1.15 Ethernet Menu functions (continued)

Menu Item and Function	Keystrokes	Display
LPR Binary PS Enable or disable the LPR binary mode of PostScript. The available values are: On Off*	1. Press Menu Up or Menu Down until you see:	Menus Ethernet Menu
	2. Press Item Up or Item Down until you see:	Ethernet Menu LPR Binary PS
	3. Press Value Up or Value Down until you see:	LPR Binary PS = New Value
	4. Press Enter . You will see:	Ethernet Menu LPR Binary PS
	5. Press Online . You will see:	Ready
DLC/LLC Enable Enable or disable the DLC/LLC protocol. The available values are: On* Off	1. Press Menu Up or Menu Down until you see:	Menus Ethernet Menu
	2. Press Item Up or Item Down until you see:	Ethernet Menu DLC/LLC Enable
	3. Press Value Up or Value Down until you see:	DLC/LLC Enable = New Value
	4. Press Enter . You will see:	Ethernet Menu DLC/LLC Enable
	5. Press Online . You will see:	Ready
DLC/LLC PDL Set the default emulation for the DLC/LLC protocol. The available values are: Auto* PCL PostScript	1. Press Menu Up or Menu Down until you see:	Menus Ethernet Menu
	2. Press Item Up or Item Down until you see:	Ethernet Menu DLC/LLC PDL
	3. Press Value Up or Value Down until you see:	DLC/LLC PDL = New Value
	4. Press Enter . You will see:	Ethernet Menu DLC/LLC PDL
	5. Press Online . You will see:	Ready

Table 1.15 Page 2 of 10

Table 1.15 Ethernet Menu functions (continued)

Menu Item and Function	Keystrokes	Display
DLC/LLC Bin PS Enable or disable the DLC/LLC binary mode of PostScript. The available values are: On Off*	1. Press Menu Up or Menu Down until you see:	Menus Ethernet Menu
	2. Press Item Up or Item Down until you see:	Ethernet Menu DLC/LLC Bin PS
	3. Press Value Up or Value Down until you see:	DLC/LLC Bin PS = New Value
	4. Press Enter . You will see:	Ethernet Menu DLC/LLC Bin PS
	5. Press Online . You will see:	Ready
NetBEUI Enable Enable or disable the NetBEUI protocol. The available values are: On* Off	1. Press Menu Up or Menu Down until you see:	Menus Ethernet Menu
	2. Press Item Up or Item Down until you see:	Ethernet Menu NetBEUI Enable
	3. Press Value Up or Value Down until you see:	NetBEUI Enable = New Value
	4. Press Enter . You will see:	Ethernet Menu NetBEUI Enable
	5. Press Online . You will see:	Ready
NetBEUI PDL Set the default emulation for the NetBEUI protocol. The available values are: Auto* PCL PostScript	1. Press Menu Up or Menu Down until you see:	Menus Ethernet Menu
	2. Press Item Up or Item Down until you see:	Ethernet Menu NetBEUI PDL
	3. Press Value Up or Value Down until you see:	NetBEUI PDL = New Value
	4. Press Enter . You will see:	Ethernet Menu NetBEUI PDL
	5. Press Online . You will see:	Ready

Table 1.15 Page 3 of 10

Table 1.15 Ethernet Menu functions (continued)

Menu Item and Function	Keystrokes	Display
NetBEUI Bin PS Enable or disable the NetBEUI binary mode of PostScript. The available values are: On Off*	1. Press Menu Up or Menu Down until you see:	Menus Ethernet Menu
	2. Press Item Up or Item Down until you see:	Ethernet Menu NetBEUI Bin PS
	3. Press Value Up or Value Down until you see:	NetBEUI Bin PS = New Value
	4. Press Enter . You will see:	Ethernet Menu NetBEUI Bin PS
	5. Press Online . You will see:	Ready
AppSocket Enable Enable or disable the Ethernet AppSocket protocol. The AppSocket in the printer supports Ports 2000, 9100, and 2501. The available values are: On* Off	1. Press Menu Up or Menu Down until you see:	Menus Ethernet Menu
	2. Press Item Up or Item Down until you see:	Ethernet Menu AppSocket Enabl
	3. Press Value Up or Value Down until you see:	AppSocket Enabl= New Value
	4. Press Enter . You will see:	Ethernet Menu AppSocket Enabl
	5. Press Online . You will see:	Ready
AppSocket PDL Set the default emulation for the Ethernet AppSocket protocol. The available values are: Auto* PCL PostScript	1. Press Menu Up or Menu Down until you see:	Menus Ethernet Menu
	2. Press Item Up or Item Down until you see:	Ethernet Menu AppSocket PDL
	3. Press Value Up or Value Down until you see:	AppSocket PDL = New Value
	4. Press Enter . You will see:	Ethernet Menu AppSocket PDL
	5. Press Online . You will see:	Ready

Table 1.15 Page 4 of 10

Table 1.15 Ethernet Menu functions (continued)

Menu Item and Function	Keystrokes	Display
AppSocket Bin PS Enable or disable the AppSocket binary mode of PostScript. The available values are: On Off*	1. Press Menu Up or Menu Down until you see:	Menus Ethernet Menu
	2. Press Item Up or Item Down until you see:	Ethernet Menu AppSocket Bin PS
	3. Press Value Up or Value Down until you see:	AppSocket Bin PS= New Value
	4. Press Enter . You will see:	Ethernet Menu AppSocket Bin PS
	5. Press Online . You will see:	Ready
EtherTalk Enable Enable or disable the Ethernet EtherTalk protocol. The available values are: On* Off	1. Press Menu Up or Menu Down until you see:	Menus Ethernet Menu
	2. Press Item Up or Item Down until you see:	Ethernet Menu EtherTalk Enable
	3. Press Value Up or Value Down until you see:	EtherTalk Enable= New Value
	4. Press Enter . You will see:	Ethernet Menu EtherTalk Enable
	5. Press Online . You will see:	Ready
HTTP Enable Enable or disable the Ethernet HTTP Server protocol. The available values are: On* Off	1. Press Menu Up or Menu Down until you see:	Menus Ethernet Menu
	2. Press Item Up or Item Down until you see:	Ethernet Menu HTTP Enable
	3. Press Value Up or Value Down until you see:	HTTP Enable = New Value
	4. Press Enter . You will see:	Ethernet Menu HTTP Enable
	5. Press Online . You will see:	Ready

Table 1.15 Page 5 of 10

Table 1.15 Ethernet Menu functions (continued)

Menu Item and Function	Keystrokes	Display
IP Address Res. Set the method used to assign the IP address, including subnet mask and default gateway. The available values are: Static BOOTP/RARP DHCP*	1. Press Menu Up or Menu Down until you see:	Menus Ethernet Menu
	2. Press Item Up or Item Down until you see:	Ethernet Menu IP Address Res.
	3. Press Value Up or Value Down until you see:	IP Address Res.= New Value
	4. Press Enter . You will see:	Ethernet Menu IP Address Res.
	5. Press Online . You will see:	Ready

Table 1.15 Page 6 of 10

Table 1.15 Ethernet Menu functions (continued)

Menu Item and Function	Keystrokes	Display
<p>IP Address</p> <p>Set the four byte IP address.</p> <p>The available values are:</p> <p>xxx.xxx.xxx.xxx (where xxx = 000 to 255)</p> <p>For this item (after Step 3), Item Up moves the cursor to the right through the displayed IP address and Item Down moves the cursor to the left. This allows you to change characters within the string rather than having to reenter the entire string.</p> <p> <i>This item appears only if IP Address Res is set to Static.</i></p>	1. Press Menu Up or Menu Down until you see:	Menus Ethernet Menu
	2. Press Item Up or Item Down until you see:	Ethernet Menu IP Address
	3. Press Value Up or Value Down . You will see:	IP Address = xxx.xxx.xxx.xxx
	4. Press Value Up or Value Down to change the value of the character above the cursor. The value is incremented or decremented by 1 each time the key is pressed. Holding down Value Up or Value Down causes continuous scrolling through the values.	IP Address = xxx.xxx.xxx.xxx
	5. To change other characters in the IP address, press Item Up or Item Down to scroll right or left respectively through the character string, then press Value Up or Value Down to change the value of the character above the cursor (as in Step 4).	IP Address = xxx.xxx.xxx.xxx
	6. When you have completed setting the IP address, press Enter . You will see:	Ethernet Menu IP Address
	7. Press Online . You will see:	Ready
	8. Restart printer or power off/on.	

Table 1.15 Page 7 of 10

Table 1.15 Ethernet Menu functions (continued)

Menu Item and Function	Keystrokes	Display
<p>Subnet Mask</p> <p>Set the four byte Subnet Mask address.</p> <p>The available values are:</p> <p>xxx.xxx.xxx.xxx (where xxx = 000 to 255)</p> <p>For this item (after Step 3), Item Up moves the cursor to the right through the displayed Subnet Mask address and Item Down moves the cursor to the left. This allows you to change characters within the string rather than having to reenter the entire string.</p> <p> This item appears only if IP Address Res is set to Static.</p>	1. Press Menu Up or Menu Down until you see:	Menus Ethernet Menu
	2. Press Item Up or Item Down until you see:	Ethernet Menu Subnet Mask
	3. Press Value Up or Value Down . You will see:	Subnet Mask = xxx.xxx.xxx.xxx
	4. Press Value Up or Value Down to change the value of the character above the cursor. The value is incremented or decremented by 1 each time the key is pressed. Holding down Value Up or Value Down causes continuous scrolling through the values.	Subnet Mask = xxx.xxx.xxx.xxx
	5. To change other characters in the Subnet Mask address, press Item Up or Item Down to scroll right or left respectively through the character string, then press Value Up or Value Down to change the value of the character above the cursor (as in Step 4).	Subnet Mask = xxx.xxx.xxx.xxx
	6. When you have completed setting the Subnet Mask address, press Enter . You will see:	Ethernet Menu Subnet Mask
	7. Press Online . You will see:	Ready
	8. Restart printer or power off/on.	

Table 1.15 Page 8 of 10

Table 1.15 Ethernet Menu functions (continued)

Menu Item and Function	Keystrokes	Display
<p>Default Gateway</p> <p>Set the four byte Default Gateway address.</p> <p>The available values are:</p> <p>xxx.xxx.xxx.xxx (where xxx = 000 to 255)</p> <p>For this item (after Step 3), Item Up moves the cursor to the right through the displayed Default Gateway address and Item Down moves the cursor to the left. This allows you to change characters within the string rather than having to reenter the entire string.</p> <p>With the cursor displayed under a character, Value Up increments the value of that character and Value Down decrements the value.</p> <p> <i>This item appears only if IP Address Res is set to Static.</i></p>	1. Press Menu Up or Menu Down until you see:	Menus Ethernet Menu
	2. Press Item Up or Item Down until you see:	Ethernet Menu Default Gateway
	3. Press Value Up or Value Down . You will see:	Default Gateway= xxx.xxx.xxx.xxx
	4. Press Value Up or Value Down to change the value of the character above the cursor. The value is incremented or decremented by 1 each time the key is pressed. Holding down Value Up or Value Down causes continuous scrolling through the values.	Default Gateway= xxx.xxx.xxx.xxx
	5. To change other characters in the Default Gateway address, press Item Up or Item Down to scroll right or left respectively through the character string, then press Value Up or Value Down to change the value of the character above the cursor (as in Step 4).	Default Gateway= xxx.xxx.xxx.xxx
	6. When you have completed setting the Default Gateway address, press Enter . You will see:	Ethernet Menu Default Gateway
	7. Press Online . You will see:	Ready
	8. Restart printer or power off/on.	

Table 1.15 Page 9 of 10

Table 1.15 Ethernet Menu functions (continued)

Menu Item and Function	Keystrokes	Display
<p>Port Timeout</p> <p>Set the time for determining when to end an incomplete print job and poll the next port in the polling sequence.</p> <p>The available values are:</p> <p>5 - 300 seconds (30*)</p> <p>This item also causes an implicit job end such as Control D in PostScript or <ESC> E in PCL, and invokes the emulation functions associated with this action (e.g., formfeed, reset, etc.).</p> <p>The time changes incrementally by 1 second each time either Value Up or Value Down is pressed. Holding down Value Up or Value Down causes continuous scrolling through the values.</p>	1. Press Menu Up or Menu Down until you see:	Menus Ethernet Menu
	2. Press Item Up or Item Down until you see:	Ethernet Menu Port Timeout
	3. Press Value Up or Value Down until you see:	Port Timeout = New Value
	4. Press Enter . You will see:	Ethernet Menu Port Timeout
	5. Press Online . You will see:	Ready
<p>Speed</p> <p>Set the speed of the 10/100 Ethernet interface card (appears only if the option is installed).</p> <p>The available values are:</p> <p>Auto* 10/HALF 10/FULL 100/HALF 100/FULL</p> <p>HALF = half duplex FULL = full duplex</p>	1. Press Menu Up or Menu Down until you see:	Menus Ethernet Menu
	2. Press Item Up or Item Down until you see:	Ethernet Menu Speed
	3. Press Value Up or Value Down until you see:	Speed = New Value
	4. Press Enter . You will see:	Ethernet Menu Speed
	5. Press Online . You will see:	Ready

Table 1.15 Page 10 of 10

Token Ring Menu

Use the Token Ring Menu to set options for the Token Ring port. The menu hierarchy is shown in Figure 1.12 on page 1-70.

Refer to Table 1.16 on page 1-71 for step-by-step instructions.

Figure 1.12 Token Ring Menu hierarchy

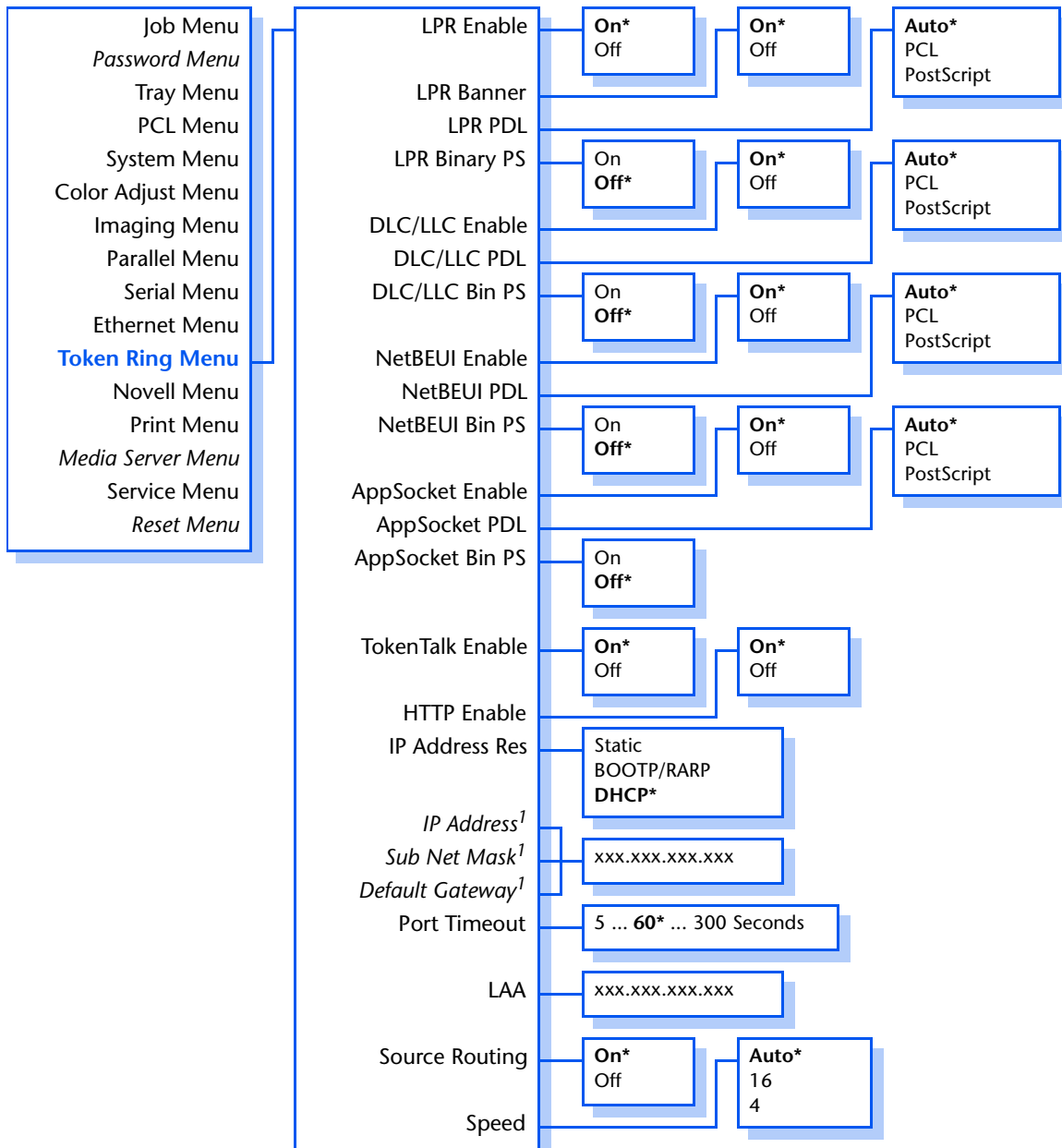

¹ Appears only if IP Address Res = Static.

Table 1.16 Token Ring Menu functions

Menu Item and Function	Keystrokes	Display
LPR Enable Enable or disable the Token Ring LPR protocol. The available values are: On* Off	1. Press Menu Up or Menu Down until you see:	Menus Token Ring Menu
	2. Press Item Up or Item Down until you see:	Token Ring Menu LPR Enable
	3. Press Value Up or Value Down until you see:	LPR Enable = New Value
	4. Press Enter . You will see:	Token Ring Menu LPR Enable
	5. Press Online . You will see:	Ready
LPR Banner Enable or disable the LPR banner sheet. The available values are: On* Off	1. Press Menu Up or Menu Down until you see:	Menus Token Ring Menu
	2. Press Item Up or Item Down until you see:	Token Ring Menu LPR Banner
	3. Press Value Up or Value Down until you see:	LPR Banner = New Value
	4. Press Enter . You will see:	Token Ring Menu LPR Banner
	5. Press Online . You will see:	Ready
LPR PDL Set the default emulation for the Token Ring LPR protocol. The available values are: Auto* PCL PostScript	1. Press Menu Up or Menu Down until you see:	Menus Token Ring Menu
	2. Press Item Up or Item Down until you see:	Token Ring Menu LPR PDL
	3. Press Value Up or Value Down until you see:	LPR PDL = New Value
	4. Press Enter . You will see:	Token Ring Menu LPR PDL
	5. Press Online . You will see:	Ready

Table 1.16 Page 1 of 12

Table 1.16 Token Ring Menu functions (continued)

Menu Item and Function	Keystrokes	Display
LPR Binary PS Enable or disable the LPR binary mode of PostScript. The available values are: On Off*	1. Press Menu Up or Menu Down until you see:	Menus Token Ring Menu
	2. Press Item Up or Item Down until you see:	Token Ring Menu LPR Binary PS
	3. Press Value Up or Value Down until you see:	LPR Binary PS = New Value
	4. Press Enter . You will see:	Token Ring Menu LPR Binary PS
	5. Press Online . You will see:	Ready
DLC/LLC Enable Enable or disable the DLC/LLC protocol. The available values are: On* Off	1. Press Menu Up or Menu Down until you see:	Menus Token Ring Menu
	2. Press Item Up or Item Down until you see:	Token Ring Menu DLC/LLC Enable
	3. Press Value Up or Value Down until you see:	DLC/LLC Enable = New Value
	4. Press Enter . You will see:	Token Ring Menu DLC/LLC Enable
	5. Press Online . You will see:	Ready
DLC/LLC PDL Set the default emulation for the DLC/LLC protocol. The available values are: Auto* PCL PostScript	1. Press Menu Up or Menu Down until you see:	Menus Token Ring Menu
	2. Press Item Up or Item Down until you see:	Token Ring Menu DLC/LLC PDL
	3. Press Value Up or Value Down until you see:	DLC/LLC PDL = New Value
	4. Press Enter . You will see:	Token Ring Menu DLC/LLC PDL
	5. Press Online . You will see:	Ready

Table 1.16 Token Ring Menu functions (continued)

Menu Item and Function	Keystrokes	Display
DLC/LLC Bin PS Enable or disable the DLC/LLC binary mode of PostScript. The available values are: On Off*	1. Press Menu Up or Menu Down until you see:	Menus Token Ring Menu
	2. Press Item Up or Item Down until you see:	Token Ring Menu DLC/LLC Bin PS
	3. Press Value Up or Value Down until you see:	DLC/LLC Bin PS = New Value
	4. Press Enter . You will see:	Token Ring Menu DLC/LLC Bin PS
	5. Press Online . You will see:	Ready
NetBEUI Enable Enable or disable the NetBEUI protocol. The available values are: On* Off	1. Press Menu Up or Menu Down until you see:	Menus Token Ring Menu
	2. Press Item Up or Item Down until you see:	Token Ring Menu NetBEUI Enable
	3. Press Value Up or Value Down until you see:	NetBEUI Enable = New Value
	4. Press Enter . You will see:	Token Ring Menu NetBEUI Enable
	5. Press Online . You will see:	Ready
NetBEUI PDL Set the default emulation for the NetBEUI protocol. The available values are: Auto* PCL PostScript	1. Press Menu Up or Menu Down until you see:	Menus Token Ring Menu
	2. Press Item Up or Item Down until you see:	Token Ring Menu NetBEUI PDL
	3. Press Value Up or Value Down until you see:	NetBEUI PDL = New Value
	4. Press Enter . You will see:	Token Ring Menu NetBEUI PDL
	5. Press Online . You will see:	Ready

Table 1.16 Page 3 of 12

Table 1.16 Token Ring Menu functions (continued)

Menu Item and Function	Keystrokes	Display
NetBEUI Bin PS Enable or disable the NetBEUI binary mode of PostScript. The available values are: On Off*	1. Press Menu Up or Menu Down until you see:	Menus Token Ring Menu
	2. Press Item Up or Item Down until you see:	Token Ring Menu NetBEUI Bin PS
	3. Press Value Up or Value Down until you see:	NetBEUI Bin PS = New Value
	4. Press Enter . You will see:	Token Ring Menu NetBEUI Bin PS
	5. Press Online . You will see:	Ready
AppSocket Enable Enable or disable the Token Ring AppSocket protocol. The AppSocket in the printer supports Ports 200, 9100, and 2105. The available values are: On* Off	1. Press Menu Up or Menu Down until you see:	Menus Token Ring Menu
	2. Press Item Up or Item Down until you see:	Token Ring Menu AppSocket Enabl
	3. Press Value Up or Value Down until you see:	AppSocket Enabl= New Value
	4. Press Enter . You will see:	Token Ring Menu AppSocket Enabl
	5. Press Online . You will see:	Ready
AppSocket PDL Set the default emulation for the Token Ring AppSocket protocol. The available values are: Auto* PCL PostScript	1. Press Menu Up or Menu Down until you see:	Menus Token Ring Menu
	2. Press Item Up or Item Down until you see:	Token Ring Menu AppSocket PDL
	3. Press Value Up or Value Down until you see:	AppSocket PDL = New Value
	4. Press Enter . You will see:	Token Ring Menu AppSocket PDL
	5. Press Online . You will see:	Ready

Table 1.16 Token Ring Menu functions (continued)

Menu Item and Function	Keystrokes	Display
AppSocket Bin PS Enable or disable the AppSocket binary mode of PostScript. The available values are: On Off*	1. Press Menu Up or Menu Down until you see:	Menus Token Ring Menu
	2. Press Item Up or Item Down until you see:	Token Ring Menu AppSocket Bin PS
	3. Press Value Up or Value Down until you see:	AppSocket Bin PS= New Value
	4. Press Enter . You will see:	Token Ring Menu AppSocket Bin PS
	5. Press Online . You will see:	Ready
TokenTalk Enable Enable or disable the Token Ring TokenTalk protocol. The available values are: On* Off	1. Press Menu Up or Menu Down until you see:	Menus Token Ring Menu
	2. Press Item Up or Item Down until you see:	Token Ring Menu TokenTalk Enable
	3. Press Value Up or Value Down until you see:	TokenTalk Enable= New Value
	4. Press Enter . You will see:	Token Ring Menu TokenTalk Enable
	5. Press Online . You will see:	Ready
HTTP Enable Enable or disable the Token Ring HTTP Server protocol. The available values are: On* Off	1. Press Menu Up or Menu Down until you see:	Menus Token Ring Menu
	2. Press Item Up or Item Down until you see:	Token Ring Menu HTTP Enable
	3. Press Value Up or Value Down until you see:	HTTP Enable = New Value
	4. Press Enter . You will see:	Token Ring Menu HTTP Enable
	5. Press Online . You will see:	Ready

Table 1.16 Page 5 of 12

Table 1.16 Token Ring Menu functions (continued)

Menu Item and Function	Keystrokes	Display
IP Address Res. Set the method used to assign the IP address, including subnet mask and default gateway. The available values are: Static BOOTP/RARP DHCP*	1. Press Menu Up or Menu Down until you see:	Menus Token Ring Menu
	2. Press Item Up or Item Down until you see:	Token Ring Menu IP Address Res.
	3. Press Value Up or Value Down until you see:	IP Address Res.= New Value
	4. Press Enter . You will see:	Token Ring Menu IP Address Res.
	5. Press Online . You will see:	Ready

Table 1.16 Page 6 of 12

Table 1.16 Token Ring Menu functions (continued)

Menu Item and Function	Keystrokes	Display
<p>IP Address</p> <p>Set the four byte IP address.</p> <p>The available values are:</p> <p>xxx.xxx.xxx.xxx (where xxx = 000 to 255)</p> <p>For this item (after Step 3), Item Up moves the cursor to the right through the displayed IP address and Item Down moves the cursor to the left. This allows you to change characters within the string rather than having to reenter the entire string.</p> <p>With the cursor displayed under a character, Value Up increments the value of that character and Value Down decrements the value.</p> <p> <i>This item appears only if IP Address Res is set to Static.</i></p>	1. Press Menu Up or Menu Down until you see:	Menus Token Ring Menu
	2. Press Item Up or Item Down until you see:	Token Ring Menu IP Address
	3. Press Value Up or Value Down . You will see:	IP Address = xxx.xxx.xxx.xxx
	4. Press Value Up or Value Down to change the value of the character above the cursor. The value is incremented or decremented by 1 each time the key is pressed. Holding down Value Up or Value Down causes continuous scrolling through the values.	IP Address = xxx.xxx.xxx.xxx
	5. To change other characters in the IP address, press Item Up or Item Down to scroll right or left respectively through the character string, then press Value Up or Value Down to change the value of the character above the cursor (as in Step 4).	IP Address = xxx.xxx.xxx.xxx
	6. When you have completed setting the IP address, press Enter . You will see:	Token Ring Menu IP Address
	7. Press Online . You will see:	Ready
	8. Restart printer or power off/on.	

Table 1.16 Page 7 of 12

Table 1.16 Token Ring Menu functions (continued)

Menu Item and Function	Keystrokes	Display
<p>Subnet Mask</p> <p>Set the four byte Subnet Mask address.</p> <p>The available values are:</p> <p>xxx.xxx.xxx.xxx (where xxx = 000 to 255)</p> <p>For this item (after Step 3), Item Up moves the cursor to the right through the displayed Subnet Mask address and Item Down moves the cursor to the left. This allows you to change characters within the string rather than having to reenter the entire string.</p> <p>With the cursor displayed under a character, Value Up increments the value of that character and Value Down decrements the value.</p> <p> <i>This item appears only if IP Address Res is set to Static.</i></p>	1. Press Menu Up or Menu Down until you see:	Menus Token Ring Menu
	2. Press Item Up or Item Down until you see:	Token Ring Menu Subnet Mask
	3. Press Value Up or Value Down . You will see:	Subnet Mask = xxx.xxx.xxx.xxx
	4. Press Value Up or Value Down to change the value of the character above the cursor. The value is incremented or decremented by 1 each time the key is pressed. Holding down Value Up or Value Down causes continuous scrolling through the values.	Subnet Mask = xxx.xxx.xxx.xxx
	5. To change other characters in the Subnet Mask address, press Item Up or Item Down to scroll right or left respectively through the character string, then press Value Up or Value Down to change the value of the character above the cursor (as in Step 4).	Subnet Mask = xxx.xxx.xxx.xxx
	6. When you have completed setting the Subnet Mask address, press Enter . You will see:	Token Ring Menu Subnet Mask
	7. Press Online . You will see:	Ready
	8. Restart printer or power off/on.	

Table 1.16 Page 8 of 12

Table 1.16 Token Ring Menu functions (continued)

Menu Item and Function	Keystrokes	Display
<p>Default Gateway</p> <p>Set the four byte Default Gateway address.</p> <p>The available values are:</p> <p>xxx.xxx.xxx.xxx (where xxx = 000 to 255)</p> <p>For this item (after Step 3), Item Up moves the cursor to the right through the displayed Default Gateway address and Item Down moves the cursor to the left. This allows you to change characters within the string rather than having to reenter the entire string.</p> <p>With the cursor displayed under a character, Value Up increments the value of that character and Value Down decrements the value.</p> <p> <i>This item appears only if IP Address Res is set to Static.</i></p>	1. Press Menu Up or Menu Down until you see:	Menus Token Ring Menu
	2. Press Item Up or Item Down until you see:	Token Ring Menu Default Gateway
	3. Press Value Up or Value Down . You will see:	Default Gateway= xxx.xxx.xxx.xxx
	4. Press Value Up or Value Down to change the value of the character above the cursor. The value is incremented or decremented by 1 each time the key is pressed. Holding down Value Up or Value Down causes continuous scrolling through the values.	Default Gateway= xxx.xxx.xxx.xxx
	5. To change other characters in the Default Gateway address, press Item Up or Item Down to scroll right or left respectively through the character string, then press Value Up or Value Down to change the value of the character above the cursor (as in Step 4).	Default Gateway= xxx.xxx.xxx.xxx
	6. When you have completed setting the Default Gateway address, press Enter . You will see:	Token Ring Menu Default Gateway
	7. Press Online . You will see:	Ready
	8. Restart printer or power off/on.	

Table 1.16 Page 9 of 12

Table 1.16 Token Ring Menu functions (continued)

Menu Item and Function	Keystrokes	Display
<p>Port Timeout</p> <p>Set the time for determining when to end an incomplete print job and poll the next port in the polling sequence.</p> <p>The available values are:</p> <p>5 - 300 seconds (60*)</p> <p>This item also causes an implicit job end such as Control D in PostScript or <ESC> E in PCL, and invokes the emulation functions associated with this action (e.g., formfeed, reset, etc.).</p> <p>The time changes incrementally by 1 second each time either Value Up or Value Down is pressed. Holding down Value Up or Value Down causes continuous scrolling through the values.</p>	1. Press Menu Up or Menu Down until you see:	Menus Token Ring Menu
	2. Press Item Up or Item Down until you see:	Token Ring Menu Port Timeout
	3. Press Value Up or Value Down until you see:	Port Timeout = New Value
	4. Press Enter . You will see:	Token Ring Menu Port Timeout
	5. Press Online . You will see:	Ready

Table 1.16 Page 10 of 12

Table 1.16 Token Ring Menu functions (continued)

Menu Item and Function	Keystrokes	Display
<p>LAA</p> <p>Set the six byte Locally Administered Address.</p> <p>The valid values are:</p> <p>xxxx xxxx xxxx (where xxxx xxxx xxxx can equal any value within the valid range of 4000 0000 0000 and 7FFF FFFF FFFF)</p> <p>For this item (after Step 3), Item Up moves the cursor to the right through the displayed LAA and Item Down moves the cursor to the left. This allows you to change characters within the string rather than having to reenter the entire string.</p> <p>With the cursor displayed under a character, Value Up increments the value of that character and Value Down decrements the value.</p>	1. Press Menu Up or Menu Down until you see:	Menus Token Ring Menu
	2. Press Item Up or Item Down until you see:	Token Ring Menu LAA
	3. Press Value Up or Value Down . You will see:	LAA = xxxx xxxx xxxx
	4. Press Value Up or Value Down to change the value of the character above the cursor. The value is incremented or decremented by 1 each time the key is pressed. Holding down Value Up or Value Down causes continuous scrolling through the values.	LAA = xxxx xxxx xxxx
	5. To change other characters in the LAA, press Item Up or Item Down to scroll right or left respectively through the character string, then press Value Up or Value Down to change the value of the character above the cursor (as in Step 4).	LAA = xxxx xxxx xxxx
	6. When you have completed setting the LAA, press Enter . You will see:	Token Ring Menu LAA
	7. Press Online . You will see:	Ready

Table 1.16 Page 11 of 12

Table 1.16 Token Ring Menu functions (continued)

Menu Item and Function	Keystrokes	Display
Source Routing Select the Source Routing option. The available values are: On* Off	1. Press Menu Up or Menu Down until you see:	Menus Token Ring Menu
	2. Press Item Up or Item Down until you see:	Token Ring Menu Source Routing
	3. Press Value Up or Value Down until you see:	Source Routing = New Value
	4. Press Enter . You will see:	Token Ring Menu Source Routing
	5. Press Online . You will see:	Ready
Speed Select the Token Ring speed option. The available values are: Auto* 16 4	1. Press Menu Up or Menu Down until you see:	Menus Token Ring Menu
	2. Press Item Up or Item Down until you see:	Token Ring Menu Speed
	3. Press Value Up or Value Down until you see:	Speed = New Value
	4. Press Enter . You will see:	Token Ring Menu Speed
	5. Press Online . You will see:	Ready

Table 1.16 Page 12 of 12

Novell Menu

Use the Novell Menu to modify Novell parameters. The menu hierarchy is shown in Figure 1.13. Items in italics appear only if Novell Enable is set to *On*.

Figure 1.13 Novell Menu hierarchy with factory settings

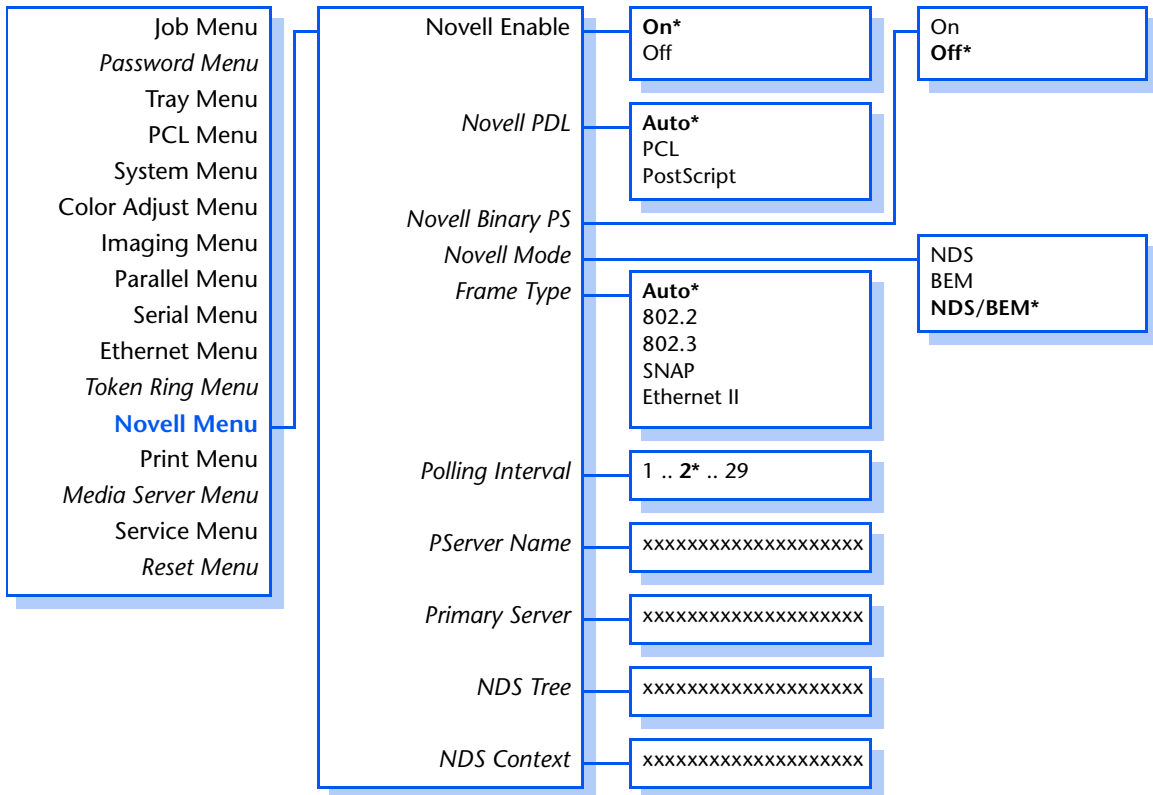

Refer to Table 1.17 on page 1-84 for step-by-step instructions.

Table 1.17 Novell Menu functions

Menu Item and Function	Keystrokes	Display
Novell Enable Enable or disable the Novell protocol. The available values are: On* Off	1. Press Menu Up or Menu Down until you see:	Menus Novell Menu
	2. Press Item Up or Item Down until you see:	Novell Menu Novell Enable
	3. Press Value Up or Value Down until you see:	Novell Enable = New Value
	4. Press Enter . You will see:	Novell Menu Novell Enable
	5. Press Online . You will see:	Ready
Novell PDL Set the default emulation for the Novell protocol. The available values are: Auto* PCL PostScript	1. Press Menu Up or Menu Down until you see:	Menus Novell Menu
	2. Press Item Up or Item Down until you see:	Novell Menu Novell PDL
	3. Press Value Up or Value Down until you see:	Novell PDL = New Value
	4. Press Enter . You will see:	Novell Menu Novell PDL
	5. Press Online . You will see:	Ready

Table 1.17 Page 1 of 7

Table 1.17 Novell Menu functions (continued)

Menu Item and Function	Keystrokes	Display
Novell Binary PS Enable or disable the Novell binary mode of PostScript. The available values are: On Off*	1. Press Menu Up or Menu Down until you see:	Menus Novell Menu
	2. Press Item Up or Item Down until you see:	Novell Menu Novell Binary PS
	3. Press Value Up or Value Down until you see:	Novell Binary PS= New Value
	4. Press Enter . You will see:	Novell Menu Novell Binary PS
	5. Press Online . You will see:	Ready
Novell Mode Set the PServer mode for the Novell protocol. The available values are: NDS BEM NDS/BEM*	1. Press Menu Up or Menu Down until you see:	Menus Novell Menu
	2. Press Item Up or Item Down until you see:	Novell Menu Novell Mode
	3. Press Value Up or Value Down until you see:	Novell Mode = New Value
	4. Press Enter . You will see:	Novell Menu Novell Mode
	5. Press Online . You will see:	Ready

Table 1.17 Page 2 of 7

Table 1.17 Novell Menu functions (continued)

Menu Item and Function	Keystrokes	Display
<p>Frame Type</p> <p>Sets the frame type used for the Novell protocol.</p> <p>The available values are:</p> <p>Auto* 802.2 802.3 SNAP Ethernet II</p>	1. Press Menu Up or Menu Down until you see:	Menus Novell Menu
	2. Press Item Up or Item Down until you see:	Novell Menu Frame Type
	3. Press Value Up or Value Down until you see:	Frame Type = New Value
	4. Press Enter . You will see:	Novell Menu Frame Type
	5. Press Online . You will see:	Ready
<p>Polling Interval</p> <p>Set the rate (in seconds) at which the PServer issues polling requests for assigned queues.</p> <p>The available values are:</p> <p>1 - 29 (2*)</p> <p>The Polling Interval changes incrementally by 1 each time either Value Up or Value Down is pressed. Holding down Value Up or Value Down causes continuous scrolling through the values.</p>	1. Press Menu Up or Menu Down until you see:	Menus Novell Menu
	2. Press Item Up or Item Down until you see:	Novell Menu Polling Interval
	3. Press Value Up or Value Down until you see:	Polling Interval= New Value
	4. Press Enter . You will see:	Novell Menu Polling Interval
	5. Press Online . You will see:	Ready

Table 1.17 Page 3 of 7

Table 1.17 Novell Menu functions (continued)

Menu Item and Function	Keystrokes	Display
<p>PServer Name</p> <p>Set the name of the PServer in this printer (a name of 1 to 47 characters in length).</p> <p>The available values are:</p> <p>A - Z, 0 - 9, hyphen (-), underscore (_) XXR_<macaddress>*</p> <p>For this item (after Step 3), Item Up moves the cursor to the right through the displayed PServer name and Item Down moves the cursor to the left. This allows you to change characters within the string rather than having to reenter the entire string.</p> <p>With the cursor displayed under a character, Value Up increments the value of that character and Value Down decrements the value.</p>	1. Press Menu Up or Menu Down until you see:	Menus Novell Menu
	2. Press Item Up or Item Down until you see:	Novell Menu PServer Name
	3. Press Value Up or Value Down . You will see:	PServer Name = xxx...xxx
	4. Press Value Up or Value Down to change the value of the character above the cursor. The value is incremented or decremented by 1 each time the key is pressed. Holding down Value Up or Value Down causes continuous scrolling through the values.	PServer Name = xxx...xxx
	5. To change other characters in the PServer name, press Item Up or Item Down to scroll right or left respectively through the character string, then press Value Up or Value Down to change the value of the character above the cursor (as in Step 4).	PServer Name = xxx...xxx
	6. When you have completed setting the PServer Name, press Enter . You will see:	Novell Menu PServer Name
	7. Press Online . You will see:	Ready

Table 1.17 Page 4 of 7

Table 1.17 Novell Menu functions (continued)

Menu Item and Function	Keystrokes	Display
<p>Primary Server</p> <p>Set the name of the Primary file server (a name of 1 to 47 characters in length).</p> <p>The available values are:</p> <p>A - Z, 0 - 9, hyphen (-) and underscore (_) Null*</p> <p>For this item (after Step 3), Item Up moves the cursor to the right through the displayed Primary Server name and Item Down moves the cursor to the left. This allows you to change characters within the string rather than having to reenter the entire string.</p> <p>With the cursor displayed under a character, Value Up increments the value of that character and Value Down decrements the value.</p>	1. Press Menu Up or Menu Down until you see:	Menus Novell Menu
	2. Press Item Up or Item Down until you see:	Novell Menu Primary Server
	3. Press Value Up or Value Down . You will see:	Primary Server = xxx...xxx
	4. Press Value Up or Value Down to change the value of the character above the cursor. The value is incremented or decremented by 1 each time the key is pressed. Holding down Value Up or Value Down causes continuous scrolling through the values.	Primary Server = xxx...xxx
	5. To change other characters in the Primary Server name, press Item Up or Item Down to scroll right or left respectively through the character string, then press Value Up or Value Down to change the value of the character above the cursor (as in Step 4).	Primary Server = xxx...xxx
	6. When you have completed setting the Primary Server name, press Enter . You will see:	Novell Menu Primary Server
	7. Press Online . You will see:	Ready

Table 1.17 Page 5 of 7

Table 1.17 Novell Menu functions (continued)

Menu Item and Function	Keystrokes	Display
<p>NDS Tree</p> <p>Set the NDS Tree character string (from 1 to 64 characters in length).</p> <p>The available values are:</p> <p>A - Z, 0 - 9, hyphen (-) and underscore (_) Null*</p> <p>For this item (after Step 3), Item Up moves the cursor to the right through the displayed NDS Tree character string and Item Down moves the cursor to the left. This allows you to change characters within the string rather than having to reenter the entire string.</p> <p>With the cursor displayed under a character, Value Up increments the value of that character and Value Down decrements the value.</p>	1. Press Menu Up or Menu Down until you see:	Menus Novell Menu
	2. Press Item Up or Item Down until you see:	Novell Menu NDS Tree
	3. Press Value Up or Value Down . You will see:	NDS Tree = xxx...xxx
	4. Press Value Up or Value Down to change the value of the character above the cursor. The value is incremented or decremented by 1 each time the key is pressed. Holding down Value Up or Value Down causes continuous scrolling through the values.	NDS Tree = xxx...xxx
	5. To change other characters in the NDS Tree character string, press Item Up or Item Down to scroll right or left respectively through the character string, then press Value Up or Value Down to change the value of the character above the cursor (as in Step 4).	NDS Tree = xxx...xxx
	6. When you have completed setting the NDS Tree, press Enter . You will see:	Novell Menu NDS Tree
	7. Press Online . You will see:	Ready

Table 1.17 Page 6 of 7

Table 1.17 Novell Menu functions (continued)

Menu Item and Function	Keystrokes	Display
<p>NDS Context</p> <p>Set the NDS context string (from 1 to 255 characters in length).</p> <p>The available values are:</p> <p>A - Z, 0 - 9, hyphen (-), period (.), underscore (_), equal (=) Null*</p> <p>For this item (after Step 3), Item Up moves the cursor to the right through the displayed NDS Context string and Item Down moves the cursor to the left. This allows you to change characters within the string rather than having to reenter the entire string.</p> <p>With the cursor displayed under a character, Value Up increments the value of that character and Value Down decrements the value.</p>	1. Press Menu Up or Menu Down until you see:	Menus Novell Menu
	2. Press Item Up or Item Down until you see:	Novell Menu NDS Context
	3. Press Value Up or Value Down . You will see:	NDS Context = xxx...xxx
	4. Press Value Up or Value Down to change the value of the character above the cursor. The value is incremented or decremented by 1 each time the key is pressed. Holding down Value Up or Value Down causes continuous scrolling through the values.	NDS Context = xxx...xxx
	5. To change other characters in the NDS Context string, press Item Up or Item Down to scroll right or left respectively through the character string, then press Value Up or Value Down to change the value of the character above the cursor (as in Step 4).	NDS Context = xxx...xxx
	6. When you have completed setting the NDS Context, press Enter . You will see:	Novell Menu NDS Context
	7. Press Online . You will see:	Ready

Table 1.17 Page 7 of 7

Print Menu

Use the Print Menu to print internal files or files downloaded to the printer's hard disk drive. The menu hierarchy is shown in Figure 1.14.

Figure 1.14 Print Menu hierarchy with factory settings

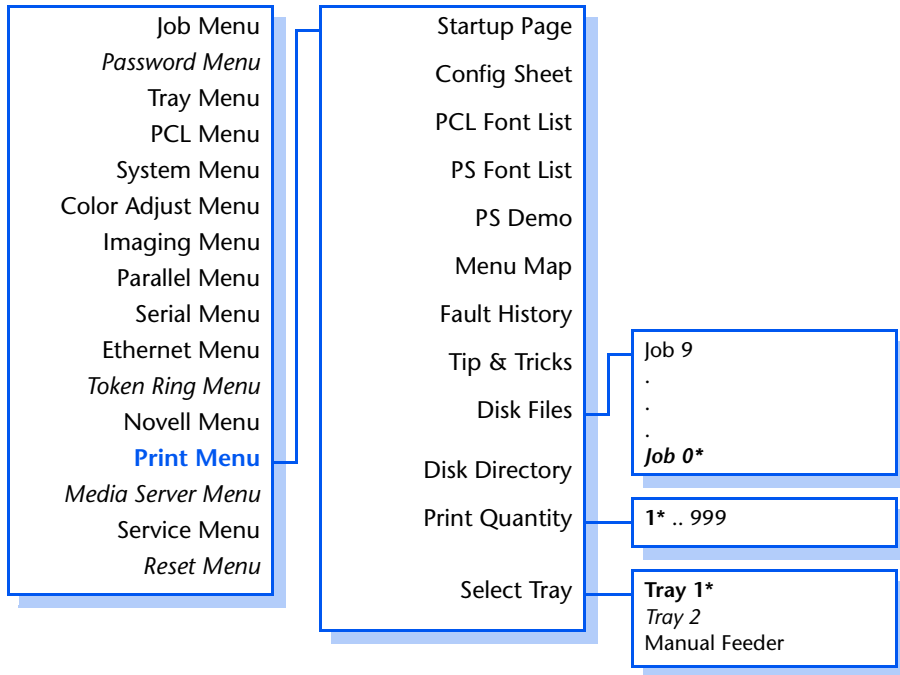

Refer to Table 1.18 on page 1-92 for step-by-step instructions.

Table 1.18 Print Menu functions

Menu Item and Function	Keystrokes	Display
<p>Startup Page</p> <p>Print a Startup Page.</p> <p>The Startup Page is formatted for either Letter or A4 paper size, regardless of the default paper size or the actual paper size loaded.</p>	1. Press Menu Up or Menu Down until you see:	Menus Print Menu
	2. Press Item Up or Item Down until you see:	Print Menu Startup Page
	3. Press Enter . You will see:	Printing Startup Page
	4. When completed, you will see:	Ready
<p>Config Sheet</p> <p>Print a Configuration Sheet showing the printer's current information and menu settings.</p> <p>The Configuration Sheet is formatted for either Letter or A4 paper size, regardless of the default paper size or the actual paper size loaded.</p>	1. Press Menu Up or Menu Down until you see:	Menus Print Menu
	2. Press Item Up or Item Down until you see:	Print Menu Config Sheet
	3. Press Enter . You will see:	Printing Config Sheet
	4. When completed, you will see:	Ready
<p>PCL Font List</p> <p>Print a list of PCL fonts currently loaded.</p> <p>The PCL Font List is formatted for either Letter or A4 paper size, regardless of the default paper size or the actual paper size loaded. There are no multiple copies. The Print Menu setting for Print Quantity is ignored. Source tray is determined by the Select Tray item.</p>	1. Press Menu Up or Menu Down until you see:	Menus Print Menu
	2. Press Item Up or Item Down until you see:	Print Menu PCL Font List
	3. Press Enter . You will see:	Printing PCL Font List
	4. When completed, you will see:	Ready

Table 1.18 Page 1 of 4

Table 1.18 Print Menu functions (continued)

Menu Item and Function	Keystrokes	Display
<p>PS Font List</p> <p>Print the list of the fonts available in PostScript, including resident fonts and fonts stored on the hard disk.</p> <p>The PS Font List is formatted for either Letter or A4 paper size, regardless of the default paper size or the actual paper size loaded</p>	1. Press Menu Up or Menu Down until you see:	Menus Print Menu
	2. Press Item Up or Item Down until you see:	Print Menu PS Font List
	3. Press Enter . You will see:	Printing PS Font List
	4. When completed, you will see:	Ready
<p>PS Demo</p> <p>Print a PostScript demonstration page that shows the printer features.</p> <p>The PS Demo page is formatted for either Letter or A4 paper size, regardless of the default paper size or the actual paper size loaded</p>	1. Press Menu Up or Menu Down until you see:	Menus Print Menu
	2. Press Item Up or Item Down until you see:	Print Menu PS Demo Page
	3. Press Enter . You will see:	Printing PS Demo Page
	4. When completed, you will see:	Ready
<p>Menu Map</p> <p>Print the menu map/Control Panel menu tree.</p> <p>Menu Maps are formatted for either Letter or A4 paper size, regardless of the default paper size or the actual paper size loaded. There are no multiple copies. The Print Menu setting for Print Quantity is ignored. Source tray is determined by the Select Tray item.</p>	1. Press Menu Up or Menu Down until you see:	Menus Print Menu
	2. Press Item Up or Item Down until you see:	Print Menu Menu Map
	3. Press Enter . You will see:	Printing Menu Map
	4. When completed, you will see:	Ready

Table 1.18 Page 2 of 4

Table 1.18 Print Menu functions *(continued)*

Menu Item and Function	Keystrokes	Display
<p>Fault History Print a log of the printer's last fifty faults.</p>	1. Press Menu Up or Menu Down until you see:	Menus Print Menu
	2. Press Item Up or Item Down until you see:	Print Menu Fault History
	3. Press Enter . You will see:	Printing Fault History
	4. When completed, you will see:	Ready
<p>Tips & Tricks Print information on how to get the most from your DocuPrint NC60.</p>	1. Press Menu Up or Menu Down until you see:	Menus Print Menu
	2. Press Item Up or Item Down until you see:	Print Menu Tips & Tricks
	3. Press Enter . You will see:	Printing Tips & Tricks
	4. When completed, you will see:	Ready
<p>Disk Files Print files downloaded to the optional hard disk (not Secure Jobs or Proof Jobs). Files can be downloaded to the hard disk using CentreWare DP. Job number (i.e. "Job 3") only appears if a file is loaded in that position.</p>	1. Press Menu Up or Menu Down until you see:	Menus Print Menu
	2. Press Item Up or Item Down until you see:	Print Menu Disk Files
	3. Press Value Up or Value Down until you see:	Disk Files = Job Number
	4. Press Enter . You will see:	Printing Job Number
	5. When completed, you will see:	Ready

Table 1.18 Page 3 of 4

Table 1.18 Print Menu functions (continued)

Menu Item and Function	Keystrokes	Display
Disk Directory Print a list of fonts and macros downloaded to the hard disk. This procedure does not list any secure or proof jobs.	1. Press Menu Up or Menu Down until you see:	Menus Print Menu
	2. Press Item Up or Item Down until you see:	Print Menu Disk Directory
	3. Press Enter . You will see:	Printing Disk Directory
	4. When completed, you will see:	Ready
Print Quantity Set the number of times each page is printed. The available values are: 1* - 999 The quantity changes incrementally by 1 each time either Value Up or Value Down is pressed. Holding down Value Up or Value Down causes continuous scrolling through the values.	1. Press Menu Up or Menu Down until you see:	Menus Print Menu
	2. Press Item Up or Item Down until you see:	Print Menu Print Quantity
	3. Press Value Up or Value Down until you see:	Print Quantity = New Value
	4. Press Enter . You will see:	Print Menu Print Quantity
	5. Press Online . You will see:	Ready
Select Tray Select the source tray from which the job is to be printed. The available values are: Tray 1* Tray 2 Manual Feeder Appears and is a choice only when the optional Tray 2 is installed. The Tray Sequence setting is ignored. Media size or type mismatches will be handled via the current Page Policy settings.	1. Press Menu Up or Menu Down until you see:	Menus Print Menu
	2. Press Item Up or Item Down until you see:	Print Menu Select Tray
	3. Press Value Up or Value Down until you see:	Select Tray = New Value
	4. Press Enter . You will see:	Print Menu Select Tray
	5. Press Online . You will see:	Ready

Table 1.18 Page 4 of 4

Media Server Menu

Use the Media Server Menu to print from the Media Server. The menu hierarchy is shown in Figure 1.15.

Figure 1.15 Media Server Menu hierarchy with factory settings

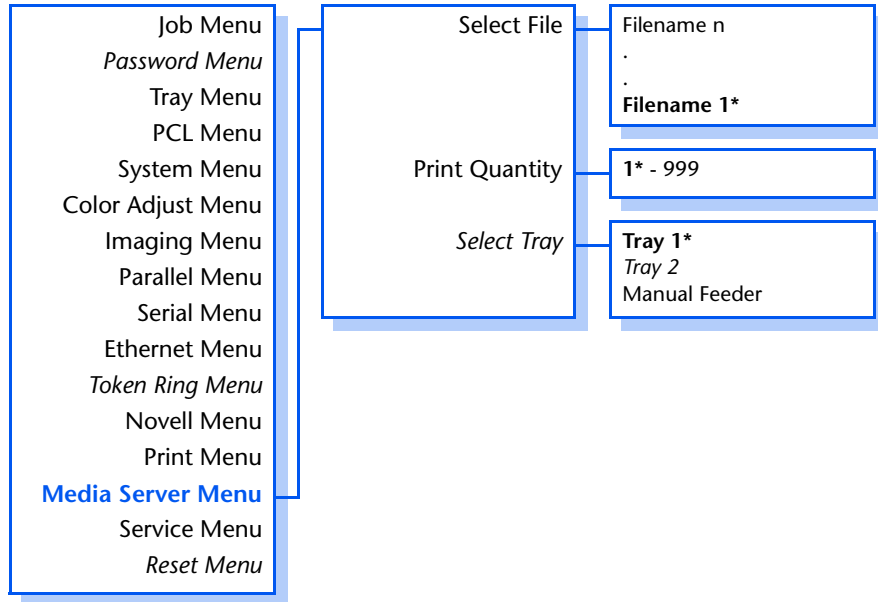

Refer to Table 1.19 on page 1-97 for step-by-step instructions.

Table 1.19 Media Server Menu functions

Menu Item and Function	Keystrokes	Display
<p>Select File</p> <p>Select a file from the Media Server's floppy disk.</p> <p>The available values are:</p> <p>Filename 1 through Filename n</p> <p>Value keys scroll through floppy filenames to find selection.</p>	1. Press Menu Up or Menu Down until you see:	Menus Media Server Menu
	2. Press Item Up or Item Down until you see:	Media Server Menu Select File
	3. Press Value Up or Value Down until you see:	Select File = Filename
	4. Press Enter . You will see:	Printing Filename
	5. When completed, you will see:	Ready
<p>Print Quantity</p> <p>Set the number of times each page is printed.</p> <p>The available values are:</p> <p>1* - 999</p> <p>The quantity changes incrementally by 1 each time either Value Up or Value Down is pressed. Holding down Value Up or Value Down causes continuous scrolling through the values.</p> <p> This value is used rather than the value in the print file.</p>	1. Press Menu Up or Menu Down until you see:	Menus Media Server Menu
	2. Press Item Up or Item Down until you see:	Media Server Menu Print Quantity
	3. Press Value Up or Value Down until you see:	Print Quantity = New Value
	4. Press Enter . You will see:	Media Server Menu Print Quantity
	5. Press Online . You will see:	Ready

Table 1.19 Page 1 of 2

Table 1.19 Media Server Menu functions (continued)

Menu Item and Function	Keystrokes	Display
<p>Select Tray</p> <p>Select the source tray from which the job is to be printed.</p> <p>The available values are:</p> <p>Tray 1* Tray 2 Manual Feeder</p> <p>Appears and is a choice only when the optional Tray 2 is installed. The Tray Sequence setting is ignored. Media size or type mismatches will be handled via the current Page Policy settings.</p> <p> <i>This tray selection is used rather than the selection in the print file.</i></p>	1. Press Menu Up or Menu Down until you see:	Menus Media Server Menu
	2. Press Item Up or Item Down until you see:	Media Server Menu Select Tray
	3. Press Value Up or Value Down until you see:	Select Tray = New Value
	4. Press Enter . You will see:	Media Server Menu Select Tray
	5. Press Online . You will see:	Ready

Table 1.19 Page 2 of 2

Service Menu

Use the Service Menu to generate printer reports and set service options. The menu hierarchy is shown in Figure 1.16 on page 1-100.

Refer to Table 1.20 on page 1-101 for step-by-step instructions.

Figure 1.16 Service Menu hierarchy

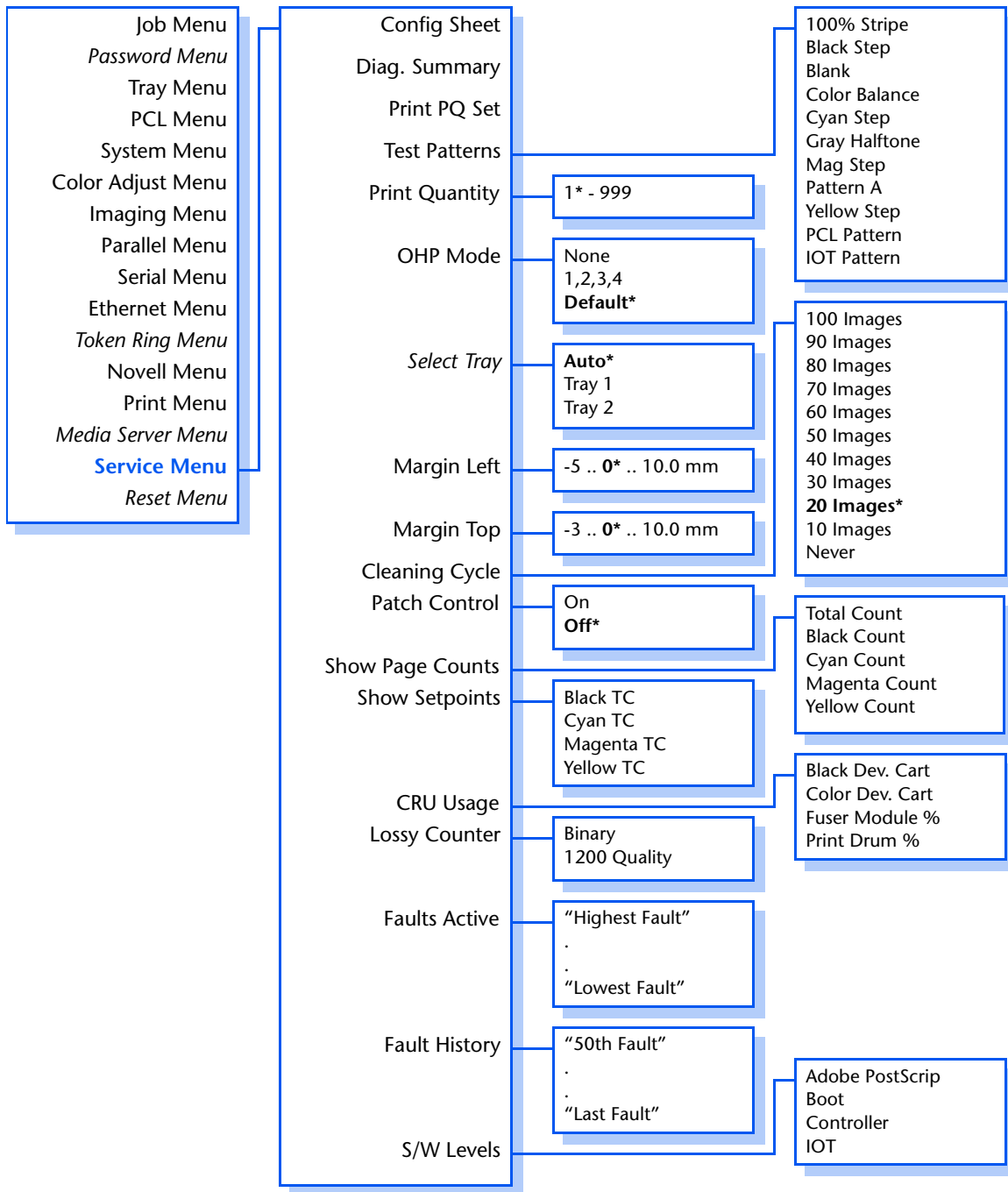

Table 1.20 Service Menu functions

Menu Item and Function	Keystrokes	Display
<p>Config Sheet</p> <p>Print a Configuration Sheet showing the printer's current information and menu settings.</p> <p>The Configuration Sheet is formatted for either Letter or A4 paper size, regardless of the default paper size or the actual paper size loaded.</p>	1. Press Menu Up or Menu Down until you see:	Menus Service Menu
	2. Press Item Up or Item Down until you see:	Service Menu Config Sheet
	3. Press Enter . You will see:	Printing Config Sheet
	4. When completed, you will see:	Ready
<p>Diag. Summary</p> <p>Print the current diagnostic summary data.</p> <p>Source tray is determined by the Select Tray item. The Diagnostic Summary Sheet(s) are formatted for either Letter or A4 paper size, regardless of the default paper size or the actual paper size loaded. There are no multiple copies.</p>	1. Press Menu Up or Menu Down until you see:	Menus Service Menu
	2. Press Item Up or Item Down until you see:	Service Menu Diag. Summary
	3. Press Enter . You will see:	Service Menu Diag. Summary
	4. When completed, you will see:	Ready
<p>Print PQ Set</p> <p>Print the PQ set: one "Test Pattern A," one "Color Balance" pattern and one "Diagnostic Page" in PS.</p> <p>The PQ set is formatted for either Letter or A4 paper size, regardless of the default paper size or the actual paper size loaded. There are no multiple copies. The Print Quantity value is ignored. Source tray is determined by the Select Tray value.</p>	1. Press Menu Up or Menu Down until you see:	Menus Service Menu
	2. Press Item Up or Item Down until you see:	Service Menu Print PQ Set
	3. Press Enter . You will see:	Service Menu Print PQ Set
	4. When completed, you will see:	Ready

Table 1.20 Page 1 of 8

Table 1.20 Service Menu functions (continued)

Menu Item and Function	Keystrokes	Display												
<p>Test Patterns</p> <p>Enable printing of printer resident, PostScript test patterns.</p> <p>The available values are:</p> <table border="0" data-bbox="164 416 471 546"> <tr> <td>100% Stripe</td> <td>Mag Step</td> </tr> <tr> <td>Black Step</td> <td>Pattern A</td> </tr> <tr> <td>Blank</td> <td>Yellow Step</td> </tr> <tr> <td>Color Balance</td> <td>PCL Pattern</td> </tr> <tr> <td>Cyan Step</td> <td>IOT Pattern</td> </tr> <tr> <td>Gray Halftone</td> <td></td> </tr> </table> <p>Patterns are formatted for either Letter or A4 paper size, regardless of the default paper size or the actual paper size loaded.</p>	100% Stripe	Mag Step	Black Step	Pattern A	Blank	Yellow Step	Color Balance	PCL Pattern	Cyan Step	IOT Pattern	Gray Halftone		1. Press Menu Up or Menu Down until you see:	Menus Service Menu
	100% Stripe	Mag Step												
	Black Step	Pattern A												
	Blank	Yellow Step												
	Color Balance	PCL Pattern												
Cyan Step	IOT Pattern													
Gray Halftone														
2. Press Item Up or Item Down until you see:	Service Menu Test Patterns													
3. Press Value Up or Value Down until you see:	Test Patterns = New Value													
4. Press Enter . You will see:	Service Menu Test Patterns													
5. Press Online . You will see:	Ready													
<p>Print Quantity</p> <p>Set the number of times each page is printed (uncollated).</p> <p>The available values are:</p> <p>1* .. 999</p> <p>The number of copies changes incrementally by 1 each time either Value Up or Value Down is pressed. Holding down Value Up or Value Down causes continuous scrolling through the number of copies.</p>	1. Press Menu Up or Menu Down until you see:	Menus Service Menu												
	2. Press Item Up or Item Down until you see:	Service Menu Print Quantity												
	3. Press Value Up or Value Down until you see:	Print Quantity = New Value												
	4. Press Enter . You will see:	Service Menu Print Quantity												
	5. Press Online . You will see:	Ready												

Table 1.20 Page 2 of 8

Table 1.20 Service Menu functions (continued)

Menu Item and Function	Keystrokes	Display
<p>OHP Mode</p> <p>Set Overhead Projection mode to allow discrete selection of settings for fuser temperature and transfer bias voltages to enhance the performance for transparencies.</p> <p>The available values are:</p> <p>None 1,2,3,4 Default*</p>	1. Press Menu Up or Menu Down until you see:	Menus Service Menu
	2. Press Item Up or Item Down until you see:	Service Menu OHP Mode
	3. Press Value Up or Value Down until you see:	OHP Mode = New Value
	4. Press Enter . You will see:	Service Menu OHP Mode
	5. Press Online . You will see:	Ready
<p>Select Tray</p> <p>Select the source tray from which the job is to be printed.</p> <p>The available values are:</p> <p>Tray 1* Tray 2 Manual Feeder</p> <p>Appears and is a choice only when the optional Tray 2 is installed. The Tray Sequence setting is ignored. Job to media size or type mismatch will be handled via the current Page Policy settings.</p>	1. Press Menu Up or Menu Down until you see:	Menus Service Menu
	2. Press Item Up or Item Down until you see:	Service Menu Select Tray
	3. Press Value Up or Value Down until you see:	Select Tray = New Value
	4. Press Enter . You will see:	Service Menu Select Tray
	5. Press Online . You will see:	Ready

Table 1.20 Page 3 of 8

Table 1.20 Service Menu functions (continued)

Menu Item and Function	Keystrokes	Display
<p>Margin Left</p> <p>Set the left margin or horizontal displacement of the logical printed page versus the physical page.</p> <p>The available values are:</p> <p>-5 .. 0* .. 10.0 mm</p> <p>A negative value moves the logical printed page (area) "left" on the physical page.</p>	1. Press Menu Up or Menu Down until you see:	Menus Service Menu
	2. Press Item Up or Item Down until you see:	Service Menu Margin Left
	3. Press Value Up or Value Down until you see:	Margin Left = New Value
	4. Press Enter . You will see:	Service Menu Margin Left
	5. Press Online . You will see:	Ready
<p>Margin Top</p> <p>Set the top margin or vertical displacement of the logical printed page versus the physical page.</p> <p>The available values are:</p> <p>-3 .. 0* .. 10.0 mm</p> <p>A negative value moves the logical printed page (area) "up" the physical page.</p>	1. Press Menu Up or Menu Down until you see:	Menus Service Menu
	2. Press Item Up or Item Down until you see:	Service Menu Margin Top
	3. Press Value Up or Value Down until you see:	Margin Top = New Value
	4. Press Enter . You will see:	Service Menu Margin Top
	5. Press Online . You will see:	Ready

Table 1.20 Page 4 of 8

Table 1.20 Service Menu functions (continued)

Menu Item and Function	Keystrokes	Display
Cleaning Cycle Select an automatic cleaning cycle frequency, based upon the number of prints. The available values are: 100 Images 90 Images 80 Images 70 Images 60 Images 50 Images 40 Images 30 Images 20 Images* 10 Images Never	1. Press Menu Up or Menu Down until you see:	Menus Service Menu
	2. Press Item Up or Item Down until you see:	Service Menu Cleaning Cycle
	3. Press Value Up or Value Down until you see:	Cleaning Cycle = New Value
	4. Press Enter . You will see:	Service Menu Cleaning Cycle
	5. Press Online . You will see:	Ready
Patch Control Control patch operation. The available values are: On Off*	1. Press Menu Up or Menu Down until you see:	Menus Service Menu
	2. Press Item Up or Item Down until you see:	Service Menu Patch Control
	3. Press Value Up or Value Down until you see:	Patch Control = New Value
	4. Press Enter . You will see:	Service Menu Patch Control
	5. Press Online . You will see:	Ready

Table 1.20 Page 5 of 8

Table 1.20 Service Menu functions *(continued)*

Menu Item and Function	Keystrokes	Display
<p>Show Page Counts Display summary page count data. The available values are: Total Count Black Count Cyan Count Magenta Count Yellow Count Total Page count reflects total pages. Color counts are the number of images (full color page contains as many as four color counts).</p>	1. Press Menu Up or Menu Down until you see:	Menus Service Menu
	2. Press Item Up or Item Down until you see:	Service Menu Show Page Counts
	3. Press Value Up or Value Down until you see:	Value Count
	4. Press Item Up or Item Down . You will see:	Service Menu Show Page Counts
	5. Press Online . You will see:	Ready
<p>Show Setpoints Display summary setpoint data. The available values are: Black TC Cyan TC Magenta TC Yellow TC</p>	1. Press Menu Up or Menu Down until you see:	Menus Service Menu
	2. Press Item Up or Item Down until you see:	Service Menu Show Setpoints
	3. Press Value Up or Value Down until you see:	Value Setpoints
	4. Press Item Up or Item Down . You will see:	Service Menu Show Setpoints
	5. Press Online . You will see:	Ready

Table 1.20 Page 6 of 8

Table 1.20 Service Menu functions (continued)

Menu Item and Function	Keystrokes	Display
CRU Usage Display CRU percentage of use data. The available values are: Black Dev. Cart Color Dev. Cart Fuser Module % Print Drum %	1. Press Menu Up or Menu Down until you see:	Menus Service Menu
	2. Press Item Up or Item Down until you see:	Service Menu CRU Usage
	3. Press Value Up or Value Down until you see:	Value Percent Usage
	4. Press Item Up or Item Down . You will see:	Service Menu CRU Usage
	5. Press Online . You will see:	Ready
Lossy Counter Maintain a count of printed pages that have printed using "Lossy" compression (image data is dropped during the compression process). The available values are: Binary 1200 Quality	1. Press Menu Up or Menu Down until you see:	Menus Service Menu
	2. Press Item Up or Item Down until you see:	Service Menu Lossy Counter
	3. Press Value Up or Value Down until you see:	Value Count
	4. Press Item Up or Item Down . You will see:	Service Menu Lossy Counter
	5. Press Online . You will see:	Ready

Table 1.20 Page 7 of 8

Table 1.20 Service Menu functions (continued)

Menu Item and Function	Keystrokes	Display
<p>Faults Active</p> <p>Display all active faults on the Control Panel display.</p> <p>The available values are:</p> <p>“Highest Fault”</p> <p>.</p> <p>“Lowest Fault”</p> <p>Pressing Value Up or Value Down in Step 3 scrolls through the messages.</p>	1. Press Menu Up or Menu Down until you see:	Menus Service Menu
	2. Press Item Up or Item Down until you see:	Service Menu Faults Active
	3. Press Value Up or Value Down . You will see:	Fault Message Fault Message
	4. Press Item Up or Item Down . You will see:	Service Menu Faults Active
	5. Press Online . You will see:	Ready
<p>Fault History</p> <p>Print a list of the last fifty faults.</p> <p>The available values are:</p> <p>“50th Fault”</p> <p>.</p> <p>“Last Fault”</p> <p>Pressing Value Up or Value Down in Step 3 scrolls through the faults.</p>	1. Press Menu Up or Menu Down until you see:	Menus Service Menu
	2. Press Item Up or Item Down until you see:	Service Menu Fault History
	3. Press Value Up or Value Down . You will see:	Log Entry # NN Fault Description
	4. Press Item Up or Item Down . You will see:	Service Menu Fault History
	5. Press Online . You will see:	Ready
<p>S/W Levels</p> <p>Display the current software versions (or levels).</p> <p>The available values are:</p> <p>Adobe PostScript</p> <p>Boot</p> <p>Controller</p> <p>IOT</p> <p>Pressing Value Up or Value Down in Step 3 scrolls through the values.</p>	1. Press Menu Up or Menu Down until you see:	Menus Service Menu
	2. Press Item Up or Item Down until you see:	Service Menu S/W Levels
	3. Press Value Up or Value Down . You will see:	Value S/W Level
	4. Press Item Up or Item Down . You will see:	Service Menu S/W Levels
	5. Press Online . You will see:	Ready

Reset Menu

Use the Reset Menu to reset various printer functions. The Reset Menu only appears in the Main Menu if the printer is powered on while simultaneously holding down the **Online** and **Enter** keys. It is removed after the printer is powered off.

Figure 1.17 shows the menu hierarchy. Items in italics appear only if the appropriate option is installed.

Figure 1.17 Reset Menu hierarchy with factory settings

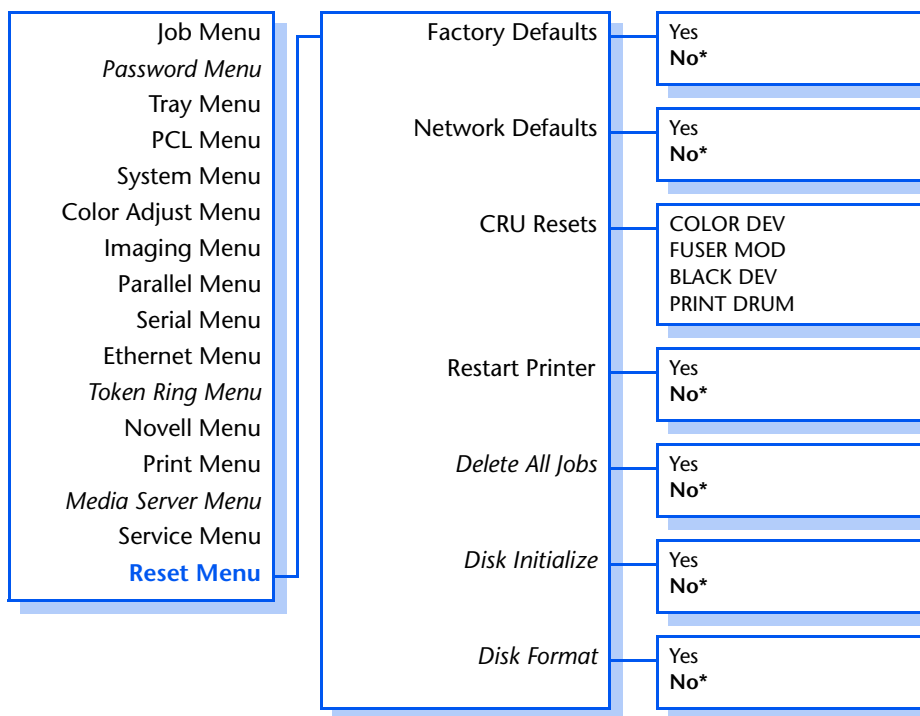

Refer to Table 1.21 on page 1-110 for step-by-step instructions.

Table 1.21 Reset Menu functions

Menu Item and Function	Keystrokes	Display
<p>Factory Defaults</p> <p>Reset the printer operating parameters to factory default settings.</p> <p>The available values are:</p> <p>Yes No*</p> <p>All NVM values are set to factory defaults, with the exception of: "Language" in the System Menu and "Defaults" in the System Menu which are not affected. No NVM values associated with the Ethernet or Token Ring interfaces are reset. Ethernet and Token Ring values may be reset to factory defaults via the "Network Defaults" item.</p>	1. Press Menu Up or Menu Down until you see:	Menus Reset Menu
	2. Press Item Up or Item Down until you see:	Reset Menu Factory Defaults
	3. Press Value Up or Value Down until you see:	Factory Defaults= Yes
	4. Press Enter . You will see:	Factory Defaults= Please Wait
	5. When the action is complete, you will see:	Ready
<p>Network Defaults</p> <p>Reset all NVM parameters associated with the Ethernet and Token Ring interfaces to factory defaults.</p> <p>The available values are:</p> <p>Yes No*</p>	1. Press Menu Up or Menu Down until you see:	Menus Reset Menu
	2. Press Item Up or Item Down until you see:	Reset Menu Network Defaults
	3. Press Value Up or Value Down until you see:	Network Defaults Yes
	4. Press Enter . You will see:	Network Defaults Please Wait
	5. When the action is complete, you will see:	Ready

Table 1.21 Reset Menu functions (continued)

Menu Item and Function	Keystrokes	Display
CRU Resets Reset the selected CRU. The available values are: COLOR DEV FUSER MOD BLACK DEV PRINT DRUM	1. Press Menu Up or Menu Down until you see:	Menus Reset Menu
	2. Press Item Up or Item Down until you see:	Reset Menu CRU Resets
	3. Press Value Up or Value Down until you see:	CRU Resets Yes
	4. Press Enter . You will see:	CRU Resets Please Wait
	5. When the action is complete, you will see:	Ready
Restart Printer Re-boot the printer as if the power was cycled, but bypassing power on diagnostics. The available values are: Yes No* This action does not remove the Reset Menu. To do so, power off/on the printer.	1. Press Menu Up or Menu Down until you see:	Menus Job Menu
	2. Press Item Up or Item Down until you see:	Job Menu Restart Printer
	3. Press Value Up or Value Down until you see:	Restart Printer Yes
	4. Press Enter . You will see:	[Startup Messages]
	5. When the action is complete, you will see:	Ready
Delete All Jobs Delete all secure or proof jobs from the disk. The available values are: Yes No* This function is ignored if the disk is locked (write protected) via a PjL or SNMP command.	1. Press Menu Up or Menu Down until you see:	Menus Reset Menu
	2. Press Item Up or Item Down until you see:	Reset Menu Delete All Jobs
	3. Press Value Up or Value Down until you see:	Delete All Jobs Yes
	4. Press Enter . You will see:	Delete All Jobs Please Wait
	5. When the action is complete, you will see:	Ready

Table 1.21 Page 2 of 3

Table 1.21 Reset Menu functions (continued)

Menu Item and Function	Keystrokes	Display
Disk Initialize Initialize the Hard Disk Drive. The available values are: Yes No* This function is ignored if the disk is locked (write protected) via a PjL or SNMP command.	1. Press Menu Up or Menu Down until you see:	Menus Reset Menu
	2. Press Item Up or Item Down until you see:	Reset Menu Disk Initialize
	3. Press Value Up or Value Down until you see:	Disk Initialize Yes
	4. Press Enter . You will see:	Disk Initialize Please Wait
	5. When the action is complete, you will see:	Ready
Disk Format Request a complete format of the disk directory. The available values are: Yes No* This item is used only if the disk has not been formatted previously (e.g. field disk replacement).	1. Press Menu Up or Menu Down until you see:	Menus Reset Menu
	2. Press Item Up or Item Down until you see:	Reset Menu Disk Format
	3. Press Value Up or Value Down until you see:	Disk Format Yes
	4. Press Enter . You will see:	Disk Format Please Wait
	5. When the action is complete, you will see:	Ready

Table 1.21 Page 3 of 3

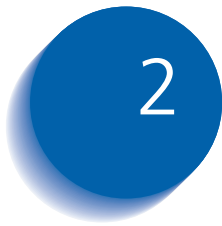

Managing Printer Usage

<i>Network Printer Services</i>	2-2
<i>CentreWare DP</i>	2-3
<i>CentreWare Internet Services</i>	2-4

Network Printer Services

Two print service utilities are available for the installation and management of your DocuPrint NC60-- CentreWare DP and CentreWare Internet Services. Each of these services provides you with the capability to easily and quickly accomplish the following tasks with your DocuPrint NC60 from your workstation:

- Check printer status.
- Remotely configure, monitor, and manage the printer.
- Set printer defaults.
- Perform printer maintenance diagnostics remotely.
- Upgrade the software on your DocuPrint NC60 and optional Network Interface Card.

CentreWare DP

CentreWare DP is a new generation of network print management software designed for the network administrator. It provides a single point of administration for all Xerox desktop and network printers, including your DocuPrint NC60. Thanks to the ease of point-and-click navigation, administrators will be able to install, connect, and configure the DocuPrint NC60 on a network immediately and quickly. Setup procedures have been simplified and the management of network printers is virtually effortless. CentreWare DP supports a number of key network environments, including NetWare and Windows NT.

See the Technical Information Guide and the CentreWare DP User Guide for more information on the operation and use of CentreWare DP.

CentreWare Internet Services

CentreWare Internet Services is an interactive service that extends the capabilities of CentreWare DP using Internet technology as the platform. It provides another option for implementing advanced services for the installation, configuration, and management of your DocuPrint NC60. Each of the features in CentreWare Internet Services can be accessed through familiar client-resident software interfaces, such as Netscape Navigator or Microsoft Explorer browsers. Through a web browser, users and system administrators will be able to monitor the status of the DocuPrint NC60, print HTML-based documents, and access context sensitive on-line assistance.

For system administrators, CentreWare Internet Services will provide a faster and more productive way to install and upgrade software on your DocuPrint NC60 and a wide range of supporting information on the Internet.

Setup

To set up your DocuPrint NC60 for Internet/Intranet access, you will need to do the following:

- Configure an IP address for the printer on your network. See *"IP Address"* (page 1-65 for Ethernet or page 1-77 for Token Ring).
- Enable the embedded HTTP server at the Control Panel. See *"HTTP Enable"* (page 1-63 for Ethernet or page 1-75 for Token Ring).

To use the Mail Send/Receive capability, you will need to establish a mail account for the printer and install and configure the Xerox Mail Port Monitor.



See the Technical Information Guide, the CentreWare Internet Services User Guide, and online help for more information on the operation and use of CentreWare Internet Services.

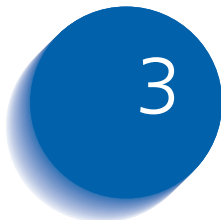

Using the Hard Drive

<i>Hard Drive Considerations</i>	3-2
<i>Disk Initialization</i>	3-2
<i>Downloading Fonts and Macros</i>	3-3
<i>FSDOWNLOAD Command</i>	3-4
<i>FSDELETE Command</i>	3-7
<i>Using the Hard Disk Drive for Secure and Proof Jobs</i>	3-8
<i>Creating Secure Jobs</i>	3-8
<i>Creating Proof Jobs</i>	3-10
<i>Printing or Deleting Secure or Proof Jobs</i>	3-12

Hard Drive Considerations

If you install the optional Hard Disk Drive on the DocuPrint NC60, it will significantly increase the amount of memory available for processing jobs and storing downloaded information (such as fonts, macros and jobs).

The hard disk is used for the following:

- Storage of print jobs for secure jobs and proof job.
- Temporary storage for collated print jobs.
- Long term storage for downloaded fonts and macros.
- Long term storage of up to ten jobs printable from the Control Panel Print Menu.

Disk Initialization

The disk is preformatted and requires no initialization. The disk may be returned to its initial state, with no loaded fonts, macros or secure jobs, by selecting the Disk Initialize item from the Reset Menu or from CentreWare.

Downloading Fonts and Macros

The Xerox DocuPrint NC60 PCL printer driver provides you with the ability to download fonts and PCL macros to the printer.

- To download fonts you must first install the appropriate DocuPrint NC60 PCL Windows 3.1 or Windows 95/98 driver. To download macros, you must install the DocuPrint NC60 Windows PCL driver.
- “Temporary” fonts/macros downloaded to printer memory on a job per job basis are cleared from the printer's memory after each job.
- “Permanent” fonts downloaded to printer memory are cleared from memory whenever the printer is powered off. When the printer switches PDLs, its automatic State Saving feature saves all fonts and macros.

In addition to downloading to memory through drivers, the DocuPrint NC60 will support downloading of fonts and macros to its hard disk by the use of the PJJ command FSDOWNLOAD. These files may be deleted from the DocuPrint NC60 disk by the PJJ command FSDELETE.

- Fonts downloaded to the hard disk are stored in the PCL Fonts and PS Fonts directories. Macros downloaded to the hard drive are stored in the PCL Macros directory. Fonts and macros stored in these directories remain there until you delete them. They are not cleared from the hard disk when the printer is powered off. You can only delete a macro from the hard disk if you know the name of the macro. Since you cannot print a list of macros as you can for fonts, it is important to keep a record of all downloaded macros. Then, use the PJJ FSDELETE command to delete fonts and macros.

FSDOWNLOAD Command

The FSDOWNLOAD command is used to download fonts or macros to the DocuPrint NC60 file system. If a file with the same name exists, the downloaded file overwrites it.

Syntax

```
@PJL FSDOWNLOAD FORMAT:BINARy [SIZE=int] [NAME = "pathname"] [<CR>] <LF>
<binary data><ESC>%-12345X
```

Parameters

Parameter	Functional Range	Default
SIZE= <i>integer</i>	0 to 2 ³¹ - 1	N/A
NAME="pathname"	ASCII 01 thru 255	N/A

SIZE = *integer* — The size variable indicates the number of bytes in the file to be downloaded. The size indicates the number of bytes immediately following the <LF> to the next UEL command.

NAME = "pathname" — where "pathname" = 0:\PCL\FONTS\

<binary data> — This is the binary file data to be downloaded, such as font files and macro data.



Use of 1 rather than 0 in the "pathname" will download the font or macro to RAM rather than to the hard drive.

Download Macro

The following is a sequence of commands that can be sent to the DocuPrint NC60 to download a macro to the disk.

```
<ESC>%-12345X @PJL<CR><LF>
@PJL FSDOWNLOAD FORMAT:BINAR Y NAME ="0:\pcl\macros\a_macro" SIZE=29<CR><LF>
<ESC>*p900x1500YThis is the macro <ESC>%-12345X
```

In this example:

- <ESC>%-12345X is the P J L U E L command which starts this sequence.
- @P J L <CR><LF> is the mandatory P J L command following the U E L command.
- @P J L F S D O W N L O A D . . . downloads a macro of 29 bytes named "a_macro."
- The phrase "This is the macro" is positioned at x=900 and y=1500 by this macro.
- <ESC>%-12345X is the U E L command which ends this sequence.

Executing this macro requires the following PCL sequence:

<ESC>&n8W<HEX'04'>a_macro<CR,LF>	Sets the current macro ID to the string ID "a_macro"
<ESC>&n8W<HEX'05'>a_macro<CR,LF>	Associates the current macro ID with the supplied string ID
<ESC>&f<HEX'02'>x<CR,LF>	Executes this macro

Notes:

1. The macro ID must be the same case as in the original download command.
2. The byte count (after the "n" and before the "w") must equal the ID byte count plus 1.

Download Fonts

The following is a sequence of commands that can be sent to the DocuPrint NC60 to download a font to the disk.

```
<ESC>%-12345X @PJL<CR><LF>  
@PJL FSDOWNLOAD FORMAT:BINARY NAME ="0:\pcl\fonts\font1" SIZE=XX<CR><LF>  
<binary data><ESC>%-12345X
```

In this example:

- <ESC>%-12345X is the PJI UEL command which starts this sequence.
- @PJL<CR><LF> is the mandatory PJI command following the UEL command.
- @PJL FSDOWNLOAD... downloads a font named "font1" that is "XX" bytes in size.
- <ESC>%-12345X is the UEL command which ends this sequence.

Invoking this font requires the following PCL sequence:

<ESC>&n6W<HEX'00'>font1<CR,LF>	Sets the current font ID to the given string ID "font1"
<ESC>&n6W<HEX'01'>font1<CR,LF>	Associates the current font ID with the string ID "font1"
<ESC>&n6W<HEX'02'>font1<CR,LF>	Selects the font referred to as "font1" for the primary font

Notes:

1. The case of the string ID must be the same as the case of the fontname in the FSDOWNLOAD command.
2. The byte count ("6" in the above example) must equal the string ID byte count plus 1.

FSDELETE Command

The FSDELETE command is used to delete files from the DocuPrint NC60 file system.

Syntax @PJL FSDELETE NAME = "*pathname*" [<CR>] <LF>

Parameters

Parameter	Functional Range	Default
NAME=" <i>pathname</i> "	ASCII 01 thru 255	N/A

NAME = "*pathname*" — where "*pathname*" has the same parameters as the FSDOWNLOAD command (see page 3-4).

Using the Hard Disk Drive for Secure and Proof Jobs

Secure and proof jobs that have been submitted to the printer are stored as processed, ready-to-print files on the Hard Disk Drive. These jobs can be printed (or deleted) through the Password Menu where you enter the 4-digit password for the job or jobs to be printed. Procedures for printing or deleting these jobs are listed in Table 1.7 on page 1-23.

The secure or proof job is placed at the top of the print queue, and will print following completion of the currently printing job. If more than one job is released, jobs are placed on the print queue in the order released. Secure or proof jobs having the same priority are printed on a first released basis.

Creating Secure Jobs

Secure printing delays printing of a job until a password associated with the job is entered at the printer's Control Panel. Entering the password at the Control Panel will provide access to only those jobs sent with that password.

Secure jobs are normally created in PCL and PostScript by choosing the feature in a driver. When not using a driver with this feature, secure jobs may also be created by preceding the job with the following PJJL commands:

```
@PJJL XSECUREJOB  
@PJJL XJOBPASSWORD = "number"
```

These commands must be immediately followed by a standard PJJL "JOB" command that includes the "jobname."

Job names can be up to 16 alphanumeric characters and passwords must contain four numeric characters (0-7). PCL does not support leading zeros in the password. The printer assigns a default job name if no name or a name with a syntax error is used. The job name is displayed on the Control Panel Password Menu when the associated password is entered. If a password is not assigned or the password contains syntax errors, the job is not printed and is discarded.

The following example creates a Secure Job named "Bond" with a password of 7000:

```
<ESC>%-12345X@PJL XSECUREJOB
@PJL XJOBPASSWORD = 7000
@PJL JOB NAME = "Bond"
@PJL ENTER LANGUAGE = PCL
...PCL file...
<ESC>%-012345X@PJL EOJ
<ESC>%-012345X
```

The printer processes all data following the @PJL ENTER LANGUAGE = PCL command as part of the Secure Job named "Bond." The job is stored on the hard disk under the name "Bond" with a password of "7000" as defined in the @PJL XJOBPASSWORD command. The @PJL EOJ command signifies the end of the secure job. The EOJ command should be followed by a UEL command.

Creating Proof Jobs

Proof printing lets you print a single copy of a multiple copy job. You assign a password and copy count at your workstation or computer before printing. The first set is printed immediately. You can then go to the printer and proofread (proof) the first set. Depending on the outcome of the proofing, you can then decide either to continue printing the remaining sets or to delete the job by entering the password at the printer's Control Panel.

Proof jobs, if not sent by a driver with the proof job feature, may be invoked in both PCL and PostScript by preceding the job with the following PJL commands:

```
@PJL XPROOFJOB
```

```
@PJL XJOBPASSWORD = "number"
```

These commands must be immediately followed by a standard PJL "JOB" command that includes the "jobname."

The printer continues processing all subsequent data as part of the proof job of name "job name." The proof job is stored with name "job name" and associated with the password defined in the PJL XPASSWORD command. The proof job ends when the PJL End of Job command is received (i.e., @PJL EOJ). The "EOJ" command should be followed by a UEL.

The job name is limited to 16 alphanumeric characters in the range ASCII 30 through ASCII 255, <SP> and <HT>. The password must contain four numeric characters in the range ASCII 48 through ASCII 55. The printer assigns a default job name if no name or a name with a syntax error is called out. The job name is the name displayed on the Control Panel Password Menu when the associated password is entered. If no password is assigned or there is a password syntax error, the entire job is printed immediately and is not stored as a proof job.

The following example generates a PCL proof job with name "Sample" and associated with password "7777" requesting five collated sets.

```
<ESC>%-12345X@PJL XPROOFJOB
@PJL XJOBPASSWORD = 7777
@PJL JOB NAME = "Sample"
@PJL SET QTY = 5
@PJL ENTER LANGUAGE = PCL
...PCL file...
<ESC>%-012345X@PJL EOJ
<ESC>%-012345X
```

Printing or Deleting Secure or Proof Jobs

Secure or proof jobs may be printed or deleted by using the Password Menu, as described in the section “*Password Menu*” (page 1-22). They may also be deleted by using the Delete Jobs function in the Reset Menu, as described in the section “*Reset Menu*” (page 1-109).

4

Maintaining the Printer

<i>Regular Printer Maintenance</i>	4-3
<i>Cleaning the Printer</i>	4-4
<i>Cleaning the Grounding Roller and Feed Rollers</i>	4-5
<i>Cleaning the Print Drum Charger</i>	4-4
<i>Adjusting Density and Color Balance</i>	4-8
<i>Printing a Test Page</i>	4-9
<i>Interpreting the Test Print</i>	4-10
<i>What To Look For</i>	4-11
<i>Making Adjustments</i>	4-12
<i>Adjustment Recovery</i>	4-15
<i>Upgrading the Printer Software</i>	4-16
<i>Upgrade Methods</i>	4-18
<i>Before You Upgrade</i>	4-17
<i>Printer Controller Upgrade Process</i>	4-19
<i>Determining a Successful Upgrade</i>	4-20
<i>After the Upgrade</i>	4-20
<i>Procedure A</i>	4-21
<i>Procedure B</i>	4-22
<i>Procedure C</i>	4-24
<i>Procedure D</i>	4-26

<i>Procedure E</i>	4-28
<i>Procedure F</i>	4-29
<i>Procedure G</i>	4-31
<i>General Troubleshooting</i>	4-32

Regular Printer Maintenance

Your DocuPrint NC60 is designed to need very little ongoing maintenance other than the replacement of maintenance items as they reach their end of use.

To avoid untimely image quality problems, we recommend that you replace maintenance items when the end of use warnings appear on the Control Panel. However, it is always good practice to periodically clean any loose toner or foreign matter in your printer. See the section *"Cleaning the Printer"* (page 4-4) for procedures and cautions.

Cleaning the Printer

The cleaning procedures described in this section will help you maintain the optimum print quality and minimize downtime of your DocuPrint NC60. Before you begin, be sure that you have a basic understanding of the parts of your printer. Also, pay strict attention to the cautions given in each process.

Cleaning the Print Drum Charger

The Print Drum Charger is a thin wire mesh used to place a charge on the Print Drum. If this mesh becomes dirty the Print Drum will not obtain a proper charge resulting in image quality defects. To clean the Print Drum Charger, follow these steps.

- 1** Open the front and top covers of the printer and locate the Print Drum.
- 2** On the top left side of the Print Drum you will see a green thumb tab. This is the Print Drum Charger cleaner slide.
- 3** Simply slide this Print Drum Charger cleaner slide back and forth several times and return it to its original location.

Cleaning the Grounding Roller and Feed Rollers

The interior rollers, located under the Front Cover, should be cleaned only if roller marks appear on prints.

Figure 4.1 Location of Interior Rollers

- ❶ Grounding Roller
- ❷ Registration/Precurler Roller
- ❸ Paper Sensor Switch
- ❹ Paper Feed Rollers
- ❺ Developer Rollers (4)
(underneath the Print Drum)

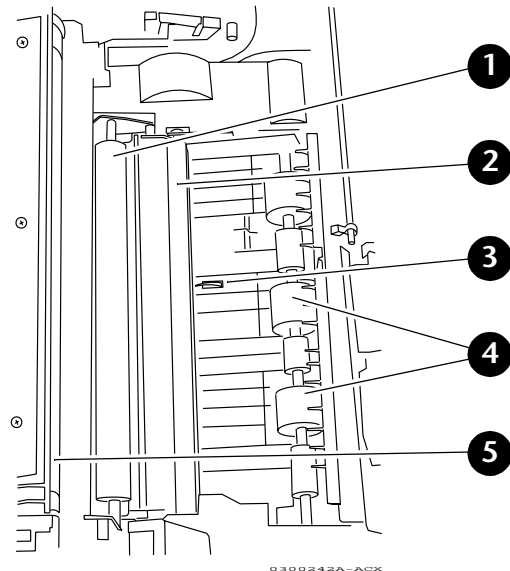

There is a small paper sensor switch in the bottom of the printer that is easily broken. Use extreme caution in this area to avoid damaging the printer. This switch can only be repaired by a service technician.

When cleaning, do not use water or a cloth dampened with water. Use a clean, dry, lint free cloth.

Follow these steps to clean the rollers.

1 Raise the Front cover.

2 Locate the Print Drum.



When removing and inserting the Print Drum, do not allow the green drum to touch any parts of the printer. Contact may damage the delicate drum degrading print quality.

3 Release the latches on both sides of the Print Drum.

4 Grasp the Print Drum by the handles and slide it up and out of the printer, being careful to not allow the drum to come into contact with the front cover of the printer.



The Print Drum is sensitive to prolonged exposure to bright light. If the drum is exposed to excessive light (the average fluorescent office lighting) for more than 2 minutes, it may require up to 2 hours of darkness to recover. Extended exposure will cause permanent damage.

5 Set the Print Drum Module aside on several sheets of used paper and cover the drum with several layers of paper to avoid light contact.

6 Locate the paper sensor switch in the bottom of the printer. See diagram above. Take care not to damage this switch while cleaning.

- 7 While holding the paper switch down, wipe all the rollers with a clean cloth.
- 8 Clean the areas between the developer rollers. It is not necessary to completely remove the toner from the developer rollers.
- 9 Hold the Print Drum with both hands by the side handles.
- 10 Replace the Print Drum by sliding it down and into the printer.
- 11 Secure both latches of the Print Drum.
- 12 Close the Front Cover.



If you detect the presence of any oil on any of these rollers or the Transfer Drum, immediately remove the Fuser from the printer and call your service provider or Xerox representative.

Adjusting Density and Color Balance

You may notice, over the course of using the printer, that colors may change. For example, reds may begin to take on a purple cast, or blues may take on a green cast. This happens during the normal use of a color printer and can be easily remedied by using the Density/Color Balance Adjustment procedure described in this section. This procedure, which should be done monthly, will help correct any color shifts.

This Control Panel procedure involves printing a test page and adjusting the densities and colors based on the appearance of the Test Page. You may need to repeat this procedure and test your adjustments until you achieve the desired effect.



*If, during the adjustment process, you decide to return to your starting point; you can do so by selecting **Cancel Changes** from the Color Adjust Menu.*

Printing a Test Page

- 1 Press Menu Up or Menu Down until you see:



Menus
Color Adjust

- 2 Press Item Up or Item Down.

You will see:



Processing

The printer prints the Color Balance test print.

Interpreting the Test Print

The Color Balance test print contains numbered images that indicate possible adjustments that can be made, as shown in Figure 4.2. You can choose to make an adjustment to the Color Density, the Black Density, or the Color Balance.

Figure 4.2 Color Balance Test Print

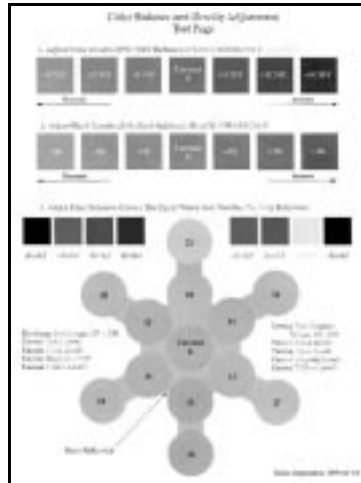

(While Figure 4.2 is in black and white, the actual Color Balance test page is in full color.)

The Color Density Images, numbered -3CMY...0,...+3CMY and the current setting show a lightness/darkness range of three color gray 30% halftones.

The Black Density Images, numbered -3K...0,...+3K and the current setting show a lightness/darkness range of black only 30% halftones.

The Color Balance Images, numbered 0,10,11,...21 and the current setting, show variations of three color gray. Each of these circles contains gray with tints of other colors.

What To Look For

There are basically three things to look for in examining the test print.

1. The Color Density and the Black Density are a matter of taste. The 30% halftones can be used to judge the current level and decide on a preference.
2. The Color Density and Black Density should be at approximately the same level. This is important in order to make the Color Balance adjustment.
3. The correct Color Balance is determined by comparing the circle in the center of the Color Balance object marked "CURRENT" with the gray background. The background is produced using black only and the circles are produced using a combination of cyan, magenta, and yellow. The adjustment objective is for the "CURRENT" circle to be the closest gray of any of the circles when compared to the background.

Making Adjustments

Use the following procedures to make adjustments to the color density and balance:

Color Density Adjustment

- 1 Press Item Up or Item Down until you see:

```
Color Adjust
Color Density
```

- 2 Press Value Up or Value Down until you see:

```
Color Density =
New Value
```

Values are -3CMY, -2CMY, -1CMY, 0, +1CMY, +2CMY, +3CMY..

- 3 Press Enter. The test page will print and the Control Panel will display:

```
Color Adjust Menu
Color Density
```

- 4 Enter "0" to set the current value or set another new value by repeating Steps 2 and 3 above..

Black Density Adjustment

- 1 Press Item Up or Item Down until you see:

```
Color Adjust  
Black Density
```

- 2 Press Value Up or Value Down until you see:

```
Black Density =  
New Value
```

Values are -3K, -2K, -1K, 0, +1K, +2K, +3K.

- 3 Press Enter. The test page will print and the Control Panel will display:

```
Color Adjust Menu  
Black Density
```

- 4 Enter "0" to set the current value or set another new value by repeating Steps 2 and 3 above..

Color Balance Adjustment

- 1 Press Menu Up or Menu Down until you see:

```
Menus  
Color Adjust Menu
```

- 2 Press Item Up or Item Down until you see:

```
Color Adjust  
Color Balance
```

- 3 Press Value Up or Value Down until you see:

```
Color Balance =  
New Value
```

Values are 0,10,11,12,13,14,15,16,17,18,19,20,21.

- 4 Press Enter. The test page will print and the Control Panel will display:

```
Color Adjust Menu  
Color Density
```

- 5 Enter "0" to set the current value or set another new value by repeating Steps 3 and 4 above.

Adjustment Recovery

While in the color adjustment routine you have two methods of recovering previous settings:

- You can choose to return to the values you had before you began the adjustment routine by using the Color Adjust menu's Cancel Changes item.

The printer will be restored to the original settings you had when you entered the color adjustment routine

- You can choose to return the values to the factory default values by using the Color Adjust menu's Color Defaults item.

The printer will be restored to the initial nominal default values.

Upgrading the Printer Software

The Printer Controller is FLASH ROM equipped. This means as software fixes and upgrades are available, you are able to update printer software without a service call.

The current software at the time of manufacture is provided on the CD-ROM. The path to the software is:

Table 4.1 Software on the CD-ROM

Software	Path to the Software
Printer Controller	D\INSTAL\UTILITY\FIRMWARE\PRINTER\<(version #).xfc (version # in the form #_#_#)

In addition the newest software will always be available on the Internet on both the Xerox ftp and world wide web sites.

Table 4.2 Software on the Internet

Software	Address
Printer Controller	ftp://ftp.xerox.com/pub/nc60/firmware
Printer Controller on WWW	http://www.xerox.com/drivers

All files are compressed using PKZIP or BinHex/ StuffIt formats to avoid corruption during transfer. Self-extracting versions of the files exist for many platforms. For the other platforms you will need the appropriate decoding software.

There are a variety of ways to upgrade the printer software. Choose one of the following that is most familiar to you.

Before You Upgrade

- 1** Be sure the printer is in communication with the workstation directly or over the network.
- 2** Be sure you have the proper upgrade file for the kind of upgrade you need to do. The printer controller file will end in the extension .xfc.
- 3** Print a Configuration Sheet and a Diagnostics Page. Refer to Table 1.20 on page 1-101 for instructions, if necessary.

Upgrade Methods

Select a method from Table 4.3 to do an upgrade for your operating system. The bold letter indicates the upgrade procedure to use, described later in this chapter.

Table 4.3 Upgrade Methods

Operating System	CentreWare DP	LPR	Parallel Port	Novell Print Queue	Macintosh Printer Utility	Internet Services	Mail Send
Windows 3.x	A	***	C	D	*	F	G
Windows 95/98	A	***	C	D	*	F	G
Windows NT 3.51 & 4.0	A	B**	C	D	*	F	G
OS/2	*	B**	C	D	*	F	G
UNIX	*	B	*	*	*	F	G
Macintosh	*	*	*	*	E	F	G

* Not Applicable

** Requires TCP/IP services to be installed from your operating system.

*** Requires LPR capable software to be installed independently from the operating system.

Printer Controller Upgrade Process

During the upgrade process the printer's Control Panel will display several messages.

As the printer receives the file it will alternate between the message "Waiting" and the message "Processing". It is normal in some cases for the printer to display the message "Waiting" a majority of the time.

After the complete file has been received the Control Panel will display "Upgrading, Please Wait..." and the upgrade process will begin.

When the upgrade process is complete the printer will automatically initialize and print a startup sheet.

The process can take as little as 5 minutes over a fast network to as long as 20 minutes over the parallel port.



It is important to not interrupt any part of the process. DO NOT TURN OFF THE PRINTER IN THE MIDDLE OF AN UPGRADE.

If you experience any problems, call your Xerox Customer Support Center.

Determining a Successful Upgrade

If your upgrade is successful, you will receive a new start up page. The “Software Version” on the start up page should reflect the software level of the upgrade.

After the Upgrade

After a successful upgrade, some printer features may be set to the factory defaults. Some of these parameters may include settings that allow you to print to the printer. These parameters must be reset before you will be able to print. To accomplish this, you will need the previously printed Configuration Sheet and Diagnostics page.

Using the directions in the section “*Before You Upgrade*” (page 4-17), print out a new Configuration Sheet and Diagnostics page.

Compare the original Configuration Sheet with the new one. Identify the items that are different between the two pages. Use CentreWare DP or the Control Panel (in some cases both) to restore settings. If you require assistance please contact your Xerox Customer Support Center.

Now compare the Printer Diagnostics pages. Look at the section labeled Adjustments. If the Top Margin and Left Margin numbers have changed they will need to be reset. To do this use the procedure on page 1-104.

Other settings on the Diagnostics Page may have changed due to print quality adjustments. This is normal and not a result of the upgrade.

Finally, it is advisable to perform a Color Balance procedure at this time to ensure optimum color printing. See the section “*Adjusting Density and Color Balance*” (page 4-8).

Procedure A Upgrade from CentreWare DP



Once the upgrade process has begun do not power off your printer!

- 1 Print a **Configuration Sheet** and a **Diagnostics Page**. Keep these pages for future reference. For directions on doing this, refer to Table 1.20 on page 1-101.
- 2 Start the CentreWare DP software from your workstation. Select the printer from the **Printers List**.
- 3 At the CentreWare DP main screen select the **Tools** menu.
- 4 From the Tools menu select the **Upgrade Printer** item.
- 5 Select the **Printer** button.
- 6 Enter the path of the upgrade file and click **OK**.
- 7 CentreWare DP will send the upgrade file to the printer. The upgrade should take less than 10 minutes to perform.
- 8 To see if your upgrade was successful see the section *“Determining a Successful Upgrade”* (page 4-20). If successful, follow the instructions in the section *“After the Upgrade”* (page 4-20). For problems consult the section *“General Troubleshooting”* (page 4-32).

Procedure B LPR Upgrade Procedure



Once the upgrade process has begun do not power off your printer!

- 1 Print a **Configuration Sheet** and a **Diagnostics Page**. Keep these pages for future reference. For directions on doing this, refer to Table 1.20 on page 1-101.
- 2 Send the upgrade file to the printer. Use the format based on your client operating system:

Windows NT (3.51 & 4.)

```
lpr -P ps -S <ipaddress> <filename>[RETURN]
```

OS/2

```
lpr -p ps -s <ipaddress> <filename>[RETURN]
```

UNIX (use lp or lpr as appropriate)

```
lpr <switches><queue><filename> [RETURN]
```

```
lp <switches><queue><filename> [RETURN]
```

Where:

<ipaddress> = the TCP/IP address the printer has been assigned

<filename> = the path and name of the upgrade file

<queue> = the native queue to which the printer is assigned

<switches> = use switches as appropriate to your UNIX environment

- 3 To see if your upgrade was successful see the section *“Determining a Successful Upgrade”* (page 4-20). If successful, follow the instructions in the section *“After the Upgrade”* (page 4-20).

If you have problems:

- Try to ping the printer to make sure it has a valid ip address.
- In addition consult the section “*General Troubleshooting*” (page 4-32).

Procedure C The Parallel Port



Once the upgrade process has begun do not power off your printer!

- 1** Print a **Configuration Sheet** and a **Diagnostics Page**. Keep these pages for future reference. For directions on doing this, refer to page 1-101.
- 2** The parallel port on the printer must be in Auto mode. Check the Configuration Sheet previously printed. In the Parallel Settings section the Mode should be set to Auto. If it is not you will need to set this through the printer's Control Panel or CentreWare DP. For directions on doing this through the Control Panel, refer to page 1-52.

- 3** Send the upgrade file to the printer.

An OS/2 user should open a command prompt.

A Windows(95/NT/3.1x) user should run from DOS or run a DOS session. For speed, it is recommended to exit Windows and run from DOS.

The format for the copy command is as follows:

```
copy /b <filename> <port>[RETURN]
```

Where:

<port> = the parallel port to which the printer is connected (LPT1:,LPT2:, etc.)

<filename> = the path and name of the upgrade file

Ex: copy 3_3_4.xfc LPT1

- 4** To see if your upgrade was successful, see the section "Determining a Successful Upgrade" (page 4-20). If successful, follow the instructions in the section "After the Upgrade" (page 4-20).

If you have problems:

- Make sure you are using an IEEE B1284 compliant cable.
- Make sure the printer's parallel port **Mode** is set to **Auto**.
- If running a DOS window from Windows 95 make sure that one of your printers through Settings/Printers is mapped directly to LPT 1 (not redirected to a network queue). Also check the port settings by selecting the **Port Settings...** button on the **Details** tab dialog. Make sure the selection **Spool MS-DOS Print Jobs** is selected. If still having problems after making these settings, try powering your PC off and on.
- (Windows Users) If experiencing time-outs on the host PC ("Problem detected on parallel port, Abort, Retry, Fail") then you need to set the port to an infinite time-out against busy on the printer. From the command line or as an entry in autoexec.bat type the following command:

mode lpt1:,,b (two commas following the colon)

The "b" option sets the port for infinite time-out. After setting the port to an infinite time-out, try using the copy command again. If the command prompt does not appear within 20 minutes a ctrl-break can be used to abort the copy command without rebooting your computer.

- Windows 3.11 users should turn off Print Manager.
- In addition consult the section "*General Troubleshooting*" (page 4-32).

Procedure D Insert into Novell Queue



Once the upgrade process has begun do not power off your printer!

- 1 Print a **Configuration Sheet** and a **Diagnostics Page**. Keep these pages for future reference. For directions on doing this, refer to Table 1.20 on page 1-101.
- 2 Start PCONSOLE.
- 3 Select **Print Queue** Information then press [RETURN].
- 4 Select the print queue to send the job to, then press [RETURN].
- 5 Select **Current Print Job Entries** then press [RETURN].
- 6 Press the [INSERT] key. Type in the path/filename and press [RETURN].
- 7 Choose configuration and then press [RETURN].
- 8 Press the [ESC] key. Select Yes then press [RETURN].
- 9 The upgrade file will be sent to the printer. The upgrade should take less than 10 minutes to perform.
- 10 To see if your upgrade was successful, see the section *“Determining a Successful Upgrade”* (page 4-20). If successful, follow the instructions in the section *“After the Upgrade”* (page 4-20).

If you have problems:

If the printer never goes to “Processing” check the status of the job in the queue. If the job is in the queue and Active, but not being sent to the printer, power the printer off and on. See if the job is then sent to the printer.

In addition consult the section “General Troubleshooting” (page 4-32).

Procedure E MACINTOSH – XEROX PRINTER UTILITY



Once the upgrade process has begun do not power off your printer!

- 1** Print a **Configuration Sheet** and a **Diagnostics Page**. Keep these pages for future reference. For directions on doing this, refer to Table 1.20 on page 1-101.
- 2** Launch the Xerox Printer Utility.
- 3** Select the NC60 printer to upgrade in **PostScript Printers** list.
- 4** Select **Send**.
- 5** Locate the upgrade file.
- 6** Select **Open** to send the upgrade file to the printer.
- 7** The Xerox Printer Utility will send the upgrade file to the printer. The upgrade should take less than 10 minutes.
- 8** To see if your upgrade was successful, see the section *“Determining a Successful Upgrade”* (page 4-20). If successful, follow the instructions in the section *“After the Upgrade”* (page 4-20). For problems consult the section *“General Troubleshooting”* (page 4-32).

Procedure F Upgrade Procedure via Internet Services



Once the upgrade process has begun do not power off your printer!

- 1** Print a **Configuration Sheet** and a **Diagnostics Page**. Keep these pages for future reference. For directions on doing this, refer to Table 1.20 on page 1-101.
- 2** Launch your web browser and connect to the printer URL (typically **http://ipaddress**).
- 3** Select the **Print** page to get to the **File Download** dialog.
- 4** In the **File:** box enter the path and name of the upgrade file, or select the **Browse...** button to select the upgrade file.
- 5** Select the **Start** button.
- 6** The upgrade file will be sent to the printer. The upgrade should take less than 10 minutes to perform.
- 7** To see if your upgrade was successful, see the section *“Determining a Successful Upgrade”* (page 4-20). If successful, follow the instructions in the section *“After the Upgrade”* (page 4-20).

If you have problems:

- If having problems with time-outs when sending the file using a proxy server try turning off the proxy server and sending the file again. Alternatively, the printer IP address can be entered individually as an address for which a proxy should not be used.
- Check your browser version to be sure your are using the correct version. The upgrade procedure requires Netscape 3.0 or later or Internet Explorer 4.0 or later
- Try to ping the printer to make sure it is a valid ip address
- In addition consult the section "*General Troubleshooting*" (page 4-32).

Procedure G Mail Send



Once the upgrade process has begun do not power off your printer!

If your printer is set up to receive mail (see “CentreWare Internet Services” on page 2-4), send the upgrade file as an attachment to a mail note addressed to the printer’s mail address. The upgrade should take less than ten minutes.



If your mail system limits the size of attached files, it is possible that some of the file may get truncated. If this occurs, the upgrade will not go through and no damage is done.

General Troubleshooting

Some of the individual printer upgrade methods will have their own trouble shooting sections. This section is to address general problems.

If the printer controller upgrade has failed, you will not receive an error page. Check the following and try the upgrade again:

- 1** Make sure you are using the correct upgrade file for your printer controller. It should be a *.xfc file, not an *.xfr file.
- 2** Check your method of connectivity to your printer. Can you successfully send a job over your chosen method of connectivity? For parallel port users- are you using a IEEE 1284 compliant parallel cable?
- 3** If the flash software was downloaded from an ftp site, make sure it was downloaded in binary format, not ASCII. To change to binary format, type binary at any ftp prompt. If you are using an ftp software package such as Chameleon ftp, you can select binary from within the software.
- 4** Consult your upgrade procedure to see if there is a "If you have problems" section in your chosen upgrade procedure
- 5** If the printer never goes to "Processing" and stays "Online" check your method of printer connection. Try powering off and on. If sending via a NetWare queue check the status of the job in the queue. Powering off and on the printer may cause the job to get to the printer.

- 6** Power off and on. Send the file again using the same method.
- 7** Power off and on. Send the file using an alternative method as indicated in the chart.
- 8** If the printer appears to be hung in “Processing” after sending the upgrade file (with the “Processing” message on the Control Panel for at least 15 minutes) either contact your Xerox Customer Support Center for assistance, or power off and on the printer. If the printer powers up properly try sending the upgrade file again. If the printer does not power up properly contact your support center for assistance.
- 9** If the printer appears to be hung in “Upgrading, Please Wait...”, (with the “Upgrading, Please Wait” message on the Control Panel for at least 10 minutes) contact your Xerox Customer Support Center for assistance.
- 10** If all attempts to upgrade the printer controller have failed, note the Control Panel message of the printer when the upgrade fails and contact your support center for assistance.
- 11** If a printer upgrade was attempted and the printer will not power up properly contact your support center for assistance.



Troubleshooting

Control Panel Messages 5-2

Control Panel Messages

Listed in Table 5.1 are Control Panel messages that either:

- Cause the printer to stop printing.
- Require the user to call for service.

Also included in Table 5.1 are common, non-error messages you are likely to see. The messages are listed in alphabetical order.

Table 5.1 Control Panel Messages and Corrective Actions

Message	Explanation/Required Action
C1-CHECK TRAY 1	Tray 1 is misinstalled or not installed in the printer.
C2-CHECK TRAY 2	Tray 2 is misinstalled or not installed in the printer.
E1-TRAY 1 JAM OPEN PRINTER	Tray 1 misfeed. Check tray and open printer to clear.
E2-TRAY 2 JAM OPEN PRINTER	Tray 2 misfeed. Check tray and open printer to clear.
E3-BYPASS JAM OPEN PRINTER	Manual bypass misfeed. Open printer to clear.
E4-INPUT JAM OPEN PRINTER	Paper jam in the input roller area. Open printer to clear.
E5-FUSER JAM OPEN PRINTER	Paper jam in the fuser area. Open printer, open the Fuser cover, release the Fuser lever to clear.
E6-DRUM JAM OPEN PRINTER	Paper jam in the transfer drum area. Open the printer to clear.
E7-PRINT DRUM JAM-OPEN PRINTER	Paper jam in the print drum area. Open printer to clear.

Table 5.1 Control Panel Messages and Corrective Actions

Message	Explanation/Required Action
E8-OUTPUT JAM OPEN PRINTER	Paper jam in the output roller area. Open printer, open the Fuser cover, release the Fuser lever to clear.
E9-PLEASE CLOSE PRINTER	A printer cover is open. Close cover to resume printing.
EA-COLOR DEV. MISINSTALLED	Color developer cartridge is not properly installed.
EB-BLACK DEV. MISINSTALLED	Black developer cartridge is not properly installed.
EC-PRINT DRUM MISINSTALLED	Print drum is not properly installed.
ED-TRAY 2 MISINSTALLED	Tray 2 is not properly installed.
ENTER PASSWORD <i>job filename</i>	Enter 4-digit password to release Secure Job or Proof Job.
ENTER TO PRINT ITEM TO SCROLL	
F1-DISK READ ERROR	Media Server error. Remove floppy and reinsert.
F2-DISK I/O ERROR	Media Server error. Remove floppy and reinsert.
F3-DISK READ FAILURE	Media Server error. Remove floppy and reinsert.
FEED #10ENVELOPE IN MANUAL BYPASS	Load Comm. 10 envelope in manual bypass.

Table 5.1 Control Panel Messages and Corrective Actions

Message	Explanation/Required Action
FEED 8.5x13 IN MANUAL BYPASS	Load 8 ¹ / ₂ x 13 in. paper in manual bypass.
FEED 8x10 PAPER IN MANUAL BYPASS	Load 8 x 10 in. paper in manual bypass.
FEED A4 PAPER IN MANUAL BYPASS	Load A4 (210 x 297 mm) paper in manual bypass.
FEED A5 PAPER IN MANUAL BYPASS	Load A5 (148 x 210 mm) paper in manual bypass.
FEED B5 PAPER IN MANUAL BYPASS	Load B5 (176 x 250 mm) paper in manual bypass.
FEED C5 ENVELOPE IN MANUAL BYPASS	Load C5 envelope in manual bypass.
FEED DL ENVELOPE IN MANUAL BYPASS	Load DL envelope in manual bypass.
FEED EXECUTIVE IN MANUAL BYPASS	Load Executive (7 ¹ / ₄ x 10 ¹ / ₂ in.) paper in manual bypass.
FEED INVOICE IN MANUAL BYPASS	Load Invoice (5 ¹ / ₄ x 8 ¹ / ₂ in.) paper in manual bypass.
FEED LEGAL IN MANUAL BYPASS	Load Legal (8 ¹ / ₂ x 14 in.) paper in manual bypass.
FEED LETTER IN MANUAL BYPASS	Load Letter (8 ¹ / ₂ x 11 in.) paper in manual bypass.
FEED MONARCH ENV IN MANUAL BYPASS	Load Monarch envelope in manual bypass.

Table 5.1 Control Panel Messages and Corrective Actions

Message	Explanation/Required Action
FEED SP. FOLIO IN MANUAL BYPASS	Load Sp. Folio (216 x 315 mm) paper in manual bypass.
FLUSHING <i>job filename</i>	Printer is removing current job from memory. No action required.
H1-HARD DISK ERROR	H1 - Hard disk error. Power printer off/on; check hard disk connections; reformat disk.
H2-HARD DISK CONTROLLER ERROR	H2 - Hard disk controller error. Power printer off/on; check hard disk connections.
H3-HARD DISK IS FULL	H3 - Hard disk is full. Print or delete any Secure Jobs or Proof Jobs.
H4-PLEASE FORMAT HARD DISK	H4 - Please format the hard disk.
INITIALIZING	No action required.
J1-ADD YELLOW TONER	Add yellow toner.
J2-ADD MAGENTA TONER	Add magenta toner.
J3-ADD CYAN TONER	Add cyan toner.
J4-ADD BLACK TONER	J4 - Add black toner.
J5-REPLACE COLOR DEV. CARTRIDGE	J5 - Replace the color developer cartridge.
J6-REPLACE BLACK DEV. CARTRIDGE	J6 - Replace the black developer cartridge.
J7-REPLACE TONER COLLECTOR	Replace the full toner collector.

Table 5.1 Control Panel Messages and Corrective Actions

Message	Explanation/Required Action
J8-REPLACE PRINT DRUM	J8 - Replace the print drum.
J9-REPLACE FUSER MODULE	J9 - Replace the fuser module.
JA-REPLACE FUSER OIL/PAD	Replace the fuser oil and pad.
JOB HELD <i>job filename</i>	A print job is being held. Press Enter to resume printing.
LOAD 8.5x13 IN TRAY 1	Load 8 ¹ / ₂ x 13 in. paper in tray 1.
LOAD 8.5x13 IN TRAY 2	Load 8 ¹ / ₂ x 13 in. paper in tray 2.
LOAD 8x10 PAPER IN TRAY 1	Load 8 x 10 in. paper in tray 1.
LOAD 8x10 PAPER IN TRAY 2	Load 8 x 10 in. paper in tray 2.
LOAD A4 PAPER IN TRAY 1	Load A4 (210 x 297 mm) paper in tray 1.
LOAD A4 PAPER IN TRAY 2	Load A4 (210 x 297 mm) paper in tray 2.
LOAD A5 PAPER IN TRAY 1	Load A5 (148 x 210 mm) paper in tray 1.

Table 5.1 Control Panel Messages and Corrective Actions

Message	Explanation/Required Action
LOAD A5 PAPER IN TRAY 2	Load A5 (148 x 210 mm) paper in tray 2.
LOAD B5 PAPER IN TRAY 1	Load B5 (176 x 250 mm) paper in tray 1.
LOAD B5 PAPER IN TRAY 2	Load B5 (176 x 250 mm) paper in tray 2.
LOAD EXECUTIVE PAPER IN TRAY 1	Load Executive ($7\frac{1}{4} \times 10\frac{1}{2}$ in.) paper in tray 1.
LOAD EXECUTIVE PAPER IN TRAY 2	Load Executive ($7\frac{1}{4} \times 10\frac{1}{2}$ in.) paper in tray 2.
LOAD INVOICE 8.5x5.5 IN TRAY1	Load Invoice ($5\frac{1}{4} \times 8\frac{1}{2}$ in.) paper in tray 1.
LOAD INVOICE 8.5x5.5 IN TRAY2	Load Invoice ($5\frac{1}{4} \times 8\frac{1}{2}$ in.) paper in tray 2.
LOAD LEGAL 8.5x14 IN TRAY 1	Load Legal ($8\frac{1}{2} \times 14$ in.) paper in tray 1.
LOAD LEGAL 8.5x14 IN TRAY 2	Load Legal ($8\frac{1}{2} \times 14$ in.) paper in tray 2.
LOAD LETTER 8.5x11 IN TRAY 1	Load Letter ($8\frac{1}{2} \times 11$ in.) paper in tray 1.
LOAD LETTER 8.5x11 IN TRAY 2	Load Letter ($8\frac{1}{2} \times 11$ in.) paper in tray 2.
LOAD SP. FOLIO 216x315 IN TRAY1	Load Sp. Folio (216 x 315 mm) paper in tray 1.
LOAD SP. FOLIO 216x315 IN TRAY2	Load Sp. Folio (216 x 315 mm) paper in tray 2.

Table 5.1 Control Panel Messages and Corrective Actions

Message	Explanation/Required Action
OFF LINE	Press On Line button to return to "Ready."
PLEASE WAIT WARMING UP	Please wait - Warming up
POWER SAVER MODE	Power Saver Mode
PRINTING <i>job filename</i>	
PROCESSING <i>job filename</i>	
READY	
SECURE JOB <i>job filename</i>	
T0-RESEAT FUSER POWER OFF/ON	Fuser thermistor fault. Reseat the fuser, then power the printer off and on. If the fault persists, call for service.
T1-RESEAT FUSER POWER OFF/ON	Fuser under temperature fault. Reseat the fuser, then power the printer off and on. If the fault persists, call for service.
T2-POWER OFF REPLACE FUSER	Fuser over temperature fault. Replace the fuser module.
TRAY 1 EMPTY	Tray 1 is empty.
TRAY 2 EMPTY	Tray 2 is empty.
U0-ROM ERROR POWER OFF/ON	There is a print engine ROM fault. Power the printer off and on. If the fault persists, call for service.

Table 5.1 Control Panel Messages and Corrective Actions

Message	Explanation/Required Action
U1-RAM ERROR POWER OFF/ON	There is a print engine RAM fault. Power the printer off and on. If the fault persists, call for service.
U2-NVRAM ERROR POWER OFF/ON	There is a print engine NVRAM fault. Power the printer off and on. If the fault persists, call for service.
U3-COMM. FAULT POWER OFF/ON	There is a controller/engine communication fault. Power the printer off and on. If the fault persists, call for service.
U4-OPTICS FAULT POWER OFF/ON	There is a laser system fault. Power the printer off and on. If the fault persists, call for service.
U5-POLYGON FAULT POWER OFF/ON	There is a polygon motor fault. Power the printer off and on. If the fault persists, call for service.
U6-MOTOR FAULT POWER OFF/ON	There is a developer motor fault. Power the printer off and on. If the fault persists, call for service.
U7-MOTOR FAULT POWER OFF/ON	There is a main motor fault. Power the printer off and on. If the fault persists, call for service.
W1-COLOR DEV MOD NEAR END OF USE	W1 - Color developer cartridge near end of use. Order a new color developer cartridge.
W2-BLACK DEV MOD NEAR END OF USE	W2 - Black developer cartridge near end of use. Order a new black developer cartridge.
W3-PRINT DRUM NEAR END OF USE	W3 - Print drum near end of use. Order a new print drum.
W4-FUSER MODULE NEAR END OF USE	W4 - Fuser module near end of use. Order a new fuser module.
W5-FUSER OIL/PAD NEAR END OF USE	W5 - Fuser oil and pad near end of use. Replace oil bottle.
WAIT:ADJUSTING PRINT QUALITY	Please wait - Adjusting print quality
WAITING <i>job filename</i>	Printer waiting for data.

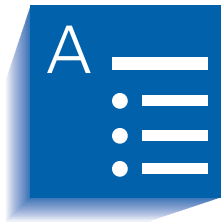

Index

A

- AppSocket Binary PS
 - Setting
 - In Ethernet
 - Menu • 1-63
 - In Token Ring
 - Menu • 1-75
- AppSocket Enable
 - Setting
 - In Ethernet
 - Menu • 1-62
 - In Token Ring
 - Menu • 1-74
- AppSocket PDL
 - Setting
 - In Ethernet
 - Menu • 1-62
 - In Token Ring
 - Menu • 1-74

B

- Baud Rate
 - Setting • 1-56
- Bidirectional
 - Setting • 1-52

- Binary PS
 - Setting • 1-52, 1-55
- Black Density
 - Setting • 1-43
- Black Overprint
 - Setting • 1-47

C

- Cancel Changes
 - Setting • 1-44
- Cancel Job
 - Performing • 1-20
- CentreWare DP • 2-3
- CentreWare Internet Services • 2-4
- Cleaning Cycle
 - Setting • 1-105
- Cleaning
 - procedures • 4-4 → 4-7
 - Feed Rollers • 4-5 → 4-7
 - Grounding
 - Roller • 4-5 → 4-7
 - Print Drum Charger • 4-4

D

- Color Adjust Menu
 - Hierarchy • 1-42
 - Items
 - Black Density • 1-43
 - Cancel Changes • 1-44
 - Color Balance • 1-44
 - Color Defaults • 1-45
 - Color Density • 1-43
- Color Balance
 - Adjusting • 4-8 → 4-15
 - Adjustment Recovery • 4-15
 - Setting • 1-44
 - Test print • 4-10
- Color Defaults
 - Setting • 1-45
- Color Density
 - Setting • 1-43
- Color Mode
 - Setting • 1-47
- Configuration Sheet
 - Printing • 1-92, 1-101
- Control Panel • 1-2 → 1-9
 - Display • 1-3
 - Indicator lights • 1-4
 - Keys • 1-5 → 1-9
 - Messages • 5-2 → 5-9
- CRU
 - Resetting • 1-111
- CRU Usage
 - Displaying • 1-107

D

- Default Gateway
 - Setting
 - In Ethernet Menu • 1-67
 - In Token Ring Menu • 1-79
- Defaults
 - Setting • 1-41
- Delete jobs • 1-111
- Density
 - Adjusting • 4-8 → 4-15
 - Adjustment Recovery • 4-15
- Diagnostic Summary
 - Printing • 1-101

- Disk Directory
 - Printing • 1-95
- Disk Drive
 - See Hard Disk Drive
- Disk Files
 - Printing • 1-94
- DLC/LLC Binary PS
 - Setting
 - In Ethernet Menu • 1-61
 - In Token Ring Menu • 1-73
- DLC/LLC Enable
 - Setting
 - In Ethernet Menu • 1-60
 - In Token Ring Menu • 1-72
- DLC/LLC PDL
 - Setting
 - In Ethernet Menu • 1-60
 - In Token Ring Menu • 1-72

E

- Edge Smoothing
 - Setting • 1-47
- Enh. Alignment
 - Setting • 1-48
- Ethernet Menu
 - Hierarchy • 1-58
 - Items
 - AppSocket Bin PS • 1-63
 - AppSocket Enable • 1-62
 - AppSocket PDL • 1-62
 - Default Gateway • 1-67
 - DLC/LLC Bin PS • 1-61
 - DLC/LLC Enable • 1-60
 - DLC/LLC PDL • 1-60
 - EtherTalk Enable • 1-63
 - HTTP Enable • 1-63
 - IP Address • 1-65
 - IP Address Reset • 1-64
 - LPR Banner • 1-59
 - LPR Binary PS • 1-60
 - LPR Enable • 1-59
 - LPR PDL • 1-59
 - NetBEUI Bin PS • 1-62
 - NetBEUI Enable • 1-61
 - NetBEUI PDL • 1-61
 - Port Timeout • 1-68
 - Speed • 1-68
 - Subnet Mask • 1-66

EtherTalk Enable
Setting • 1-63

F

Factory Defaults
Resetting to • 1-110

Fast Black
Setting • 1-48

Fault History
Displaying • 1-108
Printing • 1-94

Faults Active
Displaying • 1-108

Files
Printing from Media Server • 1-97

Flow Control
Setting • 1-55

Font Number
Setting • 1-30

Fonts
Downloading • 3-3 → 3-7

Form Feed
Forcing • 1-20

Form Length
Setting • 1-32

Frame Type
Setting • 1-86

H

Halftone Type
Setting • 1-48

Hard Disk Drive
Control Panel settings • 1-112
Formatting • 1-112
Initializing • 1-112, 3-2
Using • 3-2 → 3-12
 For downloading fonts • 3-3 → 3-7
 For downloading macros • 3-3 → 3-7
 For proof jobs • 3-8 → 3-12
 For secure jobs • 3-8 → 3-12

Hold Timeout
Setting • 1-38

HTTP Enable
Setting
 In Ethernet Menu • 1-63
 In Token Ring Menu • 1-75

I

Imaging Menu
Hierarchy • 1-46
Items
 Blk. Overprint • 1-47
 Color Mode • 1-47
 Edge Smoothing • 1-47
 Enh. Alignment • 1-48
 Fast Black • 1-48
 Halftone Type • 1-48
 Process Black • 1-49

Internet
Also see CentreWare Internet Services
Software upgrades • 4-16, 4-29

IP Address
Setting
 In Ethernet Menu • 1-65
 In Token Ring Menu • 1-77

IP Address Reset
Setting
 In Ethernet Menu • 1-64
 In Token Ring Menu • 1-76

J

Job Menu
Hierarchy • 1-19
Items
 Cancel Job • 1-20
 Form Feed • 1-20
 Restart Printer • 1-21

L

LAA
Setting • 1-81

Language
Setting • 1-35

Line Termination
Setting • 1-33

Lossy compression • 1-107

M

- LPR Banner
 - Setting
 - In Ethernet Menu • 1-59
 - In Token Ring Menu • 1-71
- LPR Binary PS
 - Setting
 - In Ethernet Menu • 1-60
 - In Token Ring Menu • 1-72
- LPR Enable
 - Setting
 - In Ethernet Menu • 1-59
 - In Token Ring Menu • 1-71
- LPR PDL
 - Setting
 - In Ethernet Menu • 1-59
 - In Token Ring Menu • 1-71

M

- Macros
 - Downloading • 3-3 → 3-7
- Mail Send/Receive • 2-4
- Manual Timeout
 - Setting • 1-39
- Margin Left
 - Setting • 1-104
- Margin Top
 - Setting • 1-104
- Media Server Menu
 - Hierarchy • 1-96
 - Items
 - Print Quantity • 1-97
 - Select File • 1-97
 - Select Tray • 1-98
- Menu Map
 - Printing • 1-93

N

- NDS Context
 - Setting • 1-90
- NDS Tree
 - Setting • 1-89
- NetBEUI Binary PS
 - Setting
 - In Ethernet Menu • 1-62
 - In Token Ring Menu • 1-74

- NetBEUI Enable
 - Setting
 - In Ethernet Menu • 1-61
 - In Token Ring Menu • 1-73
- NetBEUI PDL
 - Setting
 - In Ethernet Menu • 1-61
 - In Token Ring Menu • 1-73
- Network Defaults
 - Resetting to • 1-110
- Network Printer Services • 2-2
- Novell Binary PS
 - Setting
 - In Novell Menu • 1-85
- Novell Enable
 - Setting • 1-84
- Novell Menu
 - Hierarchy • 1-83
 - Items
 - Frame Type • 1-86
 - NDS Context • 1-90
 - NDS Tree • 1-89
 - Novell Binary PS • 1-85
 - Novell Enable • 1-84
 - Novell Mode • 1-85
 - Novell PDL • 1-84
 - Polling Interval • 1-86
 - Primary Server • 1-88
 - PServer Name • 1-87
- Novell Mode
 - Setting • 1-85
- Novell PDL
 - Setting • 1-84

O

- OHP Mode
 - Setting • 1-103
- Orientation
 - Setting • 1-32
- Overhead Projection mode • 1-103

P

- Page counts
 - Displaying • 1-106

- Page Policy
 - Setting • 1-37
- Paper
 - Specifying size of • 1-36
 - Specifying type of • 1-36
- Paper Size
 - Setting • 1-36
- Paper Type
 - Setting • 1-36
- Parallel Menu
 - Hierarchy • 1-50
 - Items
 - Bidirectional • 1-52
 - Binary PS • 1-52
 - Parallel PDL • 1-52
 - Port Enable • 1-51
 - Port Timeout • 1-51
- Parallel PDL
 - Setting • 1-52
- Password Menu
 - Hierarchy • 1-22
 - Usage • 1-23 → 1-24
- Patch Control
 - Setting • 1-105
- PCL Font List
 - Printing • 1-92
- PCL Menu
 - Hierarchy • 1-29
 - Items
 - Font Number • 1-30
 - Form Length • 1-32
 - Line Termination • 1-33
 - Orientation • 1-32
 - Pitch • 1-30
 - Point Size • 1-31
 - Symbol Set • 1-31
- Pitch
 - Setting • 1-30
- Point Size
 - Setting • 1-31
- Polling Interval
 - Setting • 1-86
- Port Enable
 - Setting
 - In Parallel Menu • 1-51
 - In Serial Menu • 1-54
- Port Timeout
 - Setting
 - In Ethernet Menu • 1-68
 - In Parallel Menu • 1-51
 - In Serial Menu • 1-54
 - In Token Ring Menu • 1-80
- PostScript
 - Demo Page • 1-93
 - Enabling binary mode • 1-52
 - Font List • 1-93
 - Printing errors • 1-40
 - Printing test patterns • 1-102
 - Setting AppSocket binary mode • 1-63, 1-75
 - Setting binary mode • 1-55
 - Setting DLC/LLC binary mode • 1-61, 1-73
 - Setting LPR binary mode • 1-60, 1-72
 - Setting NetBEUI binary mode • 1-62, 1-74
 - Setting Novell binary mode • 1-85
- Power Saver
 - Setting • 1-41
- PQ Set
 - Printing • 1-101
- Primary Server
 - Setting • 1-88
- Print Menu
 - Hierarchy • 1-91
 - Items
 - Configuration Sheet • 1-92
 - Disk Directory • 1-95
 - Disk Files • 1-94
 - Fault History • 1-94
 - Menu Map • 1-93
 - PCL Font List • 1-92
 - Print Quantity • 1-95
 - PS Demo Page • 1-93
 - PS Font List • 1-93
 - Select Tray • 1-95
 - Startup Page • 1-92
 - Tips & Tricks • 1-94
- Print PS Errors
 - Setting • 1-40

R

- Print Quantity
 - Setting • 1-39
 - Setting for internal page printing • 1-95
 - Setting for Media Server printing • 1-97
 - Setting for Service Menu printing • 1-102
- Printer software
 - See Software
- Process Black
 - Setting • 1-49
- Proof printing • 3-8 → 3-12
- PS Demo Page
 - Printing • 1-93
- PS Font List
 - Printing • 1-93
- PServer Name
 - Setting • 1-87

R

- Reset Menu
 - Hierarchy • 1-109
 - Items
 - CRU Resets • 1-111
 - Delete All Jobs • 1-111
 - Disk Format • 1-112
 - Disk Initialize • 1-112
 - Factory Defaults • 1-110
 - Network Defaults • 1-110
 - Restart Printer • 1-111
- Restart Printer
 - Initiating • 1-21, 1-111

S

- Secure printing • 3-8 → 3-12
- Select Tray
 - Setting for internal page printing • 1-95
 - Setting for Media Server printing • 1-98
 - Setting for Service Menu printing • 1-103
- Serial Menu
 - Hierarchy • 1-53
 - Items
 - Baud Rate • 1-56
 - Binary PS • 1-55
 - Flow Control • 1-55
 - Port Enable • 1-54
 - Port Timeout • 1-54
 - Serial PDL • 1-55

- Serial PDL
 - Setting • 1-55
- Service Menu
 - Hierarchy • 1-100
 - Items
 - Cleaning Cycle • 1-105
 - Configuration Sheet • 1-101
 - CRU Usage • 1-107
 - Diag. Summary • 1-101
 - Fault History • 1-108
 - Faults Active • 1-108
 - Lossy Counter • 1-107
 - Margin Left • 1-104
 - Margin Top • 1-104
 - OHP Mode • 1-103
 - Patch Control • 1-105
 - Print PQ Set • 1-101
 - Print Quantity • 1-102
 - Select Tray • 1-103
 - Show Page Counts • 1-106
 - Show Setpoints • 1-106
 - S/W Levels • 1-108
 - Test Patterns • 1-102
- Setpoints
 - Displaying • 1-106
- Software
 - Upgrading • 4-16 → 4-33
- Software levels
 - Displaying • 1-108
- Source Routing
 - Setting • 1-82
- Speed
 - Setting
 - In Ethernet Menu • 1-68
 - In Token Ring Menu • 1-82
- Startup Page
 - Printing • 1-92
 - Setting • 1-40
- Subnet Mask
 - Setting
 - In Ethernet Menu • 1-66
 - In Token Ring Menu • 1-78
- Symbol Set
 - Setting • 1-31

System Menu

Hierarchy • 1-34

Items

Defaults • 1-41

Hold Timeout • 1-38

Language • 1-35

Manual Timeout • 1-39

Page Policy • 1-37

Paper Size • 1-36

Paper Type • 1-36

Power Saver • 1-41

Print PS Errors • 1-40

Print Quantity • 1-39

Startup Page • 1-40

T

Test Patterns

Printing • 1-102

Test Print

Interpreting • 4-10

Tips & Tricks

Printing • 1-94

Token Ring Menu

Hierarchy • 1-70

Items

AppSocket Binary PS • 1-75

AppSocket Enable • 1-74

AppSocket PDL • 1-74

Default Gateway • 1-79

DLC/LLC Binary PS • 1-73

DLC/LLC Enable • 1-72

DLC/LLC PDL • 1-72

HTTP Enable • 1-75

IP Address • 1-77

IP Address Reset • 1-76

LAA • 1-81

LPR Banner • 1-71

LPR Binary PS • 1-72

LPR Enable • 1-71

LPR PDL • 1-71

NetBEUI Binary PS • 1-74

NetBEUI Enable • 1-73

NetBEUI PDL • 1-73

Port Timeout • 1-80

Source Routing • 1-82

Speed • 1-82

Subnet Mask • 1-78

TokenTalk Enable • 1-75

TokenTalk Enable

Setting • 1-75

Tray Menu

Hierarchy • 1-25

Items

Tray Sequence • 1-28

Tray 1 Cust. Size • 1-26

Tray 1 Type • 1-27

Tray 2 Cust. Size • 1-26

Tray 2 Type • 1-27

Tray Sequence

Setting • 1-28

Tray 1 Cust. Size

Setting • 1-26

Tray 1 Type

Setting • 1-27

Tray 2 Cust. Size

Setting • 1-26

Tray 2 Type

Setting • 1-27

U

Upgrading software

See Software, Upgrading

Free Manuals Download Website

<http://myh66.com>

<http://usermanuals.us>

<http://www.somanuals.com>

<http://www.4manuals.cc>

<http://www.manual-lib.com>

<http://www.404manual.com>

<http://www.luxmanual.com>

<http://aubethermostatmanual.com>

Golf course search by state

<http://golfingnear.com>

Email search by domain

<http://emailbydomain.com>

Auto manuals search

<http://auto.somanuals.com>

TV manuals search

<http://tv.somanuals.com>