

DocuPrint M235 dw

DocuPrint M235 z

DocuPrint M275 z

DocuPrint M285 z

Online User's Guide

## Table of Contents

|  |           |
|--|-----------|
| <b>Before You Use Your Fuji Xerox Machine .....</b>  | <b>1</b>  |
| Definitions of Notes .....   | 2         |
| Trademarks .....   | 3         |
| Important Note .....   | 4         |
| <b>Introduction to Your Fuji Xerox Machine .....</b>   | <b>5</b>  |
| Control Panel Overview .....   | 6         |
| Control Panel Overview .....   | 11        |
| Interface Overview .....   | 12        |
| Touchscreen LCD Overview .....   | 13        |
| How to Navigate the Touchscreen LCD .....  | 15        |
| Settings Screen Overview .....   | 17        |
| Access Fuji Xerox Utilities (Windows®) .....   | 18        |
| Uninstall the Fuji Xerox Software and Drivers (Windows®) .....   | 20        |
| <b>Paper Handling .....</b>  | <b>21</b> |
| Load Paper .....   | 22        |
| Load and Print Using the Paper Tray .....  | 23        |
| Load and Print Using the Multi-purpose Tray (MP Tray) .....  | 26        |
| Load and Print Paper in the Manual Feed Slot .....   | 33        |
| Paper Settings .....   | 40        |
| Change the Paper Size and Paper Type .....   | 41        |
| Select the Tray to Be Used For Printing .....  | 42        |
| Change the Check Paper Size Setting .....  | 43        |
| Load Documents .....   | 44        |
| Load Documents in the Automatic Document Feeder (ADF) .....  | 45        |
| Load Documents on the Scanner Glass .....  | 46        |
| Unscannable and Unprintable Areas .....  | 47        |
| Using Special Paper .....  | 48        |
| <b>Print .....</b>   | <b>49</b> |
| Print from Your Computer (Windows®) .....  | 50        |
| Print a Document (Windows®) .....  | 51        |
| Print Settings (Windows®) .....  | 53        |
| Change the Default Print Settings (Windows®) .....   | 57        |
| Print a Document Using the PS3 emulate Printer Driver (PostScript® 3™ Language Emulation) (Windows®) ..... | 58        |
| Monitor the Status of the Machine from Your Computer (Windows®) .....                                      | 59        |
| Print from Your Computer (Mac) .....   | 60        |
| Print a Document (Mac) .....   | 61        |
| Print Options (Mac) .....  | 62        |
| Monitor the Status of the Machine from Your Computer (Mac) .....   | 67        |
| Cancel a Print Job .....   | 69        |
| Test Print .....   | 70        |
| <b>Scan .....</b>  | <b>71</b> |
| Scan Using the Scan Button on Your Fuji Xerox Machine .....  | 72        |
| Scan Photos and Graphics .....   | 73        |

|  |            |
|--|------------|
| Save Scanned Data to a Folder as a PDF File .....  | 76         |
| Scan to an Editable Text File (OCR) .....  | 79         |
| Scan to Email Attachment .....   | 82         |
| Scan to FTP .....  | 85         |
| Scan to Network (Windows®) .....   | 90         |
| Web Services for Scanning on Your Network (Windows® 7, Windows® 8 and Windows® 10) ..... | 96         |
| Change Scan Button Settings from ControlCenter4 (Windows®) .....                         | 100        |
| Change Scan Button Settings from iPrint&Scan (Mac) .....                                 | 104        |
| Configure Certificate for Signed PDF .....   | 105        |
| Disable Scanning from Your Computer .....  | 106        |
| Scan from Your Computer (Windows®) .....   | 107        |
| Scan Using ControlCenter4 Home Mode (Windows®) .....                                     | 108        |
| Scan Using ControlCenter4 Advanced Mode (Windows®) .....                                 | 125        |
| Scan Using Nuance™ PaperPort™ 14SE or Other Windows® Applications .....                  | 140        |
| Scan Using Windows® Fax and Scan .....   | 145        |
| Scan from Your Computer (Mac) .....  | 149        |
| Scan Using iPrint&Scan (Mac) .....   | 150        |
| Scan Using TWAIN-Compliant Applications (Mac) .....                                      | 151        |
| Configure Scan Settings Using Web Based Management .....                                 | 156        |
| Set the Scan File Name Using Web Based Management .....                                  | 157        |
| <b>Copy .....</b>  | <b>158</b> |
| Copy a Document .....  | 159        |
| Enlarge or Reduce Copied Images .....  | 161        |
| Make N in 1 Copies Using the Page Layout Feature .....                                   | 163        |
| Sort Copies .....  | 165        |
| Copy an ID Card .....  | 167        |
| Copy on Both Sides of the Paper (2-sided Copy) .....                                     | 169        |
| Copy Options .....   | 171        |
| <b>Fax .....</b>   | <b>174</b> |
| Send a Fax .....   | 175        |
| Send a Fax .....   | 176        |
| Send a 2-sided Fax from the ADF .....  | 180        |
| Send a Fax Manually .....  | 181        |
| Send a Fax at the End of a Conversation .....  | 182        |
| Send the Same Fax to More than One Recipient (Broadcasting) .....                        | 183        |
| Send a Fax in Real Time .....  | 186        |
| Send a Fax at a Specified Time (Delayed Fax) .....                                       | 187        |
| Add a Cover Page to Your Fax .....   | 188        |
| Cancel a Fax in Progress .....   | 191        |
| Check and Cancel a Pending Fax .....   | 192        |
| Fax Options .....  | 193        |
| Receive a Fax .....  | 195        |
| Receive Mode Settings .....  | 196        |
| Memory Receive Options .....   | 208        |
| Remote Fax Retrieval .....   | 217        |
| Voice Operations and Fax Numbers .....   | 223        |

|  |            |
|--|------------|
| Voice Operations .....   | 224        |
| Store Fax Numbers .....  | 227        |
| Dial a Number Using One Touch Dial.....  | 231        |
| Dial a Number Using Speed Dial .....   | 234        |
| Set up Groups for Broadcasting .....   | 237        |
| Combine Address Book Numbers .....   | 243        |
| Telephone Services and External Devices.....   | 245        |
| Distinctive Ring.....  | 246        |
| FaxAbility .....   | 250        |
| Caller ID .....  | 254        |
| External TAD (Telephone Answering Device).....   | 255        |
| External and Extension Telephones .....  | 258        |
| Multi-line Connections (PABX) .....  | 264        |
| Fax Reports.....   | 265        |
| Print a Transmission Verification Report .....   | 266        |
| Print a Fax Journal .....  | 267        |
| PC-FAX .....   | 269        |
| PC-FAX for Windows® .....  | 270        |
| PC-FAX for Mac .....   | 295        |
| <b>Network .....</b>   | <b>298</b> |
| Supported Basic Network Features .....   | 299        |
| Network Management Software and Utilities .....  | 300        |
| Learn about Network Management Software and Utilities .....  | 301        |
| Additional Methods of Configuring Your Fuji Xerox Machine for a Wireless Network.....                        | 302        |
| Before Configuring Your Fuji Xerox Machine for a Wireless Network .....                                      | 303        |
| Configure Your Machine for a Wireless Network.....   | 304        |
| Configure Your Machine for a Wireless Network Using the One Push Method of Wi-Fi Protected Setup™ (WPS)..... | 305        |
| Configure Your Machine for a Wireless Network Using the PIN Method of Wi-Fi Protected Setup™ (WPS).....      | 307        |
| Configure Your Machine for a Wireless Network Using the Machine's Control Panel Setup Wizard                 | 311        |
| Configure Your Machine for a Wireless Network When the SSID Is Not Broadcast .....                           | 314        |
| Use Wi-Fi Direct® .....  | 317        |
| Advanced Network Features.....   | 329        |
| Print the Network Configuration Report.....  | 330        |
| Print the WLAN Report.....   | 331        |
| Synchronize Time with the SNTP Server Using Web Based Management .....                                       | 334        |
| Technical Information for Advanced Users.....  | 338        |
| Reset the Network Settings to the Factory Settings.....  | 339        |
| <b>Security .....</b>  | <b>340</b> |
| Lock the Machine Settings .....  | 341        |
| Setting Lock Overview.....   | 342        |
| Network Security Features .....  | 346        |
| Before Using Network Security Features .....   | 347        |
| Secure Function Lock 3.0.....  | 348        |
| Manage Your Network Machine Securely Using SSL/TLS.....  | 354        |
| Send an Email Securely .....   | 386        |

|  |            |
|--|------------|
| <b>Mobile</b> .....  | <b>391</b> |
| Google Cloud Print.....  | 392        |
| Google Cloud Print Overview .....  | 393        |
| Before Using Google Cloud Print .....                                    | 394        |
| Print from Google Chrome™ or Chrome OS™ .....                            | 398        |
| Print from Google Drive™ for Mobile .....                                | 399        |
| Print from Gmail™ Webmail Service for Mobile .....                       | 400        |
| AirPrint .....   | 401        |
| AirPrint Overview.....   | 402        |
| Before Using AirPrint.....   | 403        |
| Print Using AirPrint .....   | 406        |
| Scan Using AirPrint .....  | 410        |
| Send a Fax Using AirPrint (For Fax supported Models).....                | 413        |
| Mobile Printing for Windows® .....                                       | 416        |
| Mopria® Print Service.....   | 417        |
| Print Utility .....  | 418        |
| Near-Field Communication (NFC).....                                      | 419        |
| <b>ControlCenter</b> .....   | <b>420</b> |
| ControlCenter4 (Windows®).....   | 421        |
| Change the Operation Mode in ControlCenter4 (Windows®) .....             | 422        |
| Scan Using ControlCenter4 Home Mode (Windows®).....                      | 424        |
| Scan Using ControlCenter4 Advanced Mode (Windows®).....                  | 425        |
| Set Up the Fuji Xerox Machine Using ControlCenter4 (Windows®).....       | 426        |
| Create a Custom Tab Using ControlCenter4 Advanced Mode (Windows®).....   | 428        |
| <b>iPrint&amp;Scan for Mac</b> .....                                     | <b>430</b> |
| iPrint&Scan Overview .....   | 431        |
| <b>Troubleshooting</b> .....   | <b>432</b> |
| Error and Maintenance Messages .....                                     | 433        |
| Document Jams .....  | 441        |
| Document is Jammed in the Top of the ADF Unit .....                      | 442        |
| Document is Jammed under the Document Cover .....                        | 443        |
| Remove Small Scraps of Paper Jammed in the ADF .....                     | 444        |
| Paper Jams .....   | 445        |
| Paper is Jammed in the Paper Tray .....                                  | 446        |
| Paper is Jammed in the MP tray .....                                     | 448        |
| Paper is Jammed in the Output Paper Tray .....                           | 449        |
| Paper is Jammed in the Back of the Machine .....                         | 450        |
| Paper is Jammed inside the Machine .....                                 | 452        |
| Paper is Jammed in the 2-sided Tray.....                                 | 454        |
| Printing Problems.....   | 456        |
| Improve the Print Quality.....   | 459        |
| Telephone and Fax Problems .....   | 465        |
| Set Dial Tone Detection.....   | 469        |
| Set Telephone Line Compatibility for Interference and VoIP Systems ..... | 470        |
| Network Problems.....  | 472        |
| Error Messages for Network Problems .....                                | 473        |







|  |            |
|--|------------|
| Where Can I Find My Fuji Xerox Machine's Network Settings? .....                   | 475        |
| I Cannot Complete the Wireless Network Setup Configuration.....                    | 476        |
| My Fuji Xerox Machine Cannot Print, Scan, or PC-FAX Receive over the Network ..... | 478        |
| I Want to Check that My Network Devices are Working Correctly .....                | 480        |
| Google Cloud Print Problems.....   | 481        |
| AirPrint Problems .....  | 482        |
| Other Problems .....   | 483        |
| Transfer Your Faxes or Fax Journal Report .....                                    | 485        |
| Transfer Faxes to Another Fax Machine .....  | 486        |
| Transfer Faxes to Your Computer .....  | 487        |
| Transfer the Fax Journal Report to Another Fax Machine .....                       | 489        |
| Machine Information.....   | 490        |
| Check the Serial Number .....  | 491        |
| Check the Firmware Version .....   | 492        |
| Reset Functions Overview .....   | 493        |
| Reset Your Fuji Xerox Machine .....  | 495        |
| <b>Routine Maintenance .....</b>   | <b>497</b> |
| Replace Supplies .....   | 498        |
| Replace the Toner Cartridge .....  | 500        |
| Replace the Drum Unit.....   | 503        |
| Clean the Machine .....  | 505        |
| Clean the Scanner.....   | 507        |
| Clean the Touchscreen LCD .....  | 508        |
| Clean the Corona Wire.....   | 509        |
| Clean the Drum Unit Using Drum Dot Print.....                                      | 511        |
| Clean the Paper Pick-up Rollers .....  | 517        |
| Check the Remaining Part Life .....  | 518        |
| <b>Machine Settings.....</b>   | <b>519</b> |
| Change Machine Settings from the Control Panel.....                                | 520        |
| In the Event of Power Failure (Memory Storage).....                                | 521        |
| General Settings.....  | 522        |
| Save Your Favourite Settings as a Shortcut.....                                    | 546        |
| Print Reports .....  | 549        |
| Settings and Features Tables.....  | 552        |
| Change Machine Settings from Your Computer.....                                    | 576        |
| Change Machine Settings Using Web Based Management .....                           | 577        |
| Change the Machine Settings Using Remote Setup.....                                | 582        |
| <b>Appendix.....</b>   | <b>593</b> |
| Specifications .....   | 594        |
| How to Enter Text on Your Fuji Xerox Machine.....                                  | 602        |
| Supplies .....   | 605        |
| Contacting Fuji Xerox.....   | 606        |
| New Zealand FAX Modem Statements .....   | 607        |

## Before You Use Your Fuji Xerox Machine

- [Definitions of Notes](#)
- [Trademarks](#)
- [Important Note](#)

## Definitions of Notes

We use the following symbols and conventions throughout this User's Guide:

|  |   |
|--|---|
|  <b>WARNING</b> | WARNING indicates a potentially hazardous situation which, if not avoided, could result in death or serious injuries.                           |
|  <b>CAUTION</b> | CAUTION indicates a potentially hazardous situation which, if not avoided, may result in minor or moderate injuries.                            |
| <b>IMPORTANT</b>   | IMPORTANT indicates a potentially hazardous situation which, if not avoided, may result in damage to property or loss of product functionality. |
| <b>NOTE</b>  | NOTE specifies the operating environment, conditions for installation, or special conditions of use.  |
|                 | Tips icons indicate helpful hints and supplementary information.  |
|                 | Electrical Hazard icons alert you to possible electrical shock.   |
|                 | Fire Hazard icons alert you to the possibility of a fire.   |
|                 | Hot Surface icons warn you not to touch hot machine parts.  |
|                 | Prohibition icons indicate actions you must not perform.  |
| <b>Bold</b>  | Bold style identifies buttons on the machine's control panel or computer screen.  |
| <i>Italics</i>   | Italicised style emphasises an important point or refers you to a related topic.  |
| Courier New  | Courier New font identifies messages shown on the machine's LCD.  |

### ✓ Related Information

- [Before You Use Your Fuji Xerox Machine](#)



## Trademarks

Microsoft, Windows, Windows Server, SharePoint, Internet Explorer, Outlook, PowerPoint, Excel and Active Directory are either registered trademarks or trademarks of Microsoft Corporation in the United States and/or other countries.

Apple, Mac, Safari, iPad, iPhone and iPod touch are trademarks of Apple Inc., registered in the United States and other countries.

AirPrint and macOS are trademarks of Apple Inc.

App Store is a service mark of Apple Inc.

PostScript and PostScript 3 are either registered trademarks or trademarks of Adobe Systems Incorporated in the United States and/or other countries.

Android, Gmail, Google Cloud Print, Google Drive, Google Chrome, Chrome OS and Google Play are trademarks of Google Inc. Use of these trademarks is subject to Google Permissions.

All product/brand names are trademarks or registered trademarks of the respective holders.

Microsoft product screen shot(s) reprinted with permission from Microsoft Corporation.

Xerox, Xerox and Design, as well as Fuji Xerox and Design are registered trademarks or trademarks of Xerox Corporation in Japan and/or other countries.



### Related Information

- [Before You Use Your Fuji Xerox Machine](#)
-

## Important Note

- Do not use this product outside the country of purchase as it may violate the wireless telecommunication and power regulations of that country.
- Not all models are available in all countries.
- Windows® 10 in this document represents Windows® 10 Home, Windows® 10 Pro, Windows® 10 Education and Windows® 10 Enterprise.
- Windows Server® 2008 in this document represents Windows Server® 2008 and Windows Server® 2008 R2.
- In this User's Guide, the LCD messages of the DocuPrint M275 z are used unless otherwise specified.
- In this User's Guide, the illustrations of the DocuPrint M275 z/DocuPrint M285 z are used unless otherwise specified.
- The screens in this User's Guide are for illustration purposes only and may differ from the actual screens.
- Unless otherwise specified, the screens in this manual are from Windows® 7 and macOS v10.11.x. Screens on your computer may vary depending on your operating system.
- The contents of this guide and the specifications of this product are subject to change without notice.
- Not all features are available in countries subject to applicable export restrictions.



### Related Information

- [Before You Use Your Fuji Xerox Machine](#)
-

## Introduction to Your Fuji Xerox Machine

- [Control Panel Overview](#)
- [Control Panel Overview](#)
- [Interface Overview](#)
- [Touchscreen LCD Overview](#)
- [How to Navigate the Touchscreen LCD](#)
- [Settings Screen Overview](#)
- [Access Fuji Xerox Utilities \(Windows®\)](#)

## Control Panel Overview

**Related Models:** DocuPrint M235 dw/DocuPrint M235 z

The control panel may vary depending on your model.

### DocuPrint M235 z

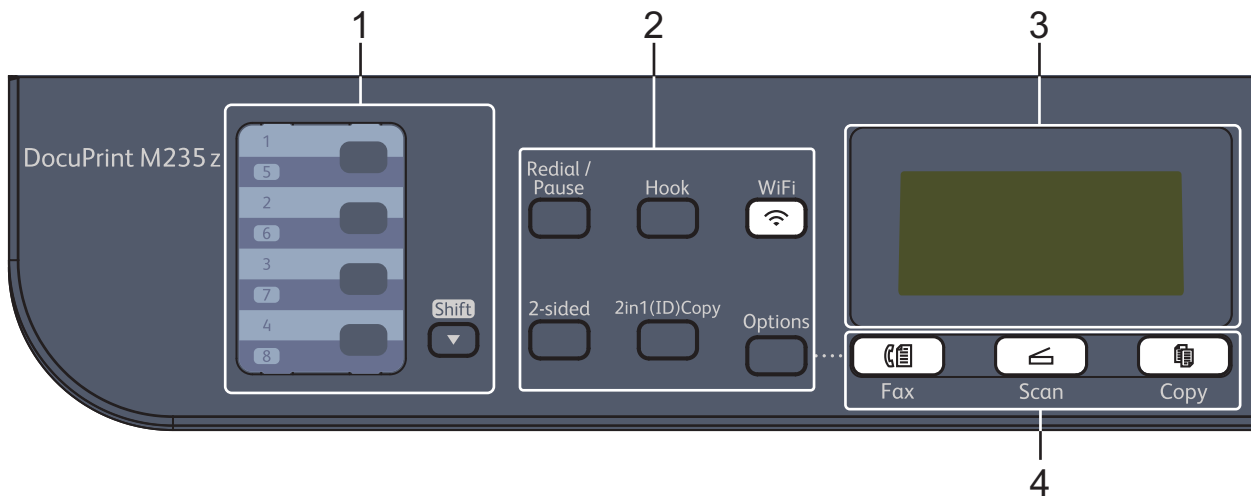

#### 1. One Touch buttons

Store and recall up to eight fax and telephone numbers.

To access stored One Touch fax and telephone numbers 1-4, press the One Touch button assigned to that number. To access stored One Touch fax and telephone numbers 5-8, press and hold **Shift** as you press the button.

#### 2. Function buttons

##### Redial/Pause

Press to dial the last number you called. This button also inserts a pause when programming quick dial numbers or when dialling a number manually.

##### Hook

Press **Hook** before dialing to ensure a fax machine answers, and then press **Start**.

If the machine is in Fax/Tel (F/T) Mode and you pick up the handset of an external telephone during the F/T ring (pseudo double-rings), press **Hook** to talk.

##### WiFi (for wireless models)

Press the **WiFi** button and launch the wireless installer on your computer. Follow the on-screen instructions to set up a wireless connection between your machine and your network.

When the **WiFi** light is on, your Fuji Xerox machine is connected to a wireless access point. When the **WiFi** light blinks, the wireless connection is down, or your machine is in the process of connecting to a wireless access point.

##### 2 in 1 (ID) Copy

Press to copy both sides of an identification card onto a single page.

##### 2-sided

Press to copy on both sides of a sheet of paper.

##### Options

Press to access temporary settings for faxing, scanning, or copying.

### 3. Liquid Crystal Display (LCD)

Displays messages to help you set up and use the machine.

If the machine is in Fax Mode, the LCD displays:

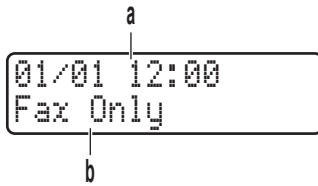

- a. Date & Time
- b. Receive Mode

When you press **Copy**, the LCD displays:

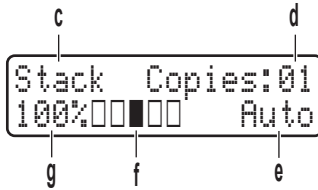

- c. Type of copy
- d. Number of copies
- e. Quality
- f. Contrast
- g. Copy ratio

### 4. Mode buttons

#### Fax

Press to switch the machine to FAX Mode.

#### Scan

Press to switch the machine to SCAN Mode.

#### Copy

Press to switch the machine to COPY Mode.

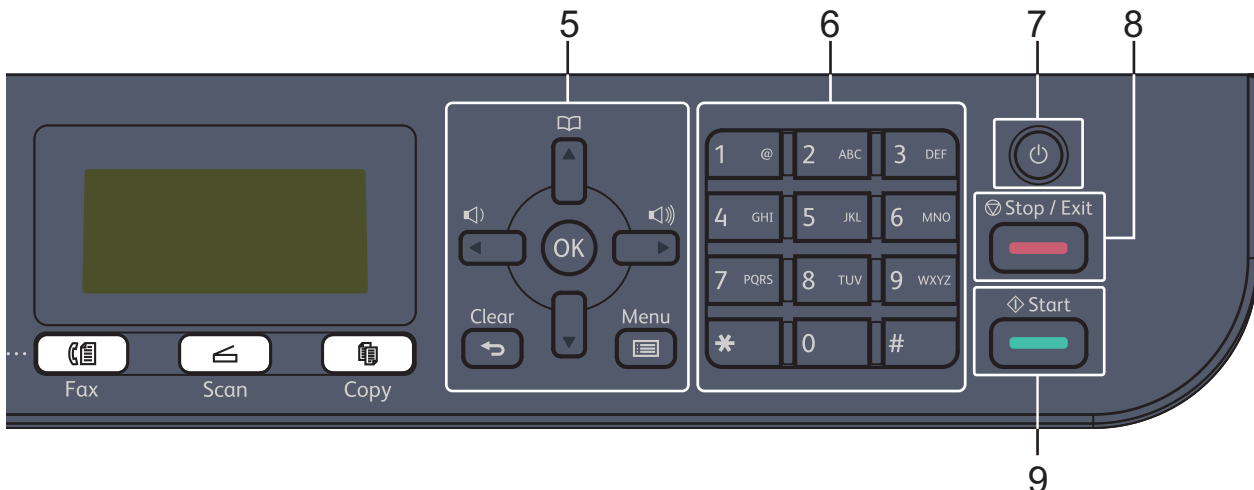

### 5. Menu buttons

#### Clear

Press to delete entered data or cancel the current setting.

#### Menu

Press to access the Menu for programming your machine settings.

## OK

Press to store your machine settings.

## ◀ or ▶

Press to scroll back or forward through menu selections.

## ▲ or ▼

- Press to scroll up or down through menus and options.
- Press to change the resolution in Fax Mode.





Press  to access speed dial numbers.

## 6. Dial Pad

- Use to dial fax and telephone numbers.
- Use as a keyboard to enter text or characters.

## 7. Power On/Off

- Turn on the machine by pressing .
- Turn off the machine by pressing and holding . The LCD displays [Shutting Down] and stays on for a few seconds before turning off. If you have an external telephone or TAD connected, it is always available.

## 8. Stop/Exit

- Press to stop an operation.
- Press to exit from a menu.



## 9. Start

- Press to start sending faxes.
- Press to start copying.
- Press to start scanning documents.

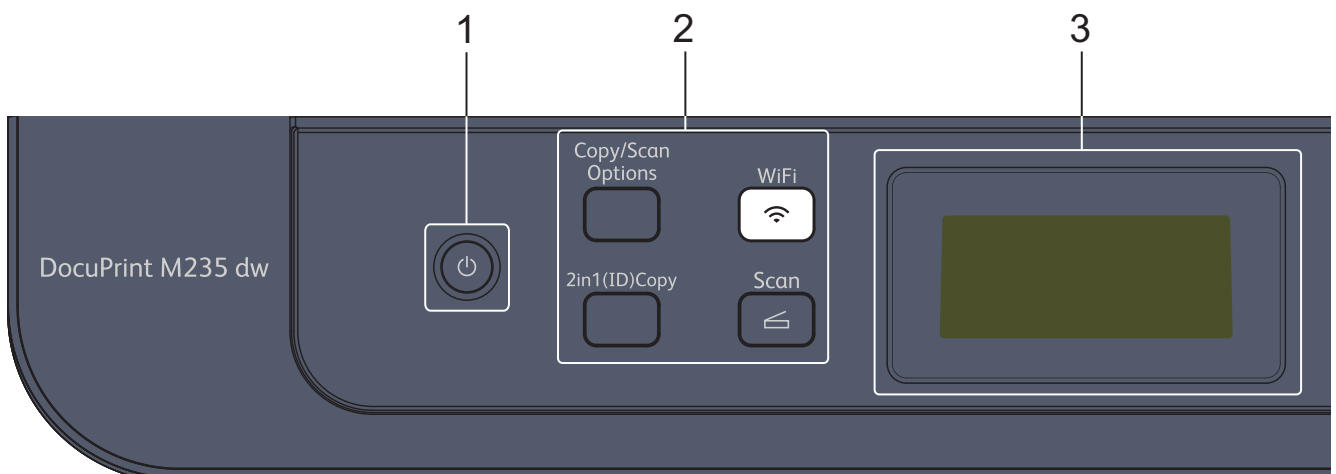
## DocuPrint M235 dw



## 1. Power On/Off

- Turn on the machine by pressing .
- Turn off the machine by pressing and holding . The LCD displays [Shutting Down] and stays on for a few seconds before turning off.

## 2. Function buttons

### Copy/Scan Options

Press to access temporary settings for scanning or copying.

### WiFi (for wireless models)

Press the **WiFi** button and launch the wireless installer on your computer. Follow the on-screen instructions to set up a wireless connection between your machine and your network.

When the **WiFi** light is on, your Fuji Xerox machine is connected to a wireless access point. When the **WiFi** light blinks, the wireless connection is down, or your machine is in the process of connecting to a wireless access point.

### Scan

Press to switch the machine to Scan Mode.

### 2 in 1 (ID) Copy

Press to copy both sides of an identification card onto a single page.

## 3. Liquid Crystal Display (LCD)

Displays messages to help you set up and use the machine.

If the machine is in Ready Mode or COPY Mode, the LCD displays:

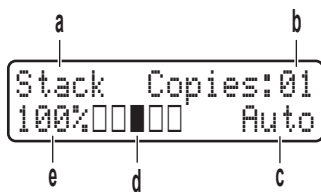

- Type of copy
- Number of copies
- Quality
- Contrast
- Copy ratio

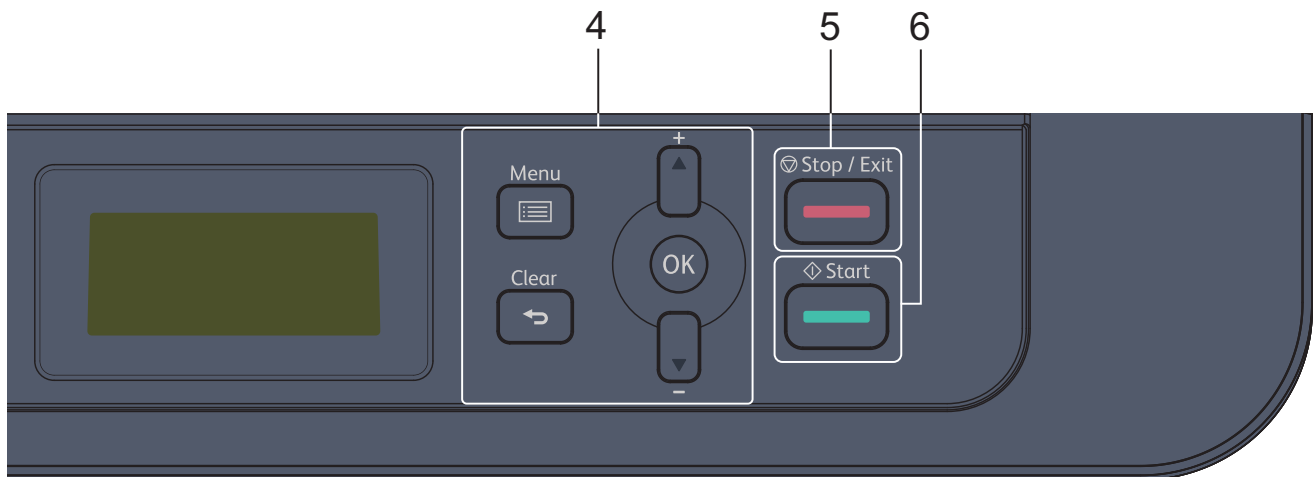

## 4. Menu buttons

### Menu

Press to access the Menu for programming your machine settings.

### Clear

- Press to delete entered data.
- Press to cancel the current setting.

### OK

Press to store your machine settings.

---

**▲ or ▼**

Press to scroll up or down through menus and options.

**5. Stop/Exit**

- Press to stop an operation.
- Press to exit from a menu.

**6. Start**

- Press to start copying.
- Press to start scanning documents.

**Related Information**

- [Introduction to Your Fuji Xerox Machine](#)
-



## Control Panel Overview

**Related Models:** DocuPrint M275 z/DocuPrint M285 z

The control panel may vary depending on your model.

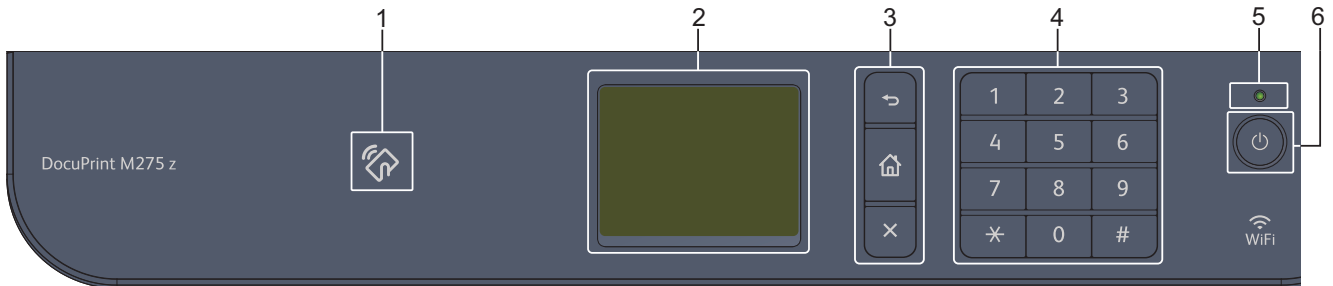

### 1. Near Field Communication (NFC) (DocuPrint M275 z/DocuPrint M285 z)

If your Android™ device supports the NFC feature, you can print from your device or scan documents to your device by touching it to the NFC symbol on the control panel.

### 2. Touchscreen Liquid Crystal Display (LCD)

Access menus and options by pressing them on the touchscreen.

### 3. Menu Buttons



**(Back)**

Press to go back to the previous menu.



**(Home)**

Press to return to the Home screen.



**(Cancel)**

Press to cancel an operation.

### 4. Dial Pad (Numerical buttons)

Press the numbers on the touchpanel to dial telephone or fax numbers and to enter the number of copies.

### 5. LED Power Indicator

The LED lights up depending on the machine's power status.

### 6. Power On/Off

- Turn on the machine by pressing .
- Turn off the machine by pressing and holding down . The touchscreen LCD displays [Shutting Down] and stays on for a few seconds before turning off. If you have an external telephone or TAD connected, it is always available.



## Related Information

- [Introduction to Your Fuji Xerox Machine](#)

## Interface Overview

The available connection interfaces vary depending on the model.

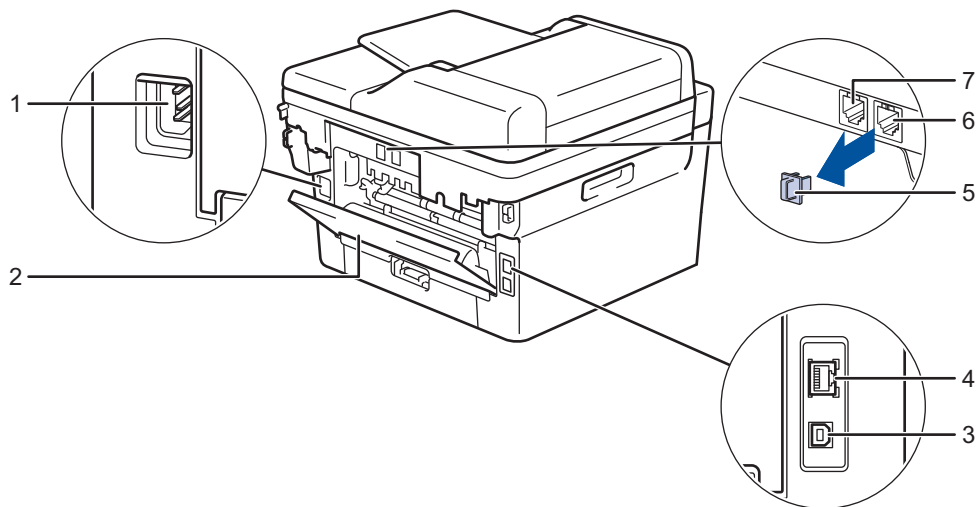

1. AC Power Connector
2. Back Cover (Output Tray)
3. USB Port
4. Network Port
5. Phone Connector CAP (DocuPrint M235 z/DocuPrint M275 z/DocuPrint M285 z)
6. Phone Connector (DocuPrint M235 z/DocuPrint M275 z/DocuPrint M285 z)
7. Wall Jack Connector (DocuPrint M235 z/DocuPrint M275 z/DocuPrint M285 z)



### Related Information

- [Introduction to Your Fuji Xerox Machine](#)

## Touchscreen LCD Overview

**Related Models:** DocuPrint M275 z/DocuPrint M285 z

When a Home screen is displayed, press ◀ or ▶ to display the other Home screens.

The Home screen displays the machine's status when the machine is idle. When displayed, this screen indicates that your machine is ready for the next command.



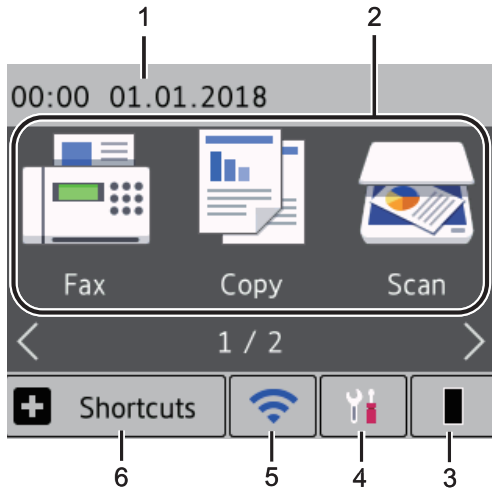

The available features will vary depending on your model.



### 1. Date & Time

Displays the date and time set on the machine.

### 2. Modes

-  [Fax]  
Press to access Fax mode.
-  [Copy]  
Press to access Copy mode.
-  [Scan]  
Press to access Scan mode.
-  [Secure Print]  
Press to access the [Secure Print] option.

### 3. Toner

Displays the remaining toner life. Press to access the [Toner] menu.

When the Toner cartridge is near the end of life or has a problem, an error icon  appears on the Toner icon.

### 4. [Settings]

Press to access the [Settings] menu.

If Secure Function Lock or Setting Lock has been turned on, a lock  icon appears on the LCD. You must unlock the machine to use Settings.

### 5. WiFi or

**(Wireless Status for wireless models)**

Press to configure wireless settings.

If you are using a wireless connection, a four-level indicator in each of the Home screens displays the current wireless signal strength.

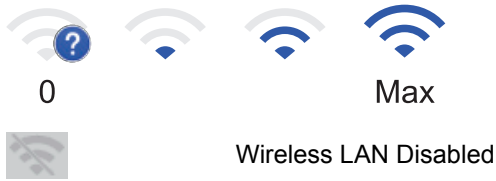

6. **+** [Shortcuts]

Press to create Shortcuts for frequently-used operations, such as sending a fax, making a copy, and scanning.



- Three Shortcuts screens are available with up to four Shortcuts on each Shortcuts screen. A total of 12 Shortcuts are available.
- To display the other Shortcuts screens, press ◀ or ▶.

**Stored Fax(es)**

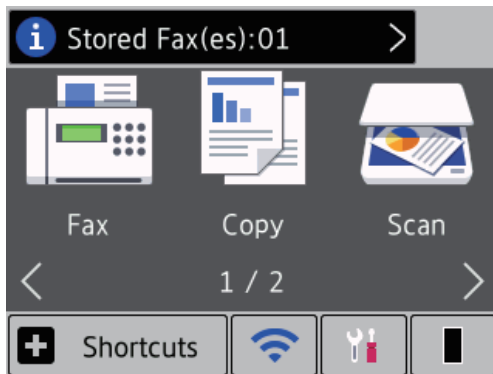

The number of received faxes in memory appears at the top of the screen.

Press **i**, and then press [Yes] to print the faxes.

**Warning icon**

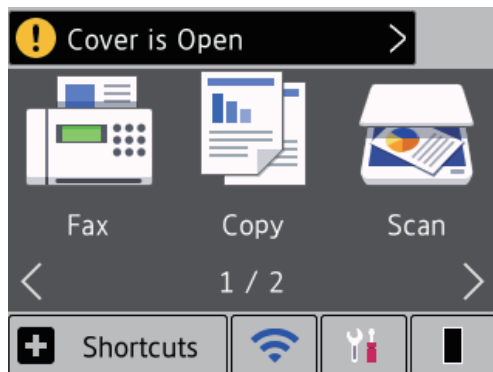

The warning icon **!** appears when there is an error or maintenance message; press the message area to view it, and then press **X** to return to Ready Mode.

**NOTE**

- This product adopts the font of ARPHIC TECHNOLOGY CO., LTD.

**✓ Related Information**

- [Introduction to Your Fuji Xerox Machine](#)

## How to Navigate the Touchscreen LCD

**Related Models:** DocuPrint M275 z/DocuPrint M285 z

Press your finger on the LCD to operate it. To display and access all the options, press ◀▶ or ▲▼ on the LCD to scroll through them.

The following steps explain how to navigate through changing a machine setting. In this example, the LCD Backlight setting is changed from [Light] to [Med].

### IMPORTANT

DO NOT press the LCD with a sharp object such as a pen or stylus. It may damage the machine.

### NOTE

DO NOT touch the LCD immediately after plugging in the power cord or turning on the machine. Doing this may cause an error.

1. Press  ([Settings]).
2. Press [All Settings].
3. Press ▲ or ▼ to display the [General Setup] option, and then press [General Setup].

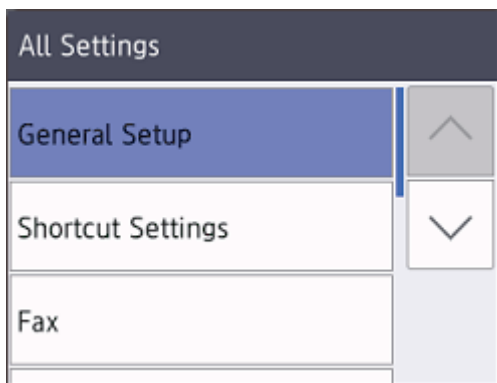

4. Press ▲ or ▼ to display the [LCD Settings] option, and then press [LCD Settings].

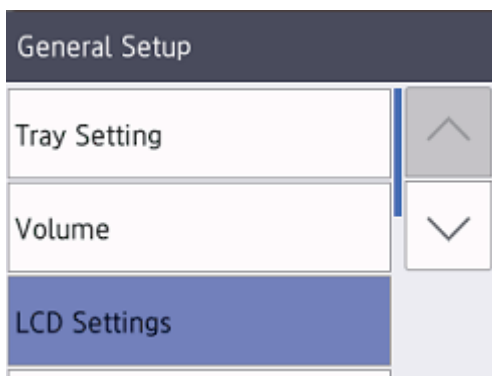

5. Press [Backlight].

---

## LCD Settings

Backlight

Light

Dim Timer

30Secs

6. Press [Med].

Backlight

Light

Med

Dark

7. Press .



## Related Information

- [Introduction to Your Fuji Xerox Machine](#)
-

## Settings Screen Overview

**Related Models:** DocuPrint M275 z/DocuPrint M285 z

Press  to view the current machine status on the LCD.

Use the Settings menu to access all of your Fuji Xerox machine's settings.

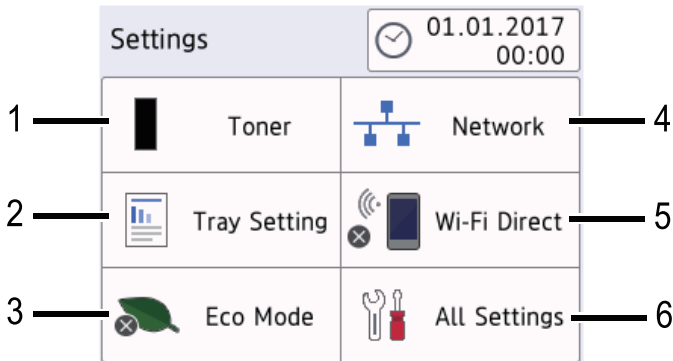

### 1. Toner

- Displays the remaining toner life.
- Press to access the [Toner] menu.

### 2. Tray Setting

Press to change the paper size and paper type settings.

### 3. Eco Mode

Press to access the [Eco Mode] menu.

### 4. Network

- Press to set up a network connection.
- A four-level indicator on the screen displays the current wireless signal strength if you are using a wireless connection.

### 5. Wi-Fi Direct

Press to set up a Wi-Fi Direct™ network connection.

### 6. All Settings

Press to access the menu of all machine settings.

## ✓ Related Information

- [Introduction to Your Fuji Xerox Machine](#)

## Access Fuji Xerox Utilities (Windows®)

**Fuji Xerox Utilities** is an application launcher that offers convenient access to all Fuji Xerox applications installed on your computer.

1. Do one of the following:

- (Windows® 7)

Click  (**Start**) > **All Programs** > **Fuji Xerox** > **Fuji Xerox Utilities**.

- (Windows® 8)

Tap or click  (**Fuji Xerox Utilities**) either on the **Start** screen or the desktop.

- (Windows® 8.1)

Move your mouse to the lower left corner of the **Start** screen and click  (if you are using a touch-based device, swipe up from the bottom of the **Start** screen to bring up the **Apps** screen).

When the **Apps** screen appears, tap or click  (**Fuji Xerox Utilities**).

- (Windows® 10)

Click  > **Fuji Xerox** > **Fuji Xerox Utilities**.

2. Select your machine (where XXXXX is the name of your model).

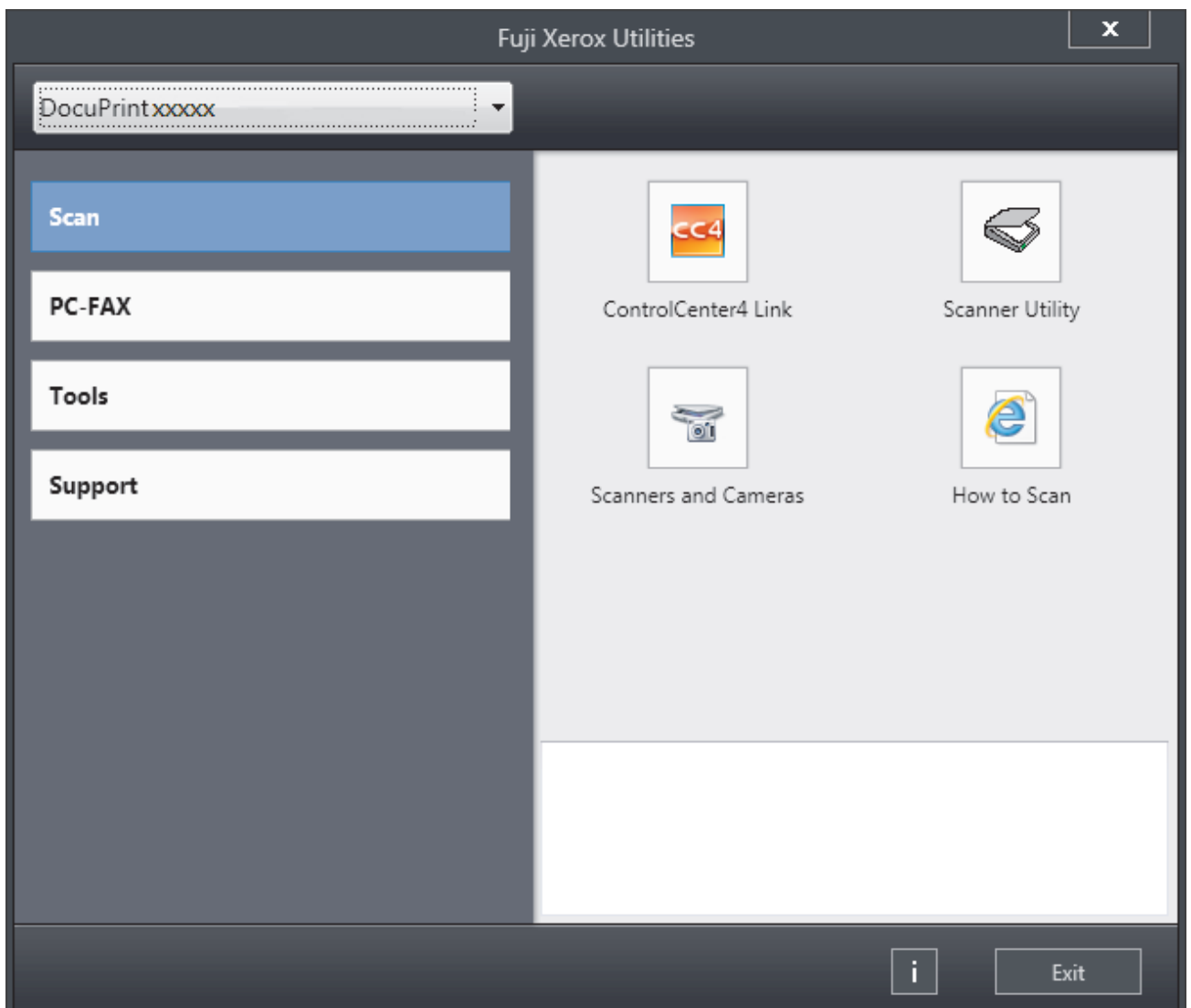

3. Choose the operation you want to use.





## Related Information

- [Introduction to Your Fuji Xerox Machine](#)
  - [Uninstall the Fuji Xerox Software and Drivers \(Windows®\)](#)
-

## Uninstall the Fuji Xerox Software and Drivers (Windows®)

1. Do one of the following:

- (Windows® 7)

Click  (**Start**) > **All Programs** > **Fuji Xerox** > **Fuji Xerox Utilities**.

- (Windows® 8)

Tap or click  (**Fuji Xerox Utilities**) either on the **Start** screen or the desktop.

- (Windows® 8.1)

Move your mouse to the lower left corner of the **Start** screen and click  (if you are using a touch-based device, swipe up from the bottom of the **Start** screen to bring up the **Apps** screen).

When the **Apps** screen appears, tap or click  (**Fuji Xerox Utilities**).

- (Windows® 10)

Click  > **Fuji Xerox** > **Fuji Xerox Utilities**.

2. Click the drop-down list, and then select your model name (if not already selected). Click **Tools** in the left navigation bar, and then click **Uninstall**.

Follow the instructions in the dialog box to uninstall the software and drivers.



### Related Information

- [Access Fuji Xerox Utilities \(Windows®\)](#)

## Paper Handling

- [Load Paper](#)
- [Paper Settings](#)
- [Load Documents](#)
- [Unscannable and Unprintable Areas](#)
- [Using Special Paper](#)

## Load Paper

- Load and Print Using the Paper Tray
- Load and Print Using the Multi-purpose Tray (MP Tray)
- Load and Print Paper in the Manual Feed Slot

## Load and Print Using the Paper Tray

- [Load Paper in the Paper Tray](#)

## Load Paper in the Paper Tray

- If the Check Size setting is set to On and you pull the paper tray out of the machine, a message appears on the LCD asking if you want to change the paper size and paper type. Change the paper size and paper type settings if needed, following the LCD instructions.
- When you load a different size and type of paper in the tray, you must also change the Paper Size and Paper Type settings in the machine, or on your computer.

1. Pull the paper tray completely out of the machine.

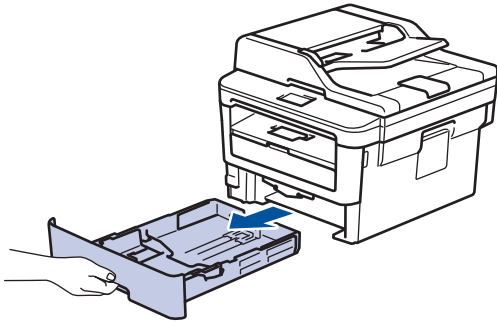

2. Press and slide the paper guides to fit the paper.  
Press the green release levers to slide the paper guides.

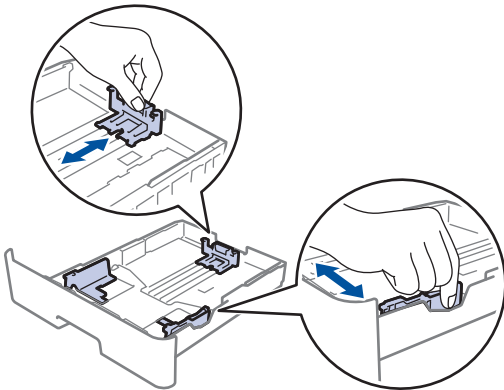

 For Legal or Folio size paper, press the release button (1) in the bottom of the paper tray and then pull out the back of the paper tray. (Legal and Folio size paper are not available in some regions.)

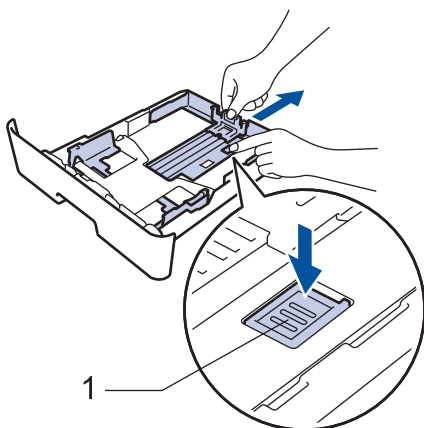

3. Fan the stack of paper well.
4. Load paper in the paper tray with the printing surface *face down*.

- 
5. Make sure the paper is below the maximum paper mark (▼▼▼).  
Overfilling the paper tray will cause paper jams.

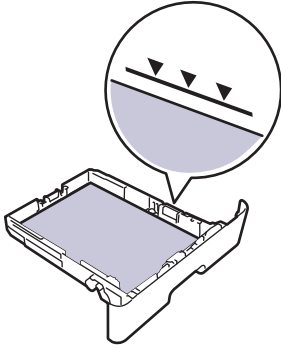

6. Slowly push the paper tray completely into the machine.
7. Lift the support flap to prevent paper from sliding off the output tray.

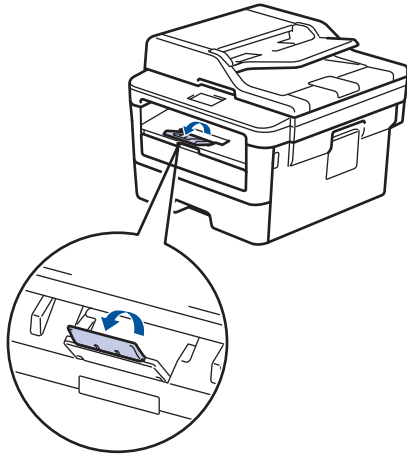

---

### ✓ Related Information

- [Load and Print Using the Paper Tray](#)
-

## Load and Print Using the Multi-purpose Tray (MP Tray)

You can load thin paper, thick paper, recycled paper, bond paper, labels, up to 30 sheets of plain paper, or up to 2 envelopes in the MP tray.

- [Load Paper in the Multi-purpose Tray \(MP Tray\)](#)
- [Load and Print Labels Using the MP Tray](#)
- [Load and Print Envelopes Using the MP Tray](#)
- [Printing Problems](#)
- [Error and Maintenance Messages](#)



## Load Paper in the Multi-purpose Tray (MP Tray)

**Related Models:** DocuPrint M285 z

When you load a different size and type of paper in the tray, you must also change the Paper Size and Paper Type settings in the machine, or on your computer.

- Plain Paper
- Thin Paper
- Thick Paper
- Recycled Paper
- Bond

1. Lift the support flap to prevent paper from sliding off the face down output tray.

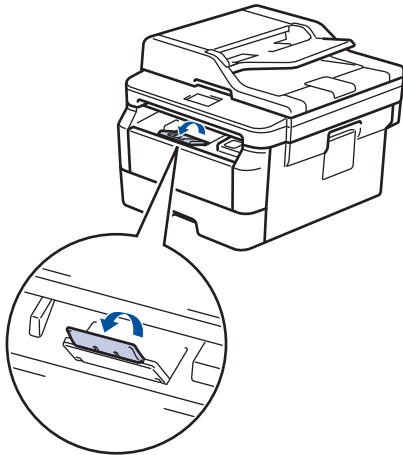

2. Open the MP tray and lower it gently.

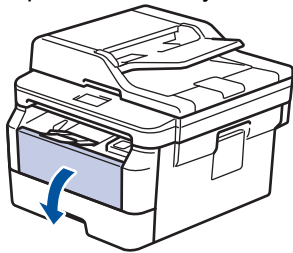

When using paper smaller than A6/A5 (Long Edge), you can skip the next step.

3. Pull out the MP tray support (1).

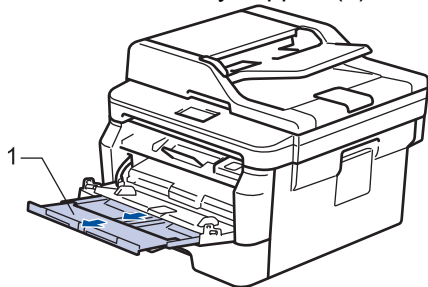



When using Legal or Folio size paper, pull out the paper support (1).

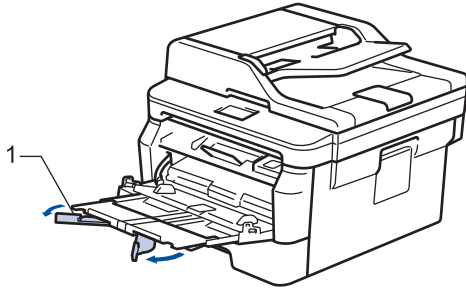

4. Slide the MP tray paper guides to fit the width of the paper you are using.



5. Load paper with the printing surface *face up* in the MP tray.



• Make sure the paper is below the maximum paper mark (1).

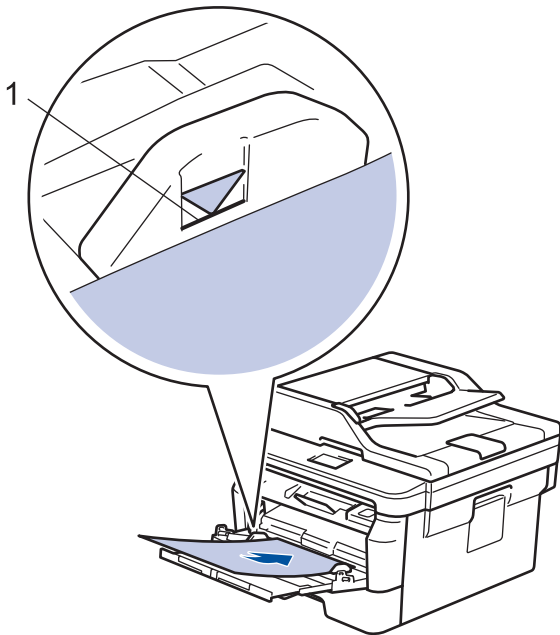

### Related Information

- [Load and Print Using the Multi-purpose Tray \(MP Tray\)](#)

## Load and Print Labels Using the MP Tray

**Related Models:** DocuPrint M285 z

When the back cover (face up output tray) is pulled down, the machine has a straight paper path from the MP tray through to the back of the machine. Use this paper feed and output method when you print on labels.

When you load a different size and type of paper in the tray, you must also change the Paper Size and Paper Type settings in the machine, or on your computer.

1. Open the machine's back cover (the face up output tray).

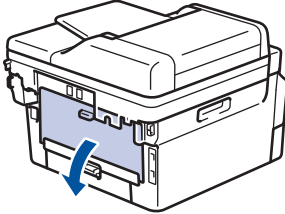

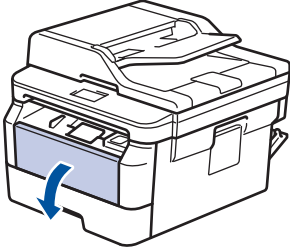

2. On the front of the machine, open the MP tray and lower it gently.

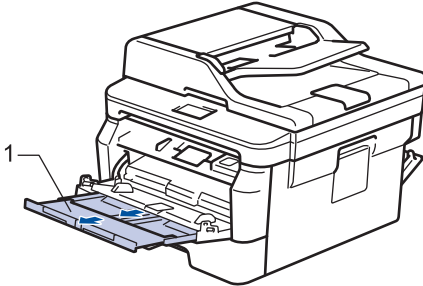

 When using paper smaller than A6/A5 (Long Edge), you can skip the next step.

3. Pull out the MP tray support (1).



 When using Legal or Folio size paper, pull out the paper support (1).

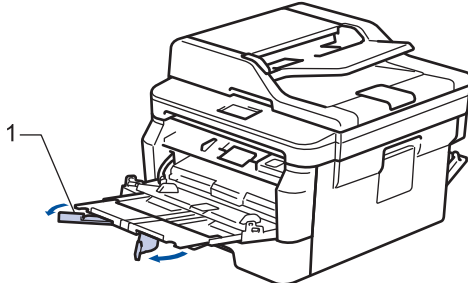

4. Slide the MP tray paper guides to fit the width of the paper you are using.

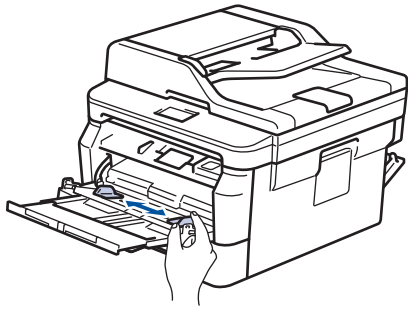

5. Load paper with the printing surface *face up* in the MP tray.

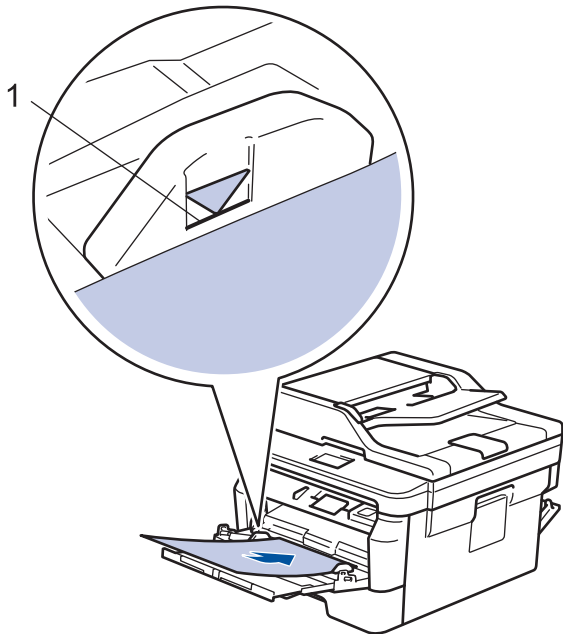

- Make sure the paper is below the maximum paper mark (1).

6. Change your print preferences in the Print screen before sending the print job from your computer.
7. Send your print job to the machine.
8. Close the back cover (the face up output tray) until it locks in the closed position.



### Related Information

- [Load and Print Using the Multi-purpose Tray \(MP Tray\)](#)

## Load and Print Envelopes Using the MP Tray

**Related Models:** DocuPrint M285 z

You can load up to two envelopes in the MP tray.

Before loading, press the corners and sides of the envelopes to make them as flat as possible.

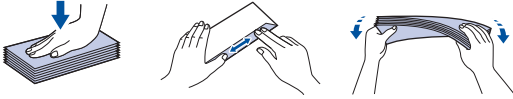

When you load a different size and type of paper in the tray, you must also change the Paper Size and Paper Type settings in the machine, or on your computer.

1. Open the machine's back cover (the face up output tray).

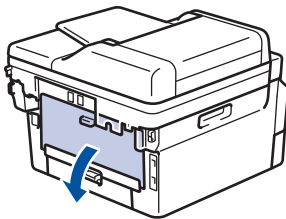

2. Pull down the two green levers, one on the left side and one on the right side, as shown in the illustration.

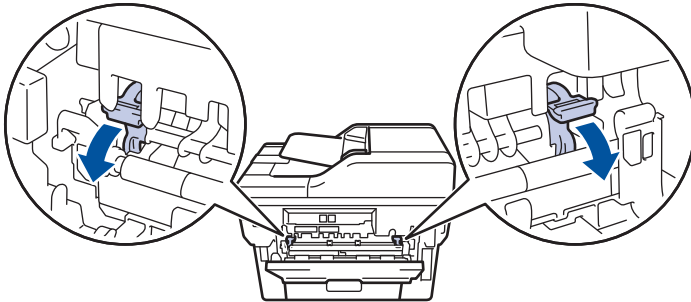

3. On the front of the machine, open the MP tray and lower it gently.

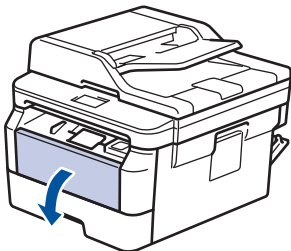

4. Pull out the MP tray support (1).

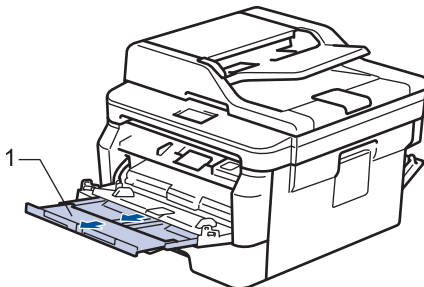

5. Slide the MP tray paper guides to fit the width of the envelopes that you are using.

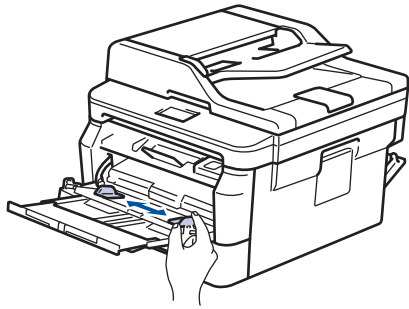

6. Load paper with the printing surface *face up* in the MP tray.

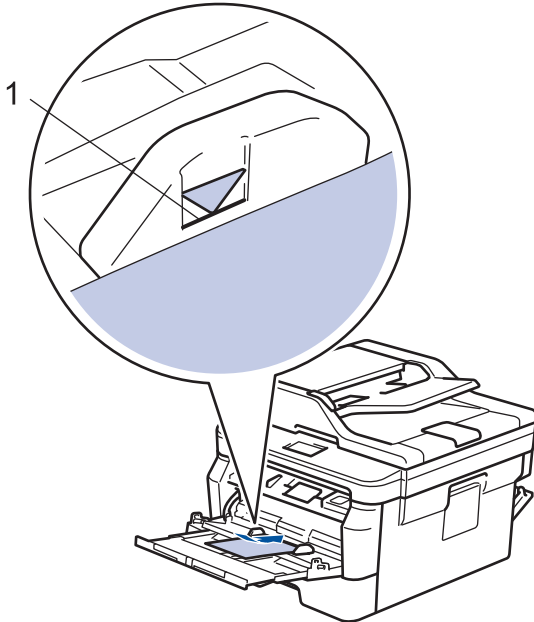

- Load up to two envelopes in the MP tray with the printing surface face up. Make sure the envelopes are below the maximum paper mark (1). Loading more than two envelopes may cause paper jams.

7. Change your print preferences in the Print dialog box before sending the print job from your computer.

| Settings   | Options for Envelopes                |
|------------|--------------------------------------|
| Paper Size | Com-10<br>DL<br>C5<br>Monarch        |
| Media Type | Envelopes<br>Env. Thick<br>Env. Thin |

8. Send your print job to the machine.

9. When you have finished printing, return the two green levers you adjusted in the earlier step back to their original positions.

10. Close the back cover (the face up output tray) until it locks in the closed position.



### Related Information

- [Load and Print Using the Multi-purpose Tray \(MP Tray\)](#)

## Load and Print Paper in the Manual Feed Slot

- [Load and Print Plain Paper, Thin Paper, Recycled Paper and Bond Paper in the Manual Feed Slot](#)
- [Load and Print on Thick Paper and Labels in the Manual Feed Slot](#)
- [Load and Print on Envelopes in the Manual Feed Slot](#)

## Load and Print Plain Paper, Thin Paper, Recycled Paper and Bond Paper in the Manual Feed Slot

**Related Models:** DocuPrint M235 dw/DocuPrint M235 z/DocuPrint M275 z

When you load a different paper size in the tray, you must change the Paper Size setting in the machine or on your computer at the same time.

1. Lift the support flap to prevent paper from sliding off the face down output tray.

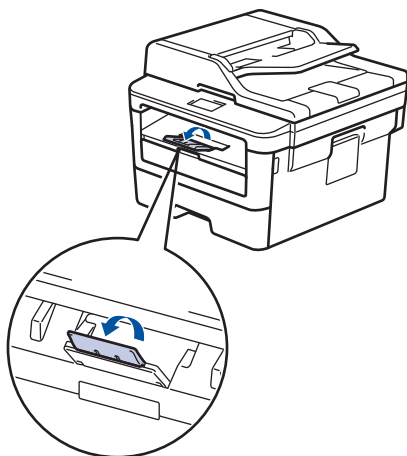

2. Open the manual feed slot cover.

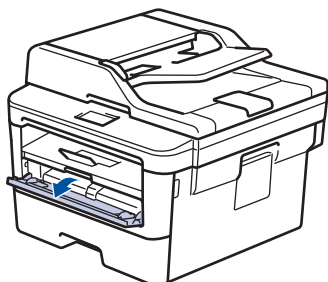

3. Use both hands to slide the manual feed slot paper guides to fit the width of the paper you are using.

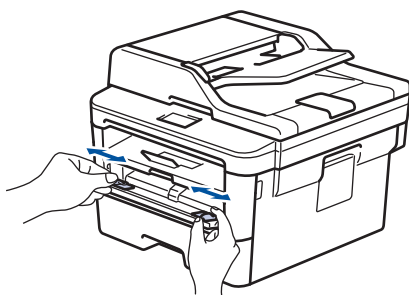

4. Using both hands, put one full sheet of paper in the manual feed slot until the front edge touches the paper feed roller. When you feel the machine pull it in, let go.

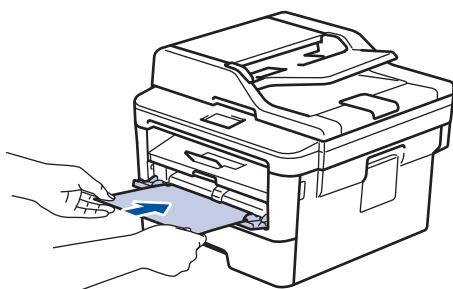





- Load paper into the manual feed slot with the printing surface facing up.
- Make sure the paper is straight and in the correct position in the manual feed slot. If it is not, the paper may not be fed correctly, resulting in a skewed printout or a paper jam.
- To remove a small printout from the output tray, use both hands to lift up the scanner cover.

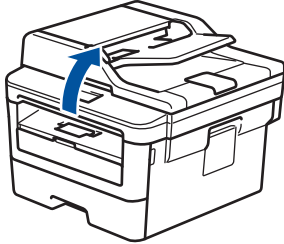

- You can still use the machine while the scanner cover is up. To close the scanner cover, push it down with both hands.

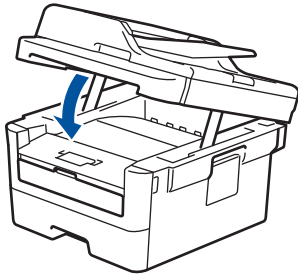

5. Send your print job to the machine.



Change your print preferences in the Print screen before sending the print job from your computer.

6. After the printed page comes out from the machine, load the next sheet of paper in the manual feed slot. Repeat for each page that you want to print.



### Related Information

- [Load and Print Paper in the Manual Feed Slot](#)

## Load and Print on Thick Paper and Labels in the Manual Feed Slot

**Related Models:** DocuPrint M235 dw/DocuPrint M235 z/DocuPrint M275 z

When you load a different paper size in the tray, you must change the Paper Size setting in the machine or on your computer at the same time.

1. Open the machine's back cover (the face up output tray).

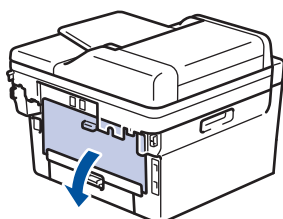

 The machine automatically turns on Manual Feed mode when you load paper in the manual feed slot.

2. On the front of the machine, open the manual feed slot cover.

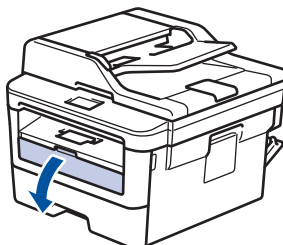

3. Use both hands to slide the manual feed slot paper guides to fit the width of the paper that you are using.

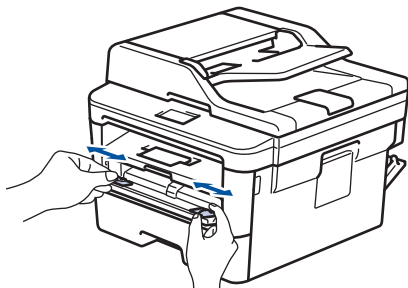

4. Using both hands, put one full sheet of paper in the manual feed slot until the front edge touches the paper feed roller. When you feel the machine pull it in, let go.

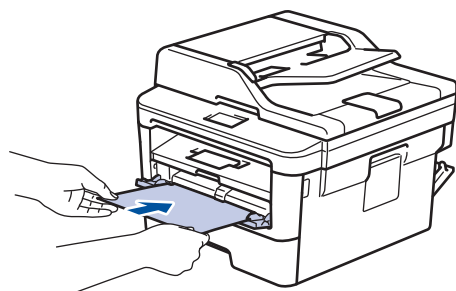



- Load paper into the manual feed slot with the printing surface facing up.
  - Pull the paper out completely if you must reload the paper into the manual feed slot.
  - Do not put more than one sheet of paper in the manual feed slot at one time, as it may cause a jam.
  - Make sure the paper is straight and in the correct position in the manual feed slot. If it is not, the paper may not be fed correctly, resulting in a skewed printout or a paper jam.
- 

5. Send your print job to the machine.



Change your print preferences in the Print screen before sending the print job from your computer.

---

6. After the printed page comes out from the back of the machine, load the next sheet of paper in the manual feed slot. Repeat for each page that you want to print.
7. Close the back cover (the face up output tray) until it locks in the closed position.



### **Related Information**

- [Load and Print Paper in the Manual Feed Slot](#)
-

## Load and Print on Envelopes in the Manual Feed Slot

**Related Models:** DocuPrint M235 dw/DocuPrint M235 z/DocuPrint M275 z

Before loading, press the corners and sides of the envelopes to make them as flat as possible.

When you load a different paper size in the tray, you must change the Paper Size setting in the machine or on your computer at the same time.

1. Open the machine's back cover (the face up output tray).

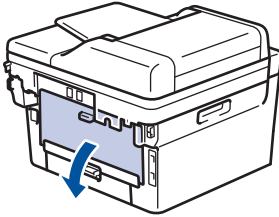

 The machine automatically turns on Manual Feed mode when you load paper in the manual feed slot.

2. Pull down the two green levers, one on the left side and one on the right side, as shown in the illustration.

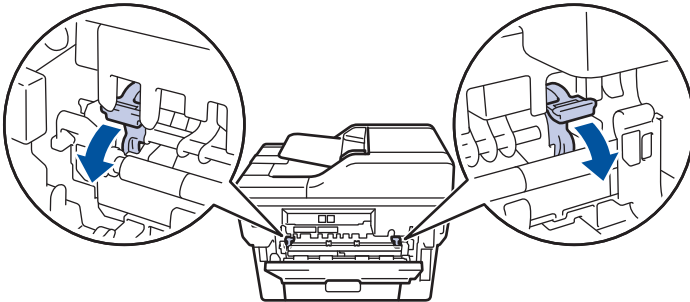

3. On the front of the machine, open the manual feed slot cover.

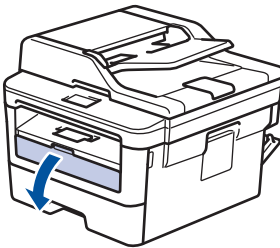

4. Use both hands to slide the manual feed slot paper guides to fit the width of the paper that you are using.

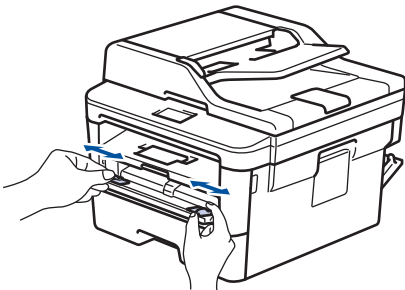

5. Using both hands, put one envelope in the manual feed slot until the front edge touches the paper feed roller. When you feel the machine pull it in, let go.

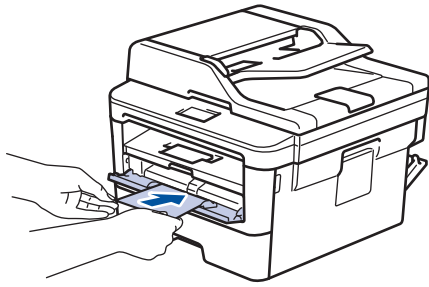

- 
- Load the envelope into the manual feed slot with the printing surface facing up.
  - Pull the envelope out completely when you reload the envelope into the manual feed slot.
  - Do not put more than one envelope in the manual feed slot at one time, as it may cause a jam.
  - Make sure the envelope is straight and in the correct position on the manual feed slot. If it is not, the envelope may not be fed correctly, resulting in a skewed printout or a paper jam.
- 
6. Send your print job to the machine.

 Change your print preferences in the Print dialog box before sending the print job from your computer.

---

| Settings   | Options for Envelopes                |
|------------|--------------------------------------|
| Paper Size | Com-10<br>DL<br>C5<br>Monarch        |
| Media Type | Envelopes<br>Env. Thick<br>Env. Thin |

7. After the printed envelope comes out of the machine, put in the next envelope. Repeat for each envelope that you want to print.
8. When you have finished printing, return the two green levers you adjusted in the earlier step back to their original positions.
9. Close the back cover (the face up output tray) until it locks in the closed position.

### Related Information

- [Load and Print Paper in the Manual Feed Slot](#)
-

## Paper Settings

- [Change the Paper Size and Paper Type](#)
- [Select the Tray to Be Used For Printing](#)
- [Change the Check Paper Size Setting](#)

## Change the Paper Size and Paper Type

When you change the size and type of the paper you load in the tray, you must change the Paper Size and Paper Type settings on the LCD at the same time.

>> [DocuPrint M235 dw/DocuPrint M235 z](#)

>> [DocuPrint M275 z/DocuPrint M285 z](#)

### DocuPrint M235 dw/DocuPrint M235 z

1. Press **Menu**.
2. Press **▲** or **▼** to display the [General Setup] option, and then press **OK**.
3. Press **▲** or **▼** to display the [Tray Setting] option, and then press **OK**.
4. Press **▲** or **▼** to display the [Paper Type] option, and then press **OK**.
5. Press **▲** or **▼** to display the [Thin Paper], [Plain Paper], [Thick Paper], or [Recycled Paper] option, and then press **OK**.
6. Press **▲** or **▼** to display the [Paper Size] option, and then press **OK**.
7. Press **▲** or **▼** to display the [A4], [Letter], [Legal], [Executive], [A5], [A5 (Long Edge)], [A6], or [Folio] option, and then press **OK**.



[Legal] and [Folio] size paper are not available in some regions.

8. Press **Stop/Exit**.

### DocuPrint M275 z/DocuPrint M285 z

1. Press  [Settings] > [All Settings] > [General Setup] > [Tray Setting] > [Paper Type].



(For models with MP Tray) Select the paper tray option you want.

2. Press **▲** or **▼** to display the [Thin], [Plain Paper], [Thick], [Thicker] or [Recycled Paper] option, and press the option you want.



The paper type may vary depending on your model.

3. Press [Paper Size].
4. Press **▲** or **▼** to display the [A4], [Letter], [A5], [A5 (Long Edge)], [A6], [Executive], [Legal], or [Folio] option, and press the option you want.



The paper size may vary depending on your model.

5. Press .



### ✓ Related Information

- [Paper Settings](#)

## Select the Tray to Be Used For Printing

**Related Models:** DocuPrint M285 z

Change the default tray the machine will use for printing copies, received faxes, and print jobs from your computer.

1. Press  [Settings] > [All Settings] > [General Setup] > [Tray Setting].
2. Press ▲ or ▼ to display the [Tray Use: Copy], [Tray Use: Fax], or [Tray Use: Print] option, and then press the option you want.
3. Press ▲ or ▼ to display the option you want, and then press it. For example, when you select the [MP>T1] option, the machine pulls paper from the MP tray until it is empty, and then from Tray 1.
4. Press .



- When you make a copy using the ADF and give priority to multiple trays, the machine looks for the tray with the most suitable paper and pulls paper from that tray.
- When you make a copy using the scanner glass, your document is copied from the higher priority tray even if more suitable paper is in another paper tray.
- (DocuPrint M285 z) Use the following sizes of paper for printing faxes: Letter, A4, Legal, Folio. Available paper sizes may differ depending on your country. When an appropriate size is not in any of the trays, the machine stores received faxes and [Size mismatch] appears on the touchscreen.
- (DocuPrint M285 z) If the tray is out of paper and received faxes are in the machine's memory, [No Paper] appears on the touchscreen. Load paper in the empty tray.



### Related Information

- [Paper Settings](#)



## Change the Check Paper Size Setting

When you turn on your machine's Check Size setting, the machine displays a message when you remove a paper tray or load paper using the MP tray, asking if you changed the paper size and paper type.

The default setting is On.



>> [DocuPrint M235 dw/DocuPrint M235 z](#)

>> [DocuPrint M275 z/DocuPrint M285 z](#)

### DocuPrint M235 dw/DocuPrint M235 z

1. Press **Menu**.
2. Press **▲** or **▼** to display the [General Setup] option, and then press **OK**.
3. Press **▲** or **▼** to display the [Tray Setting] option, and then press **OK**.
4. Press **▲** or **▼** to display the [Check Size] option, and then press **OK**.
5. Press **▲** or **▼** to select the [On] or [Off] option, and then press **OK**.
6. Press **Stop/Exit**.

### DocuPrint M275 z/DocuPrint M285 z

1. Press  [Settings] > [All Settings] > [General Setup] > [Tray Setting] > [Check Size].
2. Press [On] or [Off].
3. Press .

### Related Information

- [Paper Settings](#)

## Load Documents

You can send a fax, make copies and scan from the Automatic Document Feeder (ADF) and from the scanner glass.

- [Load Documents in the Automatic Document Feeder \(ADF\)](#)
- [Load Documents on the Scanner Glass](#)

## Load Documents in the Automatic Document Feeder (ADF)

Use the ADF when copying or scanning multiple-page, standard-sized documents.

- The ADF can hold up to 50 pages and feed each sheet individually.
- Use standard 80 g/m<sup>2</sup> paper.
- Make sure documents with correction fluid or written in ink are completely dry.

### IMPORTANT

- DO NOT leave thick documents on the scanner glass. If you do this, the ADF may jam.
- DO NOT use paper that is curled, wrinkled, folded, ripped, stapled, paper-clipped, pasted, or taped.
- DO NOT use cardboard, newspaper, or fabric.
- To avoid damaging your machine while using the ADF, DO NOT pull on the document while it is feeding.

### Document Sizes Supported

|         |                            |
|---------|----------------------------|
| Length: | 147.3 to 355.6 mm          |
| Width:  | 105 to 215.9 mm            |
| Weight: | 60 to 105 g/m <sup>2</sup> |

1. Unfold the ADF document output support flap.

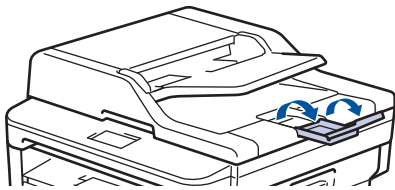

2. Fan the pages well.
3. Stagger the pages of your document and load it *face up* and *top edge first*, into the ADF as shown in the illustration.

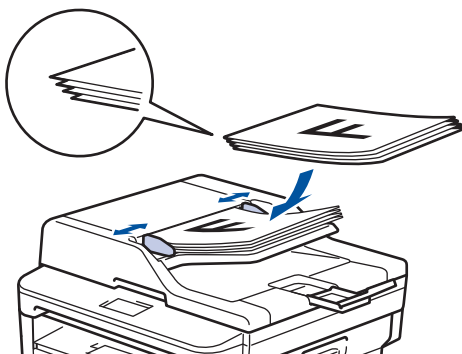

4. Adjust the paper guides to fit the width of your document.

### ✓ Related Information

- [Load Documents](#)

## Load Documents on the Scanner Glass

Use the scanner glass to fax, copy, or scan one page at a time.

### Document Sizes Supported

|         |                |
|---------|----------------|
| Length: | Up to 300 mm   |
| Width:  | Up to 215.9 mm |
| Weight: | Up to 2 kg     |



To use the scanner glass, the ADF must be empty.

1. Lift the document cover.
2. Place the document on the scanner glass *face down*.

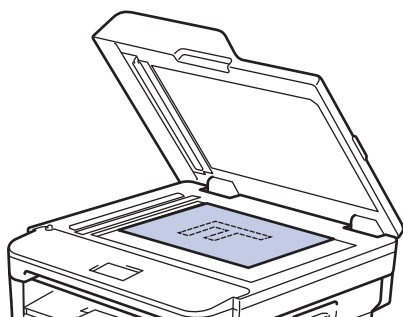

3. Place the corner of the page in the upper left corner of the scanner glass.

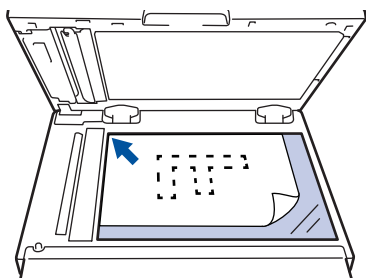

4. Close the document cover.  
If the document is a book or is thick, gently press on the document cover.



### Related Information

- [Load Documents](#)

## Unscannable and Unprintable Areas

The measurements in the table below show maximum unscannable and unprintable areas from the edges of the most commonly-used paper sizes. These measurements may vary depending on the paper size or settings in the application you are using.

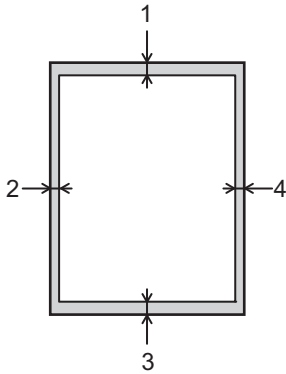

Do not attempt to scan, copy, or print into these areas; your output will not reflect anything in these areas.

| Usage             | Document Size | Top (1)<br>Bottom (3) | Left (2)<br>Right (4)                    |
|-------------------|---------------|-----------------------|--|
| Fax (Sending)     | Letter, Legal | 3 mm                  | 4 mm                                     |
|                   | A4            | 3 mm                  | (ADF)<br>1 mm<br>(Scanner Glass)<br>3 mm |
| Copy <sup>1</sup> | Letter, Legal | 3 mm                  | 4 mm                                     |
|                   | A4            | 3 mm                  | 3 mm                                     |
| Scan              | Letter        | 3 mm                  | 3 mm                                     |
|                   | A4            | 3 mm                  | 3 mm                                     |
|                   | Legal         | 3 mm                  | 3 mm                                     |
| Print             | Letter, Legal | 4.2 mm                | 4.2 mm                                   |
|                   | A4            | 4.2 mm                | 4.2 mm                                   |



### Related Information

- [Paper Handling](#)

<sup>1</sup> a 1 in 1 copy and 100% document size copy

## Using Special Paper

Always test paper samples before purchasing them to ensure desirable performance.

### WARNING

- Do not use conductive paper such as origami paper, carbonic paper or conductively-coated paper. When paper jam occurs, it may cause short-circuit and eventually a fire accident.

- DO NOT use inkjet paper; it may cause a paper jam or damage your machine.
- If you use bond paper, paper with a rough surface, or paper that is wrinkled or creased, the paper may exhibit degraded performance.

Store paper in its original packaging and keep it sealed. Keep the paper flat and away from moisture, direct sunlight and heat.

### IMPORTANT

Some types of paper may not perform well or may cause damage to your machine.

DO NOT use paper:

- that is highly textured
- that is extremely smooth or shiny
- that is curled or warped
- that is coated or has a chemical finish
- that is damaged, creased or folded
- that exceeds the recommended weight specification in this guide
- with tabs and staples
- with letterheads using low temperature dyes or thermography
- that is multipart or carbonless
- that is designed for inkjet printing

If you use any of the types of paper listed above, they may damage your machine. This damage is not covered under any Fuji Xerox warranty or service agreement.

### Related Information

- [Paper Handling](#)

## Print

- [Print from Your Computer \(Windows®\)](#)
- [Print from Your Computer \(Mac\)](#)
- [Cancel a Print Job](#)
- [Test Print](#)

## Print from Your Computer (Windows®)

- [Print a Document \(Windows®\)](#)
- [Print Settings \(Windows®\)](#)
- [Change the Default Print Settings \(Windows®\)](#)
- [Print a Document Using the PS3 emulate Printer Driver \(PostScript® 3™ Language Emulation\) \(Windows®\)](#)
- [Monitor the Status of the Machine from Your Computer \(Windows®\)](#)



## Print a Document (Windows®)

1. Select the print command in your application.
2. Select **FX DocuPrint XXXXX** (where XXXXX is the name of your model), and then click the printing properties or preferences button.

The printer driver window appears.

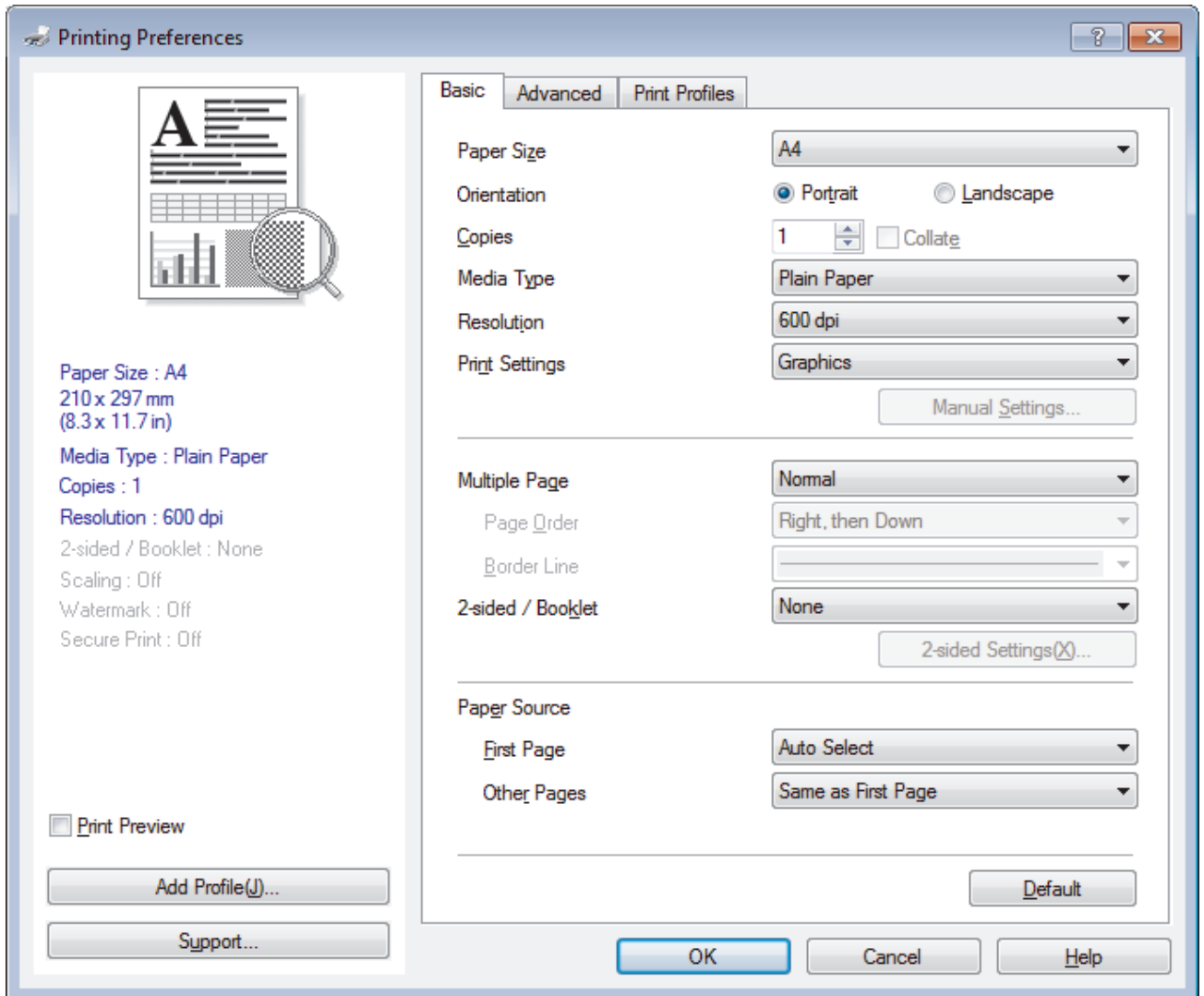

3. Make sure you have loaded the correct size paper in the paper tray.
4. Click the **Paper Size** drop-down list, and then select your paper size.
5. In the **Orientation** field, select the **Portrait** or **Landscape** option to set the orientation of your printout.



If your application contains a similar setting, we recommend that you set the orientation using the application.

6. Type the number of copies (1-999) you want in the **Copies** field.
7. Click the **Media Type** drop-down list, and then select the type of paper you are using.
8. To print multiple pages on a single sheet of paper or print one page of your document on multiple sheets, click the **Multiple Page** drop-down list, and then select your options.
9. Change other printer settings if needed.
10. Click **OK**.
11. Complete your print operation.



---

## Related Information

---

- [Print from Your Computer \(Windows®\)](#)
  - [Print Settings \(Windows®\)](#)
-

## Print Settings (Windows®)

### Basic Tab

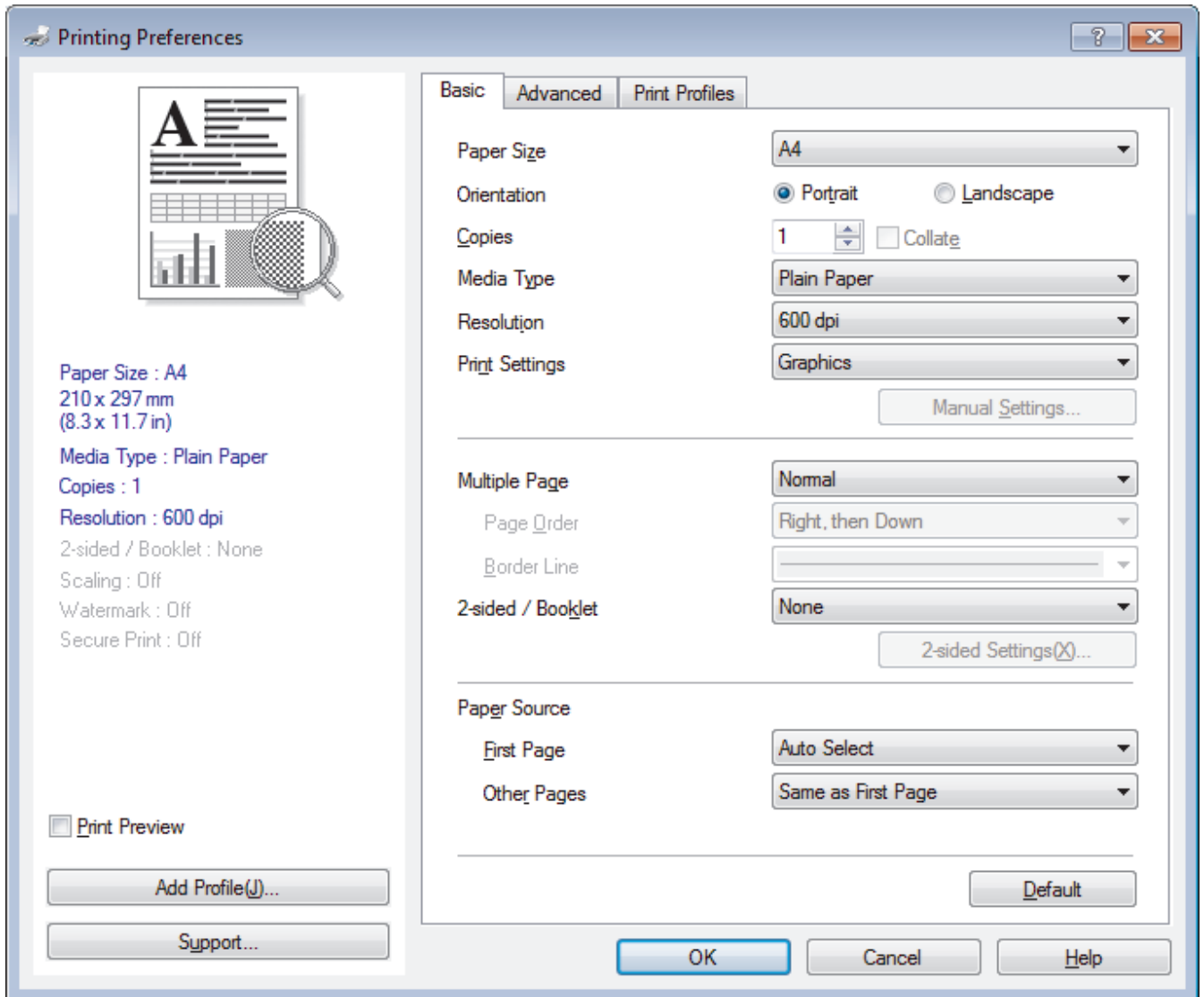

#### 1. Paper Size

Select the size of the paper you want to use. You can either choose from standard paper sizes or create a custom paper size.

#### 2. Orientation

Select the orientation (portrait or landscape) of your printout.

If your application contains a similar setting, we recommend that you set the orientation using the application.

#### 3. Copies

Type the number of copies (1-999) that you want to print in this field.

#### Collate

Select this option to print sets of multi-page documents in the original page order. When this option is selected, one complete copy of your document will print, and then reprint according to the number of copies you choose. If this option is not selected, then each page will print according to the number of copies chosen before the next page of the document is printed.

#### 4. Media Type

Select the type of media you want to use. To achieve the best print results, the machine automatically adjusts its print settings according to the selected media type.

---

## 5. Resolution

Select the print resolution. As print resolution and speed are related, the higher the resolution, the longer it will take to print the document.

## 6. Print Settings

Select the type of document you want to print.

### Manual Settings...

Specify advanced settings such as brightness, contrast, and other settings.

### Graphics

#### Use Printer Halftone

Select this option to use the printer driver to express halftones.

#### Brightness

Specify the brightness.

#### Contrast

Specify the contrast.

#### Graphics Quality

Select either Graphics or Text for the best print quality, based on the type of document you are printing.

#### Improve Grey Printing

Select this option to improve the image quality of shaded areas.

#### Improve Pattern Printing

Select this option to improve the pattern printing if printed fills and patterns are different from the fills and patterns you see on your computer screen.

#### Improve Thin Line

Select this option to improve the image quality of thin lines.

#### Use System Halftone

Select this option to use Windows® to express halftones.

### TrueType Mode (Available only for certain models)

#### Mode

Select how the fonts are processed for printing.

#### Use Printer TrueType Fonts

Select whether to use built-in fonts for the font processing.

## 7. Multiple Page

Select this option to print multiple pages on a single sheet of paper or print one page of your document on multiple sheets.

### Page Order

Select the page order when printing multiple pages on a single sheet of paper.

### Border Line

Select the type of border to use when printing multiple pages on a single sheet of paper.

## 8. 2-sided / Booklet

Select this option to print on both sides of the paper or print a document in booklet format using 2-sided printing.

### 2-sided Settings button

Click this button to select the type of 2-sided binding. Four types of 2-sided bindings are available for each orientation.

## 9. Paper Source

Select the paper source setting according to your print conditions or purpose.

### First Page

Select the paper source to use for printing the first page.

### Other Pages

Select the paper source to use for printing the second and subsequent pages.

## Advanced Tab

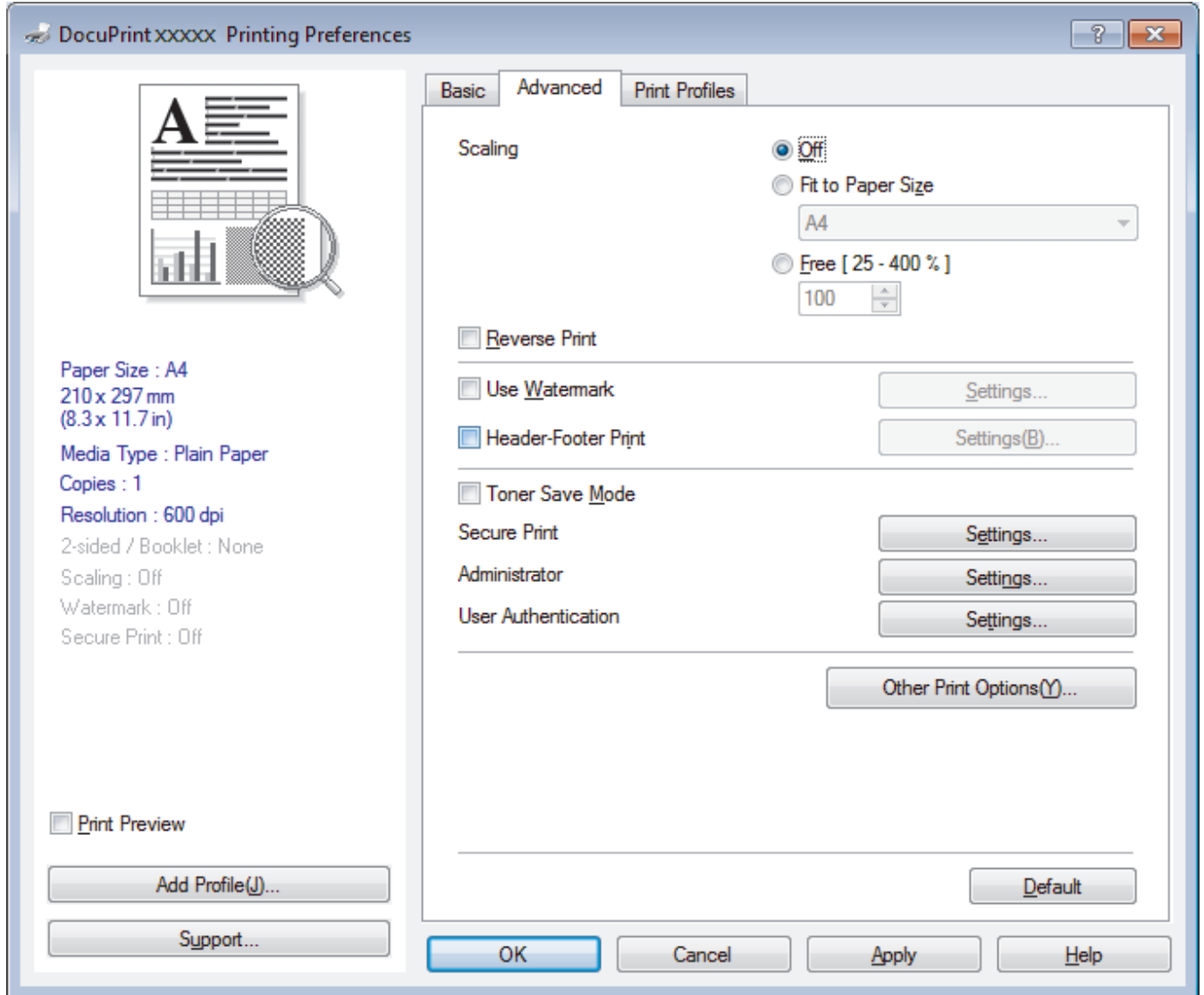

### 1. Scaling

Select these options to enlarge or reduce the size of the pages in your document.

#### Fit to Paper Size

Select this option to enlarge or reduce the document pages to fit a specified paper size. When you select this option, select the paper size you want from the drop-down list.

#### Free [25 - 400%]

Select this option to enlarge or reduce the document pages manually. When you select this option, type a value into the field.

### 2. Reverse Print

Select this option to rotate the printed image 180 degrees.

### 3. Use Watermark

Select this option to print a logo or text on your document as a watermark. Select one of the preset watermarks, add a new watermark, or use an image file you have created.

---

#### 4. Header-Footer Print

Select this option to print the date, time and PC login user name on the document.

#### 5. Toner Save Mode

Select this feature to conserve toner by using less toner to print documents; printouts appear lighter, but are still legible.

#### 6. Secure Print (Available only for certain models)

This feature ensures that confidential or sensitive documents do not print until you enter a password on the machine's control panel.

#### 7. Administrator

This feature allows you to change the administrator password and restrict various printing functions.

#### 8. User Authentication (Available only for certain models)

This feature allows you to confirm the restrictions for each user.

#### 9. Other Print Options button

##### Sleep Time

Select this option to set the machine to enter sleep mode immediately after printing.

##### Macro (Available only for certain models)

Select this feature to print an electronic form (macro), which you have stored in your machine's memory, as an overlay on the print job.

##### Density Adjustment

Specify the print density.

##### Improve Print Output

Select this option to reduce the amount of paper curling and improve the toner fixing.

##### Skip Blank Page

Select this option to allow the printer driver to automatically detect blank pages and exclude them from printing.

##### Print Text in Black

Select this option when you want to print colour text in black.

##### Print Archive

Select this option to save the print data as a PDF file to your computer.

##### Eco settings

Select this option to reduce printing noise.



#### Related Information

- [Print from Your Computer \(Windows®\)](#)
  - [Print a Document \(Windows®\)](#)
-

## Change the Default Print Settings (Windows®)

When you change an application's print settings, the changes only apply to documents printed with that application. To change print settings for all Windows® applications, you must configure the printer driver properties.

1. Do one of the following:

- For Windows Server® 2008

Click  (**Start**) > **Control Panel** > **Hardware and Sound** > **Printers**.

- For Windows® 7 and Windows Server® 2008 R2

Click  (**Start**) > **Devices and Printers**.

- For Windows® 8

Move your mouse to the lower right corner of your desktop. When the menu bar appears, click **Settings**, and then click **Control Panel**. In the **Hardware and Sound** group, click **View devices and printers**.

- For Windows® 10 and Windows Server® 2016

Click  > **Windows System** > **Control Panel**. In the **Hardware and Sound** group, click **View devices and printers**.

- For Windows Server® 2012

Move your mouse to the lower right corner of your desktop. When the menu bar appears, click **Settings**, and then click **Control Panel**. In the **Hardware** group, click **View devices and printers**.

- For Windows Server® 2012 R2

Click **Control Panel** on the **Start** screen. In the **Hardware** group, click **View devices and printers**.

2. Right-click the **FX DocuPrint XXXXX** icon (where XXXXX is your model name), and then select **Printer properties**. If printer driver options appear, select your printer driver.

3. Click the **General** tab, and then click the **Printing Preferences...** or **Preferences...** button.

The printer driver dialog box appears.



- To configure the tray settings, click the **Device Settings** tab (Available only for certain models).
- To change the printer port, click the **Ports** tab.

4. Select the print settings you want to use as defaults for all of your Windows® programs.

5. Click **OK**.

6. Close the printer properties dialog box.



### Related Information

- [Print from Your Computer \(Windows®\)](#)

## Print a Document Using the PS3 emulate Printer Driver (PostScript® 3™ Language Emulation) (Windows®)

The PS3 emulate printer driver lets you print PostScript® data more clearly.

To install the PS driver (PS3 emulate printer driver), launch the Fuji Xerox installation disc, select **Custom** in the Select Machine section, and then select the **PS Driver** check box.

1. Select the print command in your application.
2. Select **FX DocuPrint XXXXX PS3 emulate** (where XXXXX is the name of your model), and then click the printing properties or preferences button.

The printer driver window appears.

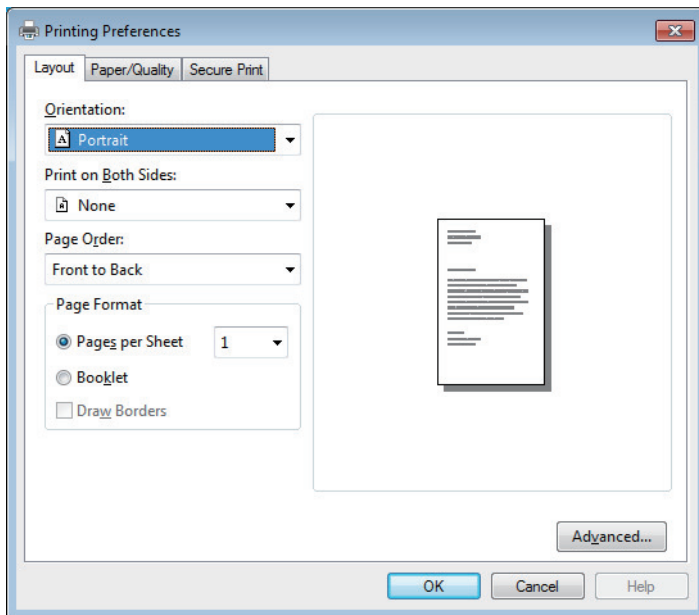

3. Click the **Layout**, **Paper/Quality**, or **Secure Print** tab to change basic print settings. (Available only for certain models)  
Click the **Layout** or **Paper/Quality** tab, and then click the **Advanced...** button to change advanced print settings.
4. Click **OK**.
5. Complete your print operation.

### ✓ Related Information

- [Print from Your Computer \(Windows®\)](#)



## Monitor the Status of the Machine from Your Computer (Windows®)

The Status Monitor utility is a configurable software tool for monitoring the status of one or more devices, allowing you to get immediate notification of errors.

- Do one of the following:

- Double-click the  icon in the task tray.

- (Windows® 7)



Click  (**Start**) > **All Programs** > **Fuji Xerox** > **Fuji Xerox Utilities**.

Click the drop-down list and select your model name (if not already selected). Click **Tools** in the left navigation bar, and then click **Status Monitor**.

- (Windows® 8)

Click  (**Fuji Xerox Utilities**), and then click the drop-down list and select your model name (if not already selected). Click **Tools** in the left navigation bar, and then click **Status Monitor**.

- (Windows® 8.1)

Move your mouse to the lower left corner of the **Start** screen and click  (if you are using a touch-based device, swipe up from bottom of the **Start** screen to bring up the **Apps** screen). When the **Apps** screen appears, tap or click  (**Fuji Xerox Utilities**), and then click the drop-down list and select your model name (if not already selected). Click **Tools** in the left navigation bar, and then click **Status Monitor**.

- (Windows® 10)

Click  > **Fuji Xerox** > **Fuji Xerox Utilities**.

Click the drop-down list and select your model name (if not already selected). Click **Tools** in the left navigation bar, and then click **Status Monitor**.



### Related Information

- [Print from Your Computer \(Windows®\)](#)
- [Printing Problems](#)

## **Print from Your Computer (Mac)**

- [Print a Document \(Mac\)](#)
- [Print Options \(Mac\)](#)
- [Monitor the Status of the Machine from Your Computer \(Mac\)](#)

## Print a Document (Mac)

1. Make sure you have loaded the correct size paper in the paper tray.
2. From an application, such as Apple TextEdit, click the **File** menu, and then select **Print**.
3. Select **FUJI XEROX DocuPrint XXXXX** (where XXXXX is your model name).



For more page setup options, click the **Show Details** button.

4. Type the number of copies you want in the **Copies** field.
5. Click the **Paper Size** pop-up menu, and then select your paper size.
6. Select the **Orientation** option that matches the way you want the document to print.
7. Click the application pop-up menu, and then select **Print Settings**.

The **Print Settings** options appear.

8. Click the **Media Type** pop-up menu, and then select the type of paper you are using.
9. Change other printer settings, if needed.
10. Click **Print**.





### Related Information

- [Print from Your Computer \(Mac\)](#)
- [Print Options \(Mac\)](#)



## Print Options (Mac)

### Page Setup

**Page Attributes** 

**Format For:**    
Fuji Xerox DocuPrint xxxxx CUPS

**Paper Size:**    
210 by 297 mm

**Orientation:**  

**Scale:**  %



#### 1. Paper Size

Select the size of the paper you want to use. You can either choose from standard paper sizes or create a custom paper size.

#### 2. Orientation

Select the orientation (portrait or landscape) of your printout.

If your application contains a similar setting, we recommend that you set the orientation using the application.

#### 3. Scale

Type a value into the field to enlarge or reduce the pages in your document to fit the selected paper size.

## Layout

Printer: FUJI XEROX DocuPrint XXXXX

Presets: Default Settings

Copies: 1  Two-Sided

Pages:  All  
 From: 1 to: 1

Paper Size: A4 210 by 297 mm

Orientation:  Portrait  Landscape

Layout: Layout

Pages per Sheet: 1

Layout Direction:  Z  S  U  N

Border: None

Two-Sided: Off

Reverse page orientation  
 Flip horizontally

? PDF Hide Details Cancel Print

### 1. Pages per Sheet

Select the number of pages to print on a single sheet of paper.

### 2. Layout Direction

Select the page order when printing multiple pages on a single sheet of paper.

### 3. Border

Select the type of border to use when printing multiple pages on a single sheet of paper.

### 4. Two-Sided

Select whether to print on both sides of the paper.

### 5. Reverse page orientation

Select this option to rotate the printed image 180 degrees.

### 6. Flip horizontally

Select this option to reverse the printed image on the page horizontally from left to right.

## Paper Handling

Printer: FUJI XEROX DocuPrint XXXXX

Presets: Default Settings

Copies: 1  Two-Sided

Pages:  All  
 From: 1 to: 1

Paper Size: A4 210 by 297 mm

Orientation:

Paper Handling

Collate pages

Pages to Print: All pages

Page Order: Automatic

Scale to fit paper size

Destination Paper Size: Suggested Paper: A4

Scale down only

? PDF Hide Details Cancel Print

### 1. Collate pages

Select this option to print sets of multi-page documents in the original page order. When this option is selected, one complete copy of your document will print, and then reprint according to the number of copies you choose. If this option is not selected, then each page will print according to the number of copies chosen before the next page of the document is printed.

### 2. Pages to Print

Select which pages you want to print (even pages or odd pages).

### 3. Page Order

Select the page order.

### 4. Scale to fit paper size

Select this option to enlarge or reduce the pages in your document to fit the selected paper size.

### 5. Destination Paper Size

Select the paper size to print on.

### 6. Scale down only

Select this option if you want to reduce the pages in your document when they are too large for the selected paper size. If this option is selected and the document is formatted for a paper size that is smaller than the paper size you are using, the document will be printed at its original size.

## Print Settings



Printer: FUJI XEROX DocuPrint XXXXX

Presets: Default Settings

Copies: 1  Two-Sided

Pages:  All  
 From: 1 to: 1

Paper Size: A4 210 by 297 mm

Orientation:  

Print Settings

Media Type: Plain Paper

Print Quality: 600 dpi

Paper Source: Auto Select

1 of 1

Advanced

? PDF Hide Details Cancel Print

### 1. Media Type

Select the type of media you want to use. To achieve the best print results, the machine automatically adjusts its print settings according to the selected media type.

### 2. Print Quality

Select the print resolution you want. Because print quality and speed are related, the higher the quality, the longer it will take to print the document.

### 3. Paper Source

Select the paper source setting according to your print conditions or purpose.

### 4. Advanced

#### Toner Save Mode

Select this feature to conserve toner by using less toner to print documents; printouts appear lighter, but are still legible.

#### Graphics Quality

Select either Graphics or Text for the best print quality, based on the type of document you are printing.

#### Improve Print Output

Select this option to reduce the amount of paper curling and improve the toner fixing.

#### Density Adjustment

Specify the print density.

#### Quiet Mode

Select this option to reduce printing noise.

#### Other Print Options

##### Skip Blank Page

Select this option to allow the printer driver to automatically detect blank pages and exclude them from printing.

## Secure Print

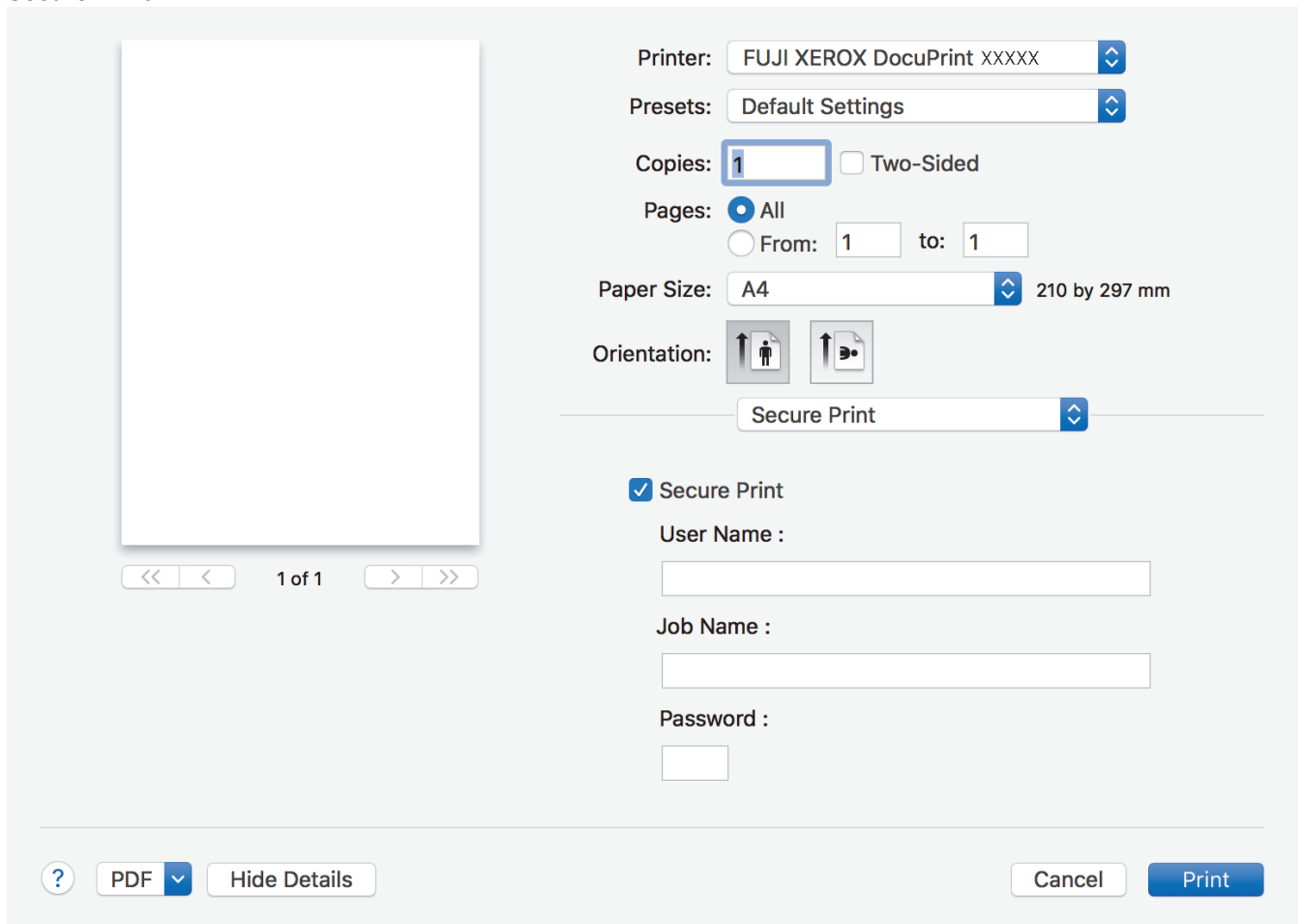



Printer: FUJI XEROX DocuPrint xxxxx

Presets: Default Settings

Copies: 1  Two-Sided

Pages:  All  
 From: 1 to: 1

Paper Size: A4 210 by 297 mm

Orientation:  

Secure Print

Secure Print

User Name :

Job Name :

Password :

1 of 1

PDF Hide Details

Cancel Print

### 1. Secure Print (Available only for certain models)

This feature ensures that confidential or sensitive documents do not print until you enter a password on the machine's control panel.

#### Related Information

- [Print from Your Computer \(Mac\)](#)
- [Print a Document \(Mac\)](#)



## Monitor the Status of the Machine from Your Computer (Mac)

The Status Monitor utility is a configurable software tool for monitoring the status of a device, allowing you to get immediate notification of error messages, such as paper empty or paper jam, at preset update intervals. You can also access Web Based Management.

1. Click the **System Preferences** menu, select **Print & Scan** or **Printers & Scanners**, and then select your machine.
2. Click the **Options & Supplies** button.
3. Click the **Utility** tab, and then click the **Open Printer Utility** button.

Status Monitor starts.

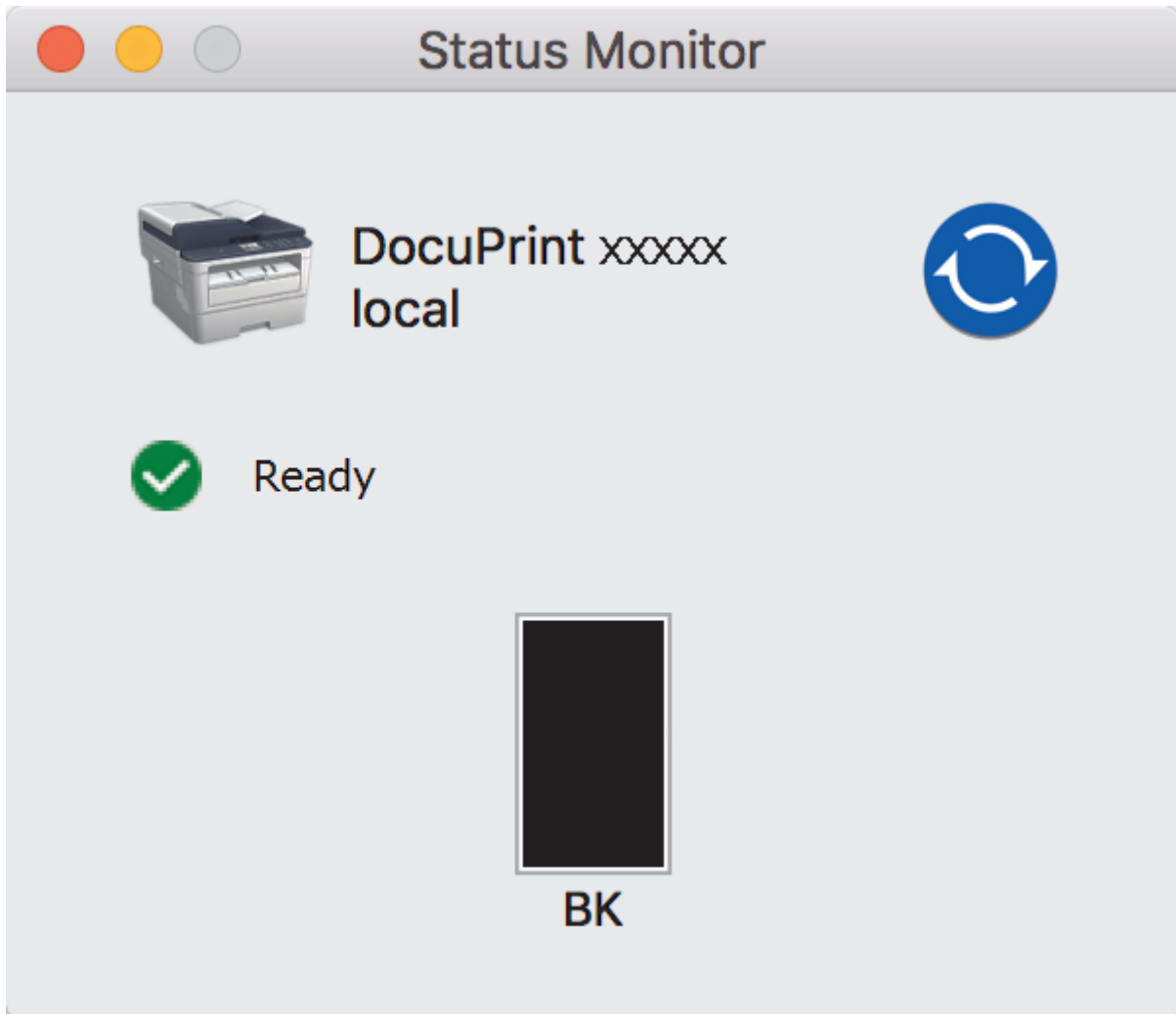

### Updating the machine's status

To view the latest machine status while the **Status Monitor** window is open, click the  icon. You can set the interval at which the software updates machine status information. Click **Status Monitor** in the menu bar, and then select **Preferences**.

### Web Based Management (Network Connection Only)

Access the Web Based Management System by clicking the machine icon on the **Status Monitor** screen. You can use a standard Web Browser to manage your machine using HTTP (Hyper Text Transfer Protocol).

### ✓ Related Information

- [Print from Your Computer \(Mac\)](#)



## Cancel a Print Job

>> [DocuPrint M235 dw/DocuPrint M235 z](#)  
>> [DocuPrint M275 z/DocuPrint M285 z](#)

### DocuPrint M235 dw/DocuPrint M235 z

1. Press **Stop/Exit**.



To cancel multiple print jobs, press and hold **Stop/Exit** for four seconds.

### DocuPrint M275 z/DocuPrint M285 z

1. Press .



To cancel multiple print jobs, press and hold  for about four seconds.

### Related Information

- [Print](#)
- [Printing Problems](#)

## Test Print

If there are problems with print quality, follow these instructions to do a test print:



>> [DocuPrint M235 dw/DocuPrint M235 z](#)

>> [DocuPrint M275 z/DocuPrint M285 z](#)

### DocuPrint M235 dw/DocuPrint M235 z

1. Press **Menu**.
2. Press **▲** or **▼** to display the [Printer] option, and then press **OK**.
3. Press **▲** or **▼** to display the [Print Options] option, and then press **OK**.
4. Press **▲** or **▼** to display the [Test Print] option, and then press **OK**.
5. Press **Start**.  
The machine prints a Test Print page.
6. Press **Stop/Exit**.

### DocuPrint M275 z/DocuPrint M285 z

1. Press  [Settings] > [All Settings] > [Printer] > [Print Options] > [Test Print].
2. Press [Yes].
3. Press .

### Related Information

- [Print](#)
- [Improve the Print Quality](#)

## Scan

- [Scan Using the Scan Button on Your Fuji Xerox Machine](#)
- [Scan from Your Computer \(Windows®\)](#)
- [Scan from Your Computer \(Mac\)](#)
- [Configure Scan Settings Using Web Based Management](#)

## Scan Using the Scan Button on Your Fuji Xerox Machine

- [Scan Photos and Graphics](#)
- [Save Scanned Data to a Folder as a PDF File](#)
- [Scan to an Editable Text File \(OCR\)](#)
- [Scan to Email Attachment](#)
- [Scan to FTP](#)
- [Scan to Network \(Windows®\)](#)
- [Web Services for Scanning on Your Network \(Windows® 7, Windows® 8 and Windows® 10\)](#)
- [Change Scan Button Settings from ControlCenter4 \(Windows®\)](#)
- [Change Scan Button Settings from iPrint&Scan \(Mac\)](#)
- [Configure Certificate for Signed PDF](#)
- [Disable Scanning from Your Computer](#)

## Scan Photos and Graphics

Send scanned photos or graphics directly to your computer.

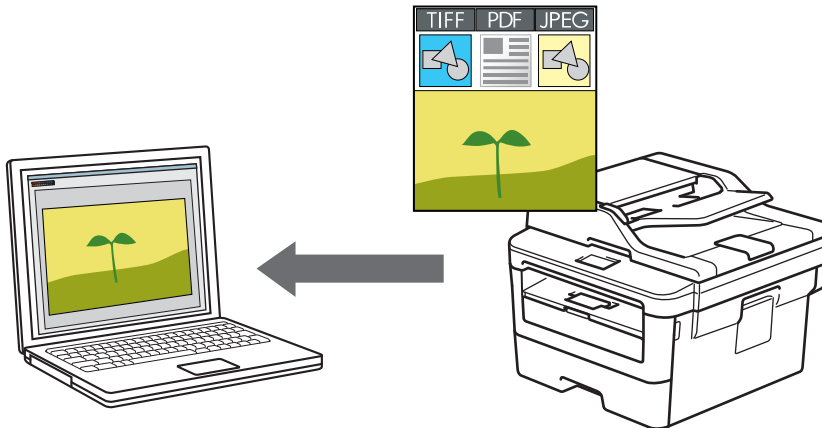

Use the Scan button on the machine to make temporary changes to the scan settings. To make permanent changes, use Fuji Xerox's ControlCenter software (Windows®) or iPrint&Scan (Mac).

>> [DocuPrint M235 dw/DocuPrint M235 z](#)  
>> [DocuPrint M275 z/DocuPrint M285 z](#)

### DocuPrint M235 dw/DocuPrint M235 z

1. Load your document.
2. Press  (**Scan**).
3. Press ▲ or ▼ to select the [Scan to PC] option, and then press **OK**.
4. Press ▲ or ▼ to select the [Image] option, and then press **OK**.
5. If the machine is connected over the network, press ▲ or ▼ to select the destination computer.
6. Press **OK**.



If the LCD prompts you to enter a PIN, enter the four digit PIN for the destination computer on the LCD and then press **OK**.

7. Do one of the following:
  - To change the scan settings for this document, press **Options** or **Copy/Scan Options** and then go to the next step.
  - To use the default scan settings, press **Start**.

The machine starts scanning. If you are using the machine's scanner glass, follow the LCD instructions to complete the scanning job.



In order to change scan settings, Fuji Xerox's ControlCenter software must be installed on a computer connected to the machine.

8. Select the scan settings you want to change:
  - [Scan Type]
  - [Resolution]
  - [File Type]
  - [Document Size]
  - [ADF Auto Des skew] (available for certain models)
  - [Remove Bkg Clr]

(available only for the [Colour] and [Grey] options.)

9. Press **OK**.
10. Press **Start**.

The machine starts scanning. If using the machine's scanner glass, follow the LCD instructions to complete the scanning job.

## DocuPrint M275 z/DocuPrint M285 z

1. Load your document.
2. Press [Scan] > [to PC] > [to Image].
3. If the machine is connected over the network, press ▲ or ▼ to display the computer where you want to send data, and then press the computer name.



If the LCD prompts you to enter a PIN for the computer, enter the four-digit PIN on the LCD and then press [OK].

4. Do one of the following:
  - To change the scan settings, press [Options], and then go to the next step.
  - To use the default scan settings, press [Start].

The machine starts scanning. If using the machine's scanner glass, follow the LCD instructions to complete the scanning job.



In order to change scan settings, Fuji Xerox's ControlCenter software must be installed on a computer connected to the machine.

5. To scan both sides of the document (DocuPrint M275 z/DocuPrint M285 z):
  - Press [2-sided Scan], and then select the document type.

| Option                   | Description |
|--------------------------|-------------|
| 2-sided Scan: Long Edge  |             |
| 2-sided Scan: Short Edge |             |

6. Select the scan settings you want to change:
  - [Resolution]
  - [File Type]
  - [Scan Type]
  - [Document Size]
  - [Scan Settings]
  - [ADF Auto Deskew] (available for certain models)
  - [Remove Background Colour]



---

(available only for the [Colour] and [Grey] options.)

7. Press [OK].

8. Press [Start].

The machine starts scanning. If using the machine's scanner glass, follow the LCD instructions to complete the scanning job.



### Related Information

- [Scan Using the Scan Button on Your Fuji Xerox Machine](#)
  - [Change Scan Button Settings from ControlCenter4 \(Windows®\)](#)
  - [Change Scan Button Settings from iPrint&Scan \(Mac\)](#)
-

## Save Scanned Data to a Folder as a PDF File

Scan documents and save them to a folder on your computer as PDF files.

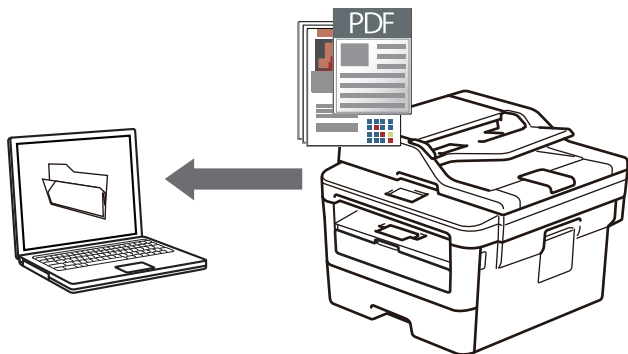

Use the Scan button on the machine to make temporary changes to the scan settings. To make permanent changes, use Fuji Xerox's ControlCenter software (Windows®) or iPrint&Scan (Mac).

>> [DocuPrint M235 dw/DocuPrint M235 z](#)

>> [DocuPrint M275 z/DocuPrint M285 z](#)

### DocuPrint M235 dw/DocuPrint M235 z

1. Load your document.
2. Press  (**Scan**).
3. Press **▲** or **▼** to select the [Scan to PC] option, and then press **OK**.
4. Press **▲** or **▼** to select the [File] option, and then press **OK**.
5. If the machine is connected over the network, press **▲** or **▼** to select the destination computer.
6. Press **OK**.



If the LCD prompts you to enter a PIN, enter the four digit PIN for the destination computer on the LCD and then press **OK**.

7. Do one of the following:
  - To change the scan settings for this document, press **Options** or **Copy/Scan Options** and then go to the next step.
  - To use the default scan settings, press **Start**.The machine starts scanning. If you are using the machine's scanner glass, follow the LCD instructions to complete the scanning job.



- In order to change scan settings, Fuji Xerox's ControlCenter software must be installed on a computer connected to the machine.

8. Select the scan settings you want to change:
  - [Scan Type]
  - [Resolution]
  - [File Type]
  - [Document Size]
  - [ADF Auto Deskew] (available for certain models)
  - [Remove Bkg Clr]  
(available only for the [Colour] and [Grey] options.)
9. Press **OK**.

10. Press **Start**.

The machine starts scanning. If using the machine's scanner glass, follow the LCD instructions to complete the scanning job.

## DocuPrint M275 z/DocuPrint M285 z

1. Load your document.
2. Press [Scan] > [to PC] > [to File].
3. If the machine is connected over the network, press ▲ or ▼ to display the computer where you want to send data, and then press the computer name.



If the LCD prompts you to enter a PIN for the computer, enter the four-digit PIN on the LCD and then press [OK].

4. Do one of the following:
  - To change the scan settings, press [Options], and then go to the next step.
  - To use the default scan settings, press [Start].

The machine starts scanning. If using the machine's scanner glass, follow the LCD instructions to complete the scanning job.



In order to change scan settings, Fuji Xerox's ControlCenter software must be installed on a computer connected to the machine.

5. To scan both sides of the document (DocuPrint M275 z/DocuPrint M285 z):
  - Press [2-sided Scan], and then select the document type.

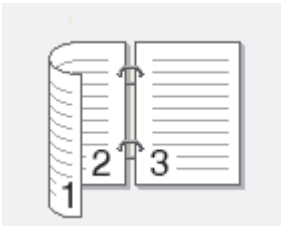
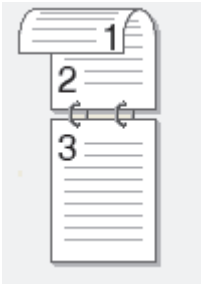
| Option                   | Description   |
|--------------------------|---|
| 2-sided Scan: Long Edge  |  |
| 2-sided Scan: Short Edge |  |

6. Select the scan settings you want to change:
  - [Resolution]
  - [File Type]
  - [Scan Type]
  - [Document Size]
  - [Scan Settings]
  - [ADF Auto Des skew] (available for certain models)
  - [Remove Background Colour] (available only for the [Colour] and [Grey] options.)
7. Press [OK].

---

8. Press [Start].

The machine starts scanning. If using the machine's scanner glass, follow the LCD instructions to complete the scanning job.



### **Related Information**

- [Scan Using the Scan Button on Your Fuji Xerox Machine](#)
  - [Change Scan Button Settings from ControlCenter4 \(Windows®\)](#)
  - [Change Scan Button Settings from iPrint&Scan \(Mac\)](#)
-

## Scan to an Editable Text File (OCR)

Your machine can convert characters in a scanned document to text using optical character recognition (OCR) technology. You can edit this text using your preferred text-editing application.

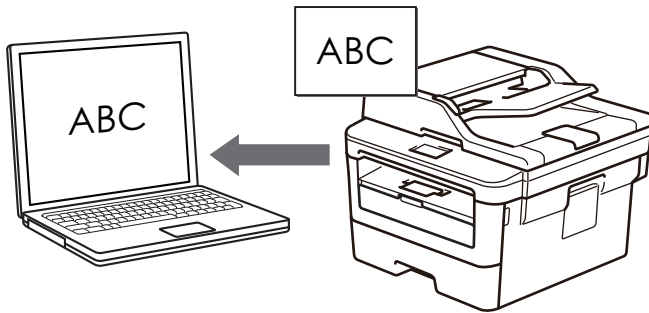

- The Scan to OCR feature is available for certain languages.
- Use the Scan button on the machine to make temporary changes to the scan settings. To make permanent changes, use Fuji Xerox's ControlCenter software.

>> [DocuPrint M235 dw/DocuPrint M235 z](#)

>> [DocuPrint M275 z/DocuPrint M285 z](#)

### DocuPrint M235 dw/DocuPrint M235 z

1. Load your document.
2. Press  (**Scan**).
3. Press **▲** or **▼** to select the [Scan to PC] option, and then press **OK**.
4. Press **▲** or **▼** to select the [OCR] option, and then press **OK**.
5. If the machine is connected over the network, press **▲** or **▼** to select the destination computer.
6. Press **OK**.



If the LCD prompts you to enter a PIN, enter the four digit PIN for the destination computer on the LCD and then press **OK**.

7. Do one of the following:
  - To change the scan settings for this document, press **Options** or **Copy/Scan Options** and then go to the next step.
  - To use the default scan settings, press **Start**.The machine starts scanning. If you are using the machine's scanner glass, follow the LCD instructions to complete the scanning job.



In order to change scan settings, Fuji Xerox's ControlCenter software must be installed on a computer connected to the machine.

8. Select the scan settings you want to change:
  - [Scan Type]
  - [Resolution]
  - [File Type]
  - [Document Size]
  - [ADF Auto Des skew] (available for certain models)
  - [Remove Bkg Clr]  
(available only for the [Colour] and [Grey] options.)

9. Press **OK**.
10. Press **Start**.

The machine scans the document, converts it to editable text, and then sends it to your default word processing application.

## DocuPrint M275 z/DocuPrint M285 z

1. Load your document.
2. Press [Scan] > [to PC] > [to OCR].
3. If the machine is connected over the network, press ▲ or ▼ to display the computer where you want to send data, and then press the computer name.



If the LCD prompts you to enter a PIN for the computer, enter the four-digit PIN on the LCD and then press [OK].

4. Do one of the following:
  - To change the scan settings, press [Options], and then go to the next step.
  - To use the default scan settings, press [Start].

The machine starts scanning. If using the machine's scanner glass, follow the LCD instructions to complete the scanning job.



In order to change scan settings, Fuji Xerox's ControlCenter software must be installed on a computer connected to the machine.

5. To scan both sides of the document (DocuPrint M275 z/DocuPrint M285 z):
  - Press [2-sided Scan], and then select the document type.

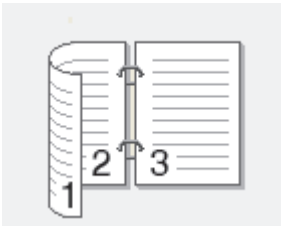
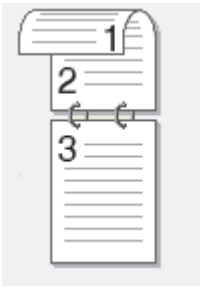
| Option                   | Description   |
|--------------------------|---|
| 2-sided Scan: Long Edge  |  |
| 2-sided Scan: Short Edge |  |

6. Select the scan settings you want to change:
  - [Resolution]
  - [File Type]
  - [Scan Type]
  - [Document Size]
  - [Scan Settings]
  - [ADF Auto Des skew] (available for certain models)
  - [Remove Background Colour] (available only for the [Colour] and [Grey] options.)

---

7. Press [OK].

8. Press [Start].

The machine starts scanning. If using the machine's scanner glass, follow the LCD instructions to complete the scanning job.



### Related Information

- [Scan Using the Scan Button on Your Fuji Xerox Machine](#)
  - [Change Scan Button Settings from ControlCenter4 \(Windows®\)](#)
  - [Change Scan Button Settings from iPrint&Scan \(Mac\)](#)
-

## Scan to Email Attachment

Send a scanned document as an email attachment.

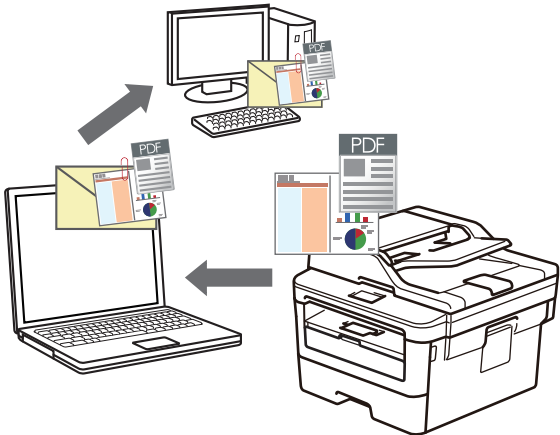

- Use the Scan button on the machine to make temporary changes to the scan settings. To make permanent changes, use Fuji Xerox's ControlCenter software (Windows®) or iPrint&Scan (Mac).
- The Scan to Email feature does not support Webmail services. Use the Scan to Image or Scan to File feature to scan a document or a picture, and then attach the scanned file to an email message.



The machine scans to your default email client.

>> [DocuPrint M235 dw/DocuPrint M235 z](#)

>> [DocuPrint M275 z/DocuPrint M285 z](#)

### DocuPrint M235 dw/DocuPrint M235 z

1. Load your document.
2. Press  (**Scan**).
3. Press ▲ or ▼ to select the [Scan to PC] option, and then press **OK**.
4. Press ▲ or ▼ to select the [E-mail] option, and then press **OK**.
5. If the machine is connected over the network, press ▲ or ▼ to select the destination computer.
6. Press **OK**.



If the LCD prompts you to enter a PIN, enter the four digit PIN for the destination computer on the LCD and then press **OK**.

7. Do one of the following:
  - To change the scan settings for this document, press **Options** or **Copy/Scan Options** and then go to the next step.
  - To use the default scan settings, press **Start**.The machine starts scanning. If you are using the machine's scanner glass, follow the LCD instructions to complete the scanning job.



In order to change scan settings, Fuji Xerox's ControlCenter software must be installed on a computer connected to the machine.

8. Select the scan settings you want to change:
  - [Scan Type]
  - [Resolution]
  - [File Type]



- [Document Size]
- [ADF Auto Deskew] (available for certain models)
- [Remove Bkg Clr]  
(available only for the [Colour] and [Grey] options.)

9. Press **OK**.

10. Press **Start**.

The machine scans the document and saves it as a file attachment. It then launches your email application and opens a new, blank email message with the scanned file attached.

## DocuPrint M275 z/DocuPrint M285 z

1. Load your document.
2. Press [Scan] > [to PC] > [to E-mail].
3. If the machine is connected over the network, press ▲ or ▼ to display the computer where you want to send data, and then press the computer name.



If the LCD prompts you to enter a PIN for the computer, enter the four-digit PIN on the LCD and then press [OK].

4. Do one of the following:

- To change the scan settings, press [Options], and then go to the next step.
- To use the default scan settings, press [Start].

The machine starts scanning. If using the machine's scanner glass, follow the LCD instructions to complete the scanning job.



In order to change scan settings, Fuji Xerox's ControlCenter software must be installed on a computer connected to the machine.

5. To scan both sides of the document (DocuPrint M275 z/DocuPrint M285 z):

- Press [2-sided Scan], and then select the document type.

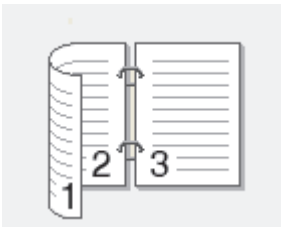
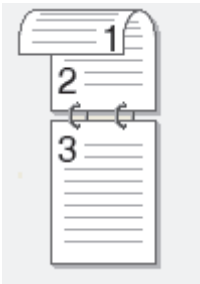
| Option                   | Description   |
|--------------------------|---|
| 2-sided Scan: Long Edge  |  |
| 2-sided Scan: Short Edge |  |

6. Select the scan settings you want to change:

- [Resolution]
- [File Type]
- [Scan Type]
- [Document Size]

- 
- [Scan Settings]
  - [ADF Auto Deskew] (available for certain models)
  - [Remove Background Colour]  
(available only for the [Colour] and [Grey] options.)

7. Press [OK].

8. Press [Start].

The machine starts scanning. If using the machine's scanner glass, follow the LCD instructions to complete the scanning job.



### Related Information

- [Scan Using the Scan Button on Your Fuji Xerox Machine](#)
  - [Change Scan Button Settings from ControlCenter4 \(Windows®\)](#)
  - [Change Scan Button Settings from iPrint&Scan \(Mac\)](#)
-

## Scan to FTP

Scan documents directly to an FTP server when you need to share the scanned information. For added convenience, configure different profiles to save your favourite Scan to FTP destinations.

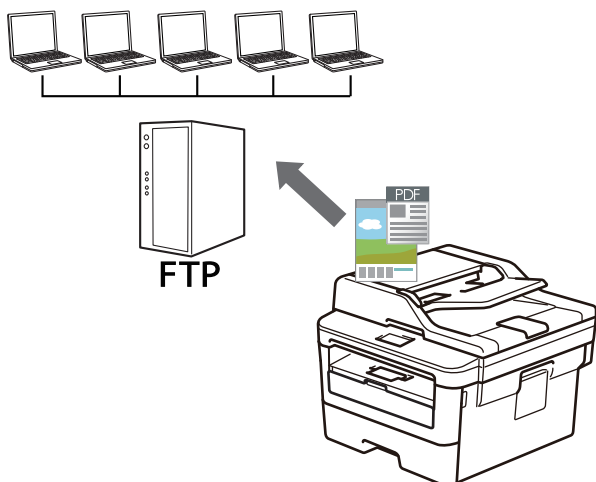

- [Set up a Scan to FTP Profile](#)
- [Upload Scanned Data to an FTP Server](#)

## Set up a Scan to FTP Profile

Set up a Scan to FTP Profile to scan and upload the scanned data directly to an FTP location.

We recommend Microsoft® Internet Explorer® 11/Edge for Windows® and Safari 9/10/11 for Mac. Make sure that JavaScript and Cookies are always enabled in whichever browser you use.

1. Start your web browser.

Type "http://machine's IP address" in your browser's address bar (where "machine's IP address" is the IP address of the machine or the print server name). For example: http://192.168.1.2

No password is required by default. If you have previously set a password, type it, and then click .

2. Click the **Scan** tab.
3. Click the **Scan to FTP/Network** menu in the left navigation bar.
4. Select the **FTP** option, and then click **Submit**.

## Scan to FTP/Network

- |            |  |
|------------|--|
| Profile 1  | <input checked="" type="radio"/> FTP <input type="radio"/> Network |
| Profile 2  | <input checked="" type="radio"/> FTP <input type="radio"/> Network |
| Profile 3  | <input checked="" type="radio"/> FTP <input type="radio"/> Network |
| Profile 4  | <input checked="" type="radio"/> FTP <input type="radio"/> Network |
| Profile 5  | <input checked="" type="radio"/> FTP <input type="radio"/> Network |
| Profile 6  | <input checked="" type="radio"/> FTP <input type="radio"/> Network |
| Profile 7  | <input checked="" type="radio"/> FTP <input type="radio"/> Network |
| Profile 8  | <input checked="" type="radio"/> FTP <input type="radio"/> Network |
| Profile 9  | <input checked="" type="radio"/> FTP <input type="radio"/> Network |
| Profile 10 | <input checked="" type="radio"/> FTP <input type="radio"/> Network |
| Profile 11 | <input checked="" type="radio"/> FTP <input type="radio"/> Network |
| Profile 12 | <input checked="" type="radio"/> FTP <input type="radio"/> Network |
| Profile 13 | <input checked="" type="radio"/> FTP <input type="radio"/> Network |
| Profile 14 | <input checked="" type="radio"/> FTP <input type="radio"/> Network |
| Profile 15 | <input checked="" type="radio"/> FTP <input type="radio"/> Network |
| Profile 16 | <input checked="" type="radio"/> FTP <input type="radio"/> Network |
| Profile 17 | <input checked="" type="radio"/> FTP <input type="radio"/> Network |
| Profile 18 | <input checked="" type="radio"/> FTP <input type="radio"/> Network |
| Profile 19 | <input checked="" type="radio"/> FTP <input type="radio"/> Network |
| Profile 20 | <input checked="" type="radio"/> FTP <input type="radio"/> Network |
| Profile 21 | <input checked="" type="radio"/> FTP <input type="radio"/> Network |
| Profile 22 | <input checked="" type="radio"/> FTP <input type="radio"/> Network |
| Profile 23 | <input checked="" type="radio"/> FTP <input type="radio"/> Network |
| Profile 24 | <input checked="" type="radio"/> FTP <input type="radio"/> Network |
| Profile 25 | <input checked="" type="radio"/> FTP <input type="radio"/> Network |

- Click the **Scan to FTP/Network Profile** menu in the left navigation bar.
- Select the profile you want to set up or change.
- In the **Profile Name** field, type a name for this server profile (up to 15 alphanumeric characters). The machine will display this name on the LCD.
- In the **Host Address** field, type the Host Address (for example: ftp.example.com; up to 64 characters) or the IP address (for example: 192.23.56.189).
- Change the **Port Number** setting used to access the FTP server. The default for this setting is port 21. In most cases this setting does not need to be changed.
- In the **Username** field, type a user name (up to 32 characters) that has permission to write data to the FTP server.
- In the **Password** field, type the password (up to 32 characters) associated with the user name you entered in the **Username** field. Type the password again in the **Retype password** field.
- In the **Store Directory** field, type the path to the folder on the FTP server where you want to send your scanned data. Do not type a slash mark at the beginning of the path (see example).

**Store Directory**

fujixerox/abc

- 
13. Click the **File Name** drop-down list, and then select a file name prefix from the preset names provided, or from user-defined names. The file name used for the scanned document will be the file name prefix you select, followed by the last six digits of the flatbed/ADF scanner counter and the file extension (for example: "Estimate\_098765.pdf").
  14. Click the **Quality** drop-down list, and then select a quality setting. If you choose the **User Select** option, the machine will prompt users to select a setting each time they use the scan profile.
  15. Click the **File Type** drop-down list, and then select the file type you want to use for the scanned document. If you choose the **User Select** option, the machine will prompt users to select a setting each time they use the scan profile.
  16. Click the **Document Size** drop-down list, and then select your document size from the list. This is necessary to make sure the scanned file is the correct size.
  17. Click the **File Size** drop-down list, and then select your file size from the list.
  18. Click the **Remove Background Colour** drop-down list, and then select the level from the list. You can use this feature to remove the background colour of documents to make the scanned data more legible.
  19. Set the **Passive Mode** option to off or on depending on your FTP server and network firewall configuration. The default setting is on. In most cases this setting does not need to be changed.
  20. Click **Submit**.



---

Using the following characters: ?, /, \, ", :, <, >, | or \* may cause a sending error.

---



## Related Information

- [Scan to FTP](#)
-

## Upload Scanned Data to an FTP Server

Share scanned information by saving it to your FTP server.

>> [DocuPrint M235 dw/DocuPrint M235 z](#)

>> [DocuPrint M275 z/DocuPrint M285 z](#)

### DocuPrint M235 dw/DocuPrint M235 z

1. Load your document.
2. Press  (**Scan**).
3. Press **▲** or **▼** to select the [Scan to FTP] option, and then press **OK**.
4. Press **▲** or **▼** to select one of the profiles listed, and then press **OK**.

If the profile is not complete (for example, if the logon account name and password are missing or if the quality or file type is not specified), you will be prompted to enter any missing information.

5. Press **Start**.

The LCD shows the message [Connecting]. When the connection to the FTP server is successful, the machine starts scanning. If you are using the machine's scanner glass, follow the LCD instructions to complete the scanning job.

### DocuPrint M275 z/DocuPrint M285 z

1. Load your document.
2. Press [Scan] > [to FTP].
3. Press **▲** or **▼** to select one of the network server profiles listed. If the profile is not complete (for example, if the logon account name and password are missing, or if the quality or file type is not specified), you will be prompted to enter any missing information.
4. Press [Start].

The machine starts scanning. If using the machine's scanner glass, follow the LCD instructions to complete the scanning job.



### Related Information

- [Scan to FTP](#)

## Scan to Network (Windows®)

Scan documents directly to a CIFS server on your local network. For added convenience, you can configure different profiles to save your favourite Scan to Network destinations.

- [Set up a Scan to Network Profile](#)
- [Upload Scanned Data to a CIFS Server](#)



## Set up a Scan to Network Profile

**Related Models:** DocuPrint M275 z/DocuPrint M285 z

Set up a Scan to Network Profile to scan and upload scanned data directly to a folder on a CIFS server.

We recommend Microsoft® Internet Explorer® 11/Edge for Windows® and Safari 9/10/11 for Mac. Make sure that JavaScript and Cookies are always enabled in whichever browser you use.

1. Start your web browser.

Type "http://machine's IP address" in your browser's address bar (where "machine's IP address" is the IP address of the machine or the print server name). For example: http://192.168.1.2

No password is required by default. If you have previously set a password, type it, and then click .

2. Click the **Scan** tab.
3. Click the **Scan to FTP/Network** menu in the left navigation bar.
4. Select the **Network** option, and then click **Submit**.

## Scan to FTP/Network

|            |  |
|------------|--|
| Profile 1  | <input type="radio"/> FTP <input checked="" type="radio"/> Network |
| Profile 2  | <input type="radio"/> FTP <input checked="" type="radio"/> Network |
| Profile 3  | <input type="radio"/> FTP <input checked="" type="radio"/> Network |
| Profile 4  | <input type="radio"/> FTP <input checked="" type="radio"/> Network |
| Profile 5  | <input type="radio"/> FTP <input checked="" type="radio"/> Network |
| Profile 6  | <input type="radio"/> FTP <input checked="" type="radio"/> Network |
| Profile 7  | <input type="radio"/> FTP <input checked="" type="radio"/> Network |
| Profile 8  | <input type="radio"/> FTP <input checked="" type="radio"/> Network |
| Profile 9  | <input type="radio"/> FTP <input checked="" type="radio"/> Network |
| Profile 10 | <input type="radio"/> FTP <input checked="" type="radio"/> Network |
| Profile 11 | <input type="radio"/> FTP <input checked="" type="radio"/> Network |
| Profile 12 | <input type="radio"/> FTP <input checked="" type="radio"/> Network |
| Profile 13 | <input type="radio"/> FTP <input checked="" type="radio"/> Network |
| Profile 14 | <input type="radio"/> FTP <input checked="" type="radio"/> Network |
| Profile 15 | <input type="radio"/> FTP <input checked="" type="radio"/> Network |
| Profile 16 | <input type="radio"/> FTP <input checked="" type="radio"/> Network |
| Profile 17 | <input type="radio"/> FTP <input checked="" type="radio"/> Network |
| Profile 18 | <input type="radio"/> FTP <input checked="" type="radio"/> Network |
| Profile 19 | <input type="radio"/> FTP <input checked="" type="radio"/> Network |
| Profile 20 | <input type="radio"/> FTP <input checked="" type="radio"/> Network |
| Profile 21 | <input type="radio"/> FTP <input checked="" type="radio"/> Network |
| Profile 22 | <input type="radio"/> FTP <input checked="" type="radio"/> Network |
| Profile 23 | <input type="radio"/> FTP <input checked="" type="radio"/> Network |
| Profile 24 | <input type="radio"/> FTP <input checked="" type="radio"/> Network |
| Profile 25 | <input type="radio"/> FTP <input checked="" type="radio"/> Network |

5. Click the **Scan to FTP/Network Profile** menu in the left navigation bar.
6. Select the profile you want to set up or change.
7. In the **Profile Name** field, type a name for this server profile (up to 15 alphanumeric characters). The machine will display this name on the LCD.
8. In the **Network Folder Path** field, type the path to the folder on the CIFS server where you want to send your scanned data.
9. Click the **File Name** drop-down list, and then select a file name prefix from the preset names provided, or from user-defined names. The file name used for the scanned document will be the file name prefix you select, followed by the last six digits of the flatbed/ADF scanner counter and the file extension (for example: "Estimate\_098765.pdf").
10. Click the **Quality** drop-down list, and then select a quality setting. If you choose the **User Select** option, the machine will prompt users to select a setting each time they use the scan profile.
11. Click the **File Type** drop-down list, and then select the file type you want to use for the scanned document. If you choose the **User Select** option, the machine will prompt users to select a setting each time they use the scan profile.

- 
12. Click the **Document Size** drop-down list, and then select your document size from the list. This is necessary to make sure the scanned file is the correct size.
  13. Click the **File Size** drop-down list, and then select your file size from the list.
  14. Click the **Remove Background Colour** drop-down list, and then select the level from the list. You can use this feature to remove the background colour of documents to make the scanned data more legible.
  15. To PIN-protect this profile, in the **Use PIN for Authentication** field, select **On**.
  16. If you selected **On** for the **Use PIN for Authentication** field, type a four-digit PIN in the **PIN Code** field.
  17. To set your authentication method, select **Auto**, or **NTLMv2** from the **Auth. Method** menu.
  18. In the **Username** field, type a user name (up to 96 characters) that has permission to write data to the folder specified in the **Network Folder Path** field. If the user name is part of a domain, enter the user name in one of the following styles:  
**user@domain**  
**domain\user**
  19. In the **Password** field, type the password (up to 32 characters) associated with the user name you entered in the **Username** field. Type the password again in the **Retype password** field.
  20. Click **Submit**.



Using the following characters: ?, /, \, ", :, <, >, | or \* may cause a sending error.

21. You must configure the SNTP protocol (network time server) or you must set the date, time and time zone correctly on the control panel for all authentication methods. The time must match the time used by the CIFS Server.



### Related Information

- [Scan to Network \(Windows®\)](#)
  - [Set the Date and Time Using Web Based Management](#)
-

## Set the Date and Time Using Web Based Management

Make sure the date and time and the time zone settings are set correctly using Web Based Management or the control panel, so the machine's time matches the time being used by the server providing authentication.

Ignore step 1, if you already have a Web Based Management window open.

1. Start your web browser.

Type "http://machine's IP address" in your browser's address bar (where "machine's IP address" is the IP address of the machine or the print server name). For example: http://192.168.1.2

No password is required by default. If you have previously set a password, type it, and then click .

2. Click the **Administrator** tab.
3. Click the **Date&Time** menu in the left navigation bar.

### Date&Time

|                      |   |
|----------------------|---|
| <b>Date</b>          | <input type="text" value="xx"/> / <input type="text" value="xx"/> / <input type="text" value="20xx"/> |
| <b>Clock Type</b>    | <input checked="" type="radio"/> 12h Clock <input type="radio"/> 24h Clock                            |
| <b>Time</b>          | <input type="text" value="xx"/> : <input type="text" value="xx"/> <input type="text" value="AM"/>     |
| <b>Time Zone</b>     | <input type="text" value="UTC+09:00"/>  |
| <b>Auto Daylight</b> | <input checked="" type="radio"/> Off <input type="radio"/> On   |

**Synchronize with SNTP server**

To synchronize the "Date&Time" with your SNTP server, you must configure the SNTP server settings.

[SNTP>>](#)

4. In the **Date** fields, enter the date.
5. Select the clock type from the **Clock Type** field.
6. In the **Time** fields, enter the time.
7. Select the time difference between your location and UTC from the **Time Zone** drop-down list, for example, the time zone for Eastern time in the USA and Canada is UTC-05:00.
8. In the **Auto Daylight** field, click **On** to set the machine to change automatically for Daylight Saving Time. It will reset itself forward one hour in the spring, and back one hour in the autumn (available only for some countries).
9. Click **Submit**.

### Related Information

- [Set up a Scan to Network Profile](#)

## Upload Scanned Data to a CIFS Server

**Related Models:** DocuPrint M275 z/DocuPrint M285 z

1. Load your document.
2. Press [Scan] > [to Network].
3. The server profiles you have set up using Web Based Management are listed. Select the profile you want. If the profile is not complete (for example, if the logon account name and password are missing, or if the quality or file type is not specified), you will be prompted to enter any missing information.
4. Press [Start].

The machine starts scanning. If using the machine's scanner glass, follow the LCD instructions to complete the scanning job.



### Related Information

- [Scan to Network \(Windows®\)](#)

## Web Services for Scanning on Your Network (Windows® 7, Windows® 8 and Windows® 10)

The Web Services protocol enables Windows® 7, Windows® 8 and Windows® 10 users to scan using a Fuji Xerox machine on the network. You must install the driver via Web Services.

- [Use Web Services to Install Drivers Used for Scanning \(Windows® 7, Windows® 8 and Windows® 10\)](#)
- [Scan Using Web Services from the Fuji Xerox Machine \(Windows® 7, Windows® 8 and Windows® 10\)](#)
- [Configure Scan Settings for Web Services](#)

## Use Web Services to Install Drivers Used for Scanning (Windows® 7, Windows® 8 and Windows® 10)

Use Web Services to monitor printers on the network.

- Make sure you have installed the Fuji Xerox software and drivers.
- Verify that the host computer and the Fuji Xerox machine are on the same subnet, or that the router is correctly configured to pass data between the two devices.
- You must configure the IP address on your Fuji Xerox machine before you configure this setting.

1. Do one of the following:

- Windows® 7

Click  (**Start**) > **Control Panel** > **Network and Internet** > **View network computers and devices**.

The machine's Web Services Name appears with the printer icon.

Right-click the machine you want to install.

- Windows® 8

Move your mouse to the lower right corner of your desktop. When the menu bar appears, click **Settings** > **Change PC settings** > **Devices** > **Add a device**.

The machine's Web Services Name appears.

- Windows® 8.1

Move your mouse to the lower right corner of your desktop. When the menu bar appears, click **Settings** > **Change PC settings** > **PC and devices** > **Devices** > **Add a device**.

The machine's Web Services Name appears.

- Windows® 10

Click  > **Windows System** > **Control Panel**. In the **Hardware and Sound** group, click **Add a device**.



• The Web Services Name for the Fuji Xerox machine is your model name and the MAC Address (Ethernet Address) of your machine (for example, Fuji Xerox DocuPrint XXXXX (model name) [XXXXXXXXXXXX] (MAC Address / Ethernet Address)).

- Windows® 8/Windows® 10

Move your mouse over the machine name to display the machine's information.

2. Do one of the following:

- Windows® 7

Click **Install** in the displayed menu.

- Windows® 8/Windows® 10

Select the machine you want to install, and then follow the on-screen instructions.



To uninstall drivers, click **Uninstall** or  (**Remove device**).



### Related Information

- [Web Services for Scanning on Your Network \(Windows® 7, Windows® 8 and Windows® 10\)](#)

## Scan Using Web Services from the Fuji Xerox Machine (Windows® 7, Windows® 8 and Windows® 10)

If you have installed the driver for scanning via Web Services, you can access the Web Services scanning menu on your Fuji Xerox machine's LCD.

Certain characters in the messages displayed on the LCD may be replaced with spaces if the language settings of your OS and your Fuji Xerox machine are different.

>> [DocuPrint M235 dw/DocuPrint M235 z](#)

>> [DocuPrint M275 z/DocuPrint M285 z](#)

### DocuPrint M235 dw/DocuPrint M235 z

1. Load your document.
2. Press  (**Scan**).
3. Press ▲ or ▼ to select the [Web Service] option, and then press **OK**.
4. Press ▲ or ▼ to select the type of scan you want to do, and then press **OK**.
5. Press ▲ or ▼ to select the destination computer where you want to send the scan, and then press **OK**.
6. Press **Start**.  
The machine starts scanning.

### DocuPrint M275 z/DocuPrint M285 z

1. Load your document.
2. Press [Scan] > [WS Scan].
3. Press ▲ or ▼ to display the scan options, and then press the type of scan.
4. Press ▲ or ▼ to display the computer name where you want to send data, and then press the computer name.
5. Press [Start].  
The machine starts scanning.



### Related Information

- [Web Services for Scanning on Your Network \(Windows® 7, Windows® 8 and Windows® 10\)](#)



## Configure Scan Settings for Web Services

1. Do one of the following:

- Windows® 7

Click  (**Start**) > **Devices and Printers**.

- Windows® 8

Move your mouse to the lower right corner of your desktop. When the menu bar appears, click **Settings**, and then click **Control Panel**. In the **Hardware and Sound** group, click **View devices and printers**.

- Windows® 10

Click  > **Windows System** > **Control Panel**. In the **Hardware and Sound** group, click **View devices and printers**.

2. Right-click the machine icon, and then select **Scan profiles....** The **Scan Profiles** dialog box appears.

3. Select the scan profile you want to use.

4. Make sure the scanner selected in the **Scanner** list is a Fuji Xerox machine that supports Web Services for scanning, and then click the **Set as Default** button.

5. Click **Edit...**

The **Edit Default Profile** dialog box appears.

6. Select the **Source**, **Paper size**, **Color format**, **File type**, **Resolution (DPI)**, **Brightness** and **Contrast** settings.

7. Click the **Save Profile** button.

These settings will be applied when you scan using the Web Services protocol.

If you are requested to select a scanning application, select Windows® Fax and Scan from the list.



### Related Information

- [Web Services for Scanning on Your Network \(Windows® 7, Windows® 8 and Windows® 10\)](#)

## Change Scan Button Settings from ControlCenter4 (Windows®)

1. Click the  (ControlCenter4) icon in the task tray, and then click **Open**.
2. Click the **Device Settings** tab.
3. Click the **Device Scan Settings** button.

The **Device Scan Settings** dialog box appears.

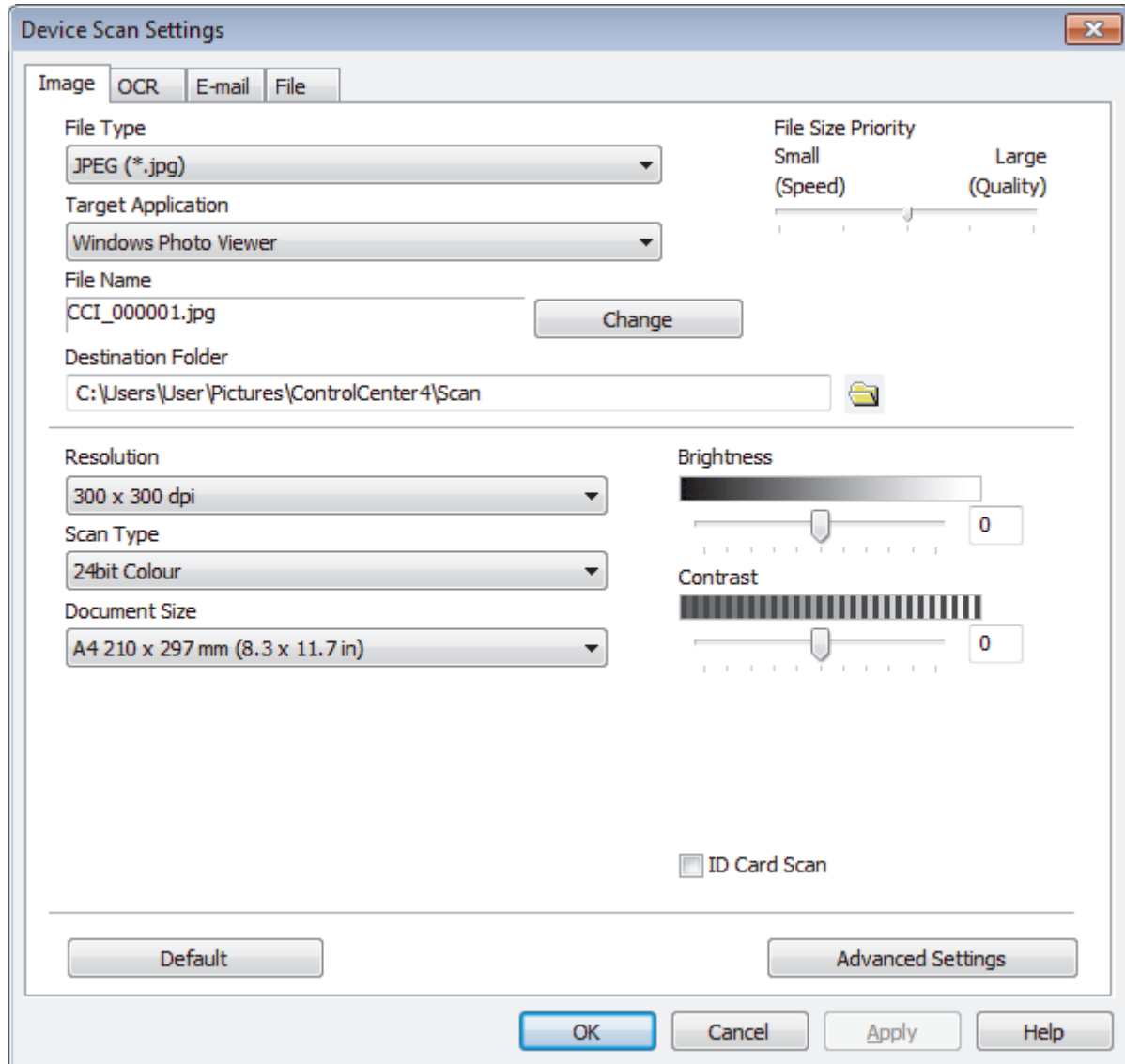

4. Click the tab for the Scan to action you want to change (**Image**, **OCR**, **E-mail**, or **File**).
5. Change the settings as needed.
6. Click **OK**.



Each tab represents one of the scanning destinations, as outlined in the table below.

Change your Scan to settings by clicking on the corresponding tab and customising the setting you want.

| Tab Name | Corresponding Feature |
|----------|-----------------------|
| Image    | Scan to Image         |
| OCR      | Scan to OCR           |
| E-mail   | Scan to Email         |
| File     | Scan to File          |

| Settings                                   | Applicable Features |     |        |      |
|--|---------------------|-----|--------|------|
|  | Image               | OCR | E-mail | File |
| <b>File Type</b>                           | Yes                 | Yes | Yes    | Yes  |
| <b>Target Application</b>                  | Yes                 | Yes | -      | -    |
| <b>OCR Language</b>                        | -                   | Yes | -      | -    |
| <b>File Name</b>                           | Yes                 | Yes | Yes    | Yes  |
| <b>Destination Folder or Scan Location</b> | Yes                 | Yes | Yes    | Yes  |
| <b>Show Save As Window</b>                 | -                   | -   | -      | Yes  |
| <b>Show Folder</b>                         | -                   | -   | -      | Yes  |
| <b>File Size Priority</b>                  | Yes                 | -   | Yes    | Yes  |
| <b>Resolution</b>                          | Yes                 | Yes | Yes    | Yes  |
| <b>Scan Type</b>                           | Yes                 | Yes | Yes    | Yes  |
| <b>Document Size</b>                       | Yes                 | Yes | Yes    | Yes  |
| <b>Brightness</b>                          | Yes                 | Yes | Yes    | Yes  |
| <b>Contrast</b>                            | Yes                 | Yes | Yes    | Yes  |
| <b>ID Card Scan</b>                        | Yes                 | Yes | Yes    | Yes  |
| <b>Advanced Settings</b>                   | Yes                 | Yes | Yes    | Yes  |
| <b>Default</b>                             | Yes                 | Yes | Yes    | Yes  |

### File Type

Select the file type you want to use for the scanned data.

### Target Application

Select the destination application from the drop-down list.

### OCR Language

Set the OCR language to match the language of the scanned document's text.

### File Name

Click **Change** to change the file name's prefix.

### Destination Folder

Click the folder icon to browse and select the folder where you want to save your scanned documents.

### Scan Location

Select the **Folder** or **SharePoint** radio button to specify the destination where you want to save your scanned documents.

### Show Save As Window

Select this option to specify the scanned image's destination every time you scan.

---

## Show Folder

Select this option to automatically display the destination folder after scanning.

## File Size Priority

Adjust the data compression ratio of the scanned image. Change the file size by moving the **File Size Priority** slider to the right or left.

## Resolution

Select a scanning resolution from the **Resolution** drop-down list. Higher resolutions take more memory and transfer time, but produce a finer scanned image.

## Scan Type

Select from a range of scan colour depths.

- **Auto**  
Use for any type of document. This mode automatically picks an appropriate colour depth for the document.
- **Black & White**  
Use for text or line art images.
- **Grey (Error Diffusion)**  
Use for photographic images or graphics. (Error Diffusion is a method for creating simulated grey images without using true grey dots. Black dots are put in a specific pattern to give a grey appearance.)
- **True Grey**  
Use for photographic images or graphics. This mode is more accurate because it uses up to 256 shades of grey.
- **24bit Colour**  
Use to create an image with the most accurate colour reproduction. This mode uses up to 16.8 million colours to scan the image, but it requires the most memory and has the longest transfer time.

## Document Size

Select the exact size of your document from the **Document Size** drop-down list.

- If you select the **1 to 2 (A4)** option, the scanned image will be divided into two A5-size documents.

## Brightness

Set the **Brightness** level by dragging the slider to the right or left to lighten or darken the image. If the scanned image is too light, set a lower brightness level and scan the document again. If the image is too dark, set a higher brightness level and scan the document again. You can also type a value into the field to set the **Brightness** level.

## Contrast

Increase or decrease the **Contrast** level by moving the slider to the right or left. An increase emphasises dark and light areas of the image, while a decrease reveals more details in grey areas. You can also type a value into the field to set the **Contrast** level.

## ID Card Scan

Select this check box to scan both sides of an identification card onto one page.

## Advanced Settings

Configure advanced settings by clicking the **Advanced Settings** button in the Scan Settings dialog box.

- **Remove Bleed-through / Pattern**  
**Remove Background Colour**  
Remove the base colour of documents to make the scanned data more legible.
- **Rotate Image**  
Rotate the scanned image.
- **Skip Blank Page**  
Remove the document's blank pages from the scanning results.

---

- **Display Scanning Results**

Show the numbers of total pages saved and blank pages skipped on your computer screen.

- **ADF Auto Deskew**

When scanning the document from the ADF, the machine corrects skewing of the document automatically.

**Default**

Select this option to restore all settings to their factory setting values.



### **Related Information**

- [Scan Using the Scan Button on Your Fuji Xerox Machine](#)
  - [Scan Photos and Graphics](#)
  - [Save Scanned Data to a Folder as a PDF File](#)
  - [Scan to an Editable Text File \(OCR\)](#)
  - [Scan to Email Attachment](#)
-

## Change Scan Button Settings from iPrint&Scan (Mac)

1. In the **Finder** menu bar, click **Go > Applications > Fuji Xerox**, and then double-click the iPrint&Scan icon. The iPrint&Scan screen appears.
2. If your Fuji Xerox machine is not selected, click the **Select your Machine** button, and then follow the on-screen instructions to select your Fuji Xerox machine.
3. Click the **Machine Scan Settings** button, and then follow the on-screen instructions to change the scan settings.



### Related Information

- [Scan Using the Scan Button on Your Fuji Xerox Machine](#)
  - [Scan Using iPrint&Scan \(Mac\)](#)
  - [Scan Photos and Graphics](#)
  - [Save Scanned Data to a Folder as a PDF File](#)
  - [Scan to an Editable Text File \(OCR\)](#)
  - [Scan to Email Attachment](#)
-

## Configure Certificate for Signed PDF

If you select Signed PDF for Scan features, you must configure a certificate on your machine using Web Based Management.

To use Signed PDF, you must install a certificate on your machine and your computer.

1. Start your web browser.

Type "http://machine's IP address" in your browser's address bar (where "machine's IP address" is the IP address of the machine or the print server name). For example: http://192.168.1.2

No password is required by default. If you have previously set a password, type it, and then click .

2. Click the **Administrator** tab.
3. Click the **Signed PDF** menu in the left navigation bar.

The Signed PDF configuration dialog box appears.

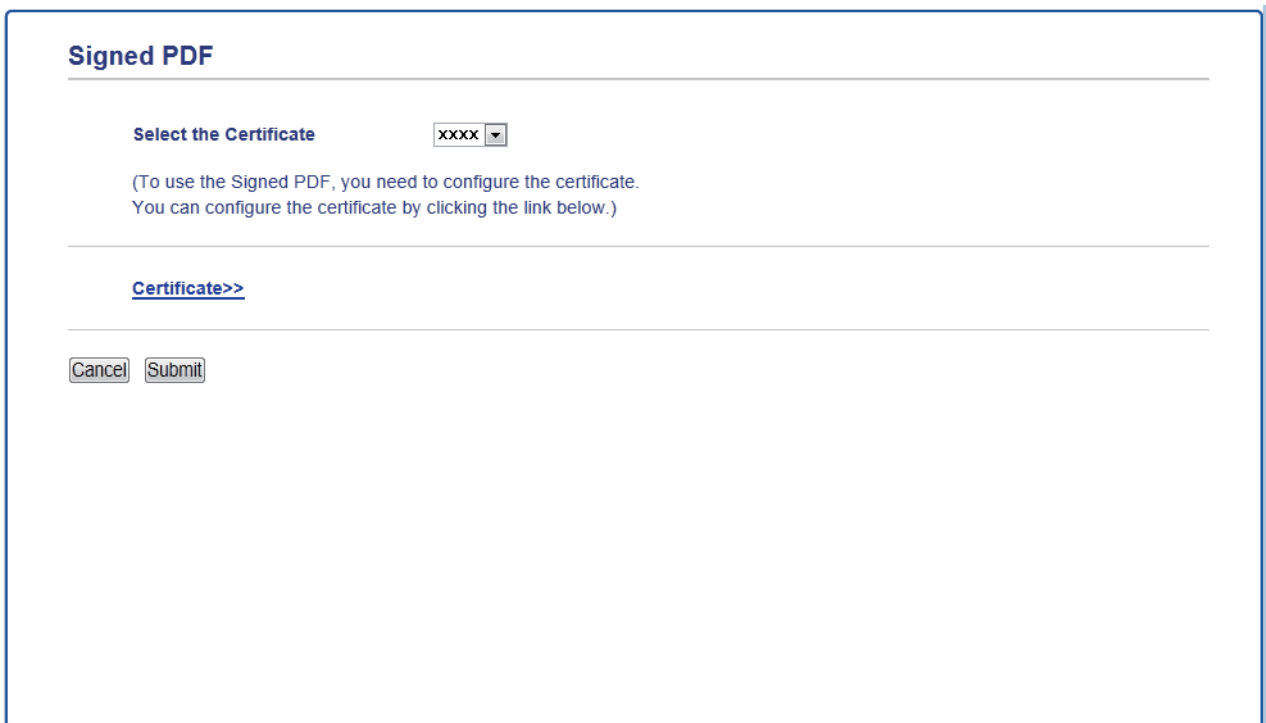

**Signed PDF**

Select the Certificate

(To use the Signed PDF, you need to configure the certificate.  
You can configure the certificate by clicking the link below.)

[Certificate>>](#)

4. Click the **Select the Certificate** drop-down list, and then select the certificate.
5. Click **Submit**.

### Related Information

- [Scan Using the Scan Button on Your Fuji Xerox Machine](#)

## Disable Scanning from Your Computer

You can disable the ability to scan from your computer. Set the pull scan setting using Web Based Management.

1. Start your web browser.

Type "http://machine's IP address" in your browser's address bar (where "machine's IP address" is the IP address of the machine or the print server name). For example: http://192.168.1.2

No password is required by default. If you have previously set a password, type it, and then click .

2. Click the **Scan** tab.
3. Click the **Scan from PC** menu in the left navigation bar.
4. In the **Pull Scan** field, click **Disabled**.
5. Click **Submit**.



### Related Information

- [Scan Using the Scan Button on Your Fuji Xerox Machine](#)



## Scan from Your Computer (Windows®)

There are several ways you can use your computer to scan photos and documents on your Fuji Xerox machine. Use the software applications provided by Fuji Xerox, or use your favourite scanning application.

- [Scan Using ControlCenter4 Home Mode \(Windows®\)](#)
- [Scan Using ControlCenter4 Advanced Mode \(Windows®\)](#)
- [Scan Using Nuance™ PaperPort™ 14SE or Other Windows® Applications](#)
- [Scan Using Windows® Fax and Scan](#)

## Scan Using ControlCenter4 Home Mode (Windows®)

Use ControlCenter4 Home Mode to access your machine's main features.

- [Scan Using ControlCenter4 Home Mode \(Windows®\)](#)
- [Save Scanned Data to a Folder as a PDF File Using ControlCenter4 Home Mode \(Windows®\)](#)
- [Scan Both Sides of a Document Automatically Using ControlCenter4 Home Mode \(Windows®\)](#)
- [Scan Settings for ControlCenter4 Home Mode \(Windows®\)](#)



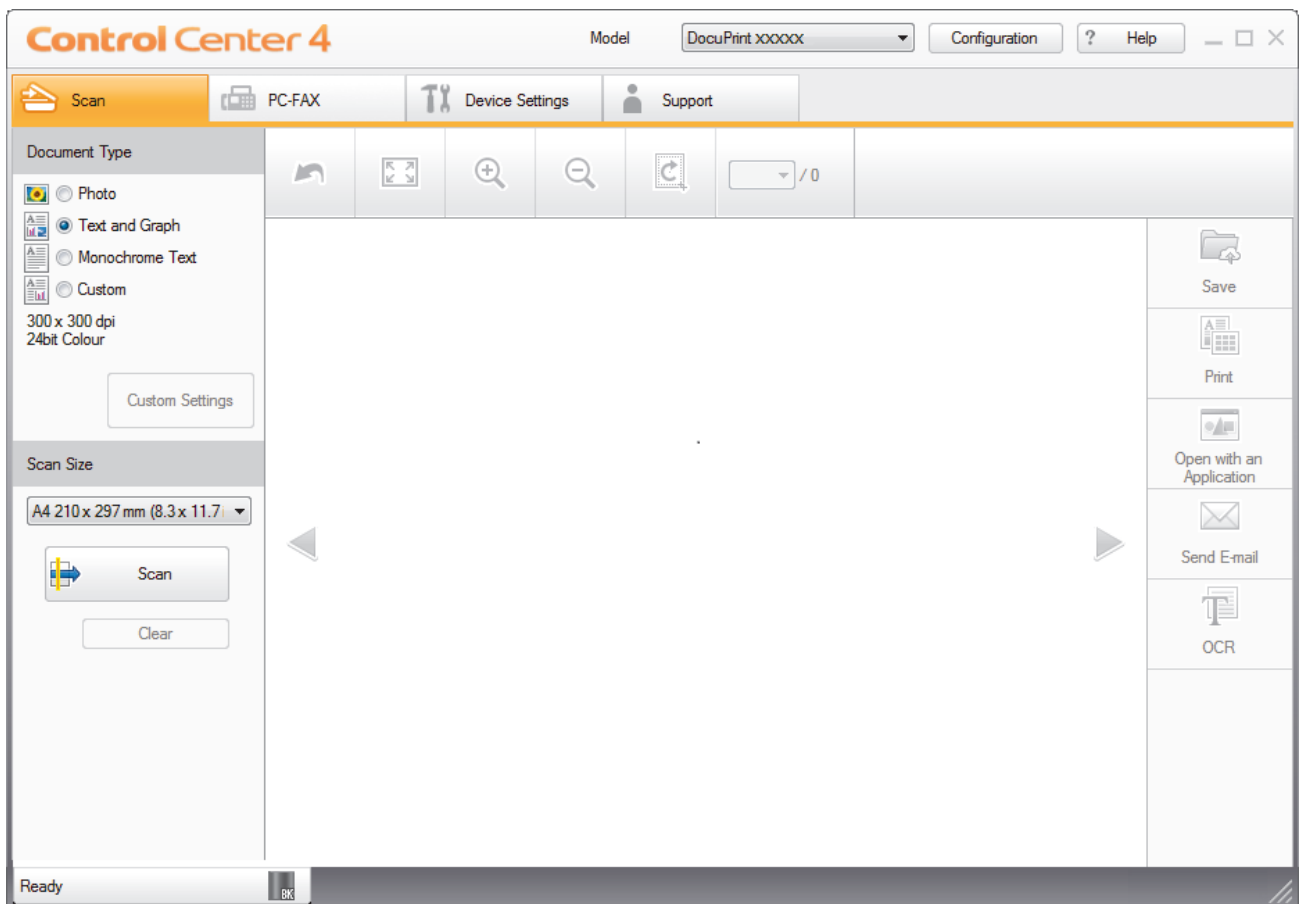

## Scan Using ControlCenter4 Home Mode (Windows®)

Select **Home Mode** as the mode setting for ControlCenter4.

1. Load your document.
2. Click the  (**ControlCenter4**) icon in the task tray, and then click **Open**.
3. Click the **Scan** tab.



4. Select the **Document Type**.
5. Change the document's **Scan Size**, if needed.
6. Click  (**Scan**).

The machine starts scanning, and the scanned image appears in the image viewer.
7. Click the left or right arrow buttons to preview each scanned page.
8. Crop the scanned image, if needed.
9. Do one of the following:
  - Click  (**Save**) to save scanned data.
  - Click  (**Print**) to print scanned data.
  - Click  (**Open with an Application**) to open scanned data in another application.
  - Click  (**Send E-mail**) to attach scanned data to an email.
  - Click  (**OCR**) to convert your scanned document to an editable text file. (available only for certain models)



## Related Information

- [Scan Using ControlCenter4 Home Mode \(Windows®\)](#)
- [Select Document Type Using ControlCenter4 Home Mode \(Windows®\)](#)
- [Change Scan Size Using ControlCenter4 Home Mode \(Windows®\)](#)
- [Crop a Scanned Image Using ControlCenter4 Home Mode \(Windows®\)](#)
- [Print Scanned Data Using ControlCenter4 Home Mode \(Windows®\)](#)
- [Scan to an Application Using ControlCenter4 Home Mode \(Windows®\)](#)

Home > Scan > Scan from Your Computer (Windows®) > Scan Using ControlCenter4 Home Mode (Windows®) > Scan Using ControlCenter4 Home Mode (Windows®) > Select Document Type Using ControlCenter4 Home Mode (Windows®)

## Select Document Type Using ControlCenter4 Home Mode (Windows®)

- Select the **Document Type** option that matches the type of original you want to scan.

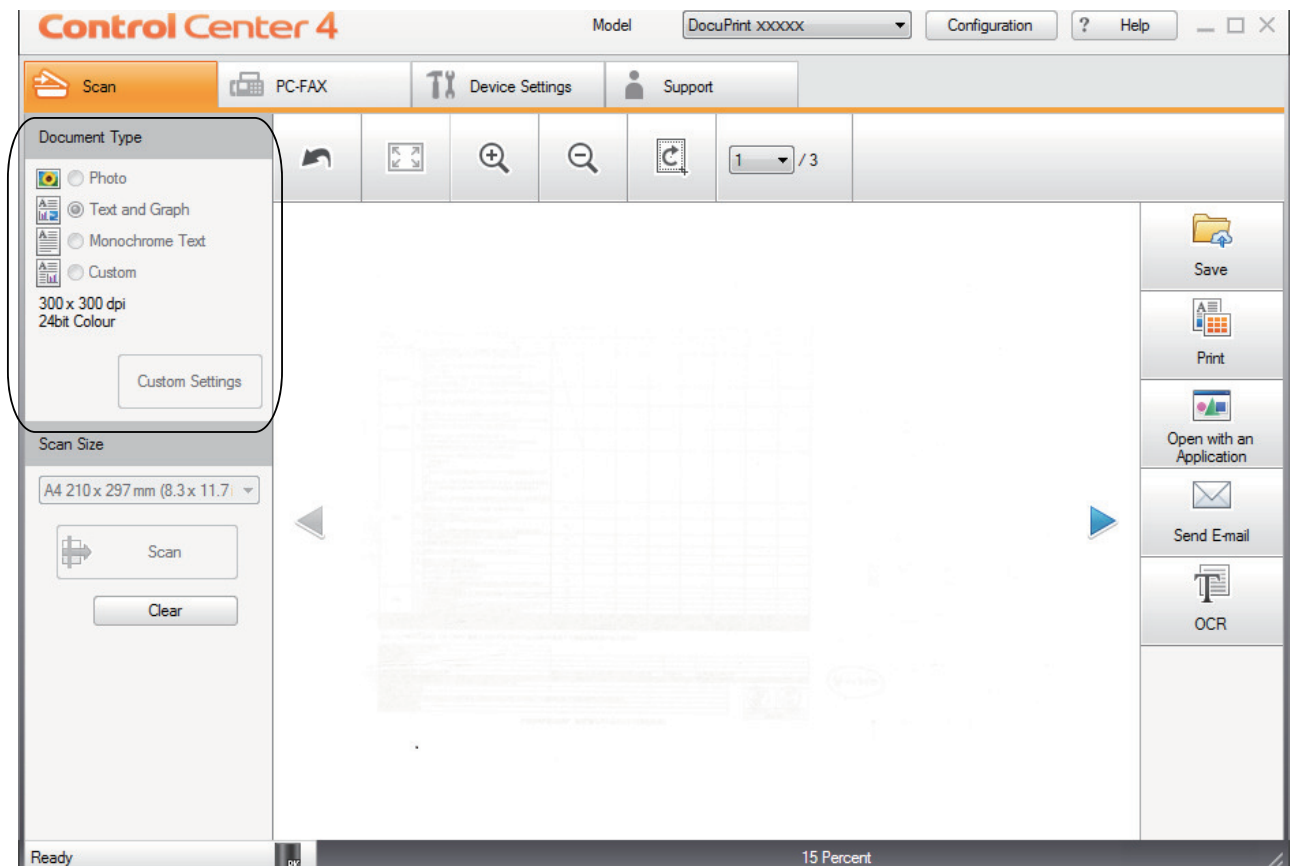

| Option          | Description  |
|-----------------|--|
| Photo           | 600 x 600 dpi 24bit Colour   |
| Text and Graph  | 300 x 300 dpi 24bit Colour   |
| Monochrome Text | 200 x 200 dpi Black & White  |
| Custom          | 300 x 300 dpi (24bit Colour as default) Select the scan settings you want from the Custom Settings button. |



### Related Information

- [Scan Using ControlCenter4 Home Mode \(Windows®\)](#)
- [Custom Scan Settings \(Windows®\)](#)

Home > Scan > Scan from Your Computer (Windows®) > Scan Using ControlCenter4 Home Mode (Windows®) > Scan Using ControlCenter4 Home Mode (Windows®) > Select Document Type Using ControlCenter4 Home Mode (Windows®) > Custom Scan Settings (Windows®)

## Custom Scan Settings (Windows®)

Select **Custom** in the **Document Type** list to change advanced scan settings.

- Select **Custom**, and then click the **Custom Settings** button.

The **Custom Scan Settings** dialog box appears.

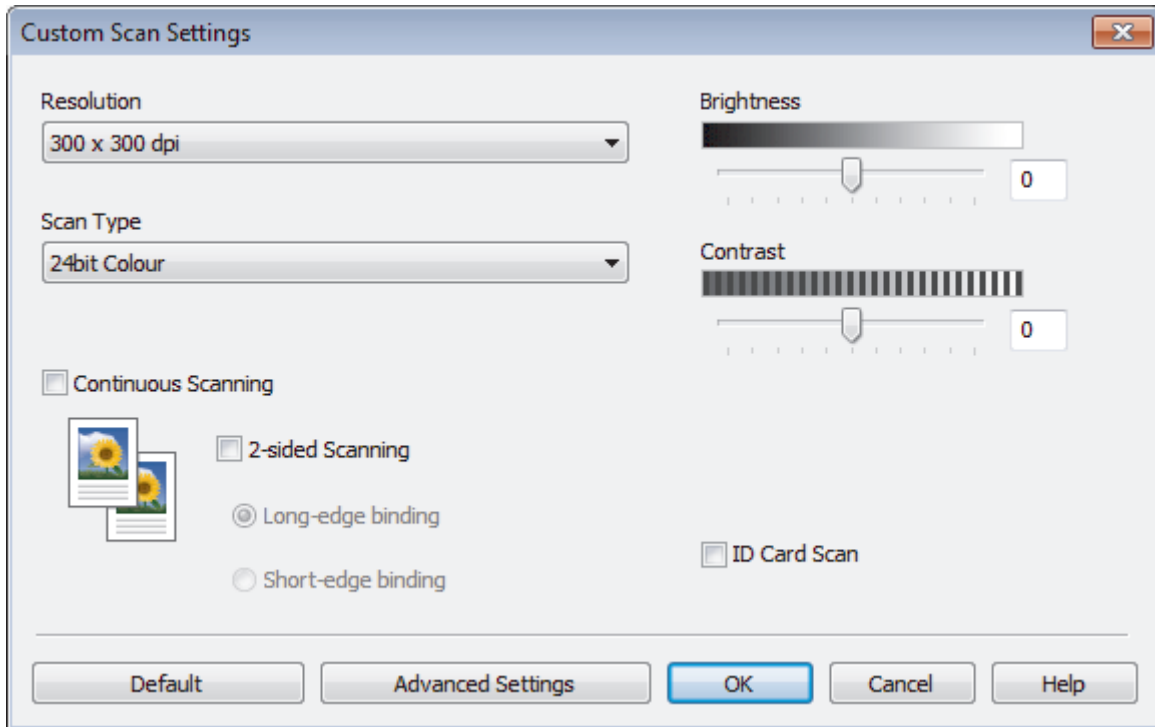

You can change the following settings:

### Resolution

Select a scanning resolution from the **Resolution** drop-down list. Higher resolutions take more memory and transfer time, but produce a finer scanned image.

### Scan Type

Select from a range of scan colour depths.

#### - Auto

Use for any type of document. This mode automatically picks an appropriate colour depth for the document.

#### - Black & White

Use for text or line art images.

#### - Grey (Error Diffusion)

Use for photographic images or graphics. (Error Diffusion is a method for creating simulated grey images without using true grey dots. Black dots are put in a specific pattern to give a grey appearance.)

#### - True Grey

Use for photographic images or graphics. This mode is more accurate because it uses up to 256 shades of grey.

#### - 24bit Colour

Use to create an image with the most accurate colour reproduction. This mode uses up to 16.8 million colours to scan the image, but it requires the most memory and has the longest transfer time.

---

## Brightness

Set the **Brightness** level by dragging the slider to the right or left to lighten or darken the image. If the scanned image is too light, set a lower brightness level and scan the document again. If the image is too dark, set a higher brightness level and scan the document again. You can also type a value into the field to set the **Brightness** level.

## Contrast

Increase or decrease the **Contrast** level by moving the slider to the right or left. An increase emphasises dark and light areas of the image, while a decrease reveals more details in grey areas. You can also type a value into the field to set the **Contrast** level.

## Continuous Scanning

Select this option to scan multiple pages. After a page is scanned, select either continue scanning or finish.

## 2-sided Scanning

Select this check box to scan both sides of the document. When using the Automatic 2-sided Scan feature, you must select the **Long-edge binding** or **Short-edge binding** option, depending on the layout of your original, to make sure the data file you create appears correctly.

(DocuPrint M275 z/DocuPrint M285 z)

## ID Card Scan

Select this check box to scan both sides of an identification card onto one page.

## Advanced Settings

Configure advanced settings by clicking the **Advanced Settings** button in the Scan Settings dialog box.

- **Remove Bleed-through / Pattern**
  - **Remove Background Colour**

Remove the base colour of documents to make the scanned data more legible.
- **Rotate Image**

Rotate the scanned image.
- **Skip Blank Page**

Remove the document's blank pages from the scanning results.
- **Display Scanning Results**

Show the numbers of total pages saved and blank pages skipped on your computer screen.
- **ADF Auto Deskew**

When scanning the document from the ADF, the machine corrects skewing of the document automatically.



## Related Information

- [Select Document Type Using ControlCenter4 Home Mode \(Windows®\)](#)
-

Home > Scan > Scan from Your Computer (Windows®) > Scan Using ControlCenter4 Home Mode (Windows®) > Scan Using ControlCenter4 Home Mode (Windows®) > Change Scan Size Using ControlCenter4 Home Mode (Windows®)

## Change Scan Size Using ControlCenter4 Home Mode (Windows®)

For faster scan speeds, select the exact size of your document from the **Scan Size** drop-down menu.

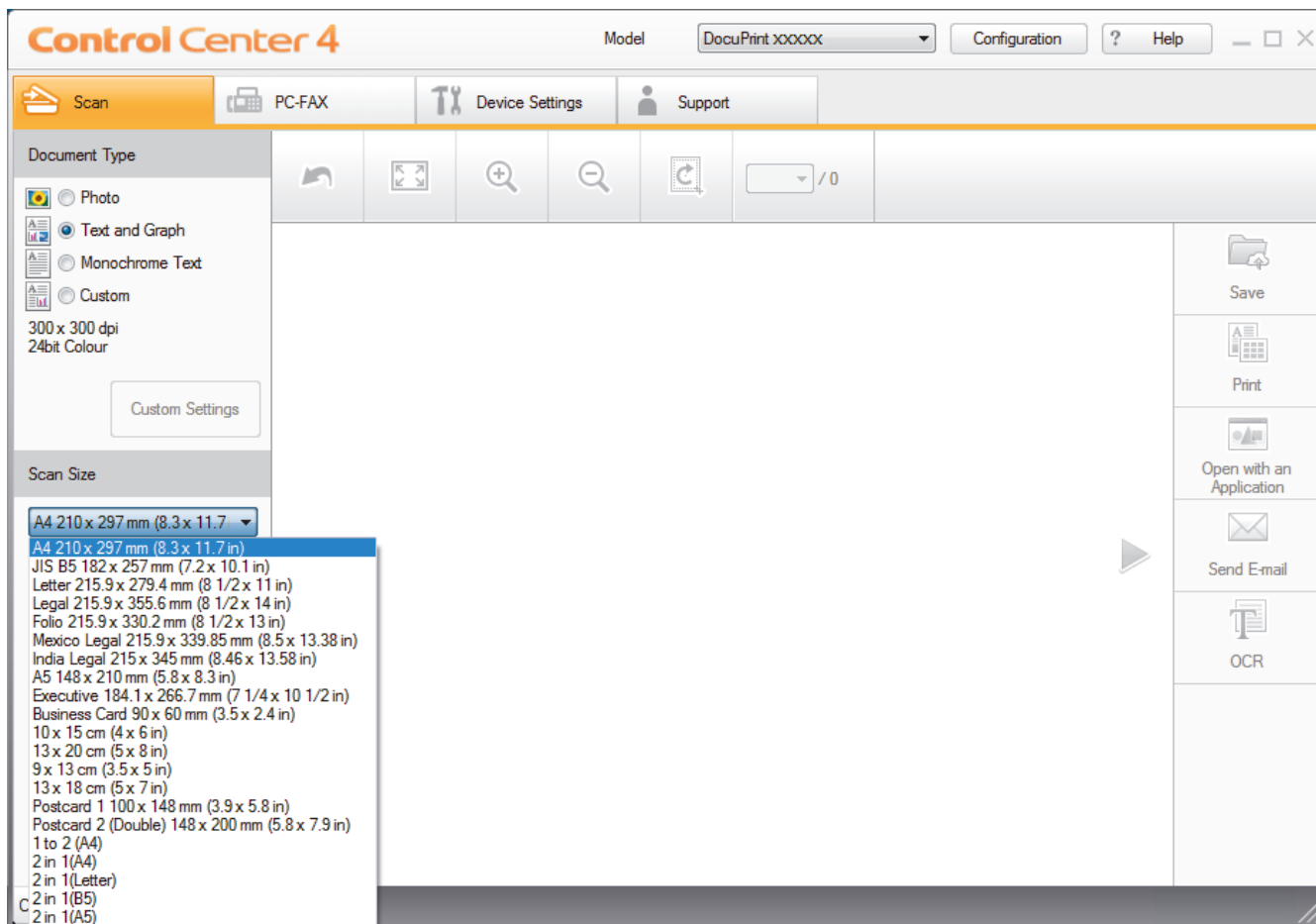

### ✓ Related Information

- [Scan Using ControlCenter4 Home Mode \(Windows®\)](#)



## Crop a Scanned Image Using ControlCenter4 Home Mode (Windows®)

The crop tool on the Image Editing Toolbar lets you trim unwanted areas from your scanned image. Use the **Zoom In** and **Zoom Out** tools to help view the image to be cropped.

### Image Editing Toolbar

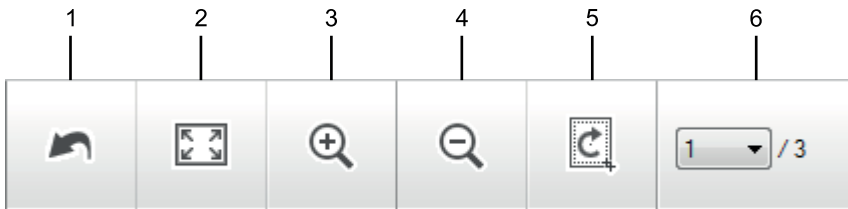

#### 1. Restart

Cancels all the edits applied to the selected image. The edited image returns to its original state.

#### 2. Fit to Window

Displays the scanned image so that the entire image fits in the window.

#### 3. Zoom In

Zooms in on the scanned image.

#### 4. Zoom Out

Zooms out of the scanned image.

#### 5. Crop and Edit

Removes the outer parts of the image. Click the **Crop and Edit** button, and then change the frame to contain the area you want to keep after cropping.

#### 6. Page Counter

Indicates the page number of the scanned page currently shown in the image viewer. To display a different page, select the desired page number from the drop-down page number list.



If you have scanned multiple pages, you can see the next or previous scanned page by clicking the left or right arrow buttons in the preview window.

1. Scan a document.

2. Click  (**Crop and Edit**) to edit the scanned image.

The **Crop and Edit - ControlCenter4** window appears.

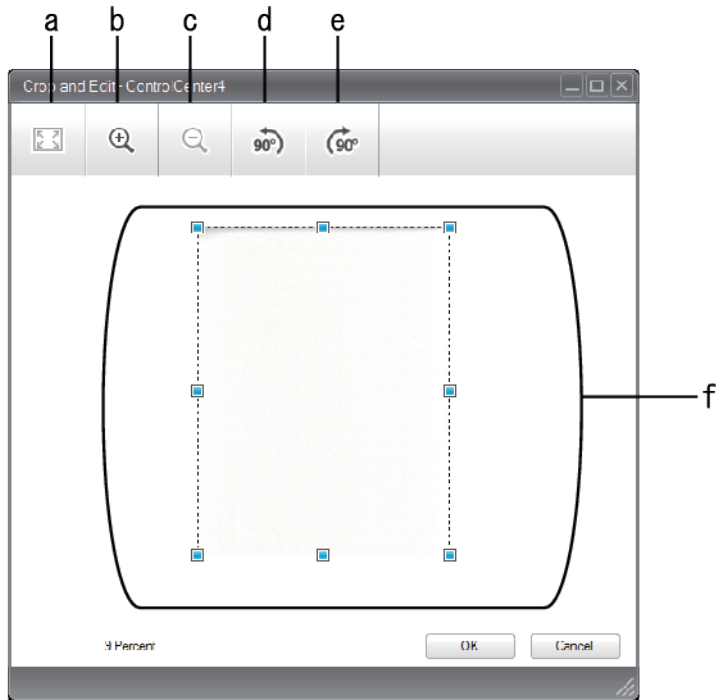

- a. Expands the scanned image so that the entire image fits in the window.
  - b. Zooms in on the image.
  - c. Zooms out of the image.
  - d. Rotates the image counter-clockwise 90 degrees.
  - e. Rotates the image clockwise 90 degrees.
  - f. Click and drag the frame to adjust the area to be cropped.
3. Click **OK**.
- The edited image appears in the image viewer.



### Related Information

- [Scan Using ControlCenter4 Home Mode \(Windows®\)](#)

Home > Scan > Scan from Your Computer (Windows®) > Scan Using ControlCenter4 Home Mode (Windows®) > Scan Using ControlCenter4 Home Mode (Windows®) > Print Scanned Data Using ControlCenter4 Home Mode (Windows®)

## Print Scanned Data Using ControlCenter4 Home Mode (Windows®)

Scan a document on your Fuji Xerox machine, and then print copies using the printer driver features that are available in ControlCenter4.

1. Scan a document.
2. Click **Print**.

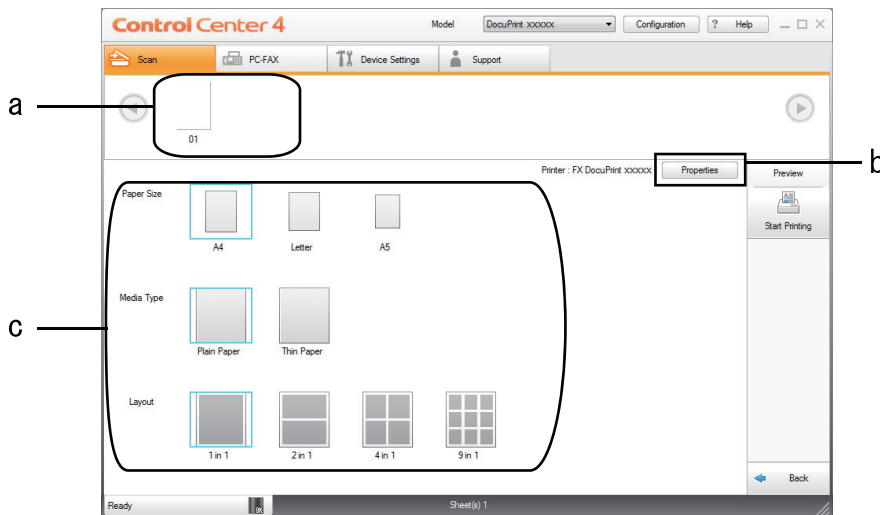

- a. Shows which images are currently selected.
  - b. Click the **Properties** button to change specific printer settings.
  - c. Select the **Paper Size**, **Media Type** and **Layout** options. The current settings are enclosed in a blue square.
3. Configure the print settings, and then click the **Start Printing** button.

### ✓ Related Information

- [Scan Using ControlCenter4 Home Mode \(Windows®\)](#)

Home > Scan > Scan from Your Computer (Windows®) > Scan Using ControlCenter4 Home Mode (Windows®) > Scan Using ControlCenter4 Home Mode (Windows®) > Scan to an Application Using ControlCenter4 Home Mode (Windows®)

## Scan to an Application Using ControlCenter4 Home Mode (Windows®)

The **Open with an Application** button lets you scan an image directly into your graphics application for editing.

Select **Home Mode** as the mode setting for ControlCenter4.

1. Load your document.
2. Click the  (**ControlCenter4**) icon in the task tray, and then click **Open**.
3. Click the **Scan** tab.

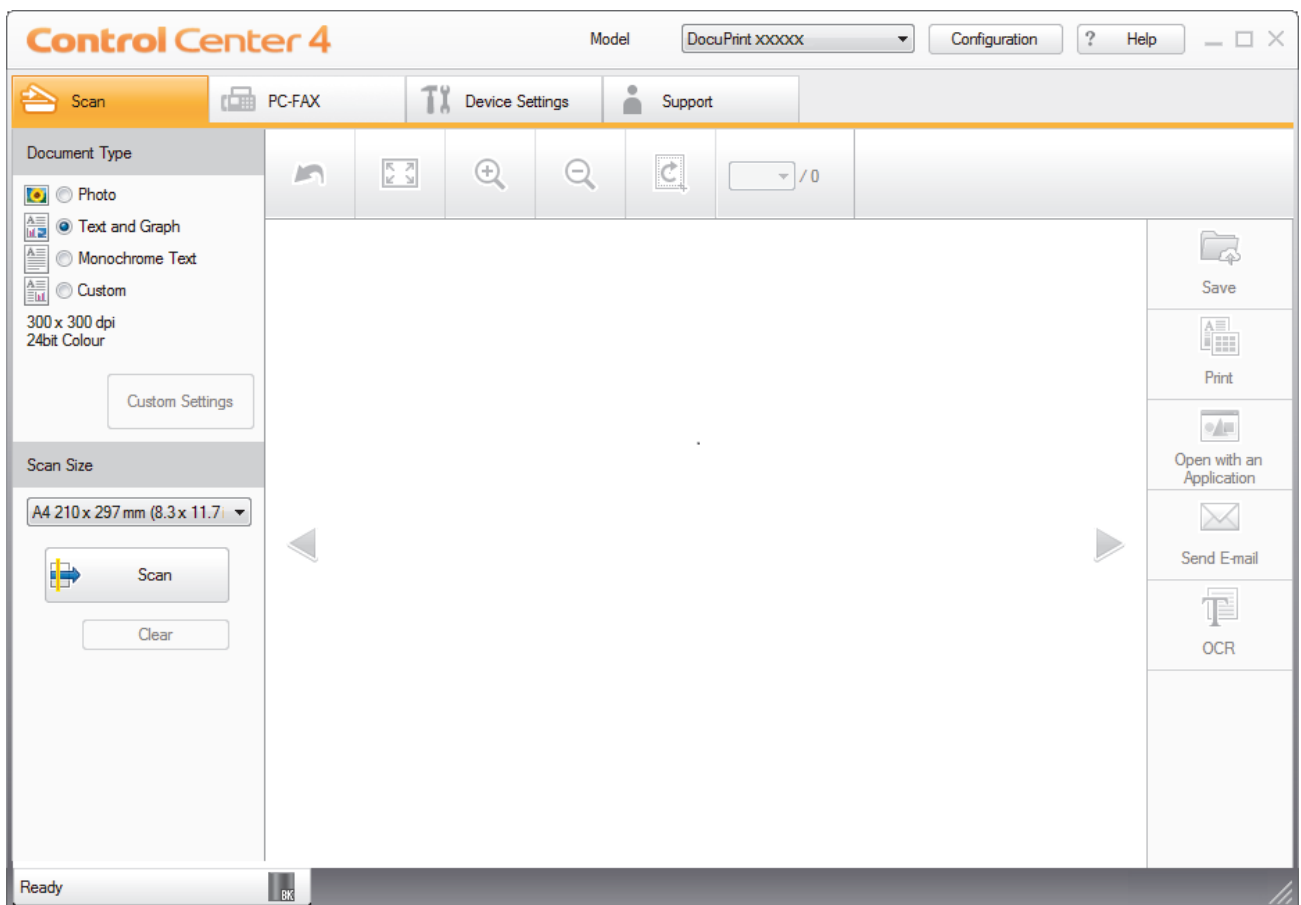

4. Select the **Document Type**.
  5. Change the size of your document, if needed.
  6. Click  (**Scan**).
- The machine starts scanning, and the scanned image appears in the image viewer.
7. Click the left or right arrow buttons to preview each scanned page.
  8. Crop the scanned image, if needed.
  9. Click the **Open with an Application** button.
  10. Select the application from the drop-down list, and then click **OK**.
- The image opens in the application you have selected.

### ✓ Related Information

- [Scan Using ControlCenter4 Home Mode \(Windows®\)](#)

## Save Scanned Data to a Folder as a PDF File Using ControlCenter4 Home Mode (Windows®)

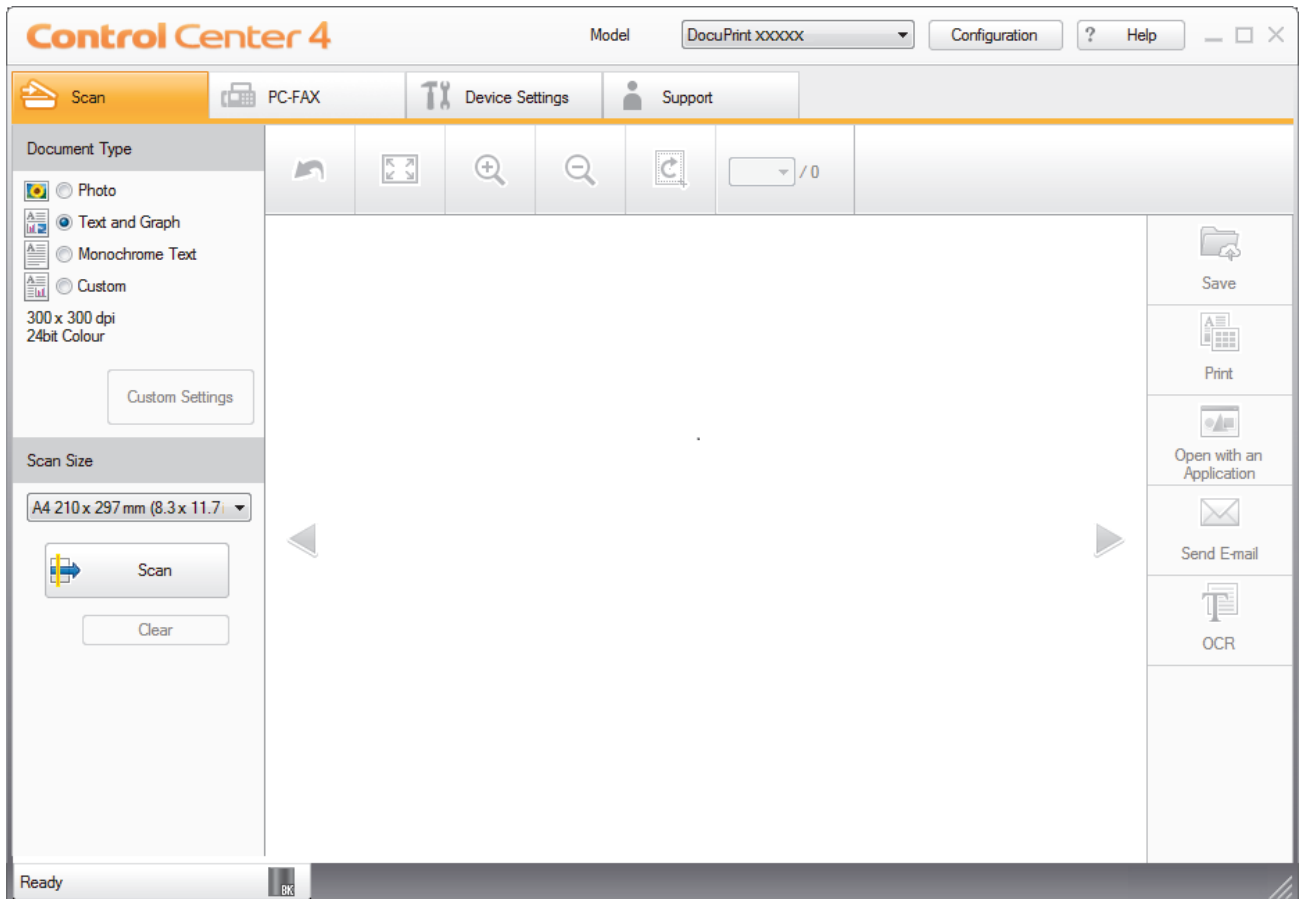

Select **Home Mode** as the mode setting for ControlCenter4.

1. Load your document.
2. Click the  (ControlCenter4) icon in the task tray, and then click **Open**.
3. Click the **Scan** tab.

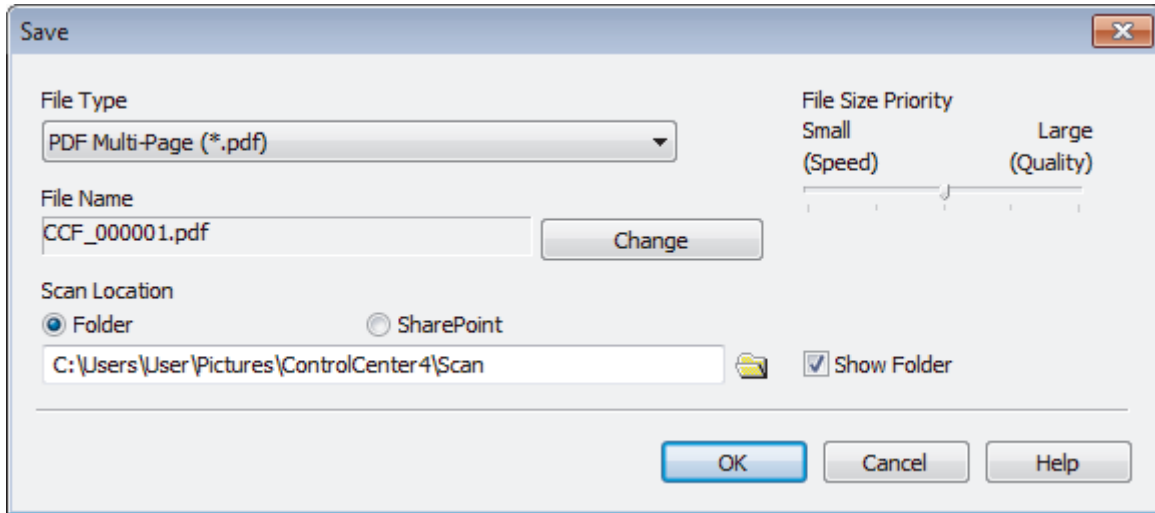

4. Select the **Document Type**.
5. Change the size of your document, if needed.
6. Click  (**Scan**).  
The machine starts scanning, and the scanned image appears in the image viewer.
7. Click the left or right arrow buttons to preview each scanned page.
8. Click **Save**.  
The **Save** dialog box appears.
9. Click the **File Type** drop-down list, and then select a PDF file.



 To save the document as a password-protected PDF, select **Secure PDF Single-Page (\*.pdf)** or **Secure PDF Multi-Page (\*.pdf)** from the **File Type** drop-down list, click , and then type the password.

10. To change the file name, click the **Change** button, if needed.
11. Click the folder icon to browse and select the folder where you want to save your scanned documents.
12. Click **OK**.

The scanned document is saved to the destination folder as a PDF.

### **Related Information**

- [Scan Using ControlCenter4 Home Mode \(Windows®\)](#)

## Scan Both Sides of a Document Automatically Using ControlCenter4 Home Mode (Windows®)

**Related Models:** DocuPrint M275 z/DocuPrint M285 z

Select **Home Mode** as the mode setting for ControlCenter4.

1. Load documents in the ADF.



To scan both sides of a document automatically, you must use the ADF, not the flatbed scanner glass.



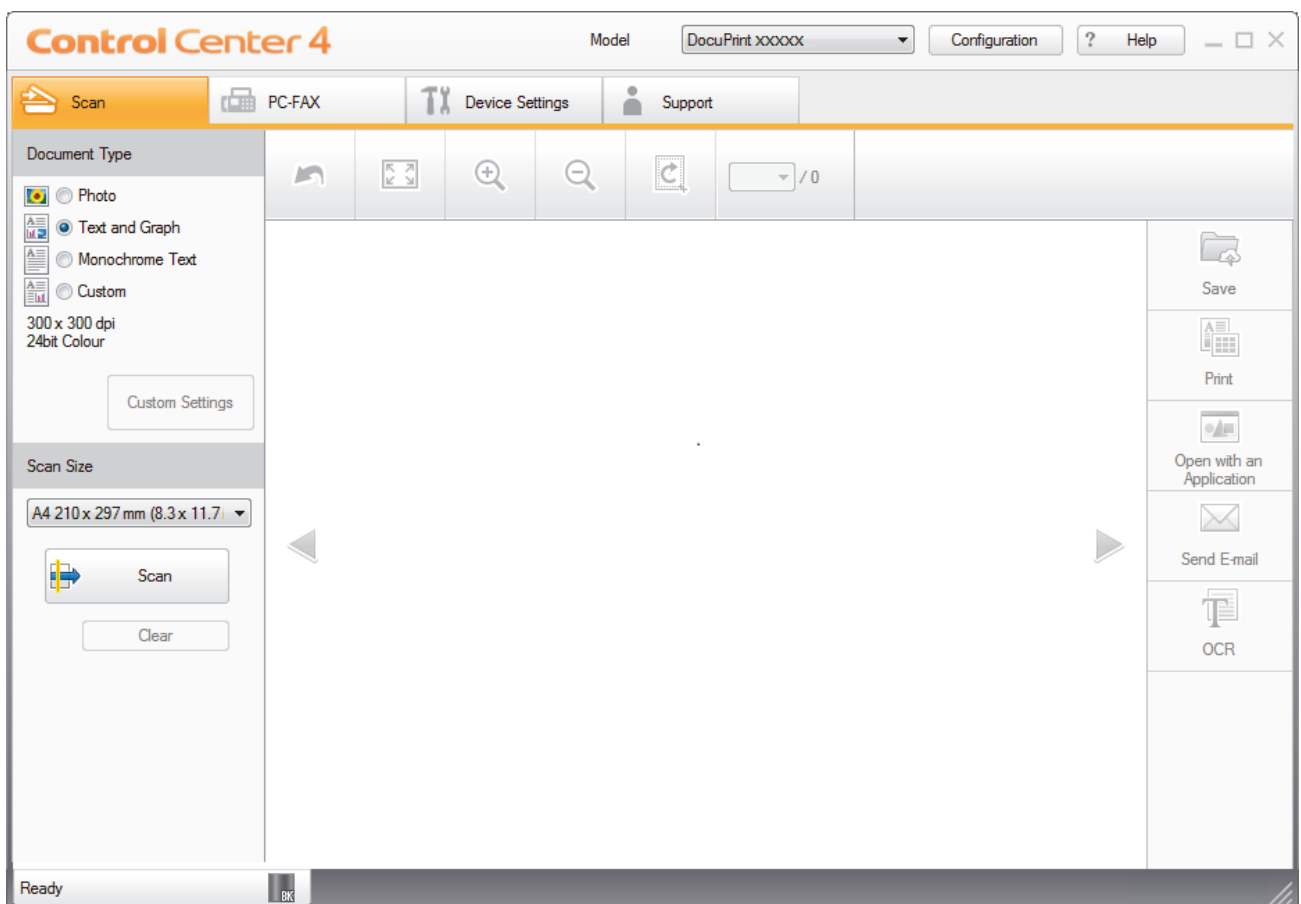

2. Click the  (**ControlCenter4**) icon in the task tray, and then click **Open**.
3. Click the **Scan** tab.



4. Under **Document Type**, select **Custom**, and then click the **Custom Settings** button.  
The **Custom Scan Settings** dialog box appears.
5. Select the **2-sided Scanning** check box.
6. Select the **Long-edge binding** or **Short-edge binding** option, depending on the Original layout.
7. Configure other **Custom Scan Settings**, if needed.
8. Click **OK**.
9. Click  (**Scan**).

The machine starts scanning, and the scanned image appears in the image viewer.

10. Click the left or right arrow buttons to preview each scanned page.
11. Do one of the following:

- 
- Click  (**Save**) to save scanned data.
  - Click  (**Print**) to print scanned data.
  - Click  (**Open with an Application**) to open scanned data in another application.
  - Click  (**Send E-mail**) to attach scanned data to an email.
  - Click  (**OCR**) to convert your scanned document to an editable text file. (available only for certain models)



## Related Information

- [Scan Using ControlCenter4 Home Mode \(Windows®\)](#)
-



## Scan Settings for ControlCenter4 Home Mode (Windows®)

| Settings           | Applicable Features      |     |             |      |
|--------------------|--------------------------|-----|-------------|------|
|                    | Open with an Application | OCR | Send E-mail | Save |
| File Type          | -                        | Yes | Yes         | Yes  |
| Target Application | Yes                      | Yes | -           | -    |
| OCR Language       | -                        | Yes | -           | -    |
| File Name          | -                        | -   | -           | Yes  |
| Scan Location      | -                        | -   | -           | Yes  |
| Show Folder        | -                        | -   | -           | Yes  |
| File Size Priority | -                        | -   | Yes         | Yes  |

### File Type

Select the file type you want to use for the scanned data.

#### For Send E-mail and Save

- **Windows Bitmap (\*.bmp)**
- **JPEG (\*.jpg)** (recommended for most users when scanning pictures)
- **TIFF Single-Page (\*.tif)**
- **TIFF Multi-Page (\*.tif)**
- **Portable Network Graphics (\*.png)**
- **PDF Single-Page (\*.pdf)** (recommended for scanning and sharing documents)
- **PDF Multi-Page (\*.pdf)** (recommended for scanning and sharing documents)
- **PDF/A Single-Page (\*.pdf)** (recommended for scanning and sharing documents)
- **PDF/A Multi-Page (\*.pdf)** (recommended for scanning and sharing documents)
- **High Compression PDF Single-Page (\*.pdf)**
- **High Compression PDF Multi-Page (\*.pdf)**
- **Secure PDF Single-Page (\*.pdf)**
- **Secure PDF Multi-Page (\*.pdf)**
- **Searchable PDF Single-Page (\*.pdf)**
- **Searchable PDF Multi-Page (\*.pdf)**
- **XML Paper Specification (\*.xps)** (the XML Paper Specification is available for Windows® 7, Windows® 8 and Windows® 10, and when using applications that support XML Paper Specification files)

#### For OCR

- **HTML 3.2 (\*.htm)**
- **HTML 4.0 (\*.htm)**
- **Microsoft Excel 2003, XP (\*.xls)**
- **RTF Word 2000 (\*.rtf)**
- **WordPad (\*.rtf)**
- **WordPerfect 9, 10 (\*.wpd)**
- **Text (\*.txt)**
- **Searchable PDF Single-Page (\*.pdf)**
- **Searchable PDF Multi-Page (\*.pdf)**

### Target Application

Select the destination application from the drop-down list.

---

### OCR Language

Set the optical character recognition (OCR) language to match the language of the scanned document's text.

### File Name

Click **Change** to change the file name's prefix.

### Scan Location

Select the **Folder** or **SharePoint** radio button to specify the destination where you want to save your scanned documents.

### Show Folder

Select this option to automatically display the destination folder after scanning.

### File Size Priority

Adjust the data compression ratio of the scanned image. Change the file size by moving the **File Size Priority** slider to the right or left.

### Custom Settings

Select the **Custom** option, click the **Custom Settings** button, and then change settings.

### Scan Size

Select the exact size of your document from the **Scan Size** drop-down menu.



### Related Information

- [Scan Using ControlCenter4 Home Mode \(Windows®\)](#)

## Scan Using ControlCenter4 Advanced Mode (Windows®)

ControlCenter4 Advanced Mode gives you more control over the details of your machine's features and allows you to customise one-button scan actions.

- [Scan Photos and Graphics Using ControlCenter4 Advanced Mode \(Windows®\)](#)
- [Save Scanned Data to a Folder as a PDF File Using ControlCenter4 Advanced Mode \(Windows®\)](#)
- [Scan Both Sides of a Document Automatically Using ControlCenter4 Advanced Mode \(Windows®\)](#)
- [Scan Both Sides of an ID Card Using ControlCenter4 Advanced Mode \(Windows®\)](#)
- [Scan to Email Attachment Using ControlCenter4 Advanced Mode \(Windows®\)](#)
- [Scan to an Editable Text File \(OCR\) Using ControlCenter4 Advanced Mode \(Windows®\)](#)
- [Scan Settings for ControlCenter4 Advanced Mode \(Windows®\)](#)

## Scan Photos and Graphics Using ControlCenter4 Advanced Mode (Windows®)

Send scanned photos or graphics directly to your computer.

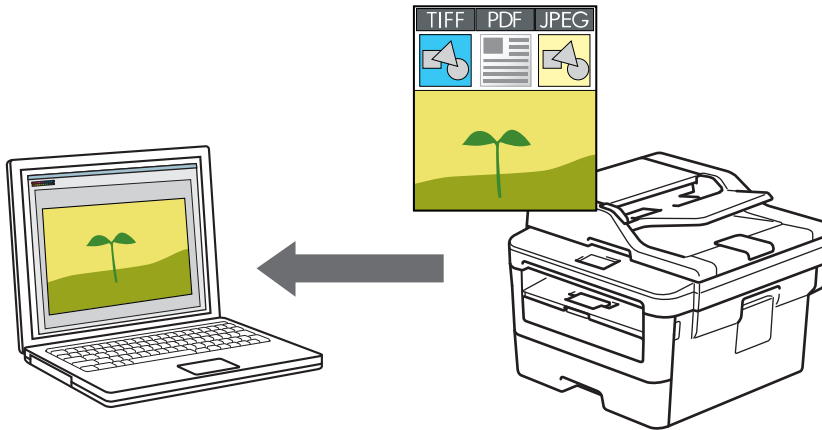

Select **Advanced Mode** as the mode setting for ControlCenter4.

1. Load your document.
2. Click the  (ControlCenter4) icon in the task tray, and then click **Open**.
3. Click the **Scan** tab.



4. Click the **Image** button.  
The scan settings dialog box appears.

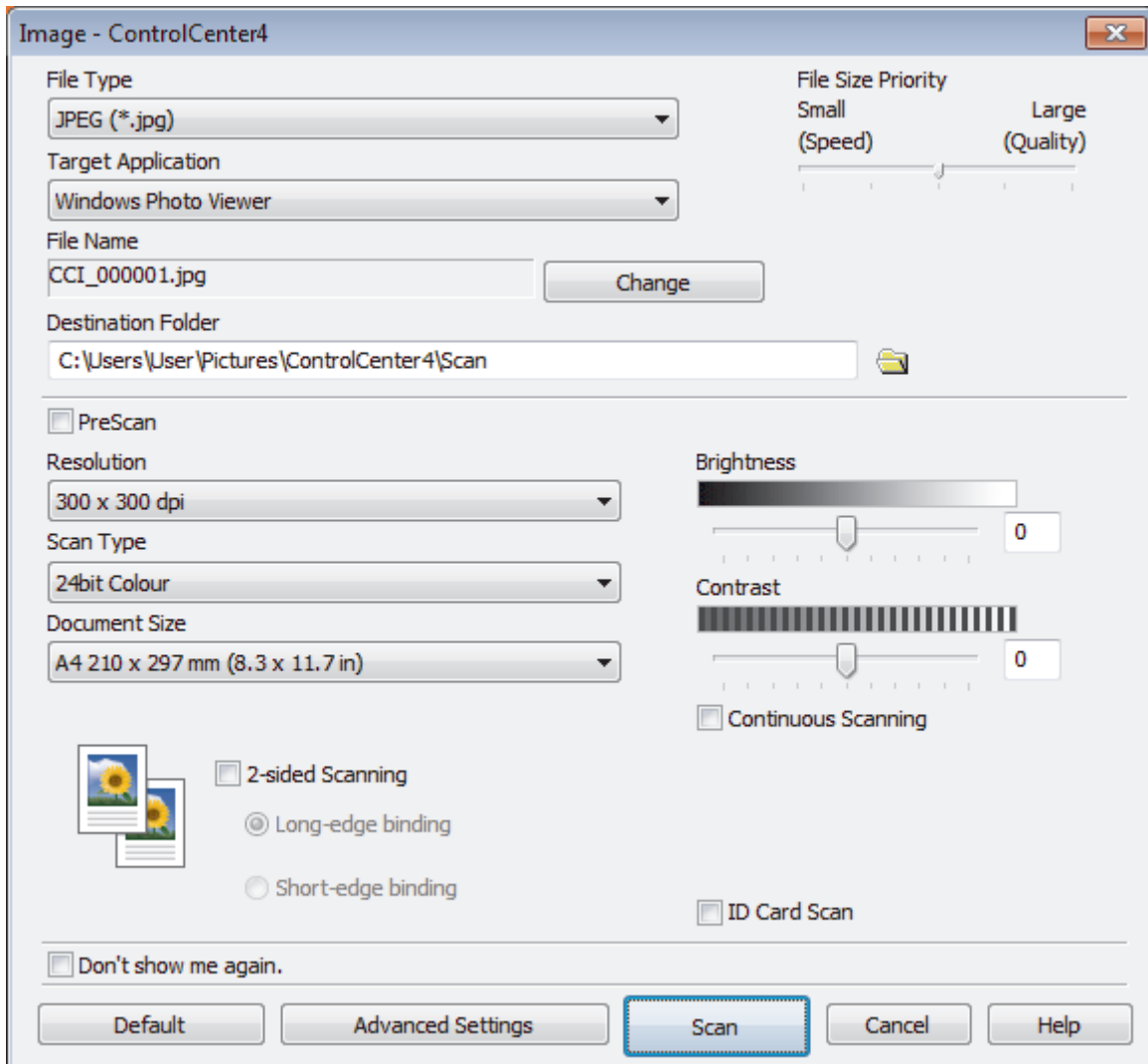

5. Change the scan settings, such as file format, file name, destination folder, resolution and colour, if needed.



- To change the file name, click **Change**.
- To change **Destination Folder**, click the folder icon.
- To preview and configure the scanned image, select the **PreScan** check box.

6. Click **Scan**.

The machine starts scanning. The image opens in the application you have selected.



### Related Information

- [Scan Using ControlCenter4 Advanced Mode \(Windows®\)](#)

Home > Scan > Scan from Your Computer (Windows®) > Scan Using ControlCenter4 Advanced Mode (Windows®) > Save Scanned Data to a Folder as a PDF File Using ControlCenter4 Advanced Mode (Windows®)

## Save Scanned Data to a Folder as a PDF File Using ControlCenter4 Advanced Mode (Windows®)

Scan documents and save them to a folder on your computer as PDF files.

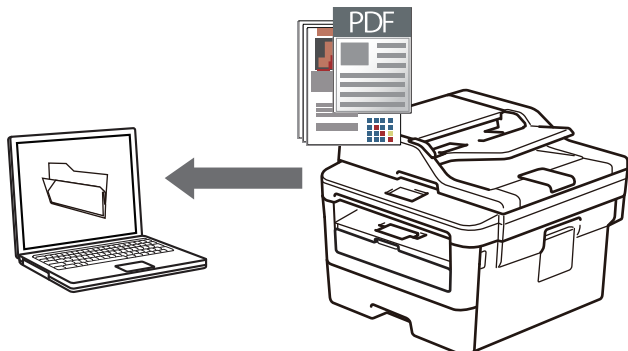

Select **Advanced Mode** as the mode setting for ControlCenter4.

1. Load your document.
2. Click the  (ControlCenter4) icon in the task tray, and then click **Open**.
3. Click the **Scan** tab.

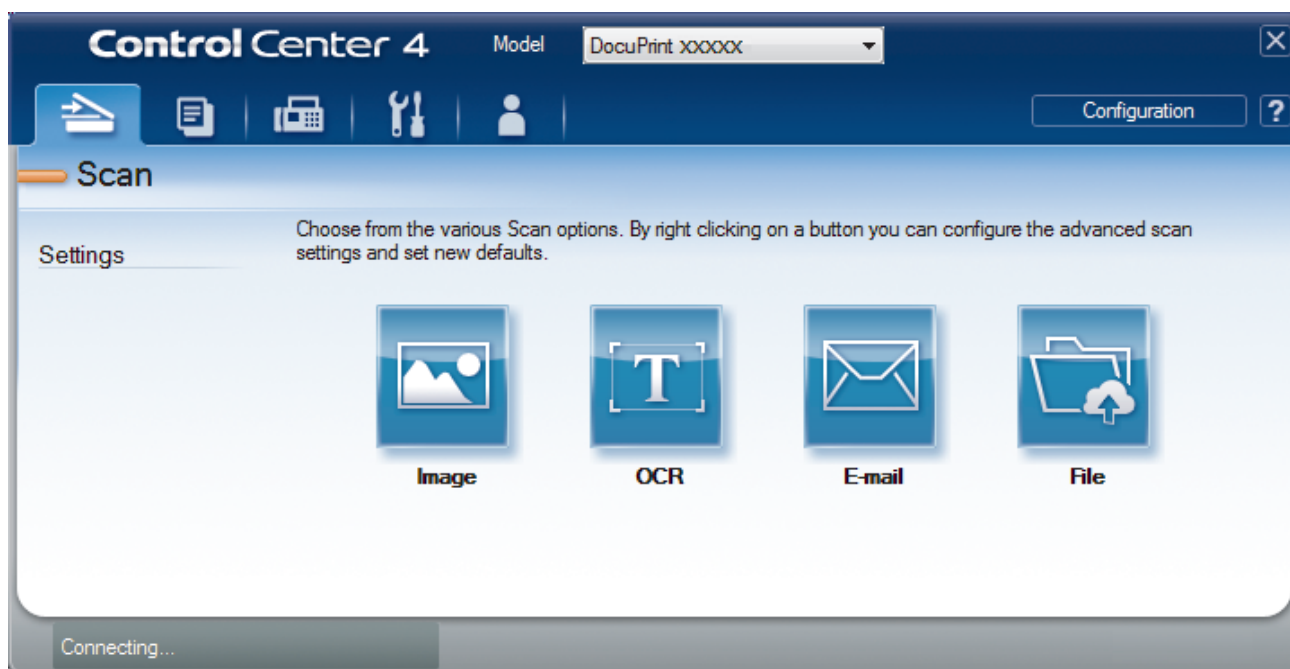

- Click the **File** button.

The scan settings dialog box appears.

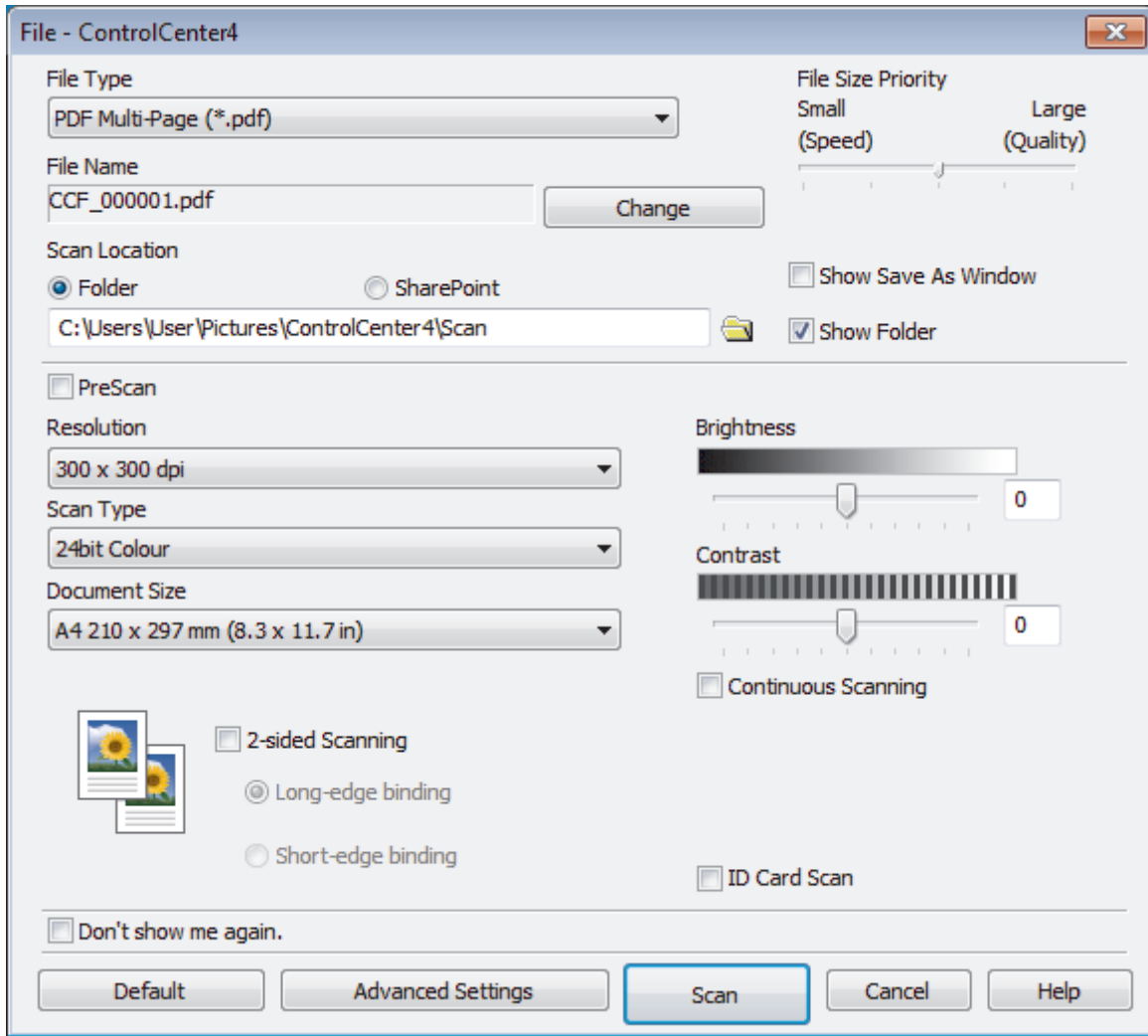

- Click the **File Type** drop-down list, and then select a PDF file.



To save the document as a password-protected PDF, select **Secure PDF Single-Page (\*.pdf)** or **Secure PDF Multi-Page (\*.pdf)** from the **File Type** drop-down list, click , and then type the password.

- Click the folder icon to browse and select the folder where you want to save your scanned documents.
- Change the scan settings, such as file format, file name, resolution and colour, if needed.



To preview and configure the scanned image, select the **PreScan** check box.

- Click **Scan**.

The machine starts scanning. The file is saved in the folder you selected.



## Related Information

- [Scan Using ControlCenter4 Advanced Mode \(Windows®\)](#)

## Scan Both Sides of a Document Automatically Using ControlCenter4 Advanced Mode (Windows®)

**Related Models:** DocuPrint M275 z/DocuPrint M285 z

Select **Advanced Mode** as the mode setting for ControlCenter4.

1. Load documents in the ADF.



To scan both sides of a document automatically, you must use the ADF, not the flatbed scanner glass.

2. Click the  (**ControlCenter4**) icon in the task tray, and then click **Open**.
3. Click the **Scan** tab.

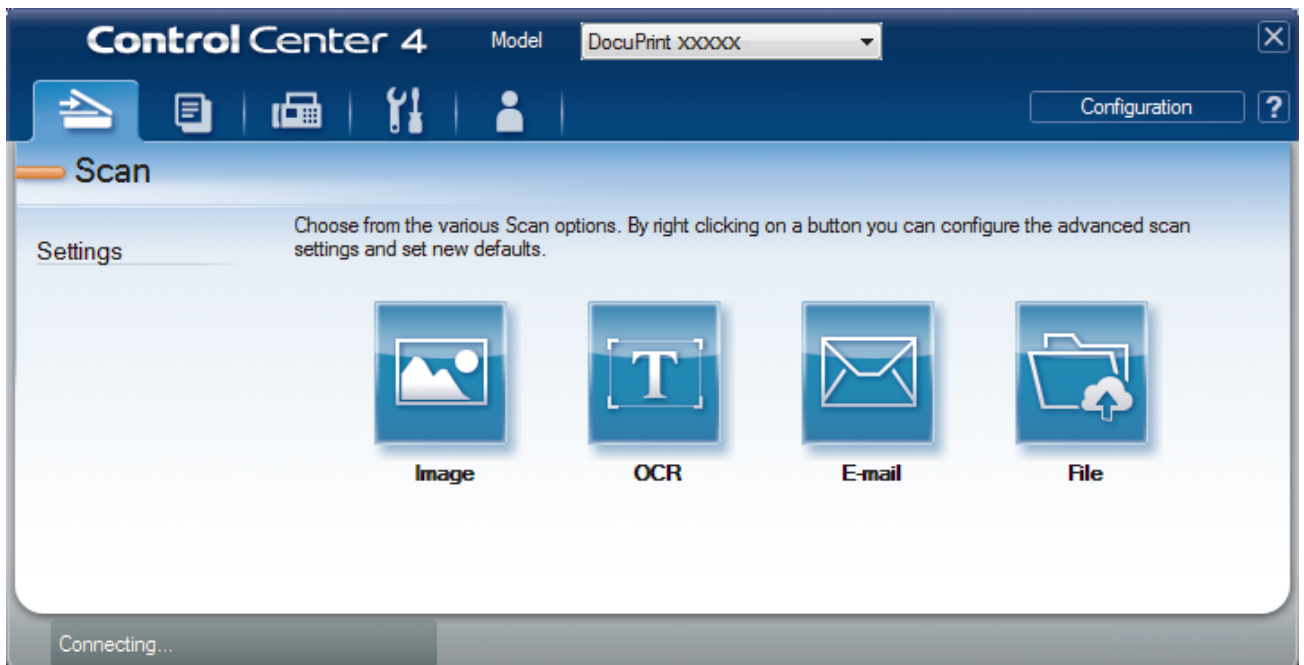

4. Click the button for the setting you want to change (**Image**, **OCR**, **E-mail**, or **File**).  
The scan settings dialog box appears.
5. Select the **2-sided Scanning** check box.
6. Select the **Long-edge binding** or **Short-edge binding** option, depending on the Original layout.
7. Change the scan settings, such as file format, file name, destination folder, resolution and colour, if needed.



- To change the file name, click **Change**.
- To change **Destination Folder**, click the folder icon.

8. Click **Scan**.  
The machine starts scanning.

You have now changed the default settings for your selected Scan to action. These settings will be used the next time one of the scan options (**Image**, **OCR**, **E-mail**, or **File**) is selected for this action.

### Related Information

- [Scan Using ControlCenter4 Advanced Mode \(Windows®\)](#)



## Scan Both Sides of an ID Card Using ControlCenter4 Advanced Mode (Windows®)

Select **Advanced Mode** as the mode setting for ControlCenter4.

1. Place an ID card on the scanner glass.
2. Click the  (ControlCenter4) icon in the task tray, and then click **Open**.
3. Click the **Scan** tab.

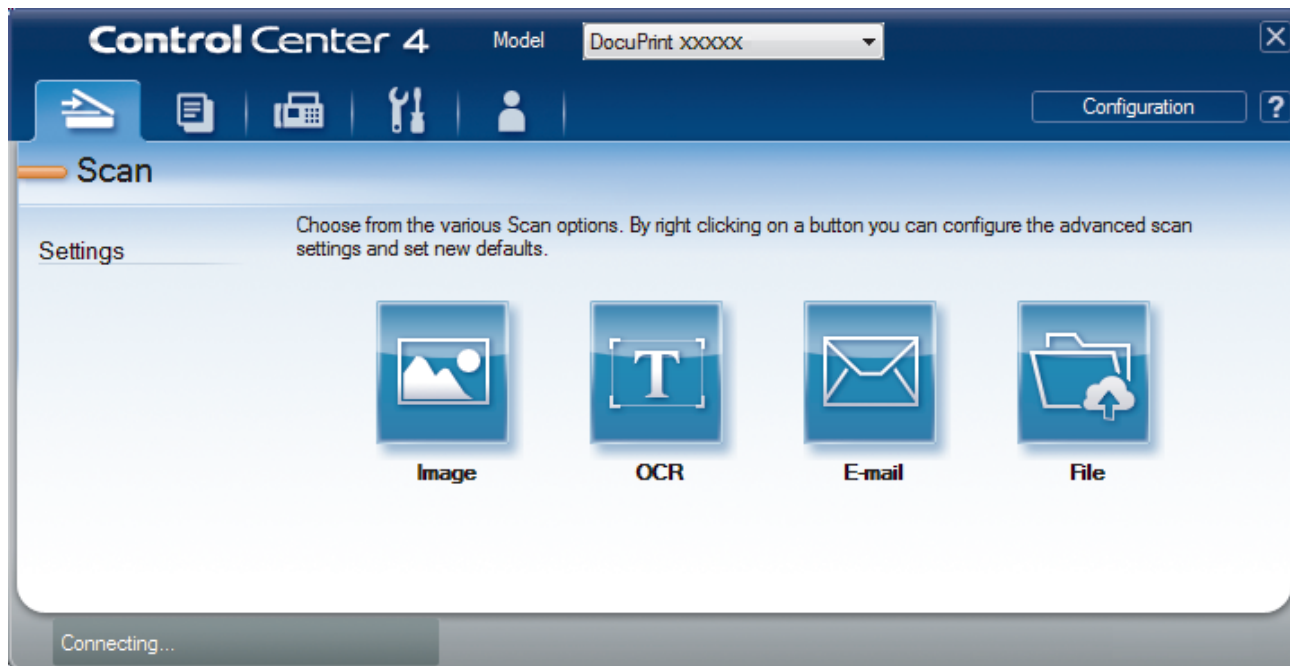

- Click the **File** button.

The scan settings dialog box appears.

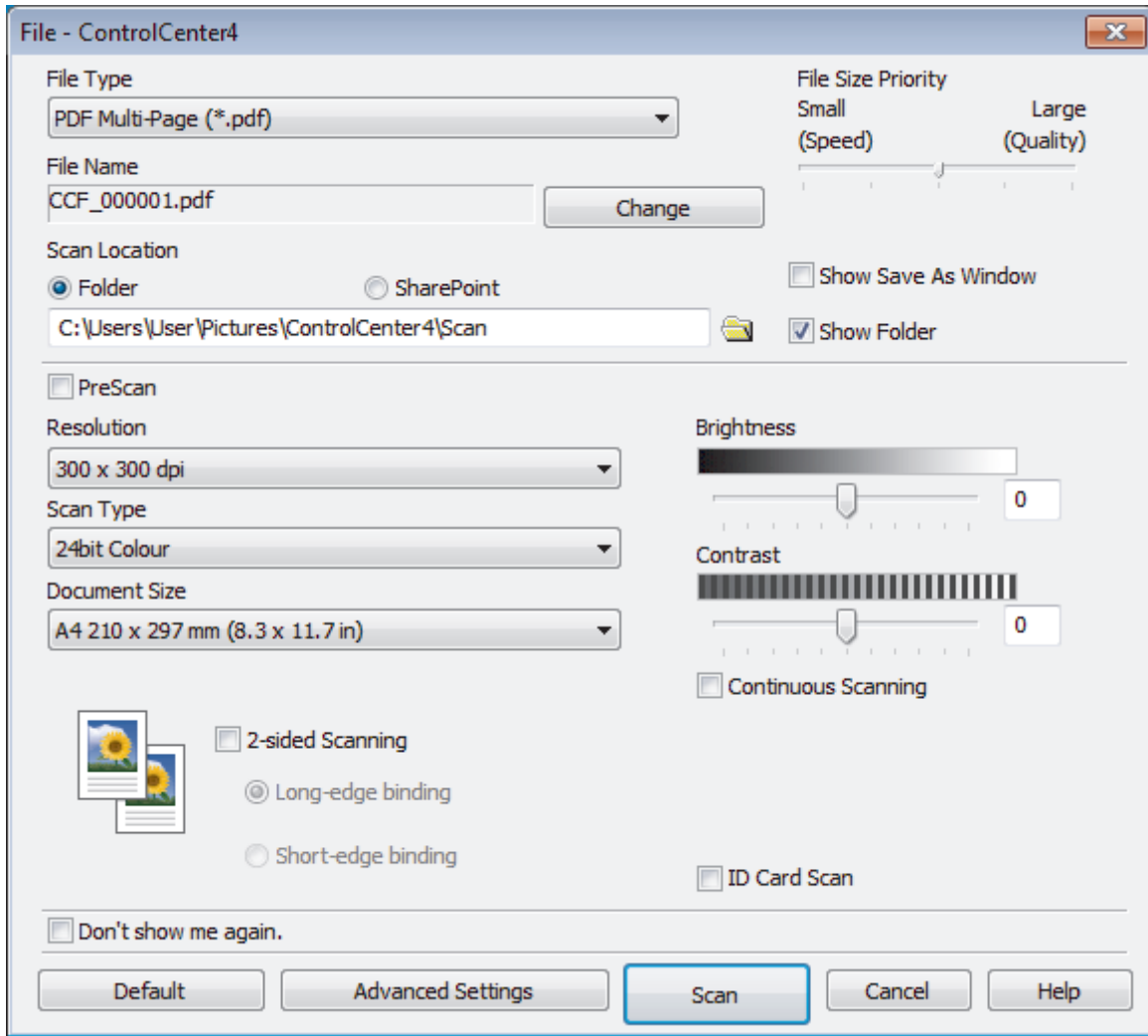

- Select the **ID Card Scan** check box.

The instruction dialog box appears.

- Read the instructions on the screen, and then click **OK**.
- Change the scan settings, such as file format, file name, scan location, resolution and colour, if needed.
- Click **Scan**.

The machine starts scanning one side of the identification card.

- After the machine has scanned one side, turn over the identification card, and then click **Continue** to scan the other side.
- Click **Finish**.



## Related Information

- [Scan Using ControlCenter4 Advanced Mode \(Windows®\)](#)

## Scan to Email Attachment Using ControlCenter4 Advanced Mode (Windows®)

Send a scanned document as an email attachment.

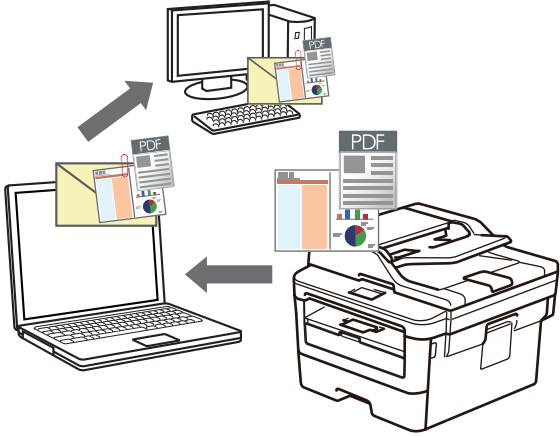

- Select **Advanced Mode** as the mode setting for ControlCenter4.
- The Scan to Email feature does not support Webmail services. Use the Scan to Image or Scan to File feature to scan a document or a picture, and then attach the scanned file to an email message.



The machine scans to your default email client.

1. Load your document.
2. Click the  (**ControlCenter4**) icon in the task tray, and then click **Open**.
3. Click the **Scan** tab.



4. Click the **E-mail** button.  
The scan settings dialog box appears.

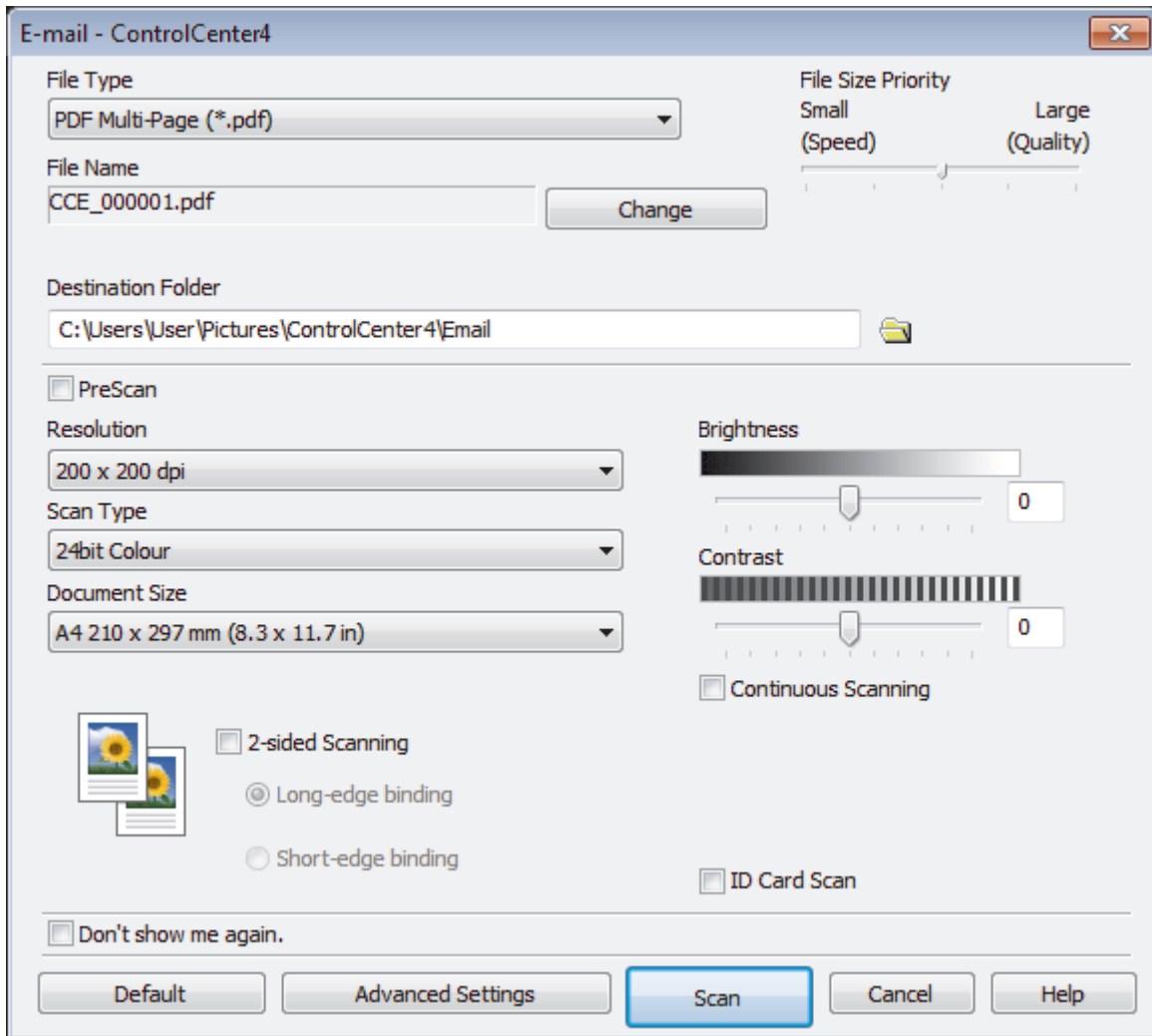

5. Change the scan settings, such as file format, file name, destination folder, resolution and colour, if needed.



- To change the file name, click **Change**.
- To change **Destination Folder**, click the folder icon.
- To preview and configure the scanned image, select the **PreScan** check box.

6. Click **Scan**.

The machine starts scanning. Your default email application opens and the scanned image is attached to a new, blank email message.



### Related Information

- [Scan Using ControlCenter4 Advanced Mode \(Windows®\)](#)

## Scan to an Editable Text File (OCR) Using ControlCenter4 Advanced Mode (Windows®)

Your machine can convert characters in a scanned document to text using optical character recognition (OCR) technology. You can edit this text using your preferred text-editing application.

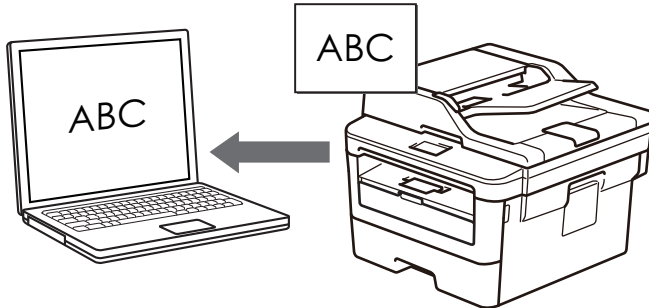

- Select **Advanced Mode** as the mode setting for ControlCenter4.

1. Load your document.
2. Click the  (**ControlCenter4**) icon in the task tray, and then click **Open**.
3. Click the **Scan** tab.



4. Click the **OCR** button.  
The scan settings dialog box appears.

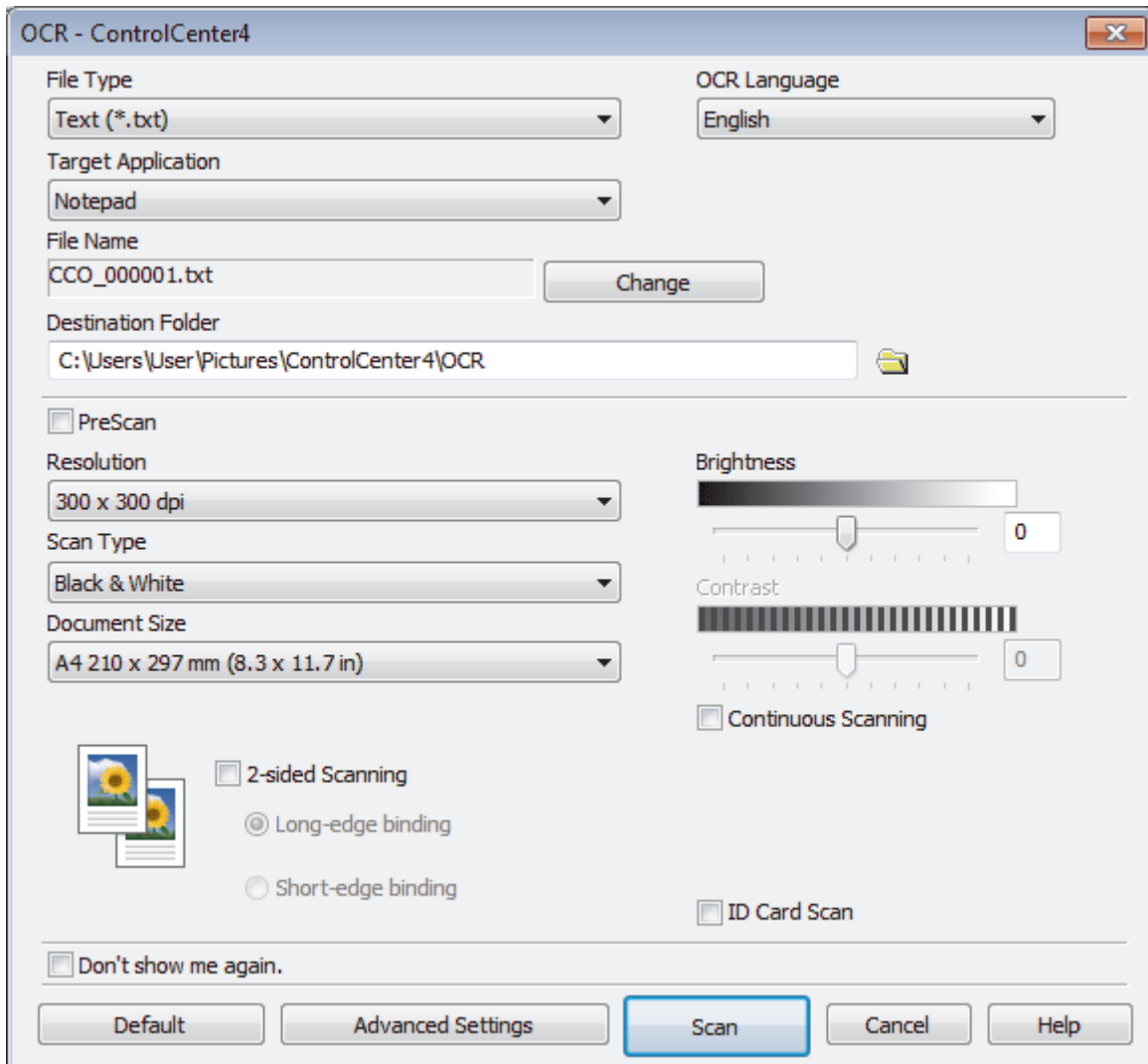

5. Change the scan settings, such as file format, file name, destination folder, resolution and colour, if needed.



- To change the file name, click **Change**.
- To change **Destination Folder**, click the folder icon.
- To preview and configure the scanned image, select the **PreScan** check box.

6. Click **Scan**.

The machine scans the document, converts it to editable text, and then sends it to your default word processing application.



### Related Information

- [Scan Using ControlCenter4 Advanced Mode \(Windows®\)](#)

## Scan Settings for ControlCenter4 Advanced Mode (Windows®)

| Settings                            | Applicable Features |     |        |      |
|-------------------------------------|---------------------|-----|--------|------|
|                                     | Image               | OCR | E-mail | File |
| File Type                           | Yes                 | Yes | Yes    | Yes  |
| Target Application                  | Yes                 | Yes | -      | -    |
| OCR Language                        | -                   | Yes | -      | -    |
| File Name                           | Yes                 | Yes | Yes    | Yes  |
| Scan Location or Destination Folder | Yes                 | Yes | Yes    | Yes  |
| Show Folder                         | -                   | -   | -      | Yes  |
| Show Save As Window                 | -                   | -   | -      | Yes  |
| File Size Priority                  | Yes                 | -   | Yes    | Yes  |
| PreScan                             | Yes                 | Yes | Yes    | Yes  |
| Resolution                          | Yes                 | Yes | Yes    | Yes  |
| Scan Type                           | Yes                 | Yes | Yes    | Yes  |
| Document Size                       | Yes                 | Yes | Yes    | Yes  |
| Brightness                          | Yes                 | Yes | Yes    | Yes  |
| Contrast                            | Yes                 | Yes | Yes    | Yes  |
| Continuous Scanning                 | Yes                 | Yes | Yes    | Yes  |
| 2-sided Scanning                    | Yes                 | Yes | Yes    | Yes  |
| ID Card Scan                        | Yes                 | Yes | Yes    | Yes  |
| Advanced Settings                   | Yes                 | Yes | Yes    | Yes  |
| Default                             | Yes                 | Yes | Yes    | Yes  |

### File Type

Select the file type you want to use for the scanned data.

#### For Image, Email and File

- **Windows Bitmap (\*.bmp)**
- **JPEG (\*.jpg)** (recommended for most users when scanning pictures)
- **TIFF Single-Page (\*.tif)**
- **TIFF Multi-Page (\*.tif)**
- **Portable Network Graphics (\*.png)**
- **PDF Single-Page (\*.pdf)** (recommended for scanning and sharing documents)
- **PDF Multi-Page (\*.pdf)** (recommended for scanning and sharing documents)
- **PDF/A Single-Page (\*.pdf)** (recommended for scanning and sharing documents)
- **PDF/A Multi-Page (\*.pdf)** (recommended for scanning and sharing documents)
- **High Compression PDF Single-Page (\*.pdf)**
- **High Compression PDF Multi-Page (\*.pdf)**
- **Secure PDF Single-Page (\*.pdf)**
- **Secure PDF Multi-Page (\*.pdf)**
- **Searchable PDF Single-Page (\*.pdf)**
- **Searchable PDF Multi-Page (\*.pdf)**

- 
- **XML Paper Specification (\*.xps)** (the XML Paper Specification is available for Windows® 7, Windows® 8 and Windows® 10, and when using applications that support XML Paper Specification files)

#### For OCR

- **HTML 3.2 (\*.htm)**
- **HTML 4.0 (\*.htm)**
- **Microsoft Excel 2003, XP (\*.xls)**
- **RTF Word 2000 (\*.rtf)**
- **WordPad (\*.rtf)**
- **WordPerfect 9, 10 (\*.wpd)**
- **Text (\*.txt)**
- **Searchable PDF Single-Page (\*.pdf)**
- **Searchable PDF Multi-Page (\*.pdf)**

#### Target Application

Select the destination application from the drop-down list.

#### OCR Language

Set the OCR language to match the language of the scanned document's text.

#### File Name

Click **Change** to change the file name's prefix.

#### Scan Location

Select the **Folder** or **SharePoint** radio button to specify the destination where you want to save your scanned documents.

#### Destination Folder

Click the folder icon to browse and select the folder where you want to save your scanned documents.

#### Show Folder

Select this option to automatically display the destination folder after scanning.

#### Show Save As Window

Select this option to specify the scanned image's destination every time you scan.

#### File Size Priority

Adjust the data compression ratio of the scanned image. Change the file size by moving the **File Size Priority** slider to the right or left.

#### PreScan

Select **PreScan** to preview your image and crop unwanted portions before scanning.

#### Resolution

Select a scanning resolution from the **Resolution** drop-down list. Higher resolutions take more memory and transfer time, but produce a finer scanned image.

#### Scan Type

Select from a range of scan colour depths.

- **Auto**  
Use for any type of document. This mode automatically picks an appropriate colour depth for the document.
- **Black & White**  
Use for text or line art images.
- **Grey (Error Diffusion)**  
Use for photographic images or graphics. (Error Diffusion is a method for creating simulated grey images without using true grey dots. Black dots are put in a specific pattern to give a grey appearance.)



---

- **True Grey**

Use for photographic images or graphics. This mode is more accurate because it uses up to 256 shades of grey.

- **24bit Colour**

Use to create an image with the most accurate colour reproduction. This mode uses up to 16.8 million colours to scan the image, but it requires the most memory and has the longest transfer time.

### Document Size

Select the exact size of your document from the **Document Size** drop-down list.

- If you select the **1 to 2 (A4)** option, the scanned image will be divided into two A5-size documents.

### Brightness

Set the **Brightness** level by dragging the slider to the right or left to lighten or darken the image. If the scanned image is too light, set a lower brightness level and scan the document again. If the image is too dark, set a higher brightness level and scan the document again. You can also type a value into the field to set the **Brightness** level.

### Contrast

Increase or decrease the **Contrast** level by moving the slider to the right or left. An increase emphasises dark and light areas of the image, while a decrease reveals more details in grey areas. You can also type a value into the field to set the **Contrast** level.

### Continuous Scanning

Select this option to scan multiple pages. After a page is scanned, select either continue scanning or finish.

### 2-sided Scanning

Select this check box to scan both sides of the document. When using the Automatic 2-sided Scan feature, you must select the **Long-edge binding** or **Short-edge binding** option, depending on the layout of your original, to make sure the data file you create appears correctly.

(DocuPrint M275 z/DocuPrint M285 z)

### ID Card Scan

Select this check box to scan both sides of an identification card onto one page.

### Advanced Settings

Configure advanced settings by clicking the **Advanced Settings** button in the Scan Settings dialog box.

- **Remove Bleed-through / Pattern**

- **Remove Background Colour**

- Remove the base colour of documents to make the scanned data more legible.

- **Rotate Image**

- Rotate the scanned image.

- **Skip Blank Page**

- Remove the document's blank pages from the scanning results.

- **Display Scanning Results**

- Show the numbers of total pages saved and blank pages skipped on your computer screen.

- **ADF Auto Deskew**

- When scanning the document from the ADF, the machine corrects skewing of the document automatically.

### Default

Select this option to restore all settings to their factory setting values.



## Related Information

- [Scan Using ControlCenter4 Advanced Mode \(Windows®\)](#)



## Scan Using Nuance™ PaperPort™ 14SE or Other Windows® Applications

You can use the Nuance™ PaperPort™ 14SE application for scanning.

- To install the Nuance™ PaperPort™ 14SE application, launch the Fuji Xerox installation disc, click **Install** in the **Additional Software** section.
- Nuance™ PaperPort™ 14SE supports Windows® 7, Windows® 8, Windows® 8.1 and Windows® 10.
- For detailed instructions on using each application, click the application's **Help** menu, and then click **Getting Started Guide** in the **Help** ribbon.



The instructions for scanning in these steps are for PaperPort™ 14SE. For other Windows® applications, the steps will be similar. PaperPort™ 14SE supports both TWAIN and Windows Image Acquisition (WIA) drivers; the TWAIN driver (recommended) is used in these steps.

1. Load your document.
2. Start PaperPort™ 14SE.  
Do one of the following:
  - Windows® 7  
Using your computer, click  (**Start**) > **All Programs** > **Nuance PaperPort 14** > **PaperPort**.
  - Windows® 8  
Click  (**PaperPort**).
  - Windows® 10  
Click  **Nuance PaperPort 14** > **PaperPort**.
3. Click the **Desktop** menu, and then click **Scan Settings** in the **Desktop** ribbon.  
The **Scan or Get Photo** panel appears on the left side of the screen.
4. From the available Scanners list, select **TWAIN: TW-FX DocuPrint XXXXX** or **TWAIN: TW-FX DocuPrint XXXXX LAN** (where XXXXX is the model name of your machine). To use the Windows Image Acquisition (WIA) driver, select the Fuji Xerox driver that has "Windows Image Acquisition (WIA)" as the prefix.
5. Select the **Display scanner dialog box** check box in the **Scan or Get Photo** panel.
6. Click **Scan**.  
The Scanner Setup dialog box appears.

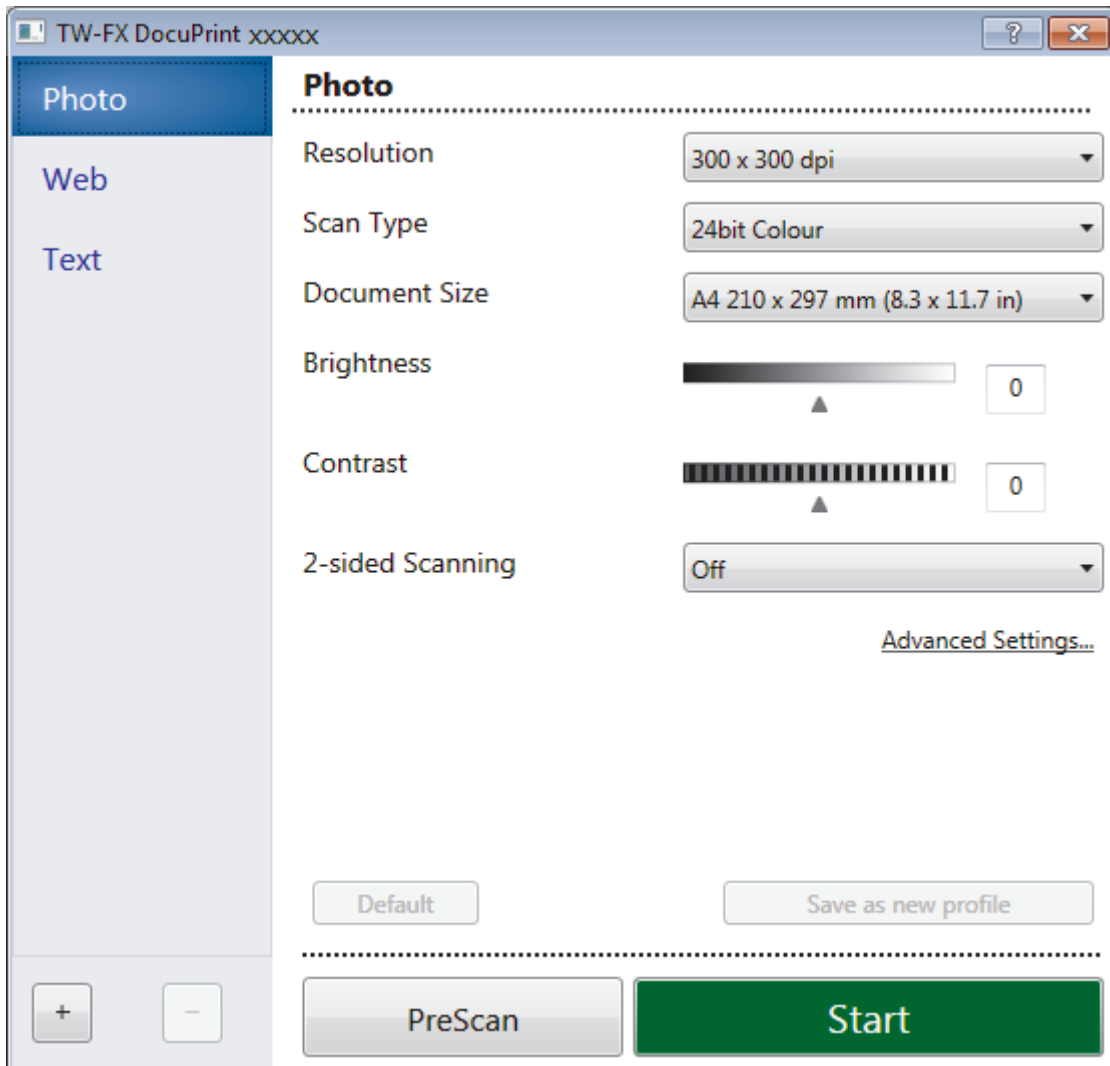

7. Adjust the settings in the Scanner Setup dialog box, if needed.
8. Click the **Document Size** drop-down list, and then select your document size.



To scan both sides of the document (DocuPrint M275 z/DocuPrint M285 z):  
Automatic 2-sided scan is available only when using the ADF.  
You cannot use PreScan to preview an image.

9. Click **PreScan** if you want to preview your image and crop unwanted portions before scanning.
10. Click **Start**.  
The machine starts scanning.



### Related Information

- [Scan from Your Computer \(Windows®\)](#)
- [TWAIN Driver Settings \(Windows®\)](#)

## TWAIN Driver Settings (Windows®)

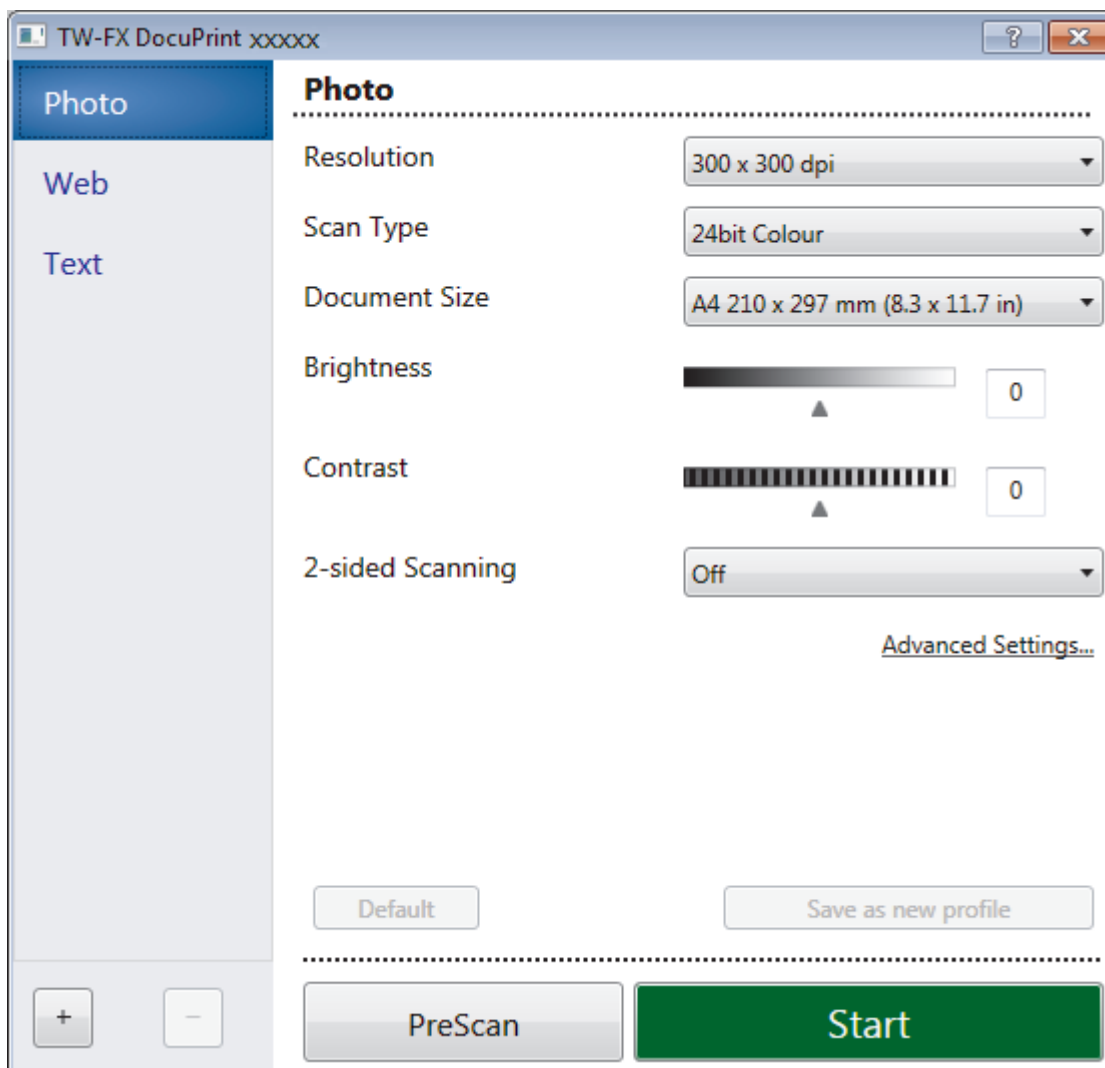

- Note that the item names and assignable values will vary depending on the machine.
- The **Contrast** option is available only when selecting the **Grey (Error Diffusion)**, **True Grey**, or **24bit Colour** options from the **Scan Type** settings.

### 1. Scan

Select the **Photo**, **Web**, or **Text** option depending on the type of document you want to scan.

| Scan (Image Type) |   | Resolution    | Scan Type                |
|-------------------|---|---------------|--------------------------|
| <b>Photo</b>      | Use for scanning photo images.                    | 300 x 300 dpi | <b>24bit Colour</b>      |
| <b>Web</b>        | Use for attaching the scanned image to web pages. | 100 x 100 dpi | <b>24bit Colour</b>      |
| <b>Text</b>       | Use for scanning text documents.                  | 200 x 200 dpi | <b>Black &amp; White</b> |

### 2. Resolution

Select a scanning resolution from the **Resolution** drop-down list. Higher resolutions take more memory and transfer time, but produce a finer scanned image.

### 3. Scan Type

Select from a range of scan colour depths.

- **Black & White**

Use for text or line art images.

- **Grey (Error Diffusion)**

Use for photographic images or graphics. (Error Diffusion is a method for creating simulated grey images without using true grey dots. Black dots are put in a specific pattern to give a grey appearance.)

- **True Grey**

Use for photographic images or graphics. This mode is more accurate because it uses up to 256 shades of grey.

- **24bit Colour**

Use to create an image with the most accurate colour reproduction. This mode uses up to 16.8 million colours to scan the image, but it requires the most memory and has the longest transfer time.

#### 4. Document Size

Select the exact size of your document from a selection of preset scan sizes.

If you select **Custom**, the **Custom Document Size** dialog box appears and you can specify the document size.

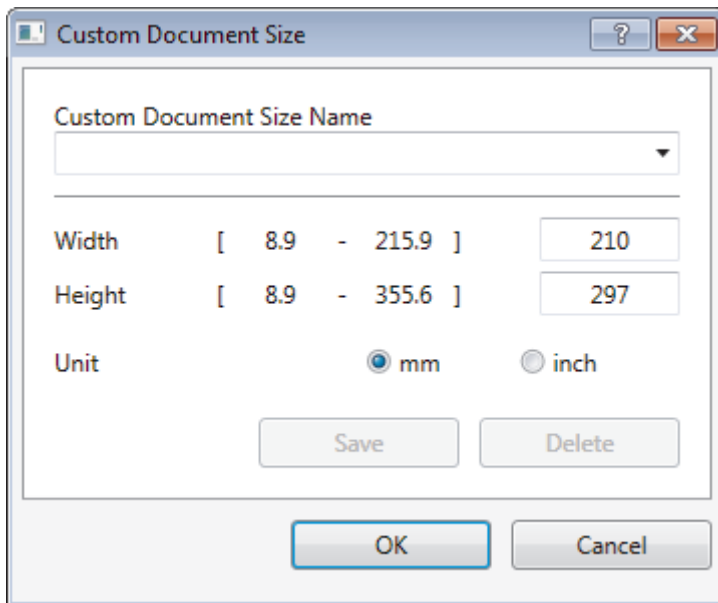

#### 5. Brightness

Set the **Brightness** level by dragging the slider to the right or left to lighten or darken the image. If the scanned image is too light, set a lower brightness level and scan the document again. If the image is too dark, set a higher brightness level and scan the document again. You can also type a value in the field to set the brightness level.

#### 6. Contrast

Increase or decrease the **Contrast** level by moving the slider to the right or left. An increase emphasises dark and light areas of the image, while a decrease reveals more details in grey areas. You can also type a value in the field to set the contrast level.

#### 7. 2-sided Scanning

Scan both sides of the document. When using the Automatic 2-sided Scan feature, you must select the **Long-edge binding** or **Short-edge binding** option from the **2-sided Scanning** drop-down list, so when you turn the pages, they are facing the way you want.

(DocuPrint M275 z/DocuPrint M285 z)

#### 8. Advanced Settings

Configure advanced settings by clicking the **Advanced Settings** button in the Scan Settings dialog box.

- **Paper**

- **Auto Deskew**

Set the machine to correct document skewing automatically as the pages are scanned from the ADF.

- **Rotate Image**

---

Rotate the scanned image.

- **Enhancement**

- **Background Processing**

- **Remove Bleed-through / Pattern**

- Prevent bleed-through.

- **Remove Background Colour**

- Remove the base colour of documents to make the scanned data more legible.

- **Colour Drop**

- Select a colour to remove from the scanned image.

- **Boldface Formatting**

- Emphasise the characters of the original by making them bold.

- **Blurred Character Correction**

- Correct the broken or incomplete characters of the original to make them easier to read.

- **Edge Emphasis**

- Make the characters of the original sharper.

- **Reduce Noise**

- Improve and enhance the quality of your scanned images with this selection. The **Reduce Noise** option is available when selecting the **24bit Colour** option and the **300 x 300 dpi**, **400 x 400 dpi**, or **600 x 600 dpi** scan resolution.

- **Paper Handling**

- **Edge Fill**

- Fill in the edges on four sides of the scanned image using the selected colour and range.

- **Continuous scan**

- Select this option to scan multiple pages. After a page is scanned, select either continue scanning or finish.



## Related Information

- [Scan Using Nuance™ PaperPort™ 14SE or Other Windows® Applications](#)
-

## Scan Using Windows® Fax and Scan

Windows® Fax and Scan application is another option that you can use for scanning.

- Windows® Fax and Scan uses the Windows Image Acquisition (WIA) scanner driver.
- If you want to crop a portion of a page after pre-scanning the document, you must scan using the scanner glass (also called the flatbed).

1. Load your document.
2. Launch Windows® Fax and Scan.
3. Click **File > New > Scan**.
4. Select the scanner you want to use.
5. Click **Import** or **OK**.

The **New Scan** dialog box appears.

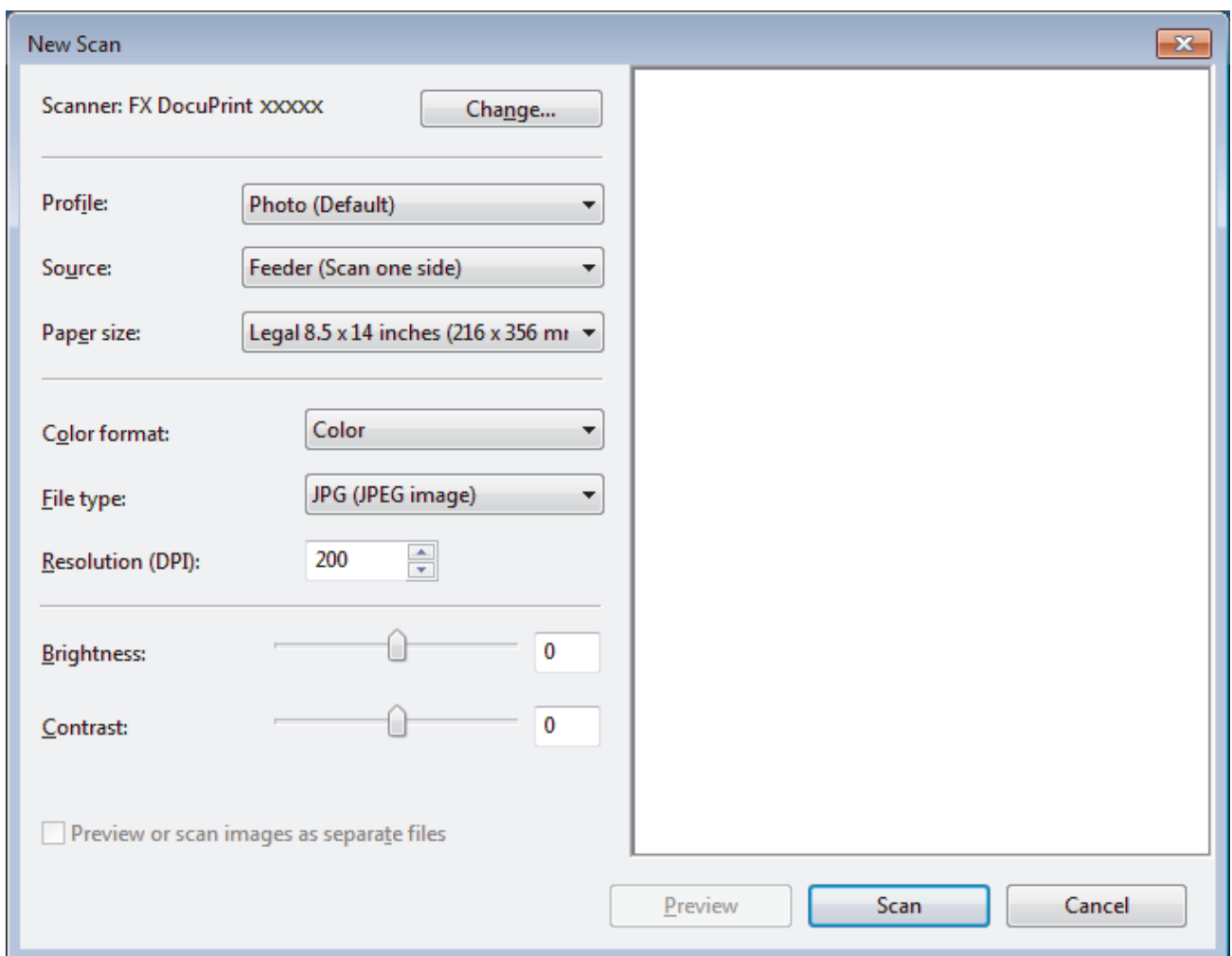

6. Adjust the settings in the Scanner Setup dialog box, if needed.

The scanner resolution can be set to a maximum of 1200 dpi. If you want to scan at higher resolutions, use the **Scanner Utility** software of **Fuji Xerox Utilities**.

If your machine supports 2-sided Scan and you want to scan both sides of your document, select **Feeder (Scan both sides)** as **Source**.

7. Click **Scan**.

The machine starts scanning the document.



## Related Information

- [Scan from Your Computer \(Windows®\)](#)
- [Windows Image Acquisition \(WIA\) Driver Settings \(Windows®\)](#)



## Windows Image Acquisition (WIA) Driver Settings (Windows®)

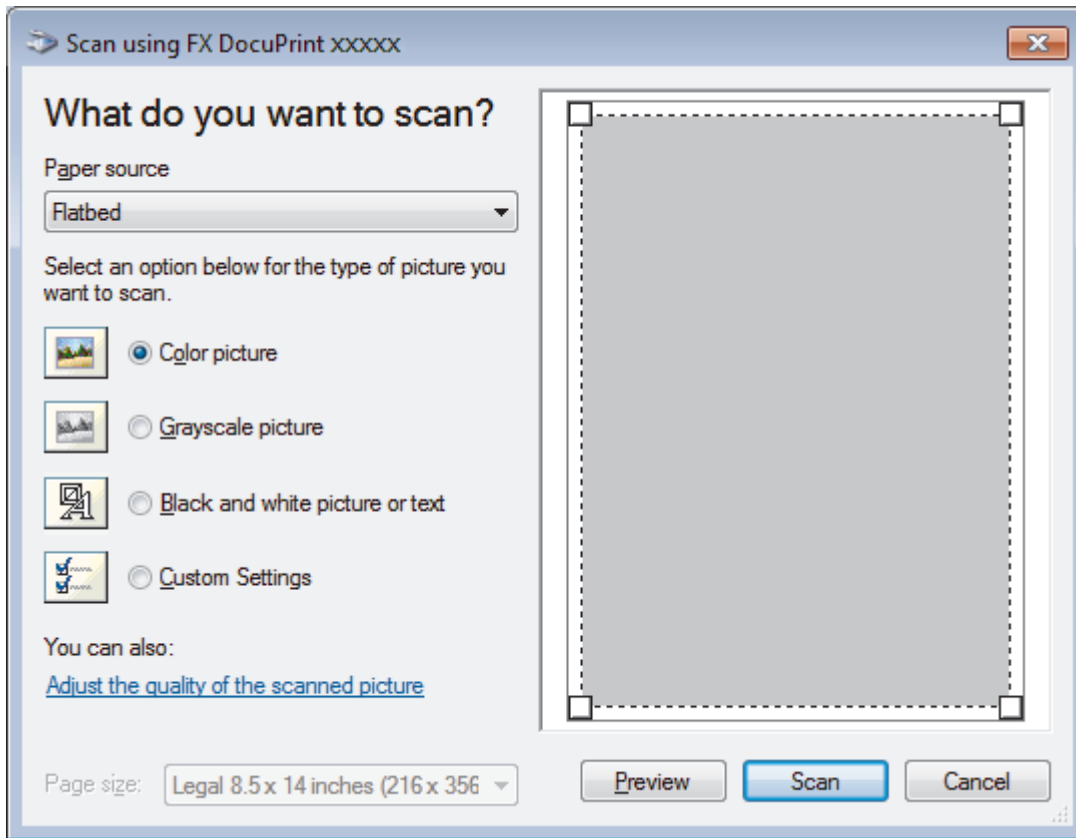

### Paper source

Select the **Document Feeder** or **Flatbed** option from the drop-down list.

### Picture Type (Image Type)

Select **Color picture**, **Grayscale picture**, **Black and white picture or text**, or **Custom Settings** for the type of document you want to scan.

To change advanced settings, click the **Adjust the quality of the scanned picture** link.

### Page size

The **Page size** option is available if you select the **Document Feeder** as the **Paper source** option.

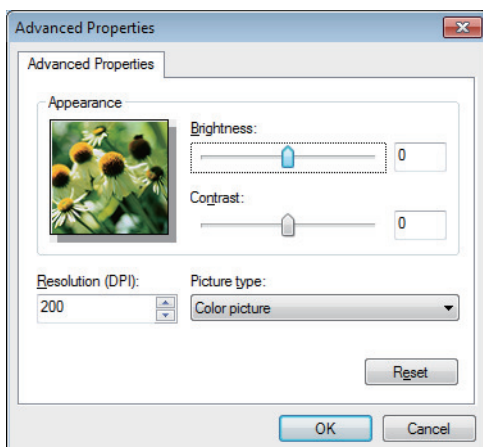

### Brightness

Set the **Brightness** level by dragging the slider to the right or left to lighten or darken the image. If the scanned image is too light, set a lower brightness level and scan the document again. If the image is too dark, set a higher brightness level and scan the document again.

---

## Contrast

Increase or decrease the **Contrast** level by moving the slider to the right or left. An increase emphasises dark and light areas of the image, while a decrease reveals more details in grey areas. You can also type a value in the field to set the contrast level.

## Resolution (DPI)

Select a scanning resolution from the **Resolution (DPI)** list. Higher resolutions take more memory and transfer time, but produce a finer scanned image.



## Related Information

- [Scan Using Windows® Fax and Scan](#)

## Scan from Your Computer (Mac)

There are several ways you can use your Mac to scan photos and documents on your Fuji Xerox machine. Use the software applications provided by Fuji Xerox or your favourite scanning application.

- [Scan Using iPrint&Scan \(Mac\)](#)
- [Scan Using TWAIN-Compliant Applications \(Mac\)](#)
- [Scan Using AirPrint](#)

## Scan Using iPrint&Scan (Mac)

1. In the **Finder** menu bar, click **Go > Applications > Fuji Xerox**, and then double-click the iPrint&Scan icon. The iPrint&Scan screen appears.
2. If your Fuji Xerox machine is not selected, click the **Select your Machine** button, and then follow the on-screen instructions to select your Fuji Xerox machine.
3. Click the **Scan** icon, and then follow the on-screen instructions to scan your documents.



### Related Information

- [Scan from Your Computer \(Mac\)](#)
  - [iPrint&Scan for Mac](#)
  - [Change Scan Button Settings from iPrint&Scan \(Mac\)](#)
-

## Scan Using TWAIN-Compliant Applications (Mac)

You can also scan using TWAIN-compliant applications. For more information about the scanning procedure, see the manual for your application.

To use Fuji Xerox TWAIN Driver, go to the download page for your model on the Fuji Xerox website at <http://www.fujixeroxprinters.com/> and download Scanner Driver.

1. Start your graphics application, and then select the scan operation.  
The scanner setup dialog box appears.

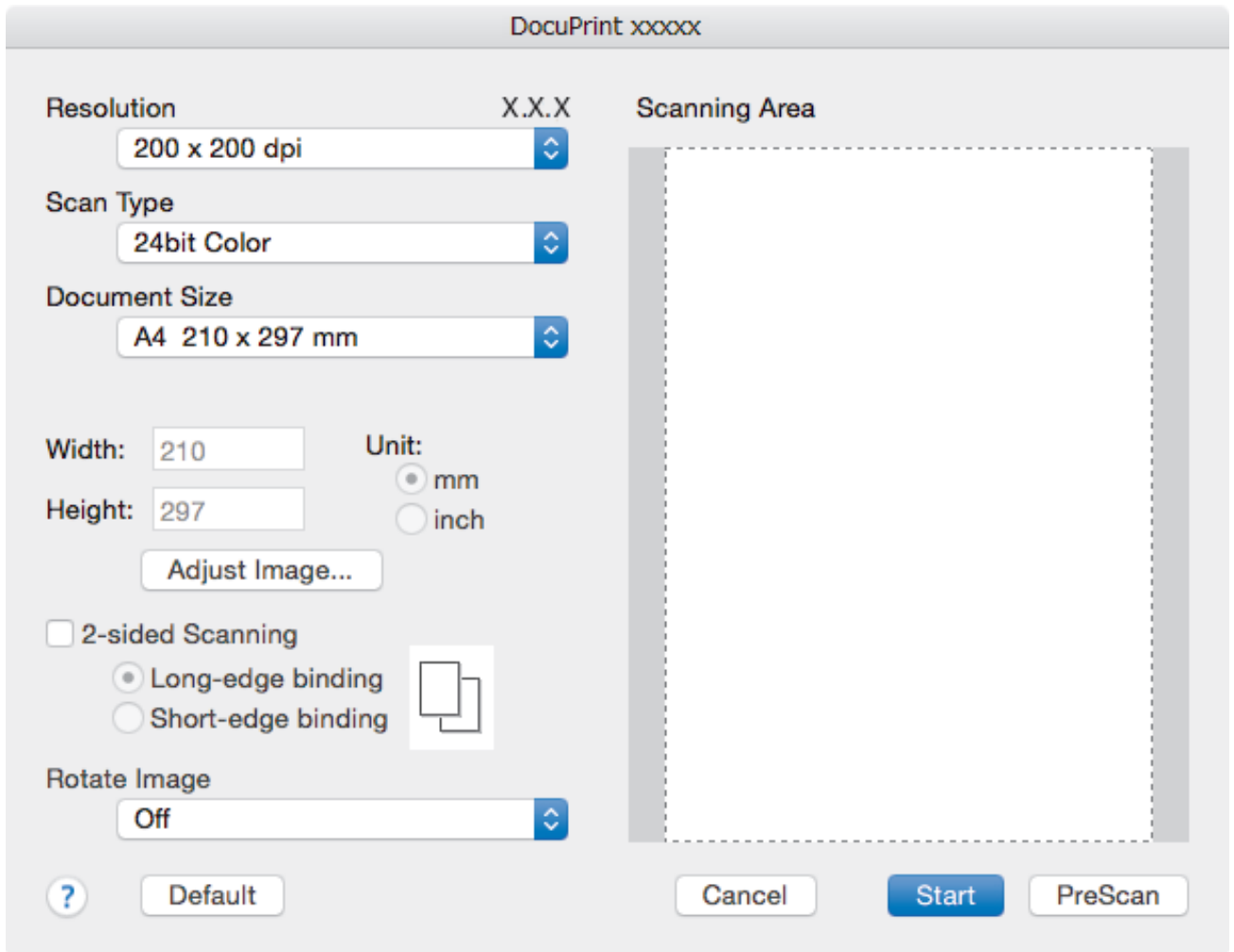

2. Change the scan settings, such as **Resolution**, **Scan Type**, or **Adjust Image**, if needed.
3. Click the **Document Size** pop-up menu, and then select your document size.
4. Click the **PreScan** option to preview your image and crop unwanted portions before scanning.



- After you select a document size, adjust the scanning area by holding down the mouse button and dragging your mouse pointer over the portion you want to scan.
- To scan both sides of the document (DocuPrint M275 z/DocuPrint M285 z):  
Automatic 2-sided scan is available only when using the ADF.  
You cannot adjust the scanning area.  
You cannot use PreScan to preview an image.

5. Click **Start**.  
The machine starts scanning.



## Related Information

- [Scan from Your Computer \(Mac\)](#)
  - [TWAIN Driver Settings \(Mac\)](#)
-

## TWAIN Driver Settings (Mac)



- Item names and assignable values will vary depending on the machine.
- The **Contrast** setting is available only when selecting **Gray (Error Diffusion)**, **True Gray**, or **24bit Color** from the **Scan Type** options.

### 1. Resolution

Select a scanning resolution from the **Resolution** pop-up menu. Higher resolutions take more memory and transfer time, but produce a finer scanned image.

### 2. Scan Type

Select from a range of scan colour depths.

- **Black & White**  
Use for text or line art images.
- **Gray (Error Diffusion)**  
Use for photographic images or graphics. (Error Diffusion is a method for creating simulated grey images without using true grey dots. Black dots are put in a specific pattern to give a grey appearance.)
- **True Gray**  
Use for photographic images or graphics. This mode is more accurate because it uses up to 256 shades of grey.

- **24bit Color**

Use to create an image with the most accurate colour reproduction. This mode uses up to 16.8 million colours to scan the image, but it requires the most memory and has the longest transfer time.

### 3. Document Size

Select the exact size of your document from a selection of preset scan sizes.

- If you select **Custom**, you can specify the document size.

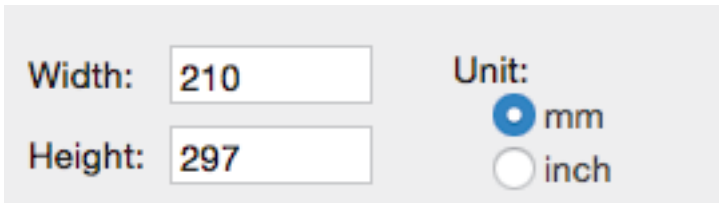

### 4. Adjust Image

Click the **Adjust Image** button to adjust other image qualities.

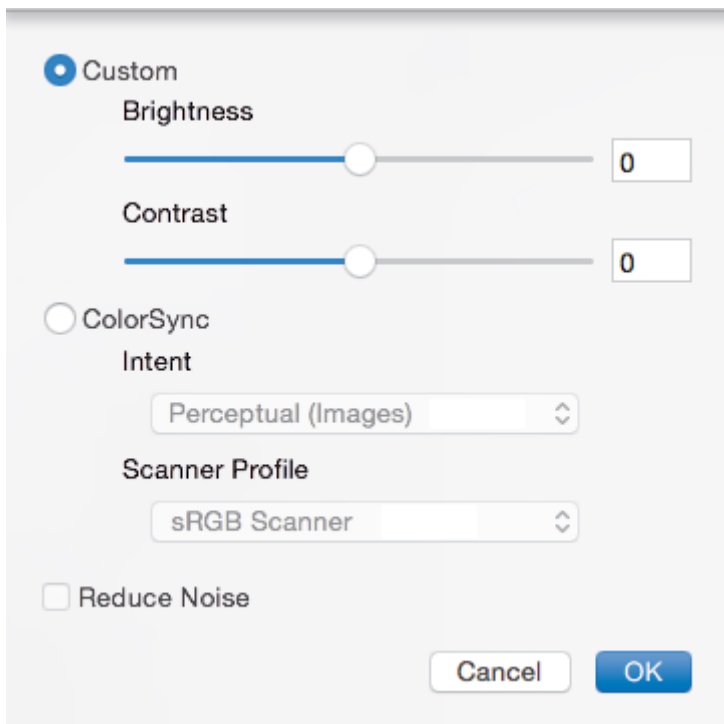

#### Brightness

Set the **Brightness** level by dragging the slider to the right or left to lighten or darken the image. If the scanned image is too light, set a lower brightness level and scan the document again. If the image is too dark, set a higher brightness level and scan the document again. You can also type a value in the box to set the brightness.

#### Contrast

Increase or decrease the **Contrast** level by moving the slider to the right or left. An increase emphasises dark and light areas of the image, while a decrease reveals more details in grey areas. You can also type a value in the box to set the contrast.

#### Reduce Noise

Improve and enhance the quality of your scanned images with this selection. The **Reduce Noise** option is available when selecting the **24bit Color** option and the **300 x 300 dpi**, **400 x 400 dpi**, or **600 x 600 dpi** scan resolutions.

### 5. 2-sided Scanning

If you select this check box, the machine scans both sides of the document. When using the Automatic 2-sided Scan feature, you must select the **Long-edge binding** or **Short-edge binding** option, depending on the layout of your original, to make sure the created data file appears correctly.

(Available only for certain models)



---

## 6. Rotate Image

Rotate the scanned image.



### Related Information

- [Scan Using TWAIN-Compliant Applications \(Mac\)](#)
-

## Configure Scan Settings Using Web Based Management

- [Set the Scan File Name Using Web Based Management](#)

## Set the Scan File Name Using Web Based Management

Set up a file name for scanned data using Web Based Management.

1. Start your web browser.

Type "http://machine's IP address" in your browser's address bar (where "machine's IP address" is the IP address of the machine or the print server name). For example: http://192.168.1.2

No password is required by default. If you have previously set a password, type it, and then click .

2. Click the **Scan** tab.
3. Click the **Scan File Name** menu in the left navigation bar.
4. Select the **File Name Style** from the drop-down list.
5. If you selected the option to include the date in **File Name Style** field, select the **Date** format from the drop-down list.
6. In the **Time** fields, select **On** to include the time information in the file name.
7. In the **Counter** field, select **Continuous** or **Reset after each job**.



When you select **Reset after each job**, duplication of file names may occur.

8. If you want to create a user-defined file name prefix, type a file name in the user-defined fields of each scan function.



Using the following characters: ?, /, \, or \* may cause a sending error.

9. Click **Submit**.



### Related Information

- [Configure Scan Settings Using Web Based Management](#)

## Copy

- [Copy a Document](#)
- [Enlarge or Reduce Copied Images](#)
- [Make N in 1 Copies Using the Page Layout Feature](#)
- [Sort Copies](#)
- [Copy an ID Card](#)
- [Copy on Both Sides of the Paper \(2-sided Copy\)](#)
- [Copy Options](#)

## Copy a Document

>> [DocuPrint M235 dw/DocuPrint M235 z](#)

>> [DocuPrint M275 z/DocuPrint M285 z](#)

### DocuPrint M235 dw/DocuPrint M235 z

1. Make sure you have loaded the correct size paper in the paper tray.
2. Do one of the following:
  - Place the document *face up* in the ADF. (available only for certain models)  
(If you are copying multiple pages, we recommend using the ADF.)

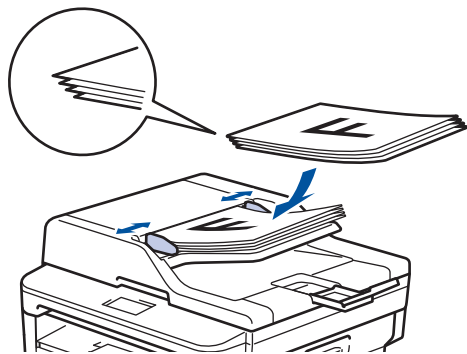

- Place the document *face down* on the scanner glass.

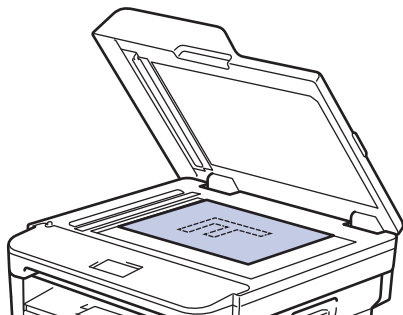

3. Do one of the following:
  - For DocuPrint M235 z  
Press  (**Copy**).  
Use the dial pad to enter the number of copies you want.
  - For DocuPrint M235 dw  
Press ▲ or ▼ to enter the number of copies you want.

The LCD displays:

```
Stack Copies:01
100%■■■■ Auto
```

4. Press **Start**.

### DocuPrint M275 z/DocuPrint M285 z

1. Make sure you have loaded the correct size paper in the paper tray.

2. Do one of the following:

- Place the document *face up* in the ADF.  
(If you are copying multiple pages, we recommend using the ADF.)

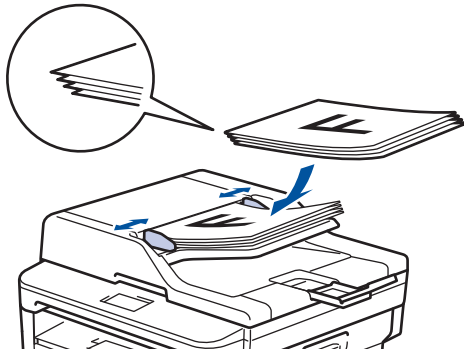

- Place the document *face down* on the scanner glass.

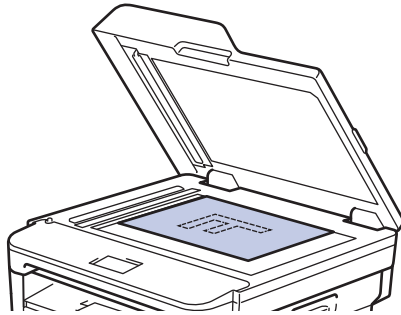

3. Press  ([Copy]).

The LCD displays:

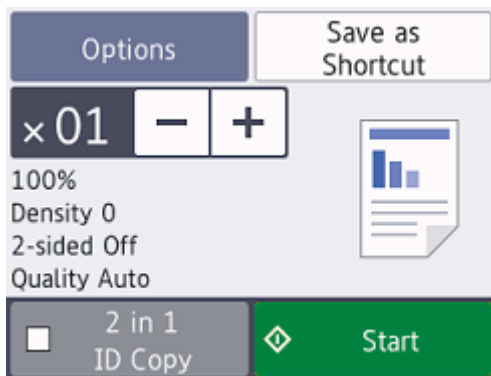

4. To enter the number of copies you want, do one of the following:

- Press [-] or [+] using the LCD.
- Use the dial pad.
- Press **x01** to display a numeric keypad on the LCD, and then enter the number of copies. Press [OK].

5. Press [Start].

## ✓ Related Information

- [Copy](#)

## Enlarge or Reduce Copied Images

Select an enlargement or reduction ratio to resize your copied data.

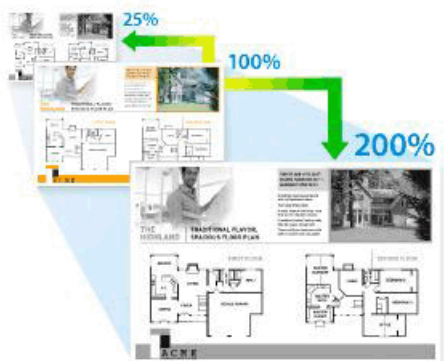

>> [DocuPrint M235 dw/DocuPrint M235 z](#)

>> [DocuPrint M275 z/DocuPrint M285 z](#)



### DocuPrint M235 dw/DocuPrint M235 z

1. Load your document.
2. Do one of the following:
  - For DocuPrint M235 z  
Press  (**Copy**).  
Use the dial pad to enter the number of copies you want.
  - For DocuPrint M235 dw  
Press ▲ or ▼ to enter the number of copies you want.
3. Press **Options** or **Copy/Scan Options**.
4. Press ▲ or ▼ to select [Enlarge/Reduce], and then press **OK**.
5. Press ▲ or ▼ to select the enlargement or reduction ratio you want, and then press **OK**.
  - If you select [Custom (25-400%)], use the dial pad, or press ▲ or ▼ to enter an enlargement or reduction ratio from [25%] to [400%] and then press **OK**.
6. Press **Start**.



- 
- [Auto] sets the machine to calculate the reduction ratio that best fits the size of paper.
  - [Auto] is only available when using the ADF.
- 

### DocuPrint M275 z/DocuPrint M285 z

1. Load your document.
2. Press  ([Copy]).
3. Enter the number of copies.
4. Press [Options].
5. Press ▲ or ▼ to display the [Enlarge/Reduce] option, and then press [Enlarge/Reduce].
6. Press ▲ or ▼ to display the available options, and then press the option you want to change.
7. Do one of the following:
  - If you select [Enlarge] or [Reduce], press the enlargement or reduction ratio you want to use.
  - If you select [Custom (25-400%)], press  (backspace) to erase the displayed percentage, or press ◀ to move the cursor, and then enter an enlargement or reduction ratio from [25%] to [400%].

---

Press [OK].

- If you selected [100%] or the [Auto] option, go to the next step.

8. When finished, press [OK]. (If the [OK] button is displayed.)

9. Press [Start].



- 
- [Auto] sets the machine to calculate the reduction ratio that best fits the size of paper.
  - [Auto] is only available when using the ADF.
- 



## Related Information

- [Copy](#)
-



## Make N in 1 Copies Using the Page Layout Feature

The N in 1 copy feature saves paper by copying two or four pages of your document onto one page of the copy.



>> DocuPrint M235 dw/DocuPrint M235 z  
>> DocuPrint M275 z/DocuPrint M285 z



### DocuPrint M235 dw/DocuPrint M235 z

1. Load your document.
2. Do one of the following:
  - For DocuPrint M235 z  
Press  (**Copy**).  
Use the dial pad to enter the number of copies you want.
  - For DocuPrint M235 dw  
Press ▲ or ▼ to enter the number of copies you want.
3. Press **Options** or **Copy/Scan Options**.
4. Press ▲ or ▼ to select [Page Layout], and then press **OK**.
5. Press ▲ or ▼ to select [Off(1 in 1)], [2 in 1 (P)], [2 in 1 (L)], [4 in 1 (P)] or [4 in 1 (L)], and then press **OK**.
6. Press **Start**.  
If you placed the document in the ADF, the machine scans the pages and starts printing.  
**If you are using the scanner glass, go to the next step.**
7. Repeat the following steps for each page of the layout:
  - For DocuPrint M235 z
    - a. After the machine scans the page, press ▲ to scan the next page.
    - b. Place the next page on the scanner glass, and then press **OK** to scan the page.
  - For DocuPrint M235 dw  
After the machine scans the page, place the next page on the scanner glass, and then press ▲ to select the [Yes] option.
8. After scanning all the pages, press ▼ to select the [No] option.

### DocuPrint M275 z/DocuPrint M285 z

1. Load your document.

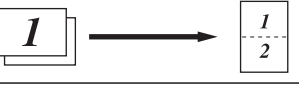
2. Press  ([Copy]).
3. Enter the number of copies.
4. Press [Options].
5. Press ▲ or ▼ to display the [Page Layout] option, and then press [Page Layout].
6. Press ▲ or ▼ to display the options, and then press the option you want.

| Option           | Description   |
|------------------|---|
| 2in1 (Portrait)  |  |
| 2in1 (Landscape) |  |
| 4in1 (Portrait)  |  |
| 4in1 (Landscape) |  |

7. When finished, press [OK].
8. Press [Start]. If you placed the document in the ADF, the machine scans the pages and starts printing.  
**If you are using the scanner glass, go to the next step.**
9. After the machine scans the page, place the next page on the scanner glass, and then press [Yes] to scan the next page.
10. When finished, press [No] to finish.

## ✓ Related Information

- [Copy](#)

## Sort Copies

Sort multiple copies. Pages will be stacked in the order they are fed, that is: 1, 2, 3, and so on.

>> [DocuPrint M235 dw/DocuPrint M235 z](#)

>> [DocuPrint M275 z/DocuPrint M285 z](#)

### DocuPrint M235 dw/DocuPrint M235 z

1. Load your document.
2. Do one of the following:
  - For DocuPrint M235 z  
Press  (**Copy**).  
Use the dial pad to enter the number of copies you want.
  - For DocuPrint M235 dw  
Press ▲ or ▼ to enter the number of copies you want.
3. Press **Options** or **Copy/Scan Options**.
4. Press ▲ or ▼ to select [Stack/Sort], and then press **OK**.
5. Press ▲ or ▼ to select [Sort], and then press **OK**.
6. Press **Start**.  
If you placed the document in the ADF, the machine scans the pages and starts printing.  
**If you are using the scanner glass, go to the next step.**
7. Repeat the following steps for each page:
  - For DocuPrint M235 z
    - a. After the machine scans the page, press ▲ to scan the next page.
    - b. Place the next page on the scanner glass, and then press **OK** to scan the page.
  - For DocuPrint M235 dw  
After the machine scans the page, place the next page on the scanner glass, and then press ▲ to select the [Yes] option.
8. After scanning all the pages, press ▼ to select the [No] option.

### DocuPrint M275 z/DocuPrint M285 z

1. Load your document.
2. Press  ([Copy]).
3. Enter the number of copies.
4. Press [Options].
5. Press ▲ or ▼ to display the [Stack/Sort] option, and then press [Stack/Sort].
6. Press [Sort].
7. When finished, press [OK].
8. Press [Start]. If you placed the document in the ADF, the machine scans the pages and starts printing.  
**If you are using the scanner glass, go to the next step.**
9. After the machine scans the page, place the next page on the scanner glass, and then press [Yes] to scan the next page.
10. When finished, press [No] to finish.



## Related Information

- [Copy](#)
-

## Copy an ID Card

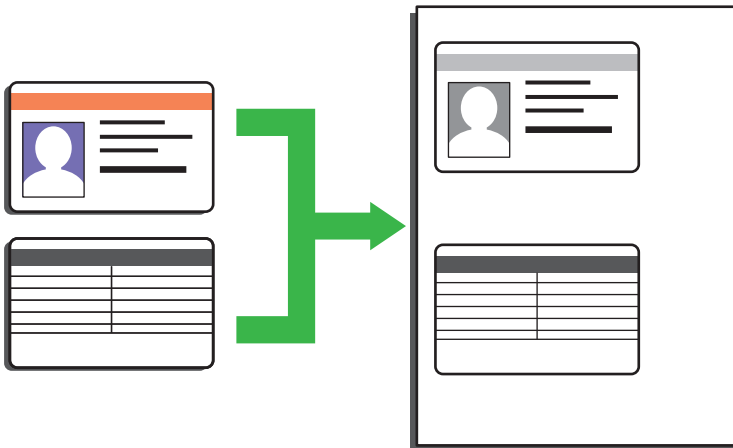

- You may copy an identification card only to the extent permitted under applicable laws. For more information, see the *Safety Guide*.

>> [DocuPrint M235 dw/DocuPrint M235 z](#)

>> [DocuPrint M275 z/DocuPrint M285 z](#)

### DocuPrint M235 dw/DocuPrint M235 z

- (DocuPrint M235 z) Press  (**Copy**).
- Place an identification card *face down* near the upper left corner of the scanner glass.

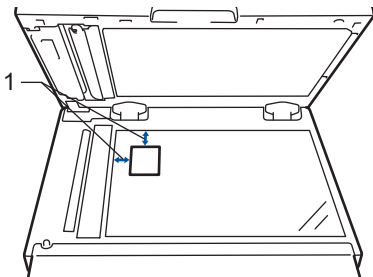

1 4.0 mm or greater (top, left)

- Press **2 in 1 (ID) Copy**.
- Do one of the following:
  - For DocuPrint M235 z  
Use the dial pad to enter the number of copies you want.
  - For DocuPrint M235 dw  
Press **▲** or **▼** to enter the number of copies you want.
- Press **Start**.  
The machine scans one side of the identification card.
- After the machine has scanned the first side, turn over the identification card.

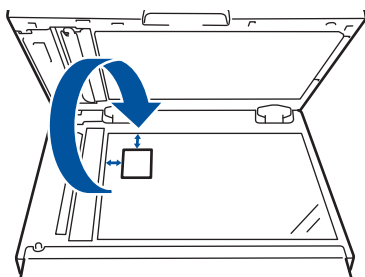

- Press **Start** to scan the other side.

## DocuPrint M275 z/DocuPrint M285 z

1. Place your identification card *face down* near the upper left corner of the scanner glass.

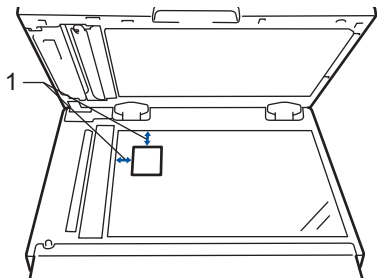

1 4.0 mm or greater (top, left)

2. Press  [Copy] > [2 in 1 ID Copy].

3. Enter the number of copies.

4. Press [Start].

The machine scans one side of the identification card.

5. After the machine has scanned the first side, turn over the identification card and press [Continue] to scan the other side.

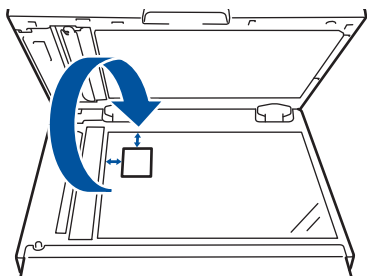

### Related Information

- [Copy](#)

## Copy on Both Sides of the Paper (2-sided Copy)

Reduce the amount of paper you use by copying onto both sides of the paper.

- You must choose a 2-sided copy layout from the following options before you can start 2-sided copying.
- The layout of your original document determines which 2-sided copy layout you should choose.
- To use the automatic 2-sided copy feature, you must load your document in the ADF.
- When you manually make 2 sided copies from a 2-sided document, use the scanner glass.
- Select A4 sized paper when using the 2-sided copy option.

### Portrait

#### 2-sided to 2-sided

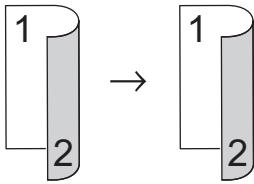

#### 1-sided to 2-sided (Long Edge Flip)

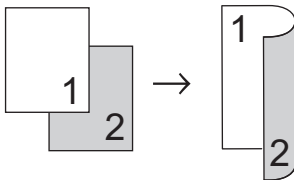

#### 1-sided to 2-sided (Short Edge Flip)

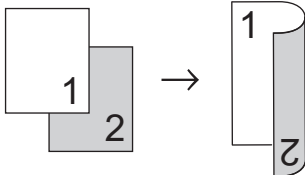

### Landscape

#### 2-sided to 2-sided

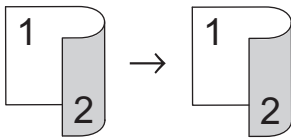

#### 1-sided to 2-sided (Long Edge Flip)

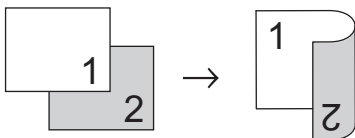

#### 1-sided to 2-sided (Short Edge Flip)

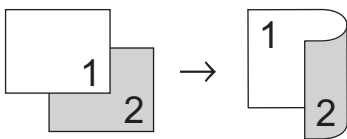

>> [DocuPrint M235 dw/DocuPrint M235 z](#)  
>> [DocuPrint M275 z/DocuPrint M285 z](#)

## DocuPrint M235 dw/DocuPrint M235 z

1. Load your document.

2. Do one of the following:
  - For DocuPrint M235 z  
Press  (**Copy**).  
Use the dial pad to enter the number of copies you want.
  - For DocuPrint M235 dw  
Press ▲ or ▼ to enter the number of copies you want.
3. Do one of the following:
  - Press **2-sided**.
  - Press **Options** or **Copy/Scan Options**.  
Press ▲ or ▼ to select [2-sided], and then press **OK**.
4. Press ▲ or ▼ to display [Layout Long] or [Layout Short], and then press **OK**.
5. Select flip on long edge or flip on short edge.
6. Press ▲ or ▼ to display [2sided → 2sided] or [1sided → 2sided], and then press **OK**.
7. Press **Start**.  
If you placed the document in the ADF, the machine scans the pages and starts printing.  
**If you are using the scanner glass, go to the next step.**
8. Repeat the following steps for each page of the layout:
  - For DocuPrint M235 z
    - a. After the machine scans the page, press ▲ to scan the next page.
    - b. Place the next page on the scanner glass, and then press **OK** to scan the page.
  - For DocuPrint M235 dw  
After the machine scans the page, place the next page on the scanner glass, and then press a to select the [Yes] option.
9. Press ▼ to select the [No] option.

## DocuPrint M275 z/DocuPrint M285 z

1. Load your document.
2. Press  ([Copy]).
3. Enter the number of copies.
4. Press [Options].
5. Press ▲ or ▼ to display the [2-sided Copy] option, and then press [2-sided Copy].
6. Press ▲ or ▼ to display the layout options, and then press the option you want.
7. When finished, press [OK].
8. Press [Start]. If you placed the document in the ADF, the machine scans the pages and starts printing.  
**If you are using the scanner glass, go to the next step.**
9. After the machine scans the page, place the next page on the scanner glass, and then press [Yes] to scan the next page.
10. After scanning all the pages, press [No] to finish.



### Related Information

- [Copy](#)



# Copy Options

## DocuPrint M235 dw/DocuPrint M235 z

To change Copy settings, press the **Options** or **Copy/Scan Options** button.

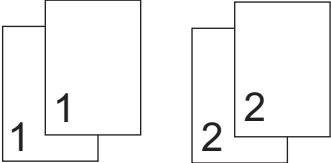
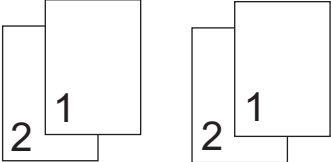
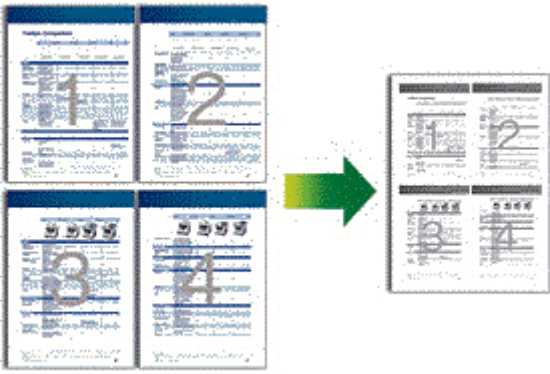
| Menu selections       | Options  |
|-----------------------|--|
| <b>Quality</b>        | Select the copy quality for your type of document.   |
| <b>Stack/Sort</b>     | <p>Select to stack or sort multiple copies.</p> <p><b>Stack</b></p>  <p><b>Sort</b></p>    |
| <b>Density</b>        | <p>Increase the brightness to make the text lighter.</p> <p>Decrease the brightness to make the text darker.</p>   |
| <b>Contrast</b>       | <p>Increase the contrast to make an image clearer.</p> <p>Decrease the contrast to make an image more subdued.</p>   |
| <b>Enlarge/Reduce</b> | <p>Select an enlargement or reduction ratio for the next copy.</p> <ul style="list-style-type: none"> <li>• <i>Auto</i> sets the machine to calculate the reduction ratio that best fits the size of paper.(for models with ADF)</li> <li>• If you select <i>Custom</i> (25-400%) , use the dial pad, or press ▲ or ▼ to enter an enlargement or reduction ratio.</li> </ul> |
| <b>Page Layout</b>    | <p>Make N in 1 copies.</p> <p><b>4 in1</b></p>   |

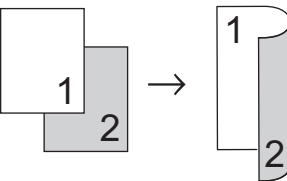
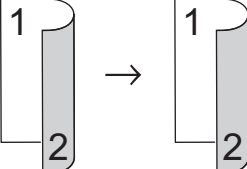
| Menu selections                                       | Options  |
|---|--|
| <b>2-sided</b><br>(available only for certain models) | Select to copy on both sides of the paper.<br><b>1-sided → 2-sided</b><br><br><b>2-sided → 2-sided</b><br> |

## DocuPrint M275 z/DocuPrint M285 z

To change Copy settings, press [Options].

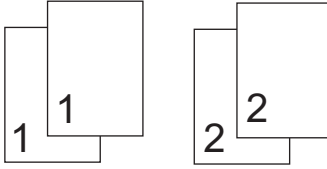
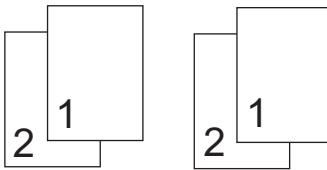
| Menu selections       | Options   |   |
|-----------------------|---|---|
| <b>Quality</b>        | Select the copy quality for your type of document.  |   |
| <b>Enlarge/Reduce</b> | 100%  | -   |
|                       | Enlarge   | Select an enlargement ratio for the next copy.            |
|                       | Reduce  | Select a reduction ratio for the next copy.               |
|                       | Auto  | Adjusts the copy size to fit the paper size you have set. |
|                       | Custom (25-400%)  | Enter an enlargement or reduction ratio.                  |
| <b>Density</b>        | Increase the density to make the text darker.<br>Decrease the density to make the text lighter.   |   |
| <b>Tray Use</b>       | Select a paper tray for the next copy.  |   |
| <b>Contrast</b>       | Increase the contrast to make an image clearer.<br>Decrease the contrast to make an image more subdued.   |   |
| <b>Stack/Sort</b>     | Select to stack or sort multiple copies.<br><b>Stack</b><br><br><b>Sort</b><br> |   |

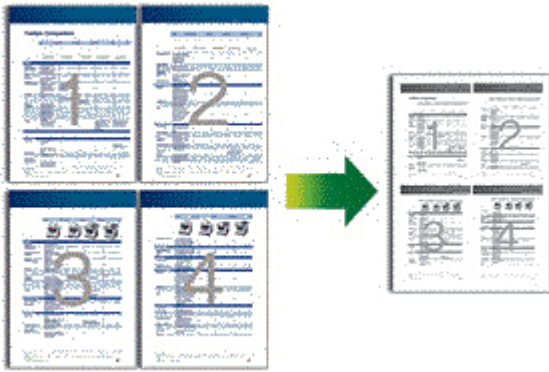
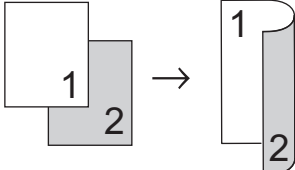
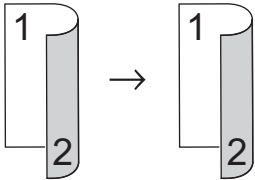
| Menu selections  | Options  |
|--|--|
| <b>Page Layout</b>   | <p>Make N in 1 copies.</p> <p><b>4 in1</b></p>   |
| <b>2-sided Copy</b>  | <p>Select to copy on both sides of the paper.</p> <p><b>1-sided → 2-sided</b></p>  <p><b>2-sided → 2-sided</b></p>  <p>The available options will vary depending on your model.</p> |
| <b>2-sided Copy Page Layout</b><br>(available only for certain settings) | Select long edge or short edge.  |
| <b>Save as Shortcut</b>  | Add the current settings as a shortcut.  |

 **Related Information**

- [Copy](#)

## Fax

- [Send a Fax](#)
- [Receive a Fax](#)
- [Voice Operations and Fax Numbers](#)
- [Telephone Services and External Devices](#)
- [Fax Reports](#)
- [PC-FAX](#)

## Send a Fax

- [Send a Fax](#)
- [Send a 2-sided Fax from the ADF](#)
- [Send a Fax Manually](#)
- [Send a Fax at the End of a Conversation](#)
- [Send the Same Fax to More than One Recipient \(Broadcasting\)](#)
- [Send a Fax in Real Time](#)
- [Send a Fax at a Specified Time \(Delayed Fax\)](#)
- [Add a Cover Page to Your Fax](#)
- [Cancel a Fax in Progress](#)
- [Check and Cancel a Pending Fax](#)
- [Fax Options](#)

## Send a Fax

**Related Models:** DocuPrint M235 z/DocuPrint M275 z/DocuPrint M285 z

>> [DocuPrint M235 z](#)

>> [DocuPrint M275 z/DocuPrint M285 z](#)

### DocuPrint M235 z

1. Press  (Fax).
2. Do one of the following:
  - Place the document *face up* in the ADF.  
(If you are faxing multiple pages, we recommend using the ADF.)

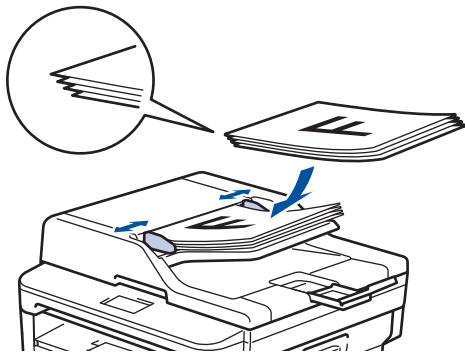

- Place the document *face down* on the scanner glass.

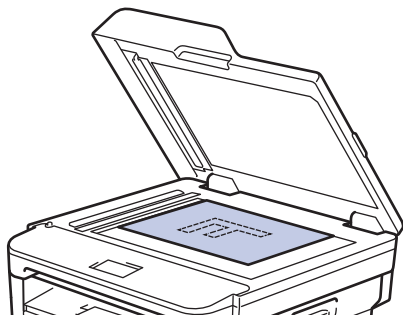

3. Enter the fax number.

- **Using the dial pad**

Enter the fax number using the dial pad.



- **Using the One Touch Buttons**

Choose a contact stored on a One Touch button.

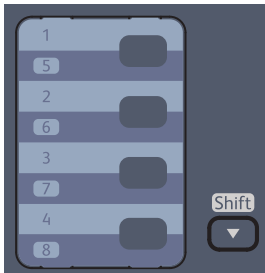

- **Using the Speed Dial Codes**

Enter the fax number by pressing  twice, and then enter the three-digit Speed Dial code.

4. Press **Start**.

The machine scans and sends the document.

**If you placed the document on the scanner glass, follow the instructions in the table:**

| Option    | Description   |
|-----------|---|
| Yes       | To scan the next page, press ▲ to select the <i>Yes</i> option, and then place the next page on the scanner glass.<br>Press <b>OK</b> to scan the page. |
| No (Send) | When you have scanned the last page, press ▼ to select the <i>No (Send)</i> option (or press <b>Start</b> again).<br>The machine sends the document.    |

- To stop faxing, press **Stop/Exit**.

## DocuPrint M275 z/DocuPrint M285 z

1. Do one of the following:

- Place the document *face up* in the ADF.  
(If you are faxing multiple pages, we recommend using the ADF.)

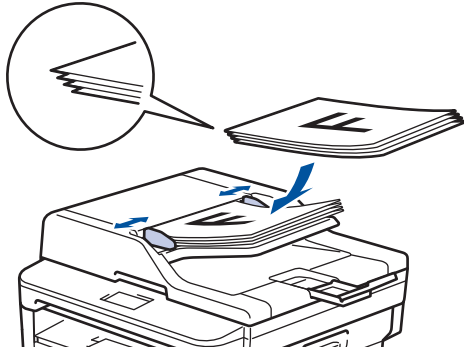

- Place the document *face down* on the scanner glass.

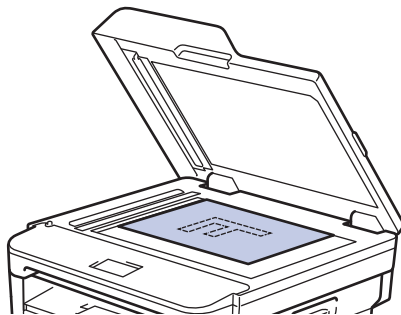

2. Press  ([Fax]).

3. Enter the fax number.

- **Using the dial pad**

Press the digits to enter the fax number.

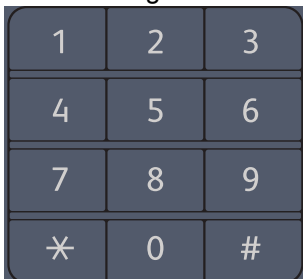

- **Using the Address Book**

Press  ([Address Book]), and then do one of the following:

- Press ▲ or ▼ to display the number you want, and then press it.
- Press , and then enter the name and press [OK]. Press the name you want to dial.

When finished, press [Apply].

- **Using the call history**

Press  ([Call History]), and then press the [Outgoing Call] option.

Press ▲ or ▼ to display the fax number you want, and then press it.

To send a fax, press [Apply].



---

4. Press [Fax Start].

The machine scans and sends the document.

**If you placed the document on the scanner glass, follow the instructions in the table.**

| Option | Description  |
|--------|--|
| Yes    | To scan the next page, press the Yes option, and then place the next page on the scanner glass. Press OK to scan the page. |
| No     | After you have scanned the last page, press the No option. The machine sends the document.                                 |

To stop faxing, press .

### Related Information

- [Send a Fax](#)
-

## Send a 2-sided Fax from the ADF

**Related Models:** DocuPrint M275 z/DocuPrint M285 z

You must select a 2-sided scanning format before sending a 2-sided fax. Select either Long Edge or Short Edge, depending on the layout of your document.

1. Load your document.
2. Press  [(Fax)] > [Options] > [2-sided Fax].
3. Do one of the following:
  - If your document is flipped on the long edge, press the [2-sided Scan: Long Edge] option.
  - If your document is flipped on the short edge, press the [2-sided Scan: Short Edge] option.
4. Press [OK]
5. Enter the fax number.
6. Press [Fax Start].



### Related Information

- [Send a Fax](#)

## Send a Fax Manually

**Related Models:** DocuPrint M235 z/DocuPrint M275 z/DocuPrint M285 z

Manual fax transmission lets you hear the dialling, ringing and fax-receiving tones while sending a fax.

>> [DocuPrint M235 z](#)

>> [DocuPrint M275 z/DocuPrint M285 z](#)

### DocuPrint M235 z

1. Press  (**Fax**).
2. Load your document.
3. Press **Hook** and listen for a dial tone.
4. Dial the fax number you want to call.
5. When you hear the fax tone, press **Start**.
  - If you are using the scanner glass, press ▲.

### DocuPrint M275 z/DocuPrint M285 z

1. Load your document.
2. Press  ([Fax]).
3. Press [Hook] and listen for a dial tone.
4. Dial the fax number you want to call.
5. When you hear the fax tone, press [Fax Start].
  - If you are using the scanner glass, press [Send].

### ✓ Related Information

- [Send a Fax](#)

## Send a Fax at the End of a Conversation

**Related Models:** DocuPrint M235 z/DocuPrint M275 z/DocuPrint M285 z

At the end of a conversation, you can send a fax to the other party before you both hang up.

>> [DocuPrint M235 z](#)

>> [DocuPrint M275 z/DocuPrint M285 z](#)

### DocuPrint M235 z

1. Ask the other party to wait for fax tones (beeps) and then to press the Start button before hanging up.
2. Load your document.
3. Press **Start**.
  - If you are using the scanner glass, press ▲.
4. Replace the handset of the external telephone.

### DocuPrint M275 z/DocuPrint M285 z

1. Ask the other party to wait for fax tones (beeps) and then to press the Start button before hanging up.
2. Load your document.
3. Press .
4. Press [Fax Start].
  - If you are using the scanner glass, press [Send].
5. Replace the handset of the external telephone.

### Related Information

- [Send a Fax](#)

## Send the Same Fax to More than One Recipient (Broadcasting)

**Related Models:** DocuPrint M235 z/DocuPrint M275 z/DocuPrint M285 z

Use the Broadcasting feature to send the same fax to multiple fax numbers at the same time.

- The same broadcast can include Groups, Address Book numbers (One Touch Dial numbers and Speed Dial numbers in some models) and up to 50 manually dialled numbers.
- 2-Line LCD models  
If you did not use any of the One Touch Dial numbers and the Speed Dial numbers for Groups, you can broadcast faxes to as many as 258 different numbers.
- Touchscreen LCD models  
If you did not use any of the Address Book numbers for Groups, you can broadcast faxes to as many as 250 different numbers.
- Address Book numbers (One Touch Dial numbers and Speed Dial numbers in some models) must be stored in the machine's memory before they can be used in a broadcast.
- Group numbers must also be stored in the machine's memory before they can be used in a broadcast. Group numbers include many stored Address Book numbers (One Touch Dial numbers and Speed Dial numbers in some models) for easier dialling.

>> [DocuPrint M235 z](#)

>> [DocuPrint M275 z/DocuPrint M285 z](#)

### DocuPrint M235 z

1. Press  (Fax).
2. Load your document.
3. Enter a number, and press **OK**.  
You can use One Touch Dial, Speed Dial, Group numbers and numbers manually entered using the dial pad.  
Repeat this step to enter the all the numbers you want to broadcast to.
4. Press **Start**.

### DocuPrint M275 z/DocuPrint M285 z

1. Load your document.
2. Press  [ (Fax) ] > [Options] > [Broadcasting].
3. Press [Add Number].  
You can add numbers to the broadcast in the following ways;
  - Press [Add Number] and enter a fax number using the LCD.  
Press [OK].
  - Press [Add from Address book] to select numbers, and then press [OK].
  - Press [Search in Address book] to search for a number.  
Enter a name using the LCD, and then press [OK].  
Select a name and a number you want to add.
4. When finished, press [OK].
5. Press [Fax Start].
6. Do one of the following:
  - If you are using the ADF, the machine scans and sends the document.

- 
- If you are using the scanner glass, the machine scans the first page.  
When the LCD displays [Next page?], press an option shown in the table.

| Option | Description  |
|--------|--|
| Yes    | Select Yes to scan the next page.<br>Place the Next page on the Scanner Glass, and then press OK.<br>Repeat this step to scan all pages. |
| No     | Select No to send the document.  |



- The machine's available memory will vary depending on the types of jobs in the memory and the numbers used for broadcasting. If you broadcast to the maximum number available, you cannot use dual access and delayed fax.
- If the [Out of Memory] message appears, press  or [Quit] to cancel or [Send Now] to send the pages scanned so far.



### Related Information

- [Send a Fax](#)
  - [Cancel a Broadcast in Progress](#)
-

## Cancel a Broadcast in Progress

**Related Models:** DocuPrint M235 z/DocuPrint M275 z/DocuPrint M285 z

While broadcasting you can cancel the fax currently being sent or the whole broadcast job.

>> [DocuPrint M235 z](#)

>> [DocuPrint M275 z/DocuPrint M285 z](#)

### DocuPrint M235 z

1. Press **Menu**.
2. Press **▲** or **▼** to display the [Fax] option, and then press **OK**.
3. Press **▲** or **▼** to display the [Remaining Jobs] option, and then press **OK**.

The LCD will display the Broadcast job number followed by the fax number being dialled (for example, [#001123456789]) and the broadcast job number (for example, [Broadcast#001]).

4. Press **▲** or **▼** to display the fax number being dialled or the broadcast job number, and then press **OK**.
5. Press the option shown in the table to cancel or exit the cancel process.

| Option | Description   |
|--------|---|
| ▲      | The machine cancels the fax currently being sent.             |
| ▼      | The machine exits from the cancel process without cancelling. |

If you cancelled the fax currently being sent, the LCD will ask you if you want to cancel the broadcast job.

6. Press the option shown in the table to cancel the broadcast job or exit the cancel process.

| Option | Description   |
|--------|---|
| ▲      | The machine cancels the broadcast job.                        |
| ▼      | The machine exits from the cancel process without cancelling. |

7. Press **Stop/Exit**.

### DocuPrint M275 z/DocuPrint M285 z

1. Press **X**.
2. Do one of the following:
  - To cancel the entire broadcast, press [Entire Broadcast]. Press [Yes] to confirm or press [No] to exit without cancelling the broadcast.
  - To cancel the current job, press the name or number being cancelled on the LCD. Press [Yes] to confirm or press [No] to exit without cancelling the fax being sent.
  - To exit without cancelling, press **X**.

### ✓ Related Information

- [Send the Same Fax to More than One Recipient \(Broadcasting\)](#)

## Send a Fax in Real Time

**Related Models:** DocuPrint M235 z/DocuPrint M275 z/DocuPrint M285 z

When sending a fax, the machine scans the document into the memory before sending it. As soon as the telephone line is free, the machine starts dialling and sending. If you want to send an important document immediately without waiting for the machine to retrieve the scan from its memory, turn on [Real Time TX].

- If the memory is full and you are sending a fax from the ADF, the machine sends the document in real time (even if [Real Time TX] is set to [Off]). If the memory is full, faxes from the scanner glass cannot be sent until you clear some of the memory.
- In Real Time Transmission, the automatic redial feature does not work when using the scanner glass.
- If [Real Time TX] is set to on, the option to scan 2-sided documents is not available.

>> [DocuPrint M235 z](#)

>> [DocuPrint M275 z/DocuPrint M285 z](#)

### DocuPrint M235 z

1. Press  (Fax).
2. Load your document.
3. Press **Menu**.
4. Press ▲ or ▼ to display the [Fax] option, and then press **OK**.
5. Press ▲ or ▼ to display the [Setup Send] option, and then press **OK**.
6. Press ▲ or ▼ to display the [Real Time TX] option, and then press **OK**.
7. Press ▲ or ▼ to display the [On] option, and then press **OK**.
8. When finished, press **Stop/Exit**.
9. Enter the fax number.
10. Press **Start**.

### DocuPrint M275 z/DocuPrint M285 z

1. Load your document.
2. Press  [(Fax)] > [Options] > [Real Time TX].
3. Press [On] or [Off].
4. Press [OK].
5. Enter the fax number.
6. Press [Fax Start].



### Related Information

- [Send a Fax](#)



## Send a Fax at a Specified Time (Delayed Fax)

**Related Models:** DocuPrint M235 z/DocuPrint M275 z/DocuPrint M285 z

You can store up to 50 faxes in the machine's memory to be sent within the next twenty-four hour period.

>> [DocuPrint M235 z](#)

>> [DocuPrint M275 z/DocuPrint M285 z](#)



### DocuPrint M235 z

1. Press  (Fax).
2. Load your document.
3. Press **Options**.
4. Press **▲** or **▼** to display the [Delayed Fax] option, and then press **OK**.
5. Enter the time you want the fax to be sent.
  - If you set [12h Clock] in the [Date&Time] setting, enter the time in 12-hour format, and then press **OK**.  
Press **▲** or **▼** to display the [AM] or [PM] option, and then press **OK**.
  - If you set [24h Clock] in the [Date&Time] setting, enter the time in 24-hour format, and then press **OK**.  
(For example, enter 19:45 for 7:45 PM.)
6. Enter the fax number.
7. Press **Start**.



- The number of pages you can scan into the memory depends on the amount of data printed on each page.

### DocuPrint M275 z/DocuPrint M285 z

1. Load your document.
2. Press  [(Fax)] > [Options] > [Delayed Fax] > [Delayed Fax].
3. Press [On] or [Off].
4. Press [Set Time].
5. Enter the time you want the fax to be sent.
  - If you set [12h Clock] in the [Date & Time] setting, enter the time in 12-hour format.  
Press the  button to select [AM] or [PM], and then press [OK].
  - If you set [24h Clock] in the [Date & Time] setting, enter the time in 24-hour format and then press [OK].  
(For example, enter 19:45 for 7:45 PM.)
6. Press [OK].
7. Enter the fax number.
8. Press [Fax Start].

### ✓ Related Information

- [Send a Fax](#)

## Add a Cover Page to Your Fax

**Related Models:** DocuPrint M235 z/DocuPrint M275 z/DocuPrint M285 z

You can add a cover page to the next fax or every outgoing fax.

- This feature will not work unless you have programmed your Station ID.
- Your cover page includes your Station ID, a comment, and the name stored in the Address Book, One Touch Dial, or Speed Dial (in some models).

>> [DocuPrint M235 z](#)

>> [DocuPrint M275 z/DocuPrint M285 z](#)



### DocuPrint M235 z

1. Press  (Fax).
2. Load your document.
3. Press **Menu**.
4. Press **▲** or **▼** to display the [Fax] option, and then press **OK**.
5. Press **▲** or **▼** to display the [Setup Send] option, and then press **OK**.
6. Press **▲** or **▼** to display the [Coverpage] option, and then press **OK**.
7. Press **▲** or **▼** to display the [Setup] option, and then press **OK**.
8. Press **▲** or **▼** to display a option in the table, and then press **OK**.

| Option | Description  |
|--------|--|
| On     | Select this option to add a cover page to outgoing fax.                      |
| Off    | Select this option if you do not want to add a cover page to outgoing faxes. |

9. If you selected [On], press **▲** or **▼** to display comment options, and then press **OK**.
10. Enter the number of total pages using the dial pad, and then press **OK**.
11. When finished, press **Stop/Exit**.
12. Enter the fax number.
13. Press **Start**.

### DocuPrint M275 z/DocuPrint M285 z

1. Load your document.
2. Press  [(Fax)] > [Options] > [Coverpage Setup] > [Coverpage Setup].
3. Press [On] or [Off].
4. Press [Coverpage Note].
5. Press **▲** or **▼** to display comment you want, and then press it.
6. Press [Total Pages].
7. Enter the number of total pages, and then press [OK].
8. Press .
9. Press [OK].
10. Enter the fax number.
11. Press [Fax Start].

---

The cover page will be added to the next fax. If you want to add the cover page to every outgoing fax, set the settings as the new default.



## Related Information

- [Send a Fax](#)
  - [Compose Your Own Comments](#)
-

## Compose Your Own Comments

**Related Models:** DocuPrint M235 z/DocuPrint M275 z/DocuPrint M285 z

You can set up two comments of your own.



>> [DocuPrint M235 z](#)

>> [DocuPrint M275 z/DocuPrint M285 z](#)

### DocuPrint M235 z

1. Press  (Fax).
2. Press **Menu**.
3. Press ▲ or ▼ to display the [Fax] option, and then press **OK**.
4. Press ▲ or ▼ to display the [Setup Send] option, and then press **OK**.
5. Press ▲ or ▼ to display the [Coverpage] option, and then press **OK**.
6. Press ▲ or ▼ to display the [Note] option, and then press **OK**.
7. Press ▲ or ▼ to display the [5] or [6] option to store your own comment, and then press **OK**.
8. Enter your own comment using the dial pad, and then press **OK**.
9. Press **Stop/Exit**.

### DocuPrint M275 z/DocuPrint M285 z

1. Press  [Settings] > [All Settings] > [Fax] > [Setup Send] > [Coverpage Note].
2. Press [5] or [6] to store your own comment.
3. Enter your own comment using the LCD, and then press [OK].
4. Press .

### ✓ Related Information

- [Add a Cover Page to Your Fax](#)

## Cancel a Fax in Progress

**Related Models:** DocuPrint M235 z/DocuPrint M275 z/DocuPrint M285 z

>> [DocuPrint M235 z](#)

>> [DocuPrint M275 z/DocuPrint M285 z](#)

### DocuPrint M235 z

1. Press **Stop/Exit** while the machine is dialling or sending a fax.
2. Press an option in the table to cancel or continue the fax job in progress.

| Option | Description  |
|--------|--|
| ▲      | The machine cancels sending the fax job.                           |
| ▼      | The machine exits from the process without cancelling the fax job. |

### DocuPrint M275 z/DocuPrint M285 z

1. Press  while the machine is dialling or sending a fax.  
The LCD will display [Cancel Job?].
2. Press an option in the table to cancel or continue the fax job in progress.

| Option | Description  |
|--------|--|
| Yes    | The machine cancels sending the fax job.                           |
| No     | The machine exits from the process without cancelling the fax job. |

### Related Information

- [Send a Fax](#)

## Check and Cancel a Pending Fax

**Related Models:** DocuPrint M235 z/DocuPrint M275 z/DocuPrint M285 z

You can cancel a fax job before it is sent, by cancelling the fax job while it is stored and waiting in the memory.

>> [DocuPrint M235 z](#)

>> [DocuPrint M275 z/DocuPrint M285 z](#)



### DocuPrint M235 z

1. Press  (Fax).
2. Press **Menu**.
3. Press **▲** or **▼** to display the [Fax] option, and then press **OK**.
4. Press **▲** or **▼** to display the [Remaining Jobs] option, and then press **OK**.  
The LCD displays the number of jobs waiting in the memory to be sent.
5. Press **▲** or **▼** to display the job you want to cancel, and then press **OK**.
6. Press the options in the following table to cancel or exit the cancel process.

| Option   | Description   |
|----------|---|
| <b>▲</b> | The machine cancels the job.                                  |
| <b>▼</b> | The machine exits from the cancel process without cancelling. |

7. Press **Stop/Exit**.

### DocuPrint M275 z/DocuPrint M285 z

1. Press  [Settings] > [All Settings] > [Fax] > [Remaining Jobs].
2. Do the following steps for each job you want to check or cancel:
  - a. Press **▲** or **▼** to scroll through the waiting jobs, and then press the job you want to cancel.
  - b. Press [OK].
  - c. Press [Yes] to confirm or press [No] to exit without cancelling.
3. When finished cancelling jobs, press .

### Related Information

- [Send a Fax](#)

## Fax Options

### DocuPrint M235 z

To change fax-sending settings, press the **Options** button.

| Option         | Description   |
|----------------|---|
| Fax Resolution | Set the resolution for outgoing faxes.<br>The fax quality often can be improved by changing the Fax Resolution.         |
| Contrast       | Adjust the contrast.<br>If your document is very light or very dark, changing the contrast may improve the fax quality. |
| Glass ScanSize | Adjust the scan area of the scanner glass to the size of the document.  |
| Delayed Fax    | Set the time of day the delayed faxes will be sent.   |
| Real Time TX   | Send a fax immediately without waiting for the machine to retrieve the scan from its memory.                            |
| Coverpage      | Set the machine to automatically send a cover page that you have pre-programmed.  |
| Overseas Mode  | Set to On if you have difficulty sending faxes overseas.  |

### DocuPrint M275 z/DocuPrint M285 z

To change fax-sending settings, press the **Options** button.

| Option   | Description   |
|--|---|
| Fax Resolution   | Set the resolution for outgoing faxes.<br>The fax quality often can be improved by changing the Fax Resolution.         |
| Contrast   | Adjust the contrast.<br>If your document is very light or very dark, changing the contrast may improve the fax quality. |
| 2-sided Fax<br>(For automatic 2-sided scanning models) | Set the 2-sided scanning format.  |
| Glass Scan Size  | Adjust the scan area of the scanner glass to the size of the document.  |
| Broadcasting   | Send the same fax message to more than one fax number at the same time.   |
| Delayed Fax  | Set the time of day the delayed faxes will be sent.   |
| Real Time TX   | Send a fax immediately without waiting for the machine to retrieve the scan from its memory.                            |
| Coverpage Setup  | Set the machine to automatically send a cover page that you have pre-programmed.  |
| Overseas Mode  | Set to On if you have difficulty sending faxes overseas.  |
| Call History   | Select a number from the Call History.  |
| Address Book   | Select a number from the Address Book.  |
| Set New Default  | Save your settings as the default.  |
| Factory Reset  | Restore all settings back to the factory settings.  |



You can save the current settings by pressing [Save as Shortcut].

---



## Related Information

---

- [Send a Fax](#)
-



## Receive a Fax

- [Receive Mode Settings](#)
- [Memory Receive Options](#)
- [Remote Fax Retrieval](#)

## Receive Mode Settings

- [Receive Modes Overview](#)
- [Choose the Correct Receive Mode](#)
- [Set the Number of Rings Before the Machine Answers \(Ring Delay\)](#)
- [Set the F/T Ring Time \(Fast Double-ring\)](#)
- [Set Fax Detect](#)
- [Shrink Page Size of an Oversized Incoming Fax](#)
- [Set the 2-sided Printing for Received Faxes](#)
- [Set the Fax Receive Stamp](#)
- [Receive a Fax at the End of a Telephone Conversation](#)
- [Register a Number in the Blocked List](#)

## Receive Modes Overview

**Related Models:** DocuPrint M235 z/DocuPrint M275 z/DocuPrint M285 z

Some receive modes answer automatically (Fax Only Mode and Fax/Tel Mode). You may want to change the Ring Delay before using these modes.

### Fax Only Mode

([Fax Only] in the machine's menu)

Fax Only Mode automatically answers every call as a fax.

### Fax/Tel Mode

([Fax/Tel] in the machine's menu)

Fax/Tel Mode helps you manage incoming calls, by recognising whether they are fax or voice calls and handling them in the following ways:

- Faxes will be received automatically.
- Voice calls will start the F/T ring to tell you to pick up the call. The F/T ring is a fast pseudo/double-ring made by your machine.

### Manual Mode

([Manual] in the machine's menu)

Manual Mode turns off all automatic answering operations unless you are using the Distinctive Ring Receive feature.

FaxAbility is equivalent to the Distinctive Ring Receive feature in New Zealand.

To receive a fax in Manual Mode, lift the handset of the external telephone connected to the machine or press the button in the table.

| Applicable Models                 | Alternate way to lift the handset   |
|-----------------------------------|---|
| DocuPrint M235 z                  | Hook  |
| DocuPrint M275 z/DocuPrint M285 z |  (Fax) and then Hook |

When you hear fax tones (short repeating beeps), press the buttons in the table to receive a fax. Use the Fax Detect feature to receive faxes when you have lifted a handset on the same line as the machine.

| Applicable Models                 | To receive the fax         |
|-----------------------------------|----------------------------|
| DocuPrint M235 z                  | Start and then ▼           |
| DocuPrint M275 z/DocuPrint M285 z | Fax Start and then Receive |

### External TAD Mode

([External TAD] in the machine's menu)

External TAD Mode lets an external answering device manage your incoming calls.

Incoming calls will be handled in the following ways:

- Faxes will be received automatically.
- Voice callers can record a message on the external TAD.

## ✓ Related Information

- [Receive Mode Settings](#)

## Choose the Correct Receive Mode

**Related Models:** DocuPrint M235 z/DocuPrint M275 z/DocuPrint M285 z

You must choose a Receive Mode depending on the external devices and telephone services you have on your line.

By default, your machine will automatically receive any faxes that are sent to it. The diagram below will help you select the correct mode.

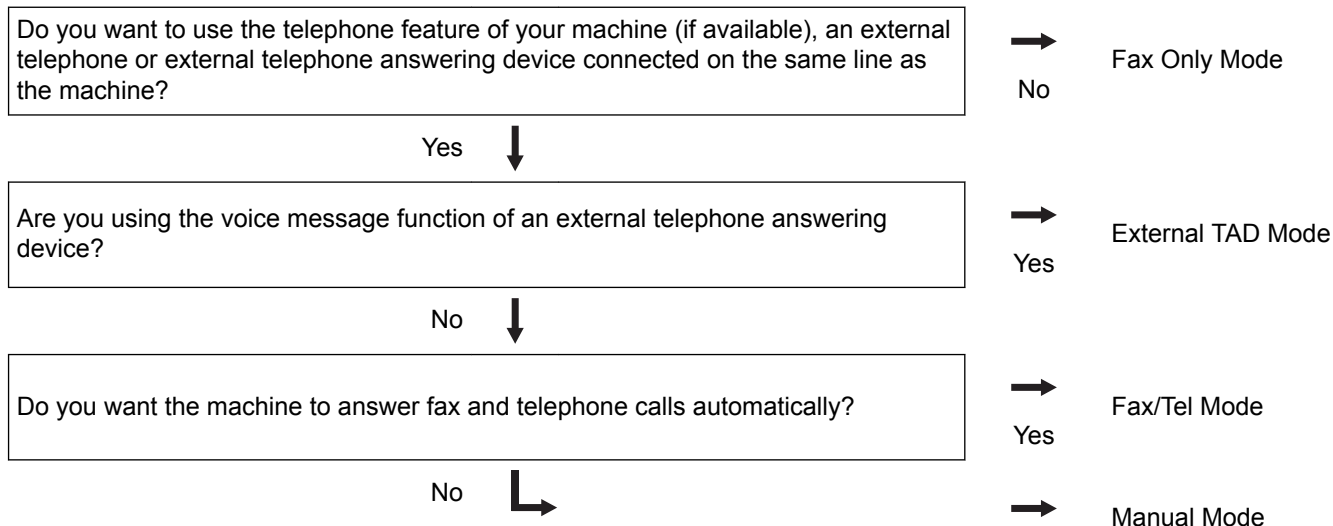

>> [DocuPrint M235 z](#)

>> [DocuPrint M275 z/DocuPrint M285 z](#)

### DocuPrint M235 z

1. Press  (Fax).
2. Press **Menu**.
3. Press ▲ or ▼ to display the [Fax] option, and then press **OK**.
4. Press ▲ or ▼ to display the [Setup Receive] option, and then press **OK**.
5. Press ▲ or ▼ to display the [Receive Mode] option, and then press **OK**.



If you cannot change the [Receive Mode], make sure the Distinctive Ring <sup>1</sup> feature is set to Off.

6. Press ▲ or ▼ to select the [Fax Only], [Fax/Tel], [External TAD], or [Manual] option, and then press **OK**.
7. Press **Stop/Exit**.

### DocuPrint M275 z/DocuPrint M285 z

1. Press  [Settings] > [All Settings] > [Fax] > [Setup Receive] > [Receive Mode].



If you cannot change the [Receive Mode], make sure the Distinctive Ring <sup>2</sup> feature is set to Off.

2. Press ▲ or ▼ to display the [Fax Only], [Fax/Tel], [External TAD], or [Manual] option, and then press the option you want.

<sup>1</sup> Fax Ability in New Zealand.

<sup>2</sup> Fax Ability in New Zealand.

---

3. Press .



### Related Information

- [Receive Mode Settings](#)
-

## Set the Number of Rings Before the Machine Answers (Ring Delay)

**Related Models:** DocuPrint M235 z/DocuPrint M275 z/DocuPrint M285 z

When somebody calls your machine, you will hear the normal telephone ring sound. The number of rings is set in the Ring Delay option.

- The Ring Delay setting sets the number of times the machine rings before it answers in the Fax Only and Fax/Tel Modes.
- If you have external or extension telephones on the same line as the machine, choose the maximum number of rings.

>> [DocuPrint M235 z](#)

>> [DocuPrint M275 z/DocuPrint M285 z](#)

### DocuPrint M235 z

1. Press  (Fax).
2. Press **Menu**.
3. Press **▲** or **▼** to display the [Fax] option, and then press **OK**.
4. Press **▲** or **▼** to display the [Setup Receive] option, and then press **OK**.
5. Press **▲** or **▼** to display the [Ring Delay] option, and then press **OK**.
6. Press **▲** or **▼** to select the number of rings you want the line to ring before the machine answers, and then press **OK**.
7. Press **Stop/Exit**.



If you select [00], the machine will answer immediately and the line will not ring at all (available only for some countries).

### DocuPrint M275 z/DocuPrint M285 z

1. Press  [Settings] > [All Settings] > [Fax] > [Setup Receive] > [Ring Delay].
2. Press the number of rings you want the line to ring before the machine answers.



If you select [0], the machine will answer immediately and the line will not ring at all (available only for some countries).

3. Press .



### Related Information

- [Receive Mode Settings](#)

## Set the F/T Ring Time (Fast Double-ring)

**Related Models:** DocuPrint M235 z/DocuPrint M275 z/DocuPrint M285 z

When you set the Receive Mode to Fax/Tel Mode, if the call is a fax, your machine will automatically receive it. However, if it is a voice call, the machine will sound the F/T ring (fast double-ring) for the time you set in the F/T Ring Time option. When you hear the F/T ring, it means that a voice caller is on the line.

- The F/T Ring Time feature works when you set Fax/Tel Mode as the Receive Mode.

Because the F/T ring is made by the machine, extension and external telephones will not ring; however, you can still answer the call on any telephone.

>> [DocuPrint M235 z](#)

>> [DocuPrint M275 z/DocuPrint M285 z](#)



### DocuPrint M235 z

1. Press  (Fax).
2. Press **Menu**.
3. Press **▲** or **▼** to display the [Fax] option, and then press **OK**.
4. Press **▲** or **▼** to display the [Setup Receive] option, and then press **OK**.
5. Press **▲** or **▼** to display the [F/T Ring Time] option, and then press **OK**.
6. Press **▲** or **▼** to display how long the machine will ring to alert you that you have a voice call, and then press **OK**.
7. Press **Stop/Exit**.



Even if the caller hangs up during the pseudo/double-ringing, the machine will continue to ring for the set time.

### DocuPrint M275 z/DocuPrint M285 z

1. Press  [Settings] > [All Settings] > [Fax] > [Setup Receive] > [F/T Ring Time].
2. Press how long you want the machine to ring to alert you that you have a voice call.
3. Press .



Even if the caller hangs up during the pseudo/double-ringing, the machine will continue to ring for the set time.

### ✓ Related Information

- [Receive Mode Settings](#)

## Set Fax Detect

**Related Models:** DocuPrint M235 z/DocuPrint M275 z/DocuPrint M285 z

**If Fax Detect is On:** The machine receives a fax call automatically, even if you answer the call. When you see [Receiving] on the LCD or when you hear “chirps” through the handset you are using, just replace the handset. Your machine will do the rest.

**If Fax Detect is Off:** If you are at the machine and answer a fax call by lifting the handset, press the buttons in the following table to receive the fax. If you answered at an extension or external telephone, press \*51 (\*91 for New Zealand).

| Applicable Models                 | To receive the fax  |
|-----------------------------------|---|
| DocuPrint M235 z                  | <b>Start</b> and then ▼   |
| DocuPrint M275 z/DocuPrint M285 z |  > Fax Start > Receive |



- If this feature is set to [On], but your machine does not connect a fax call when you lift an extension or external telephone handset, press the remote activation code \*51 (\*91 for New Zealand).
- If you send faxes from a computer on the same telephone line and the machine intercepts them, set Fax Detect to [Off].



>> [DocuPrint M235 z](#)

>> [DocuPrint M275 z/DocuPrint M285 z](#)

### DocuPrint M235 z

1. Press  (Fax).
2. Press **Menu**.
3. Press ▲ or ▼ to display the [Fax] option, and then press **OK**.
4. Press ▲ or ▼ to display the [Setup Receive] option, and then press **OK**.
5. Press ▲ or ▼ to display the [Fax Detect] option, and then press **OK**.
6. Press ▲ or ▼ to display the [On] (or [Off]) option, and then press **OK**.
7. Press **Stop/Exit**.

### DocuPrint M275 z/DocuPrint M285 z

1. Press  [Settings] > [All Settings] > [Fax] > [Setup Receive] > [Fax Detect].
2. Press [On] or [Off].
3. Press .

### ✓ Related Information

- [Receive Mode Settings](#)



## Shrink Page Size of an Oversized Incoming Fax

**Related Models:** DocuPrint M235 z/DocuPrint M275 z/DocuPrint M285 z

If you enable the auto reduction function, the machine reduces each page of an incoming fax to fit on your paper. The machine calculates the reduction ratio by using the page size of the fax and your Paper Size setting.



>> [DocuPrint M235 z](#)

>> [DocuPrint M275 z/DocuPrint M285 z](#)

### DocuPrint M235 z

1. Press  (Fax).
2. Press **Menu**.
3. Press ▲ or ▼ to display the [Fax] option, and then press **OK**.
4. Press ▲ or ▼ to display the [Setup Receive] option, and then press **OK**.
5. Press ▲ or ▼ to display the [Auto Reduction] option, and then press **OK**.
6. Press ▲ or ▼ to display the [On] (or [Off]) option, and then press **OK**.
7. Press **Stop/Exit**.

### DocuPrint M275 z/DocuPrint M285 z

1. Press  [Settings] > [All Settings] > [Fax] > [Setup Receive] > [Auto Reduction].
2. Press [On] or [Off].
3. Press .

### Related Information

- [Receive Mode Settings](#)

## Set the 2-sided Printing for Received Faxes

**Related Models:** DocuPrint M235 z/DocuPrint M275 z/DocuPrint M285 z

Your machine prints received faxes on both sides of the paper when [2-sided] is set to [On].

- Use A4 size paper (60 to 105 g/m<sup>2</sup>) for this function.
- When 2-sided printing is enabled, incoming faxes are automatically reduced to fit the paper in the paper tray.



>> [DocuPrint M235 z](#)

>> [DocuPrint M275 z/DocuPrint M285 z](#)

### DocuPrint M235 z

1. Press  (Fax).
2. Press **Menu**.
3. Press ▲ or ▼ to display the [Fax] option, and then press **OK**.
4. Press ▲ or ▼ to display the [Setup Receive] option, and then press **OK**.
5. Press ▲ or ▼ to display the [2-sided] option, and then press **OK**.
6. Press ▲ or ▼ to display the [On] (or [Off]) option, and then press **OK**.
7. Press **Stop/Exit**.

### DocuPrint M275 z/DocuPrint M285 z

1. Press  [Settings] > [All Settings] > [Fax] > [Setup Receive] > [2-sided].
2. Press [On] or [Off].
3. Press .

### Related Information

- [Receive Mode Settings](#)

## Set the Fax Receive Stamp

**Related Models:** DocuPrint M235 z/DocuPrint M275 z/DocuPrint M285 z

You can set the machine to print the received date and time at the top centre of each received fax page.

- Make sure you have set the current date and time on the machine.



>> [DocuPrint M235 z](#)

>> [DocuPrint M275 z/DocuPrint M285 z](#)

### DocuPrint M235 z

1. Press  (Fax).
2. Press **Menu**.
3. Press **▲** or **▼** to display the [Fax] option, and then press **OK**.
4. Press **▲** or **▼** to display the [Setup Receive] option, and then press **OK**.
5. Press **▲** or **▼** to display the [Fax Rx Stamp] option, and then press **OK**.
6. Press **▲** or **▼** to display the [On] (or [Off]) option, and then press **OK**.
7. Press **Stop/Exit**.

### DocuPrint M275 z/DocuPrint M285 z

1. Press  [Settings] > [All Settings] > [Fax] > [Setup Receive] > [Fax Rx Stamp].
2. Press [On] or [Off].
3. Press .

### Related Information

- [Receive Mode Settings](#)

## Receive a Fax at the End of a Telephone Conversation

**Related Models:** DocuPrint M235 z/DocuPrint M275 z/DocuPrint M285 z

If you are speaking on the telephone connected to your Fuji Xerox machine and the other party is also speaking on a telephone connected to his fax machine, at the end of the conversation, the other party can send you a fax before you both hang up.

Your machine's ADF must be empty.

>> [DocuPrint M235 z](#)

>> [DocuPrint M275 z/DocuPrint M285 z](#)

### DocuPrint M235 z

1. Ask the other party to place the document in their machine and to press the Start or Send button.
2. When you hear the CNG tones (slowly repeating beeps), press **Start**.
3. Press ▼ to receive a fax.
4. Replace the external handset.

### DocuPrint M275 z/DocuPrint M285 z

1. Ask the other party to place the document in their machine and to press the Start or Send button.
2. When you hear the CNG tones (slowly repeating beeps), press [Fax Start].



- If the LCD is dark for Sleep Mode, touch it to display [Fax Start].
- If the machine is in Automatic Redial, wait until it is finished and try again.

3. Press [Receive] to receive a fax.
4. Replace the external handset.

### ✓ Related Information

- [Receive Mode Settings](#)

## Register a Number in the Blocked List

**Related Models:** DocuPrint M235 z/DocuPrint M275 z/DocuPrint M285 z

If you do not want to receive faxes or calls from specific numbers, register the numbers to your list of blocked callers. The machine can register up to 100 fax or telephone numbers from the caller ID memory.

- You must apply for the Caller ID service at your local telephone company.
- The number you want to register must be stored in the caller ID memory.

The Caller ID feature is not available in some countries.

>> [DocuPrint M235 z](#)

>> [DocuPrint M275 z/DocuPrint M285 z](#)

### DocuPrint M235 z

1. Press  (Fax).
2. Press **Menu**.
3. Press ▲ or ▼ to display the [Fax] option, and then press **OK**.
4. Press ▲ or ▼ to display the [Anti-Junk Fax] option, and then press **OK**.
5. Press ▲ or ▼ to display the [Register] option, and then press **OK**.

The machine displays the numbers in the caller ID memory.



- To delete the number, press ▲ and then press **OK**.
- To print the blocked list, select [Print Report] and then press **OK**. Follow the on-screen menus.

6. Press ▲ or ▼ to display the number you want, and then press **OK**.
7. Press ▲ to register the number.



To go back without registering the number, press ▼.

8. Press **Stop/Exit**.

### DocuPrint M275 z/DocuPrint M285 z

1. Press  [Settings] > [All Settings] > [Fax] > [Anti-Junk Fax].
2. Press [Register].



- To delete the number, select [Delete] and then press [OK].
- To print the blocked list, press [Print Reports] and then follow the on-screen menus.

3. Press ▲ or ▼ to display the number you want, and then press the number.
4. Press [Yes].
5. Press .



### Related Information

- [Receive Mode Settings](#)

## Memory Receive Options

Use Memory Receive options to direct incoming faxes while you are away from the machine. You can use only one Memory Receive option at a time.

Memory Receive can be set to:

- Fax Forwarding
  - Fax Storage
  - PC-Fax Receive
  - Off
- 
- [Forward Incoming Faxes to Another Machine](#)
  - [Store Incoming Faxes in the Machine's Memory](#)
  - [Change Memory Receive Options](#)
  - [Turn Off Memory Receive](#)
  - [Print a Fax Stored in the Machine's Memory](#)
  - [Use PC-Fax Receive to Transfer Received Faxes to Your Computer \(Windows® only\)](#)

## Forward Incoming Faxes to Another Machine

**Related Models:** DocuPrint M235 z/DocuPrint M275 z/DocuPrint M285 z

Use the Fax Forwarding feature to automatically forward your incoming faxes to another machine.

>> [DocuPrint M235 z](#)

>> [DocuPrint M275 z/DocuPrint M285 z](#)

### DocuPrint M235 z

1. Press **Menu**.
2. Press **▲** or **▼** to display the [Fax] option, and then press **OK**.
3. Press **▲** or **▼** to display the [Memory Receive] option, and then press **OK**.
4. Press **▲** or **▼** to display the [Forward/Store] option, and then press **OK**.
5. Press **▲** or **▼** to display the [Fax Forward] option, and then press **OK**.  
The LCD will ask you to enter the fax number you want your faxes to be forwarded to.
6. Enter the forwarding number using the dial pad (up to 20 digits), a One Touch button, or  and the three-digit code, and then press **OK**.



- If you stored a Group on a One Touch key or in a Speed Dial code, the faxes will be forwarded to multiple fax numbers.

7. Press **▲** or **▼** to select on or off for the Backup Print setting.
8. Press **Stop/Exit**.

### DocuPrint M275 z/DocuPrint M285 z

1. Press  [Settings] > [All Settings] > [Fax] > [Setup Receive] > [Memory Receive].
2. Press [Fax Forward].
3. Do one of the following:
  - Press [Manual] to enter the forwarding fax number (up to 20 digits) using the LCD.  
Press [OK].
  - Press [Address Book].  
Press **▲** or **▼** to display the destination fax number where you want to your faxes forwarded.  
Press the fax number you want.

### NOTE

- Press [Backup Print: On] or [Backup Print: Off]. If you select [Backup Print: On], the machine also prints a copy of received faxes at your machine.

4. Press .

### ✓ Related Information

- [Memory Receive Options](#)

## Store Incoming Faxes in the Machine's Memory

**Related Models:** DocuPrint M235 z/DocuPrint M275 z/DocuPrint M285 z

Use the Fax Storage feature to store incoming faxes in the machine's memory. Retrieve your stored fax messages from your fax machine when you are at another location using the Remote Retrieval commands. Your machine will print a backup copy of each stored fax.

>> [DocuPrint M235 z](#)

>> [DocuPrint M275 z/DocuPrint M285 z](#)

### DocuPrint M235 z

1. Press **Menu**.
2. Press **▲** or **▼** to display the [Fax] option, and then press **OK**.
3. Press **▲** or **▼** to display the [Memory Receive] option, and then press **OK**.
4. Press **▲** or **▼** to display the [Forward/Store] option, and then press **OK**.
5. Press **▲** or **▼** to display the [Fax Storage] option, and then press **OK**.
6. Press **Stop/Exit**.

### DocuPrint M275 z/DocuPrint M285 z

1. Press  [Settings] > [All Settings] > [Fax] > [Setup Receive] > [Memory Receive].
2. Press the [Fax Storage] option.

### NOTE

- Press [Backup Print: On] or [Backup Print: Off]. If you select [Backup Print: On], the machine also prints a copy of received faxes. (Available only for certain models)

3. Press .

### ✓ Related Information

- [Memory Receive Options](#)



## Change Memory Receive Options

**Related Models:** DocuPrint M235 z/DocuPrint M275 z/DocuPrint M285 z

>> [DocuPrint M235 z](#)

>> [DocuPrint M275 z/DocuPrint M285 z](#)

### DocuPrint M235 z

If there are faxes in your machine's memory when you change any Memory Receive option, the LCD displays one of the following questions:

**If received faxes have already been printed, the LCD displays [Erase all doc?]**

- Do one of the following:
  - If you press ▲, faxes in the memory will be erased before the setting changes.
  - If you press ▼, faxes in the memory will not be erased and the setting will be unchanged.

**If unprinted faxes are in the memory, the LCD displays [Print all faxes?]**

- Do one of the following:
  - If you press ▲, faxes in the memory will be printed before the setting changes. If a backup copy has already been printed, it will not be printed again.
  - If you press ▼, faxes in the memory will not be printed and the setting will be unchanged.

**If received faxes are left in the machine's memory when you change to [PC Fax Receive] from another option (such as [Fax Forward], or [Fax Storage]).**

- Select [<USB>] or the name of the computer if you are on a network, and then press **OK**.

The LCD displays:

[Send Fax to PC?]

- If you press ▲, faxes in the memory will be sent to your computer before the setting changes. You will be asked if you want to turn on Backup Print.
- If you press ▼, faxes in the memory will not be erased and the setting will be unchanged.

### DocuPrint M275 z/DocuPrint M285 z

If received faxes are in your machine's memory when you change the Remote Fax operations, the LCD will ask you one of the following questions:

**If received faxes have already been printed, the LCD displays [Erase all documents?]**

- Do one of the following:
  - If you press [Yes], faxes in the memory will be erased before the setting changes.
  - If you press [No], faxes in the memory will not be erased and the setting will be unchanged.

**If unprinted faxes are in the machine's memory, the LCD displays [Print all faxes?]**

- Do one of the following:
  - If you press [Yes], faxes in the memory will be printed before the setting changes.
  - If you press [No], faxes in the memory will not be printed and the setting will be unchanged.

**If received faxes are left in the machine's memory when you change to [PC Fax Receive] from another option ([Fax Forward] or [Fax Storage]).**

- Press [<USB>] or the name of the computer if you are on a network, and then press [OK]. You will be asked if you want to turn on Backup Print.

The LCD displays:

[Send Fax to PC?]

- If you press [Yes], faxes in the memory will be sent to your computer before the setting changes.
- If you press [No], faxes in the memory will not be erased and the setting will be unchanged.



## Related Information

- [Memory Receive Options](#)
-

## Turn Off Memory Receive

**Related Models:** DocuPrint M235 z/DocuPrint M275 z/DocuPrint M285 z

Turn off Memory Receive if you do not want the machine to save or transfer incoming faxes.

>> [DocuPrint M235 z](#)

>> [DocuPrint M275 z/DocuPrint M285 z](#)

### DocuPrint M235 z

1. Press **Menu**.
2. Press **▲** or **▼** to display the [Fax] option, and then press **OK**.
3. Press **▲** or **▼** to display the [Memory Receive] option, and then press **OK**.
4. Press **▲** or **▼** to display the [Forward/Store] option, and then press **OK**.
5. Press **▲** or **▼** to display the [Off] option, and then press **OK**.



The LCD displays options if there are received faxes still in your machine's memory.

6. Press **Stop/Exit**.

### DocuPrint M275 z/DocuPrint M285 z

1. Press  [Settings] > [All Settings] > [Fax] > [Setup Receive] > [Memory Receive].
2. Press [Off].



The LCD displays options if there are received faxes still in your machine's memory.

3. Press .

### ✓ Related Information

- [Memory Receive Options](#)

## Print a Fax Stored in the Machine's Memory

**Related Models:** DocuPrint M235 z/DocuPrint M275 z/DocuPrint M285 z

If you select [Fax Storage], you can still print a fax from the memory when you are at your machine.

>> [DocuPrint M235 z](#)

>> [DocuPrint M275 z/DocuPrint M285 z](#)

### DocuPrint M235 z

1. Press **Menu**.
2. Press **▲** or **▼** to display the [Fax] option, and then press **OK**.
3. Press **▲** or **▼** to display the [Memory Receive] option, and then press **OK**.
4. Press **▲** or **▼** to display the [Print Document] option, and then press **OK**.
5. Press **Start**.
6. Press **Stop/Exit**.

### DocuPrint M275 z/DocuPrint M285 z

1. Press  [Settings] > [All Settings] > [Fax] > [Print Document].
2. Press [Yes].

### Related Information

- [Memory Receive Options](#)
- [Error and Maintenance Messages](#)

## Use PC-Fax Receive to Transfer Received Faxes to Your Computer (Windows® only)

**Related Models:** DocuPrint M235 z/DocuPrint M275 z/DocuPrint M285 z

Turn on the PC-Fax Receive feature, automatically store incoming faxes to your machine's memory, and then send them to your computer. Use your computer to view and store these faxes.

To transfer the received faxes to your computer you must have the PC-FAX Receiving software running on your computer.

Even if you have turned off your computer (at night or on the weekend, for example), your machine will receive and store your faxes in its memory.

When you start your computer and the PC-FAX Receiving software runs, your machine transfers your faxes to your computer automatically.

If you selected [Backup Print: On], the machine will also print the fax.

>> [DocuPrint M235 z](#)

>> [DocuPrint M275 z/DocuPrint M285 z](#)

### DocuPrint M235 z

1. Press  (Fax).
2. Press **Menu**.
3. Press ▲ or ▼ to display the [Fax] option, and then press **OK**.
4. Press ▲ or ▼ to display the [Memory Receive] option, and then press **OK**.
5. Press ▲ or ▼ to display the [PC Fax Receive] option, and then press **OK**.



- PC-Fax Receive is not available for the Mac operating systems.
- If you get an error message and the machine cannot print the faxes in the memory, you can use this setting to transfer your faxes to your computer.

6. Press ▲ or ▼ to display [On], and then press **OK**.
7. Press **OK**.
8. Press ▲ or ▼ to display [<USB>] or your computer name, and then press **OK**.
9. Press ▲ or ▼ to display [On] or [Off] for the Backup Print setting, and then press **OK**.
10. Press **Stop/Exit**.

### DocuPrint M275 z/DocuPrint M285 z

1. Press  [Settings] > [All Settings] > [Fax] > [Setup Receive] > [PC Fax Receive].
2. Press [On].



- PC-Fax Receive is not available for the Mac operating systems.
- If you get an error message and the machine cannot print the faxes in the memory, you can use this setting to transfer your faxes to your computer.

3. Press [OK].
4. Press [<USB>] or the name of the computer you want to receive faxes if you are on a network, and then press [OK].

---

5. Press [Backup Print: On] or [Backup Print: Off].

6. Press .

---

 **Related Information**

- [Memory Receive Options](#)
-

## Remote Fax Retrieval

Use Remote Retrieval to call your machine from any touch-tone telephone or fax machine, and use a remote access code and remote commands to retrieve fax messages.

- [Set a Remote Access Code](#)
- [Use Your Remote Access Code](#)
- [Remote Retrieval Commands](#)
- [Forward Faxes Remotely](#)
- [Change the Fax Forwarding Number](#)

## Set a Remote Access Code

**Related Models:** DocuPrint M235 z/DocuPrint M275 z/DocuPrint M285 z

Set a Remote Access Code to access and control your Fuji Xerox machine even when you are away from it.

Before you can use the remote access and retrieval features, you must set up your own code. The factory default code is the inactive code (---\*).

>> [DocuPrint M235 z](#)

>> [DocuPrint M275 z/DocuPrint M285 z](#)

### DocuPrint M235 z

1. Press **Menu**.
2. Press **▲** or **▼** to display the [Fax] option, and then press **OK**.
3. Press **▲** or **▼** to display the [Memory Receive] option, and then press **OK**.
4. Press **▲** or **▼** to display the [Remote Access] option, and then press **OK**.
5. Enter a three-digit code using the numbers **0** to **9**, **\*** or **#** using the dial pad, and then press **OK**.



- To make your code inactive, press **Clear** to delete the three-digit code in this step. Then press **OK**.
- You cannot change the preset \*.
- DO NOT use the same code used for your Remote Activation Code (\*51) (\*91 for New Zealand) or Remote Deactivation Code (#51) (#91 for New Zealand) .

6. Press **Stop/Exit**.

### DocuPrint M275 z/DocuPrint M285 z

1. Press  [Settings] > [All Settings] > [Fax] > [Remote Access].
2. Enter a three-digit code using the numbers [0] to [9], [\*] or [#] using the the LCD (The preset '\*' cannot be changed), and then press [OK].



- DO NOT use the same code used for your Remote Activation Code (\*51) (\*91 for New Zealand) or Remote Deactivation Code (#51) (#91 for New Zealand).
- To make your code inactive, press and hold  to restore the inactive setting (---\*), and then press [OK].

3. Press .

### ✓ Related Information

- [Remote Fax Retrieval](#)



## Use Your Remote Access Code

**Related Models:** DocuPrint M235 z/DocuPrint M275 z/DocuPrint M285 z

1. Dial your fax number from a telephone or another fax machine using touch tone.
2. When your machine answers, immediately enter your Remote Access Code (three digits followed by \*).
3. The machine signals if it has received messages:
  - One long beep -- Fax messages
  - No beeps -- No messages
4. When the machine gives two short beeps, enter a command.
  - The machine will hang up if you wait longer than 30 seconds to enter a command.
  - The machine will beep three times if you enter an invalid command.
5. Press 9 0 to reset the machine when you are finished.
6. Hang up.
  - This function may not be available in some countries or supported by your local telephone company.



### Related Information

- [Remote Fax Retrieval](#)

## Remote Retrieval Commands

**Related Models:** DocuPrint M235 z/DocuPrint M275 z/DocuPrint M285 z

Use the Remote Commands in this table to access fax commands and options when you are away from your Fuji Xerox machine. When you call the machine and enter your remote access code (three digits followed by \*), the system will sound two short beeps and you must enter a Remote Command (column 1), followed by one of the options (column 2) for that command.

| Remote commands | Options   | Operation details   |
|-----------------|---|---|
| 95              | <b>Change the Fax Forwarding, or Fax Storage settings</b> |   |
|                 | 1 OFF   | You can select <i>Off</i> after you retrieve or erase all your messages.  |
|                 | 2 Fax Forwarding  | One long beep means the change is accepted. If you hear three short beeps, you cannot make a change because something has not been set up (for example, a Fax Forwarding number has not been registered). You can register your Fax Forwarding number by entering 4. After you register the number, Fax Forwarding will work. |
|                 | 4 Fax Forwarding number                                   |   |
| 6 Fax Storage   |   |   |
| 96              | <b>Retrieve a fax</b>                                     |   |
|                 | 2 Retrieve all faxes                                      | Enter the fax number of a remote fax machine to receive stored fax messages.  |
|                 | 3 Erase faxes from memory                                 | If you hear one long beep, fax messages have been erased from memory.   |
| 97              | <b>Check the receiving status</b>                         |   |
|                 | 1 Fax   | Check whether your machine has received any faxes. If yes, you will hear one long beep. If not, you will hear three short beeps.  |
| 98              | <b>Change the Receive Mode</b>                            |   |
|                 | 1 External TAD  | One long beep means the change has been accepted.   |
|                 | 2 Fax/Tel   |   |
|                 | 3 Fax Only  |   |
| 90              | <b>Exit</b>   | Press <b>9 0</b> to stop remote retrieval. Wait for the long beep, then hang up.  |



### Related Information

- [Remote Fax Retrieval](#)

## Forward Faxes Remotely

**Related Models:** DocuPrint M235 z/DocuPrint M275 z/DocuPrint M285 z

Call your Fuji Xerox machine from any touch-tone telephone or fax machine to forward incoming faxes to another machine.

You must turn on Fax Storage to use this feature.

1. Dial your fax number.
2. When your machine answers, enter your Remote Access Code (three digits followed by \*). If you hear one long beep, you have messages.
3. When you hear two short beeps, press 9 6 2.
4. Wait for the long beep, and then use the dial pad to enter the number of the remote fax machine where you want your fax messages sent, followed by # # (up to 20 digits).



You cannot use \* and # as dial numbers. However, press # if you want to create a pause.

5. Hang up after you hear your machine beep. Your machine will call the other fax machine, which will then print your fax messages.



### Related Information

- [Remote Fax Retrieval](#)

## Change the Fax Forwarding Number

**Related Models:** DocuPrint M235 z/DocuPrint M275 z/DocuPrint M285 z

You can change your fax forwarding number from another touch-tone telephone or fax machine.

1. Dial your fax number.
2. When your machine answers, enter your Remote Access Code (three digits followed by \*). If you hear one long beep, you have messages.
3. When you hear two short beeps, press 9 5 4.
4. Wait for the long beep, enter the new number (up to 20 digits) of the remote fax machine you want your fax messages forwarded to using the dial pad, then enter # #.

You will hear one long beep.



You cannot use \* and # as dial numbers. However, press # if you want to create a pause.

5. When you hear two short beeps, press 9 0 to stop Remote Access when you have finished.
6. Hang up after you hear your machine beep.



### Related Information

- [Remote Fax Retrieval](#)

## Voice Operations and Fax Numbers

- [Voice Operations](#)
- [Store Fax Numbers](#)
- [Dial a Number Using One Touch Dial](#)
- [Dial a Number Using Speed Dial](#)
- [Set up Groups for Broadcasting](#)
- [Combine Address Book Numbers](#)

## Voice Operations

- [Send Tone Signals](#)
- [Pick up a Voice Call in Fax/Tel Receive Mode](#)

## Send Tone Signals

**Related Models:** DocuPrint M235 z/DocuPrint M275 z/DocuPrint M285 z

If you have a Pulse dialling service, but must send Tone signals (for example, for telephone banking), follow these steps. If you have a Touch Tone service, you will not need this feature to send tone signals. (This feature is not available in New Zealand.)

>> [DocuPrint M235 z](#)

>> [DocuPrint M275 z/DocuPrint M285 z](#)

### DocuPrint M235 z

1. Press  (Fax).
2. Press **Hook**.
3. Press **#** on the machine's control panel.  
Any digits dialled after this will send tone signals.

When you are finished with the call, the machine will return to the Pulse dialling service.

### DocuPrint M275 z/DocuPrint M285 z

1. Press  ([Fax]).
2. Press [Hook].
3. Press **#** on the machine's LCD.  
Any digits dialled after this will send tone signals.

When you are finished with the call, the machine will return to the Pulse dialling service.

### Related Information

- [Voice Operations](#)

## Pick up a Voice Call in Fax/Tel Receive Mode

**Related Models:** DocuPrint M235 z/DocuPrint M275 z/DocuPrint M285 z

When the machine is in Fax/Tel mode, it will use the F/T Ring (fast double-ring) to alert you to pick up a voice call.

If you are at the machine, lift the external telephone's handset, and then press the button in the following table to answer:

| Applicable Models                 | To pick up voice call |
|-----------------------------------|-----------------------|
| DocuPrint M235 z                  | Hook                  |
| DocuPrint M275 z/DocuPrint M285 z | Pickup                |

If you are at an extension telephone, lift the handset during the F/T Ring, and then press #51 (#91 for New Zealand) between the fast double-rings. If no one is on the line, or if someone wants to send you a fax, send the call back to the machine by pressing \*51 (\*91 for New Zealand).

### Related Information

- [Voice Operations](#)



## Store Fax Numbers

- [Store Address Book Numbers](#)
- [Change or Delete Address Book Names or Numbers](#)

## Store Address Book Numbers

**Related Models:** DocuPrint M275 z/DocuPrint M285 z

1. Press  [ (Fax) ] > [Address Book].

2. Do the following steps:

a. Press [Edit].

b. Press [Add New Address].

c. Press [Name].

d. Enter the name using the LCD (up to 16 characters), and then press [OK].

e. Press [Address].

f. Enter the number using the LCD (up to 20 digits), and then press [OK].



- Be sure to include the area code when entering a fax or telephone number. Depending on the country, the Caller ID names and history may not be displayed correctly if the area code is not registered with the fax or telephone number.

g. Press [OK].

To store another Address Book number, repeat these steps.

3. Press .



### Related Information

- [Store Fax Numbers](#)
- [Store Address Book Numbers from Outgoing Calls](#)

## Store Address Book Numbers from Outgoing Calls

**Related Models:** DocuPrint M275 z/DocuPrint M285 z

You can store Address Book numbers from the Outgoing Call history.

1. Press  [(Fax)] > [Call History] > [Outgoing Call].
2. Press the number you want.
3. Press [Edit] > [Add to Address Book] > [Name].



To delete the number, press [Edit] > [Delete]. Press [Yes] to confirm.

4. Enter the name using the LCD (up to 16 characters).
5. Press [OK].
6. Press [OK] to confirm the fax or telephone number you want to store.
7. Press .



### Related Information

- [Store Address Book Numbers](#)

## Change or Delete Address Book Names or Numbers

**Related Models:** DocuPrint M275 z/DocuPrint M285 z

1. Press  [(Fax)] > [Address Book] > [Edit].
2. Do one of the following:
  - Press [Change] to edit the names or fax or telephone numbers.  
Press ▲ or ▼ to display the number you want to change, and then press it.
    - To change the name, press [Name]. Enter the new name (up to 16 characters) using the LCD, and then press [OK].
    - To change the fax or telephone number, press [Address]. Enter the new fax or telephone number (up to 20 digits) using the LCD, and then press [OK].Press [OK] to finish.



### How to enter text:

To change a character, press ◀ or ▶ to position the cursor to highlight the character you want to change, and then press . Enter the new character.

- To delete numbers, press ▲ or ▼ to display [Delete], and then press [Delete].
    - Select the fax or telephone numbers you want to delete by pressing them to display a red check mark, and then press [OK].
3. Press .



### Related Information

- [Store Fax Numbers](#)

## Dial a Number Using One Touch Dial

**Related Models:** DocuPrint M235 z

1. Press  (**Fax**).
2. Load your document.
3. Press the One Touch button assigned to the fax or telephone number you want to dial.



To dial One Touch numbers 1 to 4, press the One Touch button. To dial One Touch numbers 5 to 8, hold down **Shift** as you press the One Touch button.

4. Press **Start**.



### Related Information

- [Voice Operations and Fax Numbers](#)
- [Store One Touch Dial Numbers](#)
- [Change or Delete One Touch Dial Numbers](#)

## Store One Touch Dial Numbers

**Related Models:** DocuPrint M235 z

You can store eight One Touch Dial numbers on the four One Touch buttons. To access One Touch Dial Numbers 5 to 8, hold down **Shift** as you press the One Touch button.

1. Press  (**Fax**).
2. Press the One Touch button where you want to store the number.  
If a number is not stored there, the LCD displays [Register Now?].
3. Press **▲** to select [Yes].
4. Enter the telephone or fax number (up to 20 digits), and then press **OK**.
5. Do one of the following:
  - Enter the name using the dial pad (up to 16 characters), and then press **OK**.
  - To store the number without a name, press **OK**.



### Related Information

- [Dial a Number Using One Touch Dial](#)

## Change or Delete One Touch Dial Numbers

Related Models: DocuPrint M235 z

1. Press  (Fax).
2. Press ▲ three times.
3. Press ▲ or ▼ to display the [One Touch Dial] option, and then press **OK**.
4. Press the One Touch button you want to change or delete.
5. Do one of the following:
  - To change the stored name and number:
    - a. Press ▲.
    - b. Edit the name and number:

To edit the stored name or number, press ◀ or ▶ to move the cursor to the character you want to change, and then press **Clear**.

Enter the correct character, and then press **OK**.
  - To delete the stored name and number:
    - a. Press ▼.
    - b. Press ▲ to confirm.
  - To exit without making a change, press **Stop/Exit**.
6. Press **Stop/Exit**.







### Related Information

- [Dial a Number Using One Touch Dial](#)

## Dial a Number Using Speed Dial

**Related Models:** DocuPrint M235 z

1. Press  (**Fax**).
2. Load your document.
3. Do one of the following:
  - Press  twice and enter the three-digit Speed Dial code.
  - Press .

Press the dial pad buttons for the first few letters of the name, and then press **OK**.  
Press  or  to scroll until you find the name you are looking for, and then press **OK**.
4. Press **OK**.
5. Press **Start**.



### Related Information



- [Voice Operations and Fax Numbers](#)
- [Store Speed Dial Numbers](#)
- [Change or Delete Speed Dial Numbers](#)



## Store Speed Dial Numbers

**Related Models:** DocuPrint M235 z

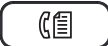
Use the Speed Dial numbers to store up to 200 numbers with a name.

1. Press  (**Fax**).
2. Press  twice and enter a three-digit Speed Dial code (001 - 200). Press **OK**.  
If a number is not stored there, the LCD displays [Register Now?].
3. Press  to select [Yes].
4. Enter the telephone or fax number (up to 20 digits), and then press **OK**.
5. Do one of the following:
  - Enter the name using the dial pad (up to 16 characters), and then press **OK**.
  - To store the number without a name, press **OK**.



### Related Information

- [Dial a Number Using Speed Dial](#)

## Change or Delete Speed Dial Numbers

**Related Models:** DocuPrint M235 z

You can change or delete Speed Dial Codes.

1. Press  (**Fax**).
2. Press ▲ three times.
3. Press ▲ or ▼ to display the [Speed Dial] option, and then press **OK**.
4. Enter the Speed Dial code you want to change or delete, and then press **OK**.
5. Do one of the following:
  - To change the stored fax or telephone number and name:
    - a. Press ▲.
    - b. Edit the number and name:

To edit the stored number or name, press ◀ or ▶ to move the cursor to the character you want to change, and then press **Clear**.

Enter the correct character, and then press **OK**.
  - To delete the stored fax or telephone number and name:
    - a. Press ▼.
    - b. Press ▲ to confirm.
  - To exit without making a change, press **Stop/Exit**.
6. Press **Stop/Exit**.



### Related Information

- [Dial a Number Using Speed Dial](#)

## Set up Groups for Broadcasting

**Related Models:** DocuPrint M235 z/DocuPrint M275 z/DocuPrint M285 z

A Group, which can be stored in the Address Book (One Touch Dial or Speed Dial in some models) allows you to send the same fax message to many fax numbers.



First, you must store each fax number in the Address Book. Then you can include them as numbers in the Group. Each Group uses up an Address Book (a One Touch Dial, or a Speed Dial in some models) number.

| Applicable Models                 | Maximum number of Group | Maximum numbers in a large Group |
|-----------------------------------|-------------------------|----------------------------------|
| DocuPrint M235 z                  | 20 groups               | 207 numbers                      |
| DocuPrint M275 z/DocuPrint M285 z | 20 groups               | 199 numbers                      |

>> [DocuPrint M235 z](#)

>> [DocuPrint M275 z/DocuPrint M285 z](#)

### DocuPrint M235 z

1. Press  (Fax).
2. Press ▲ three times.
3. Press ▲ or ▼ to display the [Setup Groups] option, and then press **OK**.
4. Do one of the following:
  - To store a Group in a Speed Dial location  
Press  and then enter the three-digit Speed Dial location, and then press **OK**.
  - To store a Group in a One Touch Dial location  
Press a One Touch button.
5. Use the dial pad to enter a Group number (01 to 20), and then press **OK**.
6. Add numbers to the Group:
  - To add Speed Dial Numbers  
Press  and then enter the three-digit Speed Dial location.
  - To add one Touch Dial Numbers  
press the One Touch keys one after the other.

The LCD will display selected Speed Dial numbers with a # and One Touch Dial numbers with a \* (for example \*006, #009).
7. Press **OK** when you finish adding numbers.
8. Enter the Group name using the dial pad (up to 16 characters).
9. Press **OK**.
10. Press **Stop/Exit**.

### DocuPrint M275 z/DocuPrint M285 z

1. Press  [(Fax)] > [Address Book].
2. Do the following steps:
  - a. Press [Edit] > [Setup Groups] > [Name].
  - b. Enter the Group name (up to 16 characters) using the LCD, and then press [OK].

- 
- c. Press [Add/Delete].
  - d. Add Address Book numbers to the Group by pressing them to display a red checkmark, and then press [OK].
  - e. Read and confirm the displayed list of names and numbers you have selected, and then press [OK] to save your Group.

To store another Group for broadcasting, repeat these steps.

3. Press .



### Related Information

- [Voice Operations and Fax Numbers](#)
  - [Change a Broadcasting Group Name](#)
  - [Delete a Broadcasting Group](#)
  - [Add or Delete a Broadcasting Group Member](#)
-



## Change a Broadcasting Group Name

**Related Models:** DocuPrint M235 z/DocuPrint M275 z/DocuPrint M285 z

>> [DocuPrint M235 z](#)

>> [DocuPrint M275 z/DocuPrint M285 z](#)

### DocuPrint M235 z

1. Press  (Fax).
2. Press ▲ three times.
3. Press ▲ or ▼ to display the [Setup Groups] option, and then press **OK**.
4. Do one of the following:
  - To change the Group name of a Group stored in a Speed Dial location  
Press  and then enter the three-digit Speed Dial location, and then press **OK**.
  - To change the Group name of a Group stored in a One Touch Dial location  
Press a One Touch button.
5. Press ▲ to change the stored Group information.
6. Press **OK**.
7. To edit the name, press ◀ or ▶ position the cursor under the character you want to change. Then press **Clear** to delete it, and enter the correct character using the dial pad.  
When you are finished editing, press **OK**.
8. Press **Stop/Exit**.

### DocuPrint M275 z/DocuPrint M285 z

1. Press  [(Fax)] > [Address Book] > [Edit] > [Change].
2. Press ▲ or ▼ to display the Group you want, and then press it.
3. Press [Name].
4. Enter the new Group name (up to 16 characters) using the LCD, and then press [OK].



How to change the stored name:

To change a character, press ◀ or ▶ to position the cursor to highlight the incorrect character, and then press .

Enter the new character.

5. Press [OK].
6. Press .

### ✓ Related Information

- [Set up Groups for Broadcasting](#)



## Delete a Broadcasting Group

**Related Models:** DocuPrint M235 z/DocuPrint M275 z/DocuPrint M285 z



>> [DocuPrint M235 z](#)

>> [DocuPrint M275 z/DocuPrint M285 z](#)

### DocuPrint M235 z

1. Press  (Fax).
2. Press ▲ three times.
3. Press ▲ or ▼ to display the [Setup Groups] option, and then press **OK**.
4. Do one of the following:
  - To delete a Group stored in a Speed Dial location  
Press  and then enter the three-digit Speed Dial location, and then press **OK**.
  - To delete a Group stored in a One Touch Dial location  
Press a One Touch button.
5. Press ▼ to delete the Group.
6. Press ▲ to confirm.
7. Press **Stop/Exit**.

### DocuPrint M275 z/DocuPrint M285 z

1. Press  [(Fax)] > [Address Book] > [Edit] > [Delete].
2. Press ▲ or ▼ to display the Group you want, and then press it.
3. Press [OK].
4. Press .

### Related Information

- [Set up Groups for Broadcasting](#)



## Add or Delete a Broadcasting Group Member

**Related Models:** DocuPrint M235 z/DocuPrint M275 z/DocuPrint M285 z



>> [DocuPrint M235 z](#)

>> [DocuPrint M275 z/DocuPrint M285 z](#)

### DocuPrint M235 z

1. Press  (Fax).
  2. Press **▲** three times.
  3. Press **▲** or **▼** to display the [Setup Groups] option, and then press **OK**.
  4. Do one of the following:
    - To change the numbers of a Group stored in a Speed Dial location  
Press  and then enter the three-digit Speed Dial location, and then press **OK**.
    - To change the numbers of a Group stored in a One Touch Dial location  
Press a One Touch button.
  5. Press **▲** to change the numbers stored in the Group.
  6. Add or delete One Touch or Speed Dial numbers
    - To add One Touch numbers  
Press **◀** or **▶** to position the cursor just after the last number.  
Then press the One Touch button of the number you want to add.
    - To add Speed Dial numbers  
Press **◀** or **▶** to position the cursor just after the last number.  
Then press  and then enter the three-digit Speed Dial location of the number you want to add.
    - To delete One Touch or Speed Dial numbers, press **◀** or **▶** to position the cursor under the number you want to delete, and then press **Clear**.
- When you are finished editing, press **OK**.
7. Press **OK**.
  8. Press **Stop/Exit**.

### DocuPrint M275 z/DocuPrint M285 z

1. Press  [(Fax)] > [Address Book] > [Edit] > [Change].
2. Press **▲** or **▼** to display the Group you want, and then press it.
3. Press **▲** or **▼** to display [Add/Delete], and then press it.
4. Press **▲** or **▼** to display the number you want to add or delete.
5. Do the following for each number you want to change:
  - To add a number to the Group, press the check box of the number to add a check mark.
  - To delete a number from the Group, press the check box of the number to remove the check mark.
6. Press [OK].
7. Press [OK].
8. Press .



## Related Information

- [Set up Groups for Broadcasting](#)



## Combine Address Book Numbers

**Related Models:** DocuPrint M235 z/DocuPrint M275 z/DocuPrint M285 z

Sometimes you may want to choose from several long-distance carriers when you send a fax. Rates may vary depending on the time and destination. To take advantage of low rates, you can store the access codes of long-distance carriers and credit card numbers as Address Book numbers.

You can store these long dialling sequences by dividing them and setting them up as separate Address Book numbers in any combination. You can even include manual dialling using the dial pad.

For example: You might have stored '01632' and '960555' in your machine as shown in the following table.



| Applicable Models                 | '01632' stored in          | '960555' stored in         |
|-----------------------------------|----------------------------|----------------------------|
| DocuPrint M235 z                  | Quick Dial: 003            | Quick Dial: 002            |
| DocuPrint M275 z/DocuPrint M285 z | Address Book: Fuji Xerox 1 | Address Book: Fuji Xerox 2 |

You can use them both to dial '01632-960555' by using the following procedure.

>> [DocuPrint M235 z](#)

>> [DocuPrint M275 z/DocuPrint M285 z](#)

### DocuPrint M235 z

1. Press  (Fax).
2. Press  twice, 003.
3. Press **OK**.
4. Press  twice, 002.
5. Press **OK**.
6. Press **Start**.







The machine will dial '01632-960555'.

To temporarily change a number, you can substitute part of the number by pressing it using the dial pad. For example, to change the number to '01632-960556', you could enter the number (01632) using Quick Dial 003, and then press 960556 using the dial pad.



If you must wait for another dial tone or signal at any point in the dialling sequence, create a pause in the number by pressing **Redial/Pause**.

### DocuPrint M275 z/DocuPrint M285 z

1. Press  [(Fax)] > [Address Book].
2. Press  or  to display the number of Fuji Xerox 1.
3. Press the number.
4. Press [Apply].
5. Press [Options].
6. Press  or  to display the [Address Book] option, and then press it.
7. Press  or  to display the number of Fuji Xerox 2.
8. Press the number.
9. Press [Apply].
10. Press [Fax Start].

---

The machine will dial '01632-960555'.

To temporarily change a number, you can substitute part of the number by pressing it using the LCD. For example, to change the number to '01632-960556', you could enter the number (Fuji Xerox 1: 01632) using Address Book, press [Apply], and then press 960556 using the LCD.



If you must wait for another dial tone or signal at any point in the dialling sequence, create a pause in the number by pressing [Pause].

---



### Related Information

- [Voice Operations and Fax Numbers](#)
-

## Telephone Services and External Devices

- [Distinctive Ring](#)
- [FaxAbility](#)
- [Caller ID](#)
- [External TAD \(Telephone Answering Device\)](#)
- [External and Extension Telephones](#)
- [Multi-line Connections \(PABX\)](#)

## Distinctive Ring

**Related Models:** DocuPrint M235 z/DocuPrint M275 z/DocuPrint M285 z



This feature is available only for some countries.

### For Australia

Distinctive Ring is a function of your Fuji Xerox machine that allows a person with one line to receive fax and voice calls through two different phone numbers on that one line. Fuji Xerox uses the term “Distinctive Ring”, but telephone companies market the service under a variety of names. This service establishes a second telephone number on the same line as your existing telephone number, and each number has its own ring pattern. Typically, the original number rings with the standard ring pattern and is used for receiving voice calls, and the second number rings with a different ring pattern and is used for receiving faxes. Only one call can be answered (or made) at any one time and while this call is in progress, incoming calls to either number will be presented with a busy tone.



- Contact your Telephone Service Provider to determine Distinctive Ring availability and any other related details.
- After you have set the Distinctive Ring feature to On, the receive mode is set to [Manual] automatically. Your Distinctive Ring Number does not allow Voice calls - only Faxes. You can not change the receive mode from [Manual] mode while the Distinctive Ring is set to on.

### How does your telephone company’s ‘Distinctive Ring’ service work?

Using “Distinctive Ring” service of your telephone company is the most efficient way to receive both fax and telephone calls on the same line. When the voice call comes in, all phones (extension and external) and the fax machine will ring to alert you to pick it up. If a fax call comes in, the fax machine will answer automatically without ringing, whereas the extension and external phones will ring twice with a Distinctive Ring pattern. It is also a more efficient way of operating a Fax machine with an extension phone as you do not have to use the remote activation codes. It gives you two independent numbers without the higher cost of a second line.

### Flowchart Sequence of Incoming call

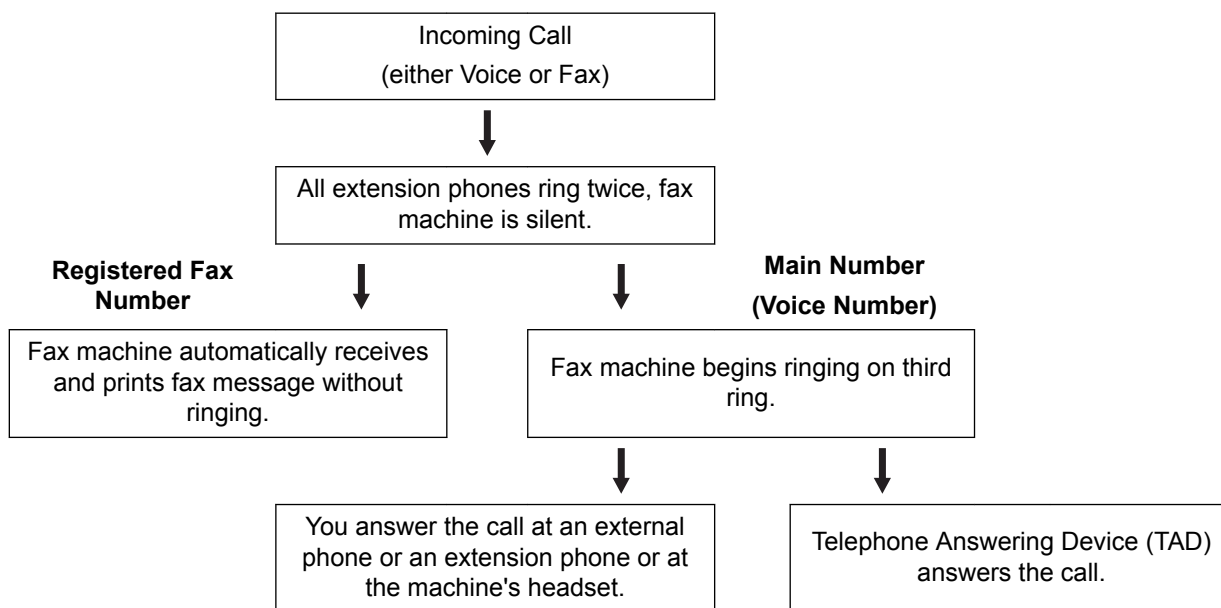

### What does Fuji Xerox’s ‘Distinctive Ring’ do?

The Fuji Xerox machine has a Distinctive Ring feature that allows you to use your machine to take full advantage of the telephone company’s Distinctive Ring service. The new telephone number on your line can just receive faxes.

---

## For Singapore and Hong Kong

This machine feature lets you use the Distinctive Ring subscriber service offered by some telephone companies, which allows you to have several telephone numbers on one phone line. Each phone number has its own Distinctive Ring pattern, so you will know which phone number is ringing. This is one way you can have a separate phone number for your machine.

Your machine has a Distinctive Ring function, allowing you to dedicate one phone number just for receiving faxes. You will need to set Distinctive Ring to On.



- You can switch it off temporarily, then turn it back on. When you get a new fax number, make sure you reset this function.
  - The machine will answer only calls to the Distinctive Ring number.
- 



### Related Information

- [Telephone Services and External Devices](#)
  - [Turn On Distinctive Ring](#)
  - [Turn Off Distinctive Ring](#)
-

## Turn On Distinctive Ring

**Related Models:** DocuPrint M235 z/DocuPrint M275 z/DocuPrint M285 z

### For Australia

After you set the Distinctive Ring feature to [On], the receive mode is automatically set to [Manual]. Your Distinctive Ring Number does not allow Voice calls - only Faxes. You cannot change the receive mode to another mode while the Distinctive Ring is set to on.

### For Singapore and Hong Kong

After you set the Distinctive Ring feature to [On], the receive mode is automatically set to [Manual]. Unless you have a TAD or Voice Mail set up on the Distinctive Ring number, Manual mode means you must answer all the calls yourself. You cannot change the receive mode to another mode while the Distinctive Ring is set to on.



When Distinctive Ring is on, the LCD will display [D/R] as the Receive Mode.



>> [DocuPrint M235 z](#)

>> [DocuPrint M275 z/DocuPrint M285 z](#)

## DocuPrint M235 z

1. Press  (Fax).
2. Press **Menu**.
3. Press ▲ or ▼ to display the [Fax] option, and then press **OK**.
4. Press ▲ or ▼ to display the [Miscellaneous] option, and then press **OK**.
5. Press ▲ or ▼ to display the [Distinctive] option, and then press **OK**.
6. Press ▲ or ▼ to display the [On] option, and then press **OK**.
7. Press **Stop/Exit**.

## DocuPrint M275 z/DocuPrint M285 z

1. Press  [Settings] > [All Settings] > [Fax] > [Miscellaneous] > [Distinctive].
2. Press [On].
3. Press .

## ✓ Related Information

- [Distinctive Ring](#)

## Turn Off Distinctive Ring

**Related Models:** DocuPrint M235 z/DocuPrint M275 z/DocuPrint M285 z

>> [DocuPrint M235 z](#)



>> [DocuPrint M275 z/DocuPrint M285 z](#)

### DocuPrint M235 z

1. Press  (Fax).
2. Press **Menu**.
3. Press ▲ or ▼ to display the [Fax] option, and then press **OK**.
4. Press ▲ or ▼ to display the [Miscellaneous] option, and then press **OK**.
5. Press ▲ or ▼ to display the [Distinctive] option, and then press **OK**.
6. Press ▲ or ▼ to display the [Off] option, and then press **OK**.
7. Press **Stop/Exit**.

If you turn off Distinctive Ring, the machine will stay in Manual Mode. You must set the Receive Mode again.

### DocuPrint M275 z/DocuPrint M285 z

1. Press  [Settings] > [All Settings] > [Fax] > [Miscellaneous] > [Distinctive].
2. Press [Off].
3. Press .

If you turn off Distinctive Ring, the machine will stay in Manual Mode. You must set the Receive Mode again.

### Related Information

- [Distinctive Ring](#)

## FaxAbility

**Related Models:** DocuPrint M235 z/DocuPrint M275 z/DocuPrint M285 z

This feature is available only in New Zealand.

FaxAbility is a service offered by Telecom that allows you to have an additional number on one phone line, with its own distinctive ring pattern. This way, when you get an incoming call, you can identify the number being called by its ring.

### How Will the Fax Machine Treat All Other Numbers?

FaxAbility mode ensures that the machine will answer calls to the FaxAbility (secondary) number. When a call comes in to your main number, all the phones will ring. You can set an external answering device (TAD) to answer calls on the other number(s). (See the chart below.)

### What is the Advantage of Using the FaxAbility Function?

Using FaxAbility is the most efficient way to receive both fax and telephone calls on the same line. It is much easier for your callers who dial manually. The fax machine will answer with receiving tones so they will not have to press an activation code. And the people who call to talk on your main number will not have to talk to your fax machine. Basically, it gives you two independent numbers without the higher cost of a second line.

### How Does FaxAbility Work?

For example, Your telephone number will have the standard ring pattern of long, long tone, while the new number will have a ring pattern of long, silence, long. When FaxAbility is On, you will not hear the first ring of all incoming calls on the fax machine. Extension phones will ring as usual. If the fax machine recognises the ring pattern, all ringing will stop and the fax machine will answer and automatically receive the fax message. Otherwise, you will hear the extension phones and the fax machine continue to ring. The fax machine always listens to the ring pattern before it answers, so do not pick up the phone during that time. You will quickly learn to recognise the ring pattern for faxes, so you will not be tempted to answer that number. Either you or a telephone answering device can answer the main number(s).

### Flowchart Sequence of Incoming call

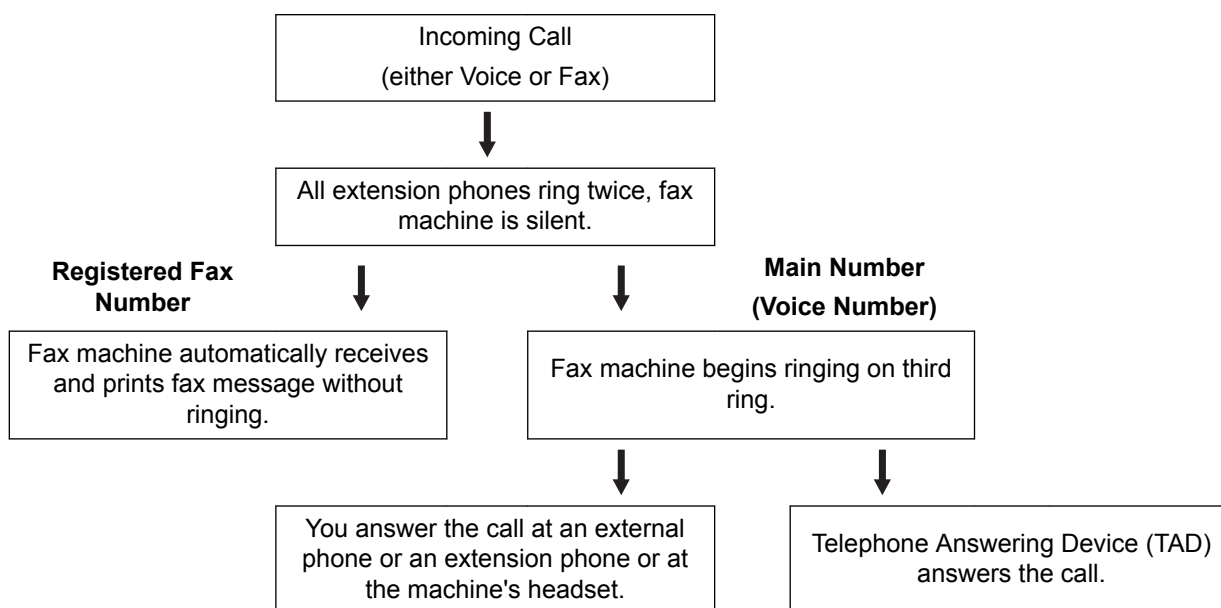

After you have set the FaxAbility feature to on, the receive mode is set to [Manual] automatically. Unless you have a TAD or Voice Mail set up on the FaxAbility number, Manual mode means you must answer all the call yourself. You can not change the receive mode to the other mode while the FaxAbility is set to on. When FaxAbility is on, the LCD will show [D/R] as the Receive Mode.





## Related Information

- [Telephone Services and External Devices](#)
  - [Turn FaxAbility On or Off](#)
-

## Turn FaxAbility On or Off

**Related Models:** DocuPrint M235 z/DocuPrint M275 z/DocuPrint M285 z

This feature is available only in New Zealand.

The FaxAbility function is designed to accommodate the FaxAbility service provided by Telecom.

Call Waiting beeps caused by incoming calls on your main number can affect fax transmissions. If you have FaxAbility Service but don't have Call Waiting, you need do nothing at this stage. If you do have Call Waiting as well as FaxAbility, set the Call Waiting menu option to On.

>> [DocuPrint M235 z](#)

>> [DocuPrint M275 z/DocuPrint M285 z](#)

### DocuPrint M235 z

1. Press  (Fax).
2. Press **Menu**.
3. Press **▲** or **▼** to display the [Fax] option, and then press **OK**.
4. Press **▲** or **▼** to display the [Miscellaneous] option, and then press **OK**.
5. Press **▲** or **▼** to display the [Faxability] option, and then press **OK**.
6. Press **▲** or **▼** to display the [On] (or [Off]) option, and then press **OK**.



- If you have FaxAbility service, select [On].
- To turn off FaxAbility, select [Off].

7. Press **▲** or **▼** to set the [Call Waiting] option to [On] or [Off], and then press **OK**.



- If you have Call Waiting service, select [On] to avoid the trouble caused by Call Waiting.
- To turn off Call Waiting, select [Off].

8. Press **Stop/Exit**.

### DocuPrint M275 z/DocuPrint M285 z

1. Press  [Settings] > [All Settings] > [Fax] > [Miscellaneous] > [FaxAbility].
2. Press [On] or [Off].



- If you have FaxAbility service, select [On].
- To turn off FaxAbility, select [Off].

3. Press [Call Waiting].
4. Press [On] or [Off].



- If you have Call Waiting service, select [On] to avoid the trouble caused by Call Waiting.
- To turn off Call Waiting, select [Off].

5. Press .



## Related Information

- [FaxAbility](#)

## Caller ID

**Related Models:** DocuPrint M235 z/DocuPrint M275 z/DocuPrint M285 z

The Caller ID feature lets you use the Caller ID subscriber service offered by many local telephone companies. This service displays the telephone number, or name if it is available, of your caller as the line rings.

- The [ID Unknown] message means the call originated outside your Caller ID service area.
- The [ID Withheld] message means the caller has intentionally blocked transmission of Caller ID information.

Call your telephone company for more information.

Once you answer a call, the Caller ID information disappears from the LCD and is stored in Caller ID memory.

View the list or select a number and add it to the Address Book (the Speed Dial or One the Touch Dial in some models), or delete it from the history.

You can print a list of the Caller ID information received by your machine.



- This feature is not available in some countries.
- The Caller ID service varies with different carriers. Contact your local telephone company to learn about the service available in your area.



### Related Information

- [Telephone Services and External Devices](#)

## External TAD (Telephone Answering Device)

**Related Models:** DocuPrint M235 z/DocuPrint M275 z/DocuPrint M285 z

You can connect an external Telephone Answering Device (TAD) to the same line as your machine. When the TAD answers a call, your machine will “listen” for the CNG (fax calling) tones sent by a sending fax machine. If it hears them it will take over the call and receive the fax. If it does not hear them, it will let your TAD take a voice message and the LCD will show [Telephone].

The external TAD must answer within four rings (we recommend setting it to two rings). This is because your machine cannot hear the CNG tones until the external TAD has picked up the call. The sending machine will send CNG tones for only eight to ten seconds longer. We do not recommend using the toll saver feature on your external TAD if it needs more than four rings to activate it.

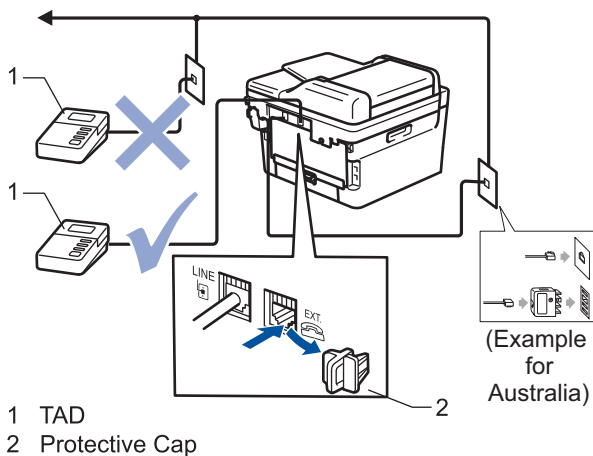

### IMPORTANT

DO NOT connect a TAD elsewhere on the same telephone line.



If you have problems receiving faxes, reduce the Ring Delay setting on your external TAD.



### Related Information

- [Telephone Services and External Devices](#)
- [Connect an External TAD](#)
- [Record an Outgoing Message \(OGM\) on the External TAD](#)

## Connect an External TAD

**Related Models:** DocuPrint M235 z/DocuPrint M275 z/DocuPrint M285 z

1. Set your external TAD to one or two rings. (The machine's Ring Delay setting does not apply.)
2. Record an outgoing message on your external TAD.
3. Set the TAD to answer calls.
4. Set the Receive Mode on your machine to [External TAD].



### Related Information

- [External TAD \(Telephone Answering Device\)](#)

## Record an Outgoing Message (OGM) on the External TAD

**Related Models:** DocuPrint M235 z/DocuPrint M275 z/DocuPrint M285 z

1. Record 5 seconds of silence at the beginning of your message. This allows your machine time to listen for fax tones.
2. Limit your speaking to 20 seconds.
3. End your 20-second message by giving your Remote Activation Code for people sending manual faxes. For example: "After the beep, leave a message or press \*51 and Start to send a fax."

### NOTE

We recommend beginning your OGM with an initial 5 second silence because the machine cannot hear fax tones over a loud voice. You may try leaving out this pause, but if your machine has trouble receiving faxes, then you should re-record the OGM to include it.



### Related Information

- [External TAD \(Telephone Answering Device\)](#)

## External and Extension Telephones

- [Connect an External or Extension Telephone](#)
- [Operation from External and Extension Telephones](#)
- [If You Use a Non-Fuji Xerox Cordless External Handset](#)
- [Use the Remote Codes](#)



## Connect an External or Extension Telephone

**Related Models:** DocuPrint M235 z/DocuPrint M275 z/DocuPrint M285 z

You can connect a separate telephone to your machine as shown in the diagram below.

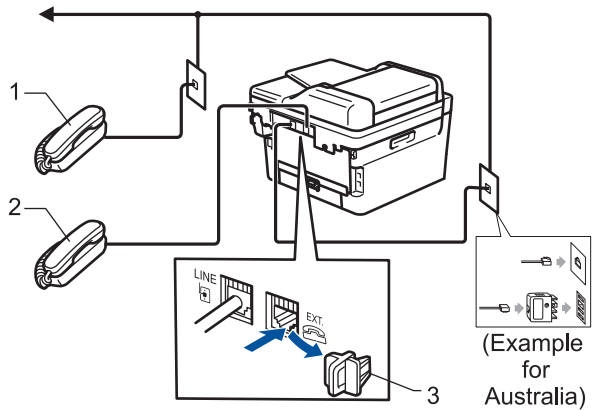

### ✓ Related Information

- [External and Extension Telephones](#)

## Operation from External and Extension Telephones

**Related Models:** DocuPrint M235 z/DocuPrint M275 z/DocuPrint M285 z

If you answer a fax call at an extension or an external telephone, you can make your machine take the call by using the Remote Activation Code. When you press the Remote Activation Code **\*51** (**\*91** for New Zealand), the machine starts to receive the fax.

If the machine answers a voice call and pseudo/double-rings for you to take over, you can take the call at an extension telephone by pressing the Remote Deactivation Code **#51** (**#91** for New Zealand).

### If you answer a call and no one is on the line:

You should assume that you're receiving a manual fax.

Press **\*51** (**\*91** for New Zealand) and wait for the chirp or until the LCD displays [Receiving], and then hang up.



You can also use the Fax Detect feature to make your machine automatically take the call.



### Related Information

- [External and Extension Telephones](#)

## If You Use a Non-Fuji Xerox Cordless External Handset

**Related Models:** DocuPrint M235 z/DocuPrint M275 z/DocuPrint M285 z

If your non-Fuji Xerox cordless telephone is connected to the telephone line cord and you typically carry the cordless handset elsewhere, it is easier to answer calls during the Ring Delay.

If you let the machine answer first, you must go to the machine so you can press [Pickup] or **Hook** to transfer the call to the cordless handset.



### Related Information

- [External and Extension Telephones](#)

## Use the Remote Codes

**Related Models:** DocuPrint M235 z/DocuPrint M275 z/DocuPrint M285 z

### Remote Activation Code

If you answer a fax call on an extension or external telephone, you can tell your machine to receive it by pressing the Remote Activation Code **\*51** (**\*91** for New Zealand). Wait for the chirping sounds, and then replace the handset.

If you answer a fax call at the external telephone, you can make the machine receive the fax by pressing the buttons in the following table:

| Applicable Models                 | To make the machine receive the fax      |
|-----------------------------------|--|
| DocuPrint M235 z                  | <b>Start</b> and then <b>▼</b>           |
| DocuPrint M275 z/DocuPrint M285 z | Fax <b>Start</b> and then <b>Receive</b> |

### Remote Deactivation Code

If you receive a voice call and the machine is in F/T mode, it will start to sound the F/T ring (fast double-ring) after the initial ring delay. If you pick up the call on an extension telephone you can turn the F/T ring off by pressing **#51** (**#91** for New Zealand) (make sure you press this between the rings).

If the machine answers a voice call and fast double-rings for you to take over, you can take the call at the external telephone by pressing the button in the following table:

| Applicable Models                 | To pick up voice call |
|-----------------------------------|-----------------------|
| DocuPrint M235 z                  | <b>Hook</b>           |
| DocuPrint M275 z/DocuPrint M285 z | <b>Pickup</b>         |



### Related Information

- [External and Extension Telephones](#)
- [Change the Remote Codes](#)

## Change the Remote Codes

**Related Models:** DocuPrint M235 z/DocuPrint M275 z/DocuPrint M285 z

The preset Remote Activation Code is \*51 (\*91 for New Zealand). The preset Remote Deactivation Code is #51 (#91 for New Zealand). If you are always disconnected when accessing your External TAD remotely, try changing the three-digit remote codes using the numbers 0-9, \*, #.

>> [DocuPrint M235 z](#)

>> [DocuPrint M275 z/DocuPrint M285 z](#)

### DocuPrint M235 z



1. Press  (Fax).
2. Press **Menu**.
3. Press ▲ or ▼ to display the [Fax] option, and then press **OK**.
4. Press ▲ or ▼ to display the [Setup Receive] option, and then press **OK**.
5. Press ▲ or ▼ to display the [Remote Codes] option, and then press **OK**.
6. Press ▲ or ▼ to display the [On] option, and then press **OK**.



- To turn off Remote Codes, select the [Off] option.

7. Enter the new Remote Activation Code, and then press **OK**.
8. Enter the new Remote Deactivation Code, and then press **OK**.
9. Press **Stop/Exit**.

### DocuPrint M275 z/DocuPrint M285 z

1. Press  [Settings] > [All Settings] > [Fax] > [Setup Receive] > [Remote Codes].
2. Do one of the following:
  - To change the Remote Activation Code, press [Act.Code]. Enter the new code, and then press [OK].
  - To change the Remote Deactivation Code, press [Deact.Code]. Enter the new code, and then press [OK].
  - If you do not want to change the Codes, go to the next step.
  - To turn off (or turn on) the Remote Codes, press [Remote Codes], and then press [Off] (or [On]).
3. Press .

### Related Information

- [Use the Remote Codes](#)

## Multi-line Connections (PABX)

**Related Models:** DocuPrint M235 z/DocuPrint M275 z/DocuPrint M285 z

Most offices use a central telephone system.

Fuji Xerox recommends that all our machines be connected to a discreet (dedicated) line. Although a particular PABX may appear to work with a particular model of fax machine, we cannot guarantee that the unit will operate correctly.

While it is often relatively simple to connect a fax machine to a PABX, (Private Automatic Branch Exchange), we suggest that you contact the company that installed your telephone system and ask them to connect the fax machine for you.

Fuji Xerox does not recommend the use of a PABX line. PABX limitations in general can cause some functions of the fax machine not to work correctly.



### Related Information

- [Telephone Services and External Devices](#)

## Fax Reports

The Transmission Verification Report and the Fax Journal are available to confirm the results of fax transmission.

- [Print a Transmission Verification Report](#)
- [Print a Fax Journal](#)

## Print a Transmission Verification Report

**Related Models:** DocuPrint M235 z/DocuPrint M275 z/DocuPrint M285 z

You can use the Transmission Verification Report as proof that you sent a fax. This report lists the receiving party's name or fax number, the time and date of transmission, duration of transmission, number of pages sent, and whether or not the transmission was successful.

There are several settings available for the Transmission Verification Report:

|                     |  |
|---------------------|--|
| On                  | Prints a report after every fax you send.  |
| On (+Image)         | Prints a report after every fax you send.<br>A portion of the fax's first page appears on the report.                                |
| Error only          | Prints a report if your fax is unsuccessful due to a transmission error.<br>Error only is the factory setting.                       |
| Error only (+Image) | Prints a report if your fax is unsuccessful due to a transmission error.<br>A portion of the fax's first page appears on the report. |
| Off                 | Your Fuji Xerox machine does not print any reports after sending faxes.  |



>> [DocuPrint M235 z](#)

>> [DocuPrint M275 z/DocuPrint M285 z](#)

### DocuPrint M235 z

1. Press **Menu**.
2. Press **▲** or **▼** to display the [Fax] option, and then press **OK**.
3. Press **▲** or **▼** to display the [Report Setting] option, and then press **OK**.
4. Press **▲** or **▼** to display the [XMIT Verify] option, and then press **OK**.
5. Press **▲** or **▼** to display the [Error Only], [ErrorOnly+Image], [Off], [On (+Image)], or [On (+Image)] option, and press **OK**.
6. Press **Stop/Exit**.

### DocuPrint M275 z/DocuPrint M285 z

1. Press  [Settings] > [All Settings] > [Fax] > [Report Setting] > [XMIT Report].
  2. Press **▲** or **▼** to select the option you want.  
If you select [On+Image] or [Error only (+Image)], the image will not appear on the Transmission Verification Report if Real Time Transmission is set to [On].
  3. Press .
- If the transmission is successful, OK appears next to RESULT on the Transmission Verification Report. If the transmission is not successful, NG appears next to RESULT.

### Related Information

- [Fax Reports](#)



## Print a Fax Journal

**Related Models:** DocuPrint M235 z/DocuPrint M275 z/DocuPrint M285 z

You can set the machine to print a Fax Journal at specific intervals (every 50 faxes, 6, 12 or 24 hours, 2 or 7 days).

>> [DocuPrint M235 z](#)

>> [DocuPrint M275 z/DocuPrint M285 z](#)

### DocuPrint M235 z

1. Press **Menu**.
2. Press **▲** or **▼** to display the [Fax] option, and then press **OK**.
3. Press **▲** or **▼** to display the [Report Setting] option, and then press **OK**.
4. Press **▲** or **▼** to display the [Journal Period] option, and then press **OK**.
5. Press **▲** or **▼** to display the [Every 50Faxes], [Every 6Hours], [Every 12Hours], [Every 24Hours], [Every 2Days], [Every 7Days], or [Off] option, and then press **OK**.
  - 6, 12, 24 hours, 2 or 7 days  
The machine will print the report at the selected time and then erase all jobs from its memory. If the machine's memory becomes full with 200 jobs before the time you selected has passed, the machine will print the Journal early and then erase all jobs from the memory. If you want an extra report before it is due to print, you can print it without erasing the jobs from the memory.
  - Every 50 Faxes  
The machine will print the Journal when the machine has stored 50 jobs.
6. If you chose Every 7 Days, press **▲** or **▼** to display the [Every Monday], [Every Tuesday], [Every Wednesday], [Every Thursday], [Every Friday], [Every Saturday] or [Every Sunday] option, and then press **OK**.
7. If you selected 6, 12, 24 hours, 2 or 7 days, do one of the following to enter the time to start printing:
  - If you selected [12h Clock] in the Date&Time setting, enter the time in 12-hour format, and then press **OK**.  
Press **▲** or **▼** to display the [AM] or [PM] option, and then press **OK**.
  - If you selected [24h Clock] in the Date&Time setting, enter the time in 24-hour format, and then press **OK**.  
(For example, enter 19:45 for 7:45 PM.)
8. Press **Stop/Exit**.

### DocuPrint M275 z/DocuPrint M285 z

1. Press  [Settings] > [All Settings] > [Fax] > [Report Setting] > [Journal Period] > [Journal Period].
2. Press **▲** or **▼** to select an interval.
  - 6, 12, 24 hours, 2 or 7 days  
The machine will print the report at the selected time and then erase all jobs from its memory. If the machine's memory becomes full with 200 jobs before the time you selected has passed, the machine will print the Journal early and then erase all jobs from the memory. If you want an extra report before it is due to print, you can print it without erasing the jobs from the memory.
  - Every 50 Faxes  
The machine will print the Journal when the machine has stored 50 jobs.
3. If you selected 6, 12, 24 hours, 2 or 7 days, press [Time] and enter the time using the LCD, and then press [OK].

- 
4. If you selected [Every 7 Days], **press** [Day].
  5. Press ▲ or ▼ to display the [Every Monday], [Every Tuesday], [Every Wednesday], [Every Thursday], [Every Friday], [Every Saturday] or [Every Sunday] option, and then press the first day of the 7-day countdown.
  6. Press .



## Related Information

- [Fax Reports](#)
-

## PC-FAX

- [PC-FAX for Windows®](#)
- [PC-FAX for Mac](#)

## PC-FAX for Windows®

- [PC-FAX Overview \(Windows®\)](#)
- [Send a Fax Using PC-FAX \(Windows®\)](#)
- [Receive Faxes on Your Computer \(Windows®\)](#)

## PC-FAX Overview (Windows®)

Reduce paper consumption and save time by using Fuji Xerox's PC-FAX software to send faxes directly from your machine.

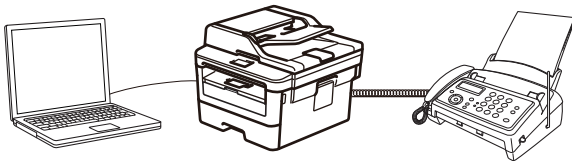

- [Configure PC-FAX \(Windows®\)](#)
- [Configure your PC-Fax Address Book \(Windows®\)](#)

## Configure PC-FAX (Windows®)

**Related Models:** DocuPrint M235 z/DocuPrint M275 z/DocuPrint M285 z

Before sending faxes using PC-FAX, personalise the send options in each tab of the **PC-FAX Setup** dialog box.

1. Do one of the following:

- Windows® 7

Click  (**Start**) > **All Programs** > **Fuji Xerox** > **Fuji Xerox Utilities**.

Click the drop-down list and select your model name (if not already selected). Click **PC-FAX** in the left navigation bar, and then click **Setup Sending**.

- Windows® 8 and Windows® 10

Launch  (**Fuji Xerox Utilities**), and then click the drop-down list and select your model name (if not already selected). Click **PC-FAX** in the left navigation bar, and then click **Setup Sending**.

The **PC-FAX Setup** dialog box appears.

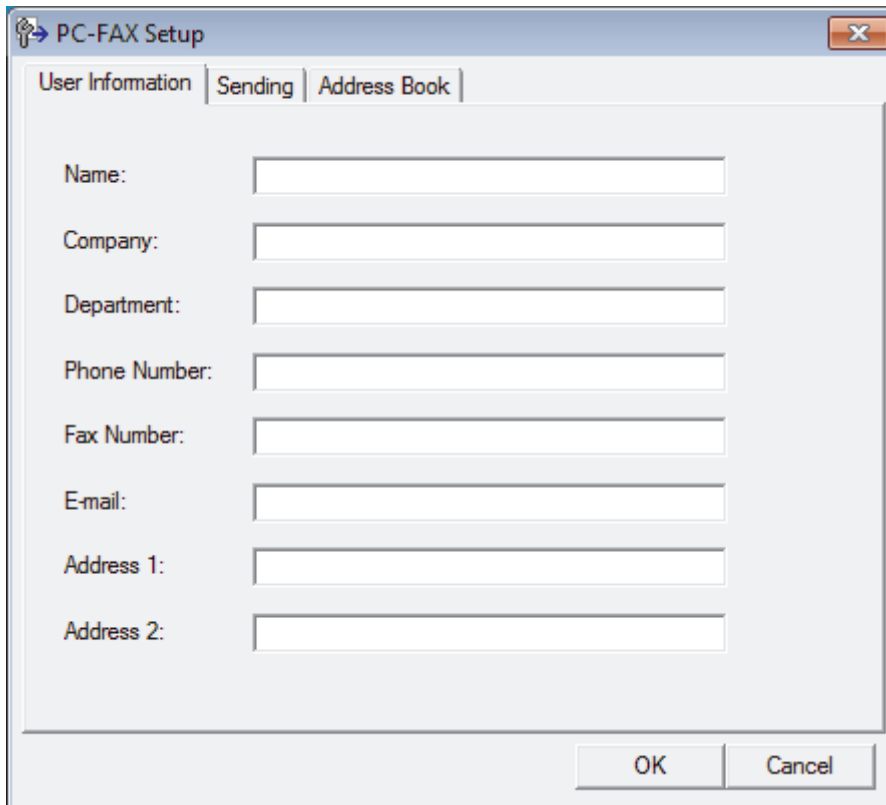

The screenshot shows the 'PC-FAX Setup' dialog box with the 'User Information' tab selected. The dialog box has a title bar with a close button. Below the title bar are three tabs: 'User Information', 'Sending', and 'Address Book'. The 'User Information' tab contains several text input fields: 'Name:', 'Company:', 'Department:', 'Phone Number:', 'Fax Number:', 'E-mail:', 'Address 1:', and 'Address 2:'. At the bottom of the dialog box are 'OK' and 'Cancel' buttons.

2. Do one of the following:

- Click the **User Information** tab, and then type your user information in the fields.



Each Microsoft® account can have its own customised **User Information** screen for custom fax headers and cover pages.

- Click the **Sending** tab, and then type the number needed to access an outside line (if needed) in the **Outside line access** field. Select the **Include header** check box to include the header information.
- Click the **Address Book** tab, and then select the address book you want to use for PC-FAX from the **Select Address Book** drop-down list.

3. Click **OK**.



## Related Information

- [PC-FAX Overview \(Windows®\)](#)

## Configure your PC-Fax Address Book (Windows®)

Add, edit and delete members and groups to personalise your Fuji Xerox **Address Book**.

- [Add a Member to your PC-FAX Address Book \(Windows®\)](#)
- [Create a Group in your PC-FAX Address Book \(Windows®\)](#)
- [Edit Member or Group Information in your PC-FAX Address Book \(Windows®\)](#)
- [Delete a Member or Group in your PC-FAX Address Book \(Windows®\)](#)
- [Export your PC-FAX Address Book \(Windows®\)](#)
- [Import Information to your PC-FAX Address Book \(Windows®\)](#)



## Add a Member to your PC-FAX Address Book (Windows®)

**Related Models:** DocuPrint M235 z/DocuPrint M275 z/DocuPrint M285 z

Add new people and their fax information to the PC-Fax Address Book if you want to send a fax using Fuji Xerox PC-Fax software.

1. Do one of the following:

- Windows® 7

Click  (**Start**) > **All Programs** > **Fuji Xerox** > **Fuji Xerox Utilities**.

Click the drop-down list and select your model name (if not already selected). Click **PC-FAX** in the left navigation bar, and then click **Address Book (Send)**.

- Windows® 8 and Windows® 10

Launch  (**Fuji Xerox Utilities**), and then click the drop-down list and select your model name (if not already selected). Click **PC-FAX** in the left navigation bar, and then click **Address Book (Send)**.

The **Address Book** dialog box appears.

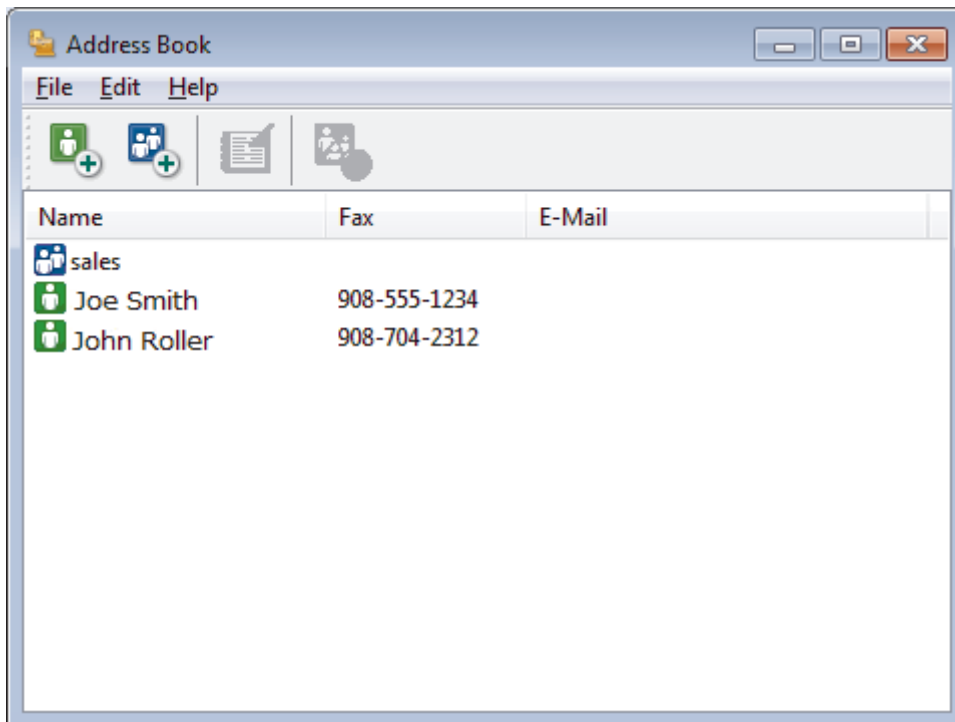

2. Click .

The **Address Book Member Setup** dialog box appears.

Address Book Member Setup

Name:  Title:

Company:

Department:  Job Title:

Street Address:

City:  State/Province:

Zip Code/Post Code:  Country/Region:

Business Phone:  Home Phone:

Fax:  Mobile Phone:

E-Mail:

OK Cancel

3. Type the member's information in the corresponding fields. Only the **Name** field is required.
4. Click **OK**.



### Related Information

- [Configure your PC-Fax Address Book \(Windows®\)](#)

## Create a Group in your PC-FAX Address Book (Windows®)

**Related Models:** DocuPrint M235 z/DocuPrint M275 z/DocuPrint M285 z

Create a group to broadcast the same PC-FAX to several recipients at one time.

1. Do one of the following:

- Windows® 7

Click  (**Start**) > **All Programs** > **Fuji Xerox** > **Fuji Xerox Utilities**.

Click the drop-down list and select your model name (if not already selected). Click **PC-FAX** in the left navigation bar, and then click **Address Book (Send)**.

- Windows® 8 and Windows® 10

Launch  (**Fuji Xerox Utilities**), and then click the drop-down list and select your model name (if not already selected). Click **PC-FAX** in the left navigation bar, and then click **Address Book (Send)**.

The **Address Book** dialog box appears.

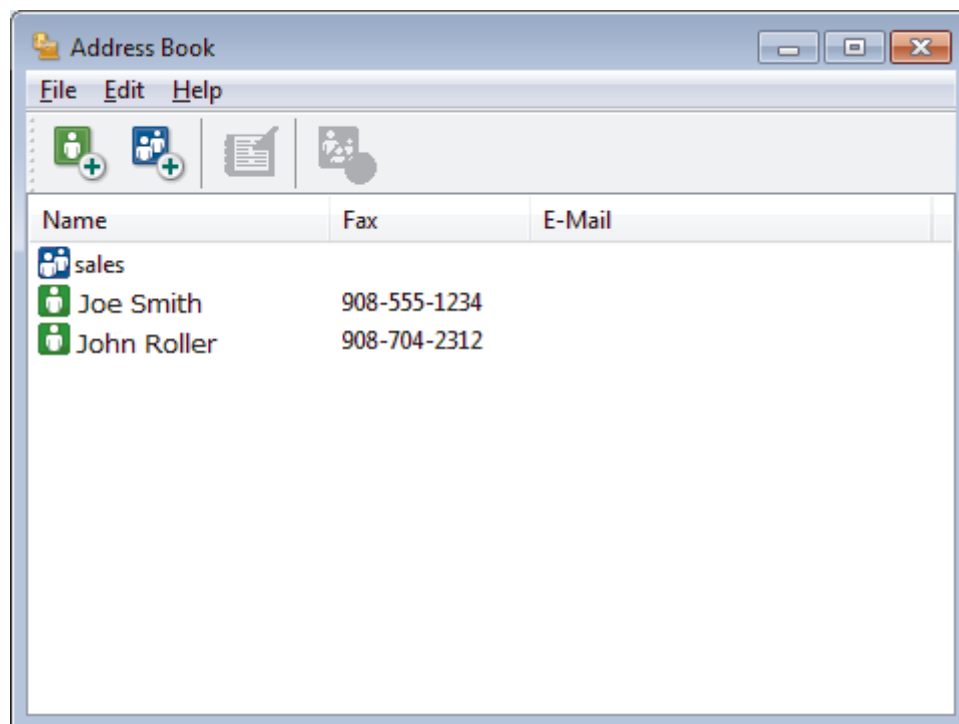

2. Click .

The **Address Book Group Setup** dialog box appears.

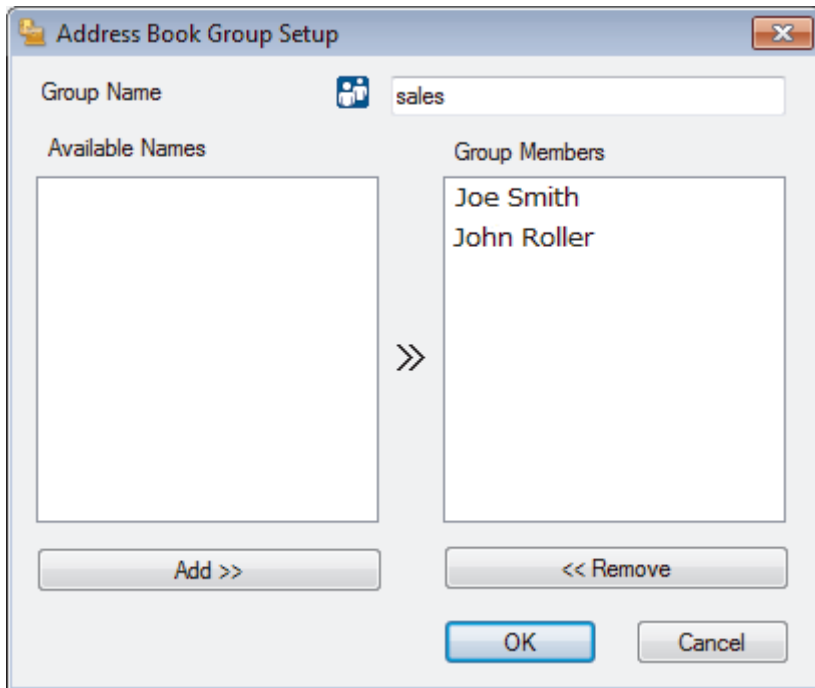

3. Type the name of the new group in the **Group Name** field.
4. In the **Available Names** field, select each name you want to include in the group, and then click **Add >>**. Members added to the group appear in the **Group Members** box.
5. When finished, click **OK**.



Each group can contain up to 50 members.



### Related Information

- [Configure your PC-Fax Address Book \(Windows®\)](#)

## Edit Member or Group Information in your PC-FAX Address Book (Windows®)

**Related Models:** DocuPrint M235 z/DocuPrint M275 z/DocuPrint M285 z

1. Do one of the following:

- Windows® 7

Click  (**Start**) > **All Programs** > **Fuji Xerox** > **Fuji Xerox Utilities**.

Click the drop-down list and select your model name (if not already selected). Click **PC-FAX** in the left navigation bar, and then click **Address Book (Send)**.

- Windows® 8 and Windows® 10

Launch  (**Fuji Xerox Utilities**), and then click the drop-down list and select your model name (if not already selected). Click **PC-FAX** in the left navigation bar, and then click **Address Book (Send)**.

The **Address Book** dialog box appears.

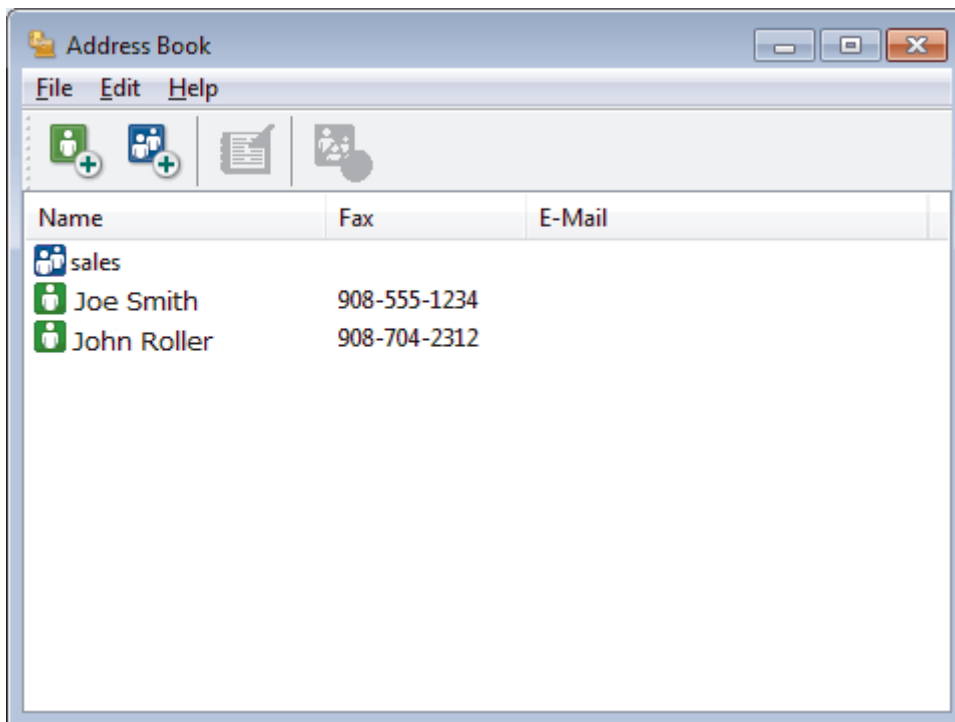

2. Select the member or group you want to edit.
3. Click  (**Properties**).
4. Change the member or group information.
5. Click **OK**.

### **Related Information**

- [Configure your PC-Fax Address Book \(Windows®\)](#)

## Delete a Member or Group in your PC-FAX Address Book (Windows®)

**Related Models:** DocuPrint M235 z/DocuPrint M275 z/DocuPrint M285 z

1. Do one of the following:

- Windows® 7

Click  (**Start**) > **All Programs** > **Fuji Xerox** > **Fuji Xerox Utilities**.

Click the drop-down list and select your model name (if not already selected). Click **PC-FAX** in the left navigation bar, and then click **Address Book (Send)**.

- Windows® 8 and Windows® 10

Launch  (**Fuji Xerox Utilities**), and then click the drop-down list and select your model name (if not already selected). Click **PC-FAX** in the left navigation bar, and then click **Address Book (Send)**.

The **Address Book** dialog box appears.

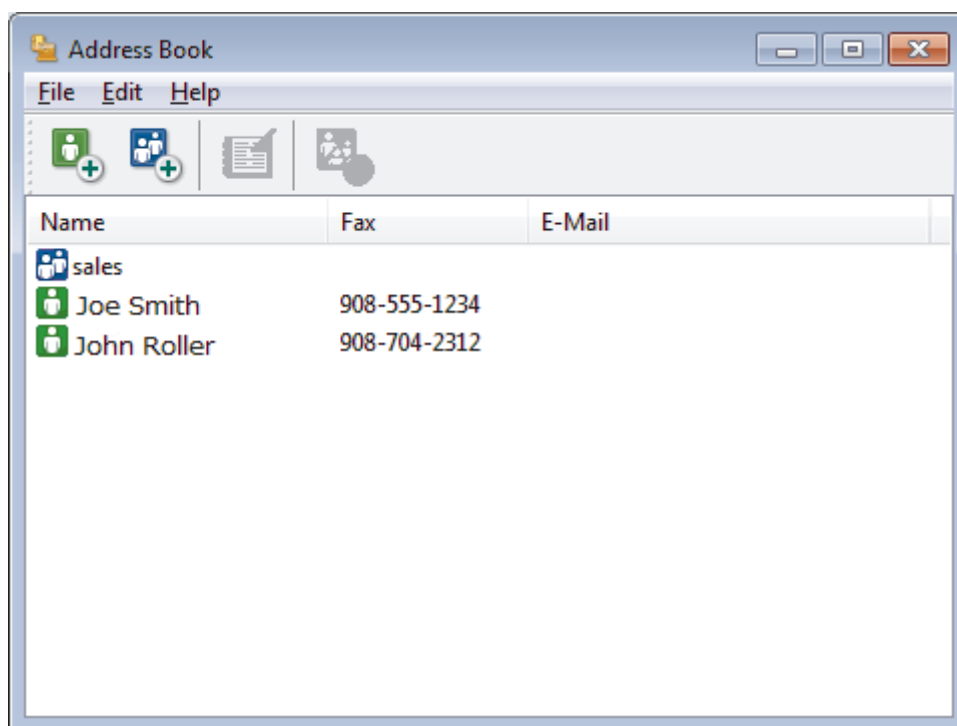

2. Select the member or group you want to delete.

3. Click  (**Delete**).

4. When the confirmation dialog box appears, click **OK**.

### Related Information

- [Configure your PC-Fax Address Book \(Windows®\)](#)

## Export your PC-FAX Address Book (Windows®)

**Related Models:** DocuPrint M235 z/DocuPrint M275 z/DocuPrint M285 z

You can export the Address Book as an ASCII text file (\*.csv), a vCard (an electronic business card), or **Remote Setup Dial Data** and save it on your computer.

- You cannot export the group settings when you export the **Address Book** data.

1. Do one of the following:

- Windows® 7

Click  (**Start**) > **All Programs** > **Fuji Xerox** > **Fuji Xerox Utilities**.

Click the drop-down list and select your model name (if not already selected). Click **PC-FAX** in the left navigation bar, and then click **Address Book (Send)**.

- Windows® 8 and Windows® 10

Launch  (**Fuji Xerox Utilities**), and then click the drop-down list and select your model name (if not already selected). Click **PC-FAX** in the left navigation bar, and then click **Address Book (Send)**.

The **Address Book** dialog box appears.

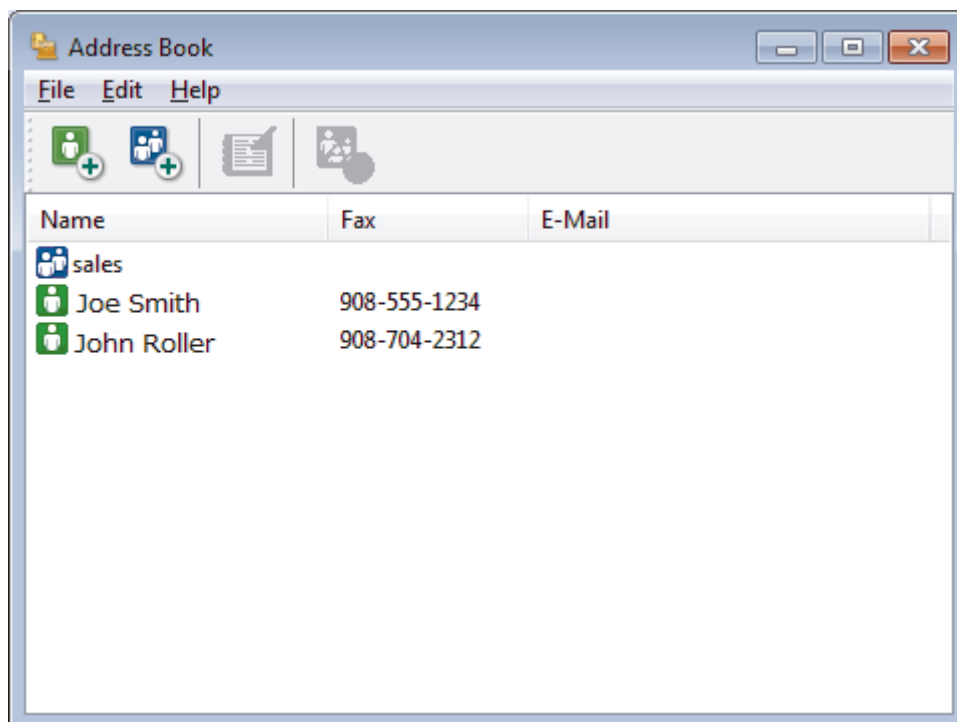

2. Click the **File** menu, and then select **Export**.

3. Select one of the following:

- Text**

The **Select Items** dialog box appears. Go to step 4.

- vCard**

You must select the member you want to export from your address book before selecting this option.

Browse to the folder where you want to save the vCard, type the vCard name in the **File name** field, and then click **Save**.

- **Remote Setup Dial Data**

Browse to the folder where you want to save the data, type the file name in the **File name** field, and then click **Save**.

4. In the **Available Items** field, select the data you want to export, and then click **Add >>**.

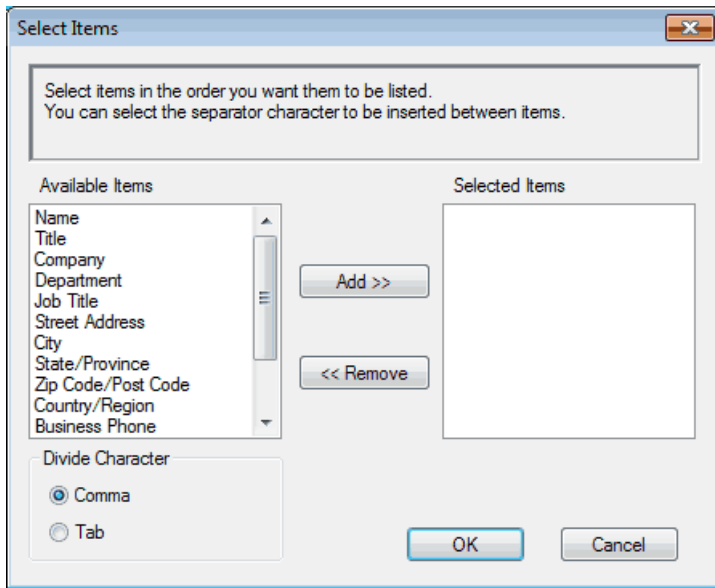

Select and add the items in the order you want them listed.

5. If you are exporting to an ASCII file, under the **Divide Character** section, select the **Tab** or **Comma** option to separate the data fields.
6. Click **OK**.
7. Browse to the folder on your computer where you want to save the data, type the file name, and then click **Save**.



## Related Information

- [Configure your PC-Fax Address Book \(Windows®\)](#)



## Import Information to your PC-FAX Address Book (Windows®)

**Related Models:** DocuPrint M235 z/DocuPrint M275 z/DocuPrint M285 z

You can import ASCII text files (\*.csv), vCards (electronic business cards), or **Remote Setup Dial Data** into your Address Book.

1. Do one of the following:

- Windows® 7

Click  (**Start**) > **All Programs** > **Fuji Xerox** > **Fuji Xerox Utilities**.

Click the drop-down list and select your model name (if not already selected). Click **PC-FAX** in the left navigation bar, and then click **Address Book (Send)**.

- Windows® 8 and Windows® 10

Launch  (**Fuji Xerox Utilities**), and then click the drop-down list and select your model name (if not already selected). Click **PC-FAX** in the left navigation bar, and then click **Address Book (Send)**.

The **Address Book** dialog box appears.

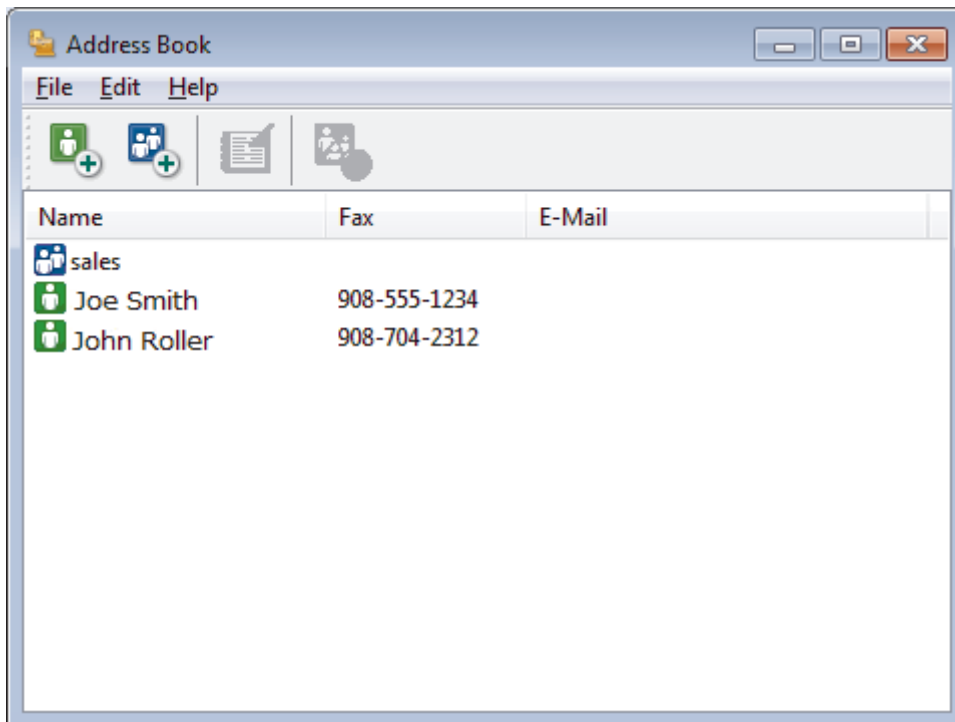

2. Click the **File** menu, and then select **Import**.

3. Select one of the following:

- **Text**

The **Select Items** dialog box appears. Go to step 4.

- **vCard**

Go to step 7.

- **Remote Setup Dial Data**

Go to step 7.

4. In the **Available Items** field, select the data you want to import, and then click **Add >>**.

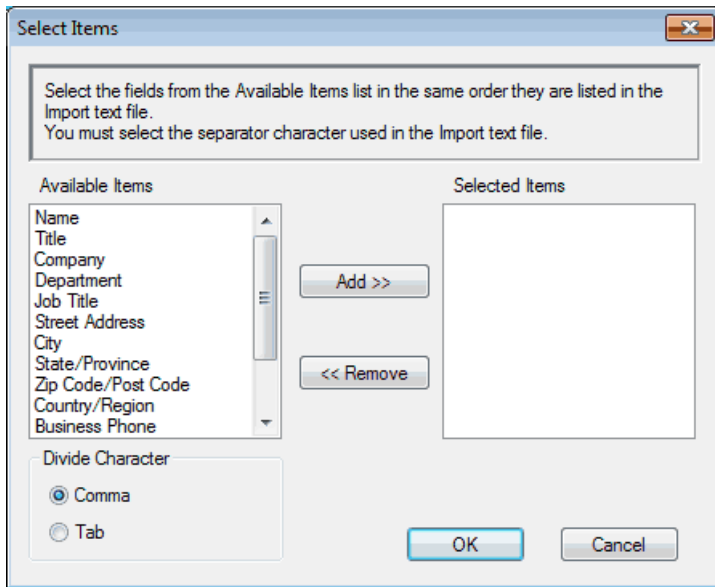

You must select and add fields from the **Available Items** list in the same order they are listed in the import text file.

5. If you are importing an ASCII file, under the **Divide Character** section, select the **Tab** or **Comma** option to separate the data fields.
6. Click **OK**.
7. Browse to the folder where you want to import the data, type the file name, and then click **Open**.

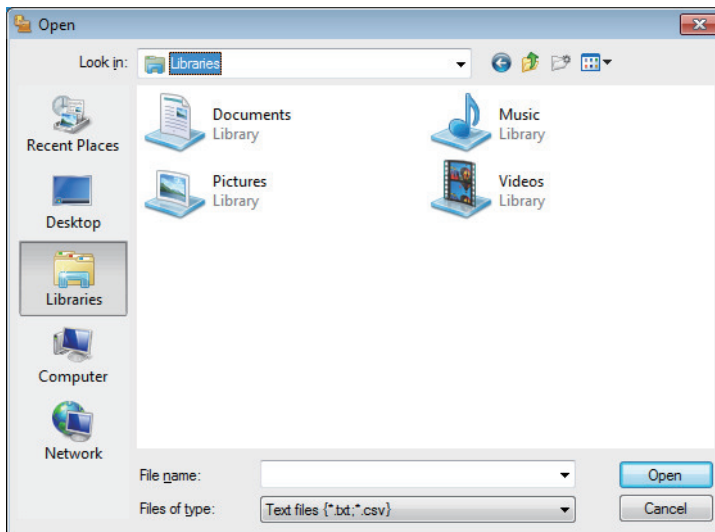

## Related Information

- [Configure your PC-Fax Address Book \(Windows®\)](#)

## Send a Fax Using PC-FAX (Windows®)

**Related Models:** DocuPrint M235 z/DocuPrint M275 z/DocuPrint M285 z

PC-FAX supports only monochrome faxes. A monochrome fax will be sent even if the original data is colour and the receiving fax machine supports colour faxes.

1. Create a file in any application on your computer.
2. Select the print command in your application.
3. Select **PC-FAX** as your printer, and then complete your print operation.

The **PC-FAX** dialog box appears.

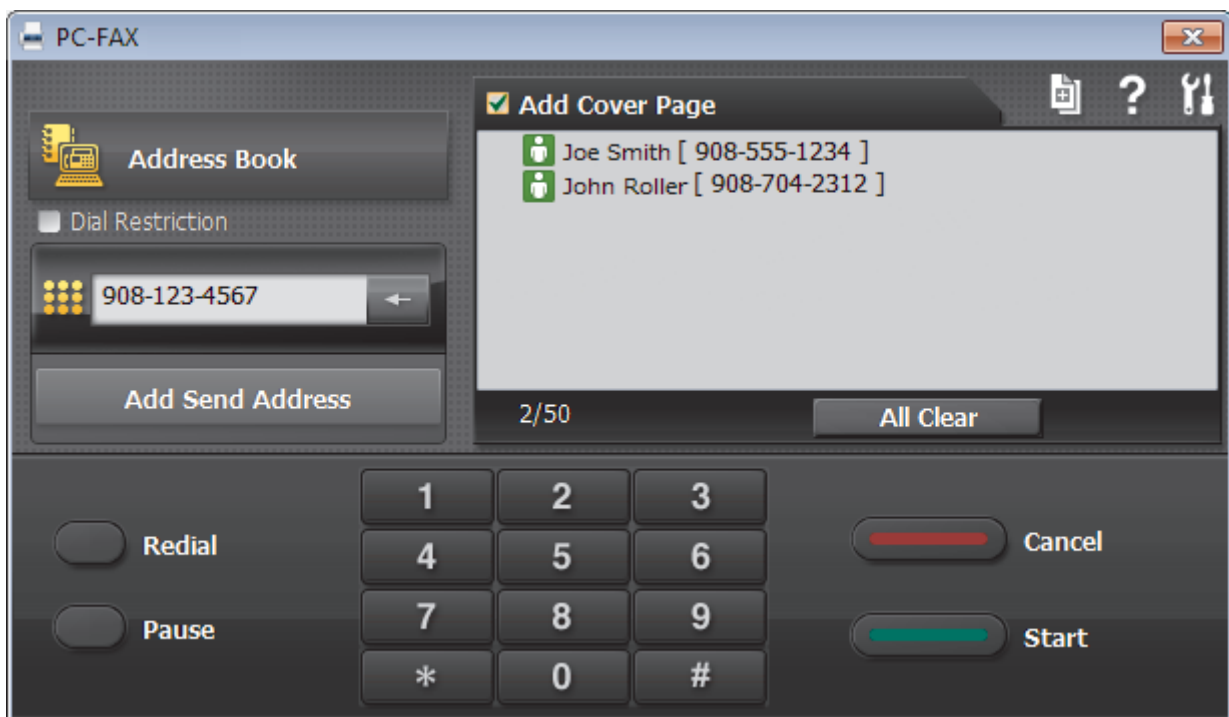

4. Type a fax number using one of the following methods:
  - Click the numbers on the dial pad to type the number, and then click **Add Send Address**.

 If you select the **Dial Restriction** check box, a confirmation dialog box will appear for you to re-type the fax number using the keyboard. This feature helps to prevent transmissions to the wrong destination.

- Click the **Address Book** button, and then select a member or group from the Address Book.

 If you make a mistake, click **All Clear** to delete all entries.

5. To include a cover page, select the **Add Cover Page** check box. You can also click  to create or edit a cover page.
6. Click **Start** to send the fax.

- To cancel the fax, click **Cancel**.
- To redial a number, click **Redial** to show the last five fax numbers, select a number, and then click **Start**.

### Related Information

- [PC-FAX for Windows®](#)

## Receive Faxes on Your Computer (Windows®)

Use Fuji Xerox's PC-FAX software to receive faxes on your computer, screen them and print only those faxes you want.

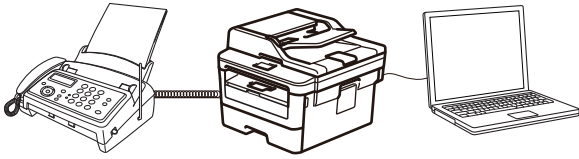

- [Receive Faxes Using PC-FAX Receive \(Windows®\)](#)

## Receive Faxes Using PC-FAX Receive (Windows®)

**Related Models:** DocuPrint M235 z/DocuPrint M275 z/DocuPrint M285 z

Fuji Xerox's PC-FAX Receive software lets you view and store faxes on your computer. It is automatically installed when you install the Fuji Xerox software and drivers and works on locally- or network-connected machines.

- PC-FAX Receive supports only monochrome faxes.

When you turn off your computer, your machine will continue to receive and store faxes in your Fuji Xerox machine's memory. The machine's LCD will display the number of stored faxes received. When you start this application, the software will transfer all received faxes to your computer at once. You can enable the Backup Print option if you want the machine to print a copy of the fax before the fax is sent to your computer, or before the computer is switched off. You can configure the Backup Print settings from your Fuji Xerox machine.



### Related Information

- [Receive Faxes on Your Computer \(Windows®\)](#)
- [Run Fuji Xerox's PC-FAX Receive on Your Computer \(Windows®\)](#)
- [View Received PC-FAX Messages \(Windows®\)](#)

Home > Fax > PC-FAX > PC-FAX for Windows® > Receive Faxes on Your Computer (Windows®)  
> Receive Faxes Using PC-FAX Receive (Windows®) > Run Fuji Xerox's PC-FAX Receive on Your Computer (Windows®)

## Run Fuji Xerox's PC-FAX Receive on Your Computer (Windows®)

**Related Models:** DocuPrint M235 z/DocuPrint M275 z/DocuPrint M285 z



We recommend selecting the **Start PC-FAX Receive on computer startup** check box so that the software runs automatically and can transfer any faxes upon computer startup.

1. Do one of the following:

- Windows® 7

Click  (**Start**) > **All Programs** > **Fuji Xerox** > **Fuji Xerox Utilities**.

Click the drop-down list and select your model name (if not already selected). Click **PC-FAX** in the left navigation bar, and then click **Receive**.

- Windows® 8 and Windows® 10

Launch  (**Fuji Xerox Utilities**), and then click the drop-down list and select your model name (if not already selected). Click **PC-FAX** in the left navigation bar, and then click **Receive**.

2. Confirm the message and click **Yes**.

The **PC-FAX Receive** window appears. The  (**PC-Fax Receive (Ready)**) icon also appears in your computer task tray.



### Related Information

- [Receive Faxes Using PC-FAX Receive \(Windows®\)](#)
- [Set Up Your Computer for PC-FAX Receiving \(Windows®\)](#)
- [Add Your Fuji Xerox Machine to PC-FAX Receiving \(Windows®\)](#)

## Set Up Your Computer for PC-FAX Receiving (Windows®)

**Related Models:** DocuPrint M235 z/DocuPrint M275 z/DocuPrint M285 z

1. Double-click the  (**PC-Fax Receive (Ready)**) icon in your computer task tray.  
The **PC-FAX Receive** window appears.
2. Click **Settings**.
3. Configure these options as needed:

### Preferences

Configure to start PC-FAX Receive automatically when you start Windows®.

### Save

Configure the path to save PC-FAX files and select the received document format.

### Upload to

Configure the path to the SharePoint® server and select the option to upload automatically or manually (available only for Administrators).

### Device

Select the Fuji Xerox machine that you want to receive PC-FAX.

### Lock (available only for Administrators)

Restrict users who do not have administrator privileges from configuring the settings options shown above.

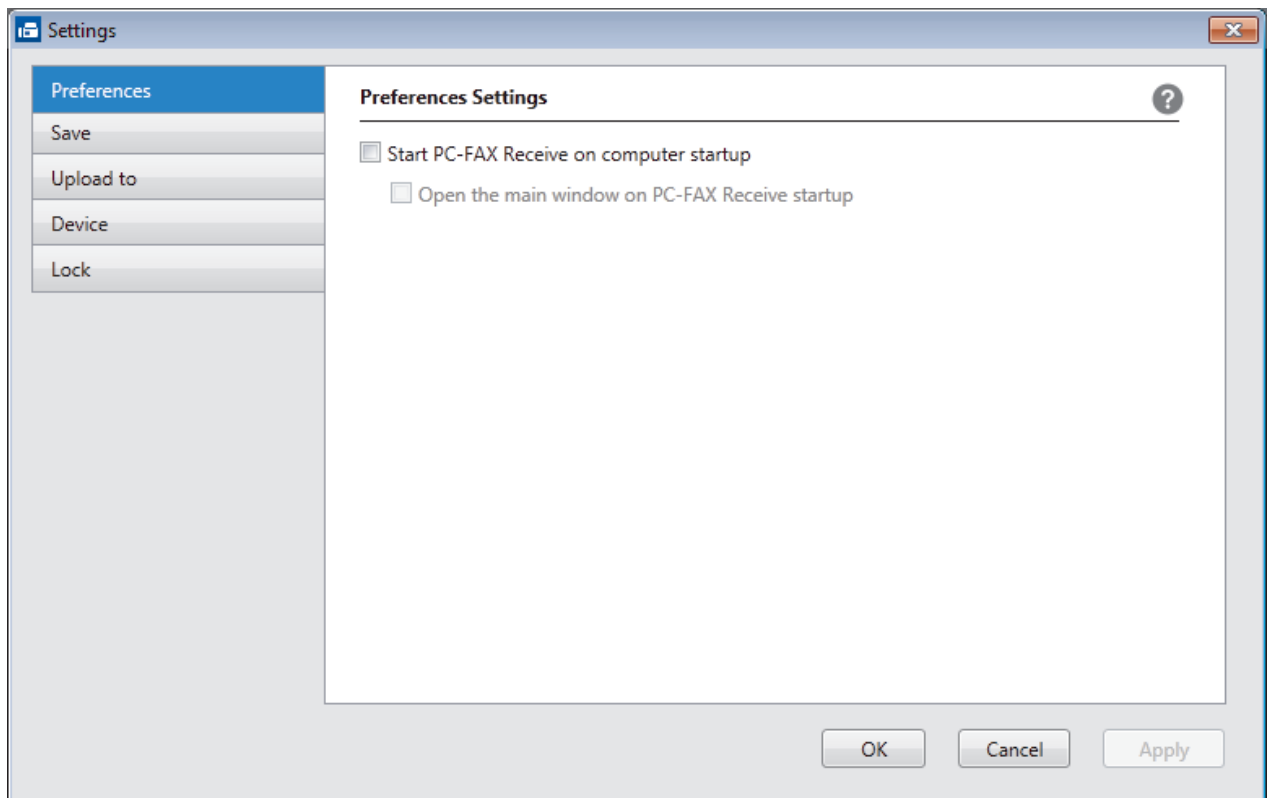

4. Click **OK**.



## Related Information

- [Run Fuji Xerox's PC-FAX Receive on Your Computer \(Windows®\)](#)
-



Home > Fax > PC-FAX > PC-FAX for Windows® > Receive Faxes on Your Computer (Windows®)  
> Receive Faxes Using PC-FAX Receive (Windows®) > Run Fuji Xerox's PC-FAX Receive on Your Computer (Windows®) > Add Your Fuji Xerox Machine to PC-FAX Receiving (Windows®)

## Add Your Fuji Xerox Machine to PC-FAX Receiving (Windows®)

**Related Models:** DocuPrint M235 z/DocuPrint M275 z/DocuPrint M285 z

- If you installed the machine following the instructions for a network user, then the machine should already be configured for your network.

1. Double-click the  (**PC-Fax Receive (Ready)**) icon in your computer task tray.

The **PC-FAX Receive** window appears.

2. Click **Settings**.

3. Click **Device** > **Add**.

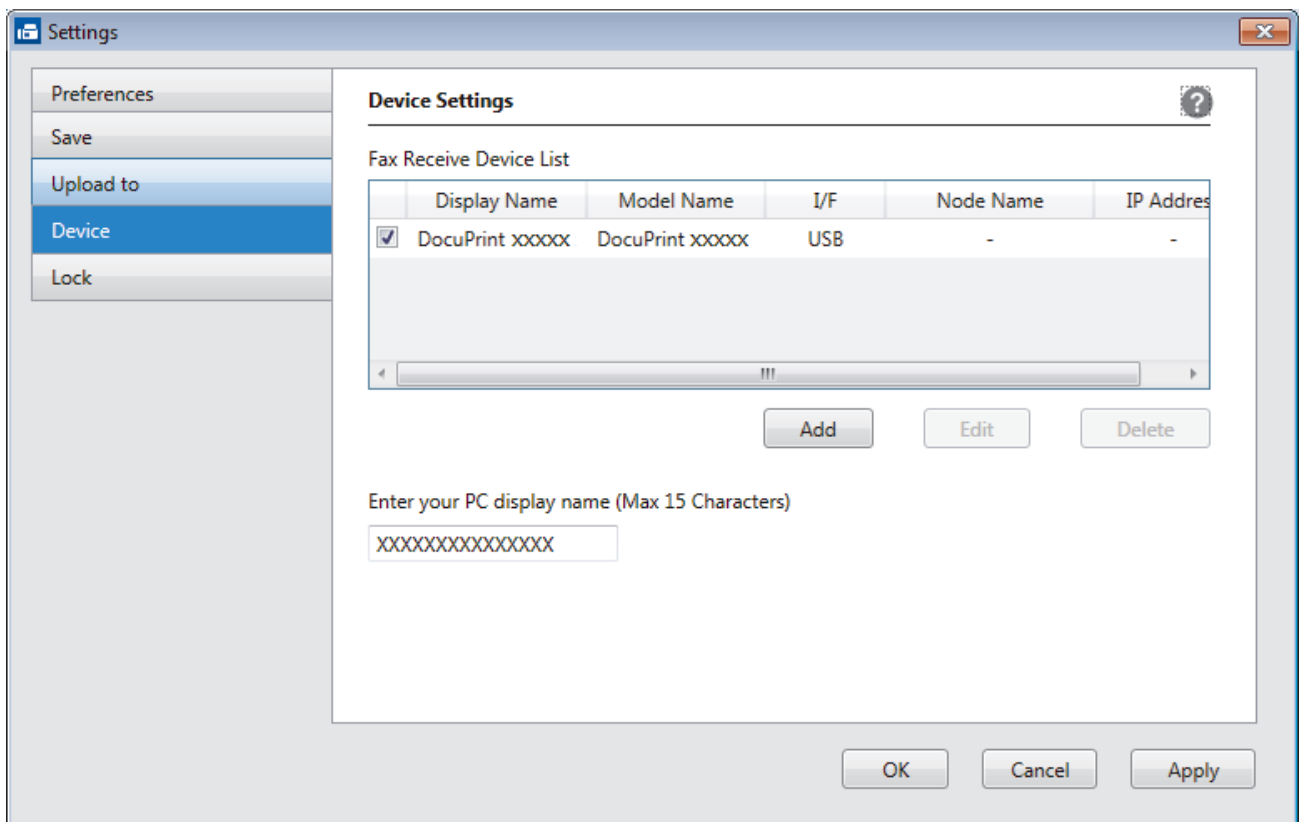

4. Select the appropriate connection method.

**Select your machine from the automatic search results below.**

Connected Fuji Xerox machines will be displayed. Select a device from the list. Click **OK**.

**Specify your machine by IP address**

Type the machine's IP address in the **IP Address** field, and then click **OK**.

Select your machine from the automatic search results below.

| Model Name | I/F | Node Name | IP Address | Location |
|------------|-----|-----------|------------|----------|
|------------|-----|-----------|------------|----------|

Specify your machine by IP address

IP Address

5. To change the computer name that will appear on the machine's LCD, type the new name in the **Enter your PC display name (Max 15 Characters)** field.
6. Click **OK**.



### **Related Information**

- [Run Fuji Xerox's PC-FAX Receive on Your Computer \(Windows®\)](#)

## View Received PC-FAX Messages (Windows®)

**Related Models:** DocuPrint M235 z/DocuPrint M275 z/DocuPrint M285 z

### Receiving Status

| Icon  | Indicated Status                     |
|---|--------------------------------------|
|  | Standby mode<br>No unread messages   |
|  | Receiving messages                   |
|  | Messages received<br>Unread messages |

1. Double-click the  (**PC-Fax Receive (Ready)**) icon in your computer task tray.

The **PC-FAX Receive** window appears.

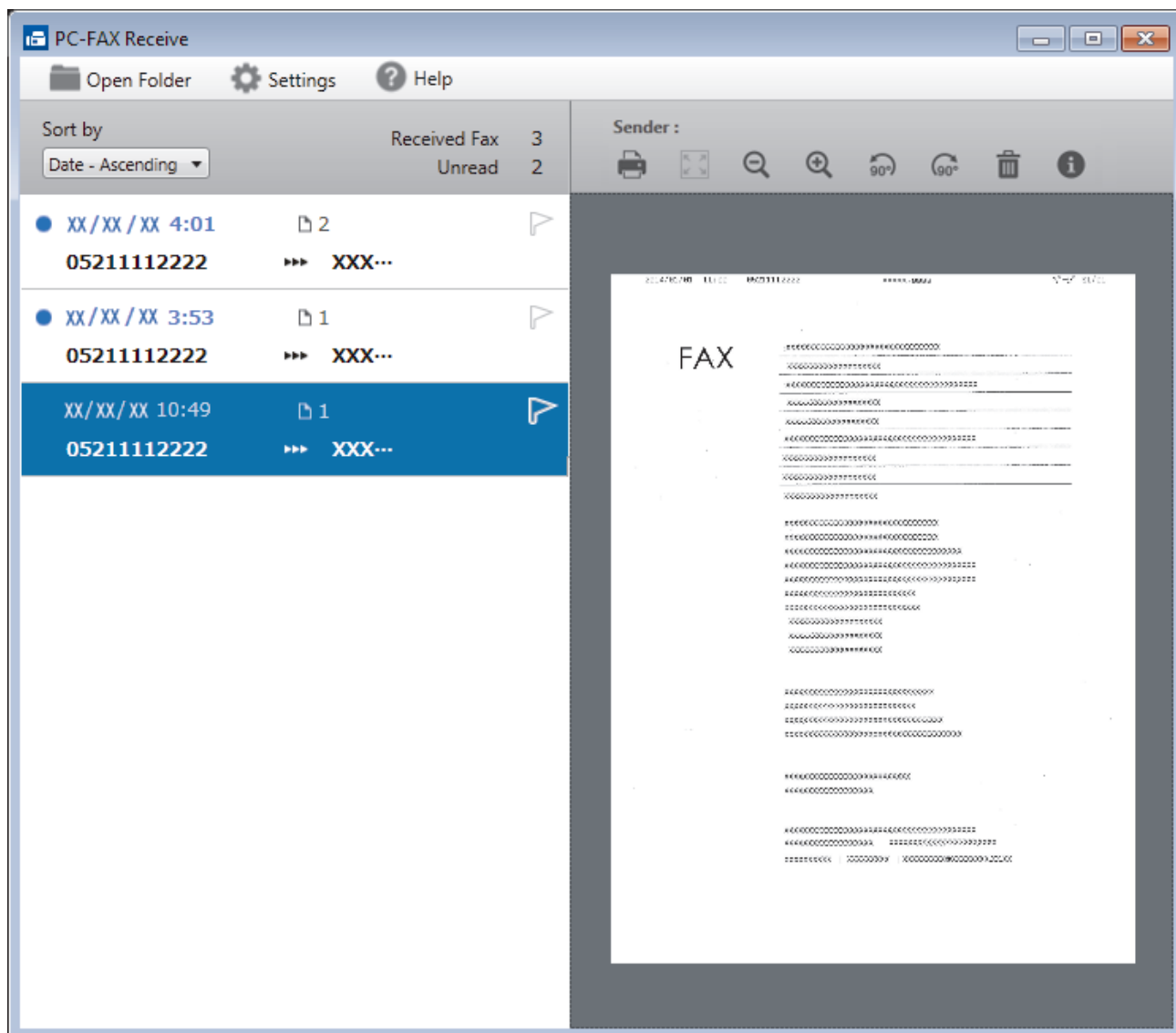

2. Click any faxes in the list to view them.
3. When finished, click  in the right top corner of the window to close it.



Even after closing the window, PC-FAX Receive is active and the  (PC-Fax Receive (Ready) ) icon will remain in your computer task tray. To close PC-FAX Receive, click the icon in the computer task tray and click **Close**.

---



### Related Information

- [Receive Faxes Using PC-FAX Receive \(Windows®\)](#)
-

## PC-FAX for Mac

Use Fuji Xerox's PC-FAX software to send faxes directly from your Mac without printing them. This feature helps reduce your paper consumption and save time.

- [Send Faxes from Your Application \(Mac\)](#)

## Send Faxes from Your Application (Mac)

**Related Models:** DocuPrint M235 z/DocuPrint M275 z/DocuPrint M285 z

PC-FAX supports only monochrome faxes. A monochrome fax will be sent even if the original data is colour and the receiving fax machine supports colour faxes.

1. Create a document in a Mac application.
2. From an application, such as Apple TextEdit, click the **File** menu, and then select **Print**.



For more page setup options, click the **Show Details** button.

3. Click the application pop-up menu, and then select the **Send Fax** option.

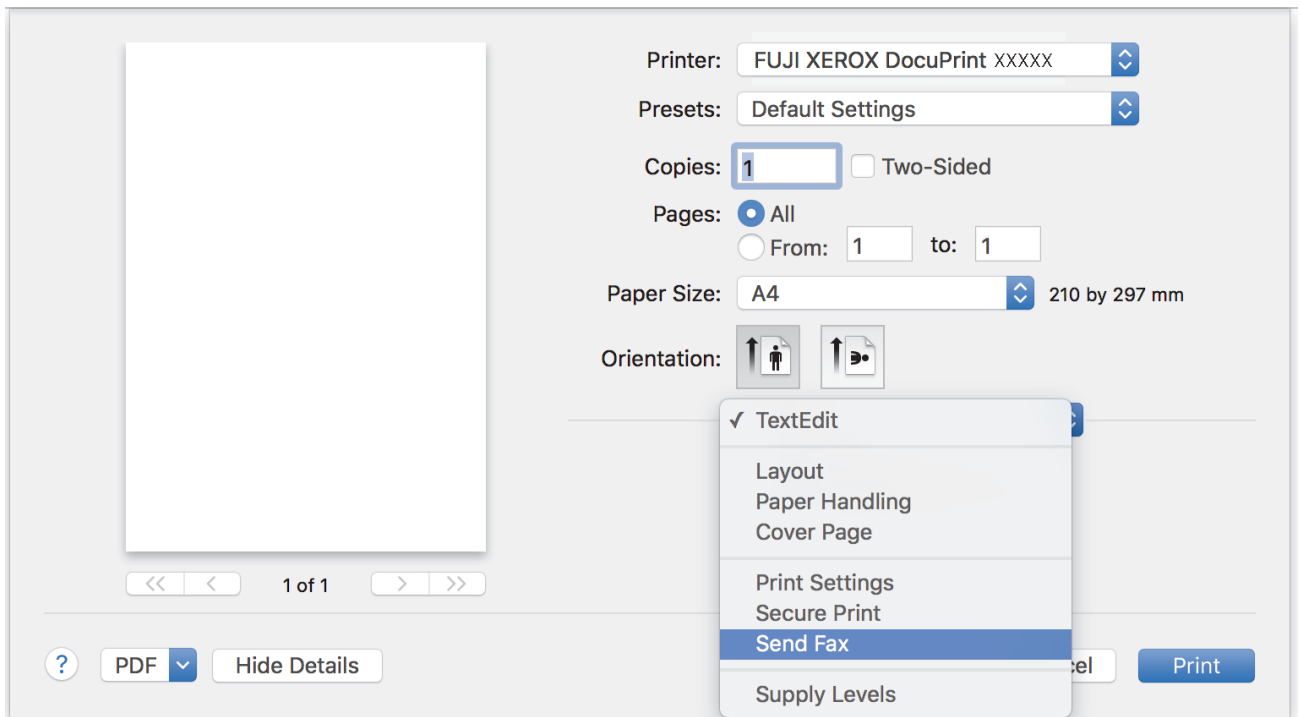

4. Click the **Output** pop-up menu, and then select the **Facsimile** option.

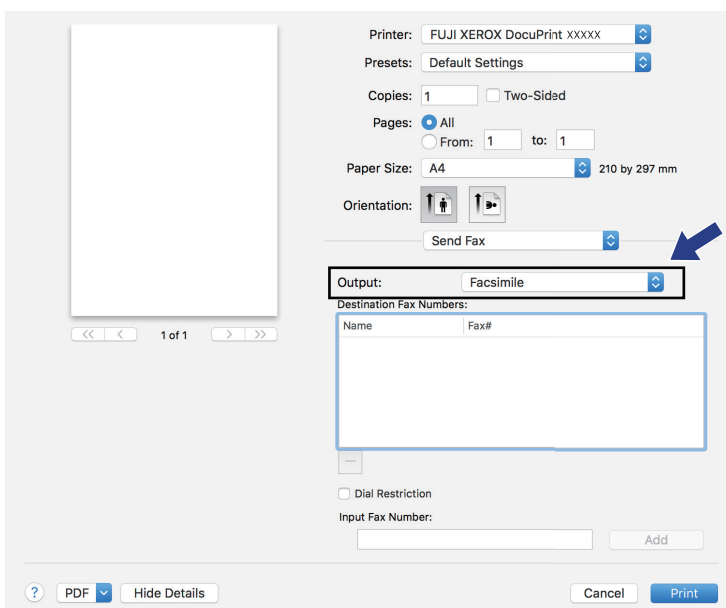

5. Type a fax number in the **Input Fax Number** field, and then click **Add**.  
The fax number is displayed in the **Destination Fax Numbers** field.



To send a fax to more than one number, click the **Add** button after entering the first fax number and type the next fax number. The destination fax numbers will be listed in the **Destination Fax Numbers** field.

The screenshot shows a fax software interface with the following elements:

- Printer:** FUJI XEROX DocuPrint XXXXX
- Presets:** Default Settings
- Copies:** 1 (with a checkbox for Two-Sided)
- Pages:** All (with a radio button for From: 1 to: 1)
- Paper Size:** A4 (210 by 297 mm)
- Orientation:** Portrait (with icons for Portrait and Landscape)
- Send Fax:** Send Fax
- Output:** Facsimile
- Destination Fax Numbers:** A table with columns for Name and Fax#. One entry is visible: Name (blank), Fax# 222-111-3333.
- Input Fax Number:** A text field with an **Add** button next to it. A blue arrow points to this button.
- Buttons:** Cancel, Print, PDF, Hide Details.

6. Click **Print** to send the fax.



## Related Information

- [PC-FAX for Mac](#)

## Network

- [Supported Basic Network Features](#)
- [Network Management Software and Utilities](#)
- [Additional Methods of Configuring Your Fuji Xerox Machine for a Wireless Network](#)
- [Advanced Network Features](#)
- [Technical Information for Advanced Users](#)



## Supported Basic Network Features

The print server supports various features depending on the operating system. Use this table to see which network features and connections are supported by each operating system.

| Operating Systems                                    | Windows® 7<br>Windows® 8<br>Windows® 10 | Windows Server®<br>2008/2008 R2/2012/2012<br>R2/2016 | macOS v10.11.x<br>macOS v10.12.x<br>macOS v10.13.x |
|--|---|--|--|
| Printing   | Yes                                     | Yes  | Yes  |
| Scanning   | Yes                                     |  | Yes  |
| PC Fax Send (Available only for certain models)      | Yes                                     |  | Yes  |
| PC Fax Receive (Available only for certain models)   | Yes                                     |  |  |
| BRAdmin Light  | Yes                                     | Yes  |  |
| Web Based Management                                 | Yes                                     | Yes  | Yes  |
| Remote Setup (Available only for certain models)     | Yes                                     |  |  |
| Status Monitor                                       | Yes                                     |  | Yes  |
| Vertical Pairing (Available only for certain models) | Yes                                     |  |  |



- Go to the download page for your model on the Fuji Xerox website at <http://www.fujixeroxprinters.com/> to download the latest version of BRAdmin Light.



### Related Information

- [Network](#)

## Network Management Software and Utilities

Configure and change your Fuji Xerox machine's network settings using a management utility.

- [Learn about Network Management Software and Utilities](#)
- [Change Machine Settings from Your Computer](#)
- [Change Machine Settings Using Web Based Management](#)

## Learn about Network Management Software and Utilities

### Web Based Management

Web Based Management is a utility that uses a standard web browser to manage your machine using the Hyper Text Transfer Protocol (HTTP) or Hyper Text Transfer Protocol over Secure Socket Layer (HTTPS). Type your machine's IP address into your web browser to access and change your print server settings.

### BRAdmin Light (Windows®)

BRAdmin Light is a utility for the initial setup of Fuji Xerox network-connected devices. This utility can search for Fuji Xerox products on your network, view the status and configure the basic network settings, such as IP address.

Go to the download page for your model on the Fuji Xerox website at <http://www.fujixeroxprinters.com/> to download BRAdmin Light.



- If using Windows® Firewall, or the firewall function of an anti-spyware or antivirus application, temporarily disable them. When you are sure you can print, configure the software settings following the instructions.

### Remote Setup (Windows® and Mac) (Available only for certain models)

Remote Setup is a program for configuring many machine and network settings from either a Windows® or a Mac application. When you start this application, the settings on your machine are automatically downloaded to your computer and displayed on your computer screen. If you change the settings, you can upload them directly to the machine.



(Windows®)

This utility can be used with either a USB or a network connection.

(Mac)

- Go to the download page for your model on the Fuji Xerox website at <http://www.fujixeroxprinters.com/> to download the Remote Setup.
- This utility can be used with a USB connection.



### Related Information

- [Network Management Software and Utilities](#)

## Additional Methods of Configuring Your Fuji Xerox Machine for a Wireless Network

To connect your machine to your wireless network, we recommend using the Fuji Xerox installation disc.

- [Before Configuring Your Fuji Xerox Machine for a Wireless Network](#)
- [Configure Your Machine for a Wireless Network](#)
- [Configure Your Machine for a Wireless Network Using the One Push Method of Wi-Fi Protected Setup™ \(WPS\)](#)
- [Configure Your Machine for a Wireless Network Using the PIN Method of Wi-Fi Protected Setup™ \(WPS\)](#)
- [Configure Your Machine for a Wireless Network Using the Machine's Control Panel Setup Wizard](#)
- [Configure Your Machine for a Wireless Network When the SSID Is Not Broadcast](#)
- [Use Wi-Fi Direct®](#)

## Before Configuring Your Fuji Xerox Machine for a Wireless Network

Before attempting to configure a wireless network, confirm the following:

- To achieve optimum results with normal everyday document printing, place the Fuji Xerox machine as close to the wireless LAN access point/router as possible with minimal obstructions. Large objects and walls between the two devices and interference from other electronic devices can affect the data transfer speed of your documents.

Due to these factors, wireless may not be the best method of connection for all types of documents and applications. If you are printing large files, such as multi-page documents with mixed text and large graphics, you may want to consider selecting wired Ethernet for faster data transfer (supported models only), or USB for the fastest throughput speed.

- Although the Fuji Xerox machine can be used in both a wired and wireless network (supported models only), only one connection method can be used at a time. However, a wireless network connection and Wi-Fi Direct connection, or a wired network connection (supported models only) and Wi-Fi Direct connection can be used at the same time.



---

If you do not know the security information, please consult the router manufacturer, your system administrator, or your Internet provider.

---



### Related Information

- [Additional Methods of Configuring Your Fuji Xerox Machine for a Wireless Network](#)

## Configure Your Machine for a Wireless Network

1. Turn on your computer and insert the Fuji Xerox installation disc into your computer.
  - For Windows®, follow these instructions:
  - The printer driver for Mac is available from the download page for your model on the Fuji Xerox website at <http://www.fujixeroxprinters.com/>.
2. The opening screen appears automatically.  
Choose your language, and then follow the on-screen instructions.



If the Fuji Xerox screen does not appear, do the following:

- (Windows® 7)  
Go to **Computer**. Double-click the CD/DVD icon, and then double-click **start.exe**.
- (Windows® 8 and Windows® 10)  
Click the  (**File Explorer**) icon on the taskbar, and then go to **Computer (This PC)**. Double-click the CD/DVD icon, and then double-click **start.exe**.
- If the **User Account Control** screen appears, click **Yes**.

3. Choose **Wireless Network Connection (Wi-Fi)**, and then click **Next**.
4. Follow the on-screen instructions.

You have completed the wireless network setup. To install **Full Driver & Software Package** necessary for operating your device, insert the Fuji Xerox installation disc into your computer or go to the download page for your model on the Fuji Xerox website at <http://www.fujixeroxprinters.com/>.



### Related Information

- [Additional Methods of Configuring Your Fuji Xerox Machine for a Wireless Network](#)

## Configure Your Machine for a Wireless Network Using the One Push Method of Wi-Fi Protected Setup™ (WPS)

If your wireless access point/router supports WPS (PBC: Push Button Configuration), you can use WPS from your machine's control panel menu to configure your wireless network settings.



Routers or access points that support WPS are marked with this symbol:



>> DocuPrint M235 dw/DocuPrint M235 z

>> DocuPrint M275 z/DocuPrint M285 z

### DocuPrint M235 dw/DocuPrint M235 z

1. Press **Menu**.
2. Press **▲** or **▼** to select the [Network] option, and then press **OK**.
3. Press **▲** or **▼** to select the [WLAN] option, and then press **OK**.
4. Press **▲** or **▼** to select the [WPS] option, and then press **OK**.
5. When [WLAN Enable?] appears, enable the wireless network.  
This will start the wireless setup wizard.
6. When the LCD displays [Press Key on rtr], press the WPS button on your wireless access point/router. Then press **OK** on your machine. Your machine will automatically detect your wireless access point/router and try to connect to your wireless network.

If your wireless device is connected successfully, the machine's LCD displays [Connected].

You have completed the wireless network setup. To install **Full Driver & Software Package** necessary for operating your device, insert the Fuji Xerox installation disc into your computer or go to the download page for your model on the Fuji Xerox website at <http://www.fujixeroxprinters.com/>.

### DocuPrint M275 z/DocuPrint M285 z

1. Press  [Settings] > [All Settings] > [Network] > [WLAN] > [WPS].
2. When [Switch Network interface to wireless?] appears, press [Yes].  
This will start the wireless setup wizard. To cancel, press [No].
3. When the touchscreen displays [Start WPS on your wireless access point/router, then press [OK].], press the WPS button on your wireless access point/router. Then press [OK] on your machine. Your machine will automatically detect your wireless access point/router and try to connect to your wireless network.

If your wireless device is connected successfully, the machine's LCD displays [Connected].

---

You have completed the wireless network setup. To install **Full Driver & Software Package** necessary for operating your device, insert the Fuji Xerox installation disc into your computer or go to the download page for your model on the Fuji Xerox website at <http://www.fujixeroxprinters.com/>.



### Related Information

- [Additional Methods of Configuring Your Fuji Xerox Machine for a Wireless Network](#)
  - [Wireless LAN Report Error Codes](#)
-



## Configure Your Machine for a Wireless Network Using the PIN Method of Wi-Fi Protected Setup™ (WPS)

If your wireless LAN access point/router supports WPS, you can use the Personal Identification Number (PIN) Method to configure your wireless network settings.

The PIN Method is one of the connection methods developed by the Wi-Fi Alliance®. By submitting a PIN created by an Enrollee (your machine) to the Registrar (a device that manages the wireless LAN), you can set up the wireless network and security settings. For more information on how to access WPS mode, see the instructions provided with your wireless access point/router.

### Type A

Connection when the wireless LAN access point/router (1) doubles as the Registrar:

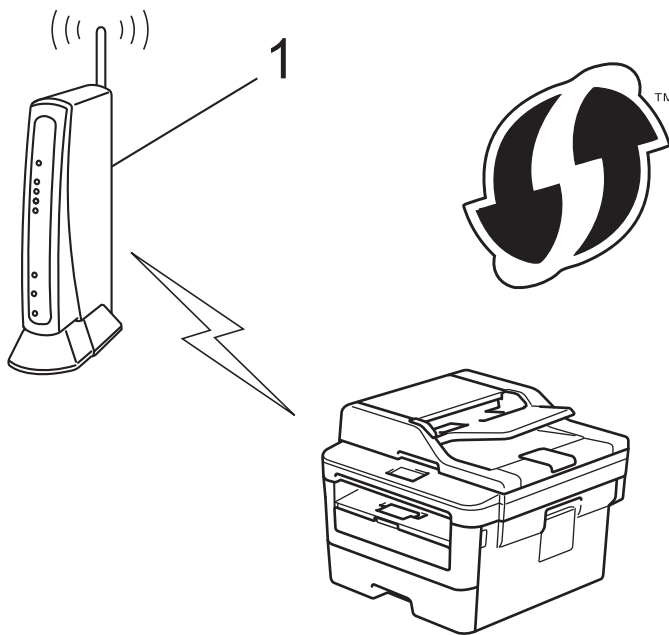

### Type B

Connection when another device (2), such as a computer, is used as the Registrar:

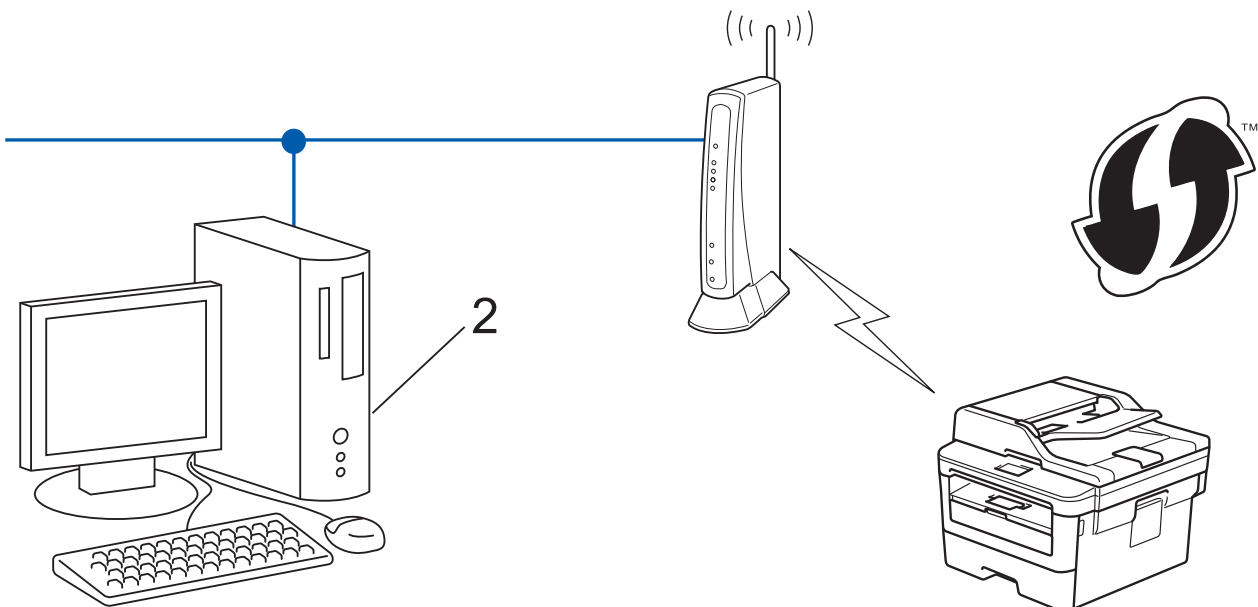

 Routers or access points that support WPS are marked with this symbol:



>> [DocuPrint M235 dw/DocuPrint M235 z](#)  
>> [DocuPrint M275 z/DocuPrint M285 z](#)

## DocuPrint M235 dw/DocuPrint M235 z

1. Press **Menu**.
2. Press **▲** or **▼** to select the [Network] option, and then press **OK**.
3. Press **▲** or **▼** to select the [WLAN] option, and then press **OK**.
4. Press **▲** or **▼** to select the [WPS w/PIN Code] option, and then press **OK**.
5. When [WLAN Enable?] appears, enable the wireless network.  
This will start the wireless setup wizard.
6. The LCD displays an eight-digit PIN and the machine starts searching for a wireless LAN access point/router.
7. Using a computer connected to the network, in your browser's address bar, type the IP address of the device you are using as the Registrar. (For example: <http://192.168.1.2>)
8. Go to the WPS settings page and type the PIN, and then follow the on-screen instructions.

-  • The Registrar is usually the wireless LAN access point/router.
- The settings page will differ depending on the brand of wireless LAN access point/router. For more information, see the instructions supplied with your wireless LAN access point/router.

**If you are using a Windows® 7, Windows® 8, or Windows® 10 computer as a Registrar, complete the following steps:**

9. Do one of the following:
  - Windows® 7

---

Click  (**Start**) > **Devices and Printers** > **Add a device**.

- Windows® 8

Move your mouse to the lower right corner of your desktop. When the menu bar appears, click **Settings** > **Control Panel** > **Hardware and Sound** > **View devices and printers** > **Add a device**.

- Windows® 10

Click  > **Windows System** > **Control Panel**. In the **Hardware and Sound** group, click **Add a device**.



- To use a Windows® 7, Windows® 8, or Windows® 10 computer as a Registrar, you must register it to your network in advance. For more information, see the instructions supplied with your wireless LAN access point/router.
- If you use Windows® 7, Windows® 8, or Windows® 10 as a Registrar, you can install the printer driver after the wireless configuration by following the on-screen instructions. To install the full driver and software package, use the Fuji Xerox installation disc.

---

10. Select your machine and click **Next**.

11. Type the PIN displayed on the machine's LCD, and then click **Next**.

12. (Windows® 7) Select your network, and then click **Next**.

13. Click **Close**.

If your wireless device is connected successfully, the machine's LCD displays [Connected].

You have completed the wireless network setup. To install **Full Driver & Software Package** necessary for operating your device, insert the Fuji Xerox installation disc into your computer or go to the download page for your model on the Fuji Xerox website at <http://www.fujixeroxprinters.com/>.

## DocuPrint M275 z/DocuPrint M285 z

1. Press  [Settings] > [All Settings] > [Network] > [WLAN] > [WPS w/ PIN Code].

2. When [Switch Network interface to wireless?] appears, press [Yes].

This will start the wireless setup wizard. To cancel, press [No].

3. The LCD displays an eight-digit PIN and the machine starts searching for a wireless LAN access point/router.

4. Using a computer connected to the network, in your browser's address bar, type the IP address of the device you are using as the Registrar. (For example: <http://192.168.1.2>)

5. Go to the WPS settings page and type the PIN, and then follow the on-screen instructions.



- The Registrar is usually the wireless LAN access point/router.
- The settings page will differ depending on the brand of wireless LAN access point/router. For more information, see the instructions supplied with your wireless LAN access point/router.

---

**If you are using a Windows® 7, Windows® 8, or Windows® 10 computer as a Registrar, complete the following steps:**

6. Do one of the following:

- (Windows® 7)

Click  (**Start**) > **Devices and Printers** > **Add a device**.

- (Windows® 8)

Move your mouse to the lower right corner of your desktop. When the menu bar appears, click **Settings** > **Control Panel** > **Hardware and Sound** > **View devices and printers** > **Add a device**.



- To use a Windows® 7, or Windows® 8 computer as a Registrar, you must register it to your network in advance. For more information, see the instructions supplied with your wireless LAN access point/router.
- If you use Windows® 7 or Windows® 8 as a Registrar, you can install the printer driver after the wireless configuration by following the on-screen instructions. To install the full driver and software package, use the Fuji Xerox installer on the Installer CD-ROM.

7. Select your machine and click **Next**.
8. Type the PIN displayed on the machine's LCD, and then click **Next**.
9. (Windows® 7) Select your network, and then click **Next**.
10. Click **Close**.

If your wireless device is connected successfully, the machine's LCD displays [Connected].

You have completed the wireless network setup. To install **Full Driver & Software Package** necessary for operating your device, insert the Fuji Xerox installation disc into your computer or go to the download page for your model on the Fuji Xerox website at <http://www.fujixeroxprinters.com/>.



### Related Information

- [Additional Methods of Configuring Your Fuji Xerox Machine for a Wireless Network](#)
- [Wireless LAN Report Error Codes](#)

## Configure Your Machine for a Wireless Network Using the Machine's Control Panel Setup Wizard

>> [DocuPrint M235 dw/DocuPrint M235 z](#)  
>> [DocuPrint M275 z/DocuPrint M285 z](#)

### DocuPrint M235 dw/DocuPrint M235 z

Before configuring your machine, we recommend writing down your wireless network settings. You will need this information before you continue with the configuration.

1. Check and record the current wireless network settings of the computer to which you are connecting.

| Network Name (SSID) |
|---------------------|
|                     |

| Network Key |
|-------------|
|             |

For example:

| Network Name (SSID) |
|---------------------|
| HELLO               |

| Network Key |
|-------------|
| 12345       |



- Your access point/router may support the use of multiple WEP keys, however your Fuji Xerox machine supports the use of the first WEP key only.
- If you need assistance during setup and want to contact Fuji Xerox customer service, make sure you have your SSID (Network Name) and Network Key ready. We cannot assist you in locating this information.
- If you do not know this information (SSID and Network Key), you cannot continue the wireless setup.

#### How can I find this information?

- Check the documentation provided with your wireless access point/router.
- The initial SSID could be the manufacturer's name or the model name.
- If you do not know the security information, please consult the router manufacturer, your system administrator, or your Internet provider.

2. Press **Menu**.
3. Press **▲** or **▼** to select the [Network] option, and then press **OK**.
4. Press **▲** or **▼** to select the [WLAN] option, and then press **OK**.
5. Press **▲** or **▼** to select the [Setup Wizard] option, and then press **OK**.
6. When [WLAN Enable?] appears, enable the wireless network.  
This will start the wireless setup wizard.
7. The machine will search for your network and display a list of available SSIDs. When a list of SSIDs appears, press **▲** or **▼** to select the SSID you want.
8. Press **OK**.
9. Do one of the following:

- If you are using an authentication and encryption method that requires a Network Key, enter the Network Key you wrote down in the first step.

Enter the WEP key, and then press **OK** to apply your settings.

To apply the settings, select [Yes]. To cancel, select [No].

- If your authentication method is Open System and your encryption mode is None, go to the next step.
- If your WLAN access point/router supports WPS, [WPS is available] appears. To connect your machine using the automatic wireless mode, press ▲. (If you choose [No], enter the Network Key you wrote down in the first step.) When [Press WPS on rtr] appears, press the WPS button on your WLAN access point/router, and then press ▲ twice.

10. The machine attempts to connect to the wireless device you have selected.

If your wireless device is connected successfully, the machine's LCD displays [Connected].

You have completed the wireless network setup. To install **Full Driver & Software Package** necessary for operating your device, insert the Fuji Xerox installation disc into your computer or go to the download page for your model on the Fuji Xerox website at <http://www.fujixeroxprinters.com/>.

## DocuPrint M275 z/DocuPrint M285 z

Before configuring your machine, we recommend writing down your wireless network settings. You will need this information before you continue with the configuration.

1. Check and record the current wireless network settings of the computer to which you are connecting.

### Network Name (SSID)

|  |
|--|
|  |
|--|

### Network Key

|  |
|--|
|  |
|--|

For example:

### Network Name (SSID)

HELLO

### Network Key

12345



- Your access point/router may support the use of multiple WEP keys, however your Fuji Xerox machine supports the use of the first WEP key only.
- If you need assistance during setup and want to contact Fuji Xerox customer service, make sure you have your SSID (Network Name) and Network Key ready. We cannot assist you in locating this information.
- If you do not know this information (SSID and Network Key), you cannot continue the wireless setup.

#### How can I find this information?

- Check the documentation provided with your wireless access point/router.
- The initial SSID could be the manufacturer's name or the model name.
- If you do not know the security information, please consult the router manufacturer, your system administrator, or your Internet provider.

2. Press  [Settings] > [All Settings] > [Network] > [WLAN] > [Setup Wizard].

3. When [Switch Network interface to wireless?] appears, press [Yes].

This will start the wireless setup wizard. To cancel, press [No].

4. The machine will search for your network and display a list of available SSIDs.

---

If a list of SSIDs is displayed, press ▲ or ▼ to display the SSID to which you want to connect, and then press the SSID.

5. Press [OK].

6. Do one of the following:

- If you are using an authentication and encryption method that requires a Network Key, enter the Network Key you wrote down in the first step.

When you have entered all the characters, press [OK].

- If your authentication method is Open System and your encryption mode is None, go to the next step.
- If your WLAN access point/router supports WPS, [The selected access point/router supports WPS. Use WPS?] appears. To connect your machine using the automatic wireless mode, press [Yes]. (If you choose [No], enter the Network Key you wrote down in the first step.) When [Start WPS on your wireless access point/router, then press [Next].] appears, press the WPS button on your WLAN access point/router, and then press [Next].

7. The machine attempts to connect to the wireless device you have selected.

If your wireless device is connected successfully, the machine's LCD displays [Connected].

You have completed the wireless network setup. To install **Full Driver & Software Package** necessary for operating your device, insert the Fuji Xerox installation disc into your computer or go to the download page for your model on the Fuji Xerox website at <http://www.fujixeroxprinters.com/>.



### Related Information

- [Additional Methods of Configuring Your Fuji Xerox Machine for a Wireless Network](#)
  - [How to Enter Text on Your Fuji Xerox Machine](#)
  - [Wireless LAN Report Error Codes](#)
-

## Configure Your Machine for a Wireless Network When the SSID Is Not Broadcast

- >> [DocuPrint M235 dw/DocuPrint M235 z](#)
- >> [DocuPrint M275 z/DocuPrint M285 z](#)

### DocuPrint M235 dw/DocuPrint M235 z

Before configuring your machine, we recommend writing down your wireless network settings. You will need this information before you continue with the configuration.

1. Check and write down the current wireless network settings.

| Network Name (SSID) |                       |                 |             |
|---------------------|-----------------------|-----------------|-------------|
|                     |                       |                 |             |
| Communication Mode  | Authentication Method | Encryption Mode | Network Key |
| Infrastructure      | Open System           | NONE            | -           |
|                     |                       | WEP             |             |
|                     | Shared Key            | WEP             |             |
|                     |                       | WPA/WPA2-PSK    | AES         |
|                     |                       | TKIP            |             |

For example:

| Network Name (SSID) |                       |                 |             |
|---------------------|-----------------------|-----------------|-------------|
| HELLO               |                       |                 |             |
| Communication Mode  | Authentication Method | Encryption Mode | Network Key |
| Infrastructure      | WPA2-PSK              | AES             | 12345678    |



If your router uses WEP encryption, enter the key used as the first WEP key. Your Fuji Xerox machine supports the use of the first WEP key only.

2. Press **Menu**.
3. Press **▲** or **▼** to select the [Network] option, and then press **OK**.
4. Press **▲** or **▼** to select the [WLAN] option, and then press **OK**.
5. Press **▲** or **▼** to select the [Setup Wizard] option, and then press **OK**.
6. When [WLAN Enable?] appears, enable the wireless network.  
This will start the wireless setup wizard.
7. The machine will search for your network and display a list of available SSIDs. Press **▲** or **▼** to select the [<New SSID>] option, and then press **OK**.
8. Enter the SSID name, and then press **OK**.
9. Press **▲** or **▼** to select the [Infrastructure] option, and then press **OK**.
10. Press **▲** or **▼** to select the Authentication Method you want, and then press **OK**.
11. Do one of the following:
  - If you selected the [Open System] option, press **▲** or **▼** to select the Encryption Type [None] or [WEP], and then press **OK**.  
If you selected the [WEP] option for Encryption Type, enter the WEP key, and then press **OK**.



- If you selected the [Shared Key] option, enter the WEP key, and then press **OK**.
- If you selected the [WPA/WPA2-PSK] option, press ▲ or ▼ to select the Encryption Type [TKIP + AES] or [AES], and then press **OK**.

Enter the WPA™ key, and then press **OK**.



Your Fuji Xerox machine supports the use of the first WEP key only.

12. To apply the settings, select [Yes]. To cancel, select [No].
13. The machine attempts to connect to the wireless device you have selected.

If your wireless device is connected successfully, the machine's LCD displays [Connected].

You have completed the wireless network setup. To install **Full Driver & Software Package** necessary for operating your device, insert the Fuji Xerox installation disc into your computer or go to the download page for your model on the Fuji Xerox website at <http://www.fujixeroxprinters.com/>.

## DocuPrint M275 z/DocuPrint M285 z

Before configuring your machine, we recommend writing down your wireless network settings. You will need this information before you continue with the configuration.

1. Check and write down the current wireless network settings.

| Network Name (SSID) |                       |                 |             |  |
|---------------------|-----------------------|-----------------|-------------|--|
|                     |                       |                 |             |  |
| Communication Mode  | Authentication Method | Encryption Mode | Network Key |  |
| Infrastructure      | Open System           | NONE            | -           |  |
|                     |                       | WEP             |             |  |
|                     | Shared Key            | WEP             |             |  |
|                     |                       | WPA/WPA2-PSK    | AES         |  |
|                     |                       |                 | TKIP        |  |

For example:

| Network Name (SSID) |                       |                 |             |
|---------------------|-----------------------|-----------------|-------------|
| HELLO               |                       |                 |             |
| Communication Mode  | Authentication Method | Encryption Mode | Network Key |
| Infrastructure      | WPA2-PSK              | AES             | 12345678    |



If your router uses WEP encryption, enter the key used as the first WEP key. Your Fuji Xerox machine supports the use of the first WEP key only.

2. Press  [Settings] > [All Settings] > [Network] > [WLAN] > [Setup Wizard].
3. When [Switch Network interface to wireless?] appears, press [Yes].  
This will start the wireless setup wizard. To cancel, press [No].
4. The machine will search for your network and display a list of available SSIDs. Press ▲ or ▼ to display [<New SSID>]. Press [<New SSID>], and then press [OK].
5. Enter the SSID name, and then press [OK].
6. Press [Infrastructure] when instructed.
7. Select the Authentication Method.
8. Do one of the following:

- 
- If you selected the [Open System] option, press [None] or [WEP].  
If you selected the [WEP] option for Encryption type, enter the WEP key, and then press [OK].
  - If you selected the [Shared Key] option, enter the WEP key, and then press [OK].
  - If you selected the [WPA/WPA2-PSK] option, press [TKIP+AES] or [AES].  
Enter the WPA™ key, and then press [OK].



Your Fuji Xerox machine supports the use of the first WEP key only.

9. The machine attempts to connect to the wireless device you have selected.

If your wireless device is connected successfully, the machine's LCD displays [Connected].

You have completed the wireless network setup. To install **Full Driver & Software Package** necessary for operating your device, insert the Fuji Xerox installation disc into your computer or go to the download page for your model on the Fuji Xerox website at <http://www.fujixeroxprinters.com/>.



### Related Information

- [Additional Methods of Configuring Your Fuji Xerox Machine for a Wireless Network](#)
  - [I Cannot Complete the Wireless Network Setup Configuration](#)
  - [How to Enter Text on Your Fuji Xerox Machine](#)
  - [Wireless LAN Report Error Codes](#)
-

## Use Wi-Fi Direct®

- [Print or Scan from Your Mobile Device Using Wi-Fi Direct](#)
- [Configure Your Wi-Fi Direct Network](#)
- [I Cannot Complete the Wireless Network Setup Configuration](#)

## Print or Scan from Your Mobile Device Using Wi-Fi Direct

Wi-Fi Direct is one of the wireless configuration methods developed by the Wi-Fi Alliance®. It allows you to configure a secured wireless network between your Fuji Xerox machine and a mobile device, such as an Android™ device, Windows® device, iPhone, iPod touch, or iPad, without using an access point. Wi-Fi Direct supports wireless network configuration using the one-push or PIN Method of Wi-Fi Protected Setup™ (WPS). You can also configure a wireless network by manually setting an SSID and password. Your Fuji Xerox machine's Wi-Fi Direct feature supports WPA2™ security with AES encryption.

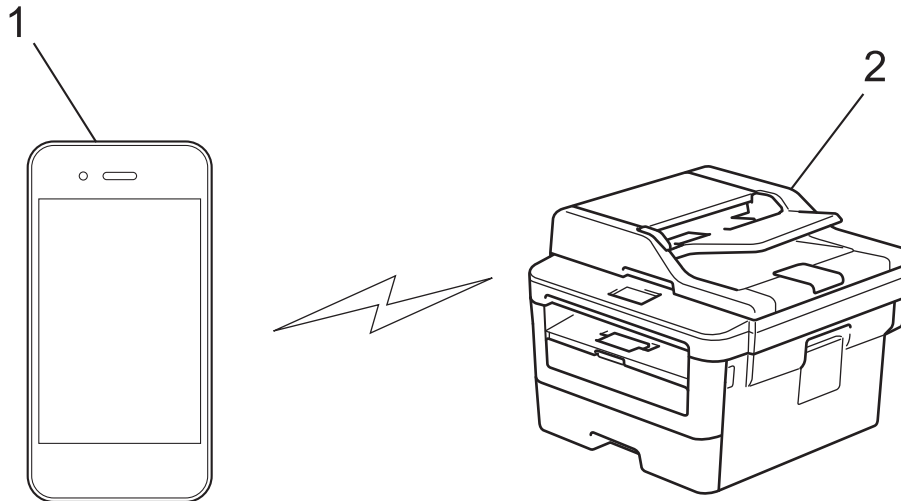

1. Mobile device
2. Your Fuji Xerox machine



- Although the Fuji Xerox machine can be used in both a wired and wireless network, only one connection method can be used at a time. However, a wireless network connection and Wi-Fi Direct connection, or a wired network connection (supported models only) and Wi-Fi Direct connection can be used at the same time.
- The Wi-Fi Direct-supported device can become a Group Owner (G/O). When configuring the Wi-Fi Direct network, the G/O serves as an access point.



### Related Information

- [Use Wi-Fi Direct®](#)

## Configure Your Wi-Fi Direct Network

Configure your Wi-Fi Direct network settings from your machine's control panel.

- [Wi-Fi Direct Network Configuration Overview](#)
- [Configure Your Wi-Fi Direct Network Using the One-Push Method](#)
- [Configure Your Wi-Fi Direct Network Using the One-Push Method of Wi-Fi Protected Setup™ \(WPS\)](#)
- [Configure Your Wi-Fi Direct Network Using the PIN Method](#)
- [Configure Your Wi-Fi Direct Network Using the PIN Method of Wi-Fi Protected Setup™ \(WPS\)](#)
- [Configure Your Wi-Fi Direct Network Manually](#)

## Wi-Fi Direct Network Configuration Overview

The following instructions offer five methods for configuring your Fuji Xerox machine in a wireless network environment. Select the method you prefer for your environment:

Check your mobile device for configuration.

1. Does your mobile device support Wi-Fi Direct?

| Option | Description  |
|--------|--------------|
| Yes    | Go to Step 2 |
| No     | Go to Step 3 |

2. Does your mobile device support one-push configuration for Wi-Fi Direct?

| Option | Description  |
|--------|--|
| Yes    | See <i>Related Information: Configure Your Wi-Fi Direct Network Using the One-Push Method.</i> |
| No     | See <i>Related Information: Configure Your Wi-Fi Direct Network Using the PIN Method.</i>      |

3. Does your mobile device support Wi-Fi Protected Setup™ (WPS)?

| Option | Description   |
|--------|---|
| Yes    | Go to Step 4  |
| No     | See <i>Related Information: Configure Your Wi-Fi Direct Network Manually.</i> |

4. Does your mobile device support one-push configuration for Wi-Fi Protected Setup™ (WPS)?

| Option | Description  |
|--------|--|
| Yes    | See <i>Related Information: Configure Your Wi-Fi Direct Network Using the One-Push Method of Wi-Fi Protected Setup™ (WPS).</i> |
| No     | See <i>Related Information: Configure Your Wi-Fi Direct Network Using the PIN Method of Wi-Fi Protected Setup™ (WPS).</i>      |

To use **Print Utility** functionality in a Wi-Fi Direct network configured by one-push configuration using Wi-Fi Direct or by PIN Method configuration using Wi-Fi Direct, the device you use to configure Wi-Fi Direct must be running Android™ 4.0 or greater.

### ✓ Related Information

- [Configure Your Wi-Fi Direct Network](#)
- [Configure Your Wi-Fi Direct Network Using the One-Push Method](#)
- [Configure Your Wi-Fi Direct Network Using the One-Push Method of Wi-Fi Protected Setup™ \(WPS\)](#)
- [Configure Your Wi-Fi Direct Network Using the PIN Method](#)
- [Configure Your Wi-Fi Direct Network Using the PIN Method of Wi-Fi Protected Setup™ \(WPS\)](#)
- [Configure Your Wi-Fi Direct Network Manually](#)

## Configure Your Wi-Fi Direct Network Using the One-Push Method

>> DocuPrint M235 dw/DocuPrint M235 z  
>> DocuPrint M275 z/DocuPrint M285 z

### DocuPrint M235 dw/DocuPrint M235 z

If your mobile device supports Wi-Fi Direct, follow these steps to configure a Wi-Fi Direct network:



1. Press **Menu**.
2. Press **▲** or **▼** to select the [Network] option, and then press **OK**.
3. Press **▲** or **▼** to select the [Wi-Fi Direct] option, and then press **OK**.
4. Press **▲** or **▼** to select the [Push Button] option, and then press **OK**.
5. When [Wi-Fi Direct On?] appears, enable the Wi-Fi Direct network.
6. Activate Wi-Fi Direct on your mobile device (see your mobile device's user's guide for instructions) when [Activate Wi-Fi Direct on other device and press OK.] appears on the machine's LCD. Press **OK** on your machine.  
This will start the Wi-Fi Direct setup. To cancel, press **Clear**.
7. Do one of the following:
  - When your Fuji Xerox machine is the Group Owner (G/O), connect your mobile device to the machine directly.
  - When your Fuji Xerox machine is not the G/O, it will display available device names with which to configure a Wi-Fi Direct network. Press **▲** or **▼** to select the mobile device you want to connect to and press **OK**. Search for available devices again by pressing [Rescan].
8. If your mobile device connects successfully, the machine's LCD displays [Connected]. You have completed the Wi-Fi Direct network setup.

### DocuPrint M275 z/DocuPrint M285 z

If your mobile device supports Wi-Fi Direct, follow these steps to configure a Wi-Fi Direct network:



When the machine receives the Wi-Fi Direct request from your mobile device, the message [Wi-Fi Direct connection request received. Press [OK] to connect.] will appear on the LCD. Press [OK] to connect.

1. Press  [Settings] > [All Settings] > [Network] > [Wi-Fi Direct] > [Push Button].
2. Activate Wi-Fi Direct on your mobile device (see your mobile device's user's guide for instructions) when [Activate Wi-Fi Direct on other device. Then Press [OK].] appears on the machine's LCD. Press [OK] on your machine.  
This will start the Wi-Fi Direct setup. To cancel, press .
3. Do one of the following:
  - When your Fuji Xerox machine is the Group Owner (G/O), connect your mobile device to the machine directly.
  - When your Fuji Xerox machine is not the G/O, it displays available device names with which to configure a Wi-Fi Direct network. Select the mobile device you want to connect to. Search for available devices again by pressing [Rescan].
4. If your mobile device connects successfully, the machine's LCD displays [Connected]. You have completed the Wi-Fi Direct network setup.



## Related Information

- [Configure Your Wi-Fi Direct Network](#)
  - [Wi-Fi Direct Network Configuration Overview](#)
-



## Configure Your Wi-Fi Direct Network Using the One-Push Method of Wi-Fi Protected Setup™ (WPS)

>> [DocuPrint M235 dw/DocuPrint M235 z](#)  
>> [DocuPrint M275 z/DocuPrint M285 z](#)

### DocuPrint M235 dw/DocuPrint M235 z

If your mobile device supports WPS (PBC: Push Button Configuration), follow these steps to configure a Wi-Fi Direct network:

1. Press **Menu**.
2. Press **▲** or **▼** to select the [Network] option, and then press **OK**.
3. Press **▲** or **▼** to select the [Wi-Fi Direct] option, and then press **OK**.
4. Press **▲** or **▼** to select the [Group Owner] option, and then press **OK**.
5. Press **▲** or **▼** to select the [On] option, and then press **OK**.
6. Press **▲** or **▼** to select the [Push Button] option, and then press **OK**.
7. When [Wi-Fi Direct On?] appears, enable the Wi-Fi Direct network.
8. Activate your mobile device's WPS one-push configuration method (see your mobile device's user's guide for instructions) when [Activate Wi-Fi Direct on other device and press OK.] appears on the machine's LCD. Press **OK** on your machine.

This will start the Wi-Fi Direct setup. To cancel, press **Clear**.

9. If your mobile device connects successfully, the machine's LCD displays [Connected]. You have completed the Wi-Fi Direct network setup.

### DocuPrint M275 z/DocuPrint M285 z

If your mobile device supports WPS (PBC: Push Button Configuration), follow these steps to configure a Wi-Fi Direct network:



When the machine receives the Wi-Fi Direct request from your mobile device, the message [Wi-Fi Direct connection request received. Press [OK] to connect.] will appear on the LCD. Press [OK] to connect.

1. Press  [Settings] > [All Settings] > [Network] > [Wi-Fi Direct] > [Group Owner].
2. Press [On].
3. Press **▲** or **▼** to select the [Push Button] option. Press [Push Button].
4. Activate your mobile device's WPS one-push configuration method (see your mobile device's user's guide for instructions) when [Activate Wi-Fi Direct on other device. Then Press [OK].] appears on the machine's LCD. Press [OK] on your Fuji Xerox machine.

This will start the Wi-Fi Direct setup. To cancel, press .

5. If your mobile device connects successfully, the machine's LCD displays [Connected]. You have completed the Wi-Fi Direct network setup.

### Related Information

- [Configure Your Wi-Fi Direct Network](#)
- [Wi-Fi Direct Network Configuration Overview](#)

## Configure Your Wi-Fi Direct Network Using the PIN Method

>> [DocuPrint M235 dw/DocuPrint M235 z](#)  
>> [DocuPrint M275 z/DocuPrint M285 z](#)

### DocuPrint M235 dw/DocuPrint M235 z

If your mobile device supports the PIN Method of Wi-Fi Direct, follow these steps to configure a Wi-Fi Direct network:

1. Press **Menu**.
2. Press **▲** or **▼** to select the [Network] option, and then press **OK**.
3. Press **▲** or **▼** to select the [Wi-Fi Direct] option, and then press **OK**.
4. Press **▲** or **▼** to select the [PIN Code] option, and then press **OK**.
5. When [Wi-Fi Direct On?] appears, enable the Wi-Fi Direct network.
6. Activate Wi-Fi Direct on your mobile device (see your mobile device's user's guide for instructions) when [Activate Wi-Fi Direct on other device and press OK.] appears on the machine's LCD. Press **OK** on your machine.  
This will start the Wi-Fi Direct setup. To cancel, press **Clear**.
7. Do one of the following:
  - When your Fuji Xerox machine is the Group Owner (G/O), it will wait for a connection request from your mobile device. When [Input PIN Code] appears, enter the PIN displayed on your mobile device in your Fuji Xerox machine. Press **OK** to complete the setup.  
If the PIN is displayed on your Fuji Xerox machine, enter the PIN in your mobile device.
  - When your Fuji Xerox machine is not the G/O, it will display available device names with which to configure a Wi-Fi Direct network. Press **▲** or **▼** to select the mobile device you want to connect to and press **OK**. Search for available devices again by pressing [Rescan].
8. Do one of the following:
  - Follow the machine's instruction to display the PIN on your Fuji Xerox machine, enter the PIN in your mobile device, and then go to the next step.
  - Follow the machine's instruction to enter the PIN displayed by your mobile device in your Fuji Xerox machine. Press **OK**, and then go to the next step.  
If your mobile device does not display a PIN, press **Stop/Exit** on your Fuji Xerox machine. Go back to the first step and try again.
9. If your mobile device connects successfully, the machine's LCD displays [Connected]. You have completed the Wi-Fi Direct network setup.

### DocuPrint M275 z/DocuPrint M285 z

If your mobile device supports the PIN Method of Wi-Fi Direct, follow these steps to configure a Wi-Fi Direct network:



When the machine receives the Wi-Fi Direct request from your mobile device, the message [Wi-Fi Direct connection request received. Press [OK] to connect.] will appear on the LCD. Press [OK] to connect.

1. Press  [Settings] > [All Settings] > [Network] > [Wi-Fi Direct] > [PIN Code].
2. Activate Wi-Fi Direct on your mobile device (see your mobile device's user's guide for instructions) when [Activate Wi-Fi Direct on other device. Then Press [OK].] appears on the machine's LCD. Press [OK] on your machine.

---

This will start the Wi-Fi Direct setup. To cancel, press .

3. Do one of the following:

- When your Fuji Xerox machine is the Group Owner (G/O), it will wait for a connection request from your mobile device. When [PIN Code] appears, enter the PIN displayed on your mobile device in your Fuji Xerox machine. Press [OK] to complete the setup.

If the PIN is displayed on your Fuji Xerox machine, enter the PIN in your mobile device.

- When your Fuji Xerox machine is not the G/O, it displays available device names with which to configure a Wi-Fi Direct network. Select the mobile device you want to connect to and press [OK]. Search for available devices again by pressing [Rescan].

4. Do one of the following:

- Press [Display PIN Code] to display the PIN on your Fuji Xerox machine and enter the PIN in your mobile device. Go to the next step.
- Press [Input PIN Code] to enter the PIN displayed by your mobile device in your Fuji Xerox machine, and then press [OK]. Go to the next step.

If your mobile device does not display a PIN, press  on your Fuji Xerox machine. Go back to the first step and try again.

5. If your mobile device connects successfully, the machine's LCD displays [Connected]. You have completed the Wi-Fi Direct network setup.



## Related Information

- [Configure Your Wi-Fi Direct Network](#)
  - [Wi-Fi Direct Network Configuration Overview](#)
-

## Configure Your Wi-Fi Direct Network Using the PIN Method of Wi-Fi Protected Setup™ (WPS)

>> [DocuPrint M235 dw/DocuPrint M235 z](#)  
>> [DocuPrint M275 z/DocuPrint M285 z](#)

### DocuPrint M235 dw/DocuPrint M235 z

If your mobile device supports the PIN Method of Wi-Fi Protected Setup™ (WPS), follow these steps to configure a Wi-Fi Direct network:



1. Press **Menu**.
2. Press **▲** or **▼** to select the [Network] option, and then press **OK**.
3. Press **▲** or **▼** to select the [Wi-Fi Direct] option, and then press **OK**.
4. Press **▲** or **▼** to select the [Group Owner] option, and then press **OK**.
5. Press **▲** or **▼** to select the [On] option, and then press **OK**.
6. Press **▲** or **▼** to select the [PIN Code] option, and then press **OK**.
7. When [Wi-Fi Direct On?] appears, enable the Wi-Fi Direct network.
8. Activate your mobile device's WPS PIN configuration method (see your mobile device's user's guide for instructions) when [Activate Wi-Fi Direct on other device and press OK.] appears on the machine's LCD. Press **OK** on your machine.  
This will start the Wi-Fi Direct setup. To cancel, press **Clear**.
9. The machine will wait for a connection request from your mobile device. When [Input PIN Code] appears, enter the PIN displayed on your mobile device in the machine.
10. Press **OK**.
11. If your mobile device connects successfully, the machine's LCD displays [Connected]. You have completed the Wi-Fi Direct network setup.

### DocuPrint M275 z/DocuPrint M285 z

If your mobile device supports the PIN Method of Wi-Fi Protected Setup™ (WPS), follow these steps to configure a Wi-Fi Direct network:



When the machine receives the Wi-Fi Direct request from your mobile device, the message [Wi-Fi Direct connection request received.Press [OK] to connect.] will appear on the LCD. Press [OK] to connect.

1. Press  [Settings] > [All Settings] > [Network] > [Wi-Fi Direct] > [Group Owner].
2. Press [On].
3. Press **▲** or **▼** to select the [PIN Code] option. Press [PIN Code].
4. When [Activate Wi-Fi Direct on other device. Then Press [OK].] appears, activate your mobile device's WPS PIN configuration method (see your mobile device's user's guide for instructions) and then press [OK] on your Fuji Xerox machine.  
This will start the Wi-Fi Direct setup. To cancel, press .
5. The machine will wait for a connection request from your mobile device. When [PIN Code] appears, enter the PIN displayed on your mobile device in to the machine. Press [OK].
6. If your mobile device connects successfully, the machine's LCD displays [Connected]. You have completed the Wi-Fi Direct network setup.



## Related Information

- [Configure Your Wi-Fi Direct Network](#)
  - [Wi-Fi Direct Network Configuration Overview](#)
-

## Configure Your Wi-Fi Direct Network Manually

>> [DocuPrint M235 dw/DocuPrint M235 z](#)  
>> [DocuPrint M275 z/DocuPrint M285 z](#)

### DocuPrint M235 dw/DocuPrint M235 z

If your mobile device does not support Wi-Fi Direct or WPS, you must configure a Wi-Fi Direct network manually.

1. Press **Menu**.
2. Press **▲** or **▼** to select the [Network] option, and then press **OK**.
3. Press **▲** or **▼** to select the [Wi-Fi Direct] option, and then press **OK**.
4. Press **▲** or **▼** to select the [Manual] option, and then press **OK**.
5. When [Wi-Fi Direct On?] appears, enable the Wi-Fi Direct network.
6. The machine will display the SSID name and Password for two minutes. Go to your mobile device's wireless network settings screen, select the SSID name, and then enter the password.
7. If your mobile device connects successfully, the machine's LCD displays [Connected]. You have completed the Wi-Fi Direct network setup.

### DocuPrint M275 z/DocuPrint M285 z

If your mobile device does not support Wi-Fi Direct or WPS, you must configure a Wi-Fi Direct network manually.



When the machine receives the Wi-Fi Direct request from your mobile device, the message [Wi-Fi Direct connection request received.Press [OK] to connect.] will appear on the LCD. Press [OK] to connect.

1. Press  [Settings] > [All Settings] > [Network] > [Wi-Fi Direct] > [Manual].
2. The machine will display the SSID name and Password for two minutes. Go to your mobile device's wireless network settings screen, select the SSID name, and then enter the password.
3. If your mobile device connects successfully, the machine's LCD displays [Connected]. You have completed the Wi-Fi Direct network setup.

### ✓ Related Information

- [Configure Your Wi-Fi Direct Network](#)
- [Wi-Fi Direct Network Configuration Overview](#)

## Advanced Network Features

- [Print the Network Configuration Report](#)
- [Print the WLAN Report](#)
- [Synchronize Time with the SNTP Server Using Web Based Management](#)

## Print the Network Configuration Report

The Network Configuration Report lists the network configuration, including the network print server settings.



- **Node Name:** The Node Name appears on the current Network Configuration Report. The default Node Name is "FXNxxxxxxxxxxxx" for a wired network or "FXWxxxxxxxxxxxx" for a wireless network (where "xxxxxxxxxxxx" is your machine's MAC Address / Ethernet Address.)
- If the [IP Address] on the Network Configuration Report shows 0.0.0.0, wait for one minute and try printing it again.
- You can find your machine's settings, such as the IP address, subnet mask, node name, and MAC Address on the report, for example:
  - IP address: 192.168.0.5
  - Subnet mask: 255.255.255.0
  - Node name: FXN000ca0000499
  - MAC Address: 00-0c-a0-00-04-99

>> [DocuPrint M235 dw/DocuPrint M235 z](#)

>> [DocuPrint M275 z/DocuPrint M285 z](#)

### DocuPrint M235 dw/DocuPrint M235 z

1. Press **Menu**.
2. Press **▲** or **▼** to display the [Print Reports] option, and then press **OK**.
3. Press **▲** or **▼** to select the [Network Config] option, and then press **OK**.
4. Press **Start**.

### DocuPrint M275 z/DocuPrint M285 z

1. Press  [Settings] > [All Settings] > [Print Reports] > [Network Configuration].
2. Press [Yes].

The machine prints the Network Configuration Report.

### Related Information

- [Advanced Network Features](#)
- [Where Can I Find My Fuji Xerox Machine's Network Settings?](#)
- [I Want to Check that My Network Devices are Working Correctly](#)
- [Access Web Based Management](#)



## Print the WLAN Report

The WLAN Report reflects your machine's wireless status. If the wireless connection fails, check the error code on the printed report.

>> [DocuPrint M235 dw/DocuPrint M235 z](#)

>> [DocuPrint M275 z/DocuPrint M285 z](#)

### DocuPrint M235 dw/DocuPrint M235 z

1. Press **Menu**.
2. Press **▲** or **▼** to display the [Print Reports] option, and then press **OK**.
3. Press **▲** or **▼** to select the [WLAN Report] option, and then press **OK**.
4. Press **Start**.

The machine will print the WLAN Report.

### DocuPrint M275 z/DocuPrint M285 z

1. Press  [Settings] > [All Settings] > [Print Reports] > [WLAN Report].
2. Press [Yes].

The machine will print the WLAN Report.

If the WLAN Report does not print, check your machine for errors. If there are no visible errors, wait for one minute and then try to print the report again.

### Related Information

- [Advanced Network Features](#)
- [Wireless LAN Report Error Codes](#)
- [My Fuji Xerox Machine Cannot Print, Scan, or PC-FAX Receive over the Network](#)
- [I Want to Check that My Network Devices are Working Correctly](#)

## Wireless LAN Report Error Codes

If the Wireless LAN Report shows that the connection failed, check the error code on the printed report and see the corresponding instructions in the table:

| Error Code | Problem and Recommended Solutions   |
|------------|---|
| TS-01      | <p>The wireless setting is not activated, change the wireless setting to ON.</p> <p>If a network cable is connected to your machine, disconnect it and change the wireless setting of your machine to ON.</p>   |
| TS-02      | <p>The wireless access point/router cannot be detected.</p> <ol style="list-style-type: none"> <li>Check the following two points: <ul style="list-style-type: none"> <li>Unplug the power to your wireless access point/router, wait for 10 seconds, and then plug it back in.</li> <li>If your WLAN access point/router is using MAC address filtering, confirm that the MAC address of the Fuji Xerox machine is allowed in the filter.</li> </ul> </li> <li>If you manually entered the SSID and security information (SSID/authentication method/encryption method/Network Key), the information may be incorrect. Reconfirm the SSID and security information and re-enter the correct information as necessary.</li> </ol> <p>This device does not support a 5 GHz SSID/ESSID and you must select a 2.4 GHz SSID/ESSID. Make sure the access point/router is set to 2.4 GHz or 2.4 GHz/5 GHz mixed mode.</p> |
| TS-04      | <p>The Authentication/Encryption methods used by the selected wireless access point/router are not supported by your machine.</p> <p>Change the authentication and encryption method of the wireless access point/router. Your machine supports the following authentication methods:</p> <ul style="list-style-type: none"> <li>WPA-Personal<br/>TKIP or AES</li> <li>WPA2-Personal<br/>TKIP or AES</li> <li>Open<br/>WEP or None (without encryption)</li> <li>Shared key<br/>WEP</li> </ul> <p>If your problem is not solved, the SSID or network settings you entered may be incorrect. Confirm the wireless network settings.</p>  |
| TS-05      | <p>The security information (SSID/Network Key) is incorrect.</p> <p>Confirm the wireless security information (Authentication method/Encryption method/Network Key).</p>  |
| TS-06      | <p>The machine cannot detect a WLAN access point/router that has WPS enabled.</p> <p>Confirm the wireless security information (Authentication method/Encryption method/Network Key).</p>   |
| TS-07      | <p>The machine cannot detect a WLAN access point/router that has WPS enabled.</p> <p>If you want to connect with WPS, you must operate both your machine and the WLAN access point/router. Confirm the connection method for WPS on WLAN access point/router and try starting again.</p> <p>If you do not know how to operate your WLAN access point/router using WPS, see the documentation provided with your WLAN access point/router, ask the manufacturer of your WLAN access point/router or ask your network administrator.</p>  |

---

| Error Code | Problem and Recommended Solutions  |
|------------|--|
| TS-08      | Two or more WLAN access points that have WPS enabled are detected. <ul style="list-style-type: none"><li>• Confirm that only one WLAN access point/router within range has the WPS method active and try again.</li><li>• Try starting again after few minutes in order to avoid effects from other access points.</li></ul> |



### Related Information

- [Print the WLAN Report](#)
  - [My Fuji Xerox Machine Cannot Print, Scan, or PC-FAX Receive over the Network](#)
  - [I Want to Check that My Network Devices are Working Correctly](#)
  - [Configure Your Machine for a Wireless Network Using the One Push Method of Wi-Fi Protected Setup™ \(WPS\)](#)
  - [Configure Your Machine for a Wireless Network Using the PIN Method of Wi-Fi Protected Setup™ \(WPS\)](#)
  - [Configure Your Machine for a Wireless Network Using the Machine's Control Panel Setup Wizard](#)
  - [Configure Your Machine for a Wireless Network When the SSID Is Not Broadcast](#)
-

## **Synchronize Time with the SNTP Server Using Web Based Management**

The Simple Network Time Protocol (SNTP) is used to synchronize the time used by the machine for authentication with the SNTP time server. (This is not the time displayed on the machine's LCD.) You can automatically or manually synchronize the machine's time with the Coordinated Universal Time (UTC) provided by the SNTP time server.

- [Configure Date and Time Using Web Based Management](#)
- [Configure the SNTP Protocol Using Web Based Management](#)

## Configure Date and Time Using Web Based Management

**Related Models:** DocuPrint M235 z/DocuPrint M275 z/DocuPrint M285 z

Configure date and time to synchronize the time used by the machine with the SNTP time server.

This feature is not available in some countries.

1. Start your web browser.
2. Type "http://machine's IP address" in your browser's address bar (where "machine's IP address" is the machine's IP address).

For example:

http://192.168.1.2

3. No password is required by default. Type a password if you have set one, and then click .
4. Click the **Administrator** tab.
5. Click **Date&Time** in the left navigation bar.

### Date&Time

|                      |   |
|----------------------|---|
| <b>Date</b>          | <input type="text" value="xx"/> / <input type="text" value="xx"/> / <input type="text" value="20xx"/> |
| <b>Clock Type</b>    | <input checked="" type="radio"/> 12h Clock <input type="radio"/> 24h Clock                            |
| <b>Time</b>          | <input type="text" value="xx"/> : <input type="text" value="xx"/> <input type="text" value="AM"/>     |
| <b>Time Zone</b>     | <input type="text" value="UTC+09:00"/>  |
| <b>Auto Daylight</b> | <input checked="" type="radio"/> Off <input type="radio"/> On   |

**Synchronize with SNTP server**

To synchronize the "Date&Time" with your SNTP server, you must configure the SNTP server settings.

[SNTP>>](#)



Select the time difference between your location and UTC from the **Time Zone** drop-down list. For example, the time zone for Eastern Time in the USA and Canada is UTC-05:00.

6. Verify the **Time Zone** settings.
7. Select the **Synchronize with SNTP server** check box.
8. Click **Submit**.



### Related Information

- [Synchronize Time with the SNTP Server Using Web Based Management](#)

## Configure the SNTP Protocol Using Web Based Management

**Related Models:** DocuPrint M235 z/DocuPrint M275 z/DocuPrint M285 z

Configure the SNTP protocol to synchronize the time the machine uses for authentication with the time kept by the SNTP time server.

1. Start your web browser.
2. Type "http://machine's IP address" in your browser's address bar (where "machine's IP address" is the machine's IP address).

For example:

http://192.168.1.2

3. No password is required by default. Type a password if you have set one, and then click .
4. Click the **Network** tab.
5. Click the **Protocol** menu in the left navigation bar.
6. Select the **SNTP** check box to activate the settings.
7. Click **Submit**.
8. Restart your Fuji Xerox machine to activate the configuration.
9. Next to the SNTP check box, click **Advanced Settings** and follow the instructions below:

### SNTP

**Status** Enabled

**Synchronization Status** Succeeded

---

**SNTP Server Method**

**Primary SNTP Server Address**

**Primary SNTP Server Port**

**Secondary SNTP Server Address**

**Secondary SNTP Server Port**

**Synchronization Interval**  hour(s)

---

[Date&Time>>](#)

| Option                        | Description  |
|-------------------------------|--|
| <b>Status</b>                 | Displays whether the SNTP protocol is enabled or disabled.   |
| <b>Synchronization Status</b> | Confirm the latest synchronization status.   |
| <b>SNTP Server Method</b>     | Select <b>AUTO</b> or <b>STATIC</b> . <ul style="list-style-type: none"><li>• <b>AUTO</b><br/>If you have a DHCP server in your network, the SNTP server will obtain the address from that server automatically.</li><li>• <b>STATIC</b></li></ul> |

---

| Option                               | Description   |
|--------------------------------------|---|
|                                      | Type the address you want to use.   |
| <b>Primary SNTP Server Address</b>   | Type the server address (up to 64 characters).  |
| <b>Secondary SNTP Server Address</b> | The secondary SNTP server address is used as a backup to the primary SNTP server address. If the primary server is unavailable, the machine will contact the secondary SNTP server. |
| <b>Primary SNTP Server Port</b>      | Type the port number (1-65535).   |
| <b>Secondary SNTP Server Port</b>    | The secondary SNTP server port is used as a backup to the primary SNTP server port. If the primary port is unavailable, the machine will contact the secondary SNTP port.           |
| <b>Synchronization Interval</b>      | Type the number of hours between server synchronization attempts (1-168 hours).   |

10. Click **Submit**.



### Related Information

- [Synchronize Time with the SNTP Server Using Web Based Management](#)
-

## Technical Information for Advanced Users

- [Reset the Network Settings to the Factory Settings](#)



## Reset the Network Settings to the Factory Settings

You can use your machine's control panel to reset the print server to its default factory settings. This resets all information, such as the password and IP address.



- This feature restores all wired (supported models only) and wireless network settings to the factory settings.
- You can also reset the print server to its factory settings using BRAdmin Light or Web Based Management.

>> [DocuPrint M235 dw/DocuPrint M235 z](#)

>> [DocuPrint M275 z/DocuPrint M285 z](#)

### DocuPrint M235 dw/DocuPrint M235 z

1. Press **Menu**.
2. Press **▲** or **▼** to display the [Network] option, and then press **OK**.
3. Press **▲** or **▼** to display the [Network Reset] option, and then press **OK**.
4. Follow the machine's instruction to reset the network settings.  
The machine will restart.

### DocuPrint M275 z/DocuPrint M285 z

1. Press  [Settings] > [All Settings] > [Network] > [Network Reset].
2. [Machine will reboot after resetting. Press [OK] for 2 seconds to confirm.] will be displayed. Press [OK] for two seconds to confirm.  
The machine will restart.



### Related Information

- [Technical Information for Advanced Users](#)

## Security

- [Lock the Machine Settings](#)
- [Network Security Features](#)

## Lock the Machine Settings

Before turning on the machine's Access Lock, make a careful note of your password. If you forget the password, you must reset all passwords stored in the machine by contacting your administrator or Fuji Xerox customer service.

- [Setting Lock Overview](#)

## Setting Lock Overview

Use the Setting Lock feature to block unauthorised access to machine settings.

When Setting Lock is set to On, you cannot access the machine settings without entering the password.

- [Set the Setting Lock Password](#)
- [Change the Setting Lock Password](#)
- [Turn Setting Lock On](#)

## Set the Setting Lock Password

**Related Models:** DocuPrint M235 z/DocuPrint M275 z/DocuPrint M285 z



>> [DocuPrint M235 z](#)

>> [DocuPrint M275 z/DocuPrint M285 z](#)

### DocuPrint M235 z

1. Press **Menu**.
2. Press **▲** or **▼** to display the [General Setup] option, and then press **OK**.
3. Press **▲** or **▼** to display the [Security] option, and then press **OK**.
4. Press **▲** or **▼** to display the [Setting Lock] option, and then press **OK**.
5. Enter a four-digit number for the password.
6. Press **OK**.
7. When the LCD displays [Verify:], re-enter the password.
8. Press **OK**.
9. Press **Stop/Exit**.

### DocuPrint M275 z/DocuPrint M285 z

1. Press  [Settings] > [All Settings] > [General Setup] > [Setting Lock].
2. Enter a four-digit number for the password.
3. Press [OK].
4. When the LCD displays [Verify:], re-enter the password.
5. Press [OK].
6. Press .

### Related Information

- [Setting Lock Overview](#)

## Change the Setting Lock Password

**Related Models:** DocuPrint M235 z/DocuPrint M275 z/DocuPrint M285 z



>> [DocuPrint M235 z](#)

>> [DocuPrint M275 z/DocuPrint M285 z](#)

### DocuPrint M235 z

1. Press **Menu**.
2. Press **▲** or **▼** to display the [General Setup] option, and then press **OK**.
3. Press **▲** or **▼** to display the [Security] option, and then press **OK**.
4. Press **▲** or **▼** to display the [Setting Lock] option, and then press **OK**.
5. Press **▲** or **▼** to select the [Set Password] option, and then press **OK**.
6. Enter the current four-digit password.
7. Press **OK**.
8. Enter a new four-digit password.
9. Press **OK**.
10. When the LCD displays [Verify:], re-enter the password.
11. Press **OK**.
12. Press **Stop/Exit**.

### DocuPrint M275 z/DocuPrint M285 z

1. Press  [Settings] > [All Settings] > [General Setup] > [Setting Lock] > [Set Password].
2. Enter the current four-digit password.
3. Press [OK].
4. Enter a new four-digit password.
5. Press [OK].
6. When the LCD displays [Verify:], re-enter the password.
7. Press [OK].
8. Press .

### Related Information

- [Setting Lock Overview](#)

## Turn Setting Lock On

**Related Models:** DocuPrint M235 z/DocuPrint M275 z/DocuPrint M285 z

>> [DocuPrint M235 z](#)

>> [DocuPrint M275 z/DocuPrint M285 z](#)

### DocuPrint M235 z

1. Press **Menu**.
2. Press **▲** or **▼** to display the [General Setup] option, and then press **OK**.
3. Press **▲** or **▼** to display the [Security] option, and then press **OK**.
4. Press **▲** or **▼** to display the [Setting Lock] option, and then press **OK**.
5. Press **OK** when the LCD displays [On].
6. Enter the current four-digit password.
7. Press **OK**.
8. Press **Stop/Exit**.



To turn Setting Lock off, current four-digit password, and then press **OK**.

### DocuPrint M275 z/DocuPrint M285 z

1. Press  [Settings] > [All Settings] > [General Setup] > [Setting Lock] > [Lock Off⇒On].
2. Enter the current four-digit password.
3. Press [OK].



To turn Setting Lock off, press  on the LCD, enter the current four-digit password, and then press [OK].

### Related Information

- [Setting Lock Overview](#)

## Network Security Features

- [Before Using Network Security Features](#)
- [Secure Function Lock 3.0](#)
- [Manage Your Network Machine Securely Using SSL/TLS](#)
- [Send an Email Securely](#)



## Before Using Network Security Features

Your Fuji Xerox machine employs some of the latest network security and encryption protocols available today. These network features can be integrated into your overall network security plan to help protect your data and prevent unauthorised access to the machine.



---

We recommend disabling the FTP server and TFTP protocols. Accessing the machine using these protocols is not secure. However, note that if you disable FTP server, the Scan to FTP feature will be disabled.

---



### Related Information

- [Network Security Features](#)
-

## Secure Function Lock 3.0

Fuji Xerox's Secure Function Lock 3.0 increases security by restricting the functions available on your Fuji Xerox machine.

- [Before Using Secure Function Lock 3.0](#)
- [Configure Secure Function Lock 3.0 Using Web Based Management](#)
- [Scan Using Secure Function Lock 3.0](#)
- [Configure Public Mode for Secure Function Lock 3.0](#)
- [Additional Secure Function Lock 3.0 Features](#)

## Before Using Secure Function Lock 3.0

**Related Models:** DocuPrint M275 z/DocuPrint M285 z

Use Secure Function Lock to configure passwords, set specific user page limits, and grant access to some or all of the functions listed here.

You can configure and change the following Secure Function Lock 3.0 settings using Web Based Management :

- **Print**

Print includes print jobs sent via AirPrint, Google Cloud Print™ and Print Utility.

If you register users' login names in advance, the users do not need to enter their passwords when they use the print function.

- **Copy**

- **Scan**

Scan includes scan jobs sent via Print Utility.

- **Send** (supported models only)

- **Receive** (supported models only)

- **Page Limits**

- **Page Counters**



### Related Information

- [Secure Function Lock 3.0](#)

## Configure Secure Function Lock 3.0 Using Web Based Management

**Related Models:** DocuPrint M275 z/DocuPrint M285 z

1. Start your web browser.
2. Type "http://machine's IP address" in your browser's address bar (where "machine's IP address" is the machine's IP address).  
For example:  
http://192.168.1.2
3. No password is required by default. Type a password if you have set one, and then click .
4. Click the **Administrator** tab.
5. Click the **User Restriction Function** menu in the left navigation bar.
6. Select **Secure Function Lock**.
7. Click **Submit**.
8. Click the **Restricted Functions** menu in the left navigation bar.
9. In the **User List / Restricted Functions** field, type a group name or user name.
10. In the **Print** and the other columns, select a check box to allow or clear a check box to restrict the function listed.
11. To configure the maximum page count, select the **On** check box in the **Page Limits** column, and then type the maximum number in the **Max. Pages** field.
12. Click **Submit**.
13. Click the **User List** menu in the left navigation bar.
14. In the **User List** field, type the user name.
15. In the **PIN Number** field, type a four-digit password.
16. Select **User List / Restricted Functions** from the drop-down list for each user.
17. Click **Submit**.



### Related Information

- [Secure Function Lock 3.0](#)

## Scan Using Secure Function Lock 3.0

**Related Models:** DocuPrint M275 z/DocuPrint M285 z

### Setting Scan restrictions (for administrators)

Secure Function Lock 3.0 allows an administrator to restrict which users are allowed to scan. When the Scan feature is set to Off for the public user setting, only users who have the **Scan** check box selected will be able to scan.

### Using the Scan feature (for restricted users)

- To scan using the machine's control panel:  
Restricted users must enter their PINs on the machine's control panel to access Scan mode.
- To scan from a computer:  
Restricted users must enter their PINs on the machine's control panel before scanning from their computers. If the PIN is not entered on the machine's control panel, an error message will appear on the user's computer.



### Related Information

- [Secure Function Lock 3.0](#)

## Configure Public Mode for Secure Function Lock 3.0

**Related Models:** DocuPrint M275 z/DocuPrint M285 z

Use the Secure Function Lock screen to set up Public Mode, which limits the functions available to public users. Public users will not need to enter a password to access the features made available through Public Mode settings.



Public Mode includes print jobs sent via AirPrint, Google Cloud Print™ and Print Utility.

1. Start your web browser.
2. Type "http://machine's IP address" in your browser's address bar (where "machine's IP address" is the machine's IP address).  
For example:  
http://192.168.1.2
3. No password is required by default. Type a password if you have set one, and then click .
4. Click the **Administrator** tab.
5. Click the **User Restriction Function** menu in the left navigation bar.
6. Select **Secure Function Lock**.
7. Click **Submit**.
8. Click the **Restricted Functions** menu.
9. In the **Public Mode** row, select a check box to allow or clear a check box to restrict the function listed.
10. Click **Submit**.



### Related Information

- [Secure Function Lock 3.0](#)
- [Register Your Machine with Google Cloud Print Using Web Based Management](#)

## Additional Secure Function Lock 3.0 Features

**Related Models:** DocuPrint M275 z/DocuPrint M285 z

Configure the following features in the Secure Function Lock screen:

### All Counter Reset

Click **All Counter Reset**, in the **Page Counters** column, to reset the page counter.

### Export to CSV file

Click **Export to CSV file**, to export the current page counter including **User List / Restricted Functions** information as a CSV file.

### Last Counter Record

Click **Last Counter Record** if you want the machine to retain the page count after the counter has been reset.

### Counter Auto Reset

Click **Counter Auto Reset** to configure the time interval you want between page counter reset. Choose a daily, weekly, or monthly interval.



### Related Information

- [Secure Function Lock 3.0](#)

## Manage Your Network Machine Securely Using SSL/TLS

- [Introduction to SSL/TLS](#)
- [Certificates and Web Based Management](#)
- [Manage Your Network Machine Securely Using Web Based Management](#)
- [Print Documents Securely Using SSL/TLS](#)



## Introduction to SSL/TLS

Secure Socket Layer (SSL) or Transport Layer Security (TLS) is an effective method of protecting data sent over a local or wide area network (LAN or WAN). It works by encrypting data, such as a print job, sent over a network, so anyone trying to capture it will not be able to read it.

SSL/TLS can be configured on both wired and wireless networks and will work with other forms of security such as WPA keys and firewalls.



### Related Information

- [Manage Your Network Machine Securely Using SSL/TLS](#)
  - [Brief History of SSL/TLS](#)
  - [Benefits of Using SSL/TLS](#)
-

## Brief History of SSL/TLS

SSL/TLS was originally created to secure web traffic information, particularly data sent between web browsers and servers. For example, when you use Internet Explorer® for Internet Banking and you see https:// and the little padlock icon in the web browser, you are using SSL. SSL grew to work with additional applications, such as Telnet, printer, and FTP software, in order to become a universal solution for online security. Its original design intentions are still being used today by many online retailers and banks to secure sensitive data, such as credit card numbers, customer records, etc.

SSL/TLS uses extremely high levels of encryption and is trusted by banks all over the world.



### Related Information

- [Introduction to SSL/TLS](#)
-

## Benefits of Using SSL/TLS

The primary benefit of using SSL/TLS on Fuji Xerox machines is to guarantee secure printing over an IP network by restricting unauthorised users from reading data sent to the machine. SSL's key selling point is that it can be used to print confidential data securely. For example, an HR department in a large company may be printing wage slips on a regular basis. Without encryption, the data contained on these wages slips can be read by other network users. However, with SSL/TLS, anyone trying to capture the data will see a confusing page of code and not the actual wage slip.



### Related Information

- [Introduction to SSL/TLS](#)
-

## Certificates and Web Based Management

You must configure a certificate to manage your networked Fuji Xerox machine securely using SSL/TLS. You must use Web Based Management to configure a certificate.

- [Supported Security Certificate Features](#)
- [Create and Install a Certificate](#)
- [Manage Multiple Certificates](#)

## Supported Security Certificate Features

Your Fuji Xerox machine supports the use of multiple security certificates, which allows secure management, authentication, and communication with the machine. The following security certificate features can be used with the machine:

- SSL/TLS communication
- SSL communication for SMTP

The Fuji Xerox machine supports the following:

- Pre-installed certificate

Your machine has a pre-installed self-signed certificate. This certificate enables you to use SSL/TLS communication without creating or installing a different certificate.



---

The pre-installed self-signed certificate cannot protect your communication from being compromised. We recommend using a certificate that is issued by a trusted organisation for better security.

---

- Self-signed certificate

This print server issues its own certificate. Using this certificate, you can easily use the SSL/TLS communication without creating or installing a different certificate from a CA.

- Certificate from a Certificate Authority (CA)

There are two methods for installing a certificate from a CA. If you already have a certificate from a CA or if you want to use a certificate from an external trusted CA:

- When using a Certificate Signing Request (CSR) from this print server.
- When importing a certificate and a private key.

- Certificate Authority (CA) Certificate

To use a CA certificate that identifies the CA and owns its private key, you must import that CA certificate from the CA before configuring the security features of the Network.



- If you are going to use SSL/TLS communication, we recommend contacting your system administrator first.
  - When you reset the print server back to its default factory settings, the certificate and the private key that are installed will be deleted. If you want to keep the same certificate and the private key after resetting the print server, export them before resetting, and then reinstall them.
- 



### Related Information

- [Certificates and Web Based Management](#)
-

## **Create and Install a Certificate**

- [Step by Step Guide for Creating and Installing a Certificate](#)
- [Create and Install a Self-signed Certificate](#)
- [Create and Install a Certificate from a Certificate Authority \(CA\)](#)
- [Import and Export a CA Certificate](#)

## Step by Step Guide for Creating and Installing a Certificate

There are two options when choosing a security certificate: use a self-signed certificate or use a certificate from a Certificate Authority (CA).

These are a brief summary of the actions required, based on the option you choose.

### Option 1

#### Self-Signed Certificate

1. Create a self-signed certificate using Web Based Management.
2. Install the self-signed certificate on your computer.

### Option 2

#### Certificate from a CA

1. Create a Certificate Signing Request (CSR) using Web Based Management.
2. Install the certificate issued by the CA on your Fuji Xerox machine using Web Based Management.
3. Install the certificate on your computer.



#### Related Information

- [Create and Install a Certificate](#)

## **Create and Install a Self-signed Certificate**

- [Create a Self-signed Certificate](#)
- [Install the Self-signed Certificate for Windows® users with Administrator Rights](#)
- [Import and Export the Self-signed Certificate on your Fuji Xerox Machine](#)



## Create a Self-signed Certificate

1. Start your web browser.
2. Type "http://machine's IP address" in your browser's address bar (where "machine's IP address" is the machine's IP address).

For example:

http://192.168.1.2



- If you are using a Domain Name System or enable a NetBIOS name, you can type another name, such as "SharedPrinter" instead of the IP address.

- For example:

http://SharedPrinter

If you enable a NetBIOS name, you can also use the node name.

- For example:

http://fxnxxxxxxxxxxxx

The NetBIOS name can be found in the Network Configuration Report.

- For Mac, access Web Based Management by clicking the machine's icon on the **Status Monitor** screen.

3. No password is required by default. Type a password if you have set one, and then click .
4. Click the **Network** tab.
5. Click the **Security** tab.
6. Click **Certificate**.
7. Click **Create Self-Signed Certificate**.
8. Enter a **Common Name** and a **Valid Date**.
  - The length of the **Common Name** is less than 64 bytes. Enter an identifier, such as an IP address, node name, or domain name to use when accessing this machine through SSL/TLS communication. The node name is displayed by default.
  - A warning will appear if you use the IPPS or HTTPS protocol and enter a different name in the URL than the **Common Name** that was used for the self-signed certificate.
9. Select your setting from the **Public Key Algorithm** drop-down list. The default setting is **RSA(2048bit)**.
10. Select your setting from the **Digest Algorithm** drop-down list. The default setting is **SHA256**.
11. Click **Submit**.
12. Click **Network**.
13. Click **Protocol**.
14. Click **HTTP Server Settings**.
15. Select the certificate you want to configure from the **Select the Certificate** drop-down list.
16. Click **Submit**.

The following screen appears.

## HTTP Server Settings

---

The setting for high security in communication was done.

---

To activate your new settings, this Device needs to restart.

Note: Any jobs in progress will be aborted.

To activate other protocols that have secure settings after restarting, check the box below.

Activate other protocols that have secure settings.

Would you like to restart immediately?

---

Yes

No

17. Click **Yes** to restart your print server.

The self-signed certificate is created and saved in your machine's memory.

To use SSL/TLS communication, the self-signed certificate must be installed on your computer.







### Related Information

- [Create and Install a Self-signed Certificate](#)

## Install the Self-signed Certificate for Windows® users with Administrator Rights

The following steps are for Microsoft® Internet Explorer®. If you use another web browser, consult the documentation for your web browser to get help with installing certificates.

1. Do one of the following:
  - (Windows® 7 and Windows Server® 2008)  
Click  (**Start**) > **All Programs**.
  - (Windows® 8 )  
Right-click the  (**Internet Explorer**) icon on the taskbar.
  - (Windows® 10 and Windows Server® 2016)  
Click  > **Windows Accessories**.
  - (Windows Server® 2012 and Windows Server® 2012 R2)  
Click  (**Internet Explorer**), and then right-click the  (**Internet Explorer**) icon that appears on the taskbar.
2. Right-click **Internet Explorer**, and then click **Run as administrator**.



If the **More** option appears, click **More**.

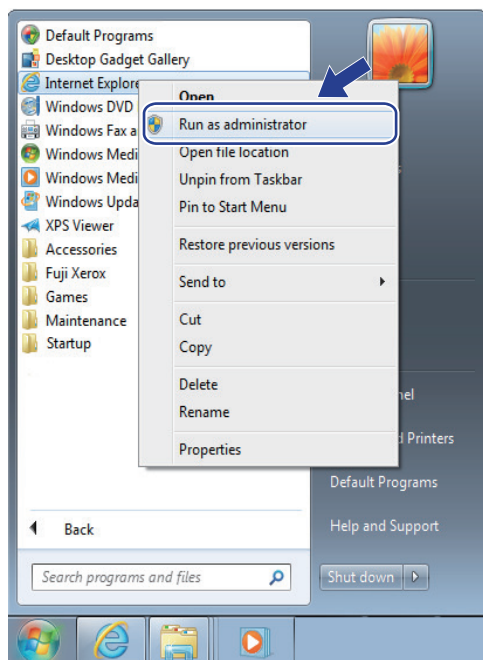

If the **User Account Control** screen appears, click **Yes**.

3. Type "https://machine's IP address" in your browser's address bar to access your machine (where "machine's IP address" is the machine's IP address or the node name that you assigned for the certificate).

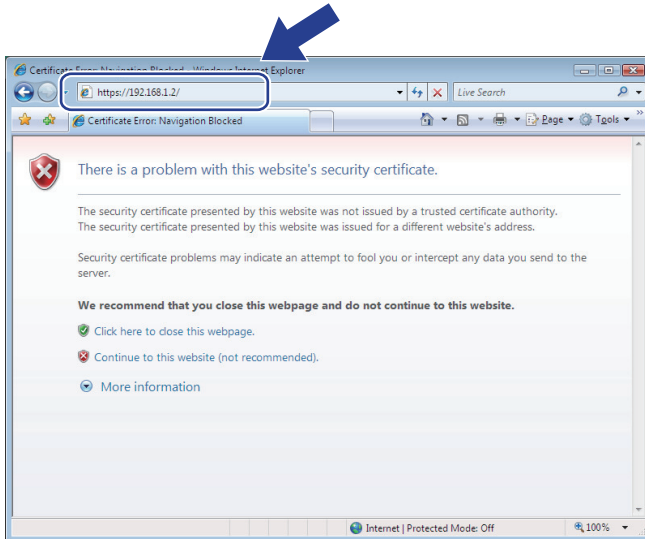

4. Click **Continue to this website (not recommended)**.

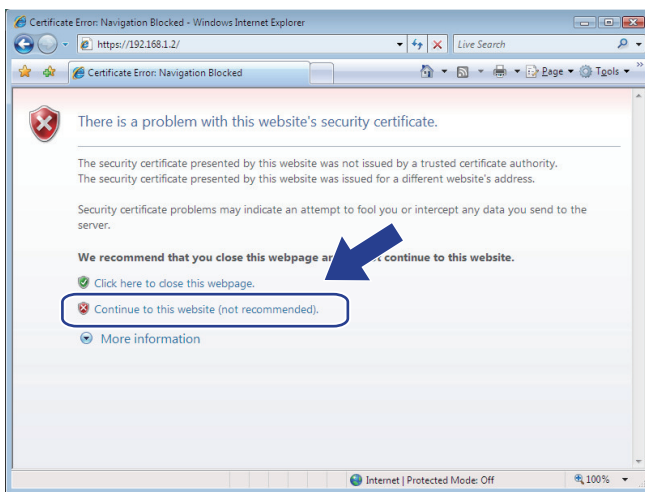

5. Click **Certificate error**, and then click **View certificates**.

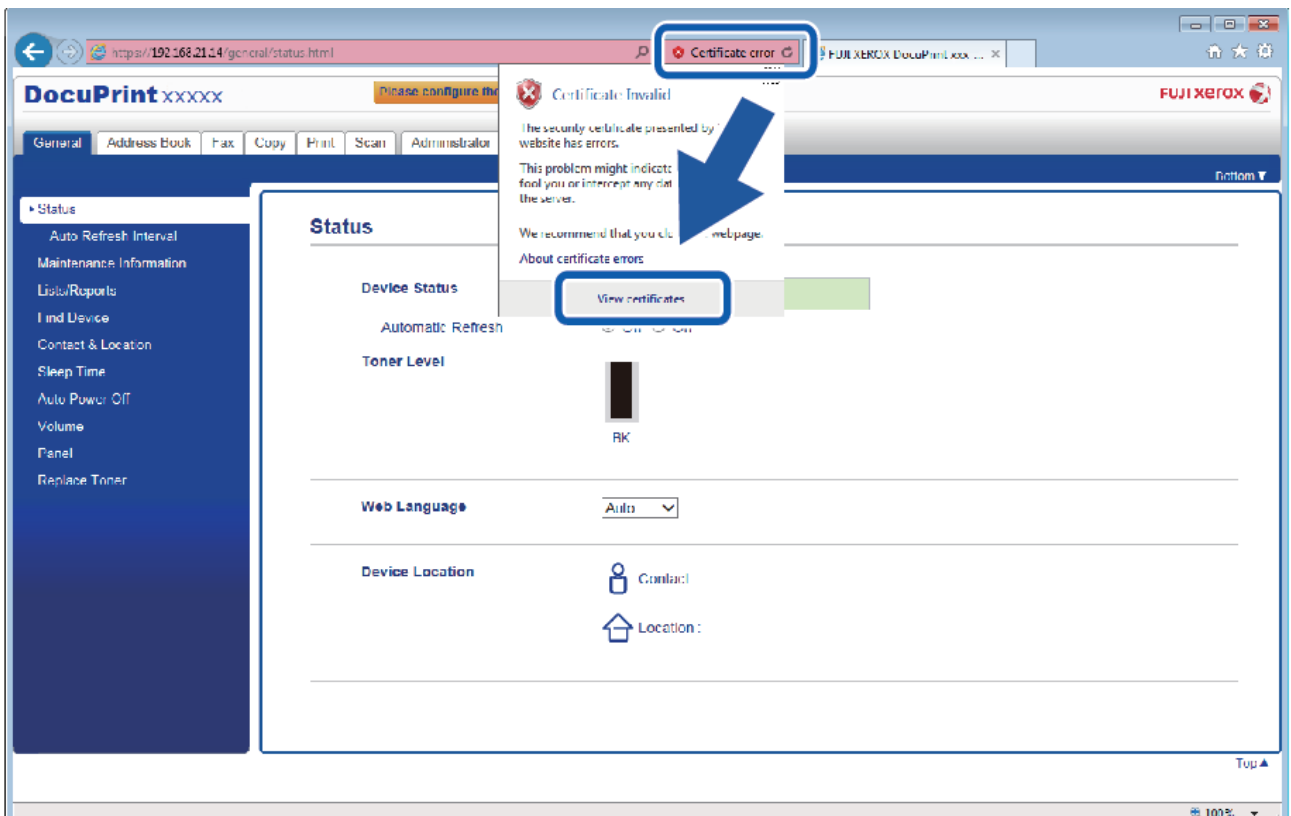

6. Click **Install Certificate...**

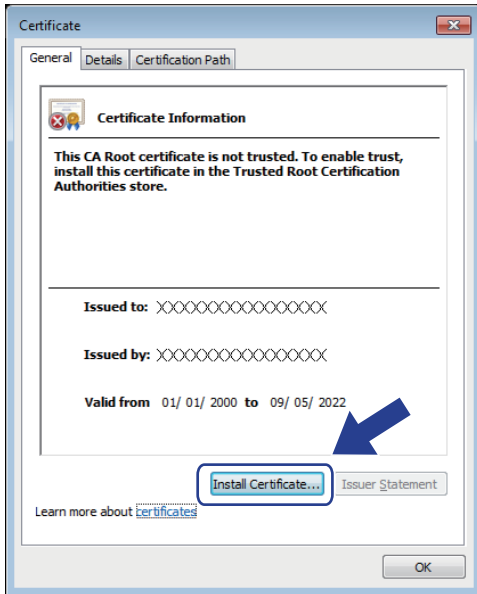

7. When the **Certificate Import Wizard** appears, click **Next**.
8. Select **Place all certificates in the following store**, and then click **Browse....**

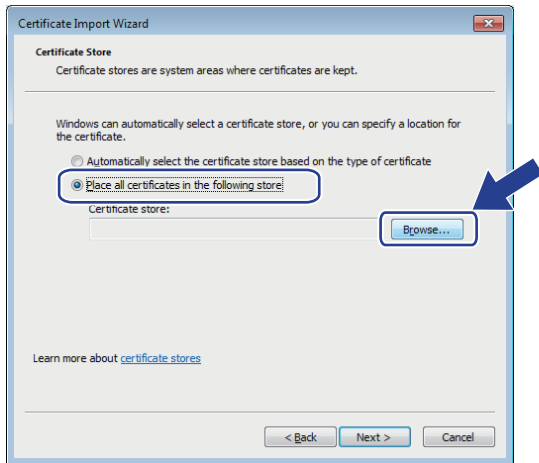

9. Select **Trusted Root Certification Authorities**, and then click **OK**.



10. Click **Next**.

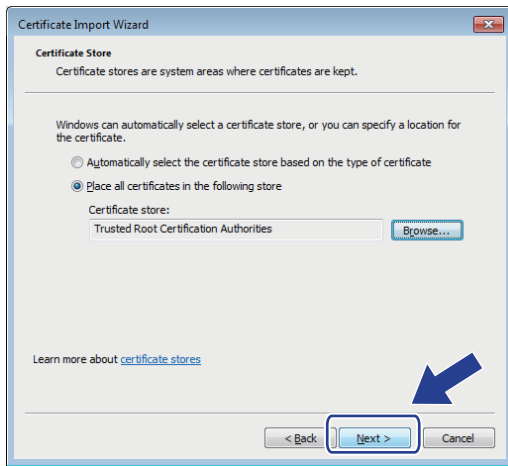

11. Click **Finish**.

12. Click **Yes**, if the fingerprint (thumbprint) is correct.

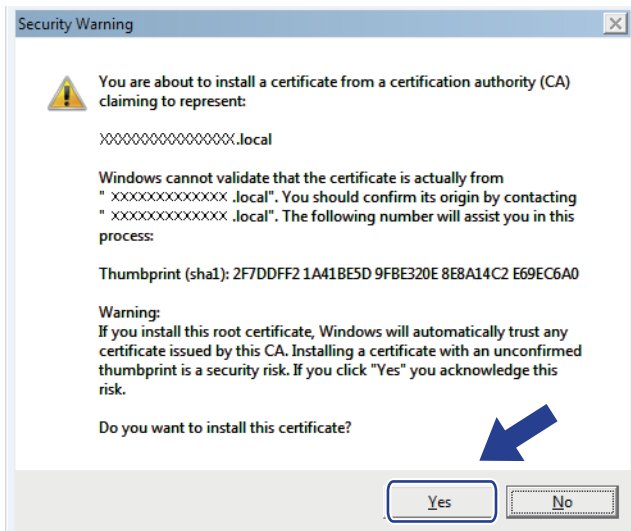

The fingerprint (thumbprint) is printed on the Network Configuration Report.

13. Click **OK**.

The self-signed certificate is now installed on your computer, and SSL/TLS communication is available.



## Related Information

- [Create and Install a Self-signed Certificate](#)

## **Import and Export the Self-signed Certificate on your Fuji Xerox Machine**

You can store the self-signed certificates on your Fuji Xerox machine and manage them by importing and exporting.

- [Import the Self-signed Certificate](#)
- [Export the Self-signed Certificate](#)

## Import the Self-signed Certificate

1. Start your web browser.
2. Type "http://machine's IP address" in your browser's address bar (where "machine's IP address" is the machine's IP address).

For example:

http://192.168.1.2



- If you are using a Domain Name System or enable a NetBIOS name, you can type another name, such as "SharedPrinter" instead of the IP address.

- For example:

http://SharedPrinter

If you enable a NetBIOS name, you can also use the node name.

- For example:

http://fxnxxxxxxxxxxxx

The NetBIOS name can be found in the Network Configuration Report.

- For Mac, access Web Based Management by clicking the machine's icon on the **Status Monitor** screen.

3. No password is required by default. Type a password if you have set one, and then click .
4. Click the **Network** tab.
5. Click the **Security** tab.
6. Click **Certificate**.
7. Click **Import Certificate and Private Key**.
8. Browse to the file you want to import.
9. Type the password if the file is encrypted, and then click **Submit**.

The self-signed certificate is imported to your machine.

To use SSL/TLS communication, the self-signed certificate must also be installed on your computer. Contact your network administrator.



### Related Information

- [Import and Export the Self-signed Certificate on your Fuji Xerox Machine](#)



## Export the Self-signed Certificate

1. Start your web browser.
2. Type "http://machine's IP address" in your browser's address bar (where "machine's IP address" is the machine's IP address).

For example:

http://192.168.1.2



- If you are using a Domain Name System or enable a NetBIOS name, you can type another name, such as "SharedPrinter" instead of the IP address.

- For example:

http://SharedPrinter

If you enable a NetBIOS name, you can also use the node name.

- For example:

http://fxnxxxxxxxxxxxx

The NetBIOS name can be found in the Network Configuration Report.

- For Mac, access Web Based Management by clicking the machine's icon on the **Status Monitor** screen.

3. No password is required by default. Type a password if you have set one, and then click .
4. Click the **Network** tab.
5. Click the **Security** tab.
6. Click **Certificate**.
7. Click **Export** shown with **Certificate List**.
8. If you want to encrypt the file, type a password in the **Enter password** field.  
If the **Enter password** field is blank, your output file will not be encrypted.
9. Type the password again in the **Retype password** field, and then click **Submit**.
10. Click **Save**.
11. Specify the location where you want to save the file.

The self-signed certificate is exported to your computer.

You can also import the self-signed certificate to your computer.



### Related Information

- [Import and Export the Self-signed Certificate on your Fuji Xerox Machine](#)

## **Create and Install a Certificate from a Certificate Authority (CA)**

If you already have a certificate from an external trusted CA, you can store the certificate and private key on the machine and manage them by importing and exporting. If you do not have a certificate from an external trusted CA, create a Certificate Signing Request (CSR), send it to a CA for authentication, and install the returned certificate on your machine.

- [Create a Certificate Signing Request \(CSR\)](#)
- [Install a Certificate on Your Fuji Xerox Machine](#)
- [Import and Export the Certificate and Private Key](#)

## Create a Certificate Signing Request (CSR)

A Certificate Signing Request (CSR) is a request sent to a Certificate Authority (CA) to authenticate the credentials contained within the certificate.

We recommend installing a Root Certificate from the CA on your computer before creating the CSR.

1. Start your web browser.
2. Type "http://machine's IP address" in your browser's address bar (where "machine's IP address" is the machine's IP address).

For example:

http://192.168.1.2



- If you are using a Domain Name System or enable a NetBIOS name, you can type another name, such as "SharedPrinter" instead of the IP address.

- For example:

http://SharedPrinter

If you enable a NetBIOS name, you can also use the node name.

- For example:

http://fxnxxxxxxxxxxxx

The NetBIOS name can be found in the Network Configuration Report.

- For Mac, access Web Based Management by clicking the machine's icon on the **Status Monitor** screen.

3. No password is required by default. Type a password if you have set one, and then click .
4. Click the **Network** tab.
5. Click the **Security** tab.
6. Click **Certificate**.
7. Click **Create CSR**.
8. Type a **Common Name** (required) and add other information about your **Organization** (optional).



- Your company details are required so that a CA can confirm your identity and verify it to the outside world.
- The length of the **Common Name** must be less than 64 bytes. Enter an identifier, such as an IP address, node name, or domain name to use when accessing this printer through SSL/TLS communication. The node name is displayed by default. The **Common Name** is required.
- A warning will appear if you type a different name in the URL than the Common Name that was used for the certificate.
- The length of the **Organization**, the **Organization Unit**, the **City/Locality** and the **State/Province** must be less than 64 bytes.
- The **Country/Region** should be a two character ISO 3166 country code.
- If you are configuring an X.509v3 certificate extension, select the **Configure extended partition** check box, and then select **Auto (Register IPv4)** or **Manual**.

9. Select your setting from the **Public Key Algorithm** drop-down list. The default setting is **RSA(2048bit)**.
10. Select your setting from the **Digest Algorithm** drop-down list. The default setting is **SHA256**.
11. Click **Submit**.

The CSR appears on your screen. Save the CSR as a file or copy and paste it into an online CSR form offered by a Certificate Authority.

---

12. Click **Save**.



- Follow your CA's policy regarding the method to send a CSR to your CA.
  - If you are using the Enterprise root CA of Windows Server® 2008/2012/2012 R2/2016, we recommend using the Web Server for the certificate template to securely create the Client Certificate.
- 



### **Related Information**

- [Create and Install a Certificate from a Certificate Authority \(CA\)](#)
-

## Install a Certificate on Your Fuji Xerox Machine

When you receive a certificate from a CA, follow the steps below to install it into the print server:

Only a certificate issued with your machine's CSR can be installed onto the machine. When you want to create another CSR, make sure that the certificate is installed before creating another CSR. Create another CSR only after installing the certificate on the machine. If you do not, the CSR you create before installing will be invalid.

1. Start your web browser.
2. Type "http://machine's IP address" in your browser's address bar (where "machine's IP address" is the machine's IP address).

For example:

http://192.168.1.2



- If you are using a Domain Name System or enable a NetBIOS name, you can type another name, such as "SharedPrinter" instead of the IP address.

- For example:

http://SharedPrinter

If you enable a NetBIOS name, you can also use the node name.

- For example:

http://fxnxxxxxxxxxxxx

The NetBIOS name can be found in the Network Configuration Report.

- For Mac, access Web Based Management by clicking the machine's icon on the **Status Monitor** screen.

3. No password is required by default. Type a password if you have set one, and then click .
4. Click the **Network** tab.
5. Click the **Security** tab.
6. Click **Certificate**.
7. Click **Install Certificate**.
8. Browse to the file that contains the certificate issued by the CA, and then click **Submit**.

The certificate has been created successfully and saved in your machine's memory successfully.

To use SSL/TLS communication, the Root Certificate from the CA must be installed on your computer. Contact your network administrator.



### Related Information

- [Create and Install a Certificate from a Certificate Authority \(CA\)](#)

## Import and Export the Certificate and Private Key

Store the certificate and private key on your machine and manage them by importing and exporting them.

- [Import a Certificate and Private Key](#)
- [Export the Certificate and Private Key](#)

## Import a Certificate and Private Key

1. Start your web browser.
2. Type "http://machine's IP address" in your browser's address bar (where "machine's IP address" is the machine's IP address).

For example:

http://192.168.1.2



- If you are using a Domain Name System or enable a NetBIOS name, you can type another name, such as "SharedPrinter" instead of the IP address.

- For example:

http://SharedPrinter

If you enable a NetBIOS name, you can also use the node name.

- For example:

http://fxnxxxxxxxxxxxx

The NetBIOS name can be found in the Network Configuration Report.

- For Mac, access Web Based Management by clicking the machine's icon on the **Status Monitor** screen.

3. No password is required by default. Type a password if you have set one, and then click .
4. Click the **Network** tab.
5. Click the **Security** tab.
6. Click **Certificate**.
7. Click **Import Certificate and Private Key**.
8. Browse to the file you want to import.
9. Type the password if the file is encrypted, and then click **Submit**.

The certificate and private key are imported to your machine.

To use SSL/TLS communication, the Root Certificate from the CA must also be installed on your computer. Contact your network administrator.



### Related Information

- [Import and Export the Certificate and Private Key](#)

## Export the Certificate and Private Key

1. Start your web browser.
2. Type "http://machine's IP address" in your browser's address bar (where "machine's IP address" is the machine's IP address).

For example:

http://192.168.1.2



- If you are using a Domain Name System or enable a NetBIOS name, you can type another name, such as "SharedPrinter" instead of the IP address.

- For example:

http://SharedPrinter

If you enable a NetBIOS name, you can also use the node name.

- For example:

http://fxnxxxxxxxxxxxx

The NetBIOS name can be found in the Network Configuration Report.

- For Mac, access Web Based Management by clicking the machine's icon on the **Status Monitor** screen.

3. No password is required by default. Type a password if you have set one, and then click .
4. Click the **Network** tab.
5. Click the **Security** tab.
6. Click **Certificate**.
7. Click **Export** shown with **Certificate List**.
8. Enter the password if you want to encrypt the file.  
If a blank password is used, the output is not encrypted.
9. Enter the password again for confirmation, and then click **Submit**.
10. Click **Save**.
11. Specify the location where you want to save the file.

The certificate and private key are exported to your computer.

You can also import the certificate to your computer.



### Related Information

- [Import and Export the Certificate and Private Key](#)



## Import and Export a CA Certificate

You can import, export and store CA certificates on your Fuji Xerox machine.

- [Import a CA Certificate](#)
- [Export a CA Certificate](#)

## Import a CA Certificate

1. Start your web browser.
2. Type "http://machine's IP address" in your browser's address bar (where "machine's IP address" is the machine's IP address).

For example:

http://192.168.1.2



- If you are using a Domain Name System or enable a NetBIOS name, you can type another name, such as "SharedPrinter" instead of the IP address.

- For example:

http://SharedPrinter

If you enable a NetBIOS name, you can also use the node name.

- For example:

http://fxnxxxxxxxxxxxx

The NetBIOS name can be found in the Network Configuration Report.

- For Mac, access Web Based Management by clicking the machine's icon on the **Status Monitor** screen.

3. No password is required by default. Type a password if you have set one, and then click .
4. Click the **Network** tab.
5. Click the **Security** tab.
6. Click **CA Certificate**.
7. Click **Import CA Certificate**.
8. Browse to the file you want to import.
9. Click **Submit**.



### Related Information

- [Import and Export a CA Certificate](#)

## Export a CA Certificate

1. Start your web browser.
2. Type "http://machine's IP address" in your browser's address bar (where "machine's IP address" is the machine's IP address).

For example:

http://192.168.1.2



- If you are using a Domain Name System or enable a NetBIOS name, you can type another name, such as "SharedPrinter" instead of the IP address.

- For example:

http://SharedPrinter

If you enable a NetBIOS name, you can also use the node name.

- For example:

http://fxnxxxxxxxxxxxx

The NetBIOS name can be found in the Network Configuration Report.

- For Mac, access Web Based Management by clicking the machine's icon on the **Status Monitor** screen.

3. No password is required by default. Type a password if you have set one, and then click .
4. Click the **Network** tab.
5. Click the **Security** tab.
6. Click **CA Certificate**.
7. Select the certificate you want to export and click **Export**.
8. Click **Submit**.
9. Click **Save**.
10. Specify where on your computer you want to save the exported certificate, and save it.



### Related Information

- [Import and Export a CA Certificate](#)

## Manage Multiple Certificates

The multiple certificate feature allows you to use Web Based Management to manage each certificate installed on your machine. In Web Based Management, navigate to the **Certificate** or **CA Certificate** screen to view certificate content, delete, or export your certificates.

|   | Maximum Number of Certificates Stored UP on Fuji Xerox Machine |
|---|--|
| Self-signed Certificate or Certificate Issued by a CA | 5  |
| CA Certificate  | 5  |

You can store up to 5 Certificate Authority (CA) certificates using SMTP over SSL (only available for certain models).

We recommend storing one less certificate than allowed, reserving an empty spot in case of certificate expiration. When a certificate expires, import a new certificate into the reserved spot, and then delete the expired certificate. This ensures that you avoid configuration failure.



- When you use SSL for SMTP communications, you do not have to choose the certificate. The necessary certificate will be chosen automatically.



### Related Information

- [Certificates and Web Based Management](#)

## Manage Your Network Machine Securely Using Web Based Management

To manage your network machine securely, you must use management utilities with security protocols.

We recommend using the HTTPS protocol for secure management. To use this protocol, HTTPS must be enabled on your machine.



- The HTTPS protocol is enabled by default.
- You can change the HTTPS protocol settings using the Web Based Management screen.

1. Start your web browser.
2. Type "https://Common Name" in your browser's address bar (where "Common Name" is the Common Name that you assigned to the certificate; this could be your IP address, node name, or domain name).
3. No password is required by default. Type a password if you have set one, and then click .
4. You can now access the machine using HTTPS.



- If you use the SNMPv3 protocol, follow the steps below.

5. Click the **Network** tab.
6. Click **Protocol**.
7. Make sure the **SNMP** setting is enabled, and then click **Advanced Settings**.
8. Configure the SNMP settings.

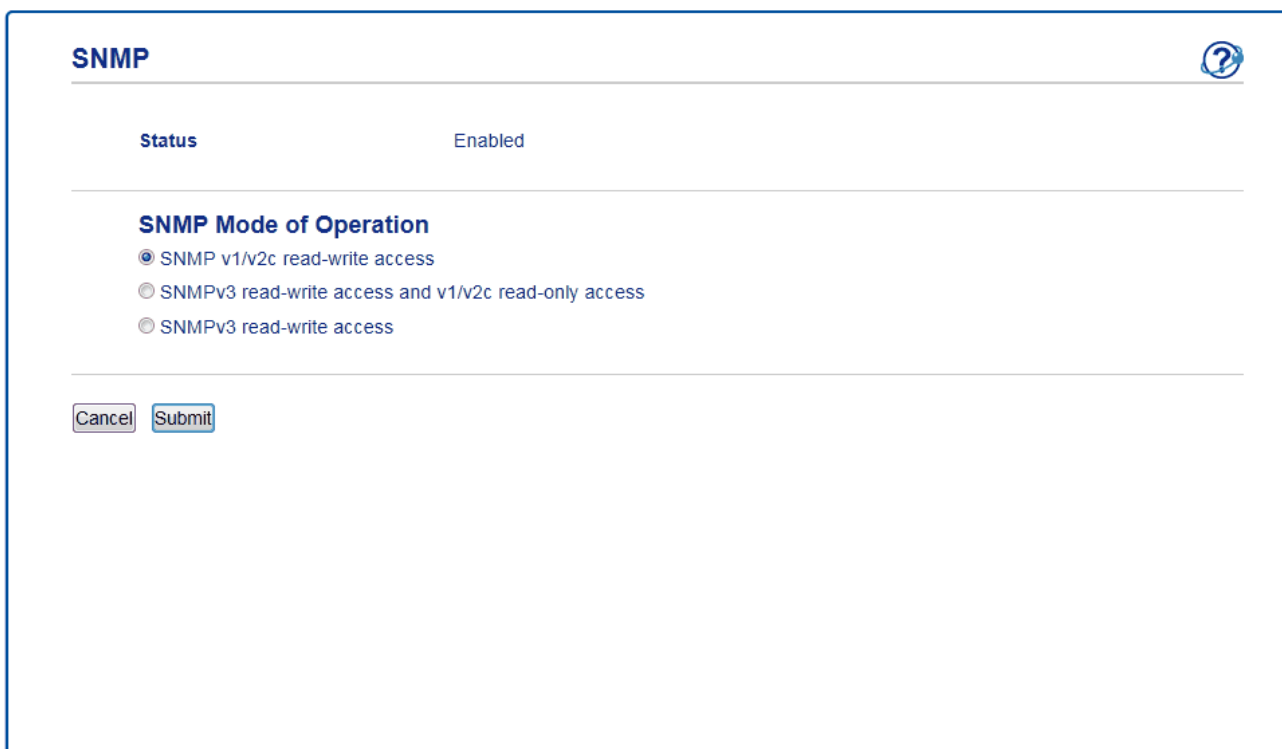

**SNMP** 

Status Enabled

**SNMP Mode of Operation**

SNMP v1/v2c read-write access

SNMPv3 read-write access and v1/v2c read-only access

SNMPv3 read-write access

There are three options for **SNMP Mode of Operation**.

- **SNMP v1/v2c read-write access**  
In this mode, the print server uses version 1 and version 2c of the SNMP protocol. You can use all Fuji Xerox applications in this mode. However, it is not secure since it will not authenticate the user, and data will not be encrypted.
- **SNMPv3 read-write access and v1/v2c read-only access**

---

In this mode, the print server uses the read-write access of version 3 and the read-only access of version 1 and version 2c of the SNMP protocol.



When you use **SNMPv3 read-write access and v1/v2c read-only access** mode, some Fuji Xerox applications (such as BRAdmin Light) that access the print server do not work correctly since they authorise the read-only access of version 1 and version 2c. If you want to use all applications, we recommend using **SNMP v1/v2c read-write access** mode.

- **SNMPv3 read-write access**

In this mode, the print server uses version 3 of the SNMP protocol. If you want to manage the print server securely, use this mode.



When you use **SNMPv3 read-write access** mode, note the following:

- You can use only Web Based Management to manage the print server.
- All applications that use SNMPv1/v2c will be restricted. To allow the use of SNMPv1/v2c applications, use **SNMPv3 read-write access and v1/v2c read-only access** or **SNMP v1/v2c read-write access** mode.

9. Click **Submit**.



### Related Information

- [Manage Your Network Machine Securely Using SSL/TLS](#)

## Print Documents Securely Using SSL/TLS

To print documents securely with IPP protocol, use the IPPS protocol.

1. Start your web browser.
2. Type "http://machine's IP address" in your browser's address bar (where "machine's IP address" is the machine's IP address).

For example:

http://192.168.1.2



- If you are using a Domain Name System or enable a NetBIOS name, you can type another name, such as "SharedPrinter" instead of the IP address.

- For example:

http://SharedPrinter

If you enable a NetBIOS name, you can also use the node name.

- For example:

http://fxnxxxxxxxxxxxx

The NetBIOS name can be found in the Network Configuration Report.

- For Mac, access Web Based Management by clicking the machine's icon on the **Status Monitor** screen.

3. No password is required by default. Type a password if you have set one, and then click .
4. Click the **Network** tab.
5. Click **Protocol**. Make sure the **IPP** check box is selected.



- If the **IPP** check box is not selected, select the **IPP** check box, and then click **Submit**.

Restart your machine to activate the configuration.

After the machine restarts, return to the machine's web page, click the **Network** tab, and then click **Protocol**.

6. Click **HTTP Server Settings**.
7. Select the **HTTPS(Port 443)** check box in the **IPP**, and then click **Submit**.
8. Restart your machine to activate the configuration.

Communication using IPPS cannot prevent unauthorised access to the print server.



### Related Information

- [Manage Your Network Machine Securely Using SSL/TLS](#)

## Send an Email Securely

- [Configure Email Sending Using Web Based Management](#)
- [Send an Email with User Authentication](#)
- [Send an Email Securely Using SSL/TLS](#)



## Configure Email Sending Using Web Based Management

We recommend using Web Based Management to configure secured email sending with user authentication, or email sending using SSL/TLS.

1. Start your web browser.
2. Type "http://machine's IP address" in your browser's address bar (where "machine's IP address" is the machine's IP address).  
For example:  
http://192.168.1.2
3. No password is required by default. Type a password if you have set one, and then click .
4. Click the **Network** tab.
5. Click the **Protocol** menu in the left navigation bar.
6. In the **SMTP** field, click **Advanced Settings** and make sure the status of **SMTP** is **Enabled**.
7. Configure the **SMTP** settings.
  - Confirm that the email settings are correct after configuration by sending a test email.
  - If you do not know the SMTP server settings, contact your network administrator or Internet Service Provider (ISP).
8. When finished, click **Submit**.  
The **Test Send E-mail Configuration** dialog box appears.
9. Follow the instructions in the dialog box to test the current settings.

### Related Information

- [Send an Email Securely](#)

## Send an Email with User Authentication

Your Fuji Xerox machine supports the SMTP-AUTH method to send email via an email server that requires user authentication. This method prevents unauthorised users from accessing the email server.

You can use SMTP-AUTH for email notification and email reports (available for certain models).



---

We recommend using Web Based Management to configure the SMTP authentication.

---

### Email Server Settings

You must configure your machine's SMTP authentication method to match the method used by your email server. For details about your email server settings, contact your network administrator or Internet Service Provider (ISP).



---

To enable SMTP server authentication: in the Web Based Management **SMTP** screen, under **Server Authentication Method**, you must select **SMTP-AUTH**.

---



### Related Information

- [Send an Email Securely](#)
-

## Send an Email Securely Using SSL/TLS

Your Fuji Xerox machine supports SSL/TLS methods to send an email via an email server that requires secure SSL/TLS communication. To send email via an email server that is using SSL/TLS communication, you must configure SMTP over SSL/TLS.



We recommend using Web Based Management to configure SSL/TLS.

### Verify Server Certificate

Under **SSL/TLS**, if you choose **SSL** or **TLS**, the **Verify Server Certificate** check box will be selected automatically.

### SMTP

Status Enabled

---

#### Send E-mail Settings(SMTP)

**Server Address**

**Port**

**Server Authentication Method**  None  SMTP-AUTH

**SMTP-AUTH Account Name**

**SMTP-AUTH Account Password**

Enter password

Retype password

**SSL/TLS**  None  SSL  TLS  Verify Server Certificate

**Device E-mail Address**

---

[CA Certificate>>](#)

[E-mail report>>](#)

[Notification>>](#)

---



- Before you verify the server certificate, you must import the CA certificate issued by the CA that signed the server certificate. Contact your network administrator or your Internet Service Provider (ISP) to confirm if importing a CA certificate is necessary.
- If you do not need to verify the server certificate, clear the **Verify Server Certificate** check box.

### Port Number

If you select **SSL**, the **Port** value will be changed to match the protocol. To change the port number manually, type the port number after you choose **SSL/TLS**.

---

You must configure your machine's SMTP communication method to match the method used by your email server. For details about your email server settings, contact your network administrator or your ISP.

In most cases, the secured webmail services require the following settings:

|      |                                     |                  |
|------|-------------------------------------|------------------|
| SMTP | <b>Port</b>                         | 25               |
|      | <b>Server Authentication Method</b> | <b>SMTP-AUTH</b> |
|      | <b>SSL/TLS</b>                      | <b>TLS</b>       |



### Related Information

- [Send an Email Securely](#)

## Mobile

- [Google Cloud Print](#)
- [AirPrint](#)
- [Mobile Printing for Windows®](#)
- [Mopria® Print Service](#)
- [Print Utility](#)
- [Near-Field Communication \(NFC\)](#)

## Google Cloud Print

- [Google Cloud Print Overview](#)
- [Before Using Google Cloud Print](#)
- [Print from Google Chrome™ or Chrome OS™](#)
- [Print from Google Drive™ for Mobile](#)
- [Print from Gmail™ Webmail Service for Mobile](#)

## Google Cloud Print Overview

Google Cloud Print™ is a Google service that allows you to print to a printer registered to your Google account using a network-compatible device (such as a mobile phone or computer) without installing the printer driver on the device.

Printing from Android™ apps requires installing the Google Cloud Print™ app from the Google Play™ Store.

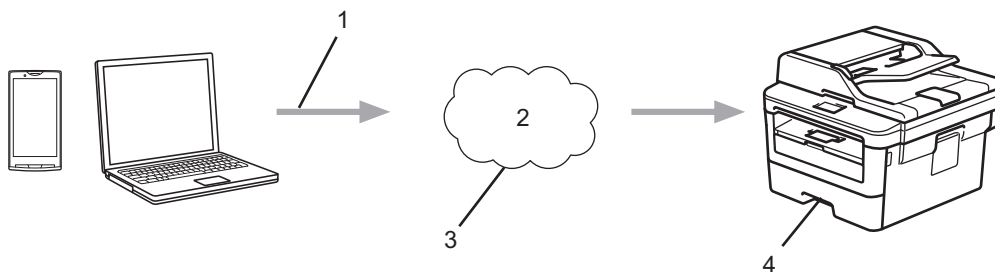

1. Print request
2. Internet
3. Google Cloud Print™
4. Printing



### Related Information

- [Google Cloud Print](#)

## Before Using Google Cloud Print

- [Network Settings for Using Google Cloud Print](#)
- [Register Your Machine with Google Cloud Print Using Google Chrome™](#)
- [Register Your Machine with Google Cloud Print Using Web Based Management](#)



## Network Settings for Using Google Cloud Print

In order to use Google Cloud Print™, your Fuji Xerox machine must be connected to a network that has access to the Internet, either through a wired or wireless connection. To connect and configure your machine correctly, see the *Quick Setup Guide* or related topics in this guide.



### Related Information

- [Before Using Google Cloud Print](#)
  - [Google Cloud Print Problems](#)
-

## Register Your Machine with Google Cloud Print Using Google Chrome™

Make sure you have already created a Google Account. If you do not have an account, use a computer or mobile device to access the Google website (<https://accounts.google.com/signup>) and create an account. Make sure your Fuji Xerox machine is idle before starting the registration process.



The steps in this section are examples for Windows® users.

Screens on your computer may vary depending on your operating system and environment.

1. Open Google Chrome™ on your computer.
2. Sign in to your Google Account.
3. Click the Google Chrome™ menu icon, and then **Settings > Show advanced settings...**
4. In the **Google Cloud Print** section, click **Manage**.
5. Follow the on-screen instructions to register your machine.
6. When a confirmation message appears on your machine, press the [OK] button.



If the confirmation message does not appear on your machine's LCD, repeat these steps.

7. When your Fuji Xerox machine is successfully registered, it will appear in the **My devices** field.



### Related Information

- [Before Using Google Cloud Print](#)

## Register Your Machine with Google Cloud Print Using Web Based Management

Make sure you have already created a Google Account. If you do not have an account, use a computer or mobile device to access the Google website (<https://accounts.google.com/signup>) and create an account. Make sure your Fuji Xerox machine is idle before starting the registration process. Before you begin to register your machine, confirm that the correct date and time are set on the machine.

1. Confirm that your Fuji Xerox machine is connected to the same network as your computer or mobile device.
2. Start your web browser.
3. Type "http://machine's IP address" in your browser's address bar (where "machine's IP address" is the machine's IP address).  
For example:  
http://192.168.1.2
4. No password is required by default. Type a password if you have set one, and then click .
5. Click the **Network** tab.
6. Click the **Protocol** menu in the left navigation bar.
7. Make sure that **Google Cloud Print** is selected, and then click **Advanced Settings**.
8. Make sure that **Status** is set to **Enabled**. Click **Register**.
9. Follow the on-screen instructions to register your machine.
10. When a confirmation message appears on your machine, press the OK button.



If the confirmation message does not appear on your machine's LCD, repeat these steps.

11. Click **Google**.
12. The sign-in screen for Google Cloud Print™ appears. Sign in with your Google Account and follow the on-screen instructions to register your machine.
13. When you have finished registering your machine, return to the Web Based Management screen and make sure that **Registration Status** is set to **Registered**.



If your machine supports the Secure Function Lock feature, printing via Google Cloud Print™ is possible even if PC print for each user is restricted. To restrict printing via Google Cloud Print™, disable Google Cloud Print™ using Web Based Management or set the Secure Function Lock feature to Public Mode, and then restrict print for public users. See *Related Information*.



### Related Information

- [Before Using Google Cloud Print](#)
- [Configure Public Mode for Secure Function Lock 3.0](#)

## Print from Google Chrome™ or Chrome OS™

1. Make sure your Fuji Xerox machine is turned on.
2. Open the web page that you want to print.
3. Click the Google Chrome™ menu icon.
4. Click **Print**.
5. Select your machine from the printer list.
6. Change print options, if needed.
7. Click **Print**.



### Related Information

- [Google Cloud Print](#)

## Print from Google Drive™ for Mobile

1. Make sure your Fuji Xerox machine is turned on.
2. Access Google Drive™ from your Android™ or iOS device's web browser.
3. Open the document that you want to print.
4. Tap the menu icon.
5. Tap **Print**.
6. Select your machine from the printer list.
7. Change print options, if needed.
8. Tap  or **Print**.



### Related Information

- [Google Cloud Print](#)

## Print from Gmail™ Webmail Service for Mobile

1. Make sure your Fuji Xerox machine is turned on.
2. Access the Gmail™ webmail service from your Android™ or iOS device's web browser.
3. Open the email that you want to print.
4. Tap the menu icon.



If **Print** appears beside the attachment name, you can also print the attachment. Tap **Print**, and then follow the instructions on your mobile device.

5. Tap **Print**.
6. Select your machine from the printer list.
7. Change print options, if needed.
8. Tap  or **Print**.



### Related Information

- [Google Cloud Print](#)

## AirPrint

- [AirPrint Overview](#)
- [Before Using AirPrint](#)
- [Print Using AirPrint](#)
- [Scan Using AirPrint](#)
- [Send a Fax Using AirPrint \(For Fax supported Models\)](#)

## AirPrint Overview

AirPrint is a printing solution for Apple operating systems that allows you to wirelessly print photos, email, web pages and documents from your iPad, iPhone, iPod touch and Mac computer without the need to install a driver.

AirPrint also lets you send faxes directly from your Mac computer without printing them and lets you scan documents to your Mac computer. (DocuPrint M235 z/ DocuPrint M275 z/DocuPrint M285 z)

For more information, visit Apple's website.

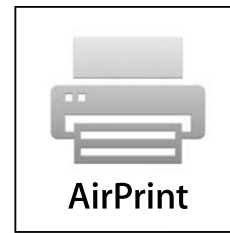

### Related Information

- [AirPrint](#)
- [AirPrint Problems](#)



## Before Using AirPrint

- [Network Settings for Using AirPrint](#)
- [Disable and Enable AirPrint Using Web Based Management \(Web Browser\)](#)

## Network Settings for Using AirPrint

In order to use AirPrint, your mobile device must connect to the wireless network to which your Fuji Xerox machine is connected. AirPrint supports wireless connections that use infrastructure mode or Wi-Fi Direct®.

To configure your mobile device for a wireless network, refer to your mobile device's user's guide. A link to your mobile device's user's guide on Apple's website can be found by tapping  in Safari.

To configure your Fuji Xerox machine for a wireless network, see the *Quick Setup Guide* or related topics in this guide. If your Fuji Xerox machine supports a wired network, you can use a network cable to connect to the wireless access point/router.

If your Fuji Xerox machine supports Wi-Fi Direct and you want to configure your Fuji Xerox machine for a Wi-Fi Direct network, see related topics in this Online Guide.



### Related Information

- [Before Using AirPrint](#)

## Disable and Enable AirPrint Using Web Based Management (Web Browser)

Confirm that your Fuji Xerox machine is connected to the same network as your computer.

1. Start your web browser.
2. Type "http://machine's IP address" in your browser's address bar (where "machine's IP address" is the machine's IP address).

For example:

http://192.168.1.2

3. No password is required by default. Type a password if you have set one, and then click .
4. Click the **Network** tab.
5. Click the **Protocol** menu in the left navigation bar.
6. To disable AirPrint, clear the **AirPrint** check box. To enable AirPrint, select the **AirPrint** check box.



By default, AirPrint is enabled.

7. Click **Submit**.
8. Restart your machine to activate the configuration.



### Related Information



- [Before Using AirPrint](#)

## Print Using AirPrint

- [Print from iPad, iPhone, or iPod Touch](#)
- [Before Using AirPrint \(macOS\)](#)
- [Print Using AirPrint \(macOS\)](#)

## Print from iPad, iPhone, or iPod Touch

The procedure used to print may vary by application. Safari is used in the example below.

1. Make sure your Fuji Xerox machine is turned on.
2. Use Safari to open the page that you want to print.
3. Tap  or .
4. Tap **Print**.
5. Make sure your Fuji Xerox machine is selected.
6. If a different machine (or no printer) is selected, tap **Printer**.  
A list of available machines appears.
7. Tap your machine's name in the list.
8. Select the desired options, such as the number of pages to print and 2-sided printing (if supported by your machine).
9. Tap **Print**.



### Related Information

- [Print Using AirPrint](#)

## Before Using AirPrint (macOS)

Before printing using macOS, add your Fuji Xerox machine to the printer list on your Mac computer.

1. Select **System Preferences** from the Apple Menu.
2. Click **Printers & Scanners**.
3. Click the + icon below the Printers pane on the left.
4. Click **Add Printer or Scanner....** The **Add** screen appears.
5. Select your Fuji Xerox machine, and then select **AirPrint** from the **Use** pop-up menu.
6. Click **Add**.



### Related Information

- [Print Using AirPrint](#)
-

## Print Using AirPrint (macOS)

The procedure used to print may vary by application. Safari is used in the example below. Before printing, make sure your Fuji Xerox machine is in the printer list on your Mac computer.

1. Make sure your Fuji Xerox machine is turned on.
2. On your Mac computer, use Safari to open the page that you want to print.
3. Click the **File** menu, and then select **Print**.
4. Make sure your Fuji Xerox machine is selected. If a different machine (or no printer) is selected, click the **Printer** pop-up menu, and then select your Fuji Xerox machine.
5. Select the desired options, such as the number of pages to print and 2-sided printing (if supported by your machine).
6. Click **Print**.



### Related Information

- [Print Using AirPrint](#)

## Scan Using AirPrint

- [Before Scanning Using AirPrint \(macOS\)](#)
- [Scan Using AirPrint \(macOS\)](#)
- [Scan from Your Computer \(Mac\)](#)



## Before Scanning Using AirPrint (macOS)

Before scanning using macOS, add your Fuji Xerox machine to the scanner list on your Mac computer.

1. Select **System Preferences** from the Apple Menu.
2. Click **Printers & Scanners**.
3. Click the + icon below the Scanners pane on the left.
4. Click **Add Printer or Scanner....**  
The **Add** screen appears.
5. Select your Fuji Xerox machine, and then select **AirPrint** from the **Use** pop-up menu.
6. Click **Add**.



### Related Information

- [Scan Using AirPrint](#)

## Scan Using AirPrint (macOS)

Before scanning, make sure your Fuji Xerox machine is in the scanner list on your Mac computer.

1. Load your document.
2. Select **System Preferences** from the Apple Menu.
3. Click **Printers & Scanners**.
4. Select your Fuji Xerox machine from the scanner list.
5. Click the **Scan** tab, and then click the **Open Scanner...** button.  
The Scanner screen appears.
6. If you place the document in the ADF, select **Use Document Feeder** check box, and then select the size of your document from the scan size setting pop-up menu.
7. Select the destination folder or destination application from the destination setting pop-up menu.
8. Click **Show Details** to change the scanning settings if needed.  
You can crop the image manually by dragging the mouse pointer over the portion you want to scan when scanning from the scanner glass.
9. Click **Scan**.



### Related Information

- [Scan Using AirPrint](#)

## Send a Fax Using AirPrint (For Fax supported Models)

- [Before Sending a Fax Using AirPrint \(macOS\)](#)
- [Send a Fax Using AirPrint \(macOS\)](#)

## Before Sending a Fax Using AirPrint (macOS)

**Related Models:** DocuPrint M235 z/DocuPrint M275 z/DocuPrint M285 z

Before sending a fax, add your Fuji Xerox machine to the printer list on your Mac computer. Make sure your Fuji Xerox machine is connected to the telephone line and works correctly.

1. Select **System Preferences** from the Apple Menu.
2. Click **Printers & Scanners**.
3. Click the + icon below the Printers pane on the left.
4. Click **Add Printer or Scanner...** The **Add** screen appears.
5. Select your Fuji Xerox machine, and then select **AirPrint** from the **Use** pop-up menu.
6. Click **Add**.



### Related Information

- [Send a Fax Using AirPrint \(For Fax supported Models\)](#)

## Send a Fax Using AirPrint (macOS)

**Related Models:** DocuPrint M235 z/DocuPrint M275 z/DocuPrint M285 z

Make sure your Fuji Xerox machine is in the printer list on your Mac computer. Apple TextEdit is used in the example below.



- AirPrint supports only monochrome fax documents.

1. Make sure your Fuji Xerox machine is turned on.
2. On your Mac computer, open the file that you want to send as a fax.
3. Click the **File** menu, and then select **Print**.
4. Click the **Printer** pop-up menu, and then select **FUJI XEROX DocuPrint XXXXX - Fax** (where XXXXX is your model name).
5. Type the fax recipient information.
6. Click **Fax**.



### Related Information

- [Send a Fax Using AirPrint \(For Fax supported Models\)](#)

## Mobile Printing for Windows®

Mobile printing for Windows® is a function to print wirelessly from your Windows® mobile device. You can connect to the same network that your Fuji Xerox machine is connected to and print without installing the printer driver on the device. Many Windows® apps support this function.

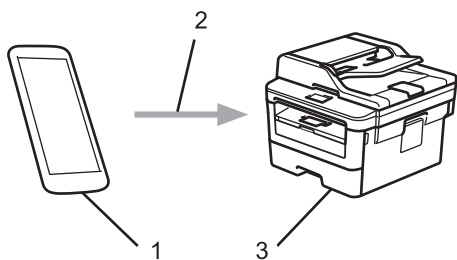

1. Windows® mobile device (Windows® 10 Mobile or later)
2. Wi-Fi® connection
3. Your Fuji Xerox machine



### Related Information

- [Mobile](#)

## Mopria® Print Service

Mopria® Print Service is a print feature on Android™ mobile devices (Android™ version 4.4 or later) developed by the Mopria® Alliance. With this service, you can connect to the same network as your machine and print without additional setup. Many native Android™ apps support printing.

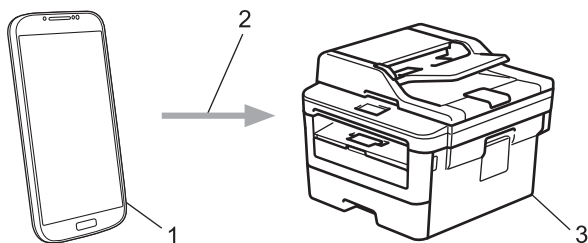

1. Android™ 4.4 or later
2. Wi-Fi® Connection
3. Your Fuji Xerox machine

You must download the Mopria® Print Service from the Google Play™ Store and install it on your Android™ device. Before using this service, you must turn it on.

### ✓ Related Information

- [Mobile](#)

## Print Utility

The Print Utility program allows you to scan to and print from your iOS or Android mobile device. For an Android mobile device with the NFC function, you can tap the device onto the NFC reader of the printer to start printing, scanning, and connecting to the printer.

For details, visit the following web sites:

- For iOS: <http://www.fxap.com.sg/product/software/printutilios/>
- For Android: <http://www.fxap.com.sg/product/software/printutilandroid/>



### Related Information

- [Mobile](#)
  - [iPrint&Scan for Mac](#)
-



## Near-Field Communication (NFC)

**Related Models:** DocuPrint M275 z/DocuPrint M285 z

Near-Field Communication (NFC) allows for simple transactions, data exchange, and wireless connections between two devices that are in close range of each other.

If your Android™ device is NFC-enabled, you can print data (photos, PDF files, text files, web pages and email messages) from the device or scan photos and documents to the device by touching it to the NFC symbol on the machine's control panel.

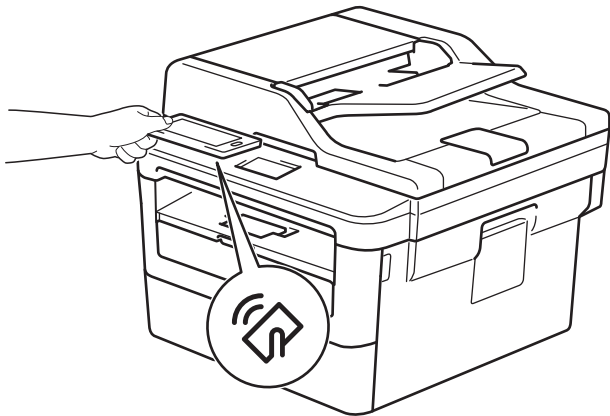

You must download and install Print Utility on your Android™ device to use this feature.

For details, visit the following web sites: <http://www.fxap.com.sg/product/software/printutilandroid/>

### ✓ Related Information

- [Mobile](#)

## ControlCenter

Use Fuji Xerox's ControlCenter software utility to quickly access your frequently-used applications. Using ControlCenter gives you direct access to specific applications.

- [ControlCenter4 \(Windows®\)](#)

## ControlCenter4 (Windows®)

- [Change the Operation Mode in ControlCenter4 \(Windows®\)](#)
- [Scan Using ControlCenter4 Home Mode \(Windows®\)](#)
- [Scan Using ControlCenter4 Advanced Mode \(Windows®\)](#)
- [Set Up the Fuji Xerox Machine Using ControlCenter4 \(Windows®\)](#)
- [Create a Custom Tab Using ControlCenter4 Advanced Mode \(Windows®\)](#)

## Change the Operation Mode in ControlCenter4 (Windows®)

ControlCenter4 has two operation modes: **Home Mode** and **Advanced Mode**. You can change modes at any time.

### Home Mode

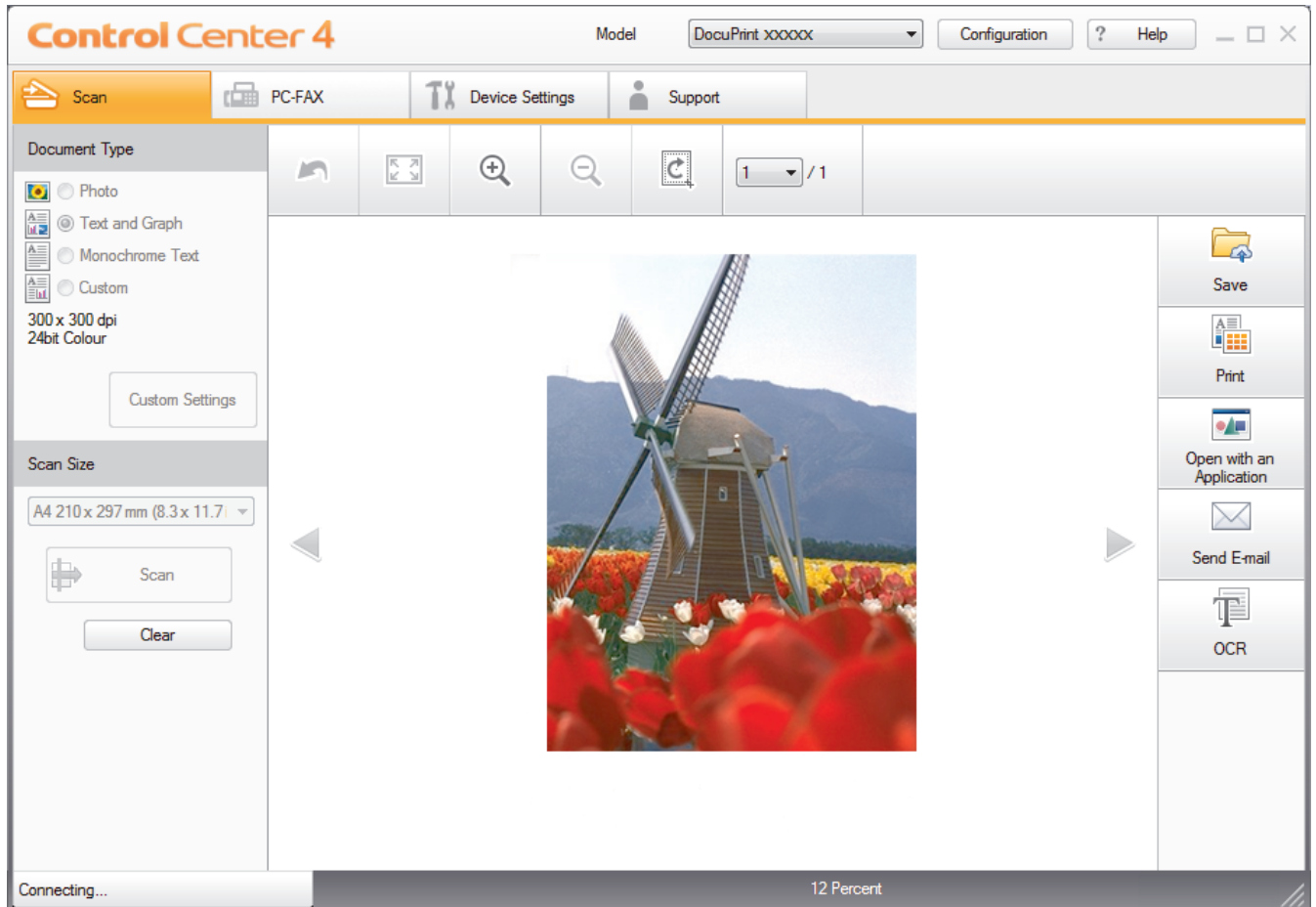

### Advanced Mode

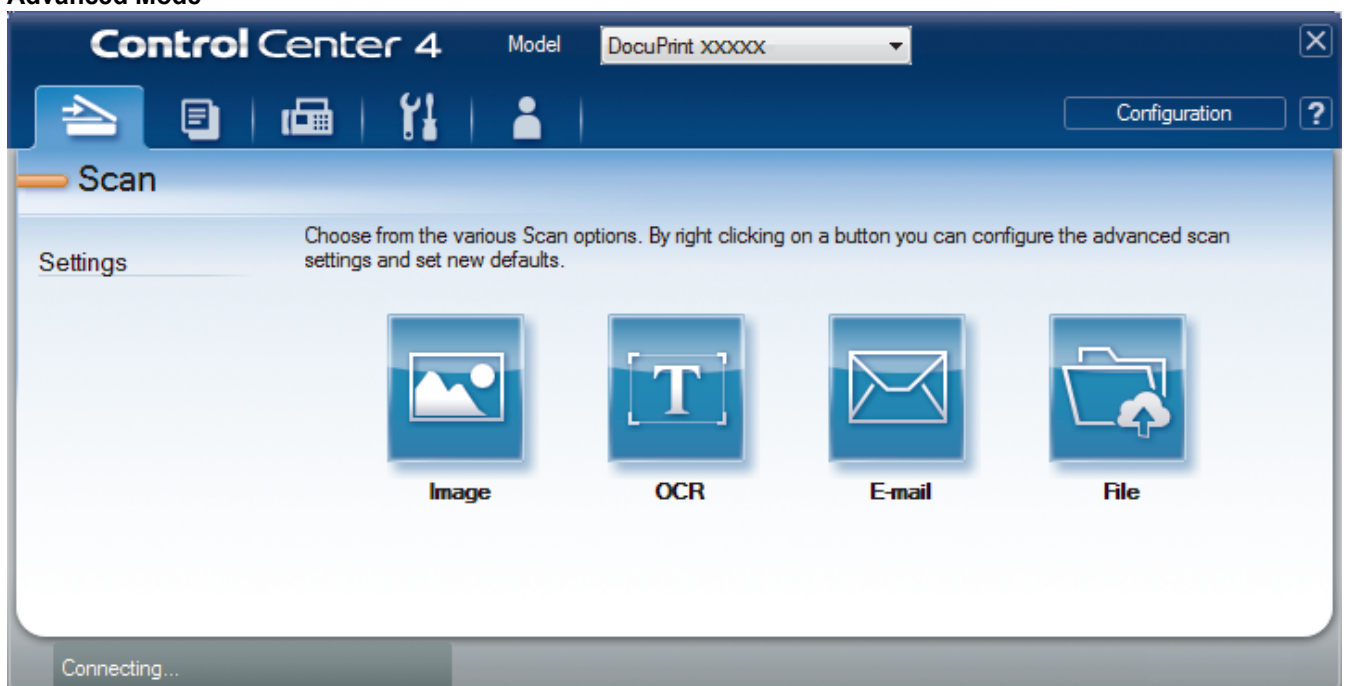

- Home Mode

---

ControlCenter4 Home Mode lets you access your machine's main features easily.

- **Advanced Mode**

ControlCenter4 Advanced Mode gives you more control over the details of your machine's features and allows you to customise one-button scan actions.

To change operation mode:

1. Click the  (**ControlCenter4**) icon in the task tray, and then select **Open**.
2. Click the **Configuration** button, and then select **Mode Select**.
3. The mode selection dialog box appears. Select either the **Home Mode** or **Advanced Mode** option.

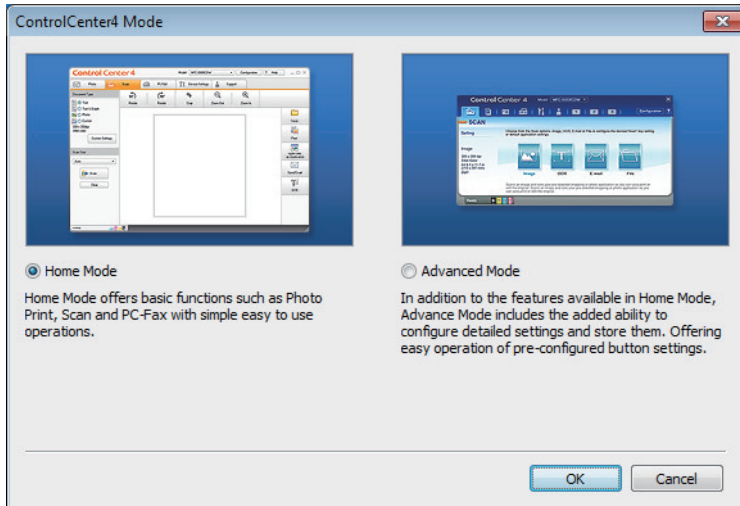

4. Click **OK**.



## Related Information

- [ControlCenter4 \(Windows®\)](#)
-

## Scan Using ControlCenter4 Home Mode (Windows®)

Use ControlCenter4 Home Mode to access your machine's main features.

- [Scan Using ControlCenter4 Home Mode \(Windows®\)](#)
- [Save Scanned Data to a Folder as a PDF File Using ControlCenter4 Home Mode \(Windows®\)](#)
- [Scan Both Sides of a Document Automatically Using ControlCenter4 Home Mode \(Windows®\)](#)
- [Scan Settings for ControlCenter4 Home Mode \(Windows®\)](#)

## Scan Using ControlCenter4 Advanced Mode (Windows®)

ControlCenter4 Advanced Mode gives you more control over the details of your machine's features and allows you to customise one-button scan actions.

- [Scan Photos and Graphics Using ControlCenter4 Advanced Mode \(Windows®\)](#)
- [Save Scanned Data to a Folder as a PDF File Using ControlCenter4 Advanced Mode \(Windows®\)](#)
- [Scan Both Sides of a Document Automatically Using ControlCenter4 Advanced Mode \(Windows®\)](#)
- [Scan Both Sides of an ID Card Using ControlCenter4 Advanced Mode \(Windows®\)](#)
- [Scan to Email Attachment Using ControlCenter4 Advanced Mode \(Windows®\)](#)
- [Scan to an Editable Text File \(OCR\) Using ControlCenter4 Advanced Mode \(Windows®\)](#)
- [Scan Settings for ControlCenter4 Advanced Mode \(Windows®\)](#)

## Set Up the Fuji Xerox Machine Using ControlCenter4 (Windows®)

**Related Models:** DocuPrint M235 z/DocuPrint M275 z/DocuPrint M285 z



If Secure Function Lock is set to On, you cannot use Remote Setup.

1. Click the  (**ControlCenter4**) icon in the task tray, and then click **Open**.
2. Click the **Device Settings** tab.
3. Click the **Remote Setup** button.
4. Configure the settings as needed.

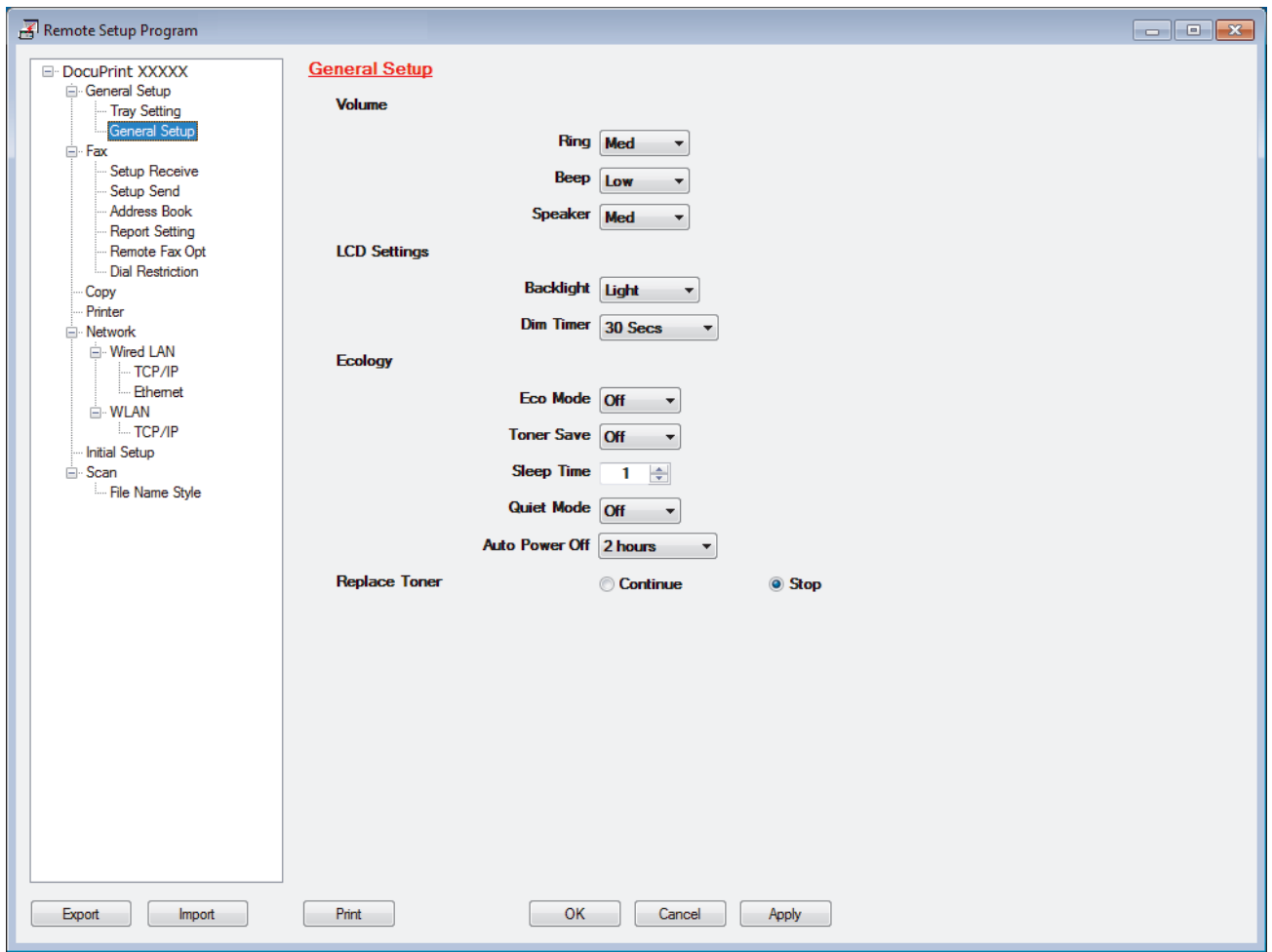

### Export

Click to save the current configuration settings to a file.



Click **Export** to save your address book or all settings for your machine.

### Import

Click to import a file and read its settings.

### Print

Click to print the selected items on the machine. You cannot print the data until it is uploaded to the machine. Click **Apply** to upload the new data to the machine, and then click **Print**.



---

**OK**

Click to start uploading data to the machine, and then exit the Remote Setup Program. If an error message appears, confirm that your data is correct, and then click **OK**.

**Cancel**

Click to exit the Remote Setup Program without uploading data to the machine.

**Apply**

Click to upload data to the machine without exiting the Remote Setup Program.

5. Click **OK**.

- If your computer is protected by a firewall and is unable to use Remote Setup, you may need to configure the firewall settings to allow communication through port numbers 137 and 161.
- If you are using Windows® Firewall and you installed the Fuji Xerox software and drivers from the installation disc, the necessary firewall settings have already been set.

**Related Information**

- [ControlCenter4 \(Windows®\)](#)
- [Remote Setup \(Windows®\)](#)

## Create a Custom Tab Using ControlCenter4 Advanced Mode (Windows®)

You can create up to three customised tabs, each including up to five customised buttons, with your preferred settings.

Select **Advanced Mode** as the mode setting for ControlCenter4.

1. Click the  (**ControlCenter4**) icon in the task tray, and then click **Open**.
2. Click the **Configuration** button, and then select **Create custom tab**.  
A custom tab is created.
3. To change the name of a custom tab, right-click the custom tab, and then select **Rename custom tab**.
4. Click the **Configuration** button, select **Create custom button**, and then select the button you want to create.  
The settings dialog box appears.
5. Type the button name, and then change the settings, if needed. Click **OK**.

The setting options vary depending on the button you select.

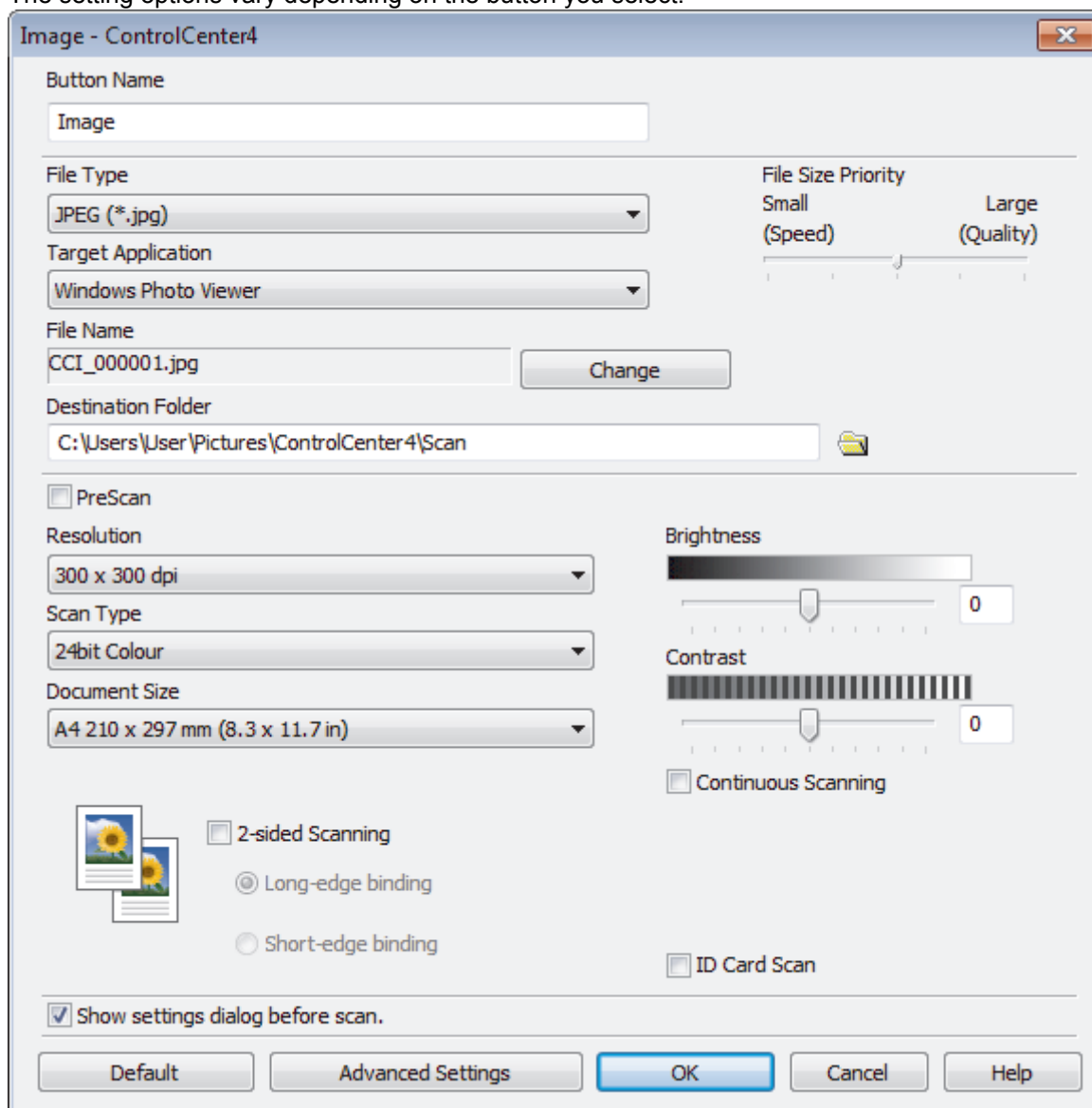



You can change or remove the created tab, button, or settings. Click the **Configuration** button, and then follow the menu.

---



## Related Information

- [ControlCenter4 \(Windows®\)](#)
-

## iPrint&Scan for Mac

- [iPrint&Scan Overview](#)
- [Print Utility](#)
- [Scan Using iPrint&Scan \(Mac\)](#)

## iPrint&Scan Overview

Use iPrint&Scan for Mac to print and scan from your computer.

The following screen shows an example of iPrint&Scan. The actual screen may differ depending on the version of the application.

- For Mac

Install iPrint&Scan from the Fuji Xerox installation disc.

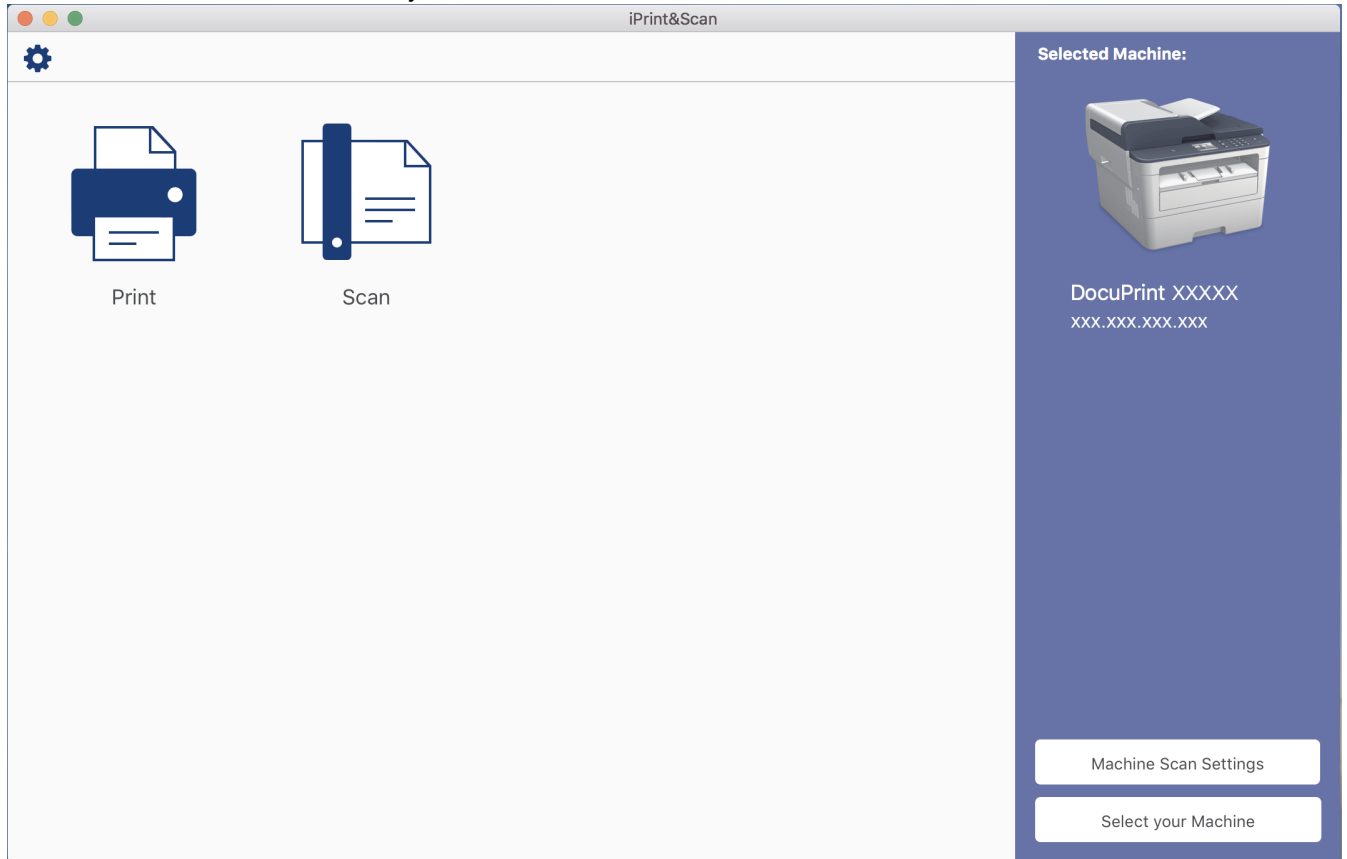

### ✓ Related Information

- [iPrint&Scan for Mac](#)

## Troubleshooting

Use this section to resolve typical problems you may encounter when using your Fuji Xerox machine. You can correct most problems yourself.

### IMPORTANT

For technical help, you must call Fuji Xerox customer service or your local Fuji Xerox dealer.

Using non-Fuji Xerox supplies may affect the print quality, hardware performance, and machine reliability.

(DocuPrint M235 z)

To prevent you from losing the received fax data in the machine's memory, transfer the data to another Fax machine or to your computer before turning off the machine.

First, check the following:

- The machine's power cord is connected correctly and the machine's power is on. See the *Quick Setup Guide*.
- All of the protective materials have been removed. See the *Quick Setup Guide*.
- Paper is loaded correctly in the paper tray.
- The interface cables are securely connected to the machine and the computer, or the wireless connection is set up on both the machine and your computer.
- Error and maintenance messages

If you did not solve the problem with the checks, identify the problem and then see *Related Information*.

### ✓ Related Information

- [Error and Maintenance Messages](#)
- [Document Jams](#)
- [Paper Jams](#)
- [Printing Problems](#)
- [Improve the Print Quality](#)
- [Telephone and Fax Problems](#)
- [Network Problems](#)
- [Google Cloud Print Problems](#)
- [AirPrint Problems](#)
- [Other Problems](#)
- [Transfer Your Faxes or Fax Journal Report](#)
- [Machine Information](#)

## Error and Maintenance Messages

As with any sophisticated office product, errors may occur and supply items may have to be replaced. If this happens, your machine identifies the error or required routine maintenance and shows the appropriate message. The most common error and maintenance messages are shown in the table.



You can correct most errors and perform routine maintenance by yourself.

### DocuPrint M235 dw/DocuPrint M235 z

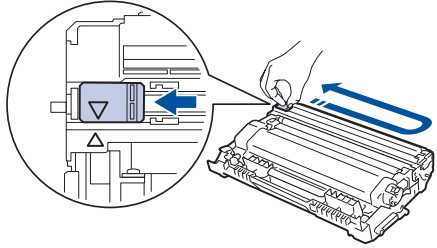
| Error Message   | Cause   | Action   |
|---|---|--|
| 2-sided Disabled  | The back cover of the machine is not closed completely.   | Close the back cover of the machine until it locks in the closed position.   |
|   | The 2-sided tray is not installed completely.   | Install the 2-sided tray firmly in the machine.  |
| Cartridge Error Put the Black (BK) Toner Cartridge back in.<br>Put the Toner Cartridge back in. | The toner cartridge is not installed correctly.   | Pull out the drum unit and toner cartridge assembly, take out the toner cartridge, and put it back in the drum unit again. Put the drum unit and toner cartridge assembly back in the machine.<br><br>If the problem continues, contact Fuji Xerox customer service or your local Fuji Xerox dealer. |
| Comm.Error  | Poor telephone line quality caused a communication error.   | Send the fax again or connect the machine to another telephone line. If the problem continues, contact the telephone company and ask them to check your telephone line.  |
| Cover is Open   | The front cover is not completely closed.   | Open and then firmly close the front cover of the machine.   |
|   | The fusing unit cover is not completely closed or paper was jammed in the back of the machine when you turned on the power. | Close the fusing unit cover located inside the back cover of the machine.  |
|   | The ADF cover is not completely closed.   | Close the ADF cover.<br>If the error message remains, press <b>Stop/Exit</b> .   |
| Disconnected  | The other person or other person's fax machine stopped the call.  | Try to send or receive again.<br><br>If calls are stopped repeatedly and you are using a VoIP (Voice over IP) system, try changing the Compatibility to Basic (for VoIP).  |
| Document Jam  | The document was not inserted or fed correctly, or the document scanned from the ADF was too long.                          | Remove the jammed paper from the ADF unit.<br><br>Clear any debris or scraps of paper from the ADF unit paper path.<br><br>Press <b>Stop/Exit</b> .  |
| DR Mode in Use<br>(Except New Zealand)  | The machine is set to Distinctive Ring mode. You cannot change the Receive Mode from Manual to another mode.                | Set Distinctive Ring to <b>Off</b> .   |
| Drum !  | The corona wire on the drum unit must be cleaned.   | Clean the corona wire on the drum unit.  |

| Error Message                      | Cause   | Action  |
|------------------------------------|---|---|
|                                    |   |    |
|                                    | The drum unit or the toner cartridge and drum unit assembly is not installed correctly.   | Put the toner cartridge in the drum unit. Then reinstall the toner cartridge and drum unit assembly in the machine.   |
| Drum End Soon                      | The drum unit is near the end of its life.  | Order a new drum unit before you get the <b>Replace Drum</b> message.   |
| Faxability On<br>(For New Zealand) | The machine is set to Faxability mode. You can not change the Receive Mode from Manual to another mode.                                       | Set FaxAbility to <b>Off</b> .  |
| Jam 2-sided                        | The paper is jammed in the 2-sided paper tray.  | Pull the paper tray and the 2-sided tray out completely, open the back cover and then remove all jammed paper. Close the back cover, and put the paper tray and the 2-sided tray firmly back in the machine.  |
| Jam Inside                         | The paper is jammed inside the machine.   | Open the front cover and remove the toner cartridge and drum unit assembly. Pull out all jammed paper. Close the front cover. If the error message remains, press <b>Start</b> .  |
| Jam Rear                           | The paper is jammed in the back of the machine.   | Open the fusing unit cover and remove all jammed paper. Close the fusing unit cover. If the error message remains, press <b>Start</b> .   |
| Jam Tray                           | The paper is jammed in the indicated paper tray.  | Pull the paper tray out completely and remove all jammed paper. Put the paper tray firmly back in the machine.  |
| Manual Feed                        | <b>Manual</b> was selected as the paper source in the printer driver, but there is no paper in the manual feed slot.                          | Place paper in the manual feed slot.  |
| No Caller ID                       | There is no incoming call history. You did not receive calls or you have not subscribed to the Caller ID service from your telephone company. | If you want to use the Caller ID feature, call your telephone company.  |
| No Paper                           | The machine is out of paper, or paper is not loaded correctly in the paper tray.  | <ul style="list-style-type: none"> <li>• Refill paper in the paper tray. Make sure the paper guides are set to the correct size.</li> <li>• If paper is in the tray, remove it and load it again. Make sure the paper guides are set to the correct size.</li> <li>• Do not overfill the paper tray.</li> </ul> |
| No Response/Busy                   | The number you dialed does not answer or is busy.   | Verify the number and try again.  |
| No Toner                           | The toner cartridge or the toner cartridge and drum unit assembly is not installed correctly.   | Remove the toner cartridge and drum unit assembly. Remove the toner cartridge from the drum unit, and reinstall the toner cartridge back in   |





| Error Message   | Cause  | Action  |
|-----------------|--|---|
|                 |  | the drum unit. Reinstall the toner cartridge and drum unit assembly back in the machine. If the problem continues, replace the toner cartridge with a new one.  |
| Out of Memory   | The machine's memory is full.  | <p><b>If a fax-sending or copy operation is in process</b></p> <p>Do one of the following:</p> <ul style="list-style-type: none"> <li>• Press <b>Start</b> to send or copy the scanned pages.</li> <li>• Press <b>Stop/Exit</b> and wait until the other operations in progress finish, and then try again.</li> <li>• Print the faxes that are in the memory.</li> <li>• Clear the data in the memory. To gain extra memory, you can turn off Memory Receive.</li> </ul> <p><b>If a print operation is in process</b></p> <p>Do one of the following:</p> <ul style="list-style-type: none"> <li>• Reduce the Resolution.</li> <li>• Clear faxes from the memory.</li> </ul> |
| Print Unable XX | The machine has a mechanical problem.  | <ul style="list-style-type: none"> <li>• (DocuPrint M235 z)<br/>To prevent you from losing the received fax data in the machine's memory, transfer the data to another Fax machine or to your computer before turning off the machine.</li> <li>• Press and hold  to turn the machine off, wait a few minutes, and then turn it on again.</li> <li>• If the problem continues, contact Fuji Xerox customer service.</li> </ul>   |
| Replace Drum    | It is time to replace the drum unit.<br>The drum unit counter was not reset when a new drum was installed.   | Replace the drum unit.<br>Reset the drum unit counter.  |
| Replace Toner   | The toner cartridge is at the end of its life. The machine stops all print operations.<br>While memory is available, faxes are stored in the memory. | Replace the toner cartridge with a new one.   |
| Scan Unable XX  | The machine has a mechanical problem.  | <ul style="list-style-type: none"> <li>• (DocuPrint M235 z)<br/>To prevent you from losing the received fax data in the machine's memory, transfer the data to another Fax machine or to your computer before turning off the machine.</li> <li>• Press and hold  to turn the machine off, and then turn it on again.</li> <li>• If the problem continues, contact Fuji Xerox customer service.</li> </ul>   |





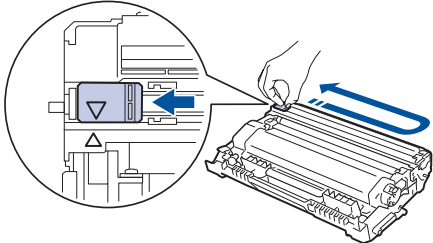

| Error Message    | Cause   | Action   |
|------------------|---|--|
| Self-Diagnostic  | The temperature of the fusing unit does not rise to a specified temperature within the specified time.  | <ul style="list-style-type: none"> <li>(DocuPrint M235 z)<br/>To prevent you from losing the received fax data in the machine's memory, transfer the data to another Fax machine or to your computer before turning off the machine.</li> <li>Press and hold  to turn the machine off, wait a few seconds, and then turn it on again. Leave the machine idle for 15 minutes with the power on.</li> </ul> |
|                  | The fusing unit is too hot.   |  |
| Size Error DX    | The paper size specified in the printer driver and the machine's paper size setting are not available for automatic 2-sided printing.   | Press <b>Stop/Exit</b> . Choose a paper size supported by 2-sided printing.<br>Paper size available for automatic 2-sided printing is A4.  |
|                  | The paper in the tray is not the correct size and is not available for automatic 2-sided printing.  | Load the correct size of paper in the tray and set the tray for that paper size.<br>Paper size available for automatic 2-sided printing is A4.   |
| Size Mismatch    | The paper in the tray is not the correct size.  | Load the correct size of paper in the tray and set the size of paper to the tray.  |
| Toner Ended      | The toner cartridge is at the end of its life. The machine stops all print operations.  | Replace the toner cartridge with a new one.  |
| Toner Low        | If the LCD displays this message, you can still print. The toner cartridge is near the end of its life.   | Order a new toner cartridge now so a replacement toner cartridge is available when the LCD displays <b>Replace Toner</b> .   |
| Wait for a while | The temperature of the inside of the machine is too hot. The machine will pause its current print job and go into cooling down mode. During the cooling down mode, you will hear the cooling fan running while the LCD displays <b>Wait for a while</b> . | Wait until the machine has finished cooling down. Make sure all vents on the machine are clear of obstructions. When the machine has cooled down, the machine will resume printing.<br>If the fan is not spinning, disconnect the machine from the power for several minutes, then reconnect it.   |

## DocuPrint M275 z/DocuPrint M285 z

| Error Message                                       | Cause   | Action   |
|---|---|--|
| 2-sided Disable                                     | The back cover of the machine is not closed completely.                 | Close the back cover of the machine until it locks in the closed position.   |
|   | The 2-sided tray is not installed completely.                           | Install the 2-sided tray firmly in the machine.  |
| Access Denied                                       | The function you want to use is restricted by Secure Function Lock 3.0. | Call your administrator to check your Secure Function Lock Settings.   |
| Cartridge Error<br>Put the Toner Cartridge back in. | The toner cartridge is not installed correctly.                         | Pull out the drum unit and toner cartridge assembly, take out the toner cartridge, and put it back in the drum unit again. Put the drum unit and |

| Error Message                          | Cause   | Action   |
|--|---|--|
|  |   | <p>toner cartridge assembly back in the machine.</p> <p>If the problem continues, contact Fuji Xerox customer service or your local Fuji Xerox dealer.</p>   |
| Comm.Error                             | Poor telephone line quality caused a communication error.   | Send the fax again or connect the machine to another telephone line. If the problem continues, contact the telephone company and ask them to check your telephone line.  |
| Cooling Down                           | The temperature of the inside of the machine is too hot. The machine will pause its current print job and go into cooling down mode. During the cooling down mode, you will hear the cooling fan running while the LCD displays <code>Cooling Down</code> . | <p>Wait until the machine has finished cooling down. Make sure all vents on the machine are clear of obstructions.</p> <p>When the machine has cooled down, the machine will resume printing.</p> <p>If the fan is not spinning, disconnect the machine from the power for several minutes, then reconnect it.</p> |
| Cover is Open                          | The front cover is not completely closed.   | Open and then firmly close the front cover of the machine.   |
|  | The fusing unit cover is not completely closed or paper was jammed in the back of the machine when you turned on the power.   | Close the fusing unit cover located inside the back cover of the machine.  |
|  | The ADF cover is not completely closed.   | <p>Close the ADF cover.</p> <p>If the error message remains, press .</p>  |
| Disconnected                           | The other person or other person's fax machine stopped the call.  | <p>Try to send or receive again.</p> <p>If calls are stopped repeatedly and you are using a VoIP (Voice over IP) system, try changing the Compatibility to Basic (for VoIP).</p>   |
| Document Jam                           | The document was not inserted or fed correctly, or the document scanned from the ADF was too long.  | <p>Remove the jammed paper from the ADF unit.</p> <p>Clear any debris or scraps of paper from the ADF unit paper path.</p> <p>Press .</p>   |
| DR Mode in Use<br>(Except New Zealand) | The machine is set to Distinctive Ring mode. You cannot change the Receive Mode from Manual to another mode.  | Set Distinctive Ring to <code>Off</code> .   |
| Drum !                                 | The corona wire on the drum unit must be cleaned.   | <p>Clean the corona wire on the drum unit.</p>    |
|  | The drum unit or the toner cartridge and drum unit assembly is not installed correctly.   | Put the toner cartridge in the drum unit. Then reinstall the toner cartridge and drum unit assembly in the machine.  |

| Error Message                      | Cause   | Action  |
|------------------------------------|---|---|
| Drum End Soon                      | The drum unit is near the end of its life.  | Order a new drum unit before you get the <code>Replace Drum</code> message.   |
| FaxAbility On<br>(For New Zealand) | The machine is set to Faxability mode. You can not change the Receive Mode from Manual to another mode.                                       | Set FaxAbility to <code>Off</code> .  |
| Jam 2-sided                        | The paper is jammed in the 2-sided paper tray.  | Pull the paper tray and the 2-sided tray out completely, open the back cover and then remove all jammed paper. Close the back cover, and put the paper tray and the 2-sided tray firmly back in the machine.  |
| Jam Inside                         | The paper is jammed inside the machine.   | Open the front cover and remove the toner cartridge and drum unit assembly. Pull out the jammed paper. Close the front cover.   |
| Jam Rear                           | The paper is jammed in the back of the machine.   | Open the fusing unit cover and remove all jammed paper. Close the fusing unit cover. If the error message remains, press <code>Retry</code> .   |
| Jam Tray                           | The paper is jammed in the indicated paper tray.  | Pull the paper tray out completely and remove all jammed paper. Put the paper tray firmly back in the machine.  |
| Limit Exceeded                     | The print limit set in Secure Function Lock 3.0 was reached.  | Call your administrator to check your Secure Function Lock Settings.  |
| Manual Feed                        | <b>Manual</b> was selected as the paper source in the printer driver, but there is no paper in the manual feed slot.                          | Place paper in the manual feed slot.  |
| No Caller ID                       | There is no incoming call history. You did not receive calls or you have not subscribed to the Caller ID service from your telephone company. | If you want to use the Caller ID feature, call your telephone company.  |
| No Paper                           | The machine is out of paper, or paper is not loaded correctly in the paper tray.  | <ul style="list-style-type: none"> <li>• Refill paper in the paper tray. Make sure the paper guides are set to the correct size.</li> <li>• If paper is in the tray, remove it and load it again. Make sure the paper guides are set to the correct size.</li> <li>• Do not overfill the paper tray.</li> </ul> |
| No Response/Busy                   | The number you dialed does not answer or is busy.   | Verify the number and try again.  |
| No Toner                           | The toner cartridge or the toner cartridge and drum unit assembly is not installed correctly.   | Remove the toner cartridge and drum unit assembly. Remove the toner cartridge from the drum unit, and reinstall the toner cartridge back in the drum unit. Reinstall the toner cartridge and drum unit assembly back in the machine. If the problem continues, replace the toner cartridge with a new one.      |
| Out of Memory                      | The machine's memory is full.   | <b>If a fax-sending or copy operation is in process</b><br>Do one of the following:   |

| Error Message      | Cause  | Action  |
|--------------------|--|---|
|                    |  | <ul style="list-style-type: none"> <li>Press  or Quit, and wait until the other operations that are in progress finish, and then try again.</li> <li>Press Send Now to send the pages scanned so far.</li> <li>Clear the data in the memory. To gain extra memory, you can turn off Memory Receive.</li> <li>Print the faxes that are in the memory.</li> </ul> <p><b>If a print operation is in process</b><br/>Do one of the following:</p> <ul style="list-style-type: none"> <li>Reduce the Resolution.</li> <li>Clear faxes from the memory.</li> </ul> |
| Print Data Full    | The machine's memory is full.  | Press  and delete the previously stored secure print data.   |
| Print Unable XX    | The machine has a mechanical problem.  | <ul style="list-style-type: none"> <li>Press and hold  to turn the machine off, wait a few minutes, and then turn it on again.</li> <li>If the problem continues, contact Fuji Xerox customer service.</li> </ul>  |
| Replace Drum       | It is time to replace the drum unit.   | Replace the drum unit.  |
|                    | The drum unit counter was not reset when a new drum was installed.   | Reset the drum unit counter.  |
| Replace Toner      | The toner cartridge is at the end of its life. The machine stops all print operations.<br>While memory is available, faxes are stored in the memory. | Replace the toner cartridge with a new one.   |
| Scan Unable        | The document is too long for 2-sided scanning.   | Press  . Use an appropriate size paper for 2-sided scanning.   |
| Scan Unable XX     | The machine has a mechanical problem.  | <ul style="list-style-type: none"> <li>Press and hold  to turn the machine off, and then turn it on again.</li> <li>If the problem continues, contact Fuji Xerox customer service.</li> </ul>  |
| Self-Diagnostic    | The temperature of the fusing unit does not rise to a specified temperature within the specified time.   | Press and hold  to turn the machine off, wait a few seconds, and then turn it on again. Leave the machine idle for 15 minutes with the power on.   |
|                    | The fusing unit is too hot.  |   |
| Size Error 2-sided | The paper size specified in the printer driver and the machine's paper size setting are not available for automatic 2-sided printing.                | Press  . Choose a paper size supported by 2-sided printing.<br>Paper size available for automatic 2-sided printing is A4.  |
|                    | The paper in the tray is not the correct size and is not available for automatic 2-sided printing.   | Load the correct size of paper in the tray and set the tray for that paper size.<br>Paper size available for automatic 2-sided printing is A4.  |

| Error Message                     | Cause   | Action  |
|-----------------------------------|---|---|
| Size mismatch                     | The paper in the tray is not the correct size.  | Load the correct size of paper in the tray and set the size of paper to the tray.   |
| Toner Ended                       | The toner cartridge is at the end of its life.  | Replace the toner cartridge with a new one.   |
| Toner Low                         | If the LCD displays this message, you can still print. The toner cartridge is near the end of its life. | Order a new toner cartridge now so a replacement toner cartridge is available when the LCD displays <code>Replace Toner</code> .          |
| Touchscreen Initialisation Failed | The touchscreen was pressed before the power on initialization was completed.                           | Make sure nothing is touching or resting on the touchscreen.  |
|                                   | Debris may be stuck between the lower part of the touchscreen and its frame.                            | Insert a piece of stiff paper between the lower part of the touchscreen and its frame and slide it back and forth to push out the debris. |



### Related Information

- [Troubleshooting](#)
- [Replace Supplies](#)
- [Load and Print Using the Multi-purpose Tray \(MP Tray\)](#)
- [Replace the Drum Unit](#)
- [Clean the Corona Wire](#)
- [Print a Fax Stored in the Machine's Memory](#)

## Document Jams

- [Document is Jammed in the Top of the ADF Unit](#)
- [Document is Jammed under the Document Cover](#)
- [Remove Small Scraps of Paper Jammed in the ADF](#)

## Document is Jammed in the Top of the ADF Unit

1. Remove any paper from the ADF that is not jammed.
2. Open the ADF cover.
3. Pull the jammed document out to the left. If the document rips or tears, be sure you remove any debris or scraps to prevent future jams.

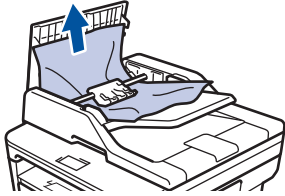

4. Close the ADF cover.
5. Do one of the following:
  - (DocuPrint M235 dw/DocuPrint M235 z)  
Press **Stop/Exit**.
  - (DocuPrint M275 z/DocuPrint M285 z)  
Press .

### Related Information

- [Document Jams](#)



## Document is Jammed under the Document Cover

1. Remove any paper from the ADF that is not jammed.
2. Lift the document cover.
3. Pull the jammed document out to the right. If the document rips or tears, be sure you remove any debris or scraps to prevent future jams.

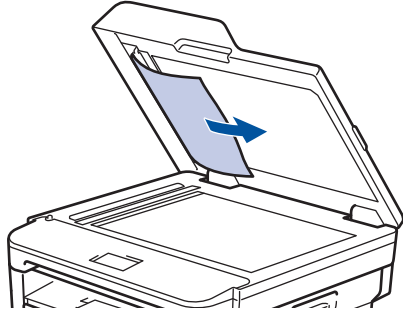

4. Close the document cover.
5. Do one of the following:
  - (DocuPrint M235 dw/DocuPrint M235 z)  
Press **Stop/Exit**.
  - (DocuPrint M275 z/DocuPrint M285 z)  
Press .



### Related Information

- [Document Jams](#)

## Remove Small Scraps of Paper Jammed in the ADF

1. Lift the document cover.
2. Insert a piece of stiff paper, such as cardstock, into the ADF to push any small paper scraps through.  
(DocuPrint M235 dw/DocuPrint M235 z)

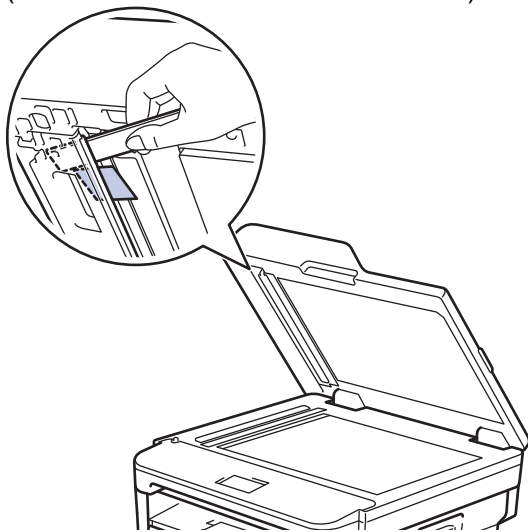

(DocuPrint M275 z/DocuPrint M285 z)

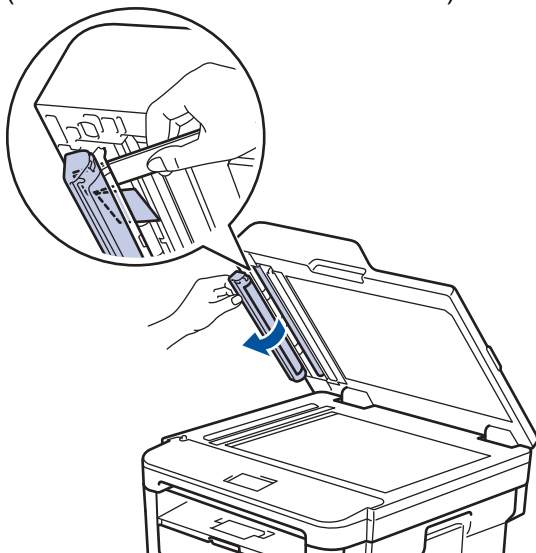

3. Close the document cover.
4. Do one of the following:
  - (DocuPrint M235 dw/DocuPrint M235 z)  
Press **Stop/Exit**.
  - (DocuPrint M275 z/DocuPrint M285 z)  
Press .

### Related Information

- [Document Jams](#)

## Paper Jams

Always remove the remaining paper from the paper tray and straighten the stack when you are adding new paper. This helps prevent multiple sheets of paper from feeding through the machine at one time and prevents paper jams.

- [Paper is Jammed in the Paper Tray](#)
- [Paper is Jammed in the MP tray](#)
- [Paper is Jammed in the Output Paper Tray](#)
- [Paper is Jammed in the Back of the Machine](#)
- [Paper is Jammed inside the Machine](#)
- [Paper is Jammed in the 2-sided Tray](#)

## Paper is Jammed in the Paper Tray

If the machine's control panel or the Status Monitor indicates that there is a jam in the paper tray, follow these steps:

1. Pull the paper tray completely out of the machine.

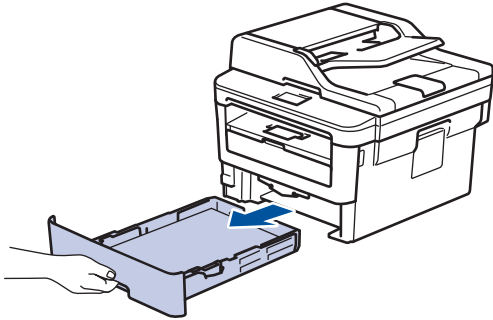

2. Slowly pull out the jammed paper.

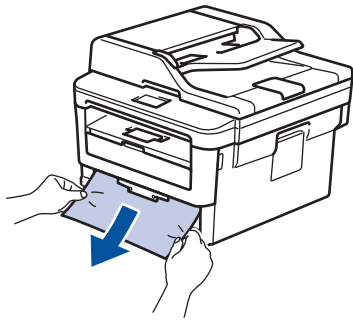

Pulling the jammed paper downward using both hands allows you to remove the paper more easily.

3. Fan the stack of paper to prevent further jams, and slide the paper guides to fit the paper size.

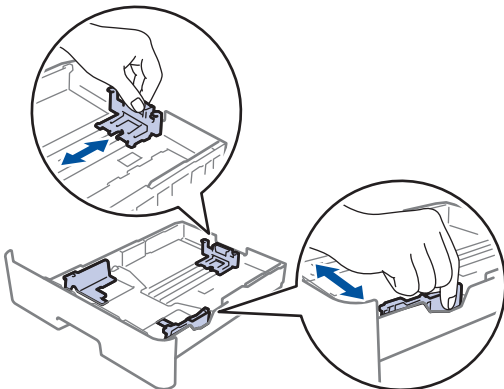

4. Make sure the paper is below the maximum paper mark (▼▼▼).

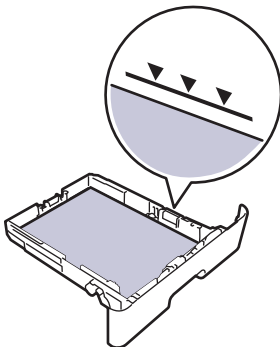

5. Put the paper tray firmly back in the machine.



## Related Information

- [Paper Jams](#)
-

## Paper is Jammed in the MP tray

**Related Models:** DocuPrint M285 z

If the machine's control panel or the Status Monitor indicates that there is a jam in the machine's MP tray, follow these steps:

1. Remove the paper from the MP tray.
2. Remove any jammed paper from in and around the MP tray.

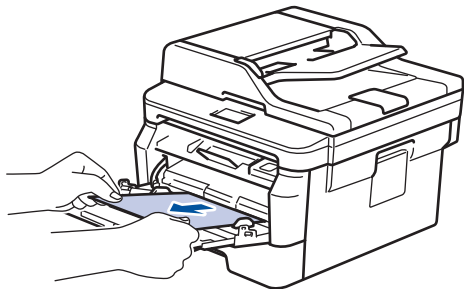

3. Fan the paper stack, and then put it back in the MP tray.
4. Reload paper in the MP tray and make sure the paper stays under the maximum paper height guides (1) on both sides of the tray.

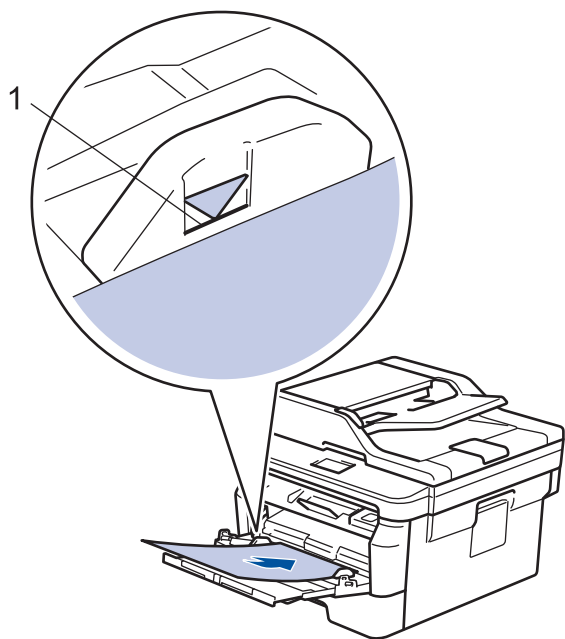

5. Follow the instructions on the machine's LCD.



### Related Information

- [Paper Jams](#)

## Paper is Jammed in the Output Paper Tray

When the paper is jammed in the output paper tray, follow these steps:

1. Use both hands to open the scanner.

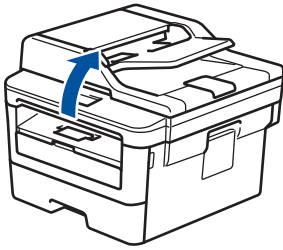

2. Remove the paper.

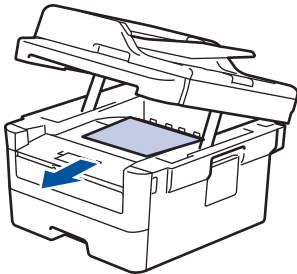

3. Push the scanner down with both hands to close it.

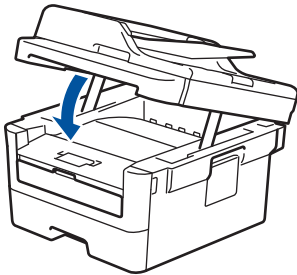

### Related Information

- [Paper Jams](#)

## Paper is Jammed in the Back of the Machine

If the machine's control panel or the Status Monitor indicates that there is a jam in the back (Rear) of the machine, follow these steps:

1. Leave the machine turned on for 10 minutes for the internal fan to cool the extremely hot parts inside the machine.
2. Open the back cover.

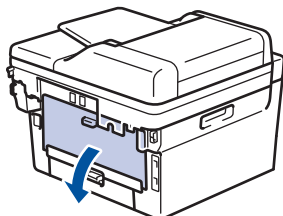

3. Pull the blue tabs at the left and right sides toward you to release the fusing unit cover.

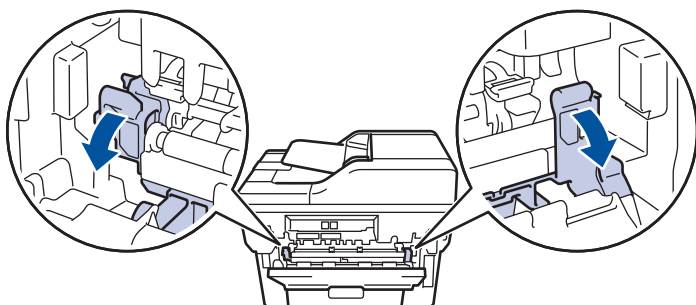

### WARNING

#### HOT SURFACE

The machine's internal parts will be extremely hot. Wait for the machine to cool down before touching them.

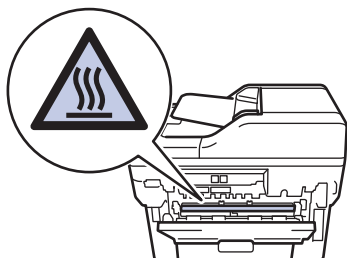

 If the green envelope levers inside the back cover are pulled down to the envelope position, lift these levers to the original position before pulling the green tabs down.

4. Use both hands to gently pull the jammed paper out of the fusing unit.

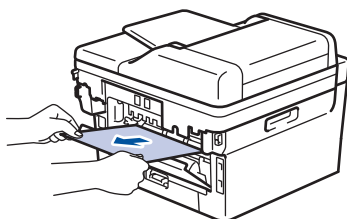



---

5. Close the fusing unit cover.

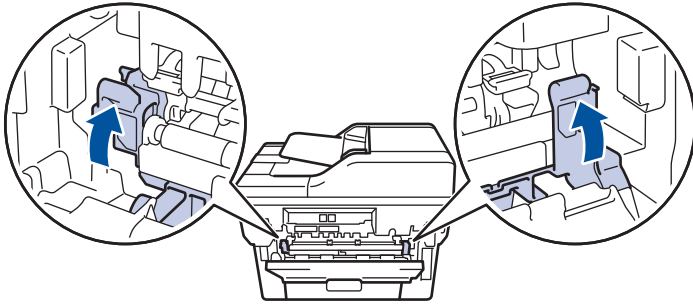

If you print on envelopes, pull down the green envelope levers to the envelope position again before closing the back cover.

---

6. Close the back cover until it locks in the closed position.



### Related Information

- [Paper Jams](#)
-

## Paper is Jammed inside the Machine

If the machine's control panel or the Status Monitor indicates that there is a jam inside the machine, follow these steps:

### CAUTION

Do not attempt to remove a paper jammed deeply inside the product, particularly a paper wrapped around a heat roller. Otherwise, it may cause injuries or burns, and even worse, may generate smoke if you keep operating the product with a paper jammed. Switch off the product promptly and contact your local Fuji Xerox representative for more information.

1. Leave the machine turned on for 10 minutes for the internal fan to cool the extremely hot parts inside the machine.
2. Open the front cover.

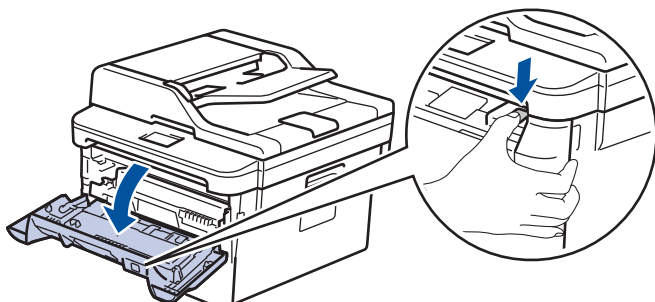
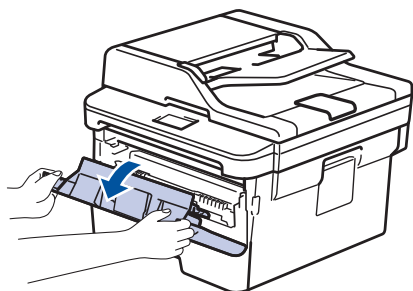

3. Remove the toner cartridge and drum unit assembly.

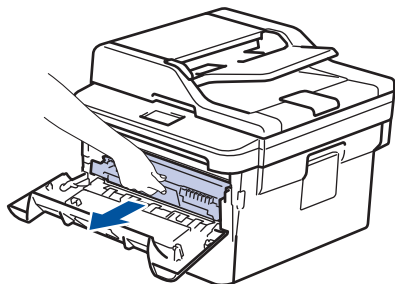

### WARNING

#### HOT SURFACE

The machine's internal parts will be extremely hot. Wait for the machine to cool down before touching them.



4. Pull out the jammed paper slowly.

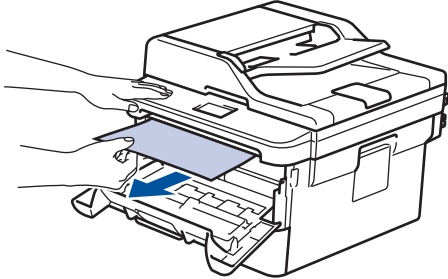

5. Install the toner cartridge and drum unit assembly into the machine.

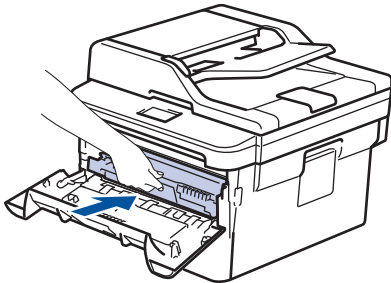

6. Close the front cover.

---

## Related Information

- [Paper Jams](#)
-

## Paper is Jammed in the 2-sided Tray

If the machine's control panel or the Status Monitor indicates that there is a jam in the 2-sided paper tray, follow these steps:

1. Leave the machine turned on for 10 minutes for the internal fan to cool the extremely hot parts inside the machine.
2. Pull the paper tray completely out of the machine.

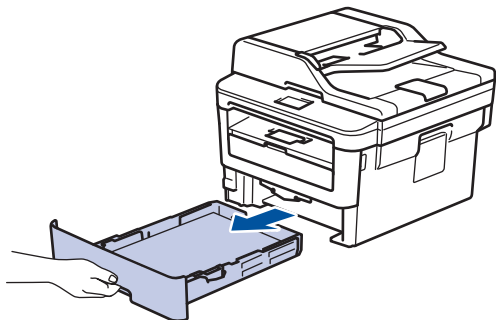

3. At the back of the machine, pull the 2-sided tray completely out of the machine.

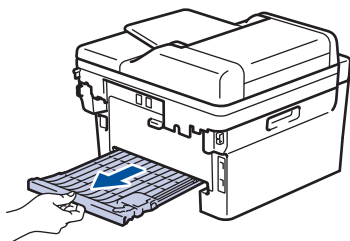

4. Pull the jammed paper out of the machine or out of the 2-sided tray.

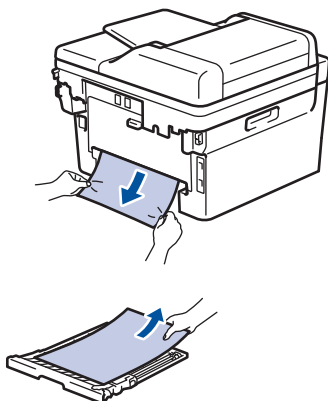

5. Remove paper that may have jammed under the machine due to static electricity.

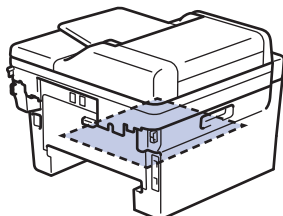

- 
6. If paper is not caught inside the 2-sided tray, open the back cover.

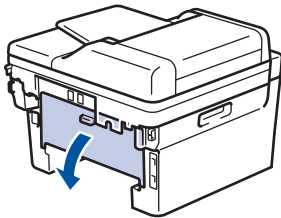

## **WARNING**

### HOT SURFACE

The machine's internal parts will be extremely hot. Wait for the machine to cool down before touching them.

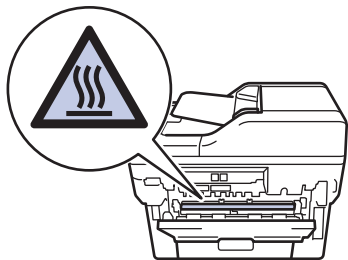

- 
7. Use both hands to gently pull the jammed paper out of the back of the machine.

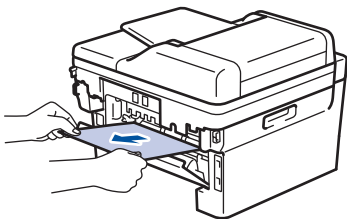



8. Close the back cover until it locks in the closed position.  
9. Put the 2-sided tray firmly back in the rear of the machine.  
10. Put the paper tray firmly back in the front of the machine.

## **Related Information**

- [Paper Jams](#)

## Printing Problems

| Difficulties | Suggestions  |
|--------------|--|
| No printout  | <p>Check the machine is not in Power Off mode.</p> <p>If the machine is in Power Off mode, press  on the control panel, and then send the print data again.</p> <p>Check that the correct printer driver has been installed and selected.</p> <p>Check to see if the Status Monitor or the machine's control panel displays an error status.</p> <p>Check that the machine is online:</p> <ul style="list-style-type: none"> <li>• Windows® 7 and Windows Server® 2008 R2                     <p>Click  (<b>Start</b>) &gt; <b>Devices and Printers</b> . Right-click <b>FX DocuPrint XXXXX</b> and click <b>See what's printing</b>. Click <b>Printer</b> in the menu bar. Make sure <b>Use Printer Offline</b> is not selected.</p> </li> <li>• Windows Server® 2008                     <p>Click  (<b>Start</b>) &gt; <b>Control Panel</b> &gt; <b>Hardware and Sound</b> &gt; <b>Printers</b>. Right-click <b>FX DocuPrint XXXXX</b>. Make sure <b>Use Printer Online</b> is not listed. If it is listed, click this option to set the driver Online.</p> </li> <li>• Windows® 8 and Windows Server® 2012                     <p>Move your mouse to the lower right corner of your desktop. When the menu bar appears, click <b>Settings</b> &gt; <b>Control Panel</b>. In the <b>Hardware and Sound</b> group, click <b>View devices and printers</b>. Right-click the <b>FX DocuPrint XXXXX</b>. Click <b>See what's printing</b>. If printer driver options appear, select your printer driver. Click <b>Printer</b> in the menu bar and make sure that <b>Use Printer Offline</b> is not selected.</p> </li> <li>• Windows® 10 and Windows Server® 2016                     <p>Click  &gt; <b>Windows System</b> &gt; <b>Control Panel</b>. In the <b>Hardware and Sound</b> group, click <b>View devices and printers</b>. Right-click the <b>FX DocuPrint XXXXX</b>. Click <b>See what's printing</b>. If printer driver options appear, select your printer driver. Click <b>Printer</b> in the menu bar and make sure that <b>Use Printer Offline</b> is not selected.</p> </li> <li>• Windows Server® 2012 R2                     <p>Click <b>Control Panel</b> on the <b>Start</b> screen. In the <b>Hardware</b> group, click <b>View devices and printers</b>. Right-click the <b>FX DocuPrint XXXXX</b>. Click <b>See what's printing</b>. If printer driver options appear, select your printer driver. Click <b>Printer</b> in the menu bar and make sure <b>Use Printer Offline</b> is not selected.</p> </li> <li>• Mac                     <p>Click the <b>System Preferences</b> menu, and then select the <b>Printers &amp; Scanners</b> option. When the machine is offline, delete it using the  button, and then add it using the  button.</p> </li> </ul> |

| Difficulties   | Suggestions   |
|--|---|
| The machine is not printing or has stopped printing.   | Cancel the print job and clear it from the machine's memory. The printout may be incomplete. Send the print data again.<br><i>See Related Information:Cancel a Print Job.</i>   |
| The headers or footers appear when the document displays on the screen but they do not show up when it is printed.   | There is an unprintable area on the top and bottom of the page. Adjust the top and bottom margins in your document to allow for this.   |
| The machine prints unexpectedly or it prints garbage.  | Cancel the print job and clear it from the machine's memory. The printout may be incomplete. Send the print data again.<br><i>See Related Information:Cancel a Print Job.</i>   |
|  | Check the settings in your application to make sure they are set up to work with your machine.  |
|  | Confirm that the Fuji Xerox printer driver is selected in your application's Print window.  |
| The machine prints the first couple of pages correctly, then some pages have missing text.   | Check the settings in your application to make sure they are set up to work with your machine.  |
|  | Your machine is not receiving all of the data sent from the computer. Make sure you connected the interface cable correctly.  |
| The machine does not print on both sides of the paper even though the printer driver setting is 2-sided and the machine supports automatic 2-sided printing. | Check the paper size setting in the printer driver. You must select A4 paper that is 60 to 105 g/m <sup>2</sup> .   |
| Print speed is too slow.   | Try changing the printer driver setting. The highest resolution needs longer data processing, sending and printing time.  |
|  | If you have enabled the Quiet Mode, disable the Quiet Mode on the printer driver or the machine's menu setting.   |
| The machine does not feed paper.   | If there is paper in the paper tray, make sure it is straight. If the paper is curled, straighten it. Sometimes it is helpful to remove the paper, turn the stack over and place it back in the paper tray.   |
|  | Reduce the amount of paper in the paper tray, and then try again.   |
|  | (For models with MP Tray)Make sure <b>MP Tray</b> is not selected for <b>Paper Source</b> in the printer driver.<br>(For models with Manual Feed Slot)Make sure <b>Manual</b> is not selected for <b>Paper Source</b> in the printer driver.                  |
|  | Clean the paper pick-up rollers.  |
| The machine does not feed paper from the MP tray.<br>(For models with MP Tray)   | Fan the paper well and place it back in the MP tray firmly.   |
|  | Make sure <b>MP Tray</b> is selected as <b>Paper Source</b> in the printer driver.  |
| The machine does not feed paper from the Manual feed slot.<br>(For models with Manual Feed Slot)   | Use both hands to push one sheet of paper firmly into the manual feed slot until the top edge of the paper presses against the paper feed rollers. Continue pressing the paper against the rollers until the machine grabs the paper and pulls it in further. |
|  | Put only one sheet of paper in the manual feed slot.  |
|  | Make sure <b>Manual</b> is selected as <b>Paper Source</b> in the printer driver.   |
| The machine does not feed envelopes.   | (For models with Manual Feed Slot)<br>Load one envelope at a time in the manual feed slot. Your application must be set to print the envelope size you are  |

---

| Difficulties | Suggestions   |
|--------------|---|
|              | <p>using. This is usually done in the Page Setup or Document Setup menu of your application.</p> <p>(For models with MP Tray)</p> <p>Load envelopes in the MP tray. Your application must be set to print the envelope size you are using. This is usually done in the Page Setup or Document Setup menu of your application.</p> |



## Related Information

---

- [Troubleshooting](#)
  - [Monitor the Status of the Machine from Your Computer \(Windows®\)](#)
  - [Monitor the Status of the Machine from Your Computer \(Mac\)](#)
  - [Cancel a Print Job](#)
  - [Clean the Paper Pick-up Rollers](#)
  - [Load and Print Using the Multi-purpose Tray \(MP Tray\)](#)
-





## Improve the Print Quality





If you have a print quality problem, print a test page first. If the printout looks good, the problem is probably not the machine. Check the interface cable connections and try printing a different document. If the printout or test page printed from the machine has a quality problem, check the examples of poor print quality and follow the recommendations in the table.



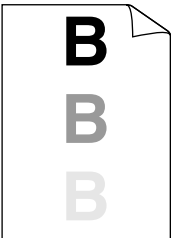

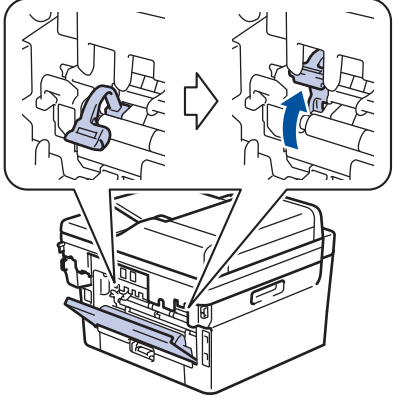
### IMPORTANT

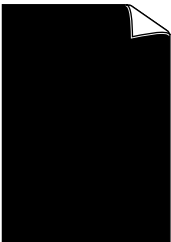

Using non-Fuji Xerox supplies may affect the print quality, hardware performance, and machine reliability.

1. To get the best print quality, we suggest using recommended print media. Make sure you use paper that meets our specifications.
2. Check that the toner cartridge and drum unit are installed correctly.

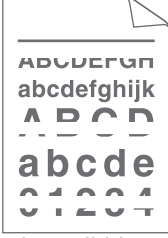
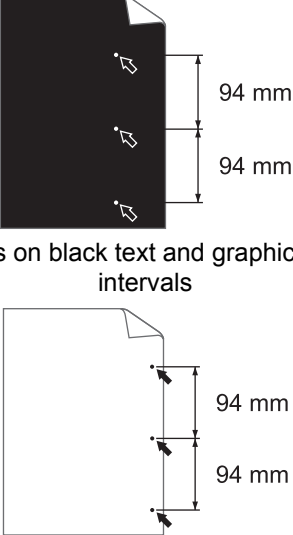
| Examples of poor print quality   | Recommendation   |
|--|--|
|  <p>Faint</p>             | <ul style="list-style-type: none"> <li>• If the machine indicates Replace Toner status, install a new toner cartridge.</li> <li>• Check the machine's environment. Conditions such as humidity, high temperatures, and so on, may cause this print fault.</li> <li>• If the whole page is too light, Toner Save may be turned on. Turn off Toner Save mode in the machine's menu settings or the printer driver.</li> <li>• Clean the drum unit.</li> <li>• Clean the corona wire on the drum unit.</li> <li>• Replace the toner cartridge with a new toner cartridge.</li> <li>• Replace the drum unit with a new drum unit.</li> </ul> |
|  <p>Grey background</p> | <ul style="list-style-type: none"> <li>• Check the machine's environment. Conditions such as high temperatures and high humidity can increase the amount of background shading.</li> <li>• Clean the drum unit.</li> <li>• Replace the toner cartridge with a new toner cartridge.</li> <li>• Replace the drum unit with a new drum unit.</li> </ul>   |
|  <p>Ghosting images</p> | <ul style="list-style-type: none"> <li>• Check the machine's environment. Conditions such as low humidity and low temperatures may cause this print quality problem.</li> <li>• Select the appropriate media type in the printer driver.</li> <li>• Select the appropriate media type in the menu setting.</li> <li>• Make sure the two green levers inside the back cover are in the up position. Pull up the two green levers until they stop.</li> </ul>  |

| Examples of poor print quality   | Recommendation   |
|--|--|
|  |  <ul style="list-style-type: none"> <li>• Clean the drum unit.</li> <li>• Replace the drum unit with a new drum unit.</li> <li>• Replace the toner cartridge with a new toner cartridge.</li> <li>• The fusing unit may be contaminated. Contact Fuji Xerox customer service.</li> </ul>   |
|  <p>Toner specks</p>                 | <ul style="list-style-type: none"> <li>• Make sure the media type setting in the driver matches the type of paper you are using.</li> <li>• Clean the drum unit.</li> <li>• The toner cartridge may be damaged. Replace the toner cartridge with a new toner cartridge.</li> <li>• The drum unit may be damaged. Replace the drum unit with a new drum unit.</li> <li>• The fusing unit may be contaminated. Contact Fuji Xerox customer service.</li> </ul>       |
|  <p>Hollow print</p>                | <ul style="list-style-type: none"> <li>• Select <b>Thick Paper</b> mode in the printer driver or use thinner paper than you are currently using.</li> <li>• Select the appropriate media type in the menu setting.</li> <li>• Check the machine's environment. Conditions such as high humidity can cause hollow print.</li> <li>• The drum unit may be damaged. Replace the drum unit with a new drum unit.</li> </ul>  |
|  <p>All black</p>                   | <ul style="list-style-type: none"> <li>• Clean the corona wire inside the drum unit.</li> <li>• The drum unit may be damaged. Replace the drum unit with a new drum unit.</li> </ul>   |
|  <p>White lines across the page</p> | <ul style="list-style-type: none"> <li>• Select the appropriate media type in the printer driver.</li> <li>• Select the appropriate media type in the menu setting.</li> <li>• The problem may disappear by itself. Print multiple blank pages to clear this problem, especially if the machine has not been used for a long time.</li> <li>• Clean the drum unit.</li> <li>• The drum unit may be damaged. Replace the drum unit with a new drum unit.</li> </ul> |

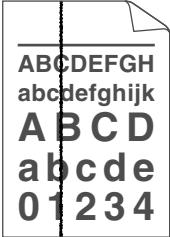
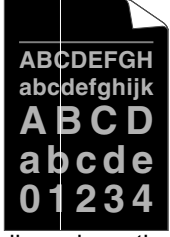
| Examples of poor print quality   | Recommendation  |
|--|---|
|  <p data-bbox="347 405 601 432">Lines across the page</p>   | <ul data-bbox="818 170 1356 280" style="list-style-type: none"> <li>• Clean the drum unit.</li> <li>• The drum unit may be damaged.<br/>Replace the drum unit with a new drum unit.</li> </ul>  |
|  <p data-bbox="288 689 665 716">Black toner lines across the page</p>   | <ul data-bbox="818 454 1473 542" style="list-style-type: none"> <li>• If the paper you use is thick, black lines may be appeared. When this happens, use thinner paper than you are using.</li> </ul>   |
|  <p data-bbox="220 974 730 1001">White lines, bands or ribbing across the page</p>  | <ul data-bbox="818 739 1473 936" style="list-style-type: none"> <li>• Check the machine's environment. Conditions such as high humidity and high temperatures may cause this print quality problem.</li> <li>• Clean the drum unit.</li> <li>• If the problem is not solved after printing a few pages, replace the drum unit with a new drum unit.</li> </ul>  |
|  <p data-bbox="197 1261 753 1317">White Spots on black text and graphics at 94 mm intervals</p> <p data-bbox="301 1565 649 1592">Black spots at 94 mm intervals</p> | <ul data-bbox="818 1023 1473 1317" style="list-style-type: none"> <li>• Make 10-15 copies of a blank, white sheet of paper. If the problem is not solved after printing the blank pages, the drum unit may have foreign material, such as glue from a label, stuck on the drum. Clean the drum unit.<br/><i>See Related Information: Clean the Drum Unit Using Drum Dot Print.</i></li> <li>• The drum unit may be damaged.<br/>Replace the drum unit with a new drum unit.</li> </ul>  |
|  <p data-bbox="277 1848 673 1874">Black toner marks across the page</p>   | <ul data-bbox="818 1612 1473 2092" style="list-style-type: none"> <li>• If you use label sheets for laser printers, the glue from the sheets may sometimes stick to the drum surface. Clean the drum unit.<br/><i>See Related Information: Clean the Drum Unit Using Drum Dot Print.</i></li> <li>• If you used paper that has clips or staples, the drum unit may be damaged.</li> <li>• If the unpacked drum unit is in direct sunlight (or room light for long periods of time), the unit may be damaged.</li> <li>• Clean the drum unit.</li> <li>• The toner cartridge may be damaged.<br/>Replace the toner cartridge with a new toner cartridge.</li> <li>• The drum unit may be damaged.</li> </ul> |

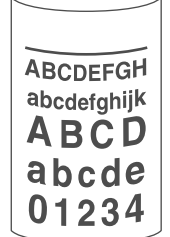
| Examples of poor print quality   | Recommendation   |
|--|--|
|  <p data-bbox="327 454 743 521">Black lines down the page<br/>Printed pages have toner stains down the page</p> | <p data-bbox="855 170 1353 197">Replace the drum unit with a new drum unit.</p> <ul data-bbox="818 219 1469 577" style="list-style-type: none"> <li data-bbox="818 219 1469 275">• Clean the corona wire inside the drum unit by sliding the green tab.<br/>Make sure that the green tab on the drum unit is in the Home position.</li> <li data-bbox="818 353 1469 421">• The toner cartridge may be damaged.<br/>Replace the toner cartridge with a new toner cartridge.</li> <li data-bbox="818 432 1469 499">• The drum unit may be damaged.<br/>Replace the drum unit with a new drum unit.</li> <li data-bbox="818 510 1469 577">• The fusing unit may be contaminated.<br/>Contact Fuji Xerox customer service.</li> </ul>  |
|  <p data-bbox="327 831 627 857">White lines down the page</p>   | <ul data-bbox="818 600 1469 846" style="list-style-type: none"> <li data-bbox="818 600 1469 689">• Make sure foreign material such as a torn piece of paper, sticky notes or dust is not inside the machine and around the toner cartridge and drum unit.</li> <li data-bbox="818 701 1469 768">• The toner cartridge may be damaged.<br/>Replace the toner cartridge with a new toner cartridge.</li> <li data-bbox="818 779 1469 846">• The drum unit may be damaged.<br/>Replace the drum unit with a new drum unit.</li> </ul>   |
|  <p data-bbox="391 1111 560 1137">Image skewed</p>   | <ul data-bbox="818 880 1469 1384" style="list-style-type: none"> <li data-bbox="818 880 1469 969">• Set the document correctly in the ADF or on the scanner glass if the skew only occurs when making copies.</li> <li data-bbox="818 981 1469 1070">• Make sure the paper or other print media is loaded correctly in the paper tray and the guides are not too tight or too loose against the paper stack.</li> <li data-bbox="818 1081 1469 1108">• Set the paper guides correctly.</li> <li data-bbox="818 1120 1469 1146">• The paper tray may be too full.</li> <li data-bbox="818 1158 1469 1184">• Check the paper type and quality.</li> <li data-bbox="818 1196 1469 1263">• Check for loose objects such as torn paper inside the machine.</li> <li data-bbox="818 1274 1469 1384">• If the problem only occurs during automatic 2-sided printing, check for torn paper in the 2-sided tray. Verify the 2-sided tray is inserted completely and the back cover is closed completely.</li> </ul>   |
|  <p data-bbox="352 1648 600 1675">Curled or wavy image</p>  | <ul data-bbox="818 1406 1469 1966" style="list-style-type: none"> <li data-bbox="818 1406 1469 1462">• Check the paper type and quality. High temperatures and high humidity will cause paper to curl.</li> <li data-bbox="818 1473 1469 1630">• If you do not use the machine often, the paper may have been in the paper tray too long. Turn over the stack of paper in the paper tray. Also, fan the paper stack, and then rotate the paper 180° in the paper tray.</li> <li data-bbox="818 1641 1469 1697">• Open the back cover (face up output tray) to let the printed paper exit onto the face up output tray.</li> <li data-bbox="818 1709 1469 1765">• Choose <b>Reduce Paper Curl</b> mode in the printer driver when you do not use our recommended print media.</li> <li data-bbox="818 1776 1469 1966">• Turn the paper over in the paper tray, and print again. If the problems remains, switch the Anti-Curl Levers as follows: <ul data-bbox="855 1877 1469 1966" style="list-style-type: none"> <li data-bbox="855 1877 1469 1904">1. Open the back cover.</li> <li data-bbox="855 1915 1469 1966">2. Lift the lever (1) and slide the two gray levers (2) in the direction of the arrow.</li> </ul> </li> </ul> |

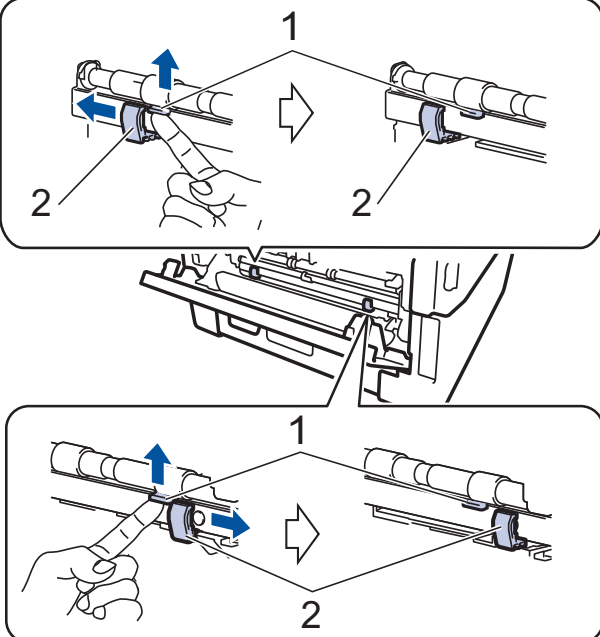
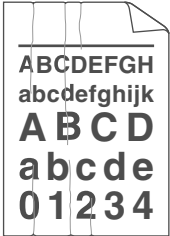
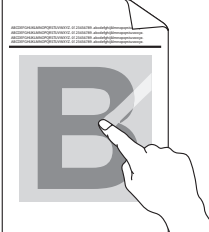
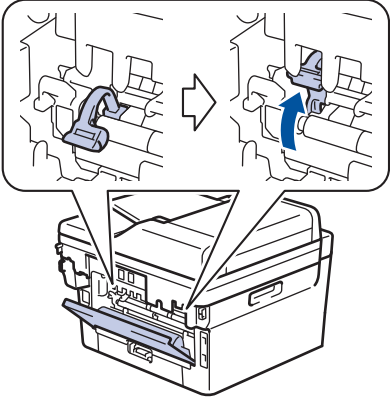
| Examples of poor print quality  | Recommendation   |
|---|--|
|   |    |
|  <p data-bbox="363 1066 587 1093">Wrinkles or creases</p> | <ul data-bbox="820 831 1437 969" style="list-style-type: none"> <li>• Make sure paper is loaded correctly.</li> <li>• Check the paper type and quality.</li> <li>• Turn over the stack of paper in the tray or rotate the paper 180° in the input tray.</li> </ul>   |
|  <p data-bbox="416 1350 534 1377">Poor fixing</p>        | <ul data-bbox="820 1115 1461 1205" style="list-style-type: none"> <li>• Make sure the two green levers inside the back cover are in the up position. Pull up the two green levers until they stop.</li> </ul>  <ul data-bbox="820 1624 1453 1749" style="list-style-type: none"> <li>• Make sure the media type setting in the printer driver matches the type of paper you are using.</li> <li>• Choose <b>Improve Toner Fixing</b> mode in the printer driver.</li> </ul> <p data-bbox="855 1760 1433 1910">If this selection does not provide enough improvement, change the printer driver setting in <b>Media Type</b> to a thick setting. If you are printing an envelope, choose <b>Env. Thick</b> in the media type setting.</p> |

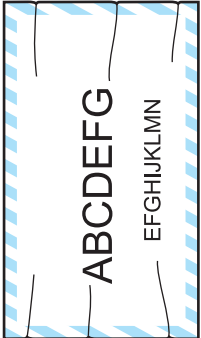
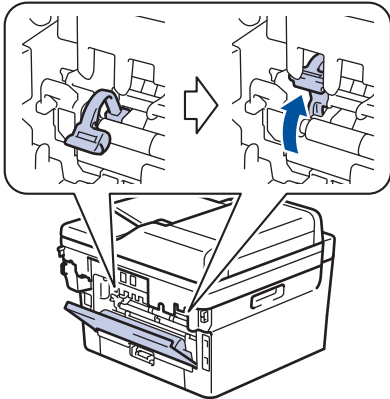
| Examples of poor print quality  | Recommendation   |
|---|--|
|  <p data-bbox="375 510 576 539">Envelope creases</p> | <ul style="list-style-type: none"> <li data-bbox="820 168 1476 315">• Make sure the two green levers inside the back cover are pulled down to the envelope position when you print envelopes. After you have finished printing, reset the levers back to their original position. Pull up the levers until they stop.</li> </ul>  <ul style="list-style-type: none"> <li data-bbox="820 734 1458 797">• Make sure envelopes are printed with the back cover (face up output tray) opened.</li> <li data-bbox="820 804 1437 904">• (For models with Manual Feed Slot)<br/>Make sure envelopes are fed only from the manual feed slot.</li> <li data-bbox="820 911 1442 987">• (For models with MP Tray)<br/>Make sure envelopes are fed only from the MP tray.</li> </ul> |



### Related Information

- [Troubleshooting](#)
- [Test Print](#)
- [Clean the Drum Unit Using Drum Dot Print](#)
- [Reduce Toner Consumption](#)
- [Replace the Toner Cartridge](#)
- [Replace the Drum Unit](#)

## Telephone and Fax Problems

**Related Models:** DocuPrint M235 z/DocuPrint M275 z/DocuPrint M285 z

### Telephone Line or Connections

| Difficulties                             | Suggestions  |
|--|--|
| Dialling does not work. (No dial tone)   | Check all line cord connections. Make sure the telephone line cord is plugged into the telephone wall socket and the LINE socket of the machine. Make sure your machine has a dial tone by pressing the Hook button in Fax mode. If you subscribe to DSL or VoIP services, contact your service provider for connection instructions.  |
|  | (Available only for some countries.)<br>Change the Tone/Pulse setting.   |
|  | Send a manual fax by pressing Hook button, and dialing the number. Wait to hear fax-receiving tones before pressing Start button.  |
|  | If there is no dial tone, connect a known working telephone and telephone line cord to the socket. Then lift the external telephone's handset and listen for a dial tone. If there is still no dial tone, ask your telephone company to check the line and/or wall socket.   |
| The machine does not answer when called. | <p>Make sure the machine is in the correct receive mode for your setup.</p> <p>Check for a dial tone. If possible, call your machine to hear it answer. If there is still no answer, check that the telephone line cord is plugged into the telephone wall socket and the LINE socket of the machine. Make sure your machine has a dial tone by pressing the Hook button in Fax mode. If there is no ringing when you call your machine, ask your telephone company to check the line.</p> |

### Handling Incoming Calls

| Difficulties                       | Suggestions   |
|------------------------------------|---|
| Sending a Fax Call to the machine. | <p>If you answered on an extension or external telephone, press your Remote Activation Code (the factory setting is *51 (*91 for New Zealand)). If you answered on the external telephone, press the Start button to receive the fax.</p> <p>When your machine answers, hang up.</p>  |
| Custom features on a single line.  | <p>If you have Call Waiting, Call Waiting/Caller ID, Caller ID, Voice Mail, an answering machine, an alarm system or other custom feature on a single telephone line with your machine, it may create a problem sending or receiving faxes.</p> <p><b>For Example:</b> If you subscribe to Call Waiting or some other custom service and its signal comes through the line while your machine is sending or receiving a fax, the signal can temporarily interrupt or disrupt the faxes. Fuji Xerox's ECM (Error Correction Mode) feature should help overcome this problem. This condition is related to the telephone system industry and is common to all devices that send and receive information on a single, shared line with custom features. If avoiding a slight interruption is</p> |

| Difficulties | Suggestions   |
|--------------|---|
|              | crucial to your business, we recommend using a separate telephone line with no custom features. |

## Receiving Faxes

| Difficulties          | Suggestions  |
|-----------------------|--|
| Cannot receive a fax. | <p data-bbox="815 365 1477 611">Check all line cord connections. Make sure the telephone line cord is plugged into the telephone wall socket and the LINE socket of the machine. If you subscribe to DSL or VoIP services, contact your service provider for connection instructions. If you are using a VoIP system, try changing the VoIP setting to <i>Basic (for VoIP)</i>. This will lower modem speed and turn off Error Correction Mode (ECM).</p> <p data-bbox="815 622 1477 745">Make sure your machine has a dial tone by pressing the Hook button in Fax mode. If you hear static or interference on your fax line, contact your local telephone provider.</p> <p data-bbox="815 757 1477 880">Make sure the machine is in the correct Receive Mode. This is determined by the external devices and telephone subscriber services you have on the same line as the Fuji Xerox machine.</p> <ul data-bbox="815 891 1477 1529" style="list-style-type: none"> <li>• If you have a dedicated fax line and want your Fuji Xerox machine to automatically answer all incoming faxes, you should select Fax only mode.</li> <li>• If your Fuji Xerox machine shares a line with an external answering machine, you should select the External TAD mode. In External TAD mode, your Fuji Xerox machine will receive incoming faxes automatically and voice callers will be able to leave a message on your answering machine.</li> <li>• If your Fuji Xerox machine shares a line with other telephones and you want it to automatically answer all incoming faxes, you should select the Fax/Tel mode. In Fax/Tel mode, your Fuji Xerox machine will receive faxes automatically and produce a pseudo/double-ring to alert you to answer voice calls.</li> <li>• If you do not want your Fuji Xerox machine to answer any incoming faxes automatically, you should select the Manual mode. In Manual mode, you must answer every incoming call and activate the machine to receive faxes.</li> </ul> <p data-bbox="815 1541 1477 1641">Another device or service at your location may be answering the call before your Fuji Xerox machine answers. To test this, lower the Ring Delay setting:</p> <ul data-bbox="815 1653 1477 1877" style="list-style-type: none"> <li>• If the Receive Mode is set to Fax Only or Fax/Tel, reduce the Ring Delay to one ring.</li> <li>• If the Receive Mode is set to External TAD, reduce the number of rings programmed on your answering machine to two.</li> <li>• If the Receive Mode is set to Manual, DO NOT adjust the Ring Delay setting.</li> </ul> <p data-bbox="815 1888 1477 1921">Have someone send you a test fax:</p> <ul data-bbox="815 1933 1477 2067" style="list-style-type: none"> <li>• If you received the test fax successfully, your machine is operating correctly. Remember to reset your Ring Delay or answering machine setting back to your original setting. If receiving problems recur after resetting the Ring Delay, then a person, device, or</li> </ul> |



| Difficulties | Suggestions  |
|--------------|--|
|              | <p>subscriber service is answering the fax call before the machine has a chance to answer.</p> <ul style="list-style-type: none"> <li>• If you were not able to receive the fax, then another device or subscriber service may be interfering with your fax reception or there may be a problem with your fax line.</li> </ul> <p>If you are using a telephone answering machine (External TAD mode) on the same line as the Fuji Xerox machine, make sure your answering machine is set up correctly.</p> <ol style="list-style-type: none"> <li>1. Set your answering machine to answer in one or two rings.</li> <li>2. Record the outgoing message on your answering machine. <ul style="list-style-type: none"> <li>• Record five seconds of silence at the beginning of your outgoing message.</li> <li>• Limit your speaking to 20 seconds.</li> <li>• End your outgoing message with your Remote Activation Code for people sending manual faxes. For example: "After the beep, leave a message or press *51 (*91 for New Zealand) and Start to send a fax."</li> </ul> </li> <li>3. Set your answering machine to answer calls.</li> <li>4. Set your Fuji Xerox machine's Receive Mode to External TAD.</li> </ol> <p>Make sure your Fuji Xerox machine's Fax Detect feature is turned On. Fax Detect is a feature that allows you to receive a fax even if you answered the call on an external or extension telephone.</p> <p>If you often get transmission errors due to possible interference on the telephone line or if you are using a VoIP system, try changing the Compatibility setting to <i>Basic(for VoIP)</i>.</p> <p>Contact your administrator to check your Secure Function Lock Settings.</p> |

## Sending Faxes

| Difficulties          | Suggestions  |
|-----------------------|--|
| Cannot send a fax.    | <p>Check all line cord connections. Make sure the telephone line cord is plugged into the telephone wall socket and the LINE socket of the machine. Make sure your machine has a dial tone by pressing the Hook button in Fax mode. If you subscribe to DSL or VoIP services, contact your service provider for connection instructions.</p> <p>Make sure you pressed Fax and the machine is in Fax mode.</p> <p>Print the Transmission Verification Report and check for an error.</p> <p>Contact your administrator to check your Secure Function Lock Settings.</p> <p>Ask the other party to check that the receiving machine has paper.</p> |
| Poor sending quality. | <p>Try changing your resolution to Fine or S.Fine. Make a copy to check your machine's scanner operation. If the copy quality is poor, clean the scanner.</p>  |

| Difficulties  | Suggestions   |
|---|---|
| Transmission Verification Report says RESULT:ERROR. | <p>There is probably temporary noise or static on the line. Try sending the fax again. If you are sending a PC-Fax message and get RESULT:ERROR on the Transmission Verification Report, your machine may be out of memory. To free up extra memory, you can turn off Fax Storage, print fax messages in memory or cancel a delayed fax. If the problem continues, ask the telephone company to check your telephone line.</p> <p>If you often get transmission errors due to possible interference on the telephone line or if you are using a VoIP system, try changing the Compatibility setting to Basic(for VoIP).</p> |
| Sent faxes are blank.                               | Make sure you are loading the document correctly. When using the ADF, the document should be face up. When using the scanner glass, the document should be face down.   |
| Vertical black lines when sending.                  | Black vertical lines on faxes you send are typically caused by dirt or correction fluid on the glass strip. Clean the glass strip.  |

## Printing received faxes

| Difficulties   | Suggestions  |
|--|--|
| <ul style="list-style-type: none"> <li>• Condensed print</li> <li>• Horizontal streaks</li> <li>• Top and bottom sentences are cut off</li> <li>• Missing lines</li> </ul>  | <p>This is usually caused by a poor telephone connection. Make a copy; if your copy looks good, you probably had a bad connection, with static or interference on the telephone line. Ask the other party to send the fax again.</p>                         |
| Vertical black lines when receiving  | <p>The corona wire for printing may be dirty. Clean the corona wire in the drum unit.</p> <p>The sender's scanner may be dirty. Ask the sender to make a copy to see if the problem is with the sending machine. Try receiving from another fax machine.</p> |
| Received faxes appear as split or blank pages.   | <p>Left and right margins are cut off or a single page is printed on two pages.</p> <p>Turn on Auto Reduction.</p>   |



### Related Information

- [Troubleshooting](#)
- [Set Dial Tone Detection](#)
- [Set Telephone Line Compatibility for Interference and VoIP Systems](#)

## Set Dial Tone Detection

**Related Models:** DocuPrint M235 z/DocuPrint M275 z/DocuPrint M285 z

Setting the Dial Tone to [Detection] will shorten the Dial Tone detect pause.



>> [DocuPrint M235 z](#)

>> [DocuPrint M275 z/DocuPrint M285 z](#)

### DocuPrint M235 z

1. Press **Menu**.
2. Press **▲** or **▼** to display the [Initial Setup] option, and then press **OK**.
3. Press **▲** or **▼** to display the [Dial Tone] option, and then press **OK**.
4. Press **▲** or **▼** to choose the [Detection] or [No Detection], and then press **OK**.
5. Press **Stop/Exit**.

### DocuPrint M275 z/DocuPrint M285 z

1. Press  [Settings] > [All Settings] > [Initial Setup] > [Dial Tone].
2. Press [Detection] or [No Detection].
3. Press .

### Related Information

- [Telephone and Fax Problems](#)

## Set Telephone Line Compatibility for Interference and VoIP Systems

**Related Models:** DocuPrint M235 z/DocuPrint M275 z/DocuPrint M285 z

Problems sending and receiving faxes due to possible interference on the telephone line may be solved by reducing the modem speed to minimise errors in fax transmission. If you are using a Voice over IP (VoIP) service, Fuji Xerox recommends changing the compatibility to Basic (for VoIP).



- VoIP is a type of phone system that uses an Internet connection, rather than a traditional phone line.
- Telephone providers frequently bundle VoIP together with Internet and cable services.
- Fuji Xerox does not recommend the use of a VoIP line. VoIP limitations in general can cause some functions of the fax machine not to work correctly.

>> [DocuPrint M235 z](#)

>> [DocuPrint M275 z/DocuPrint M285 z](#)

### DocuPrint M235 z

1. Press **Menu**.
2. Press **▲** or **▼** to display the [Initial Setup] option, and then press **OK**.
3. Press **▲** or **▼** to display the [Compatibility] option, and then press **OK**.
4. Press **▲** or **▼** to display the [High], [Normal], or [Basic (for VoIP)] option, and then press **OK**.

| Option           | Description   |
|------------------|---|
| High             | Select <b>High</b> to set the modem speed at 33600 bps.   |
| Normal           | Select <b>Normal</b> to set the modem speed at 14400 bps.   |
| Basic (for VoIP) | Select <b>Basic (for VoIP)</b> to reduce the modem speed to 9600 bps and turn off Error Correction Mode (ECM). Unless interference is a recurring problem on your telephone line, you may prefer to use it only when needed.<br><br>To improve compatibility with most VoIP services, Fuji Xerox recommends changing the compatibility setting to <b>Basic (for VoIP)</b> . |

5. Press **Stop/Exit**.

### DocuPrint M275 z/DocuPrint M285 z

1. Press  [Settings] > [All Settings] > [Initial Setup] > [Compatibility].
2. Press [High], [Normal] or [Basic (for VoIP)].

| Option           | Description   |
|------------------|---|
| High             | Select <b>High</b> to set the modem speed at 33600 bps.   |
| Normal           | Select <b>Normal</b> to set the modem speed at 14400 bps.   |
| Basic (for VoIP) | Select <b>Basic (for VoIP)</b> to reduce the modem speed to 9600 bps and turn off Error Correction Mode (ECM). Unless interference is a recurring problem on your telephone line, you may prefer to use it only when needed.<br><br>To improve compatibility with most VoIP services, Fuji Xerox recommends changing the compatibility setting to <b>Basic (for VoIP)</b> . |

---

3. Press .



### Related Information

- [Telephone and Fax Problems](#)
-

## Network Problems

- [Error Messages for Network Problems](#)
- [Where Can I Find My Fuji Xerox Machine's Network Settings?](#)
- [I Cannot Complete the Wireless Network Setup Configuration](#)
- [My Fuji Xerox Machine Cannot Print, Scan, or PC-FAX Receive over the Network](#)
- [I Want to Check that My Network Devices are Working Correctly](#)

## Error Messages for Network Problems

Your Fuji Xerox machine will display an error message if an error occurs. The most common error messages are shown in the chart.

### DocuPrint M235 dw/DocuPrint M235 z

| Error Messages                                   | Cause  | Action   |
|--|--|--|
| Cannot Connect<br>A device is already connected. | Two mobile devices are already connected to the Wi-Fi Direct network when the Fuji Xerox machine is the Group Owner (G/O). | After the current connection between your Fuji Xerox machine and another mobile device has shut down, try to configure the Wi-Fi Direct settings again. You can confirm the connection status by printing the Network Configuration Report.  |
| Connection Error                                 | Other devices are trying to connect to the Wi-Fi Direct network at the same time.  | Make sure there are no other devices trying to connect to the Wi-Fi Direct network, and then try to configure the Wi-Fi Direct settings again.   |
| Connection Fail                                  | The Fuji Xerox machine and your mobile device cannot communicate during the Wi-Fi Direct network configuration.            | <ul style="list-style-type: none"> <li>• Move the mobile device closer to your Fuji Xerox machine.</li> <li>• Move your Fuji Xerox machine and the mobile device to an obstruction-free area.</li> <li>• If you are using the PIN Method of WPS, make sure you have entered the correct PIN.</li> </ul>  |
| No Device  | When configuring the Wi-Fi Direct network, the Fuji Xerox machine cannot find your mobile device.                          | <ul style="list-style-type: none"> <li>• Make sure your machine and mobile device are in the Wi-Fi Direct mode.</li> <li>• Move the mobile device closer to your Fuji Xerox machine.</li> <li>• Move your Fuji Xerox machine and the mobile device to an obstruction-free area.</li> <li>• If you are manually configuring the Wi-Fi Direct network, make sure you have entered the correct password.</li> <li>• If your mobile device has a configuration page for how to obtain an IP address, make sure the IP address of your mobile device has been configured via DHCP.</li> </ul> |

### DocuPrint M275 z/DocuPrint M285 z

| Error Messages                             | Cause  | Action  |
|--|--|---|
| A device is already connected. Press [OK]. | Two mobile devices are already connected to the Wi-Fi Direct network when the Fuji Xerox machine is the Group Owner (G/O). | After the current connection between your Fuji Xerox machine and another mobile device has shut down, try to configure the Wi-Fi Direct settings again. You can confirm the connection status by printing the Network Configuration Report.   |
| Connection Error                           | Other devices are trying to connect to the Wi-Fi Direct network at the same time.  | Make sure there are no other devices trying to connect to the Wi-Fi Direct network, and then try to configure the Wi-Fi Direct settings again.  |
| Connection Failed                          | The Fuji Xerox machine and your mobile device cannot communicate during the Wi-Fi Direct network configuration.            | <ul style="list-style-type: none"> <li>• Move the mobile device closer to your Fuji Xerox machine.</li> <li>• Move your Fuji Xerox machine and the mobile device to an obstruction-free area.</li> <li>• If you are using the PIN Method of WPS, make sure you have entered the correct PIN.</li> </ul> |

| Error Messages                                 | Cause   | Action   |
|--|---|--|
| No Device                                      | When configuring the Wi-Fi Direct network, the Fuji Xerox machine cannot find your mobile device.                                   | <ul style="list-style-type: none"> <li>• Make sure your machine and mobile device are in the Wi-Fi Direct mode.</li> <li>• Move the mobile device closer to your Fuji Xerox machine.</li> <li>• Move your Fuji Xerox machine and the mobile device to an obstruction-free area.</li> <li>• If you are manually configuring the Wi-Fi Direct network, make sure you have entered the correct password.</li> <li>• If your mobile device has a configuration page for how to obtain an IP address, make sure the IP address of your mobile device has been configured via DHCP.</li> </ul> |
| Wrong Date & Time, contact your administrator. | The Fuji Xerox machine does not obtain the time from the SNTP time server or you have not configured the Date&Time for the machine. | <ul style="list-style-type: none"> <li>• Make sure the settings to access the SNTP time server are configured correctly in Web Based Management.</li> <li>• Confirm the <b>Date&amp;Time</b> settings of your machine are correct in Web Based Management.</li> </ul>  |



## Related Information

- [Network Problems](#)



## Where Can I Find My Fuji Xerox Machine's Network Settings?

- [Print the Network Configuration Report](#)
- [Change Machine Settings from Your Computer](#)

## I Cannot Complete the Wireless Network Setup Configuration

Turn your wireless router off and back on. Then try to configure the wireless settings again. If you are unable to resolve the problem, follow the instructions below:

Investigate the problem using the WLAN Report.

| Cause  | Action  | Interface    |
|--|---|--------------|
| Your security settings (SSID/ Network Key) are not correct.  | <ul style="list-style-type: none"> <li>• Select and confirm that you are using the correct security settings.                             <ul style="list-style-type: none"> <li>- See the instructions supplied with your wireless LAN access point/router for information on how to find the security settings.</li> <li>- The manufacturer's name or model number of the wireless LAN access point/router may be used as the default security settings.</li> <li>- Consult with the access point/router manufacturer, your Internet provider, or network administrator.</li> </ul> </li> </ul> | Wireless     |
| Your Fuji Xerox machine's MAC address is not allowed.  | Confirm that the Fuji Xerox machine's MAC Address is allowed in the filter. You can find the MAC Address on your Fuji Xerox machine's control panel.  | Wireless     |
| Your wireless LAN access point/router is in stealth mode (not broadcasting the SSID).  | <ul style="list-style-type: none"> <li>• Enter the correct SSID name or Network Key manually.</li> <li>• Check the SSID name or the Network Key in the instructions supplied with your wireless LAN access point/router and reconfigure the wireless network setup.</li> </ul>  | Wireless     |
| Your security settings (SSID/ password) are not correct.   | <ul style="list-style-type: none"> <li>• Confirm the SSID and password.                             <ul style="list-style-type: none"> <li>- When you are configuring the network manually, the SSID and password are displayed on your Fuji Xerox machine. If your mobile device supports the manual configuration, the SSID and password will be displayed on your mobile device's screen.</li> </ul> </li> </ul>   | Wi-Fi Direct |
| You are using Android™ 4.0.  | If your mobile device disconnects (approximately six minutes after using Wi-Fi Direct), try the one-push configuration using WPS (recommended) and set the Fuji Xerox machine as a G/O.   | Wi-Fi Direct |
| Your Fuji Xerox machine is placed too far from your mobile device.   | Move your Fuji Xerox machine within about 3.3 feet (1 metre) of the mobile device when you configure the Wi-Fi Direct network settings.   | Wi-Fi Direct |
| There are some obstructions (walls or furniture, for example) between your machine and the mobile device.  | Move your Fuji Xerox machine to an obstruction-free area.   | Wi-Fi Direct |
| There is a wireless computer, Bluetooth®-supported device, microwave oven, or digital cordless phone near the Fuji Xerox machine or the mobile device. | Move other devices away from the Fuji Xerox machine or the mobile device.   | Wi-Fi Direct |
| If you have checked and tried all of the above, but still cannot complete the Wi-Fi Direct configuration, do the following:                            | <ul style="list-style-type: none"> <li>• Turn your Fuji Xerox machine off and back on. Then try to configure the Wi-Fi Direct settings again.</li> <li>• If you are using your Fuji Xerox machine as a client, confirm how many devices are allowed in the current Wi-Fi Direct network, and then check how many devices are connected.</li> </ul>  | Wi-Fi Direct |





## Related Information

- [Network Problems](#)
- [Configure Your Machine for a Wireless Network When the SSID Is Not Broadcast](#)
- [Use Wi-Fi Direct<sup>®</sup>](#)

## My Fuji Xerox Machine Cannot Print, Scan, or PC-FAX Receive over the Network

| Cause   | Action   | Interface      |
|---|--|----------------|
| Your security software blocks your machine's access to the network. (The Network scanning feature does not work. )                    | <ul style="list-style-type: none"> <li>• Windows®<br/>Configure the third-party Security/Firewall Software to allow Network scanning. To add port 54925 for Network scanning, type the information below:                             <ul style="list-style-type: none"> <li>- In <b>Name</b>:<br/>Type any description, for example Fuji Xerox NetScan.</li> <li>- In <b>Port number</b>:<br/>Type 54925.</li> <li>- In <b>Protocol</b>:<br/>UDP is selected.</li> </ul>                             See the instruction manual that came with your third-party Security/Firewall Software or contact the software manufacturer.                         </li> <li>• Mac<br/>(iPrint&amp;Scan)<br/>In the <b>Finder</b> menu bar, click <b>Go &gt; Applications &gt; Fuji Xerox</b>, and then double-click the iPrint&amp;Scan icon. The iPrint&amp;Scan window appears. Click the <b>Select your Machine</b> button, and then follow the on-screen instructions to reselect your network machine. (TWAIN driver)<br/>In the <b>Finder</b> menu bar, click <b>Go &gt; Applications &gt; Fuji Xerox &gt; TWAIN Driver Utility</b>, and then double-click the Device Selector icon. The Device Selector window appears. Reselect your network machine, make sure <b>Status</b> is <b>idle</b>, and then click <b>OK</b>.</li> </ul> | Wired/Wireless |
| Your security software blocks your machine's access to the network. (The network PC-Fax Receive feature does not work.)<br>(Windows®) | <p>Set the third-party Security/Firewall Software to allow PC-FAX Rx. To add port 54926 for Network PC-FAX Rx, type the information below:</p> <ul style="list-style-type: none"> <li>• In <b>Name</b>:<br/>Type any description, for example Fuji Xerox PC-FAX Rx.</li> <li>• In <b>Port number</b>:<br/>Type 54926.</li> <li>• In <b>Protocol</b>:<br/>UDP is selected.</li> </ul> <p>See the instruction manual that came with your third-party Security/Firewall Software or contact the software manufacturer.</p>  | Wired/Wireless |
| Your security software blocks your machine's access to the network.   | <p>Some security software might block access without showing a security alert dialog box even after successful installation.</p> <p>To allow access, see the instructions for your security software or ask the software manufacturer.</p>   | Wired/Wireless |
| Your Fuji Xerox machine was not assigned an available IP address.   | <ul style="list-style-type: none"> <li>• Confirm the IP address and the Subnet Mask.<br/>Verify that both the IP addresses and Subnet Masks of your computer and the Fuji Xerox machine are correct and located on the same network.<br/>For more information about how to verify the IP address and the Subnet Mask, ask your network administrator.</li> </ul>   | Wired/Wireless |
| The failed print job is still in your computer's print queue.   | <ul style="list-style-type: none"> <li>• If the failed print job is still in your computer's print queue, delete it.</li> <li>• Otherwise, double-click the printer icon in the following folder and cancel all documents:                             <ul style="list-style-type: none"> <li>- Windows® 7</li> </ul> </li> </ul>  | Wired/Wireless |

| Cause   | Action   | Interface |
|---|--|-----------|
|   | <p>Click  (<b>Start</b>) &gt; <b>Devices and Printers</b> &gt; <b>Printers and Faxes</b>.</p> <ul style="list-style-type: none"> <li>- Windows® 8<br/>Move your mouse to the lower right corner of your desktop. When the menu bar appears, click <b>Settings</b> &gt; <b>Control Panel</b>. In the <b>Hardware and Sound</b> group, click <b>View devices and printers</b> &gt; <b>Printers</b>.</li> <li>- Windows® 10 and Windows Server® 2016<br/>Click  &gt; <b>Windows System</b> &gt; <b>Control Panel</b>. In the <b>Hardware and Sound</b> group, click <b>View devices and printers</b> &gt; <b>Printers</b>.</li> <li>- Windows Server® 2008<br/>Click <b>Start</b> &gt; <b>Control Panel</b> &gt; <b>Printers</b>.</li> <li>- Windows Server® 2012<br/>Move your mouse to the lower right corner of your desktop. When the menu bar appears, click <b>Settings</b> &gt; <b>Control Panel</b>. In the <b>Hardware</b> group, click <b>View devices and printers</b> &gt; <b>Printers</b>.</li> <li>- Windows Server® 2012 R2<br/>Click <b>Control Panel</b> on the <b>Start</b> screen. In the <b>Hardware</b> group, click <b>View devices and printers</b>.</li> <li>- macOS v10.11.x, v10.12.x, v10.13.x<br/>Click <b>System Preferences</b> &gt; <b>Printers &amp; Scanners</b>.</li> </ul> |           |
| Your Fuji Xerox machine is not connected to the wireless network. | Print the WLAN Report to check the error code on the printed report.   | Wireless  |

If you have checked and tried all of the above, but your Fuji Xerox machine still cannot print and scan, uninstall the Fuji Xerox software and drivers and reinstall them.



### Related Information

- [Network Problems](#)
- [Print the WLAN Report](#)
- [Wireless LAN Report Error Codes](#)
- [I Want to Check that My Network Devices are Working Correctly](#)

## I Want to Check that My Network Devices are Working Correctly

| Check  | Action  | Interface      |
|--|---|----------------|
| Check that your Fuji Xerox machine, access point/router, or network hub is turned on.          | <p><b>Check the following:</b></p> <ul style="list-style-type: none"> <li>The power cord is connected correctly and the Fuji Xerox machine is turned on.</li> <li>The access point/router or hub is turned on and its link button is blinking.</li> <li>All protective packaging has been removed from the machine.</li> <li>The toner cartridge and drum unit are installed correctly.</li> <li>The front and back covers are fully closed.</li> <li>Paper is inserted correctly in the paper tray.</li> <li>(For wired networks) A network cable is securely connected to the Fuji Xerox machine and to the router or hub.</li> </ul> | Wired/Wireless |
| Check the <b>Link Status</b> in the Network Configuration Report or the Printer Settings page. | Print the Network Configuration Report and check that <b>Ethernet Link Status</b> or <b>Wireless Link Status</b> is <b>Link OK</b> .  | Wired/Wireless |
| Check that you can "ping" the Fuji Xerox machine from your computer.                           | <p>Ping the Fuji Xerox machine from your computer using the IP address or the node name in the Windows® command prompt or Mac Terminal application:</p> <p>ping &lt;ipaddress&gt; or &lt;nodename&gt;.</p> <ul style="list-style-type: none"> <li>Successful: Your Fuji Xerox machine is working correctly and connected to the same network as your computer.</li> <li>Unsuccessful: Your Fuji Xerox machine is not connected to the same network as your computer.</li> </ul> <p>Confirm that the IP address and the Subnet Mask are set correctly.</p>   | Wired/Wireless |
| Check that your Fuji Xerox machine is connected to the wireless network.                       | Print the WLAN Report to check the error code on the printed report.  | Wireless       |

If you have checked and tried all of the above but you are still having problems, see the instructions supplied with your wireless LAN access point/router to find the SSID and the Network Key information and set them correctly.

### Related Information

- [Network Problems](#)
- [Print the Network Configuration Report](#)
- [Print the WLAN Report](#)
- [Wireless LAN Report Error Codes](#)
- [My Fuji Xerox Machine Cannot Print, Scan, or PC-FAX Receive over the Network](#)

## Google Cloud Print Problems

| Difficulty   | Suggestions   |
|--|---|
| My Fuji Xerox machine is not displayed in the printer list.  | Make sure your machine is turned on.  |
|  | Confirm that Google Cloud Print™ is enabled.  |
|  | Confirm that your machine is registered with Google Cloud Print™. If it is not registered, try to register again. |
| I cannot print.  | Make sure your machine is turned on.  |
|  | Confirm your network settings. See <i>Related Information</i> .   |
|  | Certain files may not be printable, or may not appear exactly as they are displayed.                              |
| I cannot register my Fuji Xerox machine with Google Cloud Print™.  | Make sure your machine is connected to a network with Internet access.  |
|  | Verify that the date and time are set correctly on your machine.  |
| I do not see a confirmation message on my Fuji Xerox machine when I try to register with Google Cloud Print™, even after repeating the registration steps. | Make sure your Fuji Xerox machine is idle while you are registering with Google Cloud Print™.                     |



### Related Information

- [Troubleshooting](#)
- [Network Settings for Using Google Cloud Print](#)

## AirPrint Problems

| Difficulty   | Suggestions   |
|--|---|
| My Fuji Xerox machine is not displayed in the printer list.  | Make sure your Fuji Xerox machine is turned on.   |
|  | Confirm the network settings. See <i>Related Information</i> .  |
|  | Move the mobile device closer to the wireless access point/router, or to your Fuji Xerox machine.   |
| I cannot print.  | Make sure your Fuji Xerox machine is turned on.   |
|  | Confirm the network settings. See <i>Related Information</i> .  |
| I am trying to print a multiple-page document from an iOS device, but ONLY the first page is printing. | Make sure you are running the latest OS version.<br>Refer to the following Apple support article for more information about AirPrint: <a href="https://support.apple.com/kb/HT4356">support.apple.com/kb/HT4356</a> . |







### Related Information

- [Troubleshooting](#)
- [AirPrint Overview](#)



## Other Problems

| Difficulties  | Suggestions   |
|---|---|
| The machine will not turn on.   | <p>Adverse conditions on the power connection (such as lightning or a power surge) may have triggered the machine's internal safety mechanisms. Unplug the power cord. Wait for ten minutes, then plug in the power cord and press  to turn on the machine.</p> <p>If the problem is not solved and you are using a power breaker, disconnect it to make sure it is not the problem. Plug the machine's power cord directly into a different known working wall electrical socket. If there is still no power, try a different power cable.</p>  |
| The machine cannot print EPS data that includes binary with the PS3 emulate printer driver. | <p><b>(Windows®)</b></p> <p>To print EPS data, do the following:</p> <ol style="list-style-type: none"> <li>For Windows® 7 and Windows Server® 2008 R2:<br/>Click the  <b>Start</b> button &gt; <b>Devices and Printers</b>.<br/>For Windows Server® 2008:<br/>Click the  <b>Start</b> button &gt; <b>Devices and Printers</b>.<br/>For Windows® 8 and Windows Server® 2012:<br/>Move your mouse to the lower right corner of your desktop. When the menu bar appears, click <b>Settings</b> &gt; <b>Control Panel</b>. In the <b>Hardware and Sound</b><sup>1</sup> group, click <b>View devices and printers</b>.<br/>For Windows® 10 and Windows Server® 2016:<br/>Click  &gt; <b>Windows System</b> &gt; <b>Control Panel</b>. In the <b>Hardware and Sound</b> group, click <b>View devices and printers</b>.<br/>For Windows Server® 2012 R2:<br/>Click <b>Control Panel</b> on the <b>Start</b> screen. In the <b>Hardware</b> group, click <b>View devices and printers</b>.</li> <li>Right-click the <b>FX DocuPrint XXXXX PS3 emulate</b> icon, select <b>Printer properties</b>.</li> <li>From the <b>Device Settings</b> tab, choose TBCP (Tagged binary communication protocol) in <b>Output Protocol</b>.</li> </ol> |
| The Fuji Xerox software cannot be installed.  | <p><b>(Windows®)</b></p> <p>If the Security Software warning appears on the computer screen during the installation, change the Security Software settings to permit the Fuji Xerox product setup program or other program to run.</p> <p><b>(Mac)</b></p> <p>If you are using a firewall function of anti-spyware or antivirus security software, temporarily disable it and then install the Fuji Xerox software.</p>   |

<sup>1</sup> For Windows Server® 2012: **Hardware and Sound**

### Copying difficulties

| Difficulties        | Suggestions   |
|---------------------|---|
| Cannot make a copy. | Make sure you pressed Copy and the machine is in Copy mode. |

| Difficulties                           | Suggestions  |
|--|--|
|  | Contact your administrator to check your Secure Function Lock Settings.  |
| Vertical black line appears in copies. | Black vertical lines on copies are typically caused by dirt or correction fluid on the glass strip, or the corona wire is dirty. Clean the glass strip and scanner glass and the white bar and white plastic above them. |
| Copies are blank.                      | Make sure you are loading the document correctly.  |

## Scanning difficulties

| Difficulties   | Suggestions  |
|--|--|
| TWAIN or Windows Image Acquisition (WIA) errors appear when starting to scan. (Windows®) | Make sure the Fuji Xerox TWAIN or Windows Image Acquisition (WIA) driver is selected as the primary source in your scanning application. For example, in Nuance™ PaperPort™ 14SE, click <b>Desktop &gt; Scan Settings &gt; Select</b> to choose the Fuji Xerox TWAIN/Windows Image Acquisition (WIA) driver. |
| TWAIN errors appear when starting to scan. (Mac)   | Make sure the Fuji Xerox TWAIN driver is selected as the primary source.   |
| OCR does not work.   | Try increasing the scanning resolution.  |
| Cannot scan.   | Contact your administrator to check your Secure Function Lock Settings.  |

## Software difficulties

| Difficulties                      | Suggestions  |
|-----------------------------------|--|
| Cannot install software or print. | (Windows® )<br>Run the install program again. This program will repair and reinstall the software. |



### Related Information

- [Troubleshooting](#)

## Transfer Your Faxes or Fax Journal Report

**Related Models:** DocuPrint M235 z/DocuPrint M275 z/DocuPrint M285 z

If the LCD displays:

- [Print Unable] ##
- [Scan Unable] ##

We recommend transferring your faxes to another fax machine or to your computer.

You can also transfer the Fax Journal report to see if there are any faxes you must transfer.



If there is an error message on the LCD after you transfer the faxes, disconnect your Fuji Xerox machine from the power source for several minutes, and then reconnect it.



### Related Information

- [Troubleshooting](#)
- [Transfer Faxes to Another Fax Machine](#)
- [Transfer Faxes to Your Computer](#)
- [Transfer the Fax Journal Report to Another Fax Machine](#)

## Transfer Faxes to Another Fax Machine

**Related Models:** [DocuPrint M235 z](#)/[DocuPrint M275 z](#)/[DocuPrint M285 z](#)

If you have not set up your Station ID, you cannot enter Fax Transfer mode.

>> [DocuPrint M235 z](#)

>> [DocuPrint M275 z/DocuPrint M285 z](#)

### DocuPrint M235 z

1. Press **Menu**.
2. Press **▲** or **▼** to display the [Service] option, and then press **OK**.
3. Press **OK** to select [Data Transfer].
4. Press **▲** or **▼** to display the [Fax Transfer] option, and then press **OK**.
5. Do one of the following:
  - If the LCD shows [No Data], there are no faxes left in the machine's memory. Press **Stop/Exit**.
  - Enter the fax number to which faxes will be forwarded. Press **Start**.

### DocuPrint M275 z/DocuPrint M285 z

1. Press  [Settings] > [All Settings] > [Service] > [Data Transfer] > [Fax Transfer].
2. Do one of the following:
  - If the LCD shows [No Data], there are no faxes left in the machine's memory. Press [Close].
  - Enter the fax number to which faxes will be forwarded.
3. Press [Fax Start].

### Related Information

- [Transfer Your Faxes or Fax Journal Report](#)
- [Set Your Station ID](#)

## Transfer Faxes to Your Computer

**Related Models:** DocuPrint M235 z/DocuPrint M275 z/DocuPrint M285 z

>> [DocuPrint M235 z](#)

>> [DocuPrint M275 z/DocuPrint M285 z](#)

### DocuPrint M235 z

1. Make sure you have installed the software and drivers on your computer, and then turn on **PC-FAX Receive** on the computer.

Do one of the following:

- (Windows® 7)

From the  (**Start**) menu, select **All Programs > Fuji Xerox > Fuji Xerox Utilities**.

Click the drop-down list and select your model name (if not already selected). Click **PC-FAX** in the left navigation bar, and then click **Receive**.

- (Windows® 8 and Windows® 10)

Click  (**Fuji Xerox Utilities**), and then click the drop-down list and select your model name (if not already selected). Click **PC-FAX** in the left navigation bar, and then click **Receive**.

2. Make sure you have set [PC Fax Receive] on the machine.

If faxes are in the machine's memory when you set up PC-Fax Receive, the LCD displays [Send Fax to PC?].

3. Press the options in the following table to transfer the fax to your computer.

| Option | Description   |
|--------|---|
| ▲      | Select On or Off for the Backup print setting.<br>The machine transfers all faxes to your computer. |
| ▼      | Select On or Off for the Backup print setting.<br>The PC-Fax setting turns On.                      |

4. Press **Stop/Exit**.

### DocuPrint M275 z/DocuPrint M285 z

1. Make sure you have installed the software and drivers on your computer, and then turn on **PC-FAX Receive** on the computer.

Do one of the following:

- (Windows® 7)

From the  (**Start**) menu, select **All Programs > Fuji Xerox > Fuji Xerox Utilities**.

Click the drop-down list and select your model name (if not already selected). Click **PC-FAX** in the left navigation bar, and then click **Receive**.

- (Windows® 8 and Windows® 10)

Click  (**Fuji Xerox Utilities**), and then click the drop-down list and select your model name (if not already selected). Click **PC-FAX** in the left navigation bar, and then click **Receive**.

2. Make sure you have set [PC Fax Receive] on the machine.

If faxes are in the machine's memory when you set up PC-Fax Receive, the LCD displays [Send Fax to PC?].

---

3. Do one of the following:

- To select On or Off for the backup print setting, press [Yes].
- To turn on PC-Fax, press [No].

4. Press .



### Related Information

- [Transfer Your Faxes or Fax Journal Report](#)
-

## Transfer the Fax Journal Report to Another Fax Machine

**Related Models:** [DocuPrint M235 z](#)/[DocuPrint M275 z](#)/[DocuPrint M285 z](#)

If you have not set up your Station ID, you cannot enter fax transfer mode.

>> [DocuPrint M235 z](#)

>> [DocuPrint M275 z/DocuPrint M285 z](#)

### DocuPrint M235 z

1. Press **Menu**.
2. Press **▲** or **▼** to display the [Service] option, and then press **OK**.
3. Press **OK** to select [Data Transfer].
4. Press **▲** or **▼** to display the [Report Trans.] option, and then press **OK**.
5. Enter the destination fax number for the Fax Journal.
6. Press **Start**.

### DocuPrint M275 z/DocuPrint M285 z

1. Press  [Settings] > [All Settings] > [Service] > [Data Transfer] > [Report Transfer].
2. Enter the destination fax number for the Fax Journal.
3. Press [Fax Start].

### Related Information

- [Transfer Your Faxes or Fax Journal Report](#)
- [Set Your Station ID](#)

## Machine Information

- [Check the Serial Number](#)
- [Check the Firmware Version](#)
- [Reset Functions Overview](#)
- [Reset Your Fuji Xerox Machine](#)



## Check the Serial Number



>> [DocuPrint M235 dw/DocuPrint M235 z](#)

>> [DocuPrint M275 z/DocuPrint M285 z](#)

### DocuPrint M235 dw/DocuPrint M235 z

1. Press **Menu**.
2. Press **▲** or **▼** to display the [Machine Info.] option, and then press **OK**.
3. Press **▲** or **▼** to display the [Serial No.] option, and then press **OK**.  
The machine displays the serial number on the LCD.
4. Press **Stop/Exit**.

### DocuPrint M275 z/DocuPrint M285 z

1. Press  [Settings] > [All Settings] > [Machine Info.] > [Serial No.].  
The machine displays the serial number on the LCD.
2. Press .

### Related Information

- [Machine Information](#)

## Check the Firmware Version



>> [DocuPrint M235 dw/DocuPrint M235 z](#)

>> [DocuPrint M275 z/DocuPrint M285 z](#)

### DocuPrint M235 dw/DocuPrint M235 z

1. Press **Menu**.
2. Press **▲** or **▼** to display the [Machine Info.] option, and then press **OK**.
3. Press **▲** or **▼** to display the [Version] option, and then press **OK**.  
The machine displays the firmware version on the LCD.
4. Press **Stop/Exit**.

### DocuPrint M275 z/DocuPrint M285 z

1. Press  [Settings] > [All Settings] > [Machine Info.] > [Firmware Version].  
The machine displays the firmware version on the LCD.
2. Press .

### Related Information

- [Machine Information](#)

## Reset Functions Overview

The following reset functions are available:



Unplug the interface cable before you choose Network Settings Reset function, All Settings Reset function or Factory Reset function.

### DocuPrint M235 dw/DocuPrint M235 z



Subdivided reset functions are not available for some models.

#### 1. Machine Reset

This function resets the following settings:

- Programmed fax jobs in the memory (For DocuPrint M235 z)  
(Delayed Fax, Batch TX)
- Coverpage Message (For DocuPrint M235 z)
- Remote Fax Options (For DocuPrint M235 z)  
(Remote Access Code, Fax Storage, Fax Forwarding, PC-Fax Send, and PC-Fax Receive (Windows® only))
- Setting Lock (For DocuPrint M235 z)
- Language Setting

#### 2. Network Settings Reset (For DocuPrint M235 dw/DocuPrint M235 z)

Reset the print server back to its default factory settings (includes Password and IP Address information).

#### 3. Address Book and Fax Settings Reset (For DocuPrint M235 z)

This function resets the following settings:

- Address Book  
(One Touch Dial / Speed Dial / Setup Groups)
- Programmed fax jobs in the memory
- Station ID  
(name and number)
- Coverpage Message
- Remote Fax Options  
(Remote Access Code, Fax Storage, Fax Forwarding, and PC-Fax Receive (Windows® only))
- Report  
(Transmission Verification Report/ Tel Index List/Fax Journal)
- Setting Lock password

#### 4. All Settings Reset

You can reset all the machine's settings back to the settings that were set at the factory.

All Settings Reset takes less time than Factory Reset.

#### 5. Factory Reset

Use the All Settings Reset function to reset all machine's settings to the settings originally set at the factory.

Factory Reset takes more time than All Settings Reset.

Fuji Xerox strongly recommends you perform this operation when you dispose of the machine.



Unplug the interface cable before you choose Network Settings Reset function, All Settings Reset function or Factory Reset function.

---

## DocuPrint M275 z/DocuPrint M285 z

### 1. Machine Reset

You can reset all the machine's settings that you have changed, such as Date and Time and Ring Delay. The Address Book, fax reports, and Call history will remain. (For DocuPrint M275 z/DocuPrint M285 z)

### 2. Network Settings Reset (For DocuPrint M275 z/DocuPrint M285 z)

Reset the print server back to its default factory settings (includes Password and IP Address information).

### 3. Address Book and Fax Settings Reset (For DocuPrint M275 z/DocuPrint M285 z)

This function resets the following settings:

- Address Book  
(Addresses and Groups)
- Programmed fax jobs in the memory
- Station ID  
(name and number)
- Coverpage Message
- Remote Fax Options  
(Remote Access Code, Fax Storage, Fax Forwarding, PC-Fax Send, and PC-Fax Receive (Windows® only))
- Report  
(Transmission Verification Report/ Tel Index List/Fax Journal)
- Setting Lock password

### 4. All Settings Reset

You can reset all the machine's settings back to the settings that were set at the factory.

All Settings Reset takes less time than Factory Reset.

### 5. Factory Reset

Use the All Settings Reset function to reset all machine's settings to the settings originally set at the factory.

Factory Reset takes more time than All Settings Reset.

Fuji Xerox strongly recommends you perform this operation when you dispose of the machine.



Unplug the interface cable before you choose Network Settings Reset function, All Settings Reset function or Factory Reset function.

---

## Related Information

- [Machine Information](#)
-

## Reset Your Fuji Xerox Machine

>> [DocuPrint M235 dw/DocuPrint M235 z](#)

>> [DocuPrint M275 z/DocuPrint M285 z](#)

### DocuPrint M235 dw/DocuPrint M235 z

1. Press **Menu**.
2. Press **▲** or **▼** to display the [Initial Setup] option, and then press **OK**.
3. Press **▲** or **▼** to display the [Reset] option, and then press **OK**.
4. Press **▲** or **▼** to choose the type of reset you want to perform, and then press **OK**.



Subdivided reset functions are not available for some models.

5. Press the option in the table to reset the machine or to exit the process.

| Option | Description                                      |
|--------|--|
| ▲      | Reset the machine.                               |
| ▼      | The machine will exit and cancel the reset menu. |

The LCD displays [Reboot OK?].

6. Press the option in the table to reboot the machine or to exit the process.

| Option | Description   |
|--------|---|
| ▲      | Reboot the machine. The machine will begin the reset. |
| ▼      | The machine will exit without rebooting.              |



If you do not reboot your machine, the reset process will not finish and your settings will remain unchanged.

### DocuPrint M275 z/DocuPrint M285 z

1. Press  [Settings] > [All Settings] > [Initial Setup] > [Reset].
2. Press **▲** or **▼** to display the type of reset functions, and then press the reset function you want to use.  
The LCD displays [Machine will reboot after resetting. Press [OK] for 2 seconds to confirm.].
3. Press the option in the table to reboot the machine or to exit the process.

| Option                          | Description   |
|---------------------------------|---|
| Press <b>OK</b> for two seconds | Reboot the machine. The machine will begin the reset. |
| Cancel                          | The machine will exit without rebooting.              |



If you do not reboot your machine, the reset process will not finish and your settings will remain unchanged.

4. Press .



You can also reset the Network settings by pressing  [Settings] > [All Settings] > [Network] > [Network Reset].



## Related Information

- [Machine Information](#)
-

## **Routine Maintenance**

- [Replace Supplies](#)
- [Clean the Machine](#)
- [Check the Remaining Part Life](#)

## Replace Supplies

You must replace supplies when the machine indicates that the life of the supply is over.

Using non-Fuji Xerox supplies may affect the print quality, hardware performance, and machine reliability. The toner cartridge and drum unit are two separate supplies. Make sure both are installed as an assembly. The model name of supplies may vary depending on the country.

### NOTE

- Contact your local Fuji Xerox office for further details.
- Be sure to seal up the used supplies tightly in a bag so that toner powder does not spill out of the cartridge.
- Discard used consumable items according to local regulations, keeping it separate from domestic waste. If you have questions, call your local waste disposal office. Be sure to reseal the consumable items tightly so that the material inside does not spill.
- We recommend placing used and new supplies on a piece of paper to prevent accidentally spilling or scattering the material inside.
- If you use paper that is not a direct equivalent for the recommended print media, the life of supplies and machine parts may be reduced.
- The projected life for each of the toner cartridges is based on ISO/IEC 19752. Frequency of replacement will vary depending on the print volume, percentage of coverage, types of media used, and powering on/off the machine.
- Frequency of replacing supplies except toner cartridges will vary depending on the print volume, types of media used, and powering on/off the machine.
- Handle the toner cartridge carefully. If toner scatters on your hands or clothes, immediately wipe or wash it off with cold water.

### WARNING

- Never use a vacuum cleaner for spilled toner and residual toner in this product, toner cartridge or toner bottle. It may catch fire by electric sparks inside a vacuum cleaner and cause explosion. Use a broom or a wet cloth to wipe off the spills. If you spill a large volume of toner, contact your local Fuji Xerox representative.
- Never throw a toner cartridge into an open flame. Remaining toner in the cartridge may catch fire and cause burn injuries or explosion. If you have a used toner cartridge no longer needed, contact your local Fuji Xerox representative for its disposal.

### CAUTION

- Keep drum cartridges (or drum if not a cartridge type) and toner cartridges out of the reach of children. If a child accidentally swallows toner, spit it out, rinse mouth with water, drink water and consult a physician immediately.
- When replacing drum cartridges (or drum if not a cartridge type) and toner cartridges, be careful not to spill the toner. In case of any toner spills, avoid contact with clothes, skin, eyes and mouth as well as inhalation.
- If toner spills onto your skin or clothing, wash it off with soap and water. If you get toner particles in the eyes, wash it out with plenty of water for at least 15 minutes until irritation is gone. Consult a physician if necessary.



## IMPORTANT

- Fuji Xerox machines are designed to work with toner of a particular specification and will work to a level of optimum performance when used with Fuji Xerox Original toner cartridges. Fuji Xerox cannot guarantee this optimum performance if toner or toner cartridges of other specifications are used. The machine may not detect toner or toner cartridges of other specifications correctly but may instead detect such items as standard yield toner cartridges. Fuji Xerox does not therefore recommend the use of cartridges other than Fuji Xerox Original cartridges with this machine, or the refilling of empty cartridges with toner from other sources. If damage is caused to the drum unit or other parts of this machine as a result of the use of toner or toner cartridges other than Fuji Xerox Original products due to the incompatibility or lack of suitability of those products with this machine, any repairs required as a result may not be covered by the warranty.
- For best performance, use a Fuji Xerox Original drum and toner cartridge. Printing with a third party drum unit or toner cartridge may reduce not only the print quality but also the quality and life of the machine itself. Warranty coverage may not apply to problems caused by the use of a third party drum or toner cartridge.
- To avoid print quality problems, DO NOT touch the shaded parts shown in the illustrations.

### Toner cartridge

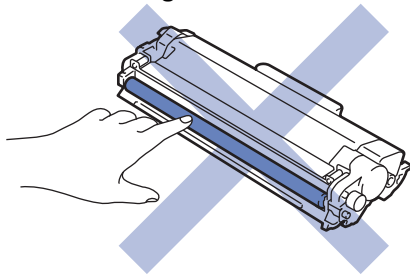

### Drum unit

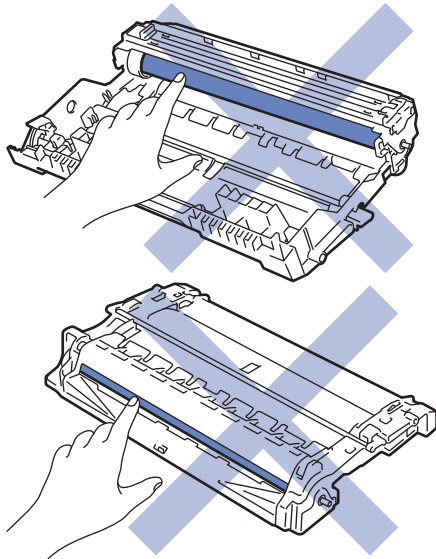

### Related Information

- [Routine Maintenance](#)
- [Replace the Toner Cartridge](#)
- [Replace the Drum Unit](#)
- [Error and Maintenance Messages](#)
- [Supplies](#)

## Replace the Toner Cartridge

1. Make sure the machine is turned on.
2. Open the front cover.

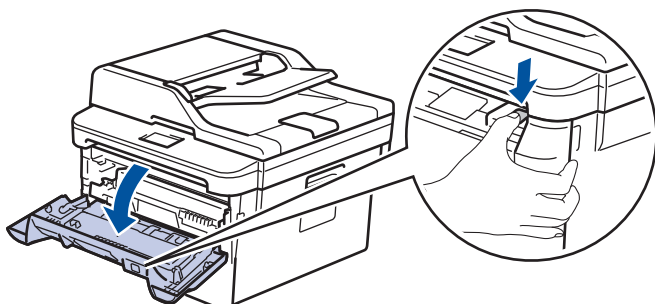
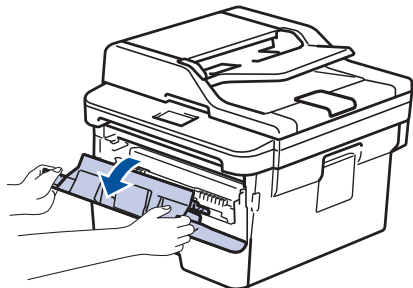

3. Remove the toner cartridge and drum unit assembly from the machine.

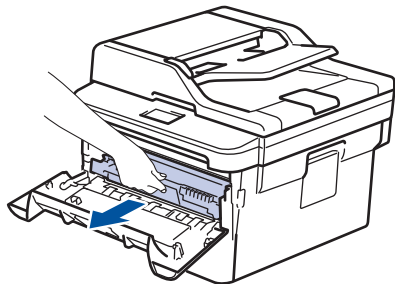

4. Push down the green lock lever and take the toner cartridge out of the drum unit.

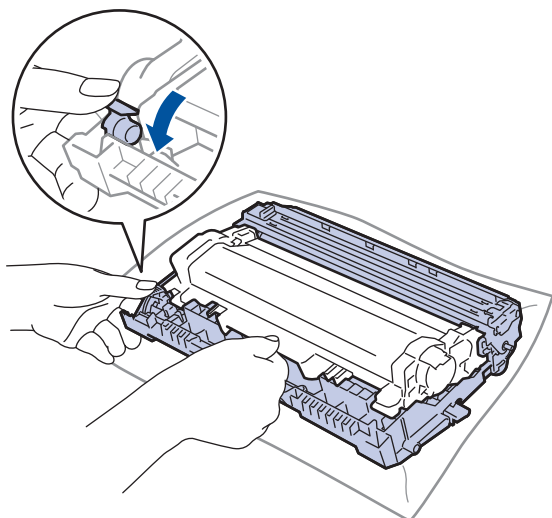

5. Unpack the new toner cartridge.
6. Remove the protective cover.

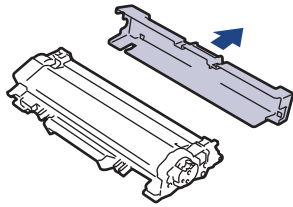

7. Push the new toner cartridge firmly into the drum unit until you hear it lock into place.

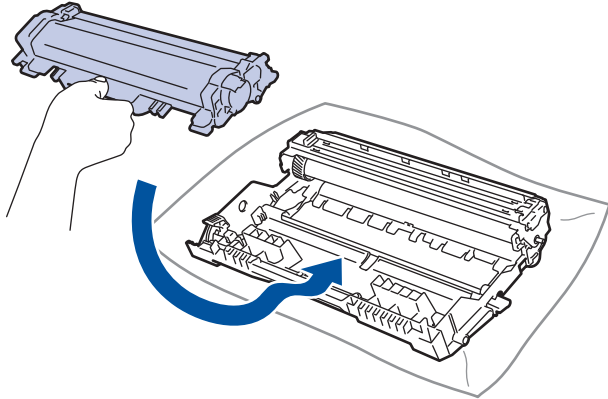

Make sure you put the toner cartridge in correctly or it may separate from the drum unit.

8. Clean the corona wire inside the drum unit by gently sliding the green tab from left to right and right to left several times.

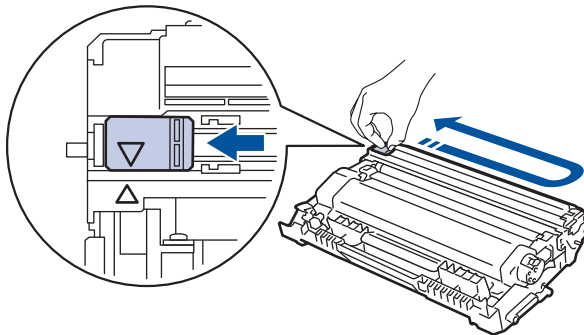

Be sure to return the tab to the Home position (▲). The arrow on the tab must be aligned with the arrow on the drum unit. If it is not, printed pages may have a vertical stripe.

9. Install the toner cartridge and drum unit assembly back into the machine.

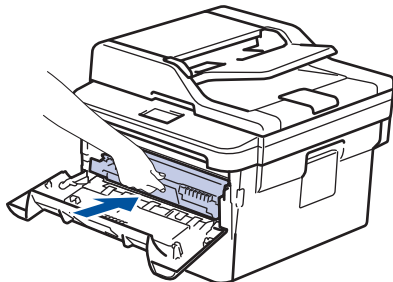

10. Close the front cover of the machine.



- 
- After replacing a toner cartridge, DO NOT turn off the machine or open the front cover until the machine's display returns to Ready Mode.
  - The toner cartridge that comes with your Fuji Xerox machine is a Inbox toner cartridge.
  - It is a good idea to keep a new toner cartridge ready for use when you see the Toner Low warning.
  - To ensure high quality printing, we recommend using only Fuji Xerox Original toner cartridges. When you want to buy toner cartridges, contact Fuji Xerox Dealer.
  - DO NOT unpack the new toner cartridge until you are ready to install it.
  - If a toner cartridge is left unpacked for a long time, the toner life will be shortened.
  - Fuji Xerox strongly recommends you DO NOT refill the toner cartridge provided with your machine. We also strongly recommend you continue to use only Fuji Xerox Original replacement toner cartridges. Use or attempted use of third party toner and/or cartridges in the Fuji Xerox machine may cause damage to the machine and/or may result in unsatisfactory print quality. Our limited warranty coverage does not apply to any problem that is caused by the use of third party toner and/or cartridges. To protect your investment and obtain premium performance from the Fuji Xerox machine, we strongly recommend the use of Fuji Xerox Original Supplies.
- 



### Related Information

- [Replace Supplies](#)
  - [Improve the Print Quality](#)
-

## Replace the Drum Unit

1. Make sure the machine is turned on.
2. Open the front cover.

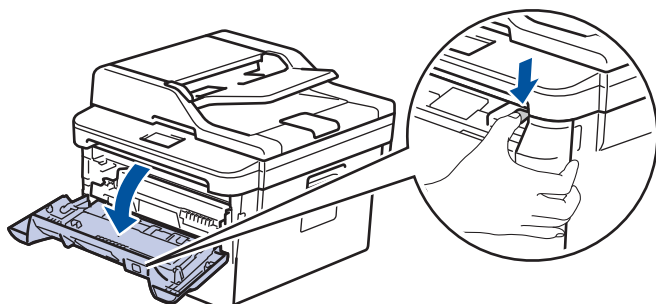
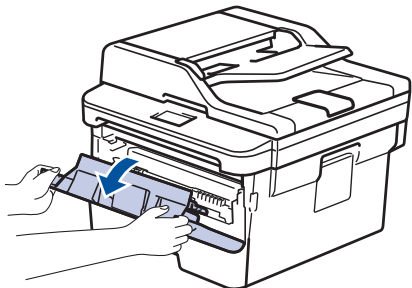

3. Remove the toner cartridge and drum unit assembly from the machine.

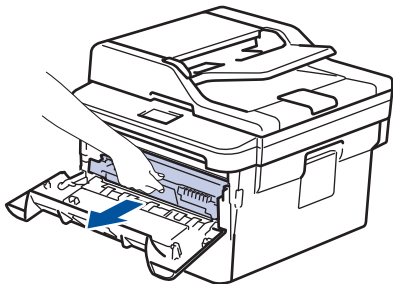

4. Push down the green lock lever and take the toner cartridge out of the drum unit.

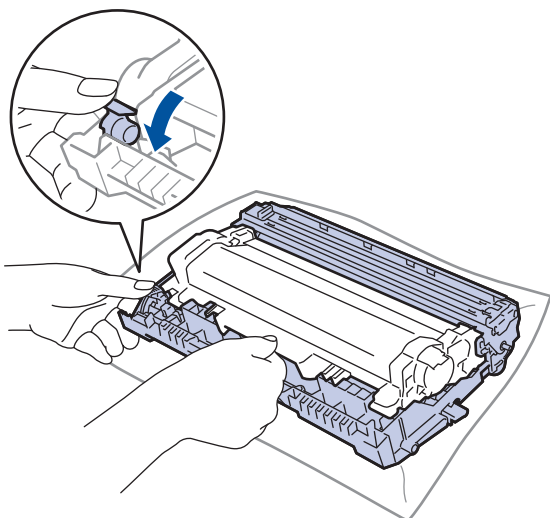

5. Unpack the new drum unit.
6. Push the toner cartridge firmly into the new drum unit until you hear it lock into place.

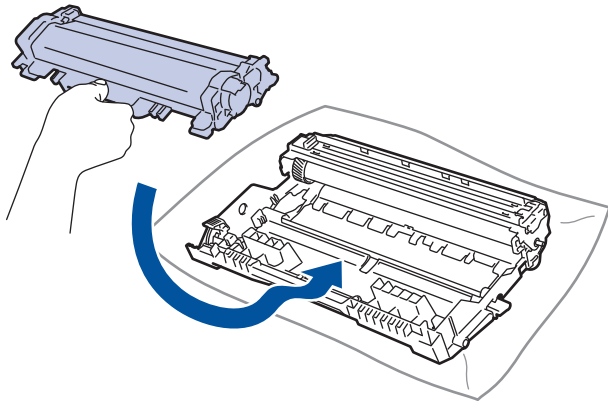

 Make sure you put the toner cartridge in correctly or it may separate from the drum unit.

7. Install the toner cartridge and drum unit assembly back into the machine.

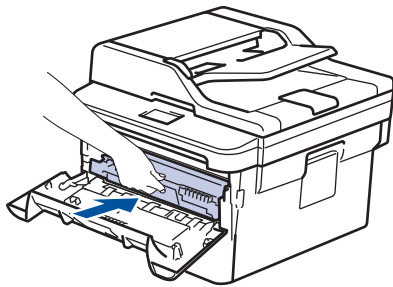

8. Close the front cover of the machine.
9. Reset the drum unit counter.

 For more information on how to reset the drum unit counter, see the *How to Replace the Drum Unit*.

## NOTE

- Drum wear and tear occurs due to use and rotation of the drum and interaction with paper, toner and other materials in the paper path. In designing this product, Fuji Xerox decided to use the number of rotations of the drum as a reasonable determinant of the drum life. When a drum reaches the factory-established rotation limit corresponding to the rated page yield, the product's LCD will advise you to replace the drum. The product will continue to function; however, print quality may not be optimal.
- If an unpacked drum unit is placed in direct sunlight (or room light for long periods of time), the unit may be damaged.
- There are many factors that determine the actual drum life, such as the temperature, humidity, type of paper, type of toner used and so on. Under ideal conditions, the average drum life is estimated at approximately 12,000 pages (based on 1 page per job [A4/Letter single-sided pages]). The number of pages may be affected due to a variety of factors including but not limited to media type and media size. Because we have no control over the many factors that determine the actual drum life, we cannot guarantee a minimum number of pages that will be printed by your drum.
- For best performance, use only Fuji Xerox Original toner.
- The machine should be used only in a clean, dust-free environment with adequate ventilation.
- Printing with a non-Fuji Xerox drum unit may reduce not only the print quality but also the quality and life of the machine itself. Warranty coverage does not apply to problems caused by the use of a non-Fuji Xerox drum unit.

## Related Information

- [Replace Supplies](#)
- [Error and Maintenance Messages](#)
- [Improve the Print Quality](#)

## Clean the Machine

Clean the outside and inside of the machine regularly with a dry, lint-free cloth.

When you replace the toner cartridge or the drum unit, make sure you clean the inside of the machine. If printed pages are stained with toner, clean the inside of the machine with a dry, lint-free cloth.

### ⚠ WARNING

- DO NOT use flammable substances, any type of spray, or an organic solvent/liquid containing alcohol or ammonia to clean the inside or outside of the product. Doing so could cause a fire. Instead, use only a dry, lint-free cloth.
- When cleaning this product, use the designated cleaning materials exclusive to it. Other cleaning materials may result in poor performance of the product. Never use aerosol cleaners to avoid catching fire and explosion.



### ⚠ CAUTION

- When cleaning this product, always switch off and unplug it. Access to a live machine interior may cause electric shock.

### IMPORTANT

- DO NOT use isopropyl alcohol to remove dirt from the control panel. It may crack the panel.
- To avoid print quality problems, DO NOT touch the shaded parts shown in the illustrations.

**Toner cartridge**

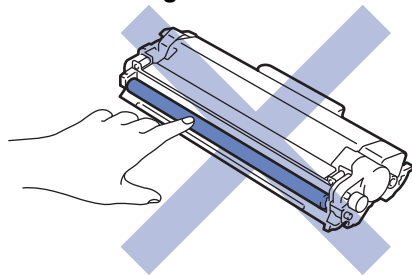

**Drum unit**

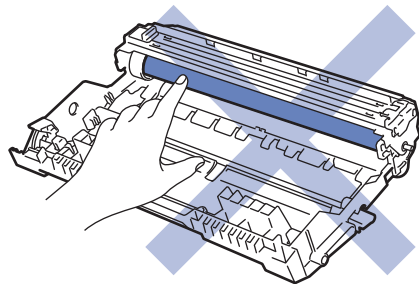

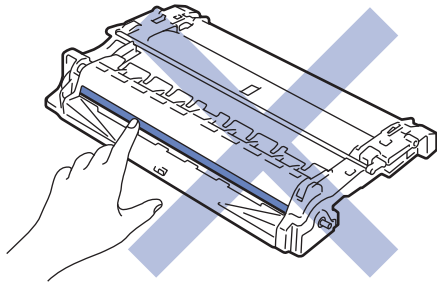

---

### Related Information

- [Routine Maintenance](#)
  - [Clean the Scanner](#)
  - [Clean the Touchscreen LCD](#)
  - [Clean the Corona Wire](#)
  - [Clean the Drum Unit Using Drum Dot Print](#)
  - [Clean the Paper Pick-up Rollers](#)
-



## Clean the Scanner

1. Press and hold  to turn the machine off.
2. Lift the document cover (1). Clean the white plastic surface (2) and scanner glass (3) underneath it with a soft lint-free cloth moistened with water.

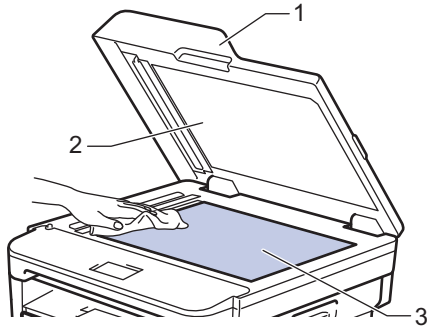

3. (DocuPrint M235 dw/DocuPrint M235 z) In the ADF unit, clean the white bar (1) and the scanner glass strip (2) underneath it with a soft lint-free cloth moistened with water.

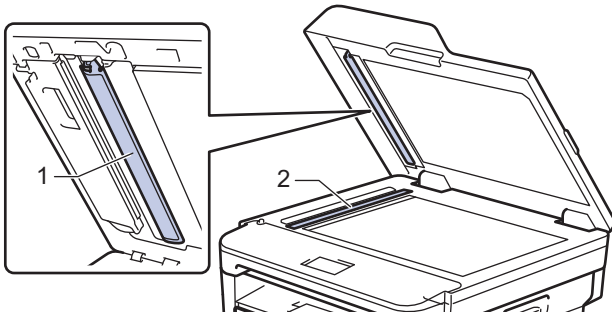

4. (DocuPrint M275 z/DocuPrint M285 z) Open the scanner glass cover (1), and then clean the other white bar (2) and scanner glass strip (3) .

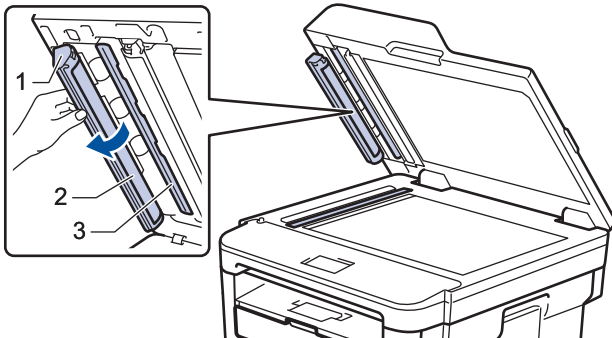

5. Close the document cover.
6. Press  to turn the machine on.

### Related Information

- [Clean the Machine](#)

## Clean the Touchscreen LCD

**Related Models:** DocuPrint M275 z/DocuPrint M285 z

### IMPORTANT

DO NOT use any type of liquid cleaners (including ethanol).

1. Press and hold  to turn the machine off.
2. Clean the touchscreen with a dry, soft lint-free cloth.

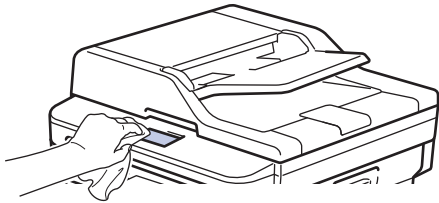

3. Press  to turn the machine on.



### Related Information

- [Clean the Machine](#)

## Clean the Corona Wire

If you have print quality problems or the control panel displays [Drum !] status, clean the corona wire.

1. Open the front cover.

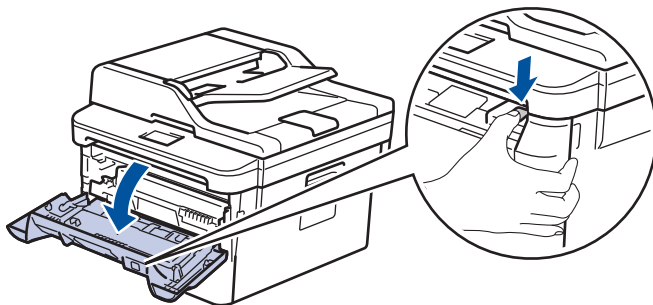
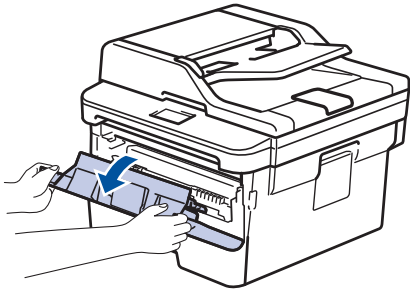

2. Remove the toner cartridge and drum unit assembly from the machine.

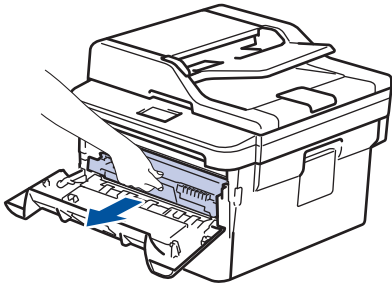

3. Clean the corona wire inside the drum unit by gently sliding the green tab from left to right and right to left several times.

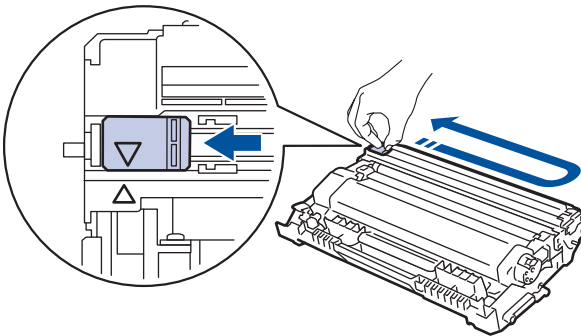

Be sure to return the tab to the Home position (▲). The arrow on the tab must be aligned with the arrow on the drum unit. If it is not, printed pages may have a vertical stripe.

4. Install the toner cartridge and drum unit assembly back into the machine.

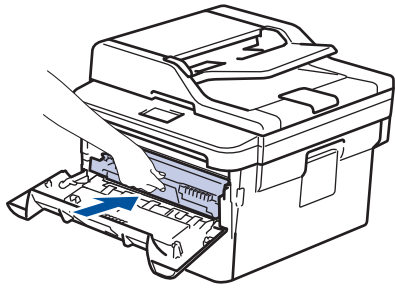

5. Close the front cover of the machine.

### **Related Information**

- [Clean the Machine](#)
  - [Error and Maintenance Messages](#)
-

## Clean the Drum Unit Using Drum Dot Print

If your printout has dots or other repeating marks at 94 mm intervals, the drum may have foreign material, such as glue from a label, stuck on the drum surface.

>> [DocuPrint M235 dw/DocuPrint M235 z](#)

>> [DocuPrint M275 z/DocuPrint M285 z](#)

### DocuPrint M235 dw/DocuPrint M235 z

1. Make sure the machine is in Ready mode.
2. Press ▲ or ▼ to display the [Print Reports] option, and then press **OK**.
3. Press ▲ or ▼ to select the [Drum Dot Print] option.
4. Press **Start**.  
The machine prints the Drum Dot Check Sheet.
5. Press and hold  to turn the machine off.
6. Open the front cover.

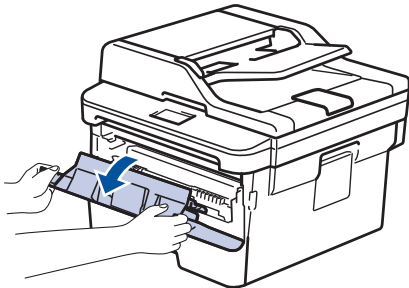

7. Remove the toner cartridge and drum unit assembly from the machine.

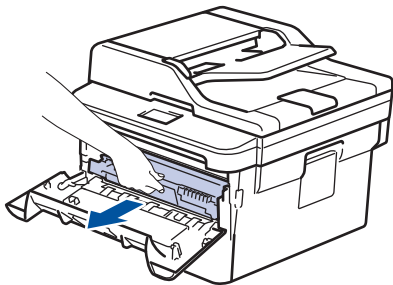

8. Push down the green lock lever and take the toner cartridge out of the drum unit.

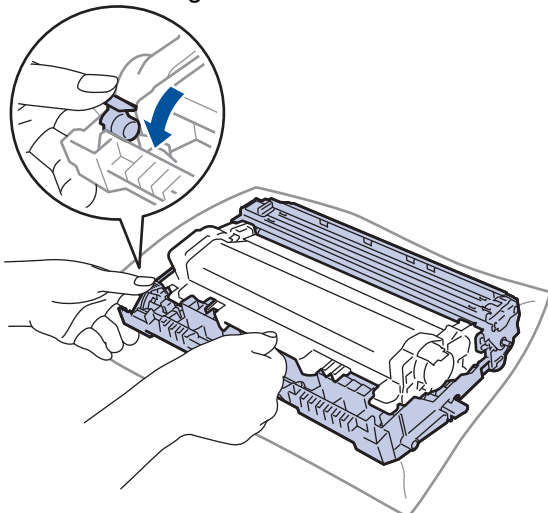

9. Turn the drum unit as shown in the illustration. Make sure that the drum unit gear is on the left side.

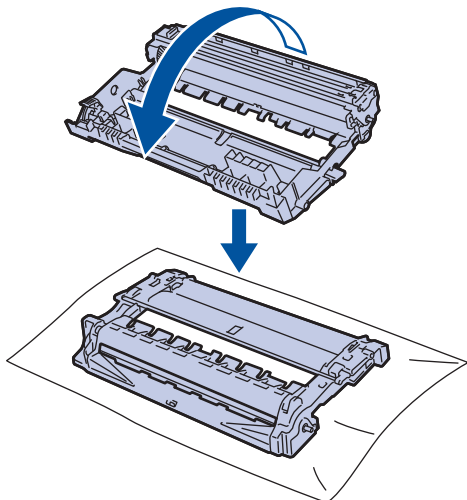

10. Use the numbered markers next to the drum roller to find the mark on the drum. For example, a dot in column 2 on the check sheet means that there is a mark in drum region “2”.

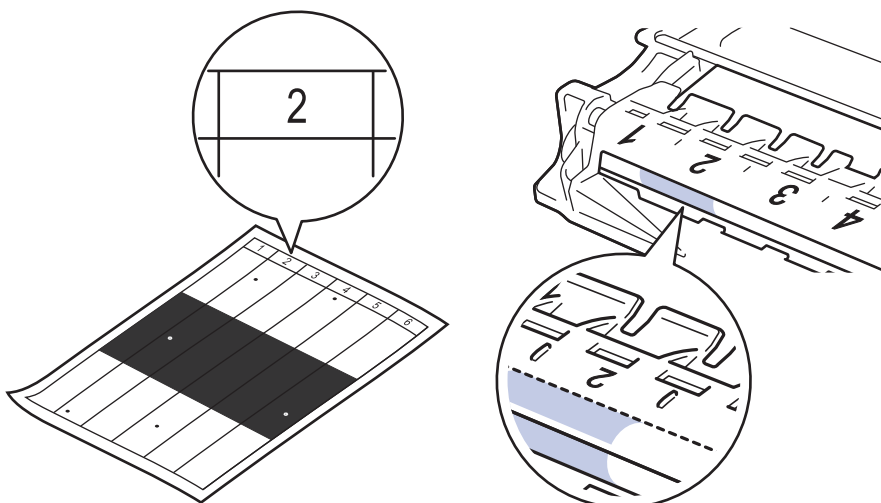

11. Turn the edge of the drum unit towards you while looking at the drum surface to find the mark.

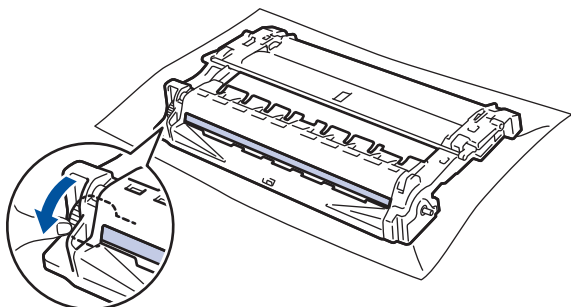

## IMPORTANT

- To avoid print quality problems, DO NOT touch the surface of the drum unit, only the wheel on the end.

12. Wipe the surface of the drum gently with a dry cotton swab until the mark or foreign material on the surface comes off.

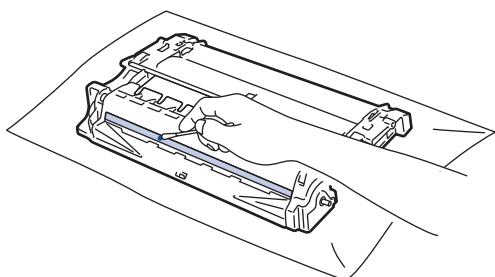

## NOTE

DO NOT clean the surface of the photosensitive drum with a sharp object or any liquids.

13. Push the toner cartridge firmly into the drum unit until you hear it lock into place.

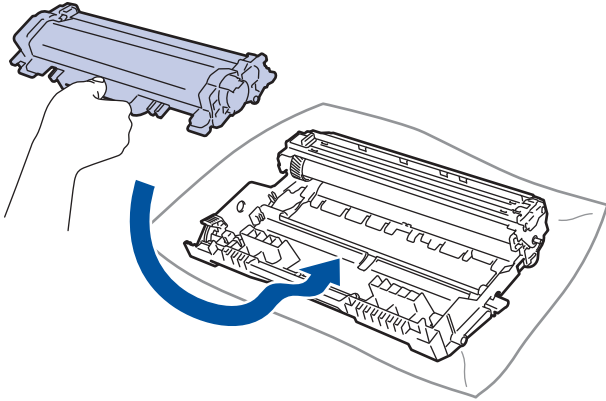

Make sure you put the toner cartridge in correctly or it may separate from the drum unit.

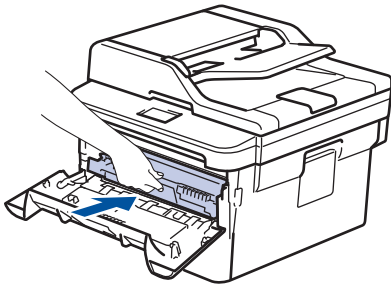

14. Install the toner cartridge and drum unit assembly back into the machine.



15. Close the front cover of the machine.

16. Press  to turn the machine on.

## DocuPrint M275 z/DocuPrint M285 z

1. Make sure the machine is in Ready mode.
2. Press  [Settings] > [All Settings] > [Print Reports] > [Drum Dot Print].
3. Press [Yes].  
The machine prints the Drum Dot Check Sheet.
4. Press .
5. Press and hold  to turn the machine off.
6. Open the front cover.

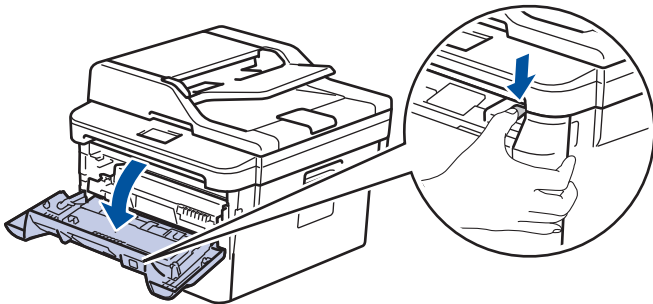
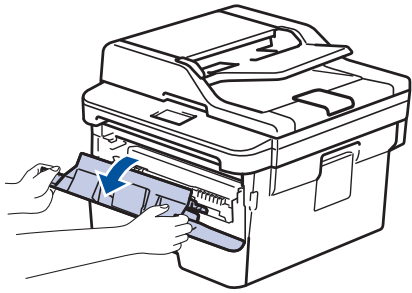

7. Remove the toner cartridge and drum unit assembly from the machine.

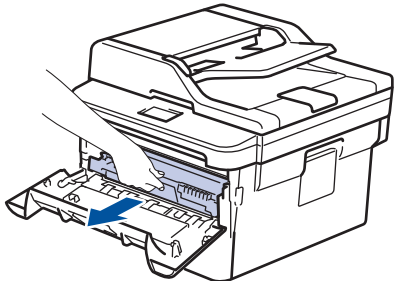

8. Push down the green lock lever and take the toner cartridge out of the drum unit.

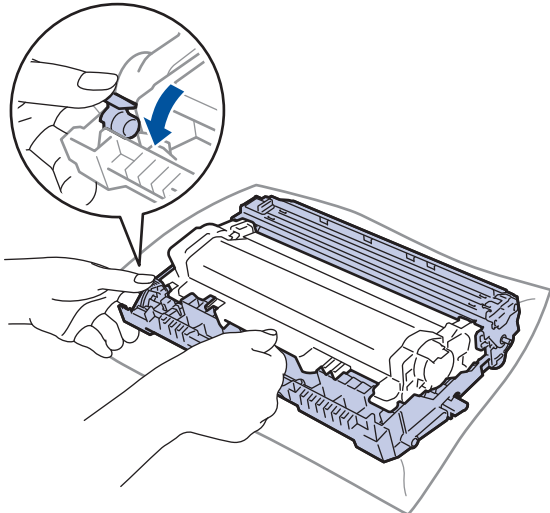

9. Turn the drum unit as shown in the illustration. Make sure that the drum unit gear is on the left side.



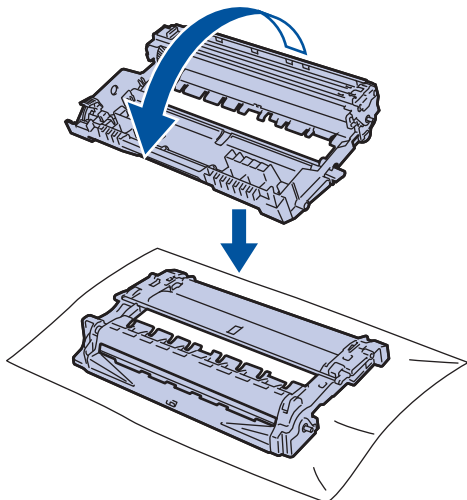

10. Use the numbered markers next to the drum roller to find the mark on the drum. For example, a dot in column 2 on the check sheet means that there is a mark in drum region “2”.

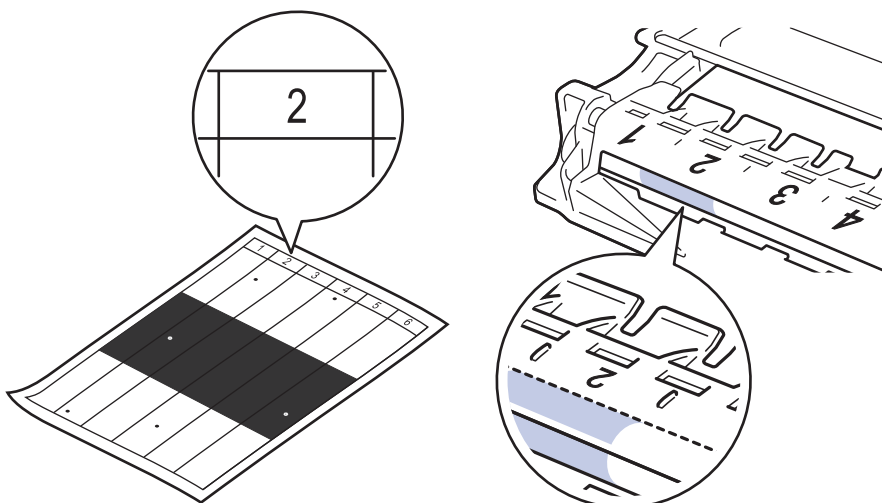

11. Turn the edge of the drum unit towards you while looking at the drum surface to find the mark.

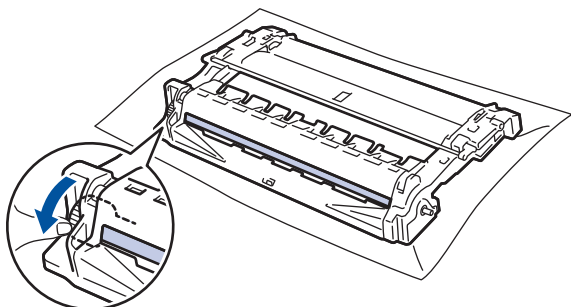

### IMPORTANT

- To avoid print quality problems, DO NOT touch the surface of the drum unit, only the wheel on the end.

12. Wipe the surface of the drum gently with a dry cotton swab until the mark or foreign material on the surface comes off.

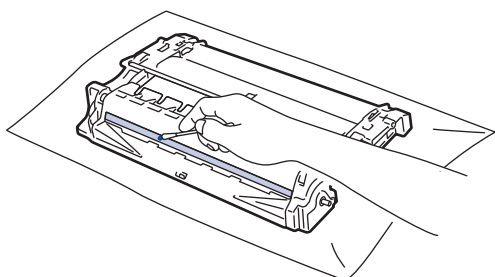

## NOTE

DO NOT clean the surface of the photosensitive drum with a sharp object or any liquids.

13. Push the toner cartridge firmly into the drum unit until you hear it lock into place.

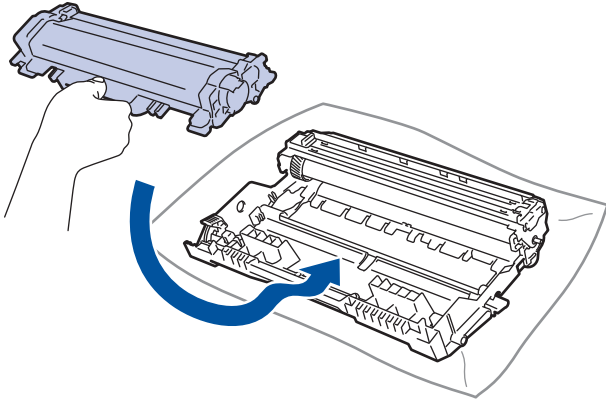

Make sure you put the toner cartridge in correctly or it may separate from the drum unit.

14. Install the toner cartridge and drum unit assembly back into the machine.

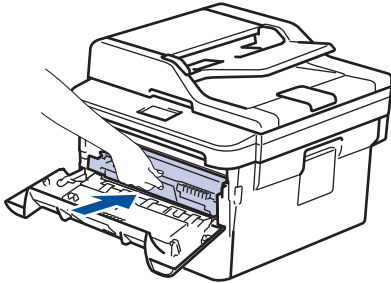

15. Close the front cover of the machine.

16. Press  to turn the machine on.



### Related Information

- [Clean the Machine](#)
- [Improve the Print Quality](#)

## Clean the Paper Pick-up Rollers

Cleaning the paper pick-up rollers periodically may prevent paper jams by ensuring that paper feeds properly.

If you have paper feed problems, clean the pick-up rollers as follows:

1. Press and hold  to turn the machine off.
2. Pull the paper tray completely out of the machine.

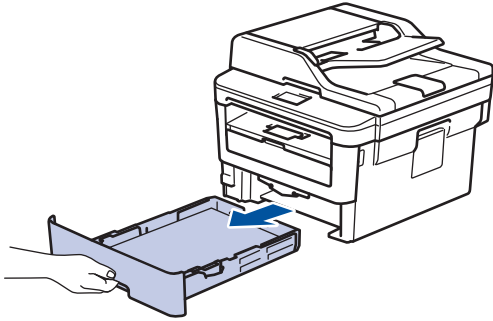

3. If paper is loaded or something is stuck inside in the paper tray, remove it.
4. Tightly wring out a lint-free cloth soaked in lukewarm water, and then wipe the separator pad on the paper tray to remove dust.

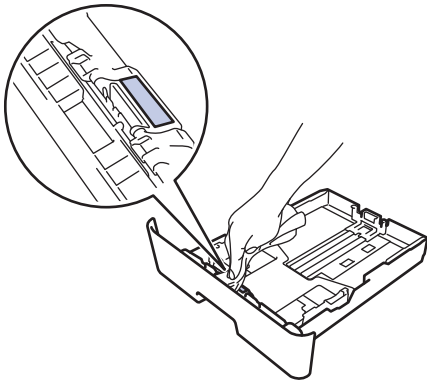

5. Wipe the two pick-up rollers inside the machine to remove dust.

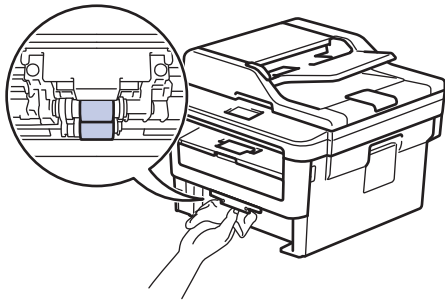

6. Reload the paper and put the paper tray firmly back in the machine.
7. Press  to turn the machine on.

### Related Information

- [Clean the Machine](#)
- [Printing Problems](#)

## Check the Remaining Part Life



>> [DocuPrint M235 dw/DocuPrint M235 z](#)

>> [DocuPrint M275 z/DocuPrint M285 z](#)

### DocuPrint M235 dw/DocuPrint M235 z

1. Press **Menu**.
2. Press **▲** or **▼** to display the [Machine Info.] option, and then press **OK**.
3. Press **▲** or **▼** to display the [Parts Life] option, and then press **OK**.
4. Press **▲** or **▼** to select the [Toner] or [Drum] option, and then press **OK**.  
The LCD displays the approximate remaining toner or drum life.
5. Press **Stop/Exit**.

### DocuPrint M275 z/DocuPrint M285 z

1. Press  [Settings] > [All Settings] > [Machine Info.] > [Parts Life].
2. The LCD displays the approximate remaining drum life.
3. Press .



To display the approximate remaining life of toner cartridge, press  on the LCD.

### ✓ Related Information

- [Routine Maintenance](#)

## Machine Settings

Customise settings and features, create shortcuts, and work with options displayed on the machine's LCD to make your Fuji Xerox machine a more efficient work tool.

- [Change Machine Settings from the Control Panel](#)
- [Change Machine Settings from Your Computer](#)

## Change Machine Settings from the Control Panel

- [In the Event of Power Failure \(Memory Storage\)](#)
- [General Settings](#)
- [Save Your Favourite Settings as a Shortcut](#)
- [Print Reports](#)
- [Settings and Features Tables](#)

## In the Event of Power Failure (Memory Storage)

Your menu settings are stored permanently, and in the event of a power failure will not be lost. Temporary settings (for example, Contrast, Overseas Mode) will be lost.

- (DocuPrint M275 z/DocuPrint M285 z)  
During a power failure, the machine will retain the date and time and programmed fax timer jobs (for example: Delayed Fax) for approximately 60 hours. Other fax jobs in the machine's memory will not be lost.
- (DocuPrint M235 z)  
During a power failure, the machine will retain the date and time for approximately two hours. The fax jobs in the machine's memory will be lost.



### Related Information

- [Change Machine Settings from the Control Panel](#)
-

## General Settings

- [Change the Default Mode](#)
- [Set the Mode Timer](#)
- [Adjust the Machine's Volume](#)
- [Change for Daylight Saving Time](#)
- [Set Sleep Mode Countdown](#)
- [About Deep Sleep Mode](#)
- [Set Auto Power Off Mode](#)
- [Set the Date and Time](#)
- [Set the Time Zone](#)
- [Adjust the LCD Backlight Brightness](#)
- [Change How Long the LCD Backlight Stays On](#)
- [Set Your Station ID](#)
- [Set Tone or Pulse Dialling Mode](#)
- [Reduce Toner Consumption](#)
- [Set the Continue Mode](#)
- [Learn About Receiving Faxes in Continue Mode](#)
- [Add a Prefix to Every Fax Number](#)
- [Prevent Dialling a Wrong Number \(Dial Restriction\)](#)
- [Reduce Printing Noise](#)
- [Change the Language on the LCD](#)



## Change the Default Mode

**Related Models:** DocuPrint M235 z

When the machine is idle or you press **Stop/Exit**, the machine will return to the mode you set.

- For DocuPrint M235 z, the machine has Fax, Scan and Copy modes. The default mode is Fax.

1. Press **Menu**.
2. Press **▲** or **▼** to display the [General Setup] option, and then press **OK**.
3. Press **▲** or **▼** to display the [Default Mode] option, and then press **OK**.
4. Press **▲** or **▼** to display the [Fax], [Copy], or [Scan] option, and then press **OK**.
5. Press **Stop/Exit**.



### Related Information

- [General Settings](#)

## Set the Mode Timer

**Related Models:** DocuPrint M235 z

The machine returns to the default mode after use of the machine in a mode other than the default mode. The Mode Timer setting defines how much time the machine takes after the last operation to return to the default mode. If you choose [Off], the machine will stay in the mode you used last.

- For DocuPrint M235 z, the machine has three mode buttons on the control panel: Fax, Scan and Copy.

1. Press **Menu**.
2. Press **▲** or **▼** to display the [General Setup] option, and then press **OK**.
3. Press **▲** or **▼** to display the [Mode Timer] option, and then press **OK**.
4. Press **▲** or **▼** to display the [5Mins], [2Mins], [1Min], [30Secs], [0Sec], or [Off] option, and then press **OK**.
5. Press **Stop/Exit**.



### Related Information

- [General Settings](#)

## Adjust the Machine's Volume

**Related Models:** DocuPrint M235 z/DocuPrint M275 z/DocuPrint M285 z

>> [DocuPrint M235 z](#)

>> [DocuPrint M275 z/DocuPrint M285 z](#)

### DocuPrint M235 z

1. Press **Menu**.
2. Press **▲** or **▼** to display the [General Setup] option, and then press **OK**.
3. Press **▲** or **▼** to display the [Volume] option, and then press **OK**.
4. Press **▲** or **▼** to select one of the following options:

| Option  | Description  |
|---------|--|
| Ring    | Adjust the ring volume.  |
| Beep    | Adjust the volume when you press a button, make a mistake, or after you send or receive a fax. |
| Speaker | Adjust the speaker volume.   |

5. Press **OK**.
6. Press **▲** or **▼** to display the [High], [Med], [Low], or [Off] option, and then press **OK**.
7. Press **Stop/Exit**.



You can also adjust the speaker volume by pressing **Hook**. Press **◀** or **▶**. Each button press decreases or increases the volume. When finished, press **Hook**.

### DocuPrint M275 z/DocuPrint M285 z

1. Press  [Settings] > [All Settings] > [General Setup] > [Volume].
2. Press one of the following options:

| Option  | Description  |
|---------|--|
| Ring    | Adjust the ring volume.  |
| Beep    | Adjust the volume when you press a button, make a mistake, or after you send or receive a fax. |
| Speaker | Adjust the speaker volume.   |

3. Press **▲** or **▼** to display the [Off], [Low], [Med], or [High] option, and then press the option you want.
4. Press .

### Related Information

- [General Settings](#)

## Change for Daylight Saving Time

You can program the machine to change for Daylight Saving Time.

To forward the time by one hour or backward one hour, select the setting in accordance with the following table. Make sure you have set the correct date and time in the Date & Time setting.

| Applicable Models                 | To Forward One Hour | To Backward One Hour |
|-----------------------------------|---------------------|----------------------|
| DocuPrint M235 z                  | Forward Hour        | Backward Hour        |
| DocuPrint M275 z/DocuPrint M285 z | Forward Hour        | Backward Hour        |



>> [DocuPrint M235 z](#)

>> [DocuPrint M275 z/DocuPrint M285 z](#)

### DocuPrint M235 z

1. Press **Menu**.
2. Press **▲** or **▼** to display the [Initial Setup] option, and then press **OK**.
3. Press **▲** or **▼** to display the [Date&Time] option, and then press **OK**.
4. Press **▲** or **▼** to display the [Daylight Save] option, and then press **OK**.
5. Press **▲** or **▼** to display the [Forward Hour] or [Backward Hour] option, and then press **OK**.
6. Press **Stop/Exit**.

### DocuPrint M275 z/DocuPrint M285 z

1. Press  [Settings] > [All Settings] > [Initial Setup] > [Date & Time] > [Daylight Save].
2. Press [Forward Hour] or [Backward Hour].
3. Press .

### ✓ Related Information

- [General Settings](#)

## Set Sleep Mode Countdown

The Sleep Mode (or Power Save Mode) setting can reduce power consumption. When the machine is in Sleep Mode, it acts as though it is turned off. The machine will wake up and start printing when it receives a print job or a fax. Use these instructions to set a time delay (countdown) before the machine enters Sleep Mode.

- You can choose how long the machine must be idle before it goes into Sleep Mode.
- The timer will restart if any operation is carried out on the machine, such as receiving a print job.



>> [DocuPrint M235 dw/DocuPrint M235 z](#)

>> [DocuPrint M275 z/DocuPrint M285 z](#)

### DocuPrint M235 dw/DocuPrint M235 z

1. Press **Menu**.
2. Press **▲** or **▼** to display the [General Setup] option, and then press **OK**.
3. Press **▲** or **▼** to display the [Ecology] option, and then press **OK**.
4. Press **▲** or **▼** to display the [Sleep Time] option, and then press **OK**.
5. Using the dial pad, enter the length of time the machine (maximum 50 minutes) is idle before entering Sleep Mode, and then press **OK**.
6. Press **Stop/Exit**.

### DocuPrint M275 z/DocuPrint M285 z

1. Press  [Settings] > [All Settings] > [General Setup] > [Ecology] > [Sleep Time].
2. Enter the length of time (maximum 50 minutes) the machine will remain idle before entering Sleep Mode, and then press [OK].
3. Press .



### Related Information

- [General Settings](#)

## About Deep Sleep Mode

If the machine is in Sleep mode and does not receive any jobs for certain length of time, the machine will automatically enter Deep Sleep mode. The length of time is based on your specific model and settings.

Deep Sleep mode uses less power than Sleep mode.

| Applicable Models                      | Machine's Control Panel in Deep Sleep Mode                        | Conditions That Will Wake the Machine  |
|--|---|--|
| DocuPrint M235 dw/<br>DocuPrint M235 z | The LCD displays <i>Deep Sleep</i> .                              | <ul style="list-style-type: none"><li>The machine receives a job.</li><li>Someone presses a button on the control panel.</li></ul>   |
| DocuPrint M275 z/<br>DocuPrint M285 z  | The LCD backlight turns off and the Power LED brightens and dims. | <ul style="list-style-type: none"><li>The machine receives a job.</li><li>Someone presses ,  or the touchscreen LCD.</li></ul> |



### Related Information

- [General Settings](#)

## Set Auto Power Off Mode

If the machine is in Deep Sleep Mode for certain length of time, based on your model and settings, the machine will go into Power Off Mode automatically. The machine does not go into Power Off Mode when the machine is connected to a network or a telephone line, or has secure print data in the memory (Available only for certain models).

- To start printing, press  on the control panel and then send a print job.



>> [DocuPrint M235 dw/DocuPrint M235 z](#)

>> [DocuPrint M275 z/DocuPrint M285 z](#)

### DocuPrint M235 dw/DocuPrint M235 z

1. Press **Menu**.
2. Press **▲** or **▼** to display the [General Setup] option, and then press **OK**.
3. Press **▲** or **▼** to display the [Ecology] option, and then press **OK**.
4. Press **▲** or **▼** to display the [Auto Power Off] option, and then press **OK**.
5. Press **▲** or **▼** to display the [8hours], [4hours], [2hours], [1hour], or [Off] option, and then press **OK**.
6. Press **Stop/Exit**.

### DocuPrint M275 z/DocuPrint M285 z

1. Press  [Settings] > [All Settings] > [General Setup] > [Ecology] > [Auto Power Off].
2. Press **▲** or **▼** to display the [Off], [1hour], [2hours], [4hours] or [8hours] option, and then press the option you want.
3. Press .

### Related Information

- [General Settings](#)

## Set the Date and Time

**Related Models:** DocuPrint M235 z/DocuPrint M275 z/DocuPrint M285 z



>> [DocuPrint M235 z](#)

>> [DocuPrint M275 z/DocuPrint M285 z](#)

### DocuPrint M235 z

1. Press **Menu**.
2. Press **▲** or **▼** to display the [Initial Setup] option, and then press **OK**.
3. Press **▲** or **▼** to display the [Date&Time] option, and then press **OK**.
4. Press **▲** or **▼** to display the [Date&Time] option, and then press **OK**.
5. Enter the last two digits of the year using the dial pad, and then press **OK**.
6. Enter the two digits for the month using the dial pad, and then press **OK**.
7. Enter the two digits for the day using the dial pad, and then press **OK**.
8. Press **▲** or **▼** to display the [12h Clock] or [24h Clock] option, and then press **OK**.
9. Do one of the following:
  - If you selected [12h Clock] as the format in the [Date&Time] setting, enter the time (in 12-hour format) using the dial pad.  
Press **OK**.  
Press **▲** or **▼** to display the [AM] or [PM] option, and then press **OK**.
  - If you selected [24h Clock] as the format in the [Date&Time] setting, enter the time (in 24-hour format) using the dial pad.  
Press **OK**.  
(For example: enter 19:45 for 7:45 PM.)
10. Press **Stop/Exit**.

### DocuPrint M275 z/DocuPrint M285 z

1. Press  [Settings] > [All Settings] > [Initial Setup] > [Date & Time] > [Date].
2. Enter the last two digits of the year using the LCD, and then press [OK].
3. Enter the two digits for the month using the LCD, and then press [OK].
4. Enter the two digits for the day using the LCD, and then press [OK].
5. Press [Clock Type].
6. Press [12h Clock] or [24h Clock].
7. Press [Time].
8. To enter the time, do one of the following:
  - If you selected [12h Clock] as the format in the [Clock Type] setting, enter the time (in 12-hour format) using the LCD.  
Press  to select the [AM] or [PM].  
Press [OK].
  - If you selected [24h Clock] as the format in the [Clock Type] setting, enter the time (in 24-hour format) using the LCD.  
Press [OK].  
(For example: enter 19:45 for 7:45 PM.)



---

9. Press .



## Related Information

- [General Settings](#)
-

## Set the Time Zone

**Related Models:** DocuPrint M235 z/DocuPrint M275 z/DocuPrint M285 z

Set the time zone for your location on the machine.



>> [DocuPrint M235 z](#)

>> [DocuPrint M275 z/DocuPrint M285 z](#)

### DocuPrint M235 z

1. Press **Menu**.
2. Press **▲** or **▼** to display the [Initial Setup] option, and then press **OK**.
3. Press **▲** or **▼** to display the [Date&Time] option, and then press **OK**.
4. Press **▲** or **▼** to display the [Time Zone] option, and then press **OK**.
5. Press **▲** or **▼** to choose the time zone. Press **OK**.
6. Press **Stop/Exit**.

### DocuPrint M275 z/DocuPrint M285 z

1. Press  [Settings] > [All Settings] > [Initial Setup] > [Date & Time] > [Time Zone].
2. Enter your time zone.
3. Press [OK].
4. Press .



### Related Information

- [General Settings](#)

## Adjust the LCD Backlight Brightness

**Related Models:** DocuPrint M275 z/DocuPrint M285 z

If you are having difficulty reading the LCD, changing the brightness setting may help.

1. Press  [Settings] > [All Settings] > [General Setup] > [LCD Settings] > [Backlight].
2. Press the [Light], [Med] or [Dark] option.
3. Press .



### Related Information

- [General Settings](#)

## Change How Long the LCD Backlight Stays On

**Related Models:** DocuPrint M275 z/DocuPrint M285 z

Set how long the LCD backlight stays on.

1. Press  [Settings] > [All Settings] > [General Setup] > [LCD Settings] > [Dim Timer].
2. Press the option you want:
  - [10Secs]
  - [30Secs]
  - [1Min]
  - [2Mins]
  - [3Mins]
  - [5Mins]
3. Press .



### Related Information

- [General Settings](#)

## Set Your Station ID

**Related Models:** DocuPrint M235 z/DocuPrint M275 z/DocuPrint M285 z

Set the machine to print your Station ID and the fax's date and time at the top of each fax you send.

>> [DocuPrint M235 z](#)

>> [DocuPrint M275 z/DocuPrint M285 z](#)

### DocuPrint M235 z

1. Press  (Fax).
2. Press **Menu**.
3. Press **▲** or **▼** to display the [Initial Setup] option, and then press **OK**.
4. Press **▲** or **▼** to display the [Station ID] option, and then press **OK**.
5. Enter your fax number (up to 20 digits) using the dial pad, and then press **OK**.
6. Enter your telephone number (up to 20 digits) using the dial pad, and then press **OK**.  
If your telephone number and fax number are the same, enter the same number again.
7. Use the dial pad to enter your name (up to 20 characters), and then press **OK**.





- To enter text on your machine, see *Related Information: How to Enter Text on Your Fuji Xerox Machine*.

8. Press **Stop/Exit**.

### DocuPrint M275 z/DocuPrint M285 z

1. Press  [Settings] > [All Settings] > [Initial Setup] > [Station ID] > [Fax].
2. Enter your fax number (up to 20 digits) using the LCD, and then press [OK].
3. Press [Tel].
4. Enter your telephone number (up to 20 digits) using the LCD, and then press [OK].
5. Press [Name].
6. Enter your name (up to 20 characters) using the LCD, and then press [OK].



- Press  to cycle between letters, numbers and special characters. (The characters available may differ depending on your country.)
- If you enter an incorrect character, press **◀** or **▶** to move the cursor to it and press . Press the correct character.
- To enter a space, press [Space].
- For more information, see *Related Information*.

7. Press .

### ✓ Related Information

- [General Settings](#)
- [How to Enter Text on Your Fuji Xerox Machine](#)
- [Transfer Faxes to Another Fax Machine](#)
- [Transfer the Fax Journal Report to Another Fax Machine](#)

## Set Tone or Pulse Dialling Mode

**Related Models:** DocuPrint M235 z/DocuPrint M275 z/DocuPrint M285 z

Your Fuji Xerox machine is set for a Tone dialling service. If you have a Pulse dialling (rotary) service, you must change the dialling mode.

This feature is not available in some countries.



>> [DocuPrint M235 z](#)

>> [DocuPrint M275 z/DocuPrint M285 z](#)

### DocuPrint M235 z

1. Press **Menu**.
2. Press **▲** or **▼** to display the [Initial Setup] option, and then press **OK**.
3. Press **▲** or **▼** to display the [Tone/Pulse] option, and then press **OK**.
4. Press **▲** or **▼** to display the [Tone] or [Pulse] option, and then press **OK**.
5. Press **Stop/Exit**.

### DocuPrint M275 z/DocuPrint M285 z

1. Press  [Settings] > [All Settings] > [Initial Setup] > [Tone/Pulse].
2. Press [Tone] or [Pulse].
3. Press .

### Related Information

- [General Settings](#)

## Reduce Toner Consumption

Using the Toner Save feature may reduce toner consumption. When Toner Save is set to on, the print on your documents appears lighter.



We DO NOT recommend using the Toner Save feature for printing photo or greyscale images.

>> [DocuPrint M235 dw/DocuPrint M235 z](#)  
>> [DocuPrint M275 z/DocuPrint M285 z](#)

### DocuPrint M235 dw/DocuPrint M235 z

1. Press **Menu**.
2. Press **▲** or **▼** to display the [General Setup] option, and then press **OK**.
3. Press **▲** or **▼** to display the [Ecology] option, and then press **OK**.
4. Press **▲** or **▼** to display the [Toner Save] option, and then press **OK**.
5. Press **▲** or **▼** to display the [On] or [Off] option, and then press **OK**.
6. Press **Stop/Exit**.

### DocuPrint M275 z/DocuPrint M285 z

1. Press  [Settings] > [All Settings] > [General Setup] > [Ecology] > [Toner Save].
2. Press [On] or [Off].
3. Press .

### Related Information

- [General Settings](#)
- [Improve the Print Quality](#)

## Set the Continue Mode

The Continue Mode forces the machine to continue printing after the control panel displays Replace Toner.

The machine will continue printing until the LCD displays Toner Ended.

The factory setting is Stop.



- When the control panel indicates an error, you cannot change the mode.
- If you continue printing in the Continue Mode, we cannot guarantee the print quality.
- While using Continue Mode the print may appear faint.
- After replacing the toner cartridge with a new one, the Continue Mode will go back to the default setting (Stop).



>> [DocuPrint M235 dw/DocuPrint M235 z](#)

>> [DocuPrint M275 z/DocuPrint M285 z](#)

### DocuPrint M235 dw/DocuPrint M235 z

1. Press **Menu**.
2. Press **▲** or **▼** to display the [General Setup] option, and then press **OK**.
3. Press **▲** or **▼** to display the [Replace Toner] option, and then press **OK**.
4. Press **▲** or **▼** to display the [Continue] or [Stop] option, and then press **OK**.
5. Press **Stop/Exit**.

### DocuPrint M275 z/DocuPrint M285 z

1. Press  [Settings] > [All Settings] > [General Setup] > [Replace Toner].
2. Press [Continue] or [Stop].
3. Press .

### Related Information

- [General Settings](#)



## Learn About Receiving Faxes in Continue Mode

**Related Models:** DocuPrint M235 z/DocuPrint M275 z/DocuPrint M285 z

The machine can store received faxes in the memory if you choose the Continue Mode when the LCD displays Replace Toner.

When received faxes are printed in Continue Mode the LCD will ask if the print quality of the fax is OK.

If the quality is not good, choose No. The machine will keep the faxes stored in the memory so you can reprint them after you replace the toner cartridge with a new one. If the print quality is good, choose Yes. The LCD will ask if you want to delete the printed faxes from the memory.

If you choose not to delete them, you will be asked again after you replace the toner cartridge with a new one.



- The machine can store up to 500 faxes in memory.
- (DocuPrint M235 z)  
If you turn off the power switch faxes in memory will be lost.
- The machine will keep faxes stored in Continue Mode even if you change the Continue setting to Stop.
- If you install a new toner cartridge when the LCD displays Toner Ended, the machine will ask if you want to print the stored faxes. Choose Print to print stored faxes.

### Toner End in Continue Mode

When the LCD displays Toner Ended, the machine will stop printing. If the memory is full and you want to continue receiving faxes, you must install a new toner cartridge.



### Related Information

- [General Settings](#)

## Add a Prefix to Every Fax Number

**Related Models:** DocuPrint M235 z/DocuPrint M275 z/DocuPrint M285 z

The Dial Prefix setting will automatically dial a predefined number before every fax number you dial. For example: If your telephone system requires a 9 to dial an outside number, use this setting to automatically dial 9 for every fax you send.



- Use the numbers and symbols from 0 to 9, #, and \*. (You cannot use ! with any other numbers or symbols.)
- If your telephone system requires a time break recall (hookflash), press ! on the LCD.

>> [DocuPrint M235 z](#)

>> [DocuPrint M275 z/DocuPrint M285 z](#)

### DocuPrint M235 z

1. Press **Menu**.
2. Press **▲** or **▼** to display the [Initial Setup] option, and then press **OK**.
3. Press **▲** or **▼** to display the [Dial Prefix] option, and then press **OK**.
4. Do one of the following:
  - If the machine does not have a stored prefix number, enter a number (up to 5 digits) using the dial pad, and then press **OK**.
  - If the machine has a stored prefix number and you want to change it, press **▲** to edit the number. Press **Clear** to delete each digit of the existing number and enter a new number using the dial pad, and then press **OK**.



To turn off the dial prefix feature, delete the stored prefix number and then press **OK**.

5. Press **Stop/Exit**.

### DocuPrint M275 z/DocuPrint M285 z

1. Press  [Settings] > [All Settings] > [Initial Setup] > [Dial Prefix].
2. Press [On] or [Off].

| Option | Description   |
|--------|---|
| On     | To activate the prefix number setting, select On.<br>If you selected On, go to the next step to set a prefix number.  |
| Off    | To deactivate the prefix number setting, select Off.<br>If you selected Off, press  to exit. |

3. Press [Dial Prefix].
4. Enter a prefix number (up to 5 digits) using the LCD, and then press [OK].



To change the prefix number, press **◀** or **▶** to position the cursor under the digit to be deleted and press . Then press the correct digit.

Repeat until the prefix number is correct, and then press [OK].

---

5. Press .



## Related Information

- [General Settings](#)
-

## Prevent Dialling a Wrong Number (Dial Restriction)

**Related Models:** DocuPrint M235 z/DocuPrint M275 z/DocuPrint M285 z

This feature prevents users from sending a fax or call to the wrong number by mistake. You can set the machine to restrict dialling when you use the dial pad, Address Book and Shortcuts.

>> [DocuPrint M235 z](#)

>> [DocuPrint M275 z/DocuPrint M285 z](#)

### DocuPrint M235 z

1. Press **Menu**.
2. Press **▲** or **▼** to display the [Fax] option, and then press **OK**.
3. Press **▲** or **▼** to display the [Dial Restrict.] option, and then press **OK**.
4. Press **▲** or **▼** to display your preferred option, and then press **OK**.
  - [Dial Pad]
  - [One Touch Dial]
  - [Speed Dial]
5. Press **▲** or **▼** to select one of the following options, and then press **OK**.

| Option        | Description   |
|---------------|---|
| Enter # Twice | The machine will prompt you to re-enter the number, and then if you re-enter the same number correctly, the machine will start dialling. If you re-enter the wrong number, the LCD will display an error message. |
| On            | The machine will restrict all fax sending and outbound calls for that dialling method.  |
| Off           | The machine does not restrict the dialling method.  |

- The [Enter # Twice] setting will not work if you use an external phone or press **Hook** before entering the number. You will not be asked to re-enter the number.
- If you choose [On] or [Enter # Twice], you cannot use the Broadcasting feature.

6. Press **Stop/Exit**.

### DocuPrint M275 z/DocuPrint M285 z

1. Press  [Settings] > [All Settings] > [Fax] > [Dial Restriction].
2. Press one of the following options:
  - [Dial Pad]
  - [Address Book]



If you combine Address Book numbers when dialling, the address will be recognised as dial pad input and will not be restricted.

- [Shortcuts]
3. Press one of the following options:

---

| Option           | Description   |
|------------------|---|
| Enter #<br>Twice | The machine will prompt you to re-enter the number, and then if you re-enter the same number correctly, the machine will start dialling. If you re-enter the wrong number, the LCD will display an error message. |
| On               | The machine will restrict all fax sending and outbound calls for that dialling method.  |
| Off              | The machine does not restrict the dialling method.  |



- The [Enter # Twice] setting will not work if you use an external phone or press [Hook] before entering the number. You will not be asked to re-enter the number.
- If you choose [On] or [Enter # Twice], you cannot use the Broadcasting feature.

4. Press .



### Related Information

- [General Settings](#)

## Reduce Printing Noise

The Quiet Mode setting can reduce printing noise. When Quiet Mode is turned on, the print speed becomes slower. The factory setting is off.



>> [DocuPrint M235 dw/DocuPrint M235 z](#)

>> [DocuPrint M275 z/DocuPrint M285 z](#)

### DocuPrint M235 dw/DocuPrint M235 z

1. Press **Menu**.
2. Press **▲** or **▼** to display the [General Setup] option, and then press **OK**.
3. Press **▲** or **▼** to display the [Ecology] option, and then press **OK**.
4. Press **▲** or **▼** to display the [Quiet Mode] option, and then press **OK**.
5. Press **▲** or **▼** to display the [On] or [Off] option, and then press **OK**.
6. Press **Stop/Exit**.

### DocuPrint M275 z/DocuPrint M285 z

1. Press  [Settings] > [All Settings] > [General Setup] > [Ecology] > [Quiet Mode].
2. Press [On] or [Off].
3. Press .

### Related Information

- [General Settings](#)

## Change the Language on the LCD

Change the LCD language if needed.

This feature is not available in some countries.



>> [DocuPrint M235 dw/DocuPrint M235 z](#)

>> [DocuPrint M275 z/DocuPrint M285 z](#)

### DocuPrint M235 dw/DocuPrint M235 z

1. Press **Menu**.
2. Press **▲** or **▼** to display the [Initial Setup] option, and then press **OK**.
3. Press **▲** or **▼** to display the [Local Language] option, and then press **OK**.
4. Press **▲** or **▼** to display your language, and then press **OK**.
5. Press **Stop/Exit**.

### DocuPrint M275 z/DocuPrint M285 z

1. Press  [Settings] > [All Settings] > [Initial Setup] > [Local Language].
2. Press your language.
3. Press .

### Related Information

- [General Settings](#)

## Save Your Favourite Settings as a Shortcut

- [Add Shortcuts](#)
- [Change or Delete Shortcuts](#)



## Add Shortcuts







**Related Models:** DocuPrint M275 z/DocuPrint M285 z

You can add the Fax, Copy, or Scan settings you use most frequently by saving them as your Shortcuts. Later you can press the Shortcut to apply these settings instead of manually re-entering them.



Some Shortcut menus are not available depending on your model.

These instructions describe how to add a Copy Shortcut. The steps for adding a Fax or Scan Shortcut are very similar.

1. Press  ([Shortcuts]).
2. Press the button where you have not added a Shortcut.
3. Press  or  to display [Copy], and then press [Copy].
4. Press  or  to display the available settings, and then press the setting you want to change.
5. Press  or  to display the available options for the setting, and then press the option you want.  
Repeat these two steps until you have selected all the settings and options you want, and then press [OK].
6. When you have finished changing settings, press [Save as Shortcut].
7. Read and confirm the displayed list of settings you have selected, and then press [OK].
8. Enter a name for the Shortcut using the LCD, and then press [OK].



### Related Information

- [Save Your Favourite Settings as a Shortcut](#)

## Change or Delete Shortcuts

**Related Models:** DocuPrint M275 z/DocuPrint M285 z

1. Press  ([Shortcuts]).
2. Press ◀ or ▶ to display the Shortcut you want to change.
3. Press the Shortcut you want to change.

The settings for the Shortcut you selected appear.



To delete the Shortcut or edit the name, press and hold the Shortcut until the options appear, and then follow the on-screen menus.

4. Press [Options].
5. Change the settings for the Shortcut if needed.
6. Press [OK].
7. When finished, press [Save as Shortcut].
8. Read and confirm the displayed list of settings you have selected, and then press [OK].
9. Do one of the following:
  - To overwrite the Shortcut, press [Yes].
  - If you do not want to overwrite the Shortcut, press [No] to enter a new Shortcut name. Enter a new name using the LCD, and then press [OK].



To edit the name, hold down  to delete the current name.

Press [OK] to confirm.



### Related Information

- [Save Your Favourite Settings as a Shortcut](#)

## Print Reports

- [Reports](#)
- [Print a Report](#)

## Reports

The following reports are available:

### **Transmission (DocuPrint M235 z/DocuPrint M275 z/DocuPrint M285 z)**

The Transmission report prints a Transmission Verification Report of your last transmission.

### **Address Book (DocuPrint M235 z/DocuPrint M275 z/DocuPrint M285 z)**

The Address Book report prints an alphabetical list of names and numbers stored in the Address Book memory.

### **Fax Journal (DocuPrint M235 z/DocuPrint M275 z/DocuPrint M285 z)**

The Fax Journal prints a list of information about your last 200 incoming and outgoing faxes. (TX means Transmit, RX means Receive)

### **User Settings**

The User Settings report prints a list of your current settings.

### **Printer Settings**

The Printer Settings report prints a list of your current printer settings.

### **Network Configuration (Models with network functionality)**

The Network Configuration report prints a list of your current network settings.

### **Print File List**

The Print File List prints a list of the fonts and print macros stored in the machine.

### **Drum Dot Print**

The Drum Dot Print prints the drum dot sheet, which helps when it is time to clean the drum unit.

### **WLAN Report (Models with wireless network functionality)**

The WLAN Report prints the wireless LAN connectivity diagnosis.

### **Caller ID history (DocuPrint M235 z/DocuPrint M275 z/DocuPrint M285 z)**

The Caller ID history report prints a list of the available Caller ID information for the last 30 received faxes and telephone calls. (Only available for some countries.)



---

2-Line LCD models

To print the Caller ID list, use the Print Report option in the caller ID setting menu.

---



## Related Information

- [Print Reports](#)



## Print a Report

- >> [DocuPrint M235 dw/DocuPrint M235 z](#)
- >> [DocuPrint M275 z/DocuPrint M285 z](#)

### DocuPrint M235 dw/DocuPrint M235 z

1. Press **Menu**.
2. Press **▲** or **▼** to display the [Print Reports] option, and then press **OK**.
3. Press **▲** or **▼** to display the report you want to print, and then press **OK**.
4. Do one of the following:
  - If you choose [XMIT Verify], do one of the following:
    - To view the Transmission Verification Report, press **▲** or **▼** to display the [View on LCD], and then press **OK**.
    - To print the Transmission Verification Report, press **▲** or **▼** to display the [Print Report], and then press **OK**.  
Press **Start**.
  - If you choose other reports, Press **Start**.
5. Press **Stop/Exit**.

### DocuPrint M275 z/DocuPrint M285 z

1. Press  [Settings] > [All Settings] > [Print Reports].
2. Press **▲** or **▼** to display the report you want to print, and then press it.
3. Do one of the following:
  - If you choose [XMIT Verify], do one of the following:
    - To view the Transmission Verification Report, press [View on LCD].
    - To print the Transmission Verification Report, press [Print Report].
  - If you choose other reports, go to next step.
4. Press [Yes].
5. Press .

### Related Information

- [Print Reports](#)

## Settings and Features Tables

The Settings tables will help you understand the menu selections and options that are found in the machine's programs.

- [Settings Tables \(DocuPrint M235 z\)](#)
- [Settings Tables \(DocuPrint M235 dw\)](#)
- [Settings Tables \(DocuPrint M275 z/DocuPrint M285 z\)](#)
- [Features Tables \(DocuPrint M275 z/DocuPrint M285 z\)](#)

## Settings Tables (DocuPrint M235 z)

Related Models: DocuPrint M235 z

### [General Setup]

| Level 1       | Level 2        | Level 3 | Descriptions  |
|---------------|----------------|---------|---|
| Default Mode  | -              | -       | Select the default mode.  |
| Mode Timer    | -              | -       | Set the idle time before the machine returns to the default mode.   |
| Tray Setting  | Paper Type     | -       | Set the type of paper in the paper tray.  |
|               | Paper Size     | -       | Set the size of paper in the paper tray.  |
|               | Check Size     | -       | Select whether to display a message telling you to check that the size and type of the paper in the machine and the machine's Paper Size and Paper Type settings match.                         |
| Volume        | Ring           | -       | Adjust the ring volume.   |
|               | Beep           | -       | Adjust the beeper volume.   |
|               | Speaker        | -       | Adjust the speaker volume.  |
| Ecology       | Eco Mode       | -       | Turn the following machine settings on at the same time. <ul style="list-style-type: none"> <li>2-sided Print:Long Edge (Available only for certain models)</li> <li>Sleep Time:0Min</li> </ul> |
|               | Toner Save     | -       | Increase the page yield of the toner cartridge.   |
|               | Sleep Time     | -       | Set the number of minutes before the machine enters Sleep mode.   |
|               | Quiet Mode     | -       | Decrease printing noise.  |
|               | Auto Power Off | -       | Set the number of hours that the machine will remain in Deep Sleep mode before going into Power Off mode.   |
| LCD Contrast  | -              | -       | Adjust the LCD contrast.  |
| Security      | TX Lock        | -       | Prohibit most operations except receiving faxes.  |
|               | Setting Lock   | -       | Restrict unauthorised users from changing the machine's settings.   |
| Replace Toner | -              | -       | Set the machine to continue printing after the LCD displays <b>Replace Toner</b> .  |

### [Fax]

| Level 1       | Level 2        | Level 3 | Descriptions  |
|---------------|----------------|---------|---|
| Setup Receive | Receive Mode   | -       | Select the receive mode that best suits your needs.   |
|               | Ring Delay     | -       | Set the number of rings before the machine answers in Fax or Fax/Tel mode.  |
|               | F/T Ring Time  | -       | Set the length of the pseudo/double-ring time in Fax/Tel mode.  |
|               | Fax Detect     | -       | Receive fax messages automatically when you answer a call and hear fax tones.   |
|               | Remote Codes   | -       | Answer calls at an extension or external telephone and use codes to turn the Remote Codes on or off. You can personalise the codes. |
|               | Auto Reduction | -       | Reduce the size of incoming faxes.  |

| Level 1   | Level 2   | Level 3 | Descriptions   |
|---|---|---------|--|
| Setup Receive   | Fax Rx Stamp  | -       | Print the received time and date on the top of received faxes.   |
|   | 2-sided   | -       | Print received faxes on both sides of the paper.   |
| Setup Send  | Fax Resolution                                      | -       | Change the lightness or darkness of faxes you send.  |
|   | Contrast  | -       | Set the default resolution for outgoing faxes.   |
|   | Glass ScanSize                                      | -       | Adjust the scan area of the scanner glass to the size of the document.   |
|   | Real Time TX  | -       | Send a fax without using the memory.   |
|   | Coverpage   | Note    | Set up your own comments for the fax cover page.   |
|   | Overseas Mode                                       | -       | If you are having difficulty sending faxes overseas, set this to On.   |
|   | Auto Redial   | -       | Set the machine to redial the last fax number after five minutes, if the fax did not go through because the line was busy.   |
|   | Destination   | -       | Set the machine to display the destination information on the LCD during fax dialling.   |
| Anti-Junk Fax<br>(Available only for some countries.) | Register  | -       | Register specific fax numbers to the blocked list to avoid receiving faxes from the numbers.   |
|   | Delete  | -       | Delete the number from the blocked list.   |
|   | Print Report  | -       | You can print a list of registered fax numbers in the blocked list.  |
| Report Setting  | XMIT Verify   | -       | Select the initial setup for the Transmission Verification Report.   |
|   | Journal Period                                      | -       | Set the interval for automatic printing of the Fax Journal. If you select an option other than Off and Every 50 Faxes, you can set the time for the option. If you select Every 7 Days, you can set the day of the week. |
| Memory Receive  | Forward/Store                                       | -       | Set the machine to forward fax messages or to store incoming faxes in the memory (so you can retrieve them while you are away from your machine).  |
|   | PC Fax Receive                                      | -       | Set the machine to send faxes to your PC.  |
|   | Remote Access                                       | -       | Set your own code for Remote Retrieval.  |
|   | Print Document                                      | -       | Print received faxes stored in the machine's memory.   |
| Dial Restrict.  | Dial Pad  | -       | Set the machine to restrict dialling when using the dial pad.  |
|   | One Touch Dial                                      | -       | Set the machine to restrict the dialling of One Touch numbers.   |
|   | Speed Dial  | -       | Set the machine to restrict the dialling of Speed Dial numbers.  |
| Remaining Jobs  | -   | -       | Check which scheduled jobs are in the machine's memory and cancel selected jobs.   |
| Miscellaneous   | Distinctive<br>(Available only for some countries.) | -       | Turn on the telephone company's Distinctive Ring subscriber service to register your new ring pattern on the machine.  |
|   | Faxability<br>(For New Zealand.)                    | -       | If you have FaxAbility from Telecom, you can use this function to store the ringing pattern of your fax number. And if you set in to ON, you should use the registered number only.                                      |



| Level 1       | Level 2   | Level 3 | Descriptions   |
|---------------|---|---------|--|
| Miscellaneous | Call Waiting<br>(For New Zealand.)                | -       | If you have Call Waiting service, you can use this function to answer second call when you are on the phone and someone rings you. |
|               | Caller ID<br>(Available only for some countries.) | -       | Enable or disable to see the number (or name) of the party calling you.  |

### [Copy]

| Level 1  | Level 2   | Descriptions  |
|----------|-----------|---|
| Density  | -         | Adjust the density.                                   |
| Quality  | -         | Choose the Copy resolution for your type of document. |
| Contrast | -         | Adjust the contrast for copies.                       |
| ID Copy  | Density   | Adjust the density.                                   |
|          | Quality   | Choose the Copy resolution for your type of document. |
|          | Contrast  | Adjust the contrast for copies.                       |
|          | 2in1/1in1 | Make 2 in 1 ID copies.                                |

### [Printer]

| Level 1  | Level 2    | Level 3       | Descriptions  |
|--|------------|---------------|---|
| Emulation  | -          | -             | Set the printer emulation mode.   |
| Print Options                                      | Font List  | PCL emulation | Print a list of the machine's internal fonts.   |
|  |            | PS3 emulation |   |
|  | Test Print | -             | Print a test page.  |
| 2-sided<br>(For automatic 2-sided printing models) | -          | -             | Turn 2-sided printing off or on and select flip on long edge or short edge.                               |
| Auto Continue                                      | -          | -             | Select this setting if you want the machine to clear paper size errors, and to use the paper in the tray. |
| Tray Command                                       | -          | -             | Select this setting if a tray mismatch appears when you use the HP drivers.                               |
| Reset Printer                                      | -          | -             | Restore the printer settings to the factory settings.   |

### [Network]

#### For wired and wireless network models

| Level 1   | Level 2 | Level 3     | Descriptions  |
|-----------|---------|-------------|---|
| Wired LAN | TCP/IP  | Boot Method | Select the Boot method that best suits your needs.              |
|           |         | IP Address  | Enter the IP address.   |
|           |         | Subnet Mask | Enter the Subnet mask.  |
|           |         | Gateway     | Enter the Gateway address.                                      |
|           |         | Node Name   | Enter the Node name.<br>(Up to 32 characters)                   |
|           |         | WINS Config | Select the WINS configuration mode.                             |
|           |         | WINS Server | Specify the IP address of the primary or secondary WINS server. |

| Level 1        | Level 2        | Level 3  | Descriptions  |
|----------------|----------------|--|---|
| Wired LAN      | TCP/IP         | DNS Server   | Specify the IP address of the primary or secondary DNS server.                              |
|                |                | APIPA  | Set the machine to allocate the IP address from the link-local address range automatically. |
|                |                | IPv6   | Turn the IPv6 protocol on or off.   |
|                | Ethernet       | -  | Select the Ethernet link mode.  |
|                | Wired Status   | -  | View the current wired status.  |
|                | MAC Address    | -  | View the machine's MAC address.   |
|                | Set to Default | -  | Restore the wired network settings to the factory settings.                                 |
|                | Wired Enable   | -  | Turn the Wired LAN interface on or off manually.  |
| WLAN           | TCP/IP         | Boot Method  | Select the Boot method that best suits your needs.  |
|                |                | IP Address   | Enter the IP address.   |
|                |                | Subnet Mask  | Enter the Subnet mask.  |
|                |                | Gateway  | Enter the Gateway address.  |
|                |                | Node Name  | Enter the Node name.<br>(Up to 32 characters)   |
|                |                | WINS Config  | Select the WINS configuration mode.   |
|                |                | WINS Server  | Specify the IP address of the primary or secondary WINS server.                             |
|                |                | DNS Server   | Specify the IP address of the primary or secondary DNS server.                              |
|                |                | APIPA  | Set the machine to allocate the IP address from the link-local address range automatically. |
|                |                | IPv6   | Turn the IPv6 protocol on or off.   |
|                | Setup Wizard   | -  | Configure your wireless network settings manually.  |
|                | WLAN Assistant | -  | Configure your wireless network settings using the Fuji Xerox installation disc.            |
|                | WPS            | -  | Configure your wireless network settings using the one-button push method.                  |
|                | WPS w/PIN Code | -  | Configure your wireless network settings using WPS with a PIN.                              |
|                | WLAN Status    | Status   | View the current wireless network status.   |
|                |                | Signal   | View the current wireless network signal strength.  |
|                |                | Channel  | View the current wireless network channel.  |
|                |                | Speed  | View the current wireless network speed.  |
|                |                | SSID   | View the current SSID.  |
|                |                | Comm. Mode   | View the current Communication mode.  |
| MAC Address    | -              | View the machine's MAC address.                                |   |
| Set to Default | -              | Restore the wireless network settings to the factory settings. |   |
| WLAN Enable    | -              | Turn the WLAN on or off manually.                              |   |
| Wi-Fi Direct   | Push Button    | -  | Configure your Wi-Fi Direct network settings using the one-button push method.              |
|                | PIN Code       | -  | Configure your Wi-Fi Direct network settings using WPS with a PIN code.                     |
|                | Manual         | -  | Configure your Wi-Fi Direct network settings manually.                                      |

| Level 1       | Level 2      | Level 3                                     | Descriptions   |
|---------------|--------------|---|--|
| Wi-Fi Direct  | Group Owner  | -   | Set your machine as the Group Owner.   |
|               | Device Info. | Device Name                                 | View your machine's device name.   |
|               |              | SSID  | View the Group Owner's SSID.<br>When the machine is not connected, the LCD displays Not Connected.   |
|               |              | IP Address                                  | View your machine's current IP Address.  |
|               | Status Info. | Status                                      | View the current Wi-Fi Direct network status.  |
|               |              | Signal                                      | View the current Wi-Fi Direct network signal strength.<br>When your machine acts as Group Owner, the LCD always indicates a strong signal. |
|               |              | Channel                                     | View the current Wi-Fi Direct network channel.   |
|               |              | Speed                                       | View the current Wi-Fi Direct network speed.   |
| I/F Enable    | -            | Turn the Wi-Fi Direct connection on or off. |  |
| Network Reset | -            | -   | Restore all network settings back to the factory settings.   |

### [Print Reports]

| Level 1  | Level 2      | Descriptions   |
|--|--------------|--|
| XMIT Verify  | View on LCD  | Display a Transmission Verification Report of your last transmission.  |
|  | Print Report | Print a Transmission Verification Report of your last transmission.  |
| Address Book   | Numeric      | Print a list of names and numbers stored in the Address Book, in numerical order.                                      |
|  | Alphabetic   | Print a list of names and numbers stored in the Address Book, in alphabetical order.                                   |
| Fax Journal  | -            | Print a list of information about your last 200 incoming and outgoing faxes.<br>(TX means Transmit. RX means Receive.) |
| User Settings  | -            | Print a list of your settings.   |
| Print Settings                                       | -            | Print a list of your Printer settings.   |
| Network Config                                       | -            | Print a list of your Network settings.   |
| PrintFileList<br>(Available only for certain models) | -            | Print a list of data saved in the machine's memory.  |
| Drum Dot Print                                       | -            | Print the Drum Dot Check Sheet.  |
| WLAN Report  | -            | Print the wireless LAN connection results.   |
| Caller ID<br>(Available only for certain models)     | -            | Enable or disable to see the number (or name) of the party calling you.  |

### [Machine Info.]

| Level 1      | Level 2 | Descriptions   |
|--------------|---------|--|
| Serial No.   | -       | Check your machine's serial number.                                      |
| Version      | -       | Check your machine's firmware version.                                   |
| Page Counter | Total   | Check the total number of pages the machine has printed during its life. |
|              | Fax     |  |

| Level 1      | Level 2 | Descriptions   |
|--------------|---------|--|
| Page Counter | Copy    | Check the total number of pages the machine has printed during its life. |
|              | Print   |  |
|              | Other   |  |
| Parts Life   | Toner   | View the approximate remaining toner life.                               |
|              | Drum    | You can check the percentage of Drum life that remains available.        |

### [Initial Setup]

| Level 1   | Level 2  | Descriptions  |
|---|--|---|
| Date&Time   | Date&Time  | Add the date and time on the screen and in the headings of the faxes you send.  |
|   | Daylight Save  | Set the machine to change automatically for Daylight Saving Time.   |
|   | Time Zone  | Set your time zone.   |
| Station ID  | -  | Enter your name and fax number so it appears on each page you fax.  |
| Tone/Pulse<br>(Not available in New Zealand)          | -  | Select the dialling mode.   |
| Dial Tone   | -  | Shorten the dial tone detect pause.   |
| Dial Prefix   | -  | Set a prefix number to be added before the fax number every time you dial.  |
| Compatibility   | -  | Adjust the equalisation for transmission difficulties.<br>VoIP service providers offer fax support using various standards. If you regularly experience fax transmission errors, select Basic (for VoIP). |
| Reset   | Machine Reset  | Restore all the machine settings that you have changed.   |
|   | Network Reset<br>(For models with network functionality) | Restore all network settings back to the factory settings.  |
|   | Address & Fax  | Erase all stored phone numbers and fax settings.  |
|   | All Settings   | Restore all the machine's settings back to the factory settings.  |
|   | Factory Reset  | Restores all the machine's settings to the factory defaults. Perform this operation when you dispose of your machine.   |
| Local Language<br>(Available only for certain models) | -  | Change your LCD language.   |



### Related Information

- [Settings and Features Tables](#)

## Settings Tables (DocuPrint M235 dw)

Related Models: DocuPrint M235 dw

### [General Setup]

| Level 1       | Level 2        | Level 3 | Descriptions  |
|---------------|----------------|---------|---|
| Tray Setting  | Paper Type     | -       | Set the type of paper in the paper tray.  |
|               | Paper Size     | -       | Set the size of paper in the paper tray.  |
|               | Check Size     | -       | Select whether to display a message telling you to check that the size and type of the paper in the machine and the machine's Paper Size and Paper Type settings match.                             |
| Ecology       | Eco Mode       | -       | Turn the following machine settings on at the same time. <ul style="list-style-type: none"> <li>2-sided Print:Long Edge<br/>(Available only for certain models)</li> <li>Sleep Time:0Min</li> </ul> |
|               | Toner Save     | -       | Increase the page yield of the toner cartridge.   |
|               | Sleep Time     | -       | Set the number of minutes before the machine enters Sleep mode.   |
|               | Quiet Mode     | -       | Decrease printing noise.  |
|               | Auto Power Off | -       | Set the number of hours that the machine will remain in Deep Sleep mode before going into Power Off mode.   |
| LCD Contrast  | -              | -       | Adjust the LCD contrast.  |
| Replace Toner | -              | -       | Set the machine to continue printing after the LCD displays Replace Toner.  |

### [Copy]

| Level 1  | Level 2   | Descriptions  |
|----------|-----------|---|
| Density  | -         | Adjust the density.                                   |
| Quality  | -         | Choose the Copy resolution for your type of document. |
| Contrast | -         | Adjust the contrast for copies.                       |
| ID Copy  | Density   | Adjust the density.                                   |
|          | Quality   | Choose the Copy resolution for your type of document. |
|          | Contrast  | Adjust the contrast for copies.                       |
|          | 2in1/1in1 | Make 2 in 1 ID copies.                                |

### [Printer]

| Level 1       | Level 2       | Level 3       | Descriptions  |
|---------------|---------------|---------------|---|
| Emulation     | -             | -             | Set the printer emulation mode.   |
| Print Options | Font List     | PCL emulation | Print a list of the machine's internal fonts.                               |
|               |               | PS3 emulation |   |
|               | Test Print    | -             | Print a test page.  |
| 2-sided       | 2-sided Print | -             | Turn 2-sided printing off or on and select flip on long edge or short edge. |

| Level 1       | Level 2      | Level 3 | Descriptions  |
|---------------|--------------|---------|---|
| 2-sided       | Single Image | -       | For a print job where the last page is a 1-sided image, select the 1-sided Feed option to reduce printing time. |
| Auto Continue | -            | -       | Select this setting if you want the machine to clear paper size errors, and to use the paper in the tray.       |
| Tray Command  | -            | -       | Select this setting if a tray mismatch appears when you use the HP drivers.                                     |
| Reset Printer | -            | -       | Restore the printer settings to the factory settings.   |

## [Network]

### For wired and wireless network models

| Level 1        | Level 2      | Level 3     | Level 4   | Descriptions   |
|----------------|--------------|-------------|---|--|
| Wired LAN      | TCP/IP       | Boot Method | -   | Select the Boot method that best suits your needs.   |
|                |              | IP Address  | -   | Enter the IP address.                                |
|                |              | Subnet Mask | -   | Enter the Subnet mask.                               |
|                |              | Gateway     | -   | Enter the Gateway address.                           |
|                |              | Node Name   | -   | Enter the Node name.<br>(Up to 32 characters)        |
|                |              | WINS Config | -   | Select the WINS configuration mode.                  |
|                |              | WINS Server | Primary   | Specify the IP address of the primary WINS server.   |
|                |              |             | Secondary   | Specify the IP address of the secondary WINS server. |
|                |              | DNS Server  | Primary   | Specify the IP address of the primary DNS server.    |
|                |              |             | Secondary   | Specify the IP address of the secondary DNS server.  |
|                | APIPA        | -           | Set the machine to allocate the IP address from the link-local address range automatically. |  |
|                | IPv6         | -           | Turn the IPv6 protocol on or off.   |  |
|                | Ethernet     | -           | -   | Select the Ethernet link mode.                       |
|                | Wired Status | -           | -   | View the current wired status.                       |
| MAC Address    | -            | -           | View the machine's MAC address.   |  |
| Set to Default | -            | -           | Restore the wired network settings to the factory settings.                                 |  |
| Wired Enable   | -            | -           | Turn the Wired LAN interface on or off manually.  |  |
| WLAN           | TCP/IP       | Boot Method | -   | Select the Boot method that best suits your needs.   |
|                |              | IP Address  | -   | Enter the IP address.                                |
|                |              | Subnet Mask | -   | Enter the Subnet mask.                               |
|                |              | Gateway     | -   | Enter the Gateway address.                           |
|                |              | Node Name   | -   | Enter the Node name.<br>(Up to 32 characters)        |
|                |              | WINS Config | -   | Select the WINS configuration mode.                  |
|                |              | WINS Server | Primary   | Specify the IP address of the primary WINS server.   |

| Level 1      | Level 2        | Level 3     | Level 4   | Descriptions   |  |
|--------------|----------------|-------------|-----------|--|--|
| WLAN         | TCP/IP         | WINS Server | Secondary | Specify the IP address of the secondary WINS server.   |  |
|              |                | DNS Server  | Primary   | Specify the IP address of the primary DNS server.  |  |
|              |                |             | Secondary | Specify the IP address of the secondary DNS server.  |  |
|              |                | APIPA       | -         | Set the machine to allocate the IP address from the link-local address range automatically.  |  |
|              |                | IPv6        | -         | Turn the IPv6 protocol on or off.  |  |
|              | Setup Wizard   | -           | -         | Configure your wireless network settings manually.   |  |
|              | WLAN Assistant | -           | -         | Configure your wireless network settings using the Fuji Xerox installation disc.   |  |
|              | WPS            | -           | -         | Configure your wireless network settings using the one-button push method.   |  |
|              | WPS w/PIN Code | -           | -         | Configure your wireless network settings using WPS with a PIN.   |  |
|              | WLAN Status    | Status      | -         | View the current wireless network status.  |  |
|              |                | Signal      | -         | View the current wireless network signal strength.   |  |
|              |                | Channel     | -         | View the current wireless network channel.   |  |
|              |                | Speed       | -         | View the current wireless network speed.   |  |
|              |                | SSID        | -         | View the current SSID.   |  |
|              |                | Comm. Mode  | -         | View the current Communication mode.   |  |
|              | MAC Address    | -           | -         | View the machine's MAC address.  |  |
|              | Set to Default | -           | -         | Restore the wireless network settings to the factory settings.   |  |
|              | WLAN Enable    | -           | -         | Turn the WLAN on or off manually.  |  |
|              | Wi-Fi Direct   | Push Button | -         | -  | Configure your Wi-Fi Direct network settings using the one-button push method. |
|              |                | PIN Code    | -         | -  | Configure your Wi-Fi Direct network settings using WPS with a PIN code.        |
| Manual       |                | -           | -         | Configure your Wi-Fi Direct network settings manually.   |  |
| Group Owner  |                | -           | -         | Set your machine as the Group Owner.   |  |
| Device Info. |                | Device Name | -         | View your machine's device name.   |  |
|              |                | SSID        | -         | View the Group Owner's SSID.<br>When the machine is not connected, the LCD displays Not Connected.   |  |
|              |                | IP Address  | -         | View your machine's current IP Address.  |  |
| Status Info. |                | Status      | -         | View the current Wi-Fi Direct network status.  |  |
|              |                | Signal      | -         | View the current Wi-Fi Direct network signal strength.<br>When your machine acts as Group Owner, the LCD always indicates a strong signal. |  |
|              |                | Channel     | -         | View the current Wi-Fi Direct network channel.   |  |
|              |                | Speed       | -         | View the current Wi-Fi Direct network speed.   |  |
| I/F Enable   |                | -           | -         | Turn the Wi-Fi Direct connection on or off.  |  |

| Level 1       | Level 2 | Level 3 | Level 4 | Descriptions   |
|---------------|---------|---------|---------|--|
| Network Reset | -       | -       | -       | Restore all network settings back to the factory settings. |

### [Print Reports]

| Level 1  | Level 2 | Descriptions  |
|--|---------|---|
| User Settings  | -       | Print a list of your settings.                      |
| Print Settings   | -       | Print a list of your Printer settings.              |
| Network Config<br>(For models with network function)       | -       | Print a list of your Network settings.              |
| PrintFileList<br>(Available only for certain models)       | -       | Print a list of data saved in the machine's memory. |
| Drum Dot Print   | -       | Print the Drum Dot Check Sheet.                     |
| WLAN Report<br>(For models with wireless network function) | -       | Print the wireless LAN connection results.          |

### [Machine Info.]

| Level 1      | Level 2 | Descriptions   |
|--------------|---------|--|
| Serial No.   | -       | Check your machine's serial number.                                      |
| Version      | -       | Check your machine's firmware version.                                   |
| Page Counter | Total   | Check the total number of pages the machine has printed during its life. |
|              | Copy    |  |
|              | Print   |  |
|              | Other   |  |
| Parts Life   | Toner   | View the approximate remaining toner life.                               |
|              | Drum    | You can check the percentage of Drum life that remains available.        |

### [Initial Setup]

| Level 1   | Level 2  | Descriptions  |
|---|--|---|
| Reset   | Machine Reset  | Restore all the machine settings that you have changed.   |
|   | Network Reset<br>(For models with network functionality) | Restore all network settings back to the factory settings.  |
|   | All Settings   | Restore all the machine's settings back to the factory settings.  |
|   | Factory Reset  | Restores all the machine's settings to the factory defaults. Perform this operation when you dispose of your machine. |
| Local Language<br>(Available only for certain models) | -  | Change your LCD language.   |



### Related Information

- [Settings and Features Tables](#)



## Settings Tables (DocuPrint M275 z/DocuPrint M285 z)

Related Models: DocuPrint M275 z/DocuPrint M285 z

### ([Settings])

| Level 1  | Level 2  | Descriptions  |
|--|--|---|
| Toner  | Toner Life   | View the approximate remaining toner life.  |
|  | Test Print   | Print a test page.  |
| Network  | Wired LAN  | Access the Wired LAN setting menus.   |
|  | WLAN   | Access the WLAN setting menus.  |
| Tray Setting<br>(For models with Manual Feed Slot) | Paper Type   | Set the type of paper in the paper tray.  |
|  | Paper Size   | Set the size of paper in the paper tray.  |
|  | Check Size   | Select whether to display a message telling you to check that the size and type of the paper in the machine and the machine's Paper Size and Paper Type settings match.   |
| Tray Setting<br>(For models with MP Tray)          | Paper Type   | Set the type of paper in the paper tray.  |
|  | Paper Size   | Set the size of paper in the paper tray.  |
|  | Check Size   | Select whether to display a message telling you to check that the size and type of the paper in the machine and the machine's Paper Size and Paper Type settings match.   |
|  | Tray Use: Copy<br>(Available only for certain models)  | Select the tray to be used for Copy.  |
|  | Tray Use: Fax<br>(Available only for certain models)   | Select the tray to be used for Fax.   |
|  | Tray Use: Print<br>(Available only for certain models) | Select the tray to be used for Print.   |
| Wi-Fi Direct                                       | -  | Access the Wi-Fi Direct setting menus.  |
| Eco Mode   | -  | Turn the following machine settings on at the same time. <ul style="list-style-type: none"> <li>2-sided Print:Long Edge (Available only for certain models)</li> <li>Sleep Time:0Min</li> <li>Dim Timer:10Secs</li> </ul> |
| All Settings                                       | -  | Configure the detailed settings.  |

### [All Settings] > [General Setup]

| Level 1  | Level 2    | Descriptions  |
|--|------------|---|
| Tray Setting<br>(For models with Manual Feed Slot) | Paper Type | Set the type of paper in the paper tray.  |
|  | Paper Size | Set the size of paper in the paper tray.  |
|  | Check Size | Select whether to display a message telling you to check that the size and type of the paper in the machine and the machine's Paper Size and Paper Type settings match. |
| Tray Setting                                       | Paper Type | Set the type of paper in the paper tray.  |

| Level 1                   | Level 2   | Descriptions   |
|---------------------------|---|--|
| (For models with MP Tray) | <b>Paper Size</b>   | Set the size of paper in the paper tray.   |
|                           | <b>Check Size</b>   | Select whether to display a message telling you to check that the size and type of the paper in the machine and the machine's Paper Size and Paper Type settings match.  |
|                           | <b>Tray Use: Copy</b><br>(Available only for certain models)  | Select the tray to be used for Copy.   |
|                           | <b>Tray Use: Fax</b><br>(Available only for certain models)   | Select the tray to be used for Fax.  |
|                           | <b>Tray Use: Print</b><br>(Available only for certain models) | Select the tray to be used for Print.  |
| <b>Volume</b>             | <b>Ring</b>   | Adjust the ring volume.  |
|                           | <b>Beep</b>   | Adjust the beeper volume.  |
|                           | <b>Speaker</b>  | Adjust the speaker volume.   |
| <b>LCD Settings</b>       | <b>Backlight</b>  | Adjust the brightness of the LCD backlight.  |
|                           | <b>Dim Timer</b>  | Set how long the LCD backlight stays on after you go back to your Home screen.   |
| <b>Screen Settings</b>    | <b>Scan Screen</b>  | Set the default Scan screen settings.  |
| <b>Ecology</b>            | <b>Eco Mode</b>   | Turn the following machine settings on at the same time. <ul style="list-style-type: none"> <li>• 2-sided Print:Long Edge(Available only for certain models)</li> <li>• Sleep Time:0Min</li> <li>• Dim Timer:10Secs</li> </ul> |
|                           | <b>Toner Save</b>   | Increase the page yield of the toner cartridge.  |
|                           | <b>Sleep Time</b>   | Set the number of minutes before the machine enters Sleep mode.  |
|                           | <b>Quiet Mode</b>   | Decrease printing noise.   |
|                           | <b>Auto Power Off</b>   | Set the number of hours that the machine will remain in Deep Sleep mode before going into Power Off mode. Choose <i>Off</i> if you do not want the machine to go into Power Off mode.  |
| <b>Setting Lock</b>       | <b>Set Password</b>   | Restrict unauthorised users from changing the machine's settings.  |
|                           | <b>Lock Off⇒On</b>  |  |
| <b>Replace Toner</b>      | -   | Set the machine to continue printing after the LCD displays <i>Replace Toner</i> .   |

**[All Settings] > [Shortcut Settings]**

| Level 1                   | Level 2       | Descriptions                  |
|---------------------------|---------------|-------------------------------|
| (Select shortcut button.) | <b>Rename</b> | Change the shortcut name.     |
|                           | <b>Edit</b>   | Change the shortcut settings. |
|                           | <b>Delete</b> | Delete the shortcut.          |

**[All Settings] > [Fax]**

| Level 1              | Level 2             | Level 3 | Descriptions  |
|----------------------|---------------------|---------|---|
| <b>Setup Receive</b> | <b>Receive Mode</b> | -       | Select the Receive Mode that best suits your needs. |

| Level 1          | Level 2        | Level 3        | Descriptions   |
|------------------|----------------|----------------|--|
| Setup Receive    | Ring Delay     | -              | Set the number of rings before the machine answers in Fax or Fax/Tel mode.   |
|                  | F/T Ring Time  | -              | Set the length of the pseudo/double-ring time in Fax/Tel mode.   |
|                  | Fax Preview    | -              | View received faxes on the LCD.  |
|                  | Fax Detect     | -              | Receive fax messages automatically when you answer a call and hear fax tones.  |
|                  | Remote Codes   | -              | Answer calls at an extension or external telephone and use codes to turn the Remote Codes on or off. You can personalise the codes.  |
|                  | Auto Reduction | -              | Reduce the size of incoming faxes.   |
|                  | PC Fax Receive | -              | Set the machine to send faxes to your computer. You can turn on the Backup Print safety feature.   |
|                  | Memory Receive | -              | Set the machine to forward fax messages or to store incoming faxes in the memory (so you can retrieve them while you are away from your machine).<br>If you select Fax Forward, you can turn on the Backup Print safety feature. |
|                  | Fax Rx Stamp   | -              | Print the received time and date on the top of received faxes.   |
|                  | 2-sided        | -              | Print received faxes on both sides of the paper.   |
| Setup Send       | Coverpage Note | -              | Set up your own comments for the fax cover page.   |
|                  | Auto Redial    | -              | Set the machine to redial the last fax number after five minutes, if the fax did not go through because the line was busy.   |
|                  | Destination    | -              | Set the machine to display the destination information on the LCD during fax dialling.   |
| Anti-Junk Fax    | Register       | -              | Register specific fax numbers to the blocked list to avoid receiving faxes from the numbers.   |
|                  | Delete         | -              | Delete the number from the blocked list.   |
|                  | Print Reports  | -              | You can print a list of registered fax numbers in the blocked list.  |
| Report Setting   | XMIT Report    | -              | Select the initial setup for the Transmission Verification Report.   |
|                  | Journal Period | Journal Period | Set the interval for automatic printing of the Fax Journal. If you select an option other than Off and Every 50 Faxes, you can set the time for the option.<br>If you select Every 7 Days, you can set the day of the week.      |
|                  |                | Time           | If you select an option other than Off and Every 50 Faxes, you can set the time for the option.<br>If you select Every 7 Days, you can set the day of the week.  |
|                  |                | Day            | If you select Every 7 Days, you can set the day of the week.   |
| Print Document   | -              | -              | Print received faxes stored in the machine's memory.   |
| Remote Access    | -              | -              | Set your own code for Remote Retrieval.  |
| Dial Restriction | Dial Pad       | -              | Set the machine to restrict dialling when using the dial pad.  |

| Level 1   | Level 2   | Level 3 | Descriptions  |
|---|---|---------|---|
| Dial Restriction                                  | Address Book  | -       | Set the machine to restrict the dialling when using the Address Book.   |
|   | Shortcuts   | -       | Set the machine to restrict the dialling when using a Shortcut.   |
| Remaining Jobs                                    | -   | -       | Check which scheduled jobs are in the machine's memory and cancel selected jobs.  |
| Miscellaneous                                     | Distinctive<br>(Available only for some countries.) | -       | Turn on the telephone company's Distinctive Ring subscriber service to register your new ring pattern on the machine.   |
|   | FaxAbility<br>(For New Zealand.)                    | -       | If you have FaxAbility from Telecom, you can use this function to store the ringing pattern of your fax number. And if you set in to ON, you should use the registered number only. |
|   | Call Waiting<br>(For New Zealand.)                  | -       | If you have Call Waiting service, you can use this function to answer second call when you are on the phone and someone rings you.  |
| Caller ID<br>(Available only for some countries.) | -   | -       | Enable or disable to see the number (or name) of the party calling you.   |

[All Settings] > [Printer]

| Level 1       | Level 2       | Level 3       | Descriptions  |
|---------------|---------------|---------------|---|
| Emulation     | -             | -             | Select the emulation mode.  |
| Print Options | Font List     | PCL emulation | Print a list of the machine's internal fonts.   |
|               |               | PS3 emulation |   |
|               | Test Print    | -             | Print a test page.  |
| 2-sided       | 2-sided Print | -             | Enable or disable 2-sided printing and choose long edge or short edge.  |
|               | Single Image  | -             | For a print job where the last page is a 1-sided image, select the 1-sided Feed option to reduce printing time. |
| Auto Continue | -             | -             | Select this setting if you want the machine to clear paper size errors, and to use the paper in the tray.       |
| Tray Command  | -             | -             | Select the correct version of HP LaserJet tray emulation.   |
| Reset Printer | -             | -             | Restore the printer settings to the factory settings.   |

[All Settings] > [Network]

| Level 1   | Level 2 | Level 3            | Level 4 | Descriptions                                       |
|-----------|---------|--------------------|---------|--|
| Wired LAN | TCP/IP  | BOOT Method        | -       | Select the Boot method that best suits your needs. |
|           |         | IP Address         | -       | Enter the IP address.                              |
|           |         | Subnet Mask        | -       | Enter the Subnet mask.                             |
|           |         | Gateway            | -       | Enter the Gateway address.                         |
|           |         | Node Name          | -       | Enter the Node name.<br>(up to 32 characters)      |
|           |         | WINS Configuration | -       | Select the WINS configuration mode.                |
|           |         | WINS Server        | Primary | Specify the IP address of the primary WINS server. |

| Level 1     | Level 2         | Level 3            | Level 4   | Descriptions  |
|-------------|-----------------|--------------------|---|---|
| Wired LAN   | TCP/IP          | WINS Server        | Secondary   | Specify the IP address of the secondary WINS server.  |
|             |                 | DNS Server         | Primary   | Specify the IP address of the primary DNS server.   |
|             |                 |                    | Secondary   | Specify the IP address of the secondary DNS server.   |
|             |                 | APIPA              | -   | Set the machine to allocate the IP address from the link-local address range automatically. |
|             | IPv6            | -                  | Turn the IPv6 protocol on or off.   |   |
|             | Ethernet        | -                  | -   | Select the Ethernet link mode.  |
|             | Wired Status    | -                  | -   | View the current wired status.  |
|             | MAC Address     | -                  | -   | View the machine's MAC address.   |
|             | Set to Default  | -                  | -   | Restore the wired network settings to the factory settings.                                 |
|             | Wired Enable    | -                  | -   | Turn the Wired LAN interface on or off manually.  |
| WLAN        | TCP/IP          | BOOT Method        | -   | Select the Boot method that best suits your needs.  |
|             |                 | IP Address         | -   | Enter the IP address.   |
|             |                 | Subnet Mask        | -   | Enter the Subnet mask.  |
|             |                 | Gateway            | -   | Enter the Gateway address.  |
|             |                 | Node Name          | -   | Enter the Node name.<br>(up to 32 characters)   |
|             |                 | WINS Configuration | -   | Select the WINS configuration mode.   |
|             |                 | WINS Server        | Primary   | Specify the IP address of the primary WINS server.  |
|             |                 |                    | Secondary   | Specify the IP address of the secondary WINS server.  |
|             |                 | DNS Server         | Primary   | Specify the IP address of the primary DNS server.   |
|             |                 |                    | Secondary   | Specify the IP address of the secondary DNS server.   |
|             | APIPA           | -                  | Set the machine to allocate the IP address from the link-local address range automatically. |   |
|             | IPv6            | -                  | Turn the IPv6 protocol on or off.   |   |
|             | Setup Wizard    | -                  | -   | Configure your wireless network settings manually.  |
|             | WLAN Assistant  | -                  | -   | Configure your wireless network settings using the Fuji Xerox installation disc.            |
|             | WPS             | -                  | -   | Configure your wireless network settings using the one-button push method.                  |
|             | WPS w/ PIN Code | -                  | -   | Configure your wireless network settings using WPS with a PIN.                              |
| WLAN Status | Status          | -                  | View the current wireless network status.   |   |

| Level 1                                    | Level 2            | Level 3     | Level 4 | Descriptions   |  |
|--|--------------------|-------------|---------|--|--|
| WLAN                                       | WLAN Status        | Signal      | -       | View the current wireless network signal strength.                             |  |
|  |                    | SSID        | -       | View the current SSID.   |  |
|  |                    | Comm. Mode  | -       | View the current Communication mode.   |  |
|  | MAC Address        | -           | -       | View the machine's MAC address.  |  |
|  | Set to Default     | -           | -       | Restore the wireless network settings to the factory settings.                 |  |
|  | WLAN Enable        | -           | -       | Turn the wireless network connection On.                                       |  |
| Wi-Fi Direct                               | Push Button        | -           | -       | Configure your Wi-Fi Direct network settings using the one-button push method. |  |
|  | PIN Code           | -           | -       | Configure your Wi-Fi Direct network settings using WPS with a PIN code.        |  |
|  | Manual             | -           | -       | Configure your Wi-Fi Direct network settings manually.                         |  |
|  | Group Owner        | -           | -       | Set your machine as the Group Owner.   |  |
|  | Device Information | Device Name | -       | -  | View your machine's device name.   |
|  |                    | SSID        | -       | -  | View the Group Owner's SSID.<br>When the machine is not connected, the LCD displays Not Connected.   |
|  |                    | IP Address  | -       | -  | View your machine's current IP Address.  |
|  | Status Information | Status      | -       | -  | View the current Wi-Fi Direct network status.  |
|  |                    | Signal      | -       | -  | View the current Wi-Fi Direct network signal strength.<br>When your machine acts as Group Owner, the LCD always indicates a strong signal. |
|  | I/F Enable         | -           | -       | Turn the Wi-Fi Direct connection on or off.                                    |  |
| NFC<br>(Available only for certain models) | -                  | -           | -       | Turn the NFC function on or off.   |  |
| Network Reset                              | -                  | -           | -       | Restore all network settings back to the factory settings.                     |  |

[All Settings] > [Print Reports]

| Level 1       | Level 2      | Descriptions   |
|---------------|--------------|--|
| XMIT Verify   | View on LCD  | Display a Transmission Verification Report of your last transmission.  |
|               | Print Report | Print a Transmission Verification Report of your last transmission.  |
| Address Book  | -            | Print a list of names and numbers stored in the Address Book.  |
| Fax Journal   | -            | Print a list of information about your last 200 incoming and outgoing faxes.<br>(TX means Transmit. RX means Receive.) |
| User Settings | -            | Print a list of your settings.   |

| Level 1   | Level 2 | Descriptions  |
|---|---------|---|
| Printer Settings  | -       | Print a list of your Printer settings.  |
| Network Configuration   | -       | Print a list of your Network settings.  |
| Print File List   | -       | Print a list of data saved in the machine's memory.   |
| Drum Dot Print  | -       | Print the Drum Dot Check Sheet.   |
| WLAN Report<br>(For models with wireless network functionality) | -       | Print the wireless LAN connection results.  |
| Caller ID History<br>(Available only for some countries.)       | -       | Select a number from the Caller ID History and then send a fax to it, add it to the Address Book, or delete it. |

[All Settings] > [Machine Info.]

| Level 1          | Level 2      | Descriptions   |
|------------------|--------------|--|
| Serial No.       | -            | Check your machine's serial number.                                |
| Firmware Version | Main Version | Check your machine's firmware version.                             |
|                  | Sub1 Version |  |
| Page Counter     | Total        | Check the total number of pages the machine has printed.           |
|                  | Fax          |  |
|                  | Copy         |  |
|                  | Print        |  |
|                  | Other        |  |
| Parts Life       | Drum         | Check the percentage of the supplies' life that remains available. |

[All Settings] > [Initial Setup]

| Level 1                                      | Level 2       | Descriptions  |
|--|---------------|---|
| Date & Time                                  | Date          | Add the date and time on the screen and in the headings of the faxes you send.  |
|  | Time          |   |
|  | Clock Type    | Select the time format (12-hour or 24-hour).  |
|  | Daylight Save | Change for Daylight Saving Time manually.   |
|  | Time Zone     | Set your time zone.   |
| Station ID                                   | Fax           | Enter your name and fax number so it appears on each page you fax.  |
|  | Tel           |   |
|  | Name          |   |
| Tone/Pulse<br>(Not available in New Zealand) | -             | Select the dialling mode.   |
| Dial Tone                                    | -             | Shorten the dial tone detect pause.   |
| Dial Prefix                                  | -             | Set a prefix number to be added before the fax number every time you dial.  |
| Compatibility                                | -             | Adjust the equalisation for transmission difficulties.<br>VoIP service providers offer fax support using various standards. If you regularly experience fax transmission errors, select Basic (for VoIP). |
| Reset  | Machine Reset | Restore all the machine settings that you have changed.   |

| Level 1   | Level 2                       | Descriptions   |
|---|-------------------------------|--|
| <b>Reset</b>  | <b>Network Reset</b>          | Restore all network settings back to the factory settings.       |
|   | <b>Address Book &amp; Fax</b> | Erase all stored phone numbers and fax settings.                 |
|   | <b>All Settings</b>           | Restore all the machine's settings back to the factory settings. |
|   | <b>Factory Reset</b>          | Restore all settings back to the factory settings.               |
| <b>Local Language</b><br>(Available only for some countries.) | -                             | Change your LCD language.  |



## Related Information

- [Settings and Features Tables](#)





## Features Tables (DocuPrint M275 z/DocuPrint M285 z)

Related Models: DocuPrint M275 z/DocuPrint M285 z



[Fax]

| Level 1  | Level 2  | Level 3                       | Level 4   | Descriptions  |
|--|--|-------------------------------|---|---|
| Redial(Pause)  | -  | -                             | -   | Redial the last number called. When you are entering a fax or telephone number on the touchpanel, Redial changes to Pause on the LCD. Press Pause when you need a delay while dialling numbers, such as access codes and credit card numbers. You can also store a pause when you set up addresses. |
| Hook   | -  | -                             | -   | Press before dialling if you want to listen to make sure a fax machine has answered, and then press Fax Start.  |
| Address Book   | <br>(Search:) | -                             | -   | Search within the Address Book.   |
|  | Edit   | -                             | -   | Store Address Book numbers, set up Group numbers for Broadcasting, change and delete Address Book numbers.  |
|  | -  | Apply                         | -   | Start sending a fax using the Address Book.   |
| Call History<br>(For some countries,<br>Outgoing Call) | Outgoing Call  | (Select<br>Outgoing Call)     | Edit<br>Apply   | Select a number from the Outgoing Call history and then send a fax to it, add it to the Address Book, or delete it.   |
|  | Caller ID<br>History   | (Select Caller<br>ID History) | Edit<br>Apply   | Select a number from the Caller ID History and then send a fax to it, add it to the Address Book, or delete it.   |
| Fax Start  | -  | -                             | -   | Send a fax.   |
| Options  | Fax Resolution   | -                             | -   | Set the resolution for outgoing faxes.  |
|  | Contrast   | -                             | -   | Adjust the contrast.  |
|  | 2-sided Fax<br>(For automatic 2-<br>sided scanning<br>models)                                  | -                             | -   | Set the 2-sided scanning format.  |
|  | Glass Scan Size  | -                             | -   | Adjust the scan area of the scanner glass to the size of the document.  |
|  | Broadcasting   | Add Number                    | Add<br>Number<br>Add from<br>Address<br>book<br>Search<br>in<br>Address<br>book | Send the same fax message to more than one fax number.  |

| Level 1          | Level 2         | Level 3  | Level 4  | Descriptions  |
|------------------|-----------------|--|--|---|
| Options          | Delayed Fax     | Delayed Fax  | -  | Set the time of day the delayed faxes will be sent.   |
|                  |                 | Set Time   | -  |   |
|                  | Real Time TX    | -  | -  | Send a fax without using the memory.  |
|                  | Coverpage Setup | Coverpage Setup  | -  | Set the machine to automatically send a cover page that you have pre-programmed.                                    |
|                  |                 | Coverpage Note   | -  |   |
|                  |                 | Total Pages  | -  |   |
|                  | Overseas Mode   | -  | -  | Set to On if you have difficulty sending faxes overseas.  |
|                  | Call History    | Outgoing Call  | -  | Select a number from the Outgoing Call history and then send a fax to it, add it to the Address Book, or delete it. |
|                  |                 | Caller ID History  | -  | Select a number from the Caller ID History and then send a fax to it, add it to the Address Book, or delete it.     |
|                  | Address Book    | <br>(Search:) | -  | Search within the Address Book.   |
| Edit             |                 | -  | Store Address Book numbers, set up Group numbers for Broadcasting, change and delete Address Book numbers. |   |
| Set New Default  | -               | -  | Save your settings as the default.   |   |
| Factory Reset    | -               | -  | Restore all settings back to the factory settings.   |   |
| Save as Shortcut | -               | -  | -  | Save the current settings as a shortcut.  |



[Copy]

| Level 1   | Level 2   | Level 3  | Descriptions  |
|---|---|--|---|
| Start   | -   | -  | Make a monochrome or greyscale copy.                        |
| Options   | Enlarge/Reduce                                  | 100%   | -   |
|   |   | Enlarge  | Select an enlargement ratio for the next copy.              |
|   |   | Reduce   | Select a reduction ratio for the next copy.                 |
|   |   | Auto   | Adjust the copy size to fit on the paper size you have set. |
|   |   | Custom (25-400%)   | Enter an enlargement or reduction ratio.                    |
|   | Density   | -  | Adjust the density.   |
|   | Tray Use<br>(Available only for certain models) | -  | Select the tray to be used for Copy.                        |
| 2-sided Copy<br>(For automatic 2-sided printing models)             | -   | Turn off or turn on 2-sided copying and select flip on long edge or flip on short edge.  |   |
| 2-sided Copy Page Layout<br>(For automatic 2-sided printing models) | -   | Select a page layout option when you make 2-sided N in 1 copies from a 2-sided document. |   |

| Level 1          | Level 2     | Level 3 | Descriptions                                       |
|------------------|-------------|---------|--|
| Options          | Quality     | -       | Select the Copy resolution for your document type. |
|                  | Contrast    | -       | Adjust the contrast.                               |
|                  | Stack/Sort  | -       | Select to stack or sort multiple copies.           |
|                  | Page Layout | -       | Make N in 1 copies.                                |
| Save as Shortcut | -           | -       | Save the current settings as a shortcut.           |



## [Scan]

| Level 1   | Level 2         | Level 3          | Level 4          | Descriptions   |
|---|-----------------|------------------|------------------|--|
| to PC   | to File         | (Select PC)      | Options          | Scan documents and save them to a folder on your computer.                   |
|   |                 |                  | Save as Shortcut |  |
|   |                 |                  | Start            |  |
|   | to OCR          | (Select PC)      | Options          | Convert your scanned document to an editable text file.                      |
|   |                 |                  | Save as Shortcut |  |
|   |                 |                  | Start            |  |
|   | to Image        | (Select PC)      | Options          | Scan photos or graphics into your graphics applications.                     |
|   |                 |                  | Save as Shortcut |  |
|   |                 |                  | Start            |  |
|   | to E-mail       | (Select PC)      | Options          | Send a scanned document as an email attachment.                              |
|   |                 |                  | Save as Shortcut |  |
|   |                 |                  | Start            |  |
| to FTP<br>(Available only for certain models)   | (Profile name)  | Options          | -                | Scan documents directly to an FTP server.                                    |
|   |                 | Save as Shortcut | -                |  |
|   |                 | Start            | -                |  |
| to Network<br>(Available only for certain models)   | (Profile name)  | Options          | -                | Send scanned data to a CIFS server on your local network or on the Internet. |
|   |                 | Save as Shortcut | -                |  |
|   |                 | Start            | -                |  |
| WS Scan<br>(Appears when you install a Web Services Scanner, which is displayed in your computer's Network explorer.) | Scan            | -                | -                | Scan data using the Web Service protocol.                                    |
|   | Scan for E-mail | -                | -                |  |
|   | Scan for Fax    | -                | -                |  |
|   | Scan for Print  | -                | -                |  |



## [Secure Print]

| Level 1      | Level 2       | Level 3                   | Descriptions   |
|--------------|---------------|---------------------------|--|
| Secure Print | (Select User) | (Select Secure Print Job) | You can print data saved in the machine's memory when you enter your four-digit password.<br>Active only when the machine has secure print data. |



## ([Shortcuts])

| Level 1         | Level 2   | Level 3 | Level 4  | Descriptions   |  |  |
|-----------------|---|---------|--|--|--|--|
| Not Registered  | Copy  | Copy    | Enlarge/<br>Reduce                               | Change the settings in the Copy Options.               |  |  |
|                 |   |         | Density  |  |  |  |
|                 |   |         | Tray Use<br>(Available only for certain models)  |  |  |  |
|                 |   |         | 2-sided Copy<br>(For certain models)             |  |  |  |
|                 |   |         | 2-sided Copy Page Layout<br>(For certain models) |  |  |  |
|                 |   |         | Quality  |  |  |  |
|                 |   |         | Contrast   |  |  |  |
|                 |   |         | Stack/Sort                                       |  |  |  |
|                 |   |         | Page Layout                                      |  |  |  |
|                 |   |         | 2 in 1 ID Copy                                   |  |  |  |
|                 | Tray Use<br>(Available only for certain models) |         |  |  |  |  |
|                 | Quality   |         |  |  |  |  |
|                 | Contrast  |         |  |  |  |  |
|                 | Fax   |         | Fax Resolution                                   | -  | Set the resolution for outgoing faxes.   |  |
|                 |   |         |  | Contrast   | -  | Adjust the contrast.   |
|                 |   |         |  | 2-sided Fax<br>(For automatic 2-sided scanning models) | -  | Select the 2-sided fax scan mode.                                      |
|                 |   |         |  | Glass Scan Size  | -  | Adjust the scan area of the scanner glass to the size of the document. |
| Broadcasting    |   |         |  | Add Number   | Send the same fax message to more than one fax number.                           |  |
| Real Time TX    |   |         |  | -  | Send a fax without using the memory.   |  |
| Coverpage Setup |   |         |  | Coverpage Setup  | Set the machine to automatically send a cover page that you have pre-programmed. |  |

| Level 1   | Level 2      | Level 3   | Level 4  | Descriptions  |
|---|--------------|---|--|---|
| Not Registered  | Fax          | Coverpage Setup                                   | Coverpage Note   | Set the machine to automatically send a cover page that you have pre-programmed.                                |
|   |              |   | Total Pages  |   |
|   |              | Overseas Mode                                     | -  | Set to On if you have difficulty sending faxes overseas.  |
|   |              | Call History                                      | -  | Select a number from the Caller ID History and then send a fax to it, add it to the Address Book, or delete it. |
|   | Address Book | -   | Store Address Book numbers, set up Group numbers for Broadcasting, change and delete Address Book numbers. |   |
|   | Scan         | to File   | -  | Scan documents and save them to a folder on your computer.  |
|   |              | to OCR  | -  | Convert your scanned document to an editable text file.   |
|   |              | to Image  | -  | Scan photos or graphics into your graphics applications.  |
|   |              | to E-mail   | -  | Send a scanned document as an email attachment.   |
|   |              | to Network<br>(Available only for certain models) | -  | Send scanned data to a CIFS server on your local network or on the Internet.                                    |
| to FTP  |              | -   | Send scanned data via FTP.   |   |
| This list appears when each Shortcut name is pressed for 2 seconds. | Rename       | -   | -  | Change the shortcut name.   |
|   | Edit         | -   | -  | Change the shortcut settings.   |
|   | Delete       | -   | -  | Delete the shortcut.  |

## ([Toner])

| Level 1   | Level 2    | Descriptions                               |
|---|------------|--|
|  (Toner) | Toner Life | View the approximate remaining toner life. |
|   | Test Print | Print a test page.                         |

## WiFi (Wi-Fi Setup)



After the Wi-Fi® is set up, you cannot change the settings from your Home screen. Change the settings for Wi-Fi in the Settings screen.

| Level 1               | Level 2        | Descriptions   |
|-----------------------|----------------|--|
| WiFi<br>(Wi-Fi Setup) | Setup Wizard   | Configure your wireless network settings manually.                               |
|                       | WLAN Assistant | Configure your wireless network settings using the Fuji Xerox installation disc. |
|                       | WPS            | Configure your wireless network settings using the one-button push method.       |

## Related Information

- [Settings and Features Tables](#)

## Change Machine Settings from Your Computer

- [Change Machine Settings Using Web Based Management](#)
- [Change the Machine Settings Using Remote Setup](#)
- [Where Can I Find My Fuji Xerox Machine's Network Settings?](#)
- [Network Management Software and Utilities](#)

## Change Machine Settings Using Web Based Management

Web Based Management is a utility that uses a standard web browser to manage your machine using the Hyper Text Transfer Protocol (HTTP) or Hyper Text Transfer Protocol over Secure Socket Layer (HTTPS).

- [What is Web Based Management?](#)
- [Access Web Based Management](#)
- [Set a Login Password for Web Based Management](#)
- [Set Up Your Machine's Address Book Using Web Based Management](#)
- [Network Management Software and Utilities](#)

## What is Web Based Management?

Web Based Management is a utility that uses a standard web browser to manage your machine using the Hyper Text Transfer Protocol (HTTP) or Hyper Text Transfer Protocol over Secure Socket Layer (HTTPS). Type your machine's IP address into your web browser to access and change your print server settings.



- We recommend Microsoft® Internet Explorer® 11/Edge for Windows® and Safari 9/10/11 for Mac. Make sure that JavaScript and Cookies are always enabled in whichever browser you use.
- You must use the TCP/IP protocol on your network and have a valid IP address programmed into the print server and your computer.

- The actual screen may differ from the screen shown above.



### Related Information

- [Change Machine Settings Using Web Based Management](#)



## Access Web Based Management

- We recommend using the HTTPS security protocol when configuring settings using Web Based Management.
- When you use HTTPS for Web Based Management configuration, your browser will display a warning dialog box.

1. Start your web browser.
2. Type "http://machine's IP address" in your browser's address bar (where "machine's IP address" is the machine's IP address).

For example:

http://192.168.1.2



- If you are using a Domain Name System or enable a NetBIOS name, you can type another name, such as "SharedPrinter" instead of the IP address.

- For example:

http://SharedPrinter

If you enable a NetBIOS name, you can also use the node name.

- For example:

http://fxnxxxxxxxxxxxx

The NetBIOS name can be found in the Network Configuration Report.

- For Mac, access Web Based Management by clicking the machine's icon on the **Status Monitor** screen.

3. No password is required by default. Type a password if you have set one, and then click .

You can now change the print server settings.

If you change the protocol settings, you must restart the machine after clicking **Submit** to activate the configuration.



### Related Information

- [Change Machine Settings Using Web Based Management](#)
- [Print the Network Configuration Report](#)

## Set a Login Password for Web Based Management

We recommend setting a login password to prevent unauthorised access to Web Based Management.

1. Start your web browser.
2. Type "http://machine's IP address" in your browser's address bar (where "machine's IP address" is the machine's IP address).

For example:

http://192.168.1.2



- If you are using a Domain Name System or enable a NetBIOS name, you can type another name, such as "SharedPrinter" instead of the IP address.

- For example:

http://SharedPrinter

If you enable a NetBIOS name, you can also use the node name.

- For example:

http://fxnxxxxxxxxxxxx

The NetBIOS name can be found in the Network Configuration Report.

- For Mac, access Web Based Management by clicking the machine's icon on the **Status Monitor** screen.

3. No password is required by default. Type a password if you have set one, and then click .
4. Click **Administrator**.
5. Type the password you want to use in the **Enter New Password** field (8 to 32 characters).
6. Retype the password in the **Confirm New Password** field.
7. Click **Submit**.

In the future, every time you access Web Based Management, type the password in the **Login** field, and then click .

After configuring the settings, log off by clicking .



If you have not previously set a login password, you can also set a password by clicking the **Please configure the password** button on the machine's web page.



### Related Information

- [Change Machine Settings Using Web Based Management](#)

## Set Up Your Machine's Address Book Using Web Based Management

- We recommend using the HTTPS security protocol when configuring settings using Web Based Management.
- When you use HTTPS for Web Based Management configuration, your browser will display a warning dialog box.

1. Start your web browser.
2. Type "http://machine's IP address" in your browser's address bar (where "machine's IP address" is the machine's IP address).

For example:

http://192.168.1.2



- If you are using a Domain Name System or enable a NetBIOS name, you can type another name, such as "SharedPrinter" instead of the IP address.

- For example:

http://SharedPrinter

If you enable a NetBIOS name, you can also use the node name.

- For example:

http://fxnxxxxxxxxxxxx

The NetBIOS name can be found in the Network Configuration Report.

- For Mac, access Web Based Management by clicking the machine's icon on the **Status Monitor** screen.

3. No password is required by default. Type a password if you have set one, and then click .
4. Click the **Address Book** tab.
5. Add or update the Address Book information as needed.
6. Click **Submit**.



### Related Information

- [Change Machine Settings Using Web Based Management](#)
- [Remote Setup \(Windows®\)](#)
- [Remote Setup \(Mac\)](#)

## Change the Machine Settings Using Remote Setup

The Remote Setup program lets you configure many of your Fuji Xerox machine's settings from your computer. When you start Remote Setup, the settings on your Fuji Xerox machine will be downloaded to your computer and displayed on your screen. If you change the settings on your computer, you can upload them directly to the machine.

- [Remote Setup \(Windows®\)](#)
- [Remote Setup \(Mac\)](#)

## Remote Setup (Windows®)

- [Set Up the Fuji Xerox Machine from Your Computer \(Windows®\)](#)
- [Set Up the Fuji Xerox Machine Using ControlCenter4 \(Windows®\)](#)
- [Set Up Your Machine's Address Book Using ControlCenter4 \(Windows®\)](#)
- [Set Up Your Machine's Address Book Using Web Based Management](#)

## Set Up the Fuji Xerox Machine from Your Computer (Windows®)

**Related Models:** DocuPrint M235 z/DocuPrint M275 z/DocuPrint M285 z

 If Secure Function Lock is set to On, you cannot use Remote Setup.

1. Do one of the following:

- Windows® 7

Click  (**Start**) > **All Programs** > **Fuji Xerox** > **Fuji Xerox Utilities**.

Click the drop-down list and select your model name (if not already selected). Click **Tools** in the left navigation bar, and then click **Remote Setup**.

- Windows® 8 and Windows® 10

Launch  (**Fuji Xerox Utilities**), and then click the drop-down list and select your model name (if not already selected). Click **Tools** in the left navigation bar, and then click **Remote Setup**.

The Remote Setup Program window appears.

 When your machine is connected via a Network, type the password if required.

2. Configure the settings as needed.

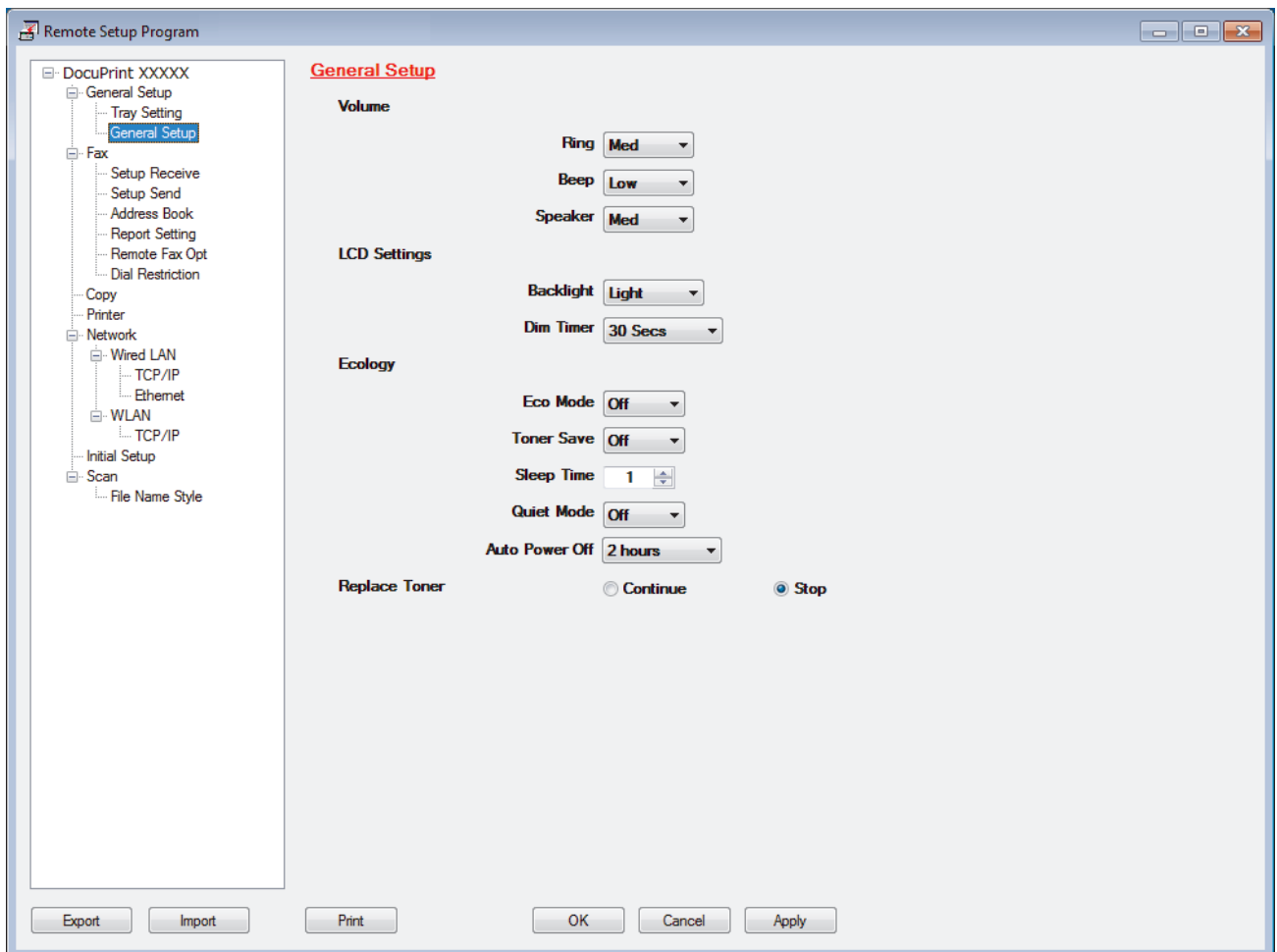

---

## Export

Click to save the current configuration settings to a file.



---

Click **Export** to save your address book or all settings for your machine.

---

## Import

Click to import a file and read its settings.

## Print

Click to print the selected items on the machine. You cannot print the data until it is uploaded to the machine. Click **Apply** to upload the new data to the machine, and then click **Print**.

## OK

Click to start uploading data to the machine, and then exit the Remote Setup Program. If an error message appears, confirm that your data is correct, and then click **OK**.

## Cancel

Click to exit the Remote Setup Program without uploading data to the machine.

## Apply

Click to upload data to the machine without exiting the Remote Setup Program.

3. Click **OK**.

- If your computer is protected by a firewall and is unable to use Remote Setup, you may need to configure the firewall settings to allow communication through port numbers 137 and 161.
- If you are using Windows® Firewall and you installed the Fuji Xerox software and drivers from the installation disc, the necessary firewall settings have already been set.



## Related Information

- [Remote Setup \(Windows®\)](#)
-

## Set Up the Fuji Xerox Machine Using ControlCenter4 (Windows®)

**Related Models:** DocuPrint M235 z/DocuPrint M275 z/DocuPrint M285 z



If Secure Function Lock is set to On, you cannot use Remote Setup.

1. Click the  (**ControlCenter4**) icon in the task tray, and then click **Open**.
2. Click the **Device Settings** tab.
3. Click the **Remote Setup** button.
4. Configure the settings as needed.

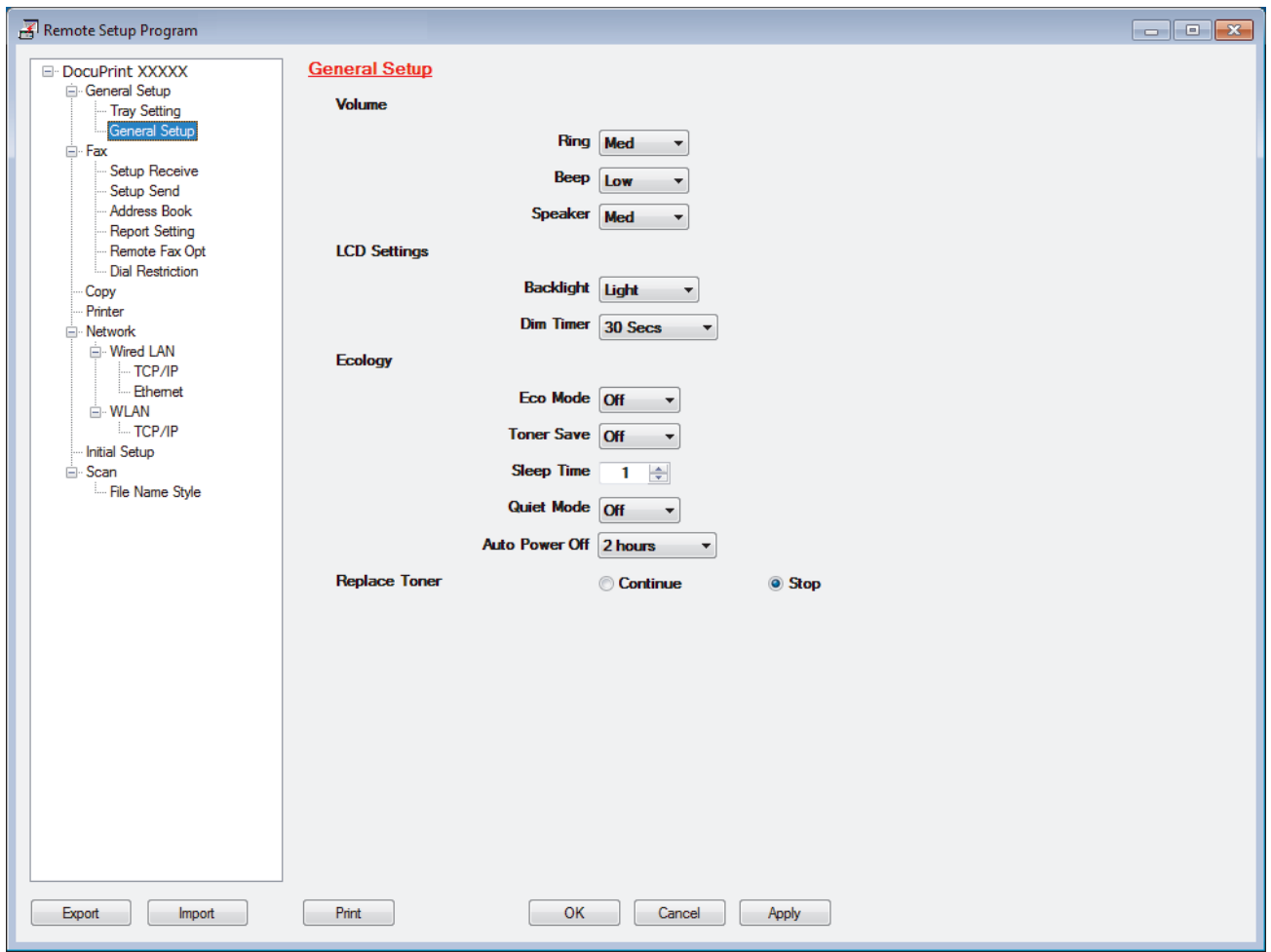

### Export

Click to save the current configuration settings to a file.



Click **Export** to save your address book or all settings for your machine.

### Import

Click to import a file and read its settings.

### Print

Click to print the selected items on the machine. You cannot print the data until it is uploaded to the machine. Click **Apply** to upload the new data to the machine, and then click **Print**.



---

**OK**

Click to start uploading data to the machine, and then exit the Remote Setup Program. If an error message appears, confirm that your data is correct, and then click **OK**.

**Cancel**

Click to exit the Remote Setup Program without uploading data to the machine.

**Apply**

Click to upload data to the machine without exiting the Remote Setup Program.

5. Click **OK**.

- If your computer is protected by a firewall and is unable to use Remote Setup, you may need to configure the firewall settings to allow communication through port numbers 137 and 161.
- If you are using Windows® Firewall and you installed the Fuji Xerox software and drivers from the installation disc, the necessary firewall settings have already been set.

**Related Information**

- [ControlCenter4 \(Windows®\)](#)
- [Remote Setup \(Windows®\)](#)

## Set Up Your Machine's Address Book Using ControlCenter4 (Windows®)

**Related Models:** DocuPrint M235 z/DocuPrint M275 z/DocuPrint M285 z

Use Remote Setup through CC4 to add or change Address Book numbers on your computer.



If Secure Function Lock is set to On, you cannot use Remote Setup.

1. Click the  (**ControlCenter4**) icon in the task tray, and then click **Open**.
2. Click the **Device Settings** tab.
3. Click the **Address Book** button.  
The **Address Book** opens in a Remote Setup window.
4. Add or update the Address Book information as needed.
5. Click **OK**.



### Related Information

- [Remote Setup \(Windows®\)](#)

## Remote Setup (Mac)

- [Set Up the Fuji Xerox Machine with a USB Cable Connection \(Mac\)](#)
- [Set Up Your Machine's Address Book with a USB Cable Connection \(Mac\)](#)
- [Set Up Your Machine's Address Book Using Web Based Management](#)

## Set Up the Fuji Xerox Machine with a USB Cable Connection (Mac)

**Related Models:** DocuPrint M235 z/DocuPrint M275 z/DocuPrint M285 z

Use Remote Setup to set up your Fuji Xerox machine with a USB cable connection.

To use Remote Setup, go to the download page for your model on the Fuji Xerox website at <http://www.fujixeroxprinters.com/> and download Remote Setup.



- If Secure Function Lock is set to On, you cannot use Remote Setup.
- Remote Setup for Mac supports USB connections only.

1. In the **Finder** menu bar, click **Go > Applications > Fuji Xerox**, and then double-click the Remote Setup icon. The Remote Setup Program screen appears.

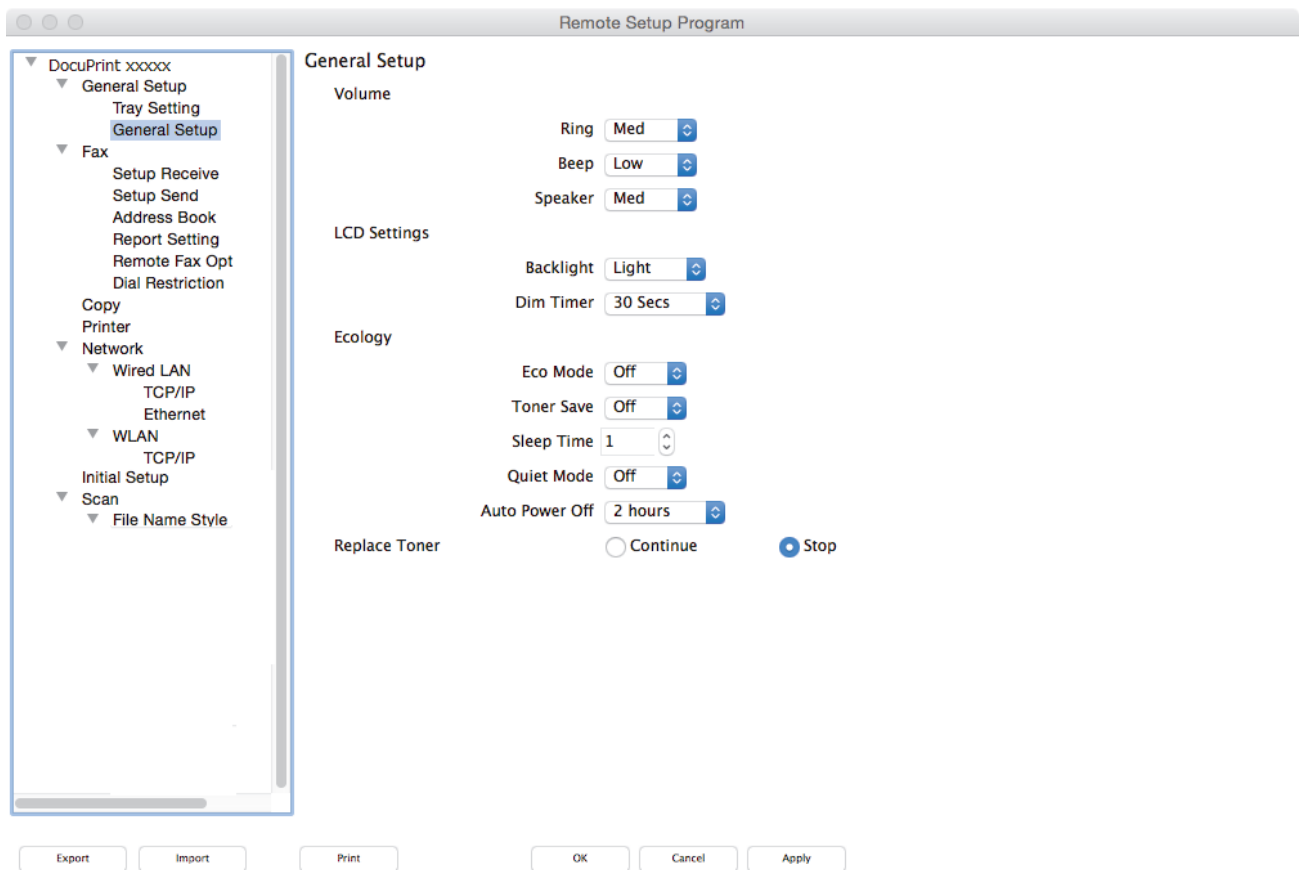

2. Configure the settings as needed.

### Export

Click to save the current configuration settings to a file.



Click **Export** to save your address book or all settings for your machine.

### Import

Click to import a file and read its settings.

---

**Print**

Click to print the selected items on the machine. You cannot print the data until it is uploaded to the machine. Click **Apply** to upload the new data to the machine, and then click **Print**.

**OK**

Click to start uploading data to the machine, and then exit the Remote Setup Program. If an error message appears, enter the correct data again, and then click **OK**.

**Cancel**

Click to exit the Remote Setup Program without uploading data to the machine.

**Apply**

Click to upload data to the machine without exiting the Remote Setup Program.

3. When finished, click **OK**.

**Related Information**

- [Remote Setup \(Mac\)](#)
-

## Set Up Your Machine's Address Book with a USB Cable Connection (Mac)

**Related Models:** DocuPrint M235 z/DocuPrint M275 z/DocuPrint M285 z

Use Remote Setup to add or change Address Book numbers on your computer with a USB cable connection.

To use Remote Setup, go to the download page for your model on the Fuji Xerox website at <http://www.fujixeroxprinters.com/> and download Remote Setup.



- If Secure Function Lock is set to On, you cannot use Remote Setup.
- Remote Setup for Mac supports USB connections only.

1. In the **Finder** menu bar, click **Go > Applications > Fuji Xerox**, and then double-click the Remote Setup icon. The Remote Setup Program screen appears.
2. In the left menu, click **Address Book** in the **Fax**.
3. Add or update the Address Book information as needed.
4. When finished, click **OK**.



### Related Information

- [Remote Setup \(Mac\)](#)

## Appendix

- [Specifications](#)
- [How to Enter Text on Your Fuji Xerox Machine](#)
- [Supplies](#)
- [Contacting Fuji Xerox](#)
- [New Zealand FAX Modem Statements](#)

## Specifications

### General Specifications

|                                       |   |   |
|---------------------------------------|---|---|
| <b>Printer Type</b>                   |   | <ul style="list-style-type: none"> <li>Laser</li> </ul>   |
| <b>Print Method</b>                   |   | <ul style="list-style-type: none"> <li>Electrophotographic Laser Printer</li> </ul>   |
| <b>Memory Capacity</b>                | <b>Standard</b>                           | <ul style="list-style-type: none"> <li>(DocuPrint M235 dw)<br/>128 MB</li> <li>(DocuPrint M235 z/DocuPrint M275 z/<br/>DocuPrint M285 z)<br/>256 MB</li> </ul>  |
| <b>LCD (Liquid Crystal Display)</b>   |   | <ul style="list-style-type: none"> <li>(DocuPrint M235 dw/DocuPrint M235 z)<br/>10 characters (2 byte) x 2 lines/ 16 characters x 2 lines</li> <li>(DocuPrint M275 z/DocuPrint M285 z)<br/>2.7 in. (67.5 mm) TFT Colour touchscreen LCD <sup>1</sup></li> </ul> |
| <b>Power Source</b>                   |   | <ul style="list-style-type: none"> <li>220 to 240 V AC 50/60 Hz</li> </ul>  |
| <b>Power Consumption</b><br>(Average) | <b>Peak</b>                               | <ul style="list-style-type: none"> <li>Approximately 1104 W (220-240 V)</li> </ul>  |
|                                       | <b>Printing</b> <sup>2</sup>              | <ul style="list-style-type: none"> <li>(DocuPrint M235 dw/DocuPrint M235 z)<br/>Approximately 440 W at 25 °C (220-240 V)</li> <li>(DocuPrint M275 z/DocuPrint M285 z)<br/>Approximately 475 W at 25 °C (220-240 V)</li> </ul>                                   |
|                                       | <b>Printing (Quiet Mode)</b> <sup>2</sup> | <ul style="list-style-type: none"> <li>Approximately 260 W at 25 °C (220-240 V)</li> </ul>  |
|                                       | <b>Copying</b> <sup>2</sup>               | <ul style="list-style-type: none"> <li>(DocuPrint M235 dw/DocuPrint M235 z)<br/>Approximately 455 W at 25 °C (220-240 V)</li> <li>(DocuPrint M275 z/DocuPrint M285 z)<br/>Approximately 485 W at 25 °C (220-240 V)</li> </ul>                                   |
|                                       | <b>Ready</b> <sup>2</sup>                 | <ul style="list-style-type: none"> <li>Approximately 42 W at 25 °C (220-240 V)</li> </ul>   |
|                                       | <b>Sleep</b> <sup>2</sup>                 | <ul style="list-style-type: none"> <li>(DocuPrint M235 dw/DocuPrint M235 z)<br/>Approximately 6.2 W (220-240 V)</li> <li>(DocuPrint M275 z/DocuPrint M285 z)<br/>Approximately 6.4 W (220-240 V)</li> </ul>   |
|                                       | <b>Deep Sleep</b> <sup>2</sup>            | <ul style="list-style-type: none"> <li>(DocuPrint M235 dw/DocuPrint M235 z)<br/>Approximately 0.9 W (220-240 V)</li> <li>(DocuPrint M275 z/DocuPrint M285 z)<br/>Approximately 1.1 W (220-240 V)</li> </ul>   |
|                                       | <b>Power Off</b> <sup>2 3 4</sup>         | <ul style="list-style-type: none"> <li>Approximately 0.03 W (220-240 V)</li> </ul>  |

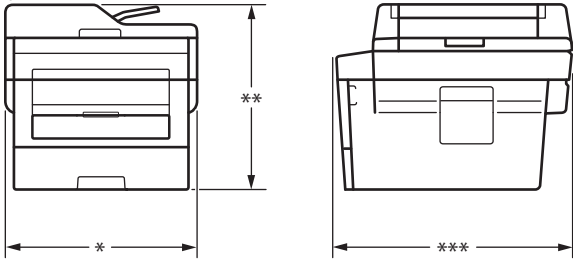
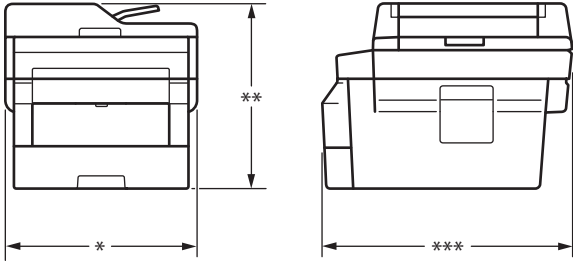

|  |                       |   |   |
|--|-----------------------|---|---|
| <b>Dimensions</b><br>(Typical outline view)<br>(DocuPrint M235 dw/DocuPrint M235 z/DocuPrint M275 z)             |                       | Unit: mm  |   |
|                                 |                       | <ul style="list-style-type: none"> <li>(DocuPrint M235 dw/DocuPrint M235 z/DocuPrint M275 z)           <ul style="list-style-type: none"> <li>* : 410</li> <li>** : 318.5</li> <li>*** : 398.5</li> </ul> </li> <li>(DocuPrint M285 z)           <ul style="list-style-type: none"> <li>* : 410</li> <li>** : 318.5</li> <li>*** : 426.5</li> </ul> </li> </ul> |   |
| (DocuPrint M285 z)   |                       |    |   |
| <b>Weights (with supplies)</b>   |                       | <ul style="list-style-type: none"> <li>(DocuPrint M235 dw/DocuPrint M235 z) 11.7 kg</li> <li>(DocuPrint M275 z) 12.0 kg</li> <li>(DocuPrint M285 z) 12.5 kg</li> </ul>  |   |
| <b>Noise Level</b>   | <b>Sound Pressure</b> | <b>Printing</b>   | <ul style="list-style-type: none"> <li>(DocuPrint M275 z/DocuPrint M285 z) LpAm = 49 dB (A)</li> <li>(DocuPrint M235 dw/DocuPrint M235 z) LpAm = 48 dB (A)</li> </ul>     |
|  |                       | <b>Printing (Quiet Mode)</b>  | <ul style="list-style-type: none"> <li>LpAm = 44 dB (A)</li> </ul>  |
|  |                       | <b>Ready</b>  | <ul style="list-style-type: none"> <li>LpAm = 30 dB (A)</li> </ul>  |
|  | <b>Sound Power</b>    | <b>Printing</b>   | <ul style="list-style-type: none"> <li>(DocuPrint M275 z/DocuPrint M285 z) LWAd = 7.165 B (A)</li> <li>(DocuPrint M235 dw/DocuPrint M235 z) LWAd = 7.103 B (A)</li> </ul> |
|  |                       | <b>Printing (Quiet Mode)</b>  | <ul style="list-style-type: none"> <li>LWAd = 6.743 B (A)</li> </ul>  |
|  |                       | <b>Ready</b>  | <ul style="list-style-type: none"> <li>LWAd = 4.55 B (A)</li> </ul>   |
| <b>Temperature</b>   | <b>Operating</b>      | <ul style="list-style-type: none"> <li>10 to 32.5 °C</li> </ul>   |   |
|  | <b>Storage</b>        | <ul style="list-style-type: none"> <li>0 to 40 °C</li> </ul>  |   |
| <b>Humidity</b>  | <b>Operating</b>      | <ul style="list-style-type: none"> <li>20 to 80% (without condensation)</li> </ul>  |   |
|  | <b>Storage</b>        | <ul style="list-style-type: none"> <li>35 to 85% (without condensation)</li> </ul>  |   |
| <b>ADF (automatic document feeder)</b><br>(DocuPrint M235 dw/DocuPrint M235 z/DocuPrint M275 z/DocuPrint M285 z) |                       | <ul style="list-style-type: none"> <li>Up to 50 sheets</li> </ul> For best results we recommend: <ul style="list-style-type: none"> <li>Temperature: 20 to 30 °C</li> <li>Humidity: 50 to 70%</li> <li>Paper: 80 g/m<sup>2</sup></li> </ul>   |   |

<sup>1</sup> Measured diagonally

- 2 USB connections to computer
- 3 Measured according to IEC 62301 Edition 2.0.
- 4 Power consumption varies slightly depending on the usage environment.

## Document Size Specification

|                      |                                |                     |
|----------------------|--------------------------------|---------------------|
| <b>Document Size</b> | <b>ADF Width</b> <sup>1</sup>  | • 105 to 215.9 mm   |
|                      | <b>ADF Length</b> <sup>1</sup> | • 147.3 to 355.6 mm |
|                      | <b>Scanner Glass Width</b>     | • Maximum 215.9 mm  |
|                      | <b>Scanner Glass Length</b>    | • Maximum 300 mm    |

<sup>1</sup> ADF models only

## Print Media Specifications

|                    |   |                               |  |
|--------------------|---|-------------------------------|--|
| <b>Paper Input</b> | <b>Paper Tray (Standard)</b>  | <b>Paper Type</b>             | • Plain Paper, Thin Paper, Recycled Paper, Thick Paper   |
|                    |   | <b>Paper Size</b>             | • (For Australia, New Zealand, Fiji Island, Papua New Guinea, Vanuatu Island and Korea)<br>A4, Letter, A5, A5 (Long Edge), A6, Executive<br>• (For Malaysia, Hong Kong, Brunei, Singapore, Macao, Vietnam, Laos, Myanmar, Thailand, Cambodia, Philippines, and Indonesia)<br>A4, Letter, A5, A5 (Long Edge), A6, Executive, Legal, Folio |
|                    |   | <b>Paper Weight</b>           | • 60 to 163 g/m <sup>2</sup>   |
|                    |   | <b>Maximum Paper Capacity</b> | • Up to 250 sheets of 80 g/m <sup>2</sup> Plain Paper  |
|                    | <b>Manual Feed Slot (DocuPrint M235 dw/ DocuPrint M235 z/ DocuPrint M275 z)</b> | <b>Paper Type</b>             | • Plain Paper, Thin Paper, Thick Paper, Thicker Paper, Recycled Paper, Bond, Label, Envelope   |
|                    |   | <b>Paper Size</b>             | • Width:<br>76.2 to 216 mm<br>• Length:<br>127 to 355.6 mm<br>• Envelope:<br>COM-10, DL, C5, Monarch   |
|                    |   | <b>Paper Weight</b>           | • 60 to 230 g/m <sup>2</sup>   |
|                    |   | <b>Maximum Paper Capacity</b> | • One sheet at a time  |
|                    | <b>Multi-Purpose Tray (MP tray) (DocuPrint M285 z)</b>                          | <b>Paper Type</b>             | • Plain Paper, Thin Paper, Thick Paper, Thicker Paper, Recycled Paper, Bond, Label, Envelope   |
|                    |   | <b>Paper Size</b>             | • Width:<br>76.2 to 216 mm<br>• Length:<br>127 to 355.6 mm<br>• Envelope:<br>COM-10, DL, C5, Monarch   |
|                    |   | <b>Paper Weight</b>           | • 60 to 230 g/m <sup>2</sup>   |

|                                  |   |                               |  |
|----------------------------------|---|-------------------------------|--|
| <b>Paper Input</b>               | <b>Multi-Purpose Tray (MP tray)</b><br>(DocuPrint M285 z) | <b>Maximum Paper Capacity</b> | <ul style="list-style-type: none"> <li>Up to 30 sheets of 80 g/m<sup>2</sup> Plain Paper</li> <li>Envelope: 2 envelopes</li> </ul>     |
| <b>Paper Output</b> <sup>1</sup> | <b>Face Down Output Tray</b>                              |                               | <ul style="list-style-type: none"> <li>Up to 120 Sheets (face down delivery to the face down output paper tray)<sup>2</sup></li> </ul> |
|                                  | <b>Face Up Output Tray</b>                                |                               | <ul style="list-style-type: none"> <li>One sheet (face up delivery to the face up output tray)</li> </ul>                              |
| <b>2-sided</b>                   | <b>Automatic 2-sided Printing</b>                         | <b>Paper Type</b>             | <ul style="list-style-type: none"> <li>Plain Paper, Thin Paper, Recycled Paper</li> </ul>  |
|                                  |   | <b>Paper Size</b>             | <ul style="list-style-type: none"> <li>A4</li> </ul>   |
|                                  |   | <b>Paper Weight</b>           | <ul style="list-style-type: none"> <li>60 to 105 g/m<sup>2</sup></li> </ul>  |

<sup>1</sup> For labels, we recommend removing the printed sheets from the output paper tray immediately after they exit the machine to avoid the possibility of smudging.

<sup>2</sup> Calculated with 80 g/m<sup>2</sup> in a temperate, non humid environment.

## Fax Specifications

### NOTE

This feature is available for DocuPrint M235 z/DocuPrint M275 z/DocuPrint M285 z.

|                                  |  |  |
|----------------------------------|--|--|
| <b>Compatibility</b>             | <ul style="list-style-type: none"> <li>ITU-T Super Group 3</li> </ul>  |  |
| <b>Coding System</b>             | <ul style="list-style-type: none"> <li>MH / MR / MMR / JBIG</li> </ul>   |  |
| <b>Modem Speed</b>               | <ul style="list-style-type: none"> <li>33,600 bps (with Automatic Fallback)</li> </ul>   |  |
| <b>2-sided Print Receiving</b>   | <ul style="list-style-type: none"> <li>(DocuPrint M235 z/DocuPrint M275 z/DocuPrint M285 z)<br/>Yes</li> </ul>   |  |
| <b>Automatic 2-sided Sending</b> | <ul style="list-style-type: none"> <li>(DocuPrint M275 z/DocuPrint M285 z)<br/>Yes (from ADF)</li> </ul>   |  |
| <b>Scanning Width</b>            | <ul style="list-style-type: none"> <li>Maximum 208 mm</li> </ul>   |  |
| <b>Printing Width</b>            | <ul style="list-style-type: none"> <li>Maximum 208 mm</li> </ul>   |  |
| <b>Greyscale</b>                 | <ul style="list-style-type: none"> <li>8 bit / 256 levels</li> </ul>   |  |
| <b>Resolution</b>                | <b>Horizontal</b>  | <ul style="list-style-type: none"> <li>203 dpi</li> </ul>  |
|                                  | <b>Vertical</b>  | <ul style="list-style-type: none"> <li>Standard: 98 dpi</li> <li>Fine: 196 dpi</li> <li>Super fine: 392 dpi</li> <li>Photo: 196 dpi</li> </ul> |
| <b>Address Book</b>              | <ul style="list-style-type: none"> <li>(DocuPrint M235 z/DocuPrint M275 z/DocuPrint M285 z)<br/>200 Locations</li> </ul>   |  |
| <b>One Touch Dial</b>            | <ul style="list-style-type: none"> <li>(DocuPrint M235 z)<br/>8 (4 x 2) locations</li> </ul>   |  |
| <b>Groups</b>                    | <ul style="list-style-type: none"> <li>Up to 20</li> </ul>   |  |
| <b>Broadcasting</b>              | <ul style="list-style-type: none"> <li>(DocuPrint M235 z)<br/>258 Locations</li> <li>(DocuPrint M275 z/DocuPrint M285 z)<br/>250 Locations</li> </ul>  |  |
| <b>Automatic Redial</b>          | <ul style="list-style-type: none"> <li>(For Vietnam, Thailand, Cambodia and Brunei)<br/>1 time at 5 minutes intervals</li> <li>(For Other countries)<br/>3 times at 5 minutes intervals</li> </ul> |  |

|                               |   |
|-------------------------------|---|
| <b>Memory Transmission</b>    | <ul style="list-style-type: none"> <li>(DocuPrint M235 z/DocuPrint M275 z/DocuPrint M285 z)<br/>Up to 500 pages <sup>1</sup></li> </ul> |
| <b>Out of Paper Reception</b> | <ul style="list-style-type: none"> <li>(DocuPrint M235 z/DocuPrint M275 z/DocuPrint M285 z)<br/>Up to 500 pages <sup>1</sup></li> </ul> |

<sup>1</sup> 'Pages' refers to the 'ITU-T Test Chart #1' (a typical business letter, Standard resolution, JBIG code).

## Copy Specification

|   |  |
|---|--|
| <b>Copy Width</b>                         | <ul style="list-style-type: none"> <li>Maximum 210 mm</li> </ul>   |
| <b>Automatic 2-sided Copy</b>             | <ul style="list-style-type: none"> <li>(DocuPrint M275 z/DocuPrint M285 z)<br/>Yes (from ADF)</li> </ul>   |
| <b>Sort Copy</b>                          | <ul style="list-style-type: none"> <li>Yes</li> </ul>  |
| <b>Stack Copy</b>                         | <ul style="list-style-type: none"> <li>Up to 99 pages</li> </ul>   |
| <b>Enlarge/Reduce</b>                     | <ul style="list-style-type: none"> <li>25 to 400% (in increments of 1%)</li> </ul>   |
| <b>Resolution</b>                         | <ul style="list-style-type: none"> <li>Maximum 600 x 600 dpi</li> </ul>  |
| <b>First Copy Out Time</b> <sup>1 2</sup> | <ul style="list-style-type: none"> <li>(DocuPrint M235 dw/DocuPrint M235 z/DocuPrint M275 z)<br/>Less than 10 seconds at 23 °C</li> <li>(DocuPrint M285 z)<br/>Less than 9 seconds at 23 °C</li> </ul> |

<sup>1</sup> From Ready Mode and standard tray

<sup>2</sup> From scanner glass

## Scanner Specifications

|  |   |
|--|---|
| <b>Colour / Black</b>                            | <ul style="list-style-type: none"> <li>Yes / Yes</li> </ul>   |
| <b>TWAIN Compliant</b>                           | <ul style="list-style-type: none"> <li>Yes<br/>(Windows® 7 SP1 / Windows® 8 / Windows® 8.1 / Windows® 10)<br/>(macOS v10.11.x, v10.12.x, v10.13.x)</li> </ul>                                     |
| <b>Windows Image Acquisition (WIA) Compliant</b> | <ul style="list-style-type: none"> <li>Yes<br/>(Windows® 7 SP1 / Windows® 8 / Windows® 8.1 / Windows® 10)</li> </ul>  |
| <b>AirPrint Compliant</b>                        | <ul style="list-style-type: none"> <li>Yes<br/>(macOS v10.11.x, v10.12.x, v10.13.x)</li> </ul>  |
| <b>Colour Depth</b>                              | <ul style="list-style-type: none"> <li>30 bit colour Processing (Input)</li> <li>24 bit colour Processing (Output)</li> </ul>   |
| <b>Grey Scale</b>                                | <ul style="list-style-type: none"> <li>10 bit colour Processing (Input)</li> <li>8 bit colour Processing (Output)</li> </ul>  |
| <b>Resolution</b> <sup>2</sup>                   | <ul style="list-style-type: none"> <li>Up to 19200 x 19200 dpi (interpolated)</li> <li>Up to 1200 x 1200 dpi (from Scanner Glass)</li> <li>Up to 600 x 600 dpi (from ADF) <sup>1</sup></li> </ul> |
| <b>Scanning Width</b>                            | <ul style="list-style-type: none"> <li>Maximum 210 mm</li> </ul>  |
| <b>Automatic 2-sided Scanning</b>                | <ul style="list-style-type: none"> <li>(DocuPrint M275 z/DocuPrint M285 z)<br/>Yes (from ADF)</li> </ul>  |

<sup>1</sup> ADF models only

<sup>2</sup> Maximum 1200 x 1200 dpi scanning with the Windows Image Acquisition (WIA) driver in Windows® 7, Windows® 8, Windows® 8.1 and Windows® 10 (resolution up to 19200 x 19200 dpi can be selected by using the scanner utility)

## Printer Specifications

|                                      |   |
|--------------------------------------|---|
| <b>Automatic 2-sided Print</b>       | • Yes   |
| <b>Emulation</b>                     | • PCL6, PostScript® 3™, Host-Based  |
| <b>Resolution</b>                    | • 600 x 600 dpi, HQ1200 (2400 x 600) quality, 1200 x 1200 dpi   |
| <b>Print Speed</b> <sup>1 2</sup>    | <b>1-sided print</b>  |
|                                      | <b>2-sided Print</b>  |
| <b>First Print Time</b> <sup>3</sup> | <ul style="list-style-type: none"> <li>• (DocuPrint M235 dw/DocuPrint M235 z/DocuPrint M275 z)<br/>Less than 8.5 seconds at 23 °C</li> <li>• (DocuPrint M285 z)<br/>Less than 7 seconds at 23 °C</li> </ul> |

<sup>1</sup> The print speed may change depending on the type of document you print.

<sup>2</sup> Print speed may be slower when the machine is connected by wireless LAN.

<sup>3</sup> From Ready mode and standard tray

## Interface Specifications

|                           |  |
|---------------------------|--|
| <b>USB</b> <sup>1 2</sup> | <ul style="list-style-type: none"> <li>• Hi-Speed USB 2.0</li> </ul> Use a USB 2.0 interface cable that is no more than 2.0 metres long. |
| <b>LAN</b>                | • 10Base-T/100Base-TX <sup>3</sup>   |
| <b>Wireless LAN</b>       | <ul style="list-style-type: none"> <li>• IEEE 802.11b/g/n (Infrastructure Mode)</li> <li>• IEEE 802.11g/n (Wi-Fi Direct®)</li> </ul>     |
| <b>NFC</b>                | <ul style="list-style-type: none"> <li>• (DocuPrint M275 z/DocuPrint M285 z)</li> </ul> Yes  |

<sup>1</sup> Your machine has a USB 2.0 Hi-Speed interface. The machine can also be connected to a computer that has a USB 1.1 interface.

<sup>2</sup> Third party USB ports are not supported.

<sup>3</sup> Use a straight-through Category 5 (or greater) twisted-pair cable.

## Supported Protocols and Security Features

### Ethernet

10Base-T/100Base-TX

### Wireless LAN

IEEE 802.11b/g/n (Infrastructure Mode), IEEE 802.11g/n (Wi-Fi Direct)

### Protocols (IPv4)

ARP, RARP, BOOTP, DHCP, APIPA(Auto IP), WINS/NetBIOS name resolution, DNS Resolver, mDNS, LLMNR responder, LPR/LPD, Custom Raw Port/Port9100, SMTP Client, IPP/IPPS, FTP Client and Server, CIFS Client, SNMPv1/v2c/v3, HTTP/HTTPS server, TFTP client and server, ICMP, Web Services (Print/Scan), SNTTP Client

(Supported protocols may vary depending on your models)

## Protocols (IPv6)

NDP, RA, DNS resolver, mDNS, LLMNR responder, LPR/LPD, Custom Raw Port/Port9100, IPP/IPPS, SMTP Client, FTP Client and Server, CIFS Client, SNMPv1/v2c/v3, HTTP/HTTPS server, TFTP client and server, ICMPv6, SNTP Client, Web Services (Print/Scan)

(Supported protocols may vary depending on your models)

## Network Security (Wired)

SMTP-AUTH, SSL/TLS (SMTP, HTTP, IPP), SNMP v3

## Network Security (Wireless)

SMTP-AUTH, SSL/TLS (SMTP, HTTP, IPP), SNMP v3

## Wireless Network Security

WEP 64/128 bit, WPA-PSK (TKIP/AES), WPA2-PSK (TKIP/AES)(Wi-Fi Direct supports WPA2-PSK (AES) only)

## Wireless Certification

Wi-Fi Certification Mark License (WPA™/WPA2™ - Personal), Wi-Fi Protected Setup (WPS) Identifier Mark License, Wi-Fi CERTIFIED™ Wi-Fi Direct

## Computer Requirements Specifications

Supported Operating Systems And Software Functions

| Computer Platform & Operating System Version |   | PC Interface        |  |   |  | Processor | For Drivers | Hard Disk Space to Install |
|--|---|---------------------|--|---|--|-----------|-------------|----------------------------|
|  |   | Parallel (IEEE1284) | USB <sup>1</sup>                                   | 10Base-T/100Base-TX <sup>2</sup> (Ethernet) | Wireless <sup>3</sup> 802.11b/g/n      |           |             |                            |
| Windows® Operating System                    | Windows® 7 SP1 / 8 / 8.1 <sup>4 5</sup>                                 | N/A                 | Printing<br>PC Fax <sup>6</sup>                    |   | 32 bit (x86) or 64 bit (x64) processor | 650 MB    | 1.2 GB      |                            |
|  | Windows® 10 Home / 10 Pro / 10 Education / 10 Enterprise <sup>4 5</sup> |                     | Scanning   |   |  |           |             |                            |
|  | Windows Server® 2008  | N/A                 | Printing   |   | 64 bit (x64) processor                 | 50 MB     | N/A         |                            |
|  | Windows Server® 2008 R2   |                     |  |   |  |           |             |                            |
|  | Windows Server® 2012  |                     |  |   |  |           |             |                            |
|  | Windows Server® 2012 R2   |                     |  |   |  |           |             |                            |
|  | Windows Server® 2016  |                     |  |   |  |           |             |                            |
| Mac Operating System                         | macOS v10.11.x<br>macOS v10.12.x<br>macOS v10.13.x                      |                     | Printing<br>PC-Fax (Send) <sup>6</sup><br>Scanning |   | Intel® Processor                       | 80 MB     | 400 MB      |                            |

<sup>1</sup> Third party USB ports are not supported.

<sup>2</sup> Supported models only(DocuPrint M235 dw/DocuPrint M235 z/DocuPrint M275 z/DocuPrint M285 z)

<sup>3</sup> Supported models only(DocuPrint M235 dw/DocuPrint M235 z/DocuPrint M275 z/DocuPrint M285 z)

<sup>4</sup> For Windows Image Acquisition (WIA), 1200x1200 resolution. Fuji Xerox Scanner Utility enables resolutions up to 19200 x 19200 dpi.

---

<sup>5</sup> PaperPort™ 14SE supports Windows® 7, Windows® 8, Windows® 8.1 and Windows® 10.

<sup>6</sup> PC-Fax supports black and white only.

For the latest driver updates, go to your model's page on the Fuji Xerox website at <http://www.fujixeroxprinters.com/>.

All trademarks, brand and product names are the property of their respective companies.



## Related Information

- [Appendix](#)

## How to Enter Text on Your Fuji Xerox Machine

- >> DocuPrint M235 dw
- >> DocuPrint M235 z
- >> DocuPrint M275 z/DocuPrint M285 z

### DocuPrint M235 dw

When text is required, enter characters on the machine. The characters that are available may differ depending on the operation you perform.

- Hold down or repeatedly press ▲ or ▼ to select a character from this list:  
0123456789abcdefghijklmnopqrstuvwxyzABCDEFGHIJKLMNOPQRSTUVWXYZ(space)!"#\$%&'()\*+,-./:;<=>?  
@[^\_
- Press **OK** when the character or symbol you want is displayed, and then enter the next character.
- Press **Clear** to delete characters entered incorrectly.

### DocuPrint M235 z

When text is required, enter characters on the machine. The characters that are available may differ depending on the operation you perform.

The buttons 0, # and \* are used for special characters.

- Press the appropriate dial pad button the number of times shown in this reference table to access the character you want.

| Press button | One time | Two times | Three times | Four times | Five times | Six times | Seven times | Eight times | Nine times |
|--------------|----------|-----------|-------------|------------|------------|-----------|-------------|-------------|------------|
| 1            | @        | .         | /           | 1          | @          | .         | /           | 1           | @          |
| 2            | a        | b         | c           | A          | B          | C         | 2           | a           | b          |
| 3            | d        | e         | f           | D          | E          | F         | 3           | d           | e          |
| 4            | g        | h         | i           | G          | H          | I         | 4           | g           | h          |
| 5            | j        | k         | l           | J          | K          | L         | 5           | j           | k          |
| 6            | m        | n         | o           | M          | N          | O         | 6           | m           | n          |
| 7            | p        | q         | r           | s          | P          | Q         | R           | S           | 7          |
| 8            | t        | u         | v           | T          | U          | V         | 8           | t           | u          |
| 9            | w        | x         | y           | z          | W          | X         | Y           | Z           | 9          |

For options that do not allow lower case characters, use the following table:

| Press button | One time | Two times | Three times | Four times | Five times |
|--------------|----------|-----------|-------------|------------|------------|
| 2            | A        | B         | C           | 2          | A          |
| 3            | D        | E         | F           | 3          | D          |
| 4            | G        | H         | I           | 4          | G          |
| 5            | J        | K         | L           | 5          | J          |
| 6            | M        | N         | O           | 6          | M          |
| 7            | P        | Q         | R           | 7          | P          |
| 8            | T        | U         | V           | 8          | T          |
| 9            | W        | X         | Y           | 9          | W          |



- Inserting spaces

To enter a space in a fax number, press ► once between numbers. To enter a space in a name, press ► twice between characters.

- Making corrections

If you entered a character incorrectly and want to change it, press ◀ or ▶ to move the cursor to the incorrect character, and then press **Clear**.

- Repeating letters

To enter a letter on the same button as the previous letter, press ► to move the cursor right before pressing the button again.

- Special symbols and characters

Press \*, # or 0, then press ◀ or ▶ to move the cursor to the symbol or character you want. Press **OK** to select it. The symbols and characters that are available on dial pad buttons are shown in the table.

|         |  |
|---------|--|
| Press * | (space) ! " # \$ % & ' ( ) * + , - . / € |
| Press # | ; ; < = > ? @ [ ] ^ _ \ ~ '   { }        |
| Press 0 | Ä È Ö Ü À Ç È É 0                        |

## DocuPrint M275 z/DocuPrint M285 z

- When you must enter text on your Fuji Xerox machine, a keyboard appears on the LCD.
- The characters that are available may differ depending on your country.
- The keyboard layout may differ depending on the operation you perform.



- Press to cycle between letters, numbers and special characters.
- Press to cycle between lowercase and uppercase letters.
- To move the cursor to the left or right, press ◀ or ▶.

### Inserting spaces

- To enter a space, press [Space].

### Making corrections

- If you entered a character incorrectly and want to change it, press ◀ or ▶ to move the cursor to the incorrect character and press . Enter the correct character.
- To insert a character, press ◀ or ▶ to move the cursor to the correct place, and then enter the character.
- Press for each character you want to erase, or press and hold to erase all the characters.

## ✓ Related Information

- [Appendix](#)
- [Configure Your Machine for a Wireless Network Using the Machine's Control Panel Setup Wizard](#)
- [Configure Your Machine for a Wireless Network When the SSID Is Not Broadcast](#)

- 
- Set Your Station ID
-

## Supplies

When the time comes to replace supplies, such as the toner or drum, an error message will appear on your machine's control panel or in the Status Monitor. Contact your local Fuji Xerox dealer.



- The supply model name will vary depending on your country and region.

### Toner Cartridge

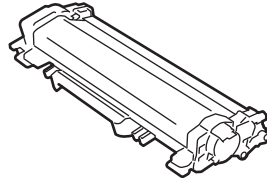

| Supply Model Name                   | Approximate Life (Page Yield)            | Applicable Models  |
|-------------------------------------|--|--|
| Standard Toner:<br>CT202876         | Approximately 1,200 pages <sup>1 2</sup> | DocuPrint M235 dw/<br>DocuPrint M235 z/DocuPrint M275 z                      |
| High Yield Toner:<br>CT202877       | Approximately 3,000 pages <sup>1 2</sup> | DocuPrint M235 dw/<br>DocuPrint M235 z/DocuPrint M275 z/<br>DocuPrint M285 z |
| Extra High Yield Toner:<br>CT202878 | Approximately 4,500 pages <sup>1 2</sup> | DocuPrint M285 z   |

<sup>1</sup> Approximate cartridge yield is declared in accordance with ISO/IEC 19752.

<sup>2</sup> A4/Letter simplex pages

The average inbox toner life is estimated at approximately 700 pages <sup>1</sup> or approximately 1,200 pages <sup>2</sup> or approximately 3,000 pages <sup>3</sup> based on 1 page per job [A4 or Letter size single-sided pages].

<sup>1</sup> (For Australia and New Zealand) DocuPrint M235 dw

<sup>2</sup> (Except Australia and New Zealand) DocuPrint M235 dw/DocuPrint M235 z

<sup>3</sup> DocuPrint M275 z/DocuPrint M285 z

### Drum Unit

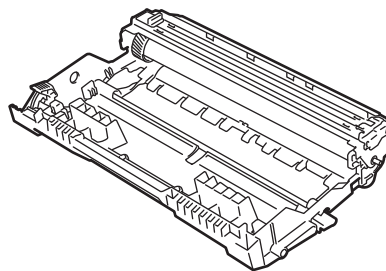

| Supply Model Name | Approximate Life (Page Yield)           | Applicable Models  |
|-------------------|---|--|
| CT351134          | Approximately 12,000 pages <sup>1</sup> | DocuPrint M235 dw/DocuPrint M235 z/DocuPrint M275 z/<br>DocuPrint M285 z |

<sup>1</sup> Approximately 12,000 pages based on 1 page per job [A4/Letter simplex pages]. The number of pages may be affected due to a variety of factors including but not limited to media type and media size.



### Related Information

- [Appendix](#)
- [Replace Supplies](#)

## Contacting Fuji Xerox

### IMPORTANT

For technical help, you must call Fuji Xerox customer service or your local Fuji Xerox dealer.

### Technical Support

Fuji Xerox recommends the Customer first utilize support materials shipped with the product, product diagnostics, information contained on the Web, and email support. If unsuccessful, to obtain service under product warranty the Customer must notify Fuji Xerox Telephone Support or its authorized service representative of the defect before the expiration of the warranty period. Customer will provide appropriate assistance to Telephone Support personnel to resolve issues, such as restoration of the operating system, software program and drivers to their default configuration and settings, verification of functionality of Fuji Xerox supplied products, replacement of customer replaceable units, clearing paper misfeeds and cleaning the unit and other prescribed routine and preventative maintenance.

If the Customer's product contains features that enable Fuji Xerox or its authorized service representative to diagnose and repair problems with the product remotely, Fuji Xerox may request that the Customer allow such remote access to the product.

### Online Services

You can find detail Product and Consumable warranty information on our website at

<http://www.fujixeroxprinters.com/>

Fuji Xerox Online Support Assistant provides instructions and troubleshooting guides to resolve your printer problems. It is an easy-to-use, searchable online Help. To find out more, please visit our online support at

<http://www.fujixeroxprinters.com/>

### ✓ Related Information

- [Appendix](#)

## New Zealand FAX Modem Statements

### General

The grant of a Telepermit for any item of terminal equipment indicates only that Telecom has accepted that the item complies with minimum conditions for connection to its network. It indicates no endorsement of the product by Telecom, nor does it provide any sort of warranty. Above all, it provides no assurance that any item will work correctly in all respects with another item of Telepermitted equipment of a different make or model, nor does it imply that any product is compatible with all of Telecom's network services.

This equipment does not fully meet Telecom's impedance requirements. Performance limitations may occur when used in conjunction with some parts of the network. Telecom will accept no responsibility should difficulties arise in such circumstances.

This equipment shall not be set up to make automatic calls to the Telecom '111' Emergency Service.

If a charge for local calls is unacceptable, the 'Dial' button should NOT be used for local calls. Only the 7-digits of the local number should be dialed from your telephone. DO NOT dial the area code digit or the '0' prefix.

This equipment may not provide for the effective hand-over of a call to another equipment connected to the same line.

### Important Notice

Under power failure conditions, this telephone may not operate. Please ensure that a separate telephone, not dependent on local power, is available for emergency use.

Some parameters required for compliance with Telecom's Telepermit requirements are dependent on the equipment (PC) associated with this equipment. The associated equipment shall be set to operate within the following limits for compliance with Telecom's Specification:

- a There shall be no more than 10 call attempts to the same number within any 30-minute period for any single manual call initiation, and the equipment shall go on-hook for a period of not less than 30 seconds between the end of one attempt and the beginning of the next attempt.
- b Where automatic calls are made to different numbers, the equipment shall go on-line for a period of not less than 5 seconds between the end of one attempt and the beginning of the next attempt.
- c The equipment shall be set to ensure that calls are answered between 3 and 30 seconds of receipt of ringing.

All persons using this equipment for recording telephone conversations shall comply with New Zealand law. This requires that at least one party to the conversation is to be aware that it is being recorded. In addition, the Principles enumerated in the Privacy Act of 1993 shall be complied with in respect to the nature of the personal information collected, the purpose for its collection, how it is used and what is disclosed to any other party.

### Related Information

- [Appendix](#)

DocuPrint M235 dw/DocuPrint M235 z/DocuPrint M275 z/DocuPrint M285 z  
Online User's Guide

ME8157E2-2 (Edition 1)  
February 2018

## Free Manuals Download Website

<http://myh66.com>

<http://usermanuals.us>

<http://www.somanuals.com>

<http://www.4manuals.cc>

<http://www.manual-lib.com>

<http://www.404manual.com>

<http://www.luxmanual.com>

<http://aubethermostatmanual.com>

Golf course search by state

<http://golfingnear.com>

Email search by domain

<http://emailbydomain.com>

Auto manuals search

<http://auto.somanuals.com>

TV manuals search

<http://tv.somanuals.com>