

DocuPrint 205/255/305
DocuPrint 240A/340A
ESC/P Emulation Settings
Guide

NetWare is a registered trademark of Novell, Inc. of the United States and other countries.
All other product/brand names used herein are trademarks or registered trademarks of the respective holders.

Important

- ① This manual is copyrighted with all rights reserved. Under the copyright laws, this manual may not be copied or modified in whole or part, without the written consent of the publisher.
- ② Parts of this manual are subject to change without prior notice.
- ③ We welcome any comments on ambiguities, errors, omissions, or missing pages.

Xerox, The Document Company and the stylized X are registered trademarks of Xerox Corporation.
All Xerox and Fuji Xerox product names are either registered trademarks or trademarks of Xerox Corporation and Fuji Xerox Co., Ltd.

Preface

Thank you for choosing this printer.

This manual explains how to set up the printer to perform ESC/P emulation.

Be sure to read this manual first to ensure proper use of this product.

Note that this manual is written for users who have basic knowledge of the operating environment and operation method as well as the method of using this printer.

Keep this manual handy for a quick reference to ensure full and efficient use of this product.

Contents

Preface.....	3
Contents.....	4
Using This Guide	5
1 Using Emulation	6
1.1 About Emulation	6
Emulation Mode	6
Host Interface and Emulation	6
Switching Between Print Languages	7
ESC/P Mode Menu Screen	7
1.2 About Fonts	8
Usable Fonts	8
User-defined Fonts (Specially Registered Fonts)	8
Font Cache	8
1.3 Eject Function.....	9
To Forcibly Eject Remaining Data	9
To Eject All Jobs in the Printer	10
1.4 Other Print Features	11
Multiple Up	11
Barcode	11
2 ESC/P Mode Settings.....	12
2.1 About the Mode Menu	12
This Printer's Menus	12
About the Mode Menu	13
2.2 ESC/P Mode Menu Settings.....	14
List of ESC/P Setting Items	14
Setting the ESC/P Mode Menu	21
2.3 About the ESC/P Mode List.....	22
ESC/P Mode List	22
Print Method	22
3 Materials Related to ESC/P Mode.....	23
3.1 List of Scaling Values	23
3.2 Paper Size and Number of Printed Digits.....	29
Index	31

List of Mode Menu (ESC/P)

Using This Guide

Prerequisite Knowledge

Read this guide in detail before using this printer. If you are not familiar with the machine to which the printer is to be connected or the basic operations or concepts of the software, read the relevant manuals first.

Machines and software to which the printer is to be connected refer to personal computers, workstations, networks, and the respective operating systems and applications on which these machines run.

Organization

The following is a summary of each chapter.

1. Using Emulation

This chapter explains the available interfaces and fonts, emulated printers.

2. ESC/P Mode Settings

This chapter explains the printer settings needed to use ESC/P emulation.

3. Materials Related to ESC/P Mode

This chapter explains scaling values and number of printable lines for various paper sizes.

Conventions

1. In this guide, “computer” refers to both the personal computer and workstation.

2. The following icons are used in this guide:

Important	Indicates important information which you should read.
Note	Indicates additional information on operations or features.
Refer to	Indicates reference sources.

3. The following conventions are used in this guide:

Refer to “xxx”	:	The cross-reference is within this guide.
Refer to xxx	:	The cross-reference is not within this guide.
[]	:	Indicates items displayed on the computer and the printer control panel. Also indicates the title of printed reports/lists from the printer.
< >	:	Indicates items such as hard buttons and indicators on the keyboard and printer.

1 Using Emulation

1.1 About Emulation

This chapter explains ESC/P emulation of print languages available on this printer. Print data conforms to certain rules (grammar). These rules (grammar) are called print language.

This printer supports a page description language used to create images on a page basis and an emulation feature used to obtain the print result similar to that obtained by another printer. The ability to obtain the print result similar to that obtained by another printers is called emulation.

Note

- The ESC/P emulation mode can be used when the SC/TC Font ROM (optional) is installed.

Emulation Mode

When printing data written in a language other than the page description language supported by this printer, place this printer in the emulation mode. This printer has more than one emulation mode. The following table summarizes the relationship between the ESC/P emulation mode and the printer type to be emulated.

Emulation mode	Emulated printer
ESC/P emulation mode (ESC/P mode)	VP-1000

Host Interface and Emulation

Different host interfaces support different print languages. Host interfaces that support print languages are as follows:

- Parallel port
- Serial port
- LPD port
- NetWare port
- SMB port
- IPP port
- USB port
- Port9100 port

Switching Between Print Languages

This printer supports multi-emulation, allowing you to switch between print languages. There are three methods of switching between print languages.

Switching by Commands

Commands for switching between supported print languages are provided. Upon receipt of a command, this printer selects the relevant print language.

Automatic Switching

This printer analyzes the data received by the host interface to identify the print language to be used. It then switches to the identified print language automatically.

Interface-dependent

Set a print language for each host interface using the control panel. Switch to the print language corresponding to the host interface that received data.

ESC/P Mode Menu Screen

This screen is for setting items specific to the ESC/P emulation mode. Press the <Menu> button, and select [ESCP] for [Print Language].



Refer to

- ESC/P mode menu item: "2 ESC/P Mode Settings" (P. 12)

1.2 About Fonts

This section explains the fonts that can be used in the ESC/P emulation mode.

Usable Fonts

The following fonts can be used in ESC/P emulation.

Outline Fonts

Chinese fonts

- ShuSongTi
- FangSongTi
- KaiTi
- HeiTi

European fonts

- Roman
- Sans Serif
- OCR-B

User-defined Fonts (Specially Registered Fonts)

User-defined fonts (specially registered fonts) can be used on this printer. User-defined fonts can be stored only in memory. This means that they are erased from memory when this printer is switched off. Note, however, that when an optional hard disk is installed, user-defined fonts are stored on hard disk, and are held even if this printer is switched off. The amount of user-defined fonts that can be saved registered on hard disk is the same as when they are stored to memory.

User-defined fonts are registered as bitmap fonts. User-defined fonts are not shared between print languages

Font Cache

To ensure high-speed printing, outline fonts are cached if they are not too large.

Outline fonts are converted to bit map data temporarily and then printed. To minimize this processing time, the processed bit map data is saved in the memory.

This process is called font caching.

The saved bit map data is erased at power-off or system reset.

1.3 Eject Function

This section explains the eject function. There are two types of eject functions as shown here.

- The remaining data is forcibly ejected.
- All jobs in the printer are eliminated.

To Forcibly Eject Remaining Data

For ESC/P emulation mode, data is not ejected until a full page of data has accumulated. When using a parallel interface, if operations stop while the data for the last page is being transferred, this machine waits for the next data until the time set [Auto Eject Time] has passed, and the "Waiting for data" appears in the display.

In this kind of situation, forced eject does not wait for automatic eject and just forces all of the data in the printer to print out.

The operation procedure is shown below.

Note

- When "Waiting for data" appears in the display, the next job sent to the printer may not be printed correctly. Send the next job after forced eject or after the automatic eject time has been exceeded.

Refer to

- Auto Eject Time: User Guide 4.2 Description of Menu Items

1. Press the <Eject/Set> button when the display shown to the right appears.

Printing will start.

When printing ends, the display changes to "Ready to print".

Important

- When the common menu item [Print Mode] is set to [Auto], "Waiting for data" does not appear, so forced eject does not occur.

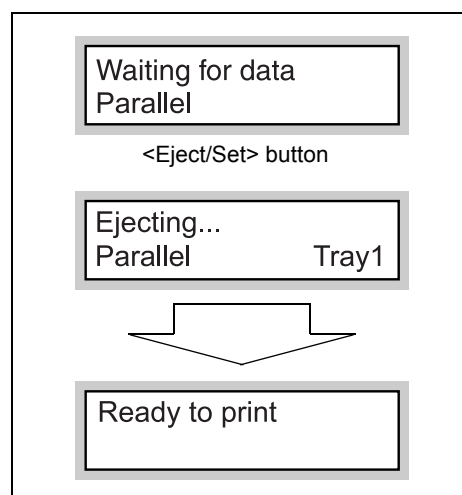

To Eject All Jobs in the Printer

Print all jobs that the printer has received.

Through this procedure, you can interrupt the receiving of data and empty the buffer. The procedure is explained below.

1. Press the <Online> button when the display shown to the right appears.

Note

- Pressing the <Online> button to make the printer automatically stop receiving data.

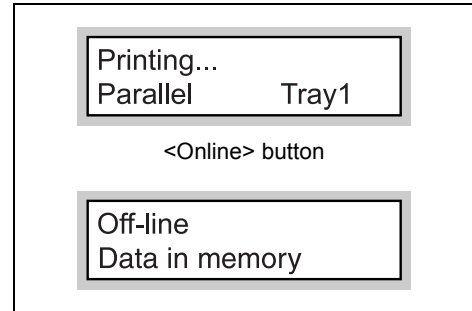

2. Press the <Eject/Set> button. This starts printing.

When all jobs are executed and printed, the display changes to "Off-line".

Note

- When a parallel interface or USB interface is being used, depending on when the <Online> button is pressed in step 1, data reception may occur in the middle of a job. In this case, after the <Eject/Set> button is pressed, and processed like a new job after releasing offline in step 3.

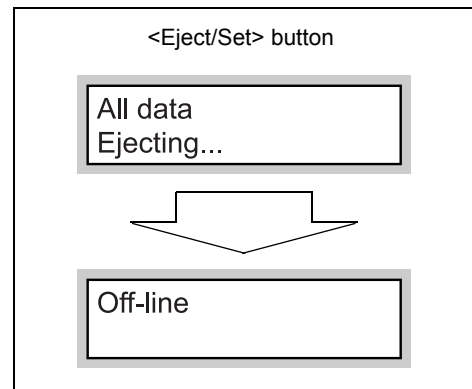

3. Press the <Online> button. The display changes to "Ready to print".

Note

- After "Ready to print" appears, the data that is being processed as a new job may not be printed correctly if [Print Mode] is set to [Auto] in the common menu.

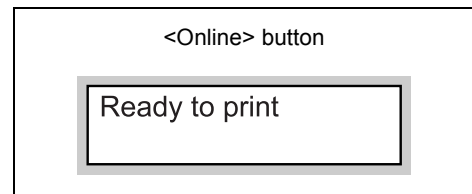

1.4 Other Print Features

This section explains the other print features that are available in the ESC/P emulation mode menu.

Multiple Up

This feature prints multiple pages reduced on a single piece of paper.

This feature is available in the ESC/P emulation mode. 2 Up is available in the ESC/P mode menu.

Barcode

Barcodes are available in the ESC/P mode. The following barcode standards are available:

- JAN code
- CODE39
- CODABAR
- Industrial 2 of 5
- Matrix 2 of 5
- Interleaved 2 of 5
- CODE128

2 ESC/P Mode Settings

2.1 About the Mode Menu

This section explains the types of menus and hierarchy of the emulation mode menus.

This Printer's Menus

The menu is divided into two menus, a mode menu for making emulation related settings, and a common menu for making other printer settings.

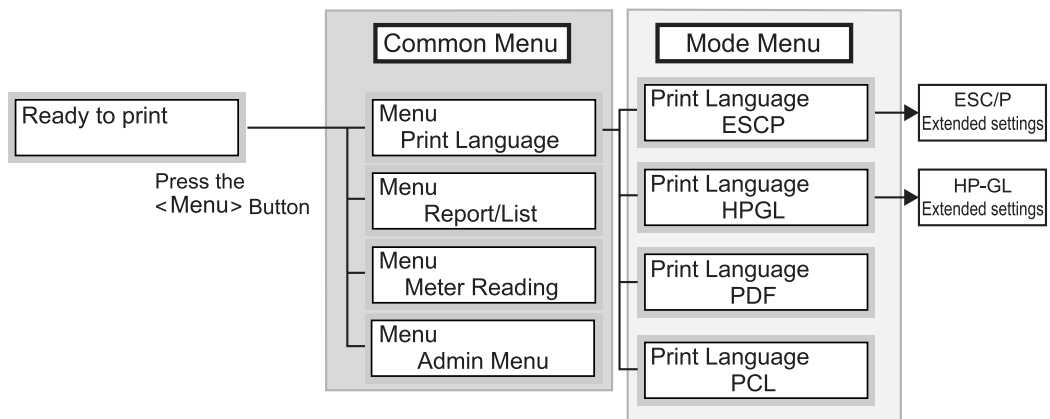

You can set the following items in the common menu when using ESC/P emulation.

- Port Status (Parallel/Serial/LPD/NetWare/SMB/IPP/USB/Port9100)
Set the port that uses ESC/P emulation to [Enable].
- Print Mode (Parallel/Serial/LPD/NetWare/SMB/IPP/USB/Port9100) (default: [Auto])
Sets specify port print mode so that you can use ESC/P emulation. Select [ESC/P] or [Auto] as the print mode.

About the Mode Menu

The ESC/P mode menu is used to set items specific to ESC/P emulation.

You can change the mode menu settings while the printer is printing. When this is done, the changed settings take effect from the next job.

The mode menu is configured from the following levels.

- Mode menu > Menu item > Item > Candidate value

Note

- Some menu items do not have items.
Sometimes they are divided into item 1, item 2 and item 3. (Called item hereafter.)

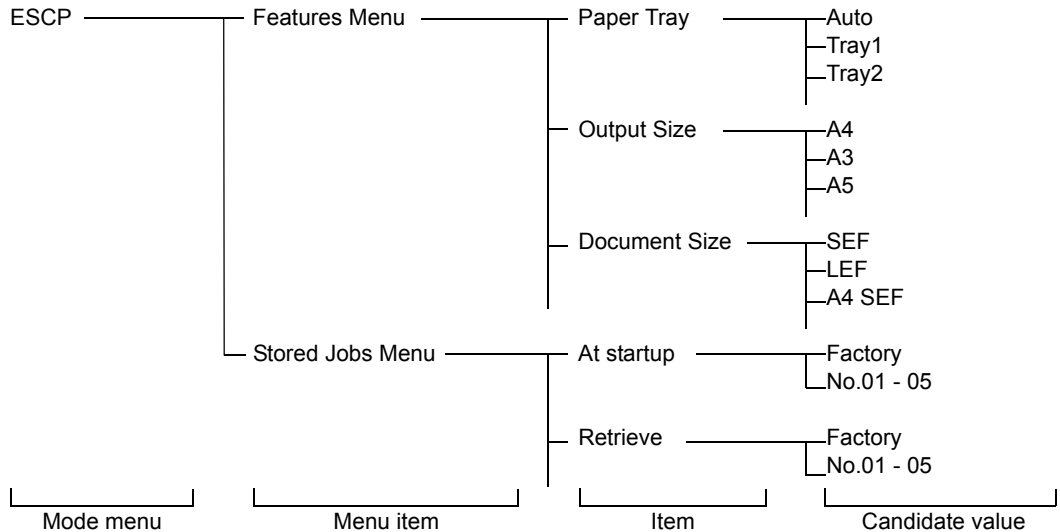

The diagram shown above represents a portion of the levels in the ESC/P mode menu.

Refer to

- Operations and items that can be set: "2.2 ESC/P Mode Menu Settings" (P. 14)

2.2 ESC/P Mode Menu Settings

This section explains items that can be configured in the mode menu and how to operate these items.

List of ESC/P Setting Items

This section explains items that can be set using ESC/P with the mode menu.

Features Menu

Paper Tray

Sets the paper tray that supplies paper.

Candidate values are shown below.

[Auto]

The printer searches for the paper tray that has the paper size set in [Output Size] and paper is fed from that tray.

[Tray 1] (default)

[Tray 2]

[Tray 3]

[Tray 4]

[Tray 1 (Bypass)]

Important

- When [Tray 1] to [Tray 4] are selected, [Output Size] cannot be set (because the paper loaded in these trays become the output sizes.)

Note

- When [Auto] is selected and the same size and type of paper is loaded in the same orientation in multiple trays, the paper tray will be selected according to the tray priority settings and paper priority settings in the common menu.
When the same size of paper is loaded in different orientations in multiple trays, the paper loaded in landscape is given priority.
- [Tray 3] and [Tray 4] are displayed only when the optional trays are installed.
- [Tray 1 (Bypass)] is displayed only when the bypass tray (optional) is installed on DocuPrint 205/255/305. [Tray 1] cannot be set when the optional bypass tray is installed. The default is [Auto].

Output Size

Sets the size of the paper to print on. This can be set when [Auto] or [Tray 1 (Bypass)] is selected for [Paper Tray]. Only cut sheet paper can be set.

Candidate values are shown below. Candidate values displayed differ according to the type of the printer.

[A4] (default)

[A3] [A5] [B4] [B5]

[8.5×14] (Legal)

[8.5×13] (Legal)

[8.5×11] (Letter)

[**] (Unknown. Only displayed)

Important

- When [Paper Tray] is set to one of [Tray 1] to [Tray 4], [Output Size] cannot be set. The size of the paper loaded in the currently set tray is displayed.

Note

- When [Fixed %] or [Full Size] is set at [Zoom Mode], the scaling factor is automatically set by the combination of [Document Size] and [Output Size]. When the 2 Up mode is set, the scaling factor is automatically set by halving the combination of [Document Size] and [Output Size].
- [**] is displayed when the currently loaded paper size is unknown.

Document Size

Sets the size and orientation of the document prepared by the client.

Candidate values are shown below.

[SEF] (default)

This is the same size as that specified at [Output Size].

[LEF]

[A4 SEF] [A4 LEF] [A3 SEF] [A3 LEF] [A5 SEF] [A5 LEF] [B4 SEF] [B4 LEF] [B5 SEF]

[B5 LEF]

[11×17-S] [11×17-L]

[8.5×14-S] [8.5×14-L]

[8.5×13-S] [8.5×13-L]

[8.5×11-S] [8.5×11-L]

[R15×12-L] (continuous roll paper 15 × 12, guaranteed number of printing digits 136 digits/72 lines)

[R15×11-L] (continuous roll paper 15 × 11, guaranteed number of printing digits 136 digits/66 lines)

[R10×12-S] (continuous roll paper 10 × 12, guaranteed number of printing digits 80 digits/72 lines)

[R10×11-S] (continuous roll paper 10 × 11, guaranteed number of printing digits 80 digits/66 lines)

Note

- When continuous roll paper is selected at [Document Size], [Page Position] cannot be set.
- When [Fixed %] or [Full Size] is set at [Zoom Mode], the scaling factor is automatically set by the combination of [Document Size] and [Output Size]. When the 2 Up mode is set, the scaling factor is automatically set by halving the combination of [Document Size] and [Output Size].
- The orientation set here is the orientation of the document. This does not influence the orientation of the paper loaded in the trays.

Quantity

Sets the number of copies to print.

Set within the range 1 (default) to 250.

Important

- When the client has specified the number of copies to print, that value is reflected and that number of copies is printed. After printing ends, the setting on the control panel also is rewritten with that value. Note, however, that the setting on the control panel is not rewritten with the number of copies specified from the NetWare and LPD ports after printing ends.

Note

- When changing the candidate values by the <▼> or <▲> button, the display can be changed continuously by holding the button down. The default is displayed by pressing the <▼> and <▲> buttons simultaneously.

Zoom Mode

■ Fixed % (default)

The scaling factor is automatically calculated from the currently set document size and paper size, and the document is printed so that the document size print area fits into the print area of the paper size. For this reason, the scaling factor becomes 100% (actual size) if the paper is the same size as the document. When 2 Up is set, documents are printed so that the size of two documents fit into the print area of a single page size.

■ Variable %

Sets any scaling value. Scaling values in the range 45 to 210% in 1% units can be set independently for each of the horizontal and vertical directions. Default is 100%.

■ Full Size

The entire surface area of cut sheet paper is printed in the print area.

[Full Size] refers to the scaling factor that is automatically calculated from the currently set document size and paper size. The entire surface is printed so that the physical paper size of the currently set document size fits into the print area of the paper size.

Note

- When continuous roll paper is set at [Document Size], the printing result of [Fixed %] or [Full Size] is the same.
- When changing the candidate values by the <▼> or <▲> button, the display can be changed continuously by holding the button down. The default is displayed by pressing the <▼> and <▲> buttons simultaneously.

2 Sided Print

Sets 2 Sided printing.

Candidate values are shown below.

[Off] (default)

2 sided printing is off.

[Long Edge Flip]

Printing is done from left to right.

[Short Edge Flip]

Printing is done from top to bottom.

Note

- 2 sided printing can be set when the duplex unit (optional) is installed.
- [Long Edge Flip] and [Short Edge Flip] cannot be selected when [Output Size] is set to [Postcard].

2 Up

2 Up is a feature for printing two pages of data on a single page. Documents are printed on either the left/right side or top/bottom side of the paper depending on the paper direction.

Candidate values are as shown below.

[Off] (default)

2 Up printing is disabled.

[Left -> Right]

2 Up printing is enabled. The first received page is printed at the left side or top side of the paper.

[Right -> Left]

2 Up printing is enabled. The first received page is printed at the right side or bottom side of the paper.

Important

- When landscape is specified at [Document Size], the printing result is the same whichever of [Left -> Right] and [Right -> Left] is set.

Output Tray

Sets the tray to which the printed paper is ejected.

[Center Tray] (default)

[Rear Tray]

[OffsetCatchTray]

Note

- [Rear Tray] can be set when the optional rear tray is installed.
- [OffsetCatchTray] can be set when the offset catch tray (optional) is installed.

Bypass-Wait User

Printing is started by operation on the printer (pressing the <Eject/Set> button) after printing by feeding from the bypass tray is instructed. The default is [Off].

Note

- This item can be set when the bypass tray (optional) is installed on DocuPrint 205/255/305.

Font

■ Kanji

Sets the typeface of the double-byte character set (kanji).

[ShuSong] (default)

[FangSong]

[Hei]

[Kai]

■ Alphanumeric

Sets the typeface of the single-byte character set (ANK) to [Roman] (default) or [Sans Serif].

Page Position

Sets the paper position and whether or not the sheet feeder is being used when cut sheet is selected for [Document Size].

Candidate values are shown below.

[CSF Off] (default)

Sets off for the cut sheet feeder setting.

[CSF On]

Sets on for the cut sheet feeder setting.

Note

- [Page Position] cannot be set when continuous roll paper is selected for [Document Size].

Adjust Position

Moves the position of the margin by shifting the data print position to the vertical or horizontal.

■ Up & Down

The position can be specified within the range -250 to 250 mm in 1 mm increments (-9.8 to 9.8 inches in 0.1 inch increments). Default is [0mm].

■ Left & Right

The position can be specified within the range -250 to 250 mm in 1 mm increments (-9.8 to 9.8 inches in 0.1 inch increments). Default is [0mm].

Note

- Data outside the print area is not printed even if the position is compensated. Also, data outside the print area as a result of position compensation is not printed.
- When changing the candidate values by the <▼> or <▲> button, the display can be changed continuously by holding the button down. The default is displayed by pressing the <▼> and <▲> buttons simultaneously.

Print Control

■ Skip Blank Pages

Sets whether or not to output blank pages when there is no data at all to print out like the data of only new pages.

At the default setting, blank pages are not output.

Note

- When [On] is set, a blank page is output in the case of spaces created by specially registered characters, or in the case of white-only image data.
- When [On] is set, and 2 Up printing or 2 sided printing has been selected, 2 Up or 2 sided printing is processed with blank pages skipped.

■ Image Enhance

[Image Enhance] is a feature for smoothing the boundary between black and white areas to reduce jagged edges, and to enhance resolution in a pseudo manner.

Candidate values are shown below.

[On] (default)

The image enhance feature is enabled during printing.

[Off]

The image enhance feature is disabled during printing.

■ Character Range

The position of the right margin can be extended.

Candidate values are shown below.

[Normal] (default)

Sets the position of the right margin to the 136 digit position at 10 cpi.

[Extended Range]

Extends the position of the right margin and prints in that area when there is free space to the right of the 136 digit position at 10 cpi as a result of the scaling factor setting.

Note

- When the printed digit range setting is changed from [Extended Range] to [Normal], the left and right margin values are initialized.
- When the right margin position is set by a command, that position becomes the right edge.

ESCP Switch

Important

- Each of the [Text], [Minimum Text], [Page Length] and [1 inch Skip] settings is not reflected when extended commands arrive as these features select defaults.

■ Text

Sets the print quality mode of the text to [Text High Dens.] (default) or [Draft].

Note

- Actual printing is not changed by changing this setting.
- This setting influences the text definition selection command.

■ Minimum Text

Text can be printed in reduced size when printing 1-byte type alphanumerics.

[Off] (default)

Alphanumerics are printed at actual size.

[On]

Alphanumerics are printed reduced in size.

■ Character Code

Sets the type of the character code to [Graphic] (default) or [Slant].

■ Page Length

Sets [11 inches] (default) or [12 inches] for the length (print area) of one page.

■ 1 inch Skip

Sets whether or not to leave one inch between pages.

[Off] (default)

Does not leave a one-inch gap between pages.

[On]

Leaves a one-inch gap between pages. When you set to leave a one-inch gap between pages, you can print to leave a one-inch gap between pages even with cut sheet paper just like skipping of perforations when continuous roll paper is used.

Important

- This is executed when use of the cut sheet feeder is set to [Off] at [Page Position].

■ Feed Position

Sets the printing start position to either of [8.5 mm] (or [0.3"]) (default) or [22 mm] (or [0.9"]) from the top edge of the paper.

■ CR Functions

Sets the operation when the CR command is received.

[CR] (default)

Returns the print head only.

[CR/LF]

Returns the print head and performs a line feed.

■ 0 Style

Sets the 0 character style.

[0] (default)

The normal "0" character is set.

[∅]

The slashed "0" character is set.

Extension

Sets whether or not to enable the specified extender. Printing can be controlled using text code when the extender is enabled. Default is [Disable].

Note

- Extended commands are prefixed with the extender, followed by command recognition data and parameter data, if necessary. An “extender” is the first two bytes (ESC (1BH in Hex) followed by a “;” (semicolon, 3BH in Hex) of an extended command.

Extended Text

Sets the extender (first two bytes) of an extended command if you want to enable printing by text codes. Valid codes are 0x21 to 0x7d. Default is [&%].

Note

- Extended commands are prefixed with the extender, followed by command recognition data and parameter data, if necessary. An “extender” is the first two bytes (ESC (1BH in Hex) followed by a “;” (semicolon, 3BH in Hex) of an extended command.

Stored Jobs Menu

Settings can be registered to NV memory (No. 01 to 05) and called up as required.

At startup

[At startup] refers to the reading of non-volatile memories (No. 01 to 05) pre-registered by [Store] when the power is switched on or the system is reset.

Here, set the No. of the NV memory to call up.

The default is [Factory], which means that the default settings are called up when the printer is started up.

Retrieve

This feature calls up pre-registered settings.

Sets the No. of the memory to call up.

The default is [Factory], which means that the default settings are called up.

Store

There are two types of memory, ROM for storing defaults, and NV memory (No. 01 to 05) for holding user settings.

With register memory, the various preset mode menu settings are registered as a group to NV memory (No. 01 to 05).

Registering these settings in advance makes it easier to call up mode menu settings, and you are no longer required to repeat the same settings each time after the printer is switched on.

Registered settings are stored until you initialize NV memory or clear memory.

Delete

Clears the settings registered to NV memory.

Sets the No. of the memory to clear.

Note

- [No. 01] to [No. 05] are not displayed if there is nothing registered in memory.
- To protect against the wrong settings being made due to commands received from a client, we recommend that you press the <Online> button and go offline while you are registering data to memory.

Setting the ESC/P Mode Menu

The following example explains how to set the ESC/P mode document size to [A3 SEF] using the mode menu.

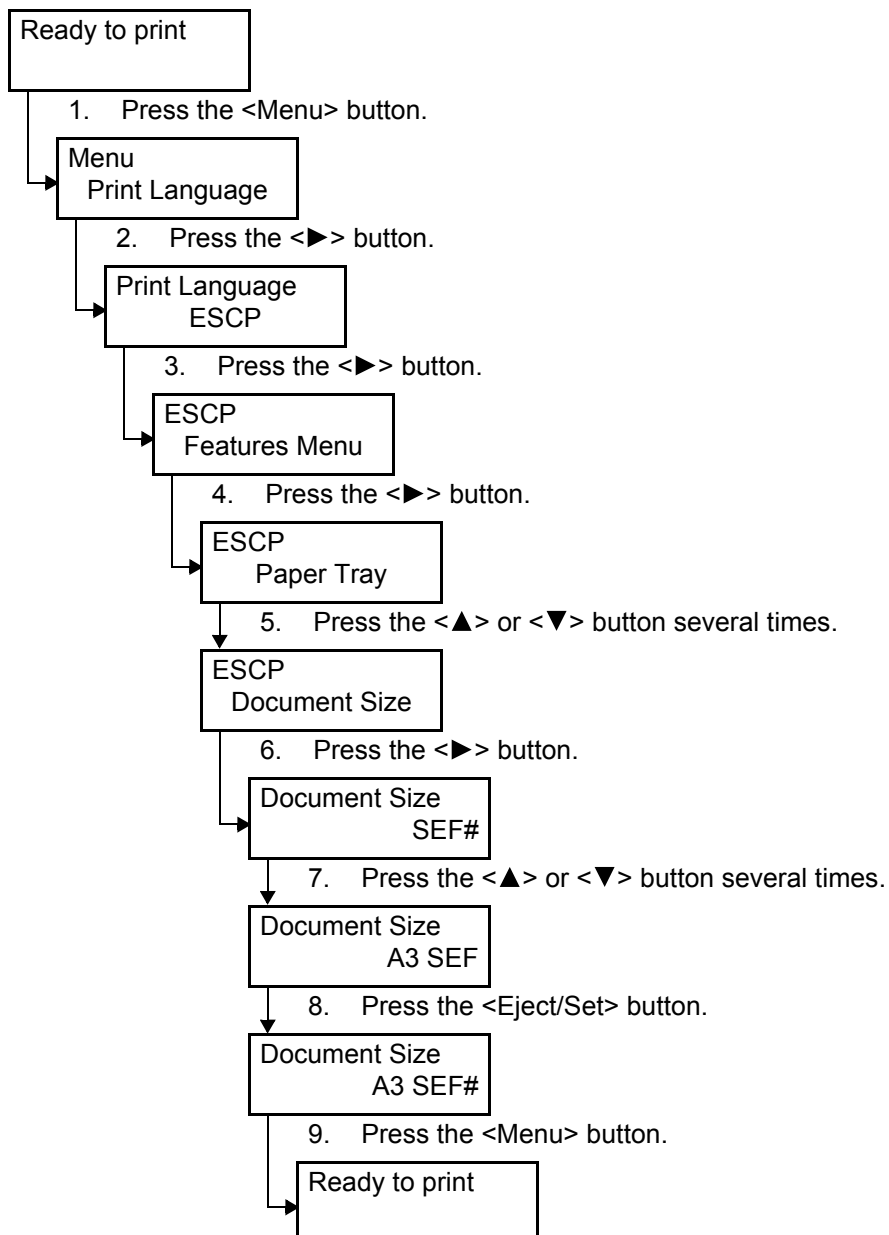

2.3 About the ESC/P Mode List

This section explains the ESC/P mode list.

Note

- For details on other reports/lists, refer to the User Guide 6.2 Printing Reports/Lists.

ESC/P Mode List

- ESC/P Settings List
Setting values made in the ESC/P can be checked.
- ESC/P User Definition List
In the [ESC/P User Definition List], the usage status of registered logos and user definition area can be checked.

Print Method

On the control panel, select [Report/List] > [Print Language] > [ESC/P Settings] or [Report/List] > [User Defined] to print lists.

3 Materials Related to ESC/P Mode

3.1 List of Scaling Values

Note

- Some output sizes may not be used depending on the printer model.

Fixed Scaling Values

Document Size	Output Size	A3	A4	A5	B4	B5	11 × 17	8.5 × 14	8.5 × 13	8.5 × 11	Post card
A3	Long side	100	70	49	86	60	103	84	78	66	100
	Short side	100	70	48	86	60	94	72	72	72	100
A4	Long side	143	100	70	123	86	147	120	112	94	48
	Short side	143	100	69	123	86	135	103	103	103	45
A5	Long side	204	143	100	177	123	210	172	160	135	69
	Short side	207	145	100	178	124	195	149	149	149	65
B4	Long side	116	81	57	100	70	119	98	90	76	100
	Short side	116	81	56	100	70	109	83	83	83	100
B5	Long side	164	116	81	143	100	171	140	130	109	56
	Short side	164	116	81	143	100	156	120	120	120	53
11 × 17	Long side	97	68	48	84	59	100	82	76	64	100
	Short side	106	74	51	92	64	100	77	77	77	100
8.5 × 14	Long side	119	83	58	102	72	122	100	93	78	100
	Short side	139	97	67	120	84	131	100	100	100	100
8.5 × 13	Long side	128	90	63	111	77	132	108	100	84	100
	Short side	139	97	67	120	84	131	100	100	100	100
8.5 × 11	Long side	152	106	74	131	92	156	128	119	100	100
	Short side	139	97	67	120	84	131	100	100	100	100

Document Size	Output Size	A3	A4	A5	B4	B5	11 × 17	8.5 × 14	8.5 × 13	8.5 × 11	Post card
Postcard	Long side	100	100	145	100	178	100	100	100	100	100
	Short side	100	100	153	100	190	100	100	100	100	100
15 × 1	Long side	119	83	58	103	72	122	100	93	78	100
	Short side	103	72	50	89	62	97	74	74	74	100
15 × 2	Long side	119	83	58	103	72	122	100	93	78	100
	Short side	95	66	46	81	57	89	68	68	68	100
10 × 11	Long side	147	103	72	127	89	151	124	115	97	50
	Short side	142	99	68	122	85	133	102	102	102	45
10 × 12	Long side	135	95	66	117	81	139	114	105	89	46
	Short side	142	99	68	122	85	133	102	102	102	45

Unit: [%]

Note

- When the scaling value of the long or short side is outside of the range 45 to 210%, the scaling value for both the long and short sides is set to 100%.

Fixed Scaling Value (When 2 Up Is Specified)

Document Size	Output Size	A3/2	A4/2	A5/2	B4/2	B5/2 B5/2	11 × 17	8.5 × 14	8.5 × 13	8.5 × 11	Post card/2
A3	Long side	70	49	100	60	100	66	50	50	50	100
	Short side	70	48	100	60	100	72	59	54	45	100
A4	Long side	100	70	48	86	60	94	72	72	72	100
	Short side	100	69	48	86	59	103	84	78	65	100
A5	Long side	143	100	69	123	86	135	103	103	103	45
	Short side	145	100	69	124	86	149	121	112	94	47
B4	Long side	81	57	100	70	49	76	58	58	58	100
	Short side	81	56	100	70	48	83	68	63	53	100

Document Size	Output Size	A3/2	A4/2	A5/2	B4/2	B5/2 B5/2	11 × 17	8.5 × 14	8.5 × 13	8.5 × 11	Post card/2
B5	Long side	116	81	56	100	70	109	83	83	83	100
	Short side	116	80	55	100	69	120	98	90	76	100
11 × 17	Long side	68	48	100	59	100	64	49	49	49	100
	Short side	74	51	100	64	100	77	62	58	48	100
8.5 × 14	Long side	83	58	100	72	50	78	60	60	60	100
	Short side	97	67	100	84	57	100	82	75	63	100
8.5 × 13	Long side	90	63	100	77	54	84	64	64	64	100
	Short side	97	67	100	84	57	100	82	75	63	100
8.5 × 11	Long side	106	74	51	92	64	100	77	77	77	100
	Short side	97	67	46	84	57	100	82	75	63	100
Postcard	Long side	100	145	100	178	124	100	149	149	149	65
	Short side	100	153	105	190	131	100	185	172	144	71
15 × 11	Long side	83	58	100	72	100	78	60	60	60	100
	Short side	72	50	100	62	100	74	60	56	47	100
15 × 12	Long side	83	58	100	72	100	78	60	60	100	100
	Short side	66	46	100	57	100	68	55	51	100	100
10 × 11	Long side	103	72	50	89	62	97	74	74	74	100
	Short side	99	68	47	85	59	102	83	77	64	100
10 × 12	Long side	95	66	46	81	57	89	68	68	68	100
	Short side	99	68	47	85	59	102	83	77	64	100

Unit: [%]

Note

- When the scaling value of the long or short side is outside of the range 45 to 210%, the scaling value for both the long and short sides is set to 100%.

Cut Sheet Scaling Value (Full Size)

Document Size	Output Size	A3	A4	A5	B4	B5	11 × 17	8.5 × 14	8.5 × 13	8.5 × 11	Post card
A3	Long side	98	69	48	85	59	101	83	77	64	100
	Short side	97	68	47	84	58	91	70	70	70	100
A4	Long side	138	97	68	120	84	142	117	108	91	100
	Short side	137	96	66	118	82	129	99	99	99	100
A5	Long side	196	137	96	169	118	201	165	153	129	66
	Short side	195	136	94	168	117	183	140	140	140	62
B4	Long side	113	79	55	98	68	116	95	88	74	100
	Short side	112	78	54	97	67	105	81	81	81	100
B5	Long side	160	112	78	138	97	165	135	125	105	54
	Short side	158	110	76	136	95	149	114	114	114	50
11 × 17	Long side	95	67	47	82	57	98	80	74	63	100
	Short side	103	72	50	89	62	97	74	74	74	100
8.5 × 14	Long side	116	81	57	100	70	119	98	90	76	100
	Short side	133	93	64	115	80	125	96	96	96	100
8.5 × 13	Long side	125	87	61	108	75	128	105	97	82	100
	Short side	133	93	64	115	80	125	96	96	96	100
8.5 × 11	Long side	147	103	72	127	89	151	124	115	97	100
	Short side	133	93	64	115	80	125	96	96	96	100
Postcard	Long side	100	195	136	100	168	100	100	100	183	94
	Short side	100	201	139	100	173	100	100	100	207	91
15 × 11	Long side	135	95	66	117	81	139	105	114	89	46
	Short side	142	99	68	122	85	133	102	102	102	45

Document Size	Output Size	A3	A4	A5	B4	B5	11 × 17	8.5 × 14	8.5 × 13	8.5 × 11	Post card
15 × 12	Long side	135	95	66	117	81	139	105	114	89	46
	Short side	142	99	68	122	85	133	102	102	102	45
10 × 11	Long side	147	103	72	127	89	151	115	124	97	50
	Short side	142	99	68	122	85	133	102	102	102	45
10 × 12	Long side	147	103	72	127	89	151	124	115	97	50
	Short side	142	99	68	122	85	133	102	102	102	45

Unit: [%]

Note

- When the scaling value of the long or short side is outside of the range 45 to 210%, the scaling value for both the long and short sides is set to 100%.

Cut Sheet Scaling Value (Full Size) (When 2 Up Is Specified)

Document Size	Output Size	A3/2	A4/2	A5/2	B4/2 B5/2	B5/2 B5/2	11 × 17	8.5 × 14	8.5 × 13	8.5 × 11	Post card/2
A3	Long side	69	48	100	59	100	64	49	49	100	100
	Short side	68	47	100	58	100	70	57	53	100	100
A4	Long side	97	68	47	84	58	91	70	70	70	100
	Short side	96	66	46	82	57	99	80	74	62	100
A5	Long side	137	96	66	118	82	129	99	99	99	100
	Short side	136	84	65	117	80	140	114	106	88	100
B4	Long side	79	55	100	68	48	74	57	57	57	100
	Short side	78	54	100	67	46	81	66	61	51	100
B5	Long side	112	78	54	97	67	105	81	81	81	100
	Short side	110	76	53	95	65	114	93	86	72	100
11 × 17	Long side	67	47	100	57	100	63	48	48	48	100
	Short side	72	50	100	62	100	74	60	56	47	100

Document Size	Output Size	A3/2	A4/2	A5/2	B4/2 B5/2	B5/2 B5/2	11 × 17	8.5 × 14	8.5 × 13	8.5 × 11	Post card/2
8.5 × 14	Long side	81	47	100	70	49	76	58	58	58	100
	Short side	93	50	100	80	55	96	78	72	61	100
8.5 × 13	Long side	87	61	100	75	52	82	63	63	63	100
	Short side	93	64	100	80	55	96	78	72	61	100
8.5 × 11	Long side	103	89	100	89	72	97	74	74	74	100
	Short side	93	80	100	80	55	96	78	72	61	100
Postcard	Long side	195	136	94	168	117	183	140	140	140	62
	Short side	201	139	96	173	119	207	169	156	131	65
15 × 11	Long side	95	66	46	81	57	89	68	68	68	100
	Short side	99	68	47	85	59	102	83	77	64	100
15 × 12	Long side	95	66	46	81	57	89	68	68	68	100
	Short side	99	68	47	85	59	102	83	77	64	100
10 × 11	Long side	103	72	50	89	62	97	74	74	74	100
	Short side	99	68	47	85	59	102	83	77	64	100
10 × 12	Long side	103	72	50	89	62	97	74	74	74	100
	Short side	99	68	47	85	59	102	83	77	64	100

Unit: [%]

Note

- When the scaling value of the long or short side is outside of the range 45 to 210%, the scaling value for both the long and short sides is set to 100%.

3.2 Paper Size and Number of Printed Digits

Note

- Some output sizes may not be used depending on the printer model.

When Paper Feed Position Is 22 mm (0.9")

Output Size	Portrait		Landscape	
	Number of printed digits	Number of printed lines	Number of printed digits	Number of printed lines
A3	113	92	161	63
B4	97	78	139	53
A4	79	63	113	42
B5	68	53	97	35
A5	54	42	79	27
Postcard	35	30	54	19
11 × 17	106	94	166	58
8.5 × 14	81	76	136	43
8.5 × 13	81	70	126	43
8.5 × 11	81	58	106	43

When Feed Position Is 8.5 mm (0.3")

Output Size	Portrait		Landscape	
	Number of printed digits	Number of printed lines	Number of printed digits	Number of printed lines
A3	113	95	161	66
B4	97	82	139	56
A4	79	66	113	45
B5	68	56	97	39
A5	54	45	79	31
Postcard	35	30	54	19
11 × 17	106	98	166	62
8.5 × 14	81	80	136	47
8.5 × 13	81	74	126	47
8.5 × 11	81	62	106	47

Note

- The above values were obtained based upon a character pitch of 10 cpi and line pitch of 6 lpi.
- The V/H scaling value for each value is 100%.

Cut Sheet (Full Size)

Output Size	Portrait		Landscape	
	Number of printed digits	Number of printed lines	Number of printed digits	Number of printed lines
A3	116	99	165	70
B4	101	85	143	60
A4	82	70	116	49
B5	71	60	101	42
A5	58	49	82	34
Postcard	39	34	58	23
11 × 17	110	102	170	66
8.5 × 14	85	84	140	51
8.5 × 13	85	78	130	51
8.5 × 11	85	66	110	51

Note

- The above values were obtained based upon a character pitch of 10 cpi and line pitch of 6 lpi.

15" Continuous Roll Paper Mode (Fixed in Landscape Orientation/fixed Flush Left)

Output Size	Portrait		Landscape	
	Number of printed digits	Number of printed lines	Number of printed digits	Number of printed lines
All compatible paper sizes	136	66	136	72

Note

- The above values were obtained based upon a character pitch of 10 cpi and line pitch of 6 lpi.

10" Continuous Roll Paper Mode

Output Size	Portrait		Landscape	
	Number of printed digits	Number of printed lines	Number of printed digits	Number of printed lines
All compatible paper sizes	80	66	80	72

Index

B

barcode 11

C

configuring ESC/P mode menu settings 21
cut sheet scaling value (full size) 26
cut sheet scaling value (full size) (when 2 up is
specified) 27

E

eject function 9
emulation mode 6
ESC/P Settings List 22

F

fixed scaling value (when 2 up is
specified) 24
fixed scaling values 23
font cache 8

H

host interface 6

M

mode menu 12
multiple up 11

N

number of print lines 29

O

outline fonts 8

U

user-defined fonts 8

Customer Response Sheet

ESC/P Emulation Settings Guide (ME3212E2-1)

To improve our publications, we would appreciate your feedback regarding this guide. Please take a few moments to complete and return this form to us.

● About Yourself

1. How often do you use this guide?

Daily Weekly Monthly Infrequently

2. When do you usually refer to the guide?

Doing a usual operation Using unfamiliar features

Solving a problem

3. Which part of the guide do you read frequently?

Chapter/Section/Page:

4. Where do you keep this guide?

5. (Optional)

Your Name:

Occupation:

Company or organization:

Address:

● About the Guide

	Strongly agree		Neutral		Strongly disagree
1. It is handy.	1	2	3	4	5
2. It is easy to read.	1	2	3	4	5
3. Titles of chapters and sections make sense.	1	2	3	4	5
4. Information is logically placed.	1	2	3	4	5
5. Referencing is easy.	1	2	3	4	5
6. Content is easy to understand.	1	2	3	4	5
7. The step-by-step instructions are easy to follow.	1	2	3	4	5
8. All necessary information is included.	1	2	3	4	5
9. Illustrations aid in the understanding of content.	1	2	3	4	5
10. The use of color is effective.	1	2	3	4	5

Other comments:

After completing this form, detach and send it to the address below.

(Please use your own envelope and postage stamp.)

Thank you for your cooperation.



Fuji Xerox Co., Ltd.

KSP R&D 2D7

3-2-1, Sakado, Takatsu-ku

Kawasaki-shi, Kanagawa-ken

JAPAN 213-0012.

ESC/P Emulation Settings Guide

Human Interface Design Development
Document Products & Supply Company
Fuji Xerox Co., Ltd.

ME3212E2-1 (Edition 1)
Copyright© 2003 by Fuji Xerox Co., Ltd.

List of Mode Menu (ESC/P)

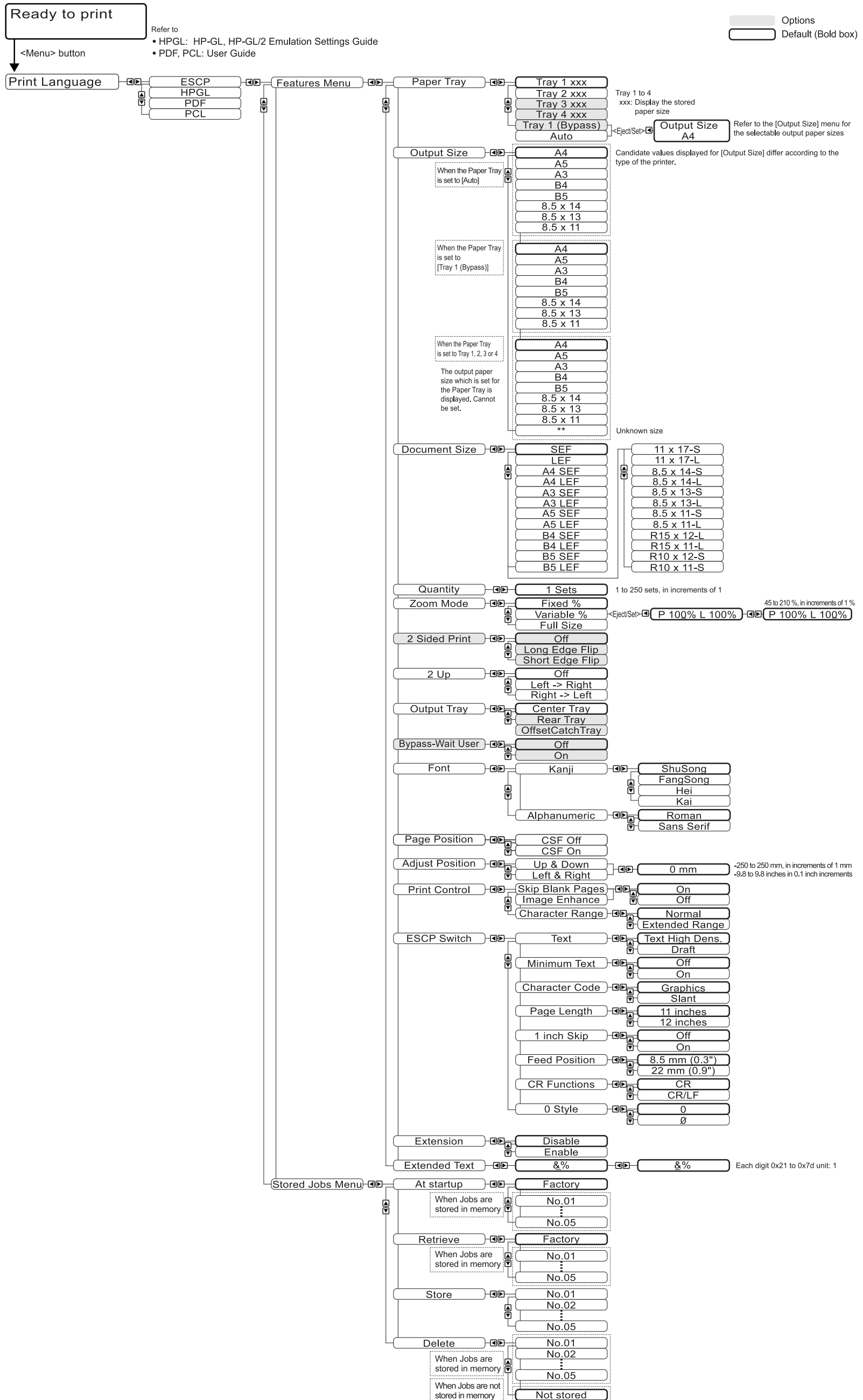

Free Manuals Download Website

<http://myh66.com>

<http://usermanuals.us>

<http://www.somanuals.com>

<http://www.4manuals.cc>

<http://www.manual-lib.com>

<http://www.404manual.com>

<http://www.luxmanual.com>

<http://aubethermostatmanual.com>

Golf course search by state

<http://golfingnear.com>

Email search by domain

<http://emailbydomain.com>

Auto manuals search

<http://auto.somanuals.com>

TV manuals search

<http://tv.somanuals.com>