

DocuCentre S2420

DocuCentre S2220

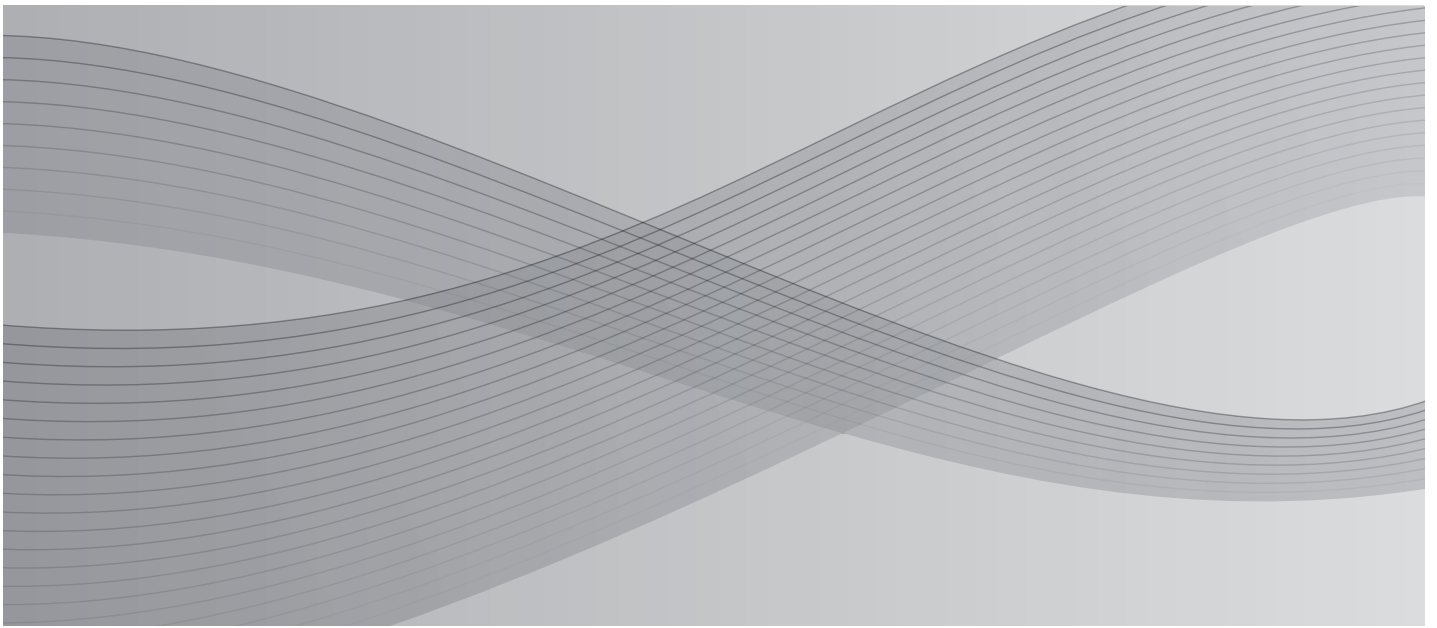

## Basic Operation Guide

This manual describes the basic operations for using this machine.

# About Quick-Buttons

Just simply pressing a Quick-Button allows you to:

- Directly access to the setting screen and check the current setting value.
- Easily moves your selection from one item to another by pressing the single button. As a new setting is applied, its icon changes accordingly on the screen.
- Just 2 seconds after pressing the button, the setting screen is closed and the last selected item is applied.
- With the [Quick-Button Selection Timer] from the <Machine Status> button, you can change the displayed time for up to 5 seconds.

Practical use of Quick-Buttons:

- Keep pressing the button while you calmly decide your setting value.
- Stop pressing the button when your desired setting is being selected.

Once you get used to the Quick-Button operation, you can easily change the settings. By using the <OK> and the arrow buttons also changes the settings, but this operation is generally not recommended.

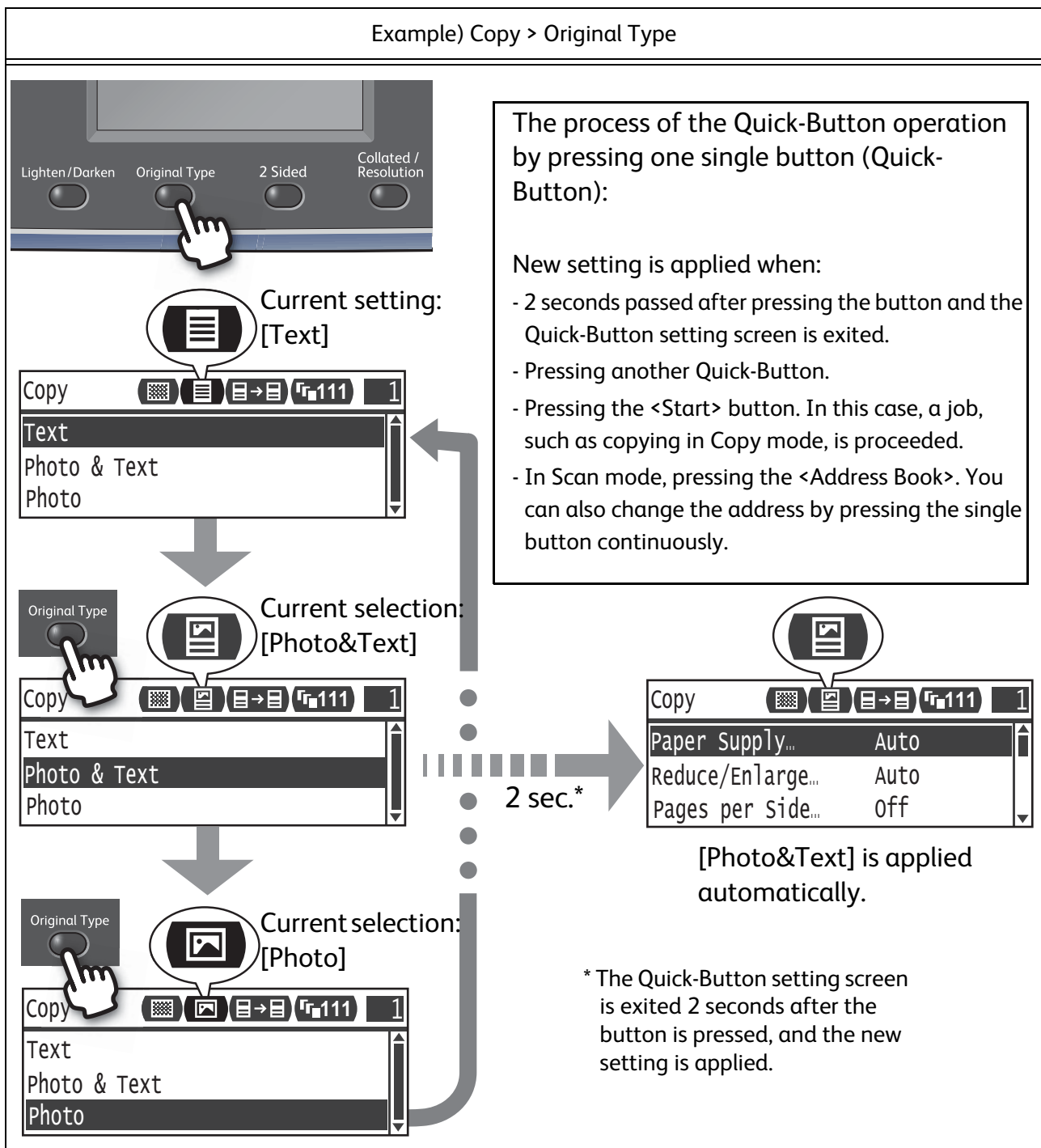

Windows is trademark or registered trademark of Microsoft Corporation in the United States and/or other countries.

All product/brand names are trademarks or registered trademarks of the respective holders.

Microsoft product screen shot(s) reprinted with permission from Microsoft Corporation.

In this manual, safety instructions are preceded by the symbol .  
Always read and follow the instructions before performing the required procedures.

The data saved in the hard disk of the machine may be lost if there is any problem in the hard disk.  
Fuji Xerox is not responsible for any direct and indirect damages arising from or caused by such data loss.

Fuji Xerox is not responsible for any breakdown of machines due to infection of computer virus or computer hacking.

**Important**

1. This manual is copyrighted with all rights reserved. Under the copyright laws, this manual may not be copied or modified in whole or part, without the written consent of the publisher.
2. Parts of this manual are subject to change without prior notice.
3. We welcome any comments on ambiguities, errors, omissions, or missing pages.
4. Never attempt any procedure on the machine that is not specifically described in this manual. Unauthorized operation can cause faults or accidents. Fuji Xerox is not liable for any problems resulting from unauthorized operation of the equipment.

An export of this product is strictly controlled in accordance with Laws concerning Foreign Exchange and Foreign Trade of Japan and/or the export control regulations of the United States.

XEROX, the sphere of connectivity design, and CentreWare are trademarks or registered trademarks of Xerox Corporation in the U.S. or Fuji Xerox Co., Ltd.

# Table of Contents

---

About Quick-Buttons .....	2
Table of Contents .....	4
Preface .....	5
Preface .....	5
Types of Manuals .....	5
Main Features on the Control Panel .....	6
Informative Pointers .....	8
Before Using This Machine .....	10
Safety Notes .....	10
Regulations.....	17
Environment.....	17
Legal Notice .....	17
Preparations.....	18
Paper Types.....	18
Loading Paper .....	19
Placing Document .....	21
Copy .....	23
How to Copy .....	23
Copying an ID Card .....	24
Making 2 Sided Copies .....	25
Collating Output.....	26
Making Reduced or Enlarged Copies .....	27
Copying Two/Four Pages onto One Sheet.....	28
Print.....	29
How to Print .....	29
Scan.....	30
Importing Scanned Data via Application .....	30
Sending Scanned Data via E-mail.....	31
Sending Scanned Data to PC (Network) .....	32
Fax .....	33
How to Fax.....	33
Registering Phone Book .....	35
Problem Solving.....	36
Paper Jams .....	36
Document Jams.....	39
Error Code .....	40
Index.....	51

# Preface

---

Thank you for choosing the DocuCentre S2420/S2220 (hereafter referred to as "the machine").

This guide describes how to operate the machine and the precautions you should follow during operation. To get the most out of the machine and to use it effectively, be sure to read this guide before use.

This guide assumes that you have a basic knowledge of the operating environment of the personal computer in use and networking environments. For information on the environment of the personal computer in use and the basic knowledge and operations of networking environments, refer to the manuals provided with the personal computer, operating system, and network system.

After reading this guide, be sure to keep it handy for quick reference. It will be useful in case you forget how to perform operations or if a problem occurs with the machine.

For detailed information of this machine, refer to the "User Guide" included on the Driver CD Kit provided with this machine.

## Types of Manuals

---

The following guides are provided with the machine.

### Accompanying Manuals

■ **Basic Operation Guide (this guide) (Booklet) (Driver CD Kit)**

The guide describes a quick reference for the basic operations, daily maintenance, and problem solving for this machine. (The Indonesian version of this guide is included in the Driver CD Kit.)

■ **User Guide (Driver CD Kit)**

The guide describes how to use the copy, print, fax and scan features as well as show to set the paper, perform everyday maintenance, make machine status settings, perform troubleshooting, and set up a network.

■ **Manual (HTML)**

The manual describes installation and configuration procedures for print drivers and the printer environment. This manual is included in the Driver CD Kit.

■ **Print Driver Help**

The help describes print features and operations.

# Main Features on the Control Panel

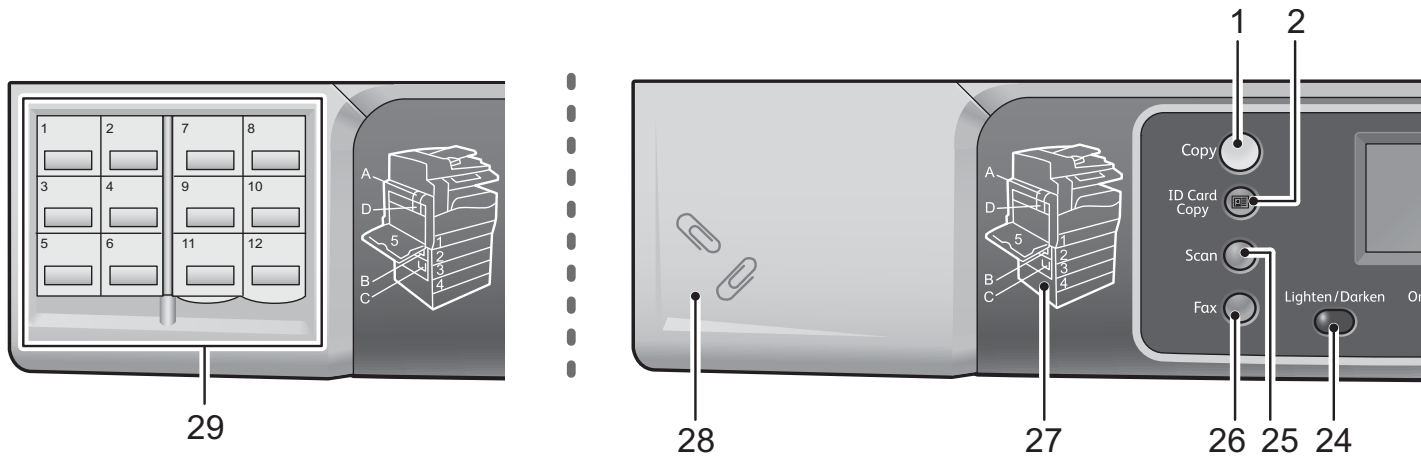

No.	Component	Function
1	<Copy> button	Press this button to use the Copy feature. When the Copy feature is selected, this button lights up.
2	<ID Card Copy> button	Press this button to use the ID Card Copy feature. When the ID Card Copy feature is selected, this button lights up.
3	Display	Displays the operation menus and machine status messages.
4	<Job Status> button	Press this button to check/cancel a current job or pending job.
5	<▲> <▼> <◀> <▶> buttons	Press these buttons to select a menu item on the menu screen, and to change settings. <b>Note</b> <ul style="list-style-type: none"> <li>• The &lt;▲&gt; button allows you to select the previous menu item.</li> <li>• The &lt;▼&gt; button allows you to select the next menu item.</li> <li>• The &lt;◀&gt; button allows you to go to the next menu screen.</li> <li>• The &lt;▶&gt; button allows you to return to the previous screen.</li> </ul>
6	<OK> button	Press this button and the arrow buttons to change settings.
7	<Log In/Out> button	Press this button to enter or exit System Administration mode (for at least for 4 seconds) or Account mode. This button lights up when the machine is in the System Administration mode.
8	Numeric keypad	Press this button to enter numbers (such as number of copies) or text.
9	<Dial Pause> button	Press this button to insert a pause between numbers while entering a recipient's number.
10	<Machine Status> button	Press this button to print reports and check the machine information such as the status of consumables and the machine's the IP address.
11	<Energy Saver> button	Lights up when the machine enters Energy Saver mode to conserve power when the machine is left idle for a while. You can also press this button to enter or exit the Energy Saver mode.
12	<Stop> button	Press this button to cancel a current job or failed job.
13	<ClearAll> button	Press this button to reset the displayed settings of each feature to default values or clear the entered numbers. The setting returns to the same condition as the machine is powered on.
14	<Start> button	Press this button to start scanning documents or confirm the value of each setting.
15	<Error> indicator	Blinks if a system error occurs. This indicator lights up when a problem other than a system error occurs with the machine, including paper jams and running out of paper.

# Main Features on the Control Panel

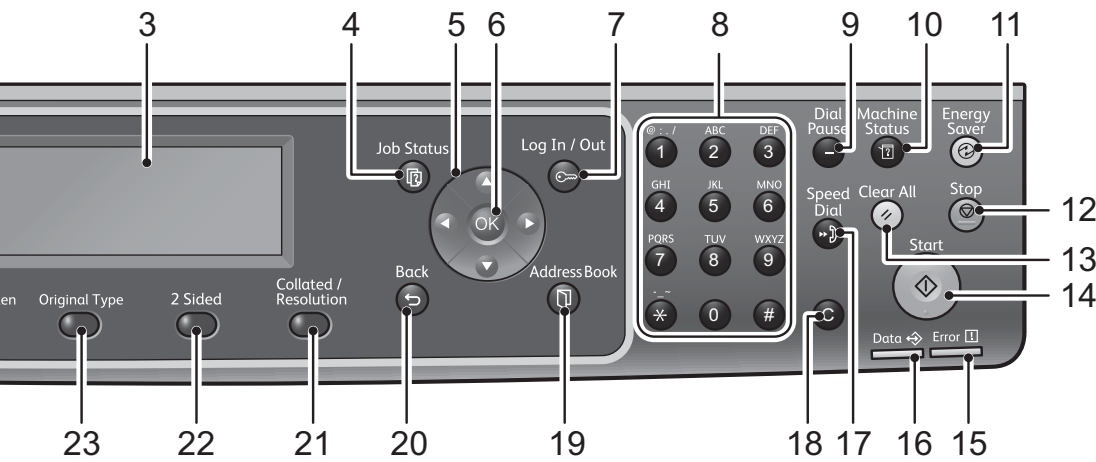

16	<Data> indicator	Blinks when the machine is sending or receiving data to or from a client. This indicator lights up when data is stored in the machine's memory or when received faxes waiting to be printed.
17	<Speed Dial> button	Press this button to specify a recipient with entering a Speed Dial number when sending a fax.
18	<C> (Clear) button	Press this button to delete one numerical value that you have entered.
19	<Address Book> button	Press this button to display the recipients registered for the Address Book when sending data by fax, e-mail, or network.
20	<Back> button	Press this button to return the display to the previous screen.
21	<Collated/Resolution> button (Quick-Button)	Press this button to display the setting screen for the Collated or Resolution function that lets you change the output method for Copy feature and the resolution for Scan feature. The button lights up when this function is available.
22	<2 Sided> button (Quick-Button)	Press this button to display the setting screen for the 2 Sided function that lets you select 2 sided printing for Copy and Scan features. The button lights up when this function is available.
23	<Original Type> button (Quick-Button)	Press this button to display the setting screen for the Original Type function that lets you change the type of document for Copy, ID Card Copy, and Scan features. The button lights up when this function is available.
21	<Lighten/Darken> button (Quick-Button)	Press this button to display the setting screen for the Lighten/Darken function that lets you adjust the brightness for Copy, ID Card Copy, and Scan features. Also, the Toner Saver setting is available for Copy feature. The button lights up when this function is available.
25	<Scan> button	Press this button to use the Scan feature. When the Scan feature is selected, this button lights up.
26	<Fax> button	Press this button to use the Fax feature. When the Fax feature is selected, this button lights up.
27	Outline view	Used to verify the location indicated in an error message appears on the display.
28	Paper clip tray	Used as a place to store paper clips, staples, etc.
29	One touch panels (Only available for machines with the Fax Kit)	Used to specify the recipient when sending a fax. The recipients registered for the one touch buttons 01 to 36 correspond to the Speed Dial numbers 001 to 036.

# Informative Pointers

With regularly using multifunctional machines, knowing few things can help you avoid having troubles and make use of the machine more comfortable.

Please read this guide before using the machine.

## Load only paper inside a tray

Make sure there is no object except paper inside of the trays.

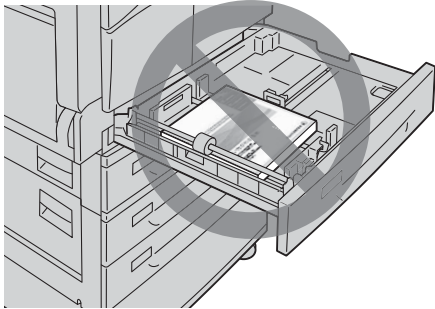

Do not place any guides or objects in the empty space (outside of the paper guides).

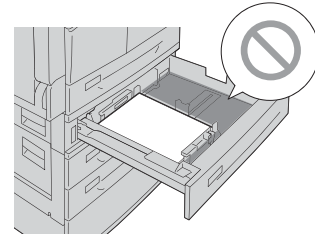

➔ You can prevent the following problem situation:

- Cause noise on the left side of the machine.

## Using the correct printer driver?

When you use the new multifunctional machine, you need to install the new printer driver. Install the new driver for this machine (DocuCentre S2420 or DocuCentre S2220).

Check the printer driver installed in your computer.

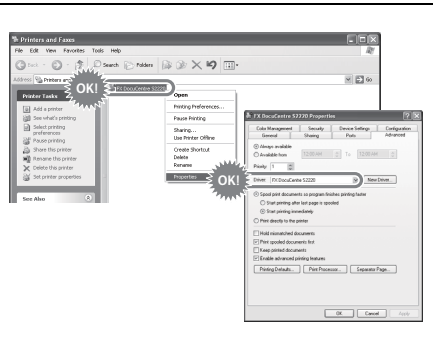

➔ You can prevent the following problem situations:

- Unreadable characters are printed.
- Unnecessary lines are printed.
- A part of the image is missing.
- Encounters an error and cannot print.
- The images having different tones are printed.



## Clean the glass for clear copy!

Check the glass before starting to copy.



Even when you use the document feeder, dirt of the glass may cause unsatisfactory result.

### When using the document feeder:

Clean the narrow glass strip on the left side of the document glass. Wipe the glass with a soft cloth moistened with water first, and then wipe it with a soft dry cloth.

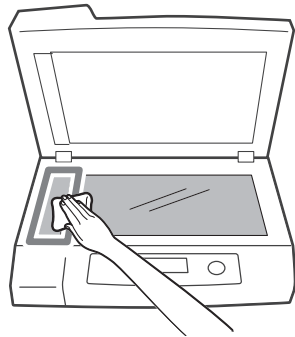

### When using the document glass:

Clean the document glass. Wipe the glass with a soft cloth moistened with water first, and then wipe it with a soft dry cloth.



Looking over the glass from the front and angles helps you find any dirt.



You can prevent the following problem situations:

- The copy has black lines when using the document feeder.
- The copy has black dots when using the document glass.

## Notes on Switching ON/OFF the Power

When restarting the machine, wait for 10 seconds before switching the power on.

## Safety Notes

Before using this product, read "Safety Notes" carefully for safety use.

This product and recommended supplies have been tested and found to comply with strict safety requirements including safety agency approvals and compliance with environmental standards. Follow the following instructions for safety use.

**⚠ WARNING**

Any unauthorized alteration including an addition of new functions or connection to external devices may not be covered by the product warranty. Contact your local Fuji Xerox representative for more information.

Follow all warning instructions marked on this product. The warning marks stand for the followings:

**⚠ DANGER**

Used for item that if not followed strictly, can lead death or severe or fatal injuries and the possibility to do it is comparatively high.

**⚠ WARNING**

Used for items that if not followed strictly, can lead to severe or fatal injuries.

**⚠ CAUTION**

Used for items that if not followed strictly, can cause injuries to user or damages to machine.

⚠: A symbol for items to pay attention to when handling machine. Follow instructions carefully to use machine safely.



Caution



Flammable



Explosive



Electric shock



Heated surface



Moving object



Pinched fingers

⊘: A symbol for prohibited items. Follow instructions carefully to avoid any dangerous acts.



Prohibited



No fire



Do not touch



Do not use in bathroom



Do not tear down



Keep away from wet



Never touch with wet hand

●: A symbol for items that must be performed. Follow instructions carefully to carry out these essential tasks.



Instructions



Unplug



Ground/Earth

## Electrical Safety

### **WARNING**

This product shall be operated by the power source as indicated on the product's data plate. Consult your local power company to check if your power source meets the requirements.



**WARNING:** Connect this product to a protective earth circuit.

This product is supplied with a plug that has a protective earth pin. The plug fits only into an earthed electrical outlet. This is a safety feature. If the plug doesn't fit to the outlet, contact an electrician to replace the outlet to avoid risk of electric shock. Never use an earthed adapter plug to connect the product to the electrical outlet that has no earth connection terminal.

Improper connection of a grounding conductor may cause electric shock.



Plug the power cord directly into a grounded electrical outlet. To prevent overheating and a fire accident, do not use an extension cord, a multi-plug adaptor or a multiple connector. Consult your local Fuji Xerox representative to check if an outlet is grounded.



Connect this product to a branch circuit or an outlet that has larger capacity than the rated ampere and voltage of this product. See the data plate on the rear panel of this product for its rated ampere and voltage.



Never touch the power cord with wet hands. It may cause electric shock.



Do not put an object on the power cord.



Always keep the plug connection free of dust. The dusty and damp environment may bring about minute electric current in a connector. It may generate heat and eventually cause a fire accident.



To avoid the risk of electric shock and a fire accident, only use the power cord supplied with this product or the ones designated by Fuji Xerox. The power cord is exclusive use for this product. Do not use it for any other product. Do not damage or alter the power cord. Damage and alteration may generate heat and eventually cause electric shock or a fire accident.

If the power cord is damaged or insulated wires are exposed, contact your local Fuji Xerox representative for its replacement. Do not use a damaged or uninsulated cord to avoid the risk of electric shock and a fire accident.

### **CAUTION**



When cleaning this product, always switch off and unplug it. Access to a live machine interior may cause electric shock.



Switch off and unplug the product when it (i.e., fax function) is not used over weekends or long holidays. Please note that it cannot receive fax message during switch-off.

# Before Using This Machine

---



- Once a month, switch off this product and check if
- the power cord is plugged firmly into an electrical outlet;
  - the plug is not excessively heated, rusted or bent;
  - the plug and electrical outlet are free of dust; and
  - the power cord is not cracked or worn down.

Once you notice any unusual condition, switch off and unplug this product first and contact your local Fuji Xerox representative.

## Machine Installation

---

### ⚠ WARNING



Do not locate this product where people might step on or trip over the power cord. Friction or excessive pressure may generate heat and eventually cause electric shock or a fire accident.

### ⚠ CAUTION



Never locate this product in the following places:

- Near radiators or any other heat sources
- Near volatile flammable materials such as curtains
- In the hot, humid, dusty or poorly ventilated environment
- In the place receiving direct sunlight
- Near cookers or humidifiers



This product weighs 37 kg. When moving it, always carry it by a team of three or more persons to avoid mishandling or injury.



When lifting this product, the first two persons to hold the bottom of the folded bypass tray on the left side of the product and the third person to hold the handhold provided on the right side of the product. Never lift it by gripping any other areas. It will prevent you from dropping the product and getting back ache or injuries.

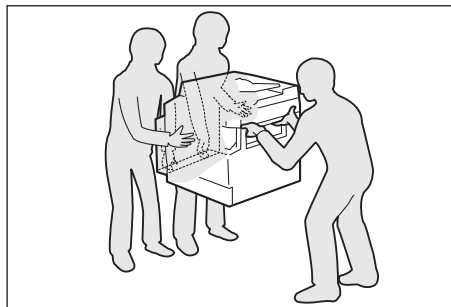

Locate this product on a level and sturdy surface that can withstand its weight. Otherwise, if tilted, the product may fall over and cause injuries.



Locate this product in a well-ventilated area. Do not obstruct ventilation openings of the product.

Keep the minimum clearance as follows for ventilation and an access to the power plug. Unplug the product if an abnormal condition is noted.

# Before Using This Machine

With Duplex Automatic Document Feeder

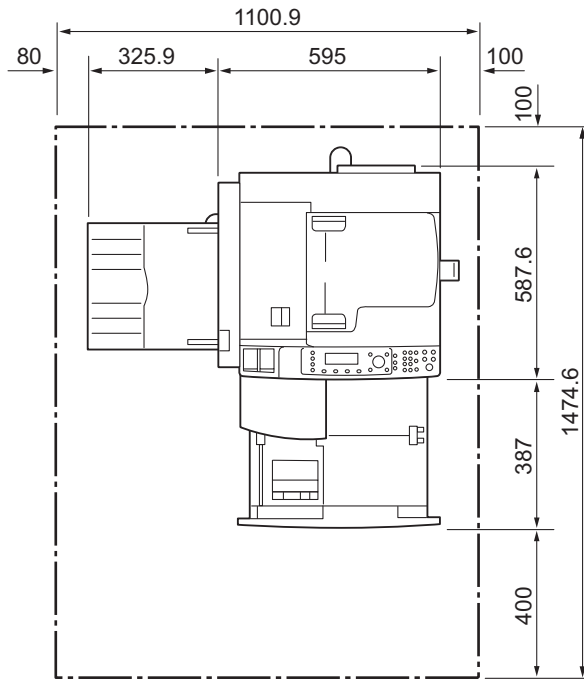

(Unit: mm)



Do not incline the product at more than 10 degree angle. Otherwise, it may fall over and cause injuries.

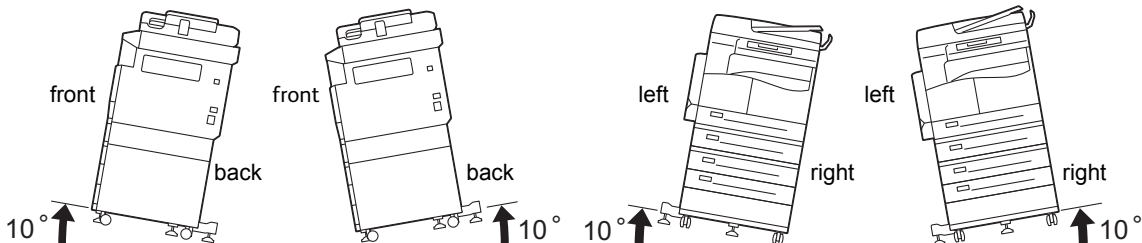

Always lock the wheels of this product after installation. Otherwise, it may fall over or slide and cause injuries.

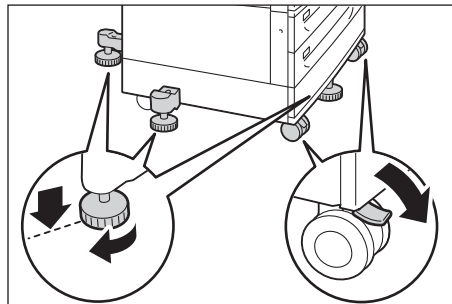

To bundle wires and cables, always use the cable ties and spiral tubes that Fuji Xerox supplies. Otherwise, it may cause some defects.

# Before Using This Machine

---

## Others



To keep this product in a good performance and condition, always use it in the following environment:

Temperature: 10 - 32°C

Humidity: 35 - 85 %

When the product is left in a chilly room and the room is rapidly warmed up by heater, dew condensation may form inside the product and cause a partial deletion on printing.

## Operational Safety

---

### WARNING



The operator's product maintenance procedures are described in the customer documentation supplied with this product. Do not carry out any other maintenance procedures not described in the documentation.



This product features safety design not to allow operators access to hazard areas. The hazard areas are isolated from operators by covers or protectors which require a tool to remove. To prevent electric shock and injuries, never remove those covers and protectors.



To avoid the risk of electric shock and a fire accident, switch off and unplug the product promptly in the following conditions, then contact your local Fuji Xerox representative.

- The product emits smoke or its surface is unusually hot.
- The product emits unusual noise or odor.
- The power cord is cracked or worn down.
- A circuit breaker, fuse or any other safety device becomes activated.
- Any liquid is spilled into the product.
- The product is soaked in water.
- Any part of the product is damaged.



Do not insert any object into slots or openings of this product. Do not put any of the followings on the product:

- Liquid container such as flower vases or coffee cups
- Metal parts such as staples or clips
- Heavy objects

If liquid is spilled over or metal parts are slipped into the product, it may cause electric shock or a fire accident.



Do not use conductive paper such as origami paper, carbonic paper or conductively-coated paper. When paper jam occurs, it may cause short-circuit and eventually a fire accident.



When cleaning this product, use the designated cleaning materials exclusive to it. Other cleaning materials may result in poor performance of the product. Never use aerosol cleaners to avoid catching fire and explosion.



If you need to pull out a tray to remove paper jam, contact your local Fuji Xerox representative. Do not pull out a tray, otherwise it may cause injuries.



Never play the CD-ROM supplied with the product on an audio player. Always use a CD-ROM player. Otherwise, large sound may damage audio players or your ears.



## Laser Safety

**CAUTION:** Any operations or adjustments not stated in the operation manual may cause hazardous light exposure and eventually burn injuries or loss of eyesight.

This product has been tested and found to comply with the Class 1 Laser Equipment requirements defined by the international standard IEC60825 and has no light exposure hazard. The product has no hazardous light emission as it features light protection components and covers to shut in all light beam during operation and maintenance.

## CAUTION



Keep electrical and mechanical safety interlocks active. Keep the safety interlocks away from magnetic materials. Magnetic materials may accidentally activate the product and cause injuries or electric shock.



Do not attempt to remove a paper deeply jammed inside the product, particularly a paper wrapped around the fusing unit or the heat roller. Otherwise, it may cause injuries or burns. Switch off the product immediately and contact your local Fuji Xerox representative.



Do not apply excessive force to hold thick document on the document glass. It may break the glass and cause injuries.



Ventilate well during extended operation or mass copying. It may affect the office air environment due to odor such as ozone in a poorly ventilated room. Provide proper ventilation to ensure the comfortable and safe environment.

## Consumable

---

### WARNING



Store all consumables in accordance with the instructions given on its package or container.



Never use a vacuum cleaner for spilled toner and residual toner in this product, toner cartridge or toner bottle. It may catch fire by electric sparks inside a vacuum cleaner and cause explosion. Use a broom or a wet cloth to wipe off spill. If you spill a large volume of toner, contact your local Fuji Xerox representative.



Never throw a toner cartridge into an open flame. Remaining toner in the cartridge may catch fire and cause burn injuries or explosion. If you have a used toner cartridge no longer needed, contact your local Fuji Xerox representative for its disposal.



**CAUTION: RISK OF EXPLOSION IF BATTERY IS REPLACED BY AN INCORRECT TYPE. DISPOSE OF USED BATTERIES ACCORDING TO THE INSTRUCTIONS.**

### CAUTION



Keep drum cartridges and toner cartridges out of the reach of children. If a child accidentally swallows toner, spit it out, rinse mouth with water, drink water and consult a physician immediately.

# Before Using This Machine

- 

When replacing drum cartridges and toner cartridges, be careful not to spill the toner. In case of any toner spills, avoid contact with clothes, skin, eyes and mouth as well as inhalation.
- 

If toner spills onto your skin or clothing, wash it off with soap and water.

If you get toner particles in the eyes, wash it out with plenty of water for at least 15 minutes until irritation is gone. Consult a physician if necessary.

If you inhale toner particles, move to a fresh air location and rinse your mouth with water.

If you swallow toner, spit it out, rinse your mouth with water, drink plenty of water and consult a physician immediately.
- 

**Fusing Unit Safety**

When removing the fusing unit, always switch off first and wait for 40 minutes until it cools off.

## Location of Warning and Caution Labels

- 

Always follow all warning instructions marked on or supplied with this product.

To avoid the risk of burn injuries and electric shock, never touch the area with the "High Temperature" or "High Voltage" marks on.

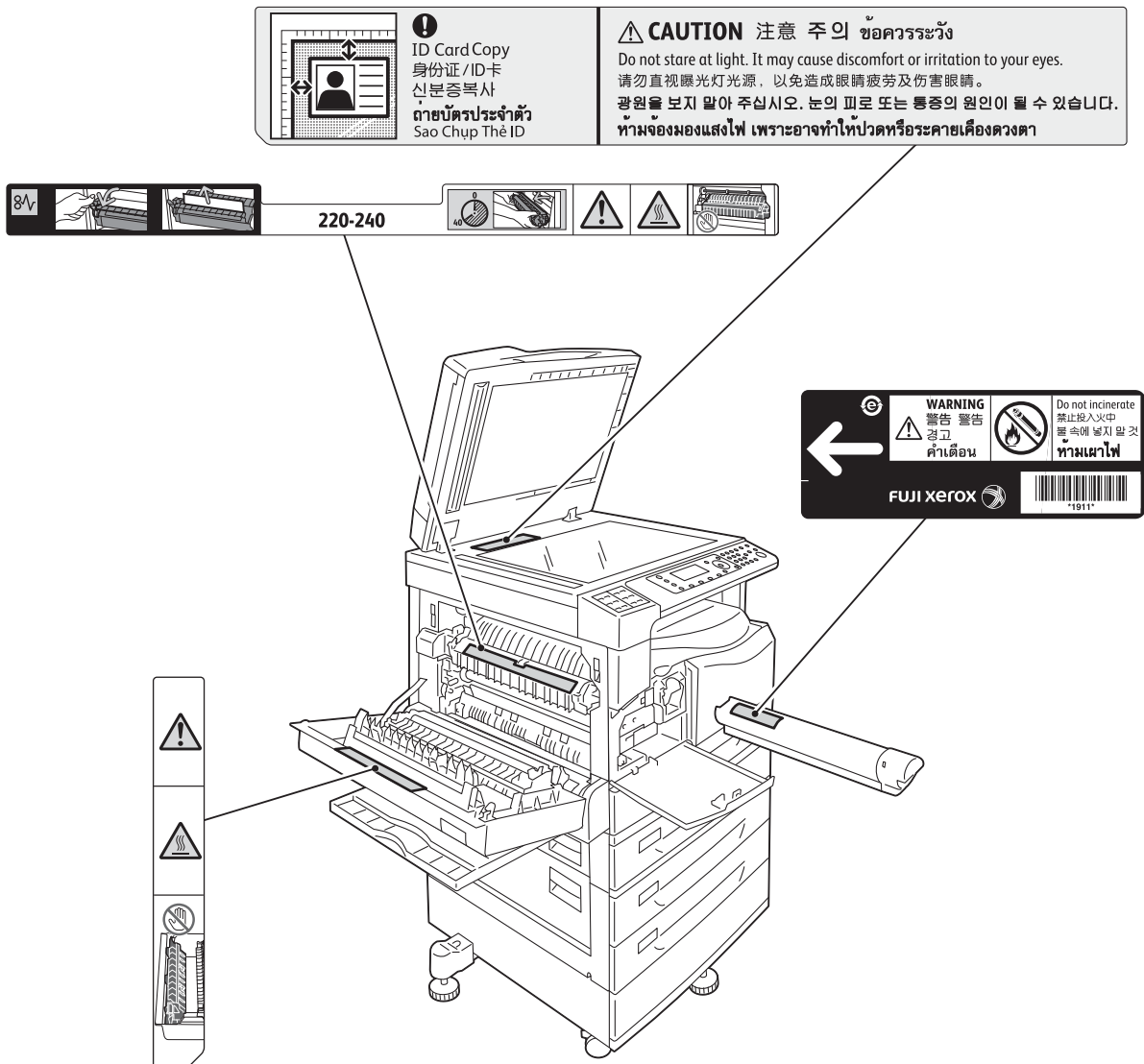



## Regulations

---

### Radio Frequency Emissions (Class A)

---

This product has been tested and found to comply with the limits for a class A digital device, pursuant to International Standard for Electromagnetic Interference (CISPR Publ. 22) and Radiocommunication Act 1992 in Australia/New Zealand. These limits are designed to provide reasonable protection against harmful interference when the product is operated in a commercial environment. This product generates, uses, and can radiate radio frequency energy and, if not installed and used in accordance with the customer documentation, may cause harmful interference to radio communications. Operation of this product in a residential area is likely to cause harmful interference in which case the user is required to correct the interference at their own expense.

Changes and modifications to this product not specifically approved by Fuji Xerox may void the user's authority to operate this equipment.

### Product Safety Certification (UL, CB)

---

This product is certified by the following agency using the safety standards listed.

<u>Agency</u>	<u>Standard</u>
TUV	IEC60950-1:ed. 2

## Environment

---

For environmental protection and efficient use of resources, Fuji Xerox reuses returned toner cartridges and drum cartridges to make recycle parts, recycle materials or energy recovery.

Proper disposal is required for toner cartridge and drum cartridge no longer needed. Do not open toner cartridge and drum cartridge. Return them to your local Fuji Xerox representative.

## Legal Notice

---

Copying or printing certain documents may be illegal in your country. Penalties of fines or imprisonment may be imposed on those found guilty. The following are examples of items that may be illegal to copy or print in your country.

- Currency
- Banknotes and checks
- Bank and government bonds and securities
- Passports and identification cards
- Copyright material or trademarks without the consent of the owner
- Postage stamps and other negotiable instruments

This list is not inclusive and no liability is assumed for either its completeness or accuracy. In case of doubt, contact your legal counsel.

## Paper Types

---

### Supported Paper Weights and Sheet Counts

Paper Trays	Basis Weight/Ream Weight	Loadable Quantity	Paper Type
Tray 1 (Standard)	60 to 90 gsm Ream weight: 51.6 to 77.4 kg	250 sheets * <sup>1</sup> (Up to 27 mm)	Lightweight (60 - 63 gsm) Plain 1 (64 - 79 gsm) Plain 2 (80 - 90 gsm)
Tray 2 (One Tray Module (Optional)) Tray 3, 4 (Two Tray Module (Optional))	60 to 216 gsm Ream weight: 51.6 to 186 kg	500 sheets * <sup>1</sup> (Up to 54 mm)	Lightweight (60 - 63 gsm) Plain 1 (64 - 79 gsm) Plain 2 (80 - 90 gsm) Heavyweight (91 - 169 gsm) Extra-HW (170 - 216 gsm)
Tray 5 (Bypass)	60 to 216 gsm Ream weight: 51.6 to 186 kg	100 sheets * <sup>2</sup> (Up to 10 mm)	

\*<sup>1</sup> When using 80 gsm paper

\*<sup>2</sup> When using Fuji Xerox standard paper

### Unusable Paper

- Damp or wet paper
- Paper pre-printed with other printer or copying machine
- Wrinkled, creased, or ripped paper
- Envelopes that are not flat, or that have clasps
- Color paper with surface treatments
- Paper with rough surface, such as pulp paper or fibrous paper
- Punched paper
- Transparency paper

# Loading Paper

## Loading Paper in Trays 1 to 4 and 5

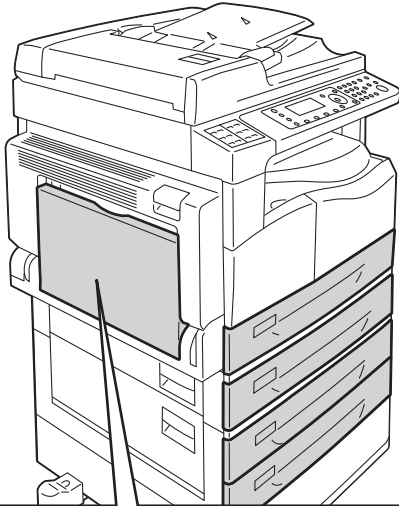

**Trays 1 to 4**

\* Only Tray 1

**Tray 5 (bypass)**

- Point** Load paper with the side to be copied or printed:
- For Trays 1 to 4: Face up
  - For Tray 5: Face down

# Preparations

## Changing the Paper Setting

**1** Enter the System Administration mode.

Press and hold the <Log In/Out> button for more than four seconds, and enter the passcode.

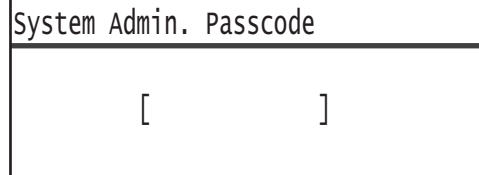
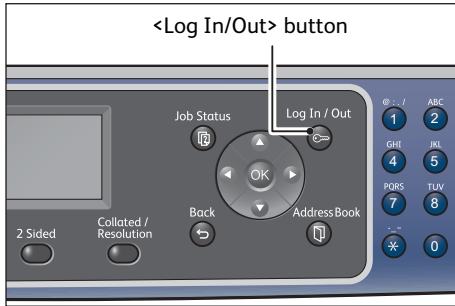

Use the numeric keypad to enter the passcode. The passcode is initially set to "11111" (five "1" digits).

**2** Select [Tray Settings], then press the <OK> button.

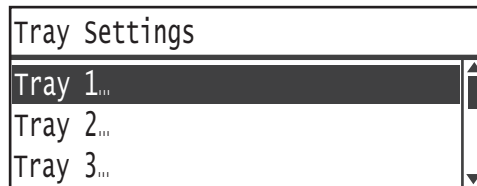

Tray 1 to 4	Tray 5*	
Paper Type	Paper Size	Paper Type
Tray 1 Paper Type... Plain1	Tray 5 Paper Size... A3☐ Paper Type... Plain1	Tray 5 Paper Size... A3☐ Paper Type... Plain1
▼	▼	▼
Paper Type Plain1 Plain2 Lightweight	Paper Size A3☐ (297x420mm) A4☐ (297x210mm) A4☐ (210x297mm)	Paper Type Plain1 Plain2 Lightweight

\* When you load non-standard size paper in the Tray 5, select [Paper Size] > [Custom Size], and then set the size in the X (width) direction between 98 and 432 mm and in the Y (length) direction between 127 and 297 mm.

# Placing Document

## Placing the document in the document feeder

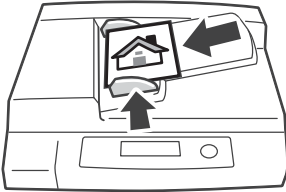

\* Only the standard sizes are supported.

\* Place document face up in the center of the document feeder by adjusting the document guides to each side of the document.

\* When using 2-sided document, make sure to properly set [Original - Binding Position] when copying and [2 Sided] when scanning.

Upright position (top edge of the document)

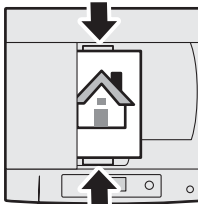
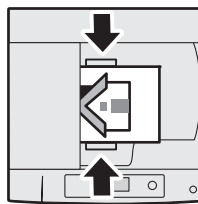

When the side of document to be fed is too large, place the short edge of the document to be fed first.

**Point** You cannot use the following documents using the document feeder. Use the document glass.



Mixed size



Lightweight  
(2 sided)



smaller than A5



Cut-and-pasted



Folded, wrinkled,  
curled\*



Carbon-backed

\* If you can flatten the curled document, you can use the document.

## Placing the document on the document glass

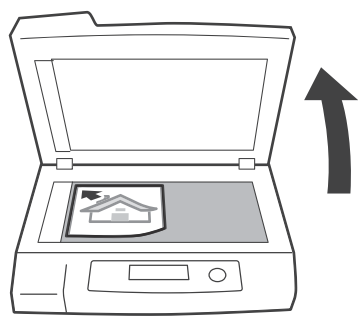

Place document face down slightly away from the top left corner of the document glass.

Upright position (top edge of the document)

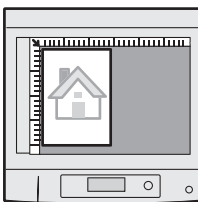
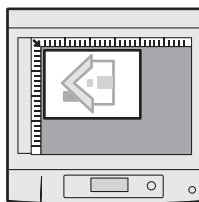

When document does not fit on the document glass, rotate the document.

# Preparations

---

## Placing the non-standard size document

When placing a non-standard size document, specify the document size in [Original Size] from the menu items.

Sample screens:

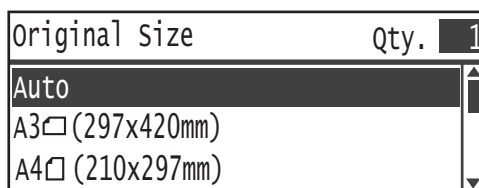
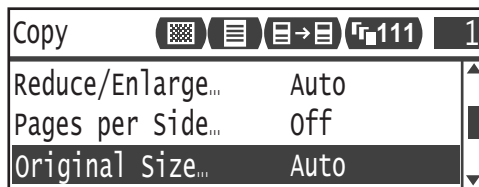

**Point** When [Original Size] is set to [Auto]:

An error screen appears when you place a non-standard size document on the document glass. In this case, select the document size manually by selecting [Original Size] from the menu items.

Depending on the selected document size, the printout may be too large for the paper or may have shadow at the edges.

# How to Copy

## Basic Copy Procedure (100% zoom ratio)

- 1 Place document.  
Refer to "Placing Document" (P.21).

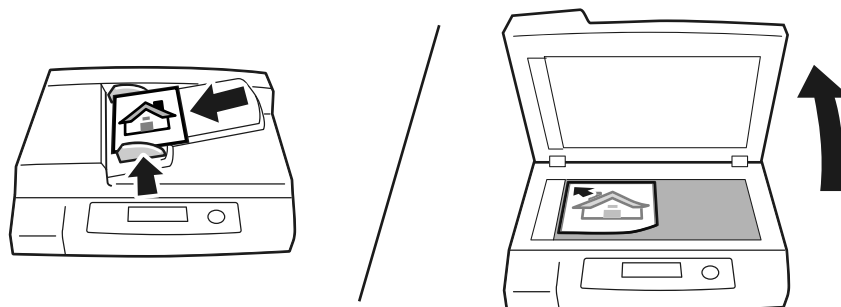

- 2 Press the <Copy> button.

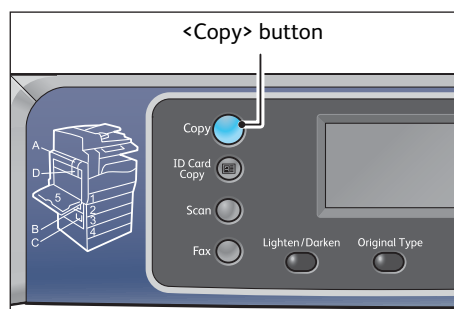

- 3 Make advanced settings as needed.

**Point** You can change the [Lighten/Darken], [Original Type], [2 Sided], and [Collated] settings by pressing the buttons. Refer to "About Quick-Buttons" (P.2).

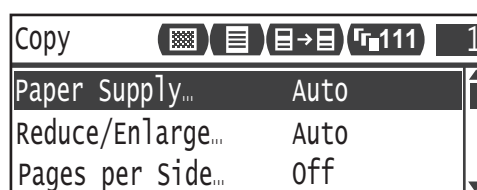

- 4 Press the <Start> button.

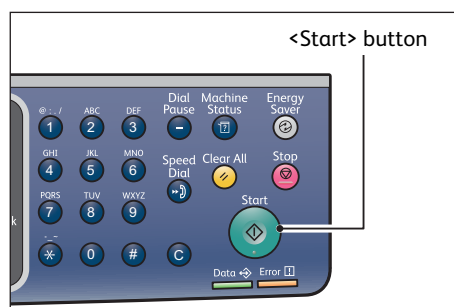

# Copying an ID Card

This function allows you to copy both sides of an ID card (name card, employee card, etc.) on one side of paper.

The default zoom ratio is set to 100%. You can also change the zoom ratio.

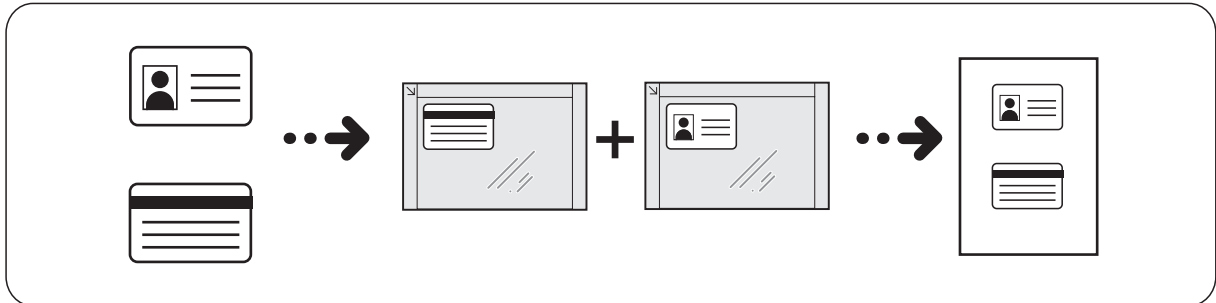

**1** Place an ID card face down at least 5mm away from the top left corner of the document glass, and then close the document cover.



- Placing the ID card too close to the corner of the document glass may not copy the edge of the ID card properly.
- Place an ID card in the upright position.

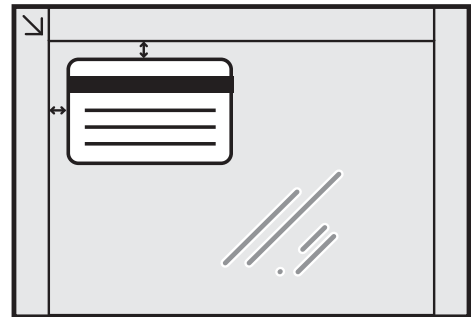

\*\*\*\*\*

**2** Press the <ID Card Copy> button.



- Make advanced settings as needed.

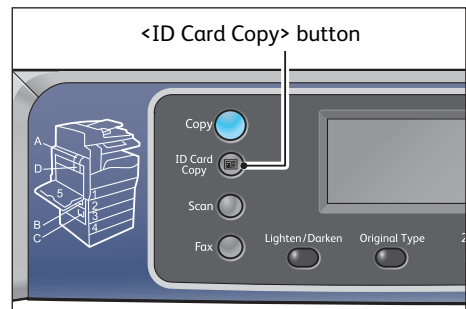

\*\*\*\*\*

**3** Press the <Start> button.

To finish scanning to print only one side of the ID card, select [Cancel], and then press the <OK> button.

\*\*\*\*\*

**4** To continue scanning the other side of the ID card, place the other side of the ID card face down slightly away from the top left corner of the document glass, and then close the document cover.

\*\*\*\*\*

**5** Select [Continue], and then press the <OK> button to start printing the scanned two sides of the ID card.



# Making 2 Sided Copies

This function allows you to copy 1 Sided or 2 Sided document on one side or both sides of paper.

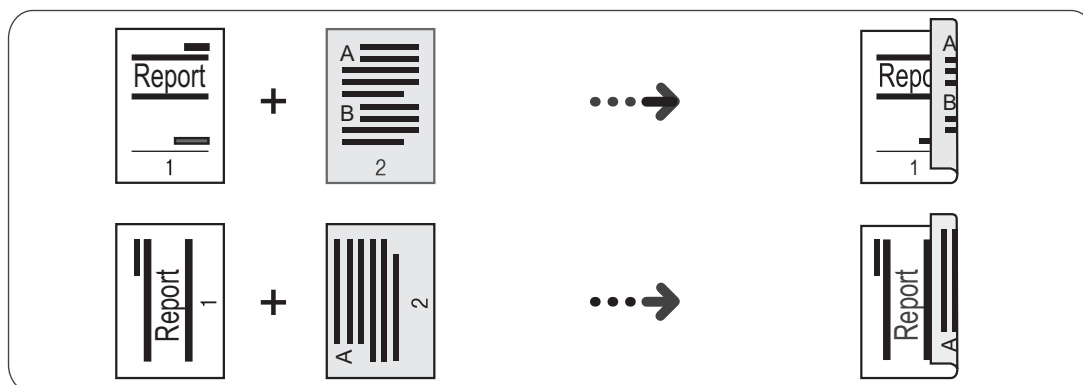

## 1 Place document.

Refer to "Placing Document" (P.21).

## 2 Press the <Copy> button.

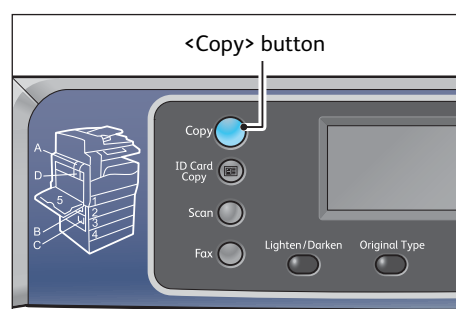

## 3 Press the <2 Sided> button.

**Point** You can change the displayed time length of the setting screen. For more information on changing the displayed time length of the setting screen, refer to the User Guide.

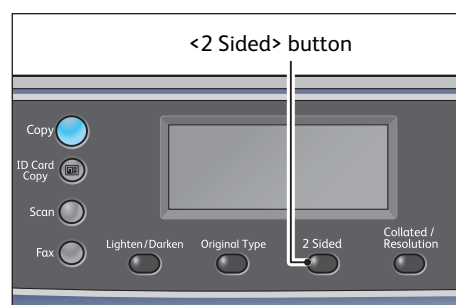

## 4 The selected copy method changes everytime the <2 Sided> button is pressed. The selection is applied when the screen is returned to the main menu screen without pressing the <OK> button.

**Point** You cannot select [2 -> 1 Sided] or [2 -> 2 Sided] when document is sitting on the document glass. Place document in the document feeder.

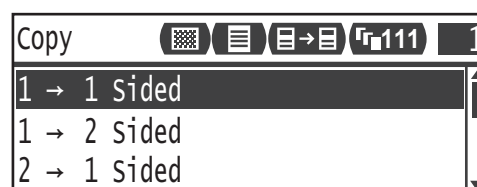

## 5 Press the <Start> button.

# Collating Output

This function allows you to output sheets sorted into sets that are arranged in page order for copying multiple pages of a document.



**1** Place document.  
Refer to "Placing Document" (P.21).

**2** Press the <Copy> button.

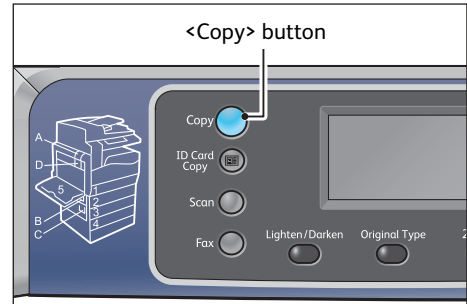

**3** Press the <Collated/Resolution> button.



You can change the displayed time length of the setting screen. For more information on changing the displayed time length of the setting screen, refer to the User Guide.

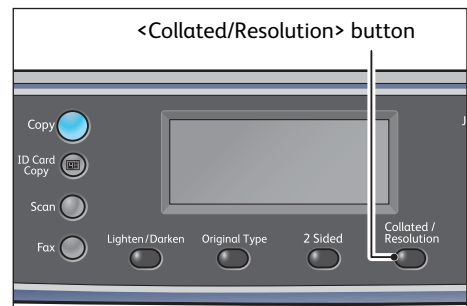

**4** The selected output method changes everytime the <Collated/Resolution> button is pressed. The selection is applied when the screen is returned to the main menu screen without pressing the <OK> button.



Selecting [On (Rotate)] will output sheets sorted into sets that are arranged in page order by alternating between landscape and portrait orientations.

**5** Press the <Start> button.

# Making Reduced or Enlarged Copies

This function allows you to select a zoom ratio to reduce or enlarge the size of copies.



**1** Place document.

Refer to "Placing Document" (P.21).

**2** Press the <Copy> button.

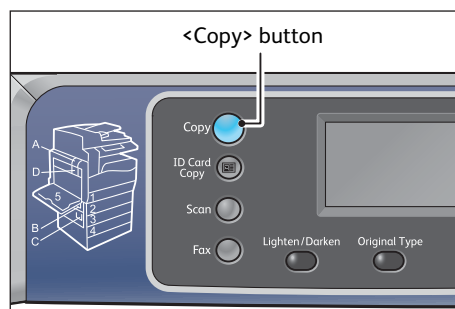

**3** Select [Reduce/Enlarge], and then press the <OK> button.

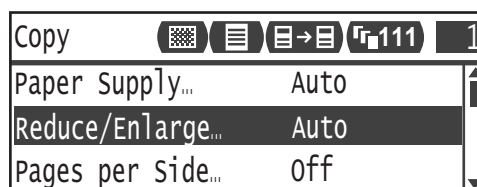

**Point** You can select one of the preset zoom ratio or use the numeric keypad or < ◀ ▶ > and < ▶ ▶ > buttons to set the desired reduction/enlargement zoom ratio.

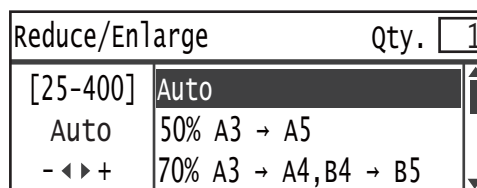

**4** Press the <Start> button.

# Copying Two/Four Pages onto One Sheet

This function allows you to copy two or four pages of a document together onto one side of a single sheet of paper.

The machine automatically sets the zoom ratio to fit on a page.

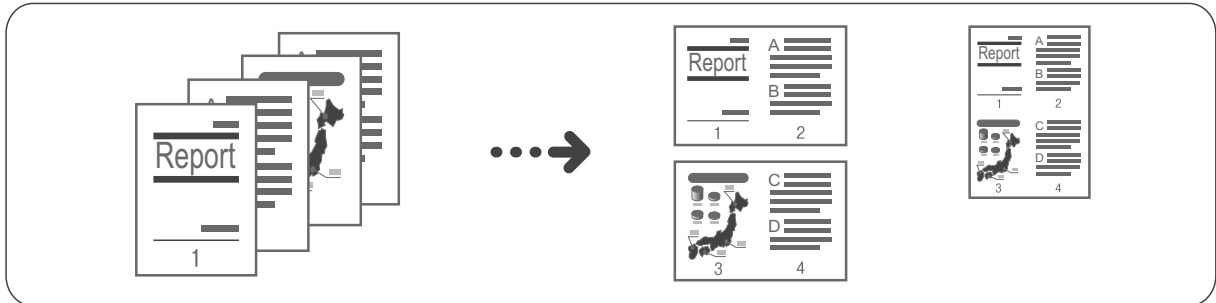

- Place document in upright position.
- Point** •When using 2-sided document placed in the document feeder, make sure to set [Original - Binding Position] properly.

## 1 Place document.

Refer to "Placing Document" (P.21).

## 2 Press the <Copy> button.

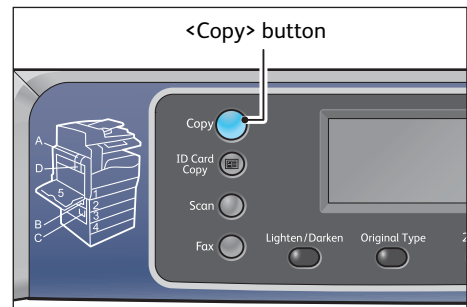

## 3 Select [Pages per Side], and then press the <OK> button.

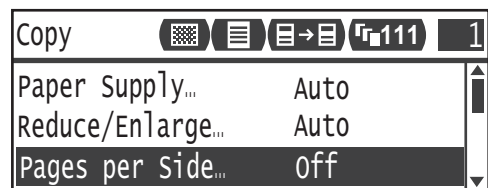

## 4 Select the number of document pages to be printed in one side of paper, and then press the <OK> button.

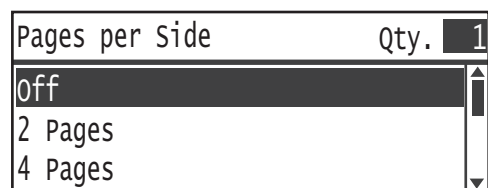

## 5 Press the <Start> button.

# How to Print

This section describes the basic printing procedure and how to cancel the currently printing job.



Before using this feature, the print driver included in the Driver CD Kit CD-ROM must be installed to the computer. For the instruction, click the "CD-ROM Documentation (HTML)" on the [Documentation] tab in the Driver CD Kit .

**1** Select [Print] from the application's [File] menu.

\*\*\*\*\*

**2** Select [FX DocuCentre XXXXX].

XXXXX: "S2420" or "S2220"

\*\*\*\*\*

**3** Make advanced settings by clicking [Properties] if needed.

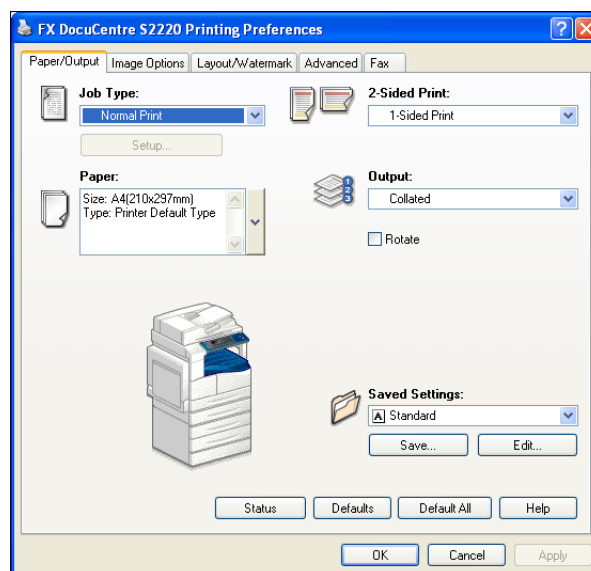

\*\*\*\*\*

**4** Click [OK].

\*\*\*\*\*

**5** Click [OK] in the [Print] dialog box.

## How to stop printing

Double-click the printer icon  appeared on the task bar in the lower right corner of the screen.

Select the document name that you desire to cancel, and then press the <Delete> key.

If there is no document within the window, cancel it manually on the machine.

# Importing Scanned Data via Application

This function allows you to load scan data via a TWAIN-compatible application or a Windows® Imaging Acquisition (WIA)-compatible application installed on the computer. You can specify the document load conditions while checking the preview of the scan results displayed on the PC screen.



- Before using this function, the scan driver included in the Driver CD Kit CD-ROM must be installed to the computer.
- This function is available using the USB connection. Scanning using a network is not supported.

## 1 Place document.

Refer to "Placing Document" (P.21).

\*\*\*\*\*

## 2 Start an application to scan the document.

\*\*\*\*\*

## 3 Select the menu item for selecting a scanner (source).

\*\*\*\*\*

## 4 Select [DocuCentre S2420/S2220].

\*\*\*\*\*

## 5 Make advanced settings if needed.

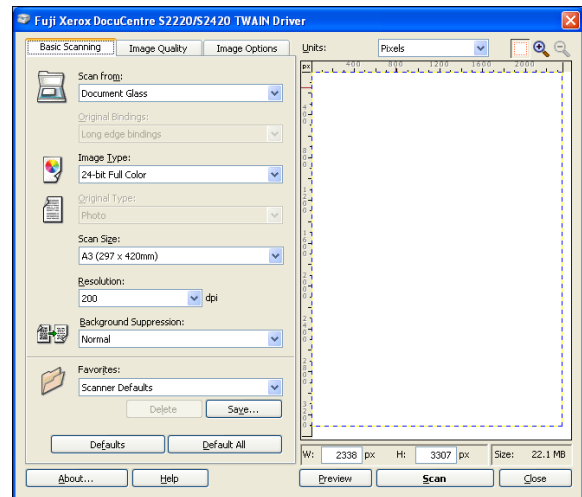

\*\*\*\*\*

## 6 Click [Scan].

# Sending Scanned Data via E-mail

This function allows you to send scanned data via e-mail. You can send the monochrome scanned data in PDF or TIFF or the color scanned data in PDF or JPEG attached to an e-mail. The SMTP protocol is used for the e-mail transmission.

Point

- You can select an e-mail address only from the Address Book. Register the e-mail addresses using CentreWare Internet Services in advance. For more information, refer to the User Guide included in the Driver CD Kit CD-ROM.
- When using 2-sided document placed in the document feeder, make sure to set [Original -Binding Position] properly. If it is not specified and the orientation of the scanned data needs to be changed, rotate it on your computer.

## 1 Place document.

Refer to "Placing Document" (P.21).

## 2 Press the <Scan> button, and specify the registered recipient by pressing the <Address Book> button.

Point

You can also enter a two-digit number of registered recipient using the numeric keypad, and then go to step 4.

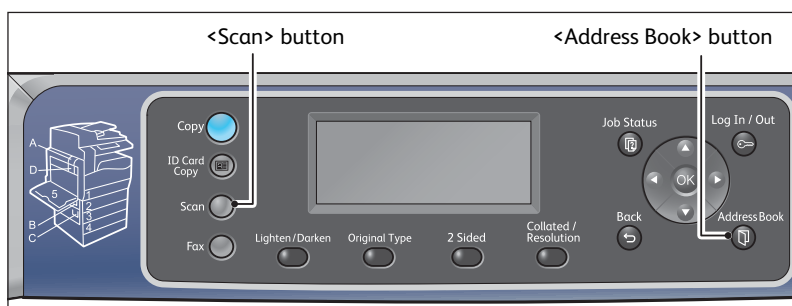

## 3 Select the desired recipient, and then press the <OK> button.

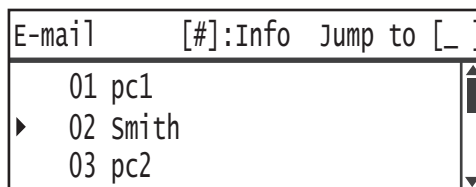

## 4 Make advanced settings as needed.

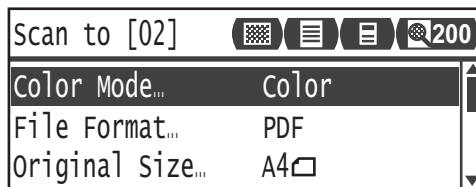

## 5 Press the <Start> button.

# Sending Scanned Data to PC (Network)

This function allows you to send scanned data to a network-based computer. You can send the monochrome scanned data in PDF or TIFF or the color scanned data in PDF or JPEG to the specified PC. The SMB protocol is used for the data transmission.



- You can select a PC address only from the Address Book. Register the PC addresses using CentreWare Internet Services in advance. For more information, refer to the User Guide included in the Driver CD Kit CD-ROM.
- When using 2-sided document placed in the document feeder, make sure to set [Original -Binding Position] properly. If it is not specified and the orientation of the scanned data needs to be changed, rotate it on your computer.

## 1

Place document.

Refer to "Placing Document" (P.21).

## 2

Press the <Scan> button. Specify the registered PC by pressing the <Address Book> button.



You can also enter a two-digit number of the registered PC using the numeric keypad, and then go to step 4.

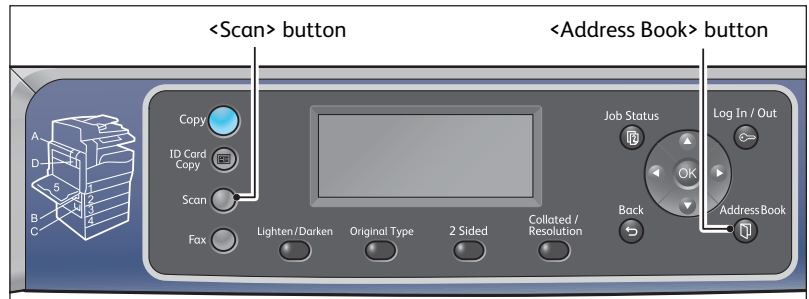

## 3

Select the desired address of PC, and then press the <OK> button.

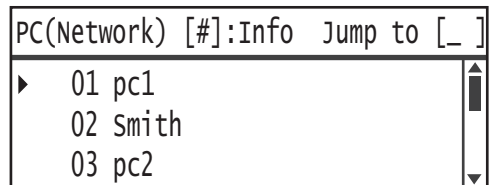

## 4

Make advanced settings as needed.

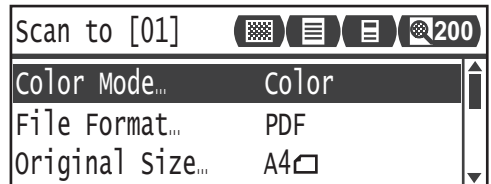

## 5

Press the <Start> button.



# How to Fax

## Using the Address Book

You can select a recipient from the Phone Book entries that you have registered.

## Using the Speed Dial

You can select a recipient by entering a Speed Dial number directly on the Speed Dial input screen.

- 1 Place document.  
Refer to "Placing Document" (P.21).

- 2 Press the <Fax> button.

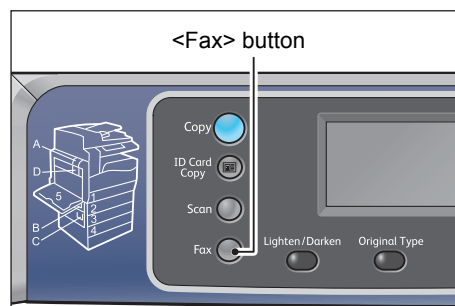

- 3 Specify a recipient.

Press the <Address Book> button.

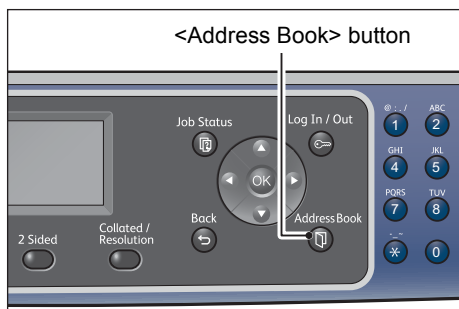

Select [All Entries], then press the <OK> button.

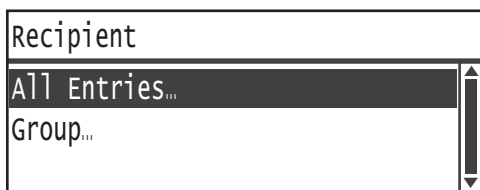

**Point** Select [Group] when specifying the multiple recipients.

Press the <Speed Dial> button.

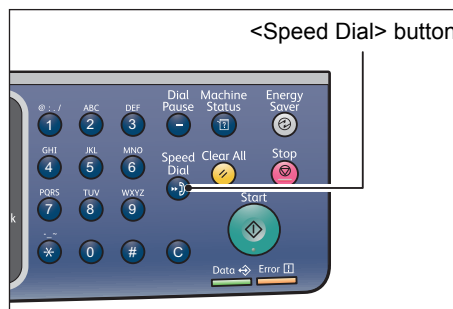

Use the numeric keypad to enter the desired Speed Dial number.

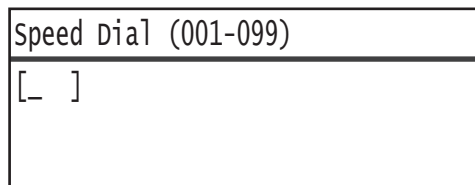

- 4 Press the <Start> button.

## Entering the Fax Number

You can specify a recipient by pressing the recipient's fax number using the numeric keypad.

### 1 Place document.

Refer to "Placing Document" (P.21).

### 2 Press the <Fax> button.

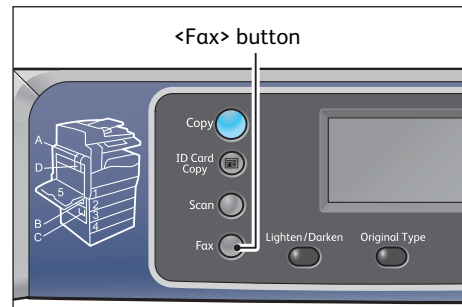

### 3 Specify a recipient.

Use the numeric keypad.

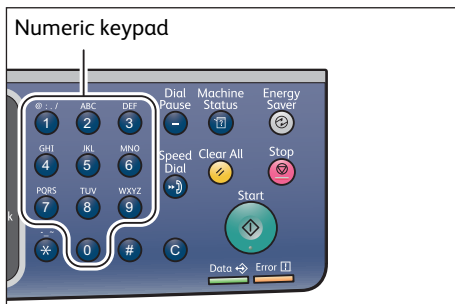

Press a One Touch Button.

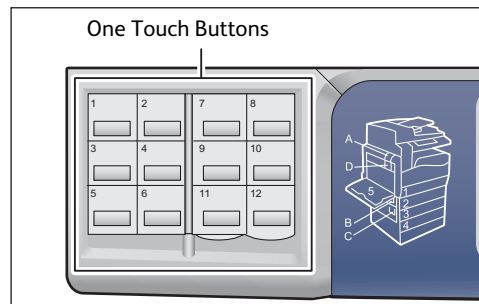

ex.) Pressing the <1> One Touch Button will select the 001 recipient registered for Speed Dial.

### 4 Press the <Start> button.



- To use the <Address Book> button, the <Speed Dial> button, and the One Touch Buttons, the recipients' fax numbers must be registered in advance.
- This machine does not support broadcast transmission.
- To specify multiple recipients, register the recipients' fax numbers as a group in the Phone Book beforehand.

# Registering Phone Book

This section describes how to register a fax recipient to the Phone Book. You can register up to 99 Speed Dial entries. You can register up to 99 Speed Dial entries in each group.

**Point** The recipients registered on the Speed Dial numbers 001 to 036 correspond to the one touch buttons 1 to 36. Pressing a one touch button is a handy way to quickly specify a fax recipient.

## 1 Enter the System Administration mode.

Refer to "Enter the System Administration mode." (P.20).

\*\*\*\*\*

## 2 Select [Tools], and follow the steps below.

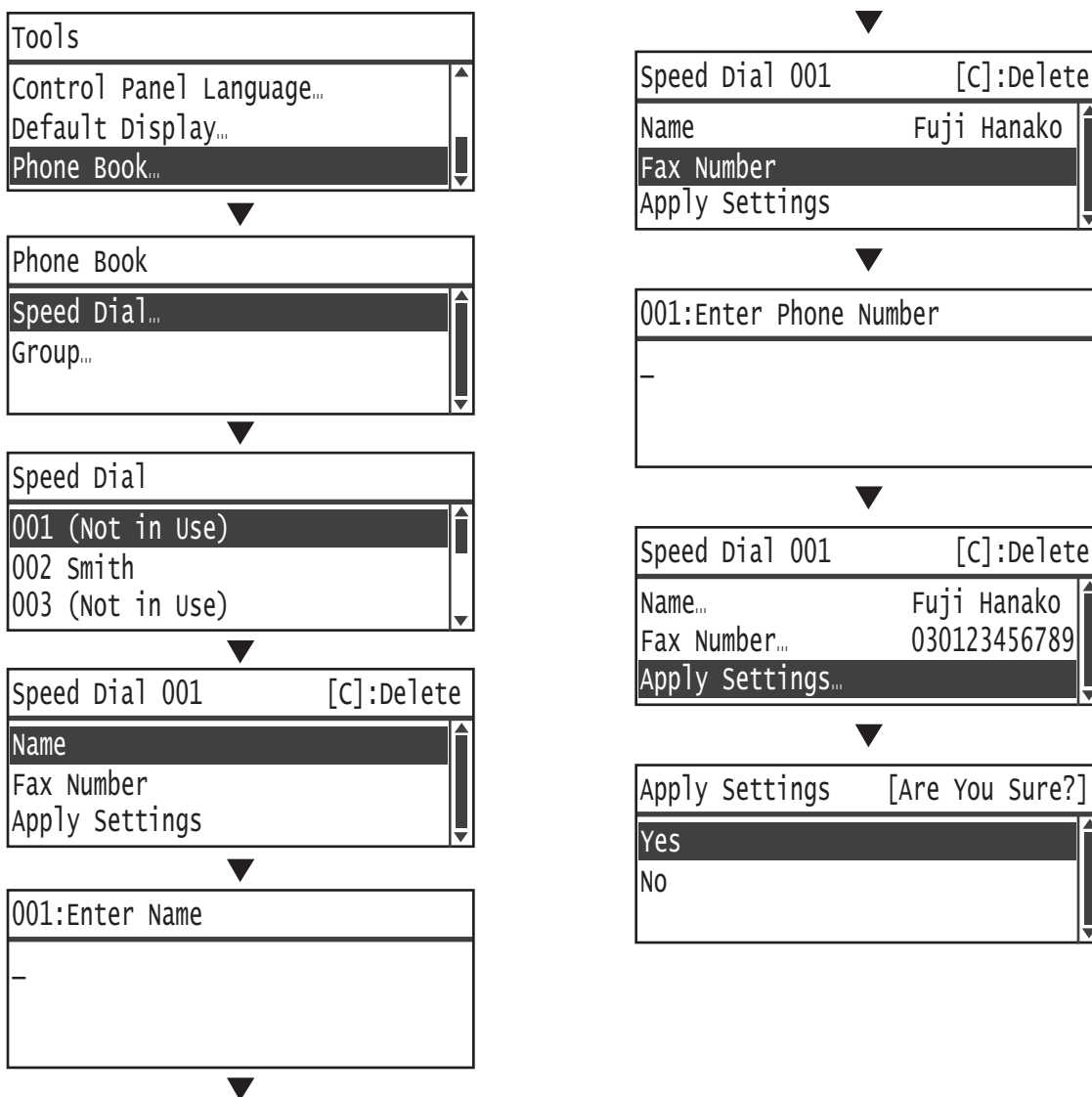

**Point** To exit System Administration mode, press the <Log In/Out> button.

# Paper Jams

---

When a paper jam occurred, the machine stops and an alarm beeps. An error code and a message will be displayed on the screen.

Error Code	Area to Check
<b>071-105</b>	1. Left cover [A] 2. Tray 1
<b>072-102</b>	1. One tray module cover [B] 2. Tray 2
<b>072-105</b>	One tray module cover [B]
<b>073-102</b>	1. Two tray module cover [C] 2. Tray 3
<b>073-104</b>	1. One tray module cover [B] 2. Two tray module cover [C]
<b>073-105</b>	One tray module cover [B]
<b>074-101</b> <b>074-102</b>	1. Two tray module cover [C] 2. Tray 4
<b>074-104</b>	1. One tray module cover [B] 2. Two tray module cover [C]
<b>074-105</b>	One tray module cover [B]
<b>075-135</b>	1. Left cover [A] 2. Tray 5
<b>077-101</b>	Left cover [A]
<b>077-103</b>	
<b>077-104</b>	
<b>077-106</b>	
<b>077-129</b>	
<b>077-900</b>	
<b>077-901</b>	
<b>077-904</b>	One tray module cover [B]
<b>077-905</b> <b>077-906</b>	1. One tray module cover [B] 2. Two tray module cover [C]

Left Cover [A]

- If the paper is jammed around the fusing unit:

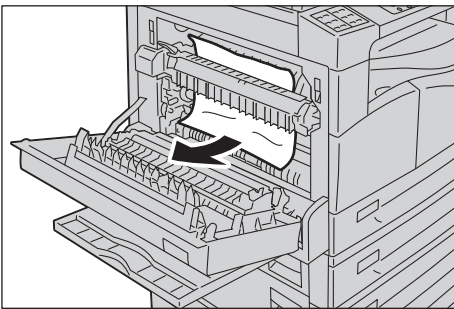
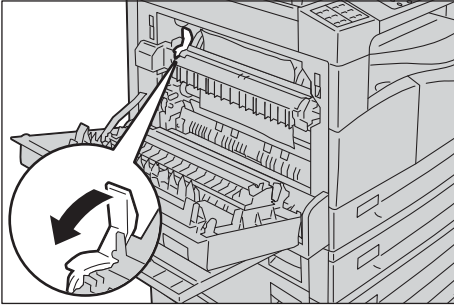

- If the paper is jammed within the left side cover:

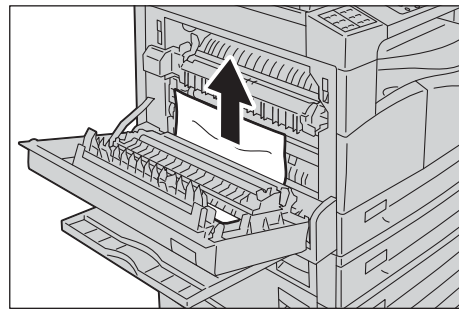
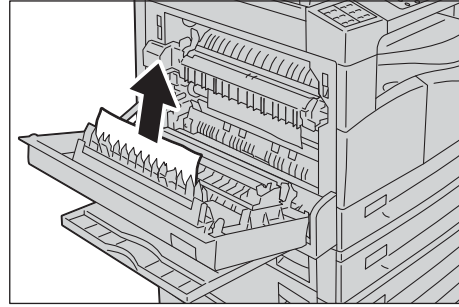

One Tray Module Cover [B]

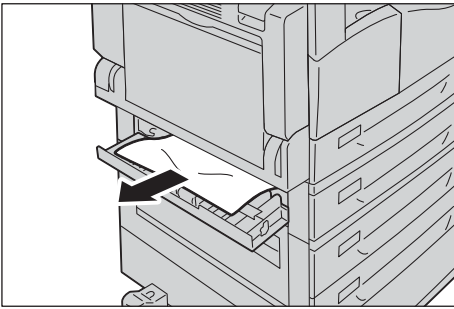

Two Tray Module Cover [C]

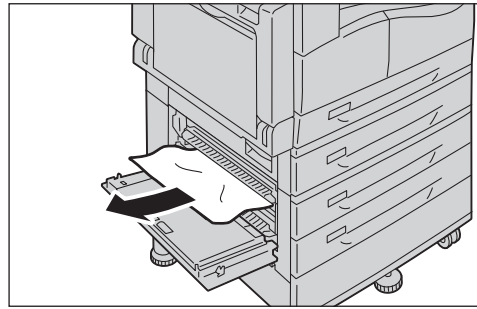

## Tray 1

- Operated after checking the left cover [A]:

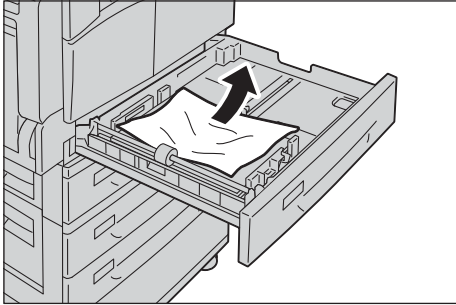

## Tray 2 to 4

- Operated after checking the one tray module cover [B]:

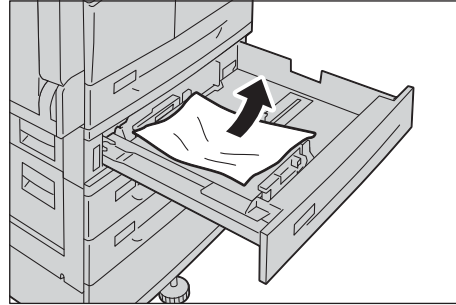

## Tray 5

- Operated after checking the left cover [A]:

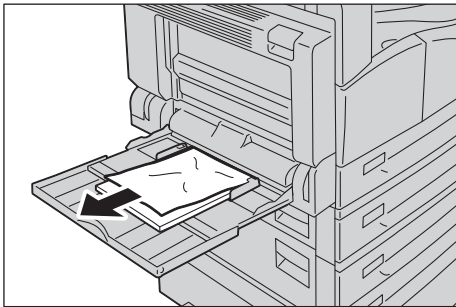

# Document Jams

When a document jam occurred in the document feeder, the machine stops and an alarm beeps. An error code and a message will be displayed on the screen.

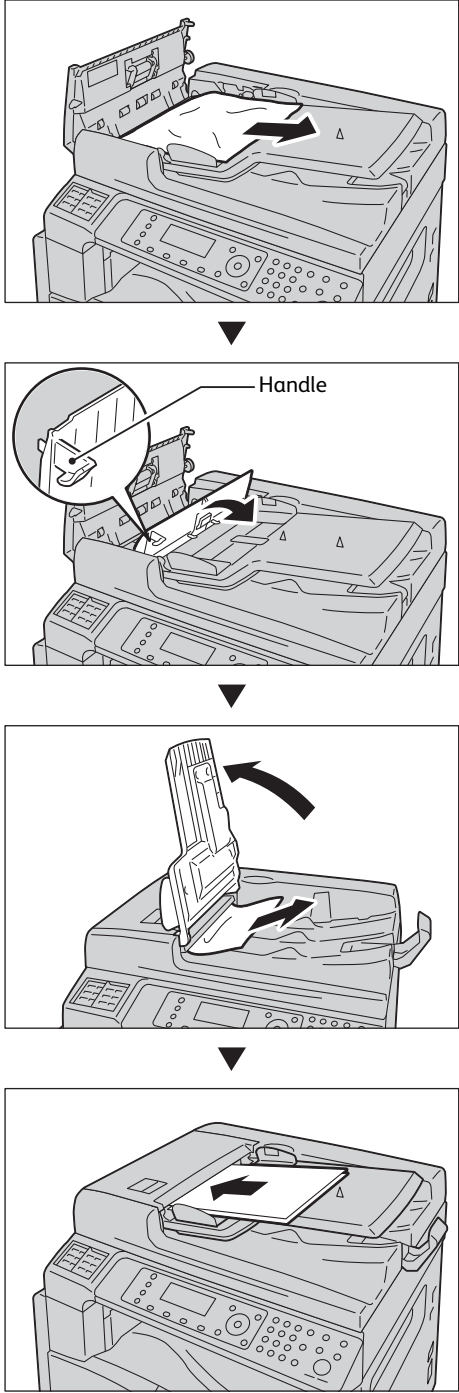
Error Code	Remedy
<p>005-122                      005-123                      005-125                      005-131                      005-132                      005-134                      005-135                      005-136                      005-139                      005-145                      005-147                      005-196                      005-197                      005-198                      005-199                      005-907                      005-908                      005-913</p>	 <p>The remedy section contains four sequential diagrams illustrating the process of clearing a document jam. The first diagram shows a document being fed into the machine. The second diagram shows a close-up of the document being pulled out, with a label 'Handle' pointing to a specific part of the feeder. The third diagram shows the document being pulled out further. The fourth diagram shows the document being fed back into the machine.</p>

## Error Code

An error code (xxx-xxx) and a message will be displayed if a printing is terminated abnormally because of an error, or a malfunction occurred in the machine.

Refer to the error codes in the following table to resolve problems.

Error Code	Cause and Remedy
<b>003-500</b>	Cause) When using the Pages per Side function, the printout doesn't fit in the paper with the specified reduction/enlargement factor. Remedy) Press the control panel's <Stop> button, and change the setting.
<b>003-754</b>	Cause) An IPS error occurred. Remedy) Press the control panel's <Stop> button, and cancel the job.
<b>003-795</b>	Cause) When enlarging/reducing a scanned document to the paper size specified, the reduction/enlargement ratio exceeds the allowed range. Remedy) Press the control panel's <Stop> button, and change the setting.
<b>003-942</b>	Cause) A document with a nonstandard size is set in the document feeder. Remedy) Press the control panel's <Stop> button, and check the document.
<b>003-963</b>	Cause) When [Auto] is set for [Paper Supply] for a copy job, the size of the scan document is larger than the paper size that can be copied. Remedy) Press the control panel's <Stop> button, and change the setting.
<b>003-972</b>	Cause) Exceeded the maximum pages that can be scanned during a copy/scan job. Remedy) Press the control panel's <Start> button to redo the operation or press the <Stop> button to cancel the operation.
<b>003-973</b>	Cause) The image size is too large when enlarging/reducing a scanned document that does not match the orientation of paper. Remedy) Take one of the following measures. * Reduce the magnification with [Reduce/Enlarge]. * Change the orientation of paper or document.
<b>004-345</b>	Cause) An error occurred. Remedy) Switch off the machine power, make sure that the display is blank, and then switch on the machine power. If the same message is displayed again, contact our Customer Support Center.
<b>005-122</b> <b>005-123</b> <b>005-125</b> <b>005-131</b> <b>005-132</b> <b>005-134</b> <b>005-135</b> <b>005-136</b> <b>005-139</b> <b>005-145</b> <b>005-147</b> <b>005-196</b> <b>005-197</b> <b>005-198</b> <b>005-199</b>	Cause) A document jam occurred in the document feeder. Remedy) Remove the jammed document.



<p><b>005-210</b> <b>005-275</b> <b>005-280</b></p>	<p>Cause) An error occurred in the document feeder. Remedy) Switch off the machine power, make sure that the display is blank, and then switch on the machine power. If the same message is displayed again, contact our Customer Support Center.</p>
<p><b>005-305</b></p>	<p>Cause) The document feeder's left cover is open. Remedy) Close the document feeder's left cover.</p>
<p><b>005-500</b></p>	<p>Cause) An error occurred in the document feeder. Remedy) Switch off the machine power, make sure that the display is blank, and then switch on the machine power.</p>
<p><b>005-907</b> <b>005-908</b> <b>005-913</b></p>	<p>Cause) A document jam occurred in the document feeder. Remedy) Remove the jammed document.</p>
<p><b>005-940</b></p>	<p>Cause) An error occurred in the document feeder. Remedy) Press the control panel's &lt;Stop&gt; button, and set the document on the document feeder again.</p>
<p><b>005-948</b></p>	<p>Cause) A document size mismatch error occurred in the document feeder. Remedy) Press the control panel's &lt;Stop&gt; button, and cancel the job.</p>
<p><b>007-270</b></p>	<p>Cause) Tray 1 malfunction. Remedy) Switch off the machine power, make sure that the display is blank, and then switch on the machine power. If the same message is displayed again, contact our Customer Support Center. You can use a tray other than Tray 1.</p>
<p><b>007-272</b></p>	<p>Cause) Tray 3 malfunction. Remedy) Switch off the machine power, make sure that the display is blank, and then switch on the machine power. If the same message is displayed again, contact our Customer Support Center. You can use a tray other than Tray 3.</p>
<p><b>007-273</b></p>	<p>Cause) Tray 4 malfunction. Remedy) Switch off the machine power, make sure that the display is blank, and then switch on the machine power. If the same message is displayed again, contact our Customer Support Center. You can use a tray other than Tray 4.</p>
<p><b>010-311</b> <b>010-312</b> <b>010-320</b> <b>010-327</b> <b>010-379</b> <b>010-392</b></p>	<p>Cause) An error occurred. Remedy) Switch off the machine power, make sure that the display is blank, and then switch on the machine power. If the same message is displayed again, contact our Customer Support Center.</p>
<p><b>010-602</b></p>	<p>Cause) Temperature sensor of the machine detected abnormality. Remedy) The machine will automatically recover when the machine cools down. Wait for a while, and try again.</p>
<p><b>016-346</b> <b>016-372</b></p>	<p>Cause) An error occurred. Remedy) Switch off the machine power, make sure that the display is blank, and then switch on the machine power. If the same message is displayed again, contact our Customer Support Center.</p>
<p><b>016-500</b> <b>016-501</b> <b>016-502</b> <b>016-504</b></p>	<p>Cause) An error occurred. Remedy) Switch off the machine power, make sure that the display is blank, and then switch on the machine power.</p>

## Problem Solving

---

<b>016-570</b>	Cause) A communication error occurred while printing. Remedy) Press the control panel's <Stop> button, and cancel the job.
<b>016-571</b>	Cause) A communication error occurred during print processing. Remedy) The machine will automatically recover. Wait a moment, and try again.
<b>016-598</b>	Cause) The size of an e-mail page exceeds the maximum message size because of page splitting. Remedy) Press the control panel's <Start> button to redo the operation, or press the <Stop> button to cancel the operation.
<b>016-742</b> <b>016-744</b>	Cause) An error occurred. Remedy) Switch off the machine power, make sure that the display is blank, and then switch on the machine power.
<b>016-749</b>	Cause) An error occurred. Remedy) Press the control panel's <Stop> button, and cancel the job.
<b>016-759</b>	Cause) A setting has been entered for the maximum number of permitted copies, and has been reached. Alternatively, a user who has reached their maximum number of copies logged in. Remedy) Press the control panel's <Stop> button, and cancel the job.
<b>016-764</b>	Cause) An error occurred on the network. Remedy) Press the control panel's <Stop> button and cancel the job.
<b>016-765</b> <b>016-766</b>	Cause) The SMTP server's memory area for incoming e-mail is full. Remedy) Press the control panel's <Stop> button, and cancel the job.
<b>016-767</b>	Cause) Unable to send the e-mail because the address is not correct. Remedy) Press the control panel's <Stop> button, and cancel the job.
<b>016-768</b>	Cause) E-mail data creation failed. Remedy) Press the control panel's <Stop> button, and cancel the job.
<b>016-776</b>	Cause) A job is canceled. Remedy) Press the control panel's <Stop> button, and cancel the job.
<b>016-781</b>	Cause) Unable to resolve the SMTP server name when sending e-mail. Remedy) Press the control panel's <Stop> button, and cancel the job.
<b>016-791</b>	Cause) The machine couldn't send data when executing the Scan to PC (Network) or Scan to E-mail function. Remedy) Press the control panel's <Stop> button, and cancel the job.
<b>016-799</b>	Cause) An invalid print parameter is included in the print data of the application, or the print data and the Print Setup settings may not match. Remedy) Press the control panel's <Stop> button, and cancel the job.
<b>016-981</b>	Cause) The EPC memory is full. Remedy) Press the control panel's <Start> button to redo the operation, or press the <Stop> button to cancel the operation.
<b>016-982</b>	Cause) The memory is full while scanning the first page with Scan to PC service. Remedy) Press the control panel's <Stop> button, and cancel the job.
<b>016-985</b>	Cause) The attachment size using the Scan to E-mail service exceeds the maximum size. Remedy) Press the control panel's <Start> button to redo the operation, or press the <Stop> button to cancel the operation.

<b>017-745</b>	<p>Cause) Exceeded the maximum storage size using SMB of the Scan to PC service.</p> <p>Remedy) Press the control panel's &lt;Start&gt; button to redo the operation, or press the &lt;Stop&gt; button to cancel the operation.</p>
<b>024-910</b>	<p>Cause) The paper size set for Tray 1 and the paper size specified for the job are not the same.</p> <p>Remedy) Press the control panel's &lt;Stop&gt; button to cancel the job or change the paper to the specified paper size.</p>
<b>024-911</b>	<p>Cause) The paper size set for Tray 2 and the paper size specified for the job are not the same.</p> <p>Remedy) Press the control panel's &lt;Stop&gt; button to cancel the job or change the paper to the specified paper size.</p>
<b>024-912</b>	<p>Cause) The paper size set for Tray 3 and the paper size specified for the job are not the same.</p> <p>Remedy) Press the control panel's &lt;Stop&gt; button to cancel the job or change the paper to the specified paper size.</p>
<b>024-913</b>	<p>Cause) The paper size set for Tray 4 and the paper size specified for the job are not the same.</p> <p>Remedy) Press the control panel's &lt;Stop&gt; button to cancel the job or change the paper to the specified paper size.</p>
<b>024-915</b>	<p>Cause) The paper size set for Tray 5 (bypass) and the paper size specified for the job are not the same.</p> <p>Remedy) Reload paper to match the paper setting or press the control panel's &lt;Stop&gt; button.</p>
<b>024-950</b>	<p>Cause) There is no paper in Tray 1 and another tray cannot be selected.</p> <p>Remedy) Load more paper, or press the control panel's &lt;Stop&gt; button to cancel the job.</p>
<b>024-951</b>	<p>Cause) There is no paper in Tray 2 and another tray cannot be selected.</p> <p>Remedy) Load more paper, or press the control panel's &lt;Stop&gt; button to cancel the job.</p>
<b>024-952</b>	<p>Cause) There is no paper in Tray 3 and another tray cannot be selected.</p> <p>Remedy) Load more paper, or press the control panel's &lt;Stop&gt; button to cancel the job.</p>
<b>024-953</b>	<p>Cause) There is no paper in Tray 4 and another tray cannot be selected.</p> <p>Remedy) Load more paper, or press the control panel's &lt;Stop&gt; button to cancel the job.</p>
<b>024-954</b>	<p>Cause) There is no paper in Tray 5 and another tray cannot be selected.</p> <p>Remedy) Load more paper, or press the control panel's &lt;Stop&gt; button to cancel the job.</p>
<b>024-958</b>	<p>Cause) The paper setting specified in the control panel does not match the size or type of paper loaded in the Tray 5 (bypass).</p> <p>Remedy) Reload paper to match the paper setting or press the control panel's &lt;Stop&gt; button.</p>
<b>024-959</b>	<p>Cause) Tray 1 has not been inserted or the paper guides are in an unsupported position.</p> <p>Remedy) Press the control panel's &lt;Stop&gt; button and insert Tray 1, or check the position of the paper guides.</p>
<b>024-960</b>	<p>Cause) Tray 2 has not been inserted or the paper guides are in an unsupported position.</p> <p>Remedy) Press the control panel's &lt;Stop&gt; button and insert Tray 2, or check the position of the paper guides.</p>

## Problem Solving

---

<b>024-961</b>	<p>Cause) Tray 3 has not been inserted or the paper guides are in an unsupported position.</p> <p>Remedy) Press the control panel's &lt;Stop&gt; button and insert Tray 3, or check the position of the paper guides.</p>
<b>024-962</b>	<p>Cause) Tray 4 has not been inserted or the paper guides are in an unsupported position.</p> <p>Remedy) Press the control panel's &lt;Stop&gt; button and insert Tray 4, or check the position of the paper guides.</p>
<b>024-965</b>	<p>Cause) The paper specified for the job is not loaded into any of the trays.</p> <p>Remedy) Load the specified paper, or press the control panel's &lt;Stop&gt; button to cancel the job.</p>
<b>024-966</b>	<p>Cause) Attempted to select a tray automatically although all trays except the Tray 5 (bypass) are not selectable for auto selection.</p> <p>Remedy) Press the control panel's &lt;Stop&gt; button, and try again.</p>
<b>024-718</b>	<p>Cause) Incompatible print parameters are used. The combination of the specified functions such as Document Size, Paper Size, Paper Tray, 2 sided printing, and Output Tray is incompatible.</p> <p>Remedy) Confirm the print data, and try printing again.</p>
<b>026-737</b>	<p>Cause) A network error occurred.</p> <p>Remedy) Consult your network administrator whether the network or the server have any problem.</p>
<b>027-518</b>	<p>Cause) Failed to login the forwarding destination.</p> <p>Remedy) Press the control panel's &lt;Stop&gt; button, and cancel the job.</p>
<b>027-520</b>	<p>Cause) Invalid characters are used or the specified path is not found.</p> <p>Remedy) Press the control panel's &lt;Stop&gt; button, and cancel the job.</p>
<b>027-522</b>	<p>Cause) Unable to write in the forwarding destination.</p> <p>Remedy) Press the control panel's &lt;Stop&gt; button, and cancel the job.</p>
<b>027-528</b>	<p>Cause) Data could not be written to the shared folder because the PC's hard disk is full.</p> <p>Remedy) Press the control panel's &lt;Stop&gt; button, and delete any unneeded data to create room on the hard disk.</p>
<b>027-543</b>	<p>Cause) The SMB server (NetBIOS) name is invalid.</p> <p>Remedy) Check whether the server name of the SMB server is correct, or press the control panel's &lt;Stop&gt; button to cancel the job.</p>
<b>027-779</b>	<p>Cause) Failed to authenticate the SMTP server.</p> <p>Remedy) Press the control panel's &lt;Stop&gt; button, and cancel the job.</p>
<b>033-313</b> <b>033-316</b>	<p>Cause) An error occurred while sending a fax.</p> <p>Remedy) Press the control panel's &lt;Stop&gt; button, and check the settings.</p>
<b>033-325</b>	<p>Cause) An error occurred.</p> <p>Remedy) Switch off the machine power, make sure that the touch screen is blank, and then switch on the machine power. If the same message is displayed again, contact our Customer Support Center.</p>
<b>033-326</b>	<p>Cause) The sender for the Scan to E-mail function has not been entered.</p> <p>Remedy) Press the control panel's &lt;Stop&gt; button, and check the settings.</p>

<p><b>033-503</b>  <b>033-504</b>  <b>033-505</b>  <b>033-506</b>  <b>033-507</b>  <b>033-509</b>  <b>033-510</b>  <b>033-517</b>  <b>033-526</b>  <b>033-529</b>  <b>033-531</b>  <b>033-532</b></p>	<p>Cause) An error occurred during fax transmission.  Remedy) The machine will automatically recover. Wait for a while, and try again.</p>
<p><b>033-541</b></p>	<p>Cause) The recipient of the specified number is not registered.  Remedy) Specify the recipient correctly, or press the control panel's &lt;Stop&gt; button, and cancel the job.</p>
<p><b>033-547</b></p>	<p>Cause) Communication was terminated by a cause such as pressing the &lt;Stop&gt; button.  Remedy) The machine will automatically recover. Press the control panel's &lt;Stop&gt; button, and try again.</p>
<p><b>033-548</b></p>	<p>Cause) Cannot transmit manually because a line is unavailable.  Remedy) Press the control panel's &lt;Stop&gt; button, and cancel the job.</p>
<p><b>033-549</b></p>	<p>Cause) Cannot use the Fax service because of causes such as memory is insufficient a fax in the queue.  Remedy) The machine will automatically recover. Wait for a while, and try again.</p>
<p><b>033-550</b>  <b>033-567</b></p>	<p>Cause) Unable to register in the Address Book.  Remedy) The machine will automatically recover. Wait for a while, and try again.</p>
<p><b>033-572</b></p>	<p>Cause) The data received is not printed.  Remedy) The machine will automatically recover. Wait for a while, and try again.</p>
<p><b>033-577</b>  <b>033-578</b></p>	<p>Cause) An error occurred during fax transmission.  Remedy) The machine will automatically recover. Wait for a while, and try again.</p>
<p><b>033-712</b></p>	<p>Cause) Unable to process because of insufficient memory.  Remedy) Delete unnecessary data. If the same message is displayed again, contact our Customer Support Center.</p>
<p><b>033-725</b></p>	<p>Cause) The hard disk is full.  Remedy) The machine will automatically recover. Wait for a while, and try again.</p>
<p><b>033-753</b></p>	<p>Cause) An error occurred during fax transmission.  Remedy) Press the control panel's &lt;Stop&gt; button, and cancel the job.</p>
<p><b>034-522</b></p>	<p>Cause) Cannot transmit manually because a line is unavailable.  Remedy) Confirm the completion of the job, or press the control panel's &lt;Stop&gt; button, and cancel the job.</p>
<p><b>034-550</b></p>	<p>Cause) An error occurred during fax transmission.  Remedy) Switch off the machine power, make sure that the display is blank, and then switch on the machine power. If the same message is displayed again, contact our Customer Support Center.</p>

## Problem Solving

---

<b>034-711</b>	Cause) An error occurred during fax transmission. Remedy) The machine will automatically recover. Wait for a while, and try again.
<b>034-726</b>	Cause) Exceeded the limit of jobs. Remedy) The machine will automatically recover. Wait for a while, and try again.
<b>034-746</b>	Cause) The line is not connected correctly. Remedy) Press the control panel's <Stop> button, and cancel the job.
<b>034-752</b>	Cause) The recipient's line is busy. Remedy) Press the control panel's <Stop> button, and cancel the job.
<b>034-757</b>	Cause) An error occurred during fax transmission. Remedy) The machine will automatically recover. Wait for a while, and try again.
<b>034-761</b> <b>034-765</b>	Cause) The recipient in the Address Book is incorrect. Remedy) Confirm the recipient's address, and try again. If the same message is displayed again, contact our Customer Support Center.
<b>035-550</b>	Cause) An error occurred during fax transmission. Remedy) Switch off the machine power, make sure that the display is blank, and then switch on the machine power.
<b>035-703</b>	Cause) An error occurred during fax transmission. Remedy) The machine will automatically recover. Wait for a while, and try again.
<b>035-704</b>	Cause) An error occurred while sending a fax. Remedy) The machine will automatically recover. Wait for a while, and try again.
<b>035-708</b> <b>035-728</b> <b>035-741</b> <b>035-748</b> <b>035-758</b> <b>035-759</b>	Cause) An error occurred while sending a fax during fax transmission. Remedy) The machine will automatically recover. Wait a moment, and try again.
<b>035-761</b>	Cause) An error occurred during fax transmission. Remedy) Switch off the machine power, make sure that the display is blank, and then switch on the machine power. If the same message is displayed again, contact our Customer Support Center.
<b>036-506</b>	Cause) An error occurred during fax transmission. Remedy) The machine will automatically recover. Wait for a while, and try again.
<b>036-550</b>	Cause) An error occurred during fax transmission. Remedy) Switch off the machine power, make sure that the display is blank, and then switch on the machine power.
<b>036-700</b>	Cause) An error occurred during fax transmission. Remedy) The machine will automatically recover. Wait for a while, and try again.
<b>036-740</b>	Cause) An error occurred during fax transmission. Remedy) Press the control panel's <Stop> button, and cancel the job.
<b>036-777</b> <b>036-796</b>	Cause) An error occurred during fax transmission. Remedy) The machine will automatically recover. Wait for a while and try again.

<b>041-210</b> <b>041-211</b>	Cause) An error occurred in Tray 1. Remedy) Switch off the machine power, make sure that the display is blank, and then switch on the machine power. If the same message is displayed again, contact our Customer Support Center.
<b>042-325</b>	Cause) An error occurred. Remedy) Switch off the machine power, make sure that the display is blank, and then switch on the machine power. If the same message is displayed again, contact our Customer Support Center.
<b>042-400</b>	Cause) The odor filter life is over. Remedy) Contact our Customer Support Center.
<b>042-608</b> <b>042-614</b>	Cause) The Voc filter life is over. Remedy) Contact our Customer Support Center.
<b>042-614</b>	Cause) An error occurred. Remedy) Switch off the machine power, make sure that the display is blank, and then switch on the machine power.
<b>045-310</b>	Cause) An error occurred. Remedy) Removed the jammed paper.
<b>045-313</b> <b>045-218</b> <b>061-321</b> <b>061-325</b>	Cause) An error occurred. Remedy) Switch off the machine power, make sure that the display is blank, and then switch on the machine power. If the same message is displayed again, contact our Customer Support Center.
<b>062-277</b>	Cause) An error occurred in the document feeder. Remedy) Switch off the machine power, make sure that the display is blank, and then switch on the machine power. If the same message is displayed again, contact our Customer Support Center.
<b>062-300</b>	Cause) The cover was open when a document was placed in the document feeder. Remedy) Close the cover.
<b>062-311</b>	Cause) An error occurred. Remedy) Switch off the machine power, make sure that the display is blank, and then switch on the machine power. If the same message is displayed again, contact our Customer Support Center.
<b>062-360</b> <b>062-371</b> <b>062-380</b> <b>062-386</b> <b>062-389</b> <b>062-396</b>	Cause) An error occurred. Remedy) Switch off the machine power, make sure that the display is blank, and then switch on the machine power. If the same message is displayed again, contact our Customer Support Center.
<b>071-105</b>	Cause) An error occurred in the left cover [A] or Tray 1. Remedy) Remove the jammed paper.
<b>072-102</b>	Cause) An error occurred in the one tray module cover [B] or Tray 2. Remedy) Remove the jammed paper.
<b>072-105</b>	Cause) A paper jam occurred in the one tray module cover [B]. Remedy) Remove the jammed paper.
<b>072-210</b> <b>072-212</b> <b>072-215</b>	Cause) An error occurred in Tray 2 (One Tray Module). Remedy) Switch off the machine power, make sure that the display is blank, and then switch on the machine power. If the same message is displayed again, contact our Customer Support Center.

## Problem Solving

---

<b>073-102</b>	Cause) A paper jam occurred in the two tray module cover [C] or Tray 3. Remedy) Remove the jammed paper.
<b>073-104</b>	Cause) A paper jam occurred in the one tray module cover [B] or the two tray module cover [C]. Remedy) Remove the jammed paper.
<b>073-105</b>	Cause) A paper jam occurred in the one tray module cover [B]. Remedy) Remove the jammed paper.
<b>073-210</b>	Cause) An error occurred in Tray 3 (Two Tray Module). Remedy) Switch off the machine power, make sure that the display is blank, and then switch on the machine power. If the same message is displayed again, contact our Customer Support Center.
<b>074-101</b> <b>074-102</b>	Cause) A paper jam occurred in the two tray module cover [C] or Tray 4. Cause) Remove the jammed paper.
<b>074-104</b>	Cause) A paper jam occurred in the one tray module cover [B] or the two tray module cover [C]. Remedy) Remove the jammed paper.
<b>074-105</b>	Cause) A paper jam occurred in the one tray module cover [B]. Remedy) Remove the jammed paper.
<b>074-210</b>	Cause) An error occurred in Tray 4 (Two Tray Module). Remedy) Switch off the machine power, make sure that the display is blank, and then switch on the machine power. If the same message is displayed again, contact our Customer Support Center.
<b>075-135</b> <b>077-101</b> <b>077-103</b> <b>077-104</b> <b>077-106</b>	Cause) A paper jam occurred in the left cover [A]. Remedy) Remove the jammed paper.
<b>077-129</b>	Cause) A paper jam occurred in the left cover [A]. Remedy) Remove the jammed paper.
<b>077-211</b>	Cause) An error occurred in the Two Tray Module. Remedy) Switch off the machine power, make sure that the display is blank, and then switch on the machine power. If the same message is displayed again, contact our Customer Support Center.
<b>077-212</b>	Cause) An error occurred in the One Tray Module. Remedy) Switch off the machine power, make sure that the display is blank, and then switch on the machine power. If the same message is displayed again, contact our Customer Support Center.
<b>077-300</b>	Cause) The front cover is open. Remedy) Close the front cover.
<b>077-301</b>	Cause) The left cover [A] is open. Remedy) Close the left cover [A].
<b>077-305</b>	Cause) The two tray module cover [C] is open. Remedy) Close the two tray module cover [C].
<b>077-309</b>	Cause) The one tray module cover [B] is open. Remedy) Close the one tray module cover [B].
<b>077-900</b> <b>077-901</b>	Cause) A paper jam occurred in the left cover [A]. Remedy) Remove the jammed paper.



<b>077-904</b>	Cause) A paper jam occurred in the one tray module cover [B]. Remedy) Remove the jammed paper.
<b>077-905</b> <b>077-906</b>	Cause) A paper jam occurred in the two tray module cover [B] or [C]. Remedy) Remove the jammed paper.
<b>091-313</b>	Cause) An error occurred. Remedy) Switch off the machine power, make sure that the display is blank, and then switch on the machine power. If the same message is displayed again, contact our Customer Support Center.
<b>091-401</b>	Cause) The drum cartridge needs to be replaced soon. Remedy) Replace the drum cartridge soon.
<b>091-402</b>	Cause) The drum cartridge needs to be replaced soon. Remedy) Replace the drum cartridge.
<b>091-406</b>	Cause) The drum cartridge life is over. Remedy) Replace the drum cartridge. Contact your local Fuji Xerox representative or sales representative.
<b>091-424</b>	Cause) The drum cartridge life is over. Remedy) Replace the drum cartridge immediately. Contact your local Fuji Xerox representative or sales representative.
<b>091-430</b>	Cause) The drum cartridge life is over. Remedy) Switch off the machine power, make sure that the display is blank, and then switch on the machine power. If the same message is displayed again, contact our Customer Support Center.
<b>091-440</b>	Cause) The drum cartridge need to be replaced soon. Remedy) Prepare a new drum cartridge.
<b>091-441</b>	Cause) The drum cartridge need to be replaced soon. Remedy) Replace the drum cartridge. Contact your local Fuji Xerox representative or sales representative.
<b>091-914</b> <b>091-915</b> <b>091-916</b>	Cause) An error occurred with the drum cartridge. Remedy) Switch off the machine power, make sure that the display is blank, and then switch on the machine power. If the same message is displayed again, contact our Customer Support Center.
<b>091-921</b>	Cause) An error occurred with the drum cartridge. Remedy) Replace the drum cartridge. Contact your local Fuji Xerox representative or sales representative.
<b>092-660</b>	Cause) A drum cartridge error occurred. Remedy) Switch off the machine power, make sure that the display is blank, and then switch on the machine power.
<b>092-661</b>	Cause) Temperature SNR (in CRU) value is out of range. Remedy) Exchange the Sensor unit, and switch off the machine power, make sure that the display is blank, and then switch on the machine power.
<b>092-668</b>	Cause) ATC SNR (in drum cartridge) value is out of range. Remedy) Switch off the machine power, make sure that the display is blank, and then switch on the machine power.
<b>092-910</b>	Cause) An error occurred. Remedy) Switch off the machine power, make sure that the display is blank, and then switch on the machine power.

## Problem Solving

---

<b>093-312</b>	Cause) An error occurred with the toner cartridge. Remedy) Switch off the machine power, make sure that the display is blank, and then switch on the machine power. If the same message is displayed again, contact our Customer Support Center.
<b>093-400</b>	Cause) There is no more toner in the toner cartridge. Remedy) Replace the toner cartridge.
<b>093-406</b>	Cause) The toner cartridge needs to be replaced soon. Remedy) Prepare a new toner cartridge.
<b>093-912</b>	Cause) There is no more toner in the toner cartridge. Remedy) Replace the toner cartridge.
<b>093-956</b>	Cause) There is no more toner in the toner cartridge. Remedy) Remove the seal on the drum cartridge.
<b>093-959</b>	Cause) An error occurred with the drum cartridge. Remedy) Replace the drum cartridge. Contact your local Fuji Xerox representative or sales representative.
<b>116-321</b> <b>116-323</b> <b>116-324</b> <b>116-334</b> <b>116-377</b>	Cause) An error occurred. Remedy) Switch off the machine power, make sure that the display is blank, and then switch on the machine power. If the same message is displayed again, contact our Customer Support Center.
<b>116-386</b>	Cause) The fax cable is not connected correctly. Remedy) Connect the cable securely, and then switch off the machine power, make sure that the display is blank, and then switch on the machine power. If the same message is displayed again, contact our Customer Support Center.
<b>116-747</b>	Cause) Unable to complete scanning due to the scanning area being too small. Remedy) Decrease the value of the Erase Frame or reduce the zoom ratio.
<b>117-326</b> <b>117-327</b> <b>123-314</b>	Cause) An error occurred. Remedy) Switch off the machine power, make sure that the display is blank, and then switch on the machine power. If the same message is displayed again, contact our Customer Support Center.
<b>127-396</b>	Cause) Failed to create a e-mail data. Remedy) Press the control panel's <Stop> button, and try again.
<b>133-226</b>	Cause) The country code specified is not supported by the machine or the time is not set. Remedy) Set the country code or time again.
<b>134-210</b> <b>134-211</b>	Cause) An error occurred during fax transmission. Remedy) Connect the cable securely, and then switch off the machine power, make sure that the display is blank, and then switch on the machine power. If the same message is displayed again, contact our Customer Support Center.

**Numerics**

2 Sided button ..... 7

**A**

Address Book button ..... 7

arrow buttons ..... 6

**B**

Back button ..... 7

**C**

C (Clear) button ..... 7

changing the paper setting ..... 20

cleaning ..... 9

ClearAll button ..... 6

Collated/Resolution button ..... 7

collating output ..... 26

control panel ..... 6

Copy button ..... 6

copying ID card ..... 24

copying two/four pages onto one sheet ..... 28

**D**

Data indicator ..... 7

Dial Pause button ..... 6

Display ..... 6

document jams ..... 39

**E**

Energy Saver button ..... 6

error code ..... 40

Error indicator ..... 6

**F**

Fax button ..... 7

**H**

how to copy ..... 23

how to fax ..... 33

how to print ..... 29

how to scan ..... 30

**I**

ID card copy button ..... 6

importing scanned data via application ..... 30

**J**

Job Status button ..... 6

**L**

Lighten/Darken button ..... 7

loading paper ..... 19

Log In/Out button ..... 6

**M**

Machine Status button ..... 6

making 2 sided copies ..... 25

making reduced or enlarged copies ..... 27

**N**

non-standard size document ..... 22

non-standard size paper ..... 20

Numeric keypad ..... 6

**O**

OK button ..... 6

One touch panels ..... 7

Original Type button ..... 7

Outline view ..... 7

**P**

Paper clip tray ..... 7

paper jams ..... 36

paper types ..... 18

placing document ..... 21

power on/off ..... 9

printer driver ..... 8

**R**

registering phone book ..... 35

**S**

safety notes ..... 10

Scan button ..... 7

sending scanned data to PC (network) ..... 32

sending scanned data via e-mail ..... 31

Speed Dial button ..... 7

Start button ..... 6

Stop button ..... 6

supported paper ..... 18

**U**

unusable paper ..... 18



---



**DocuCentre S2420/S2220**  
**Basic Operation Guide**

Fuji Xerox Co., Ltd.

DE5144E2-1 (Edition 1)

April 2013

Copyright © 2013 by Fuji Xerox Co., Ltd.

Printed in China

DocuCentre S2420  
DocuCentre S2220

# Basic Operation Guide





## Free Manuals Download Website

<http://myh66.com>

<http://usermanuals.us>

<http://www.somanuals.com>

<http://www.4manuals.cc>

<http://www.manual-lib.com>

<http://www.404manual.com>

<http://www.luxmanual.com>

<http://aubethermostatmanual.com>

Golf course search by state

<http://golfingnear.com>

Email search by domain

<http://emailbydomain.com>

Auto manuals search

<http://auto.somanuals.com>

TV manuals search

<http://tv.somanuals.com>