

Wi-Fi® Camera with Night Vision

**NETCAM** 



User Manual

## TABLE OF CONTENTS

### **Getting Started..... 1**

What's in the Box.....	1
Initial Setup .....	1
Set Up Your Camera Wirelessly Through Your Mobile Devices .....	2

### **Getting to Know Your Wi-Fi Camera ..... 19**

Front Panel.....	19
Back Panel .....	20

### **Technical Details..... 21**

Software Features and Specifications .....	21
Hardware Features and Specifications .....	25
System Requirements .....	27
Resetting the Camera .....	27

### **Troubleshooting, Support, and Warranty ..... 28**

Troubleshooting.....	28
Technical Support .....	29
Belkin International, Inc., Limited 2-Year Product Warranty .....	30

### **Regulatory Information..... 33**

FCC Statement .....	33
---------------------	----

## GETTING STARTED

---

**Congratulations on buying a Belkin NetCam. This device will enable you to easily check in on your home and your loved ones when you are away.**

### **What's in the Box**

NetCam

Power Supply

Quick Installation Guide

Mounting Kit

### **Initial Setup**

**To get started, you will need:**

- Your wireless router, its network name (SSID), and password.
- An Android™ device (Version 2.2 or later) or an iPhone, iPad, or iPod touch (iOS Version 4.1 or later).

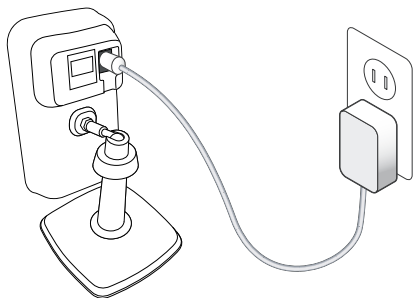

### Set Up Your Camera Wirelessly Through Your Mobile Devices

1. Plug the NetCam into a power outlet



2. Switch the NetCam to Setup Mode by flipping up the switch on the back of the camera



Please make sure the switch is in  setup mode and the  Wi-Fi light is blinking.

3. Download the NetCam App from the App Store or Google Play



4. Set Up on iPhone, iPad, or iPod touch

4.1 Connect your mobile device to NetCam Wi-Fi signal

Go to "Settings > Wi-Fi" on your iPhone/iPad/iPod touch and connect to the camera's Wi-Fi signal.



## GETTING STARTED

---

### 4.2 Launch the NetCam App

Once your device establishes a connection with the camera, launch the NetCam App. You should see a pop-up message like the one below. Click “Yes” to set up your camera.

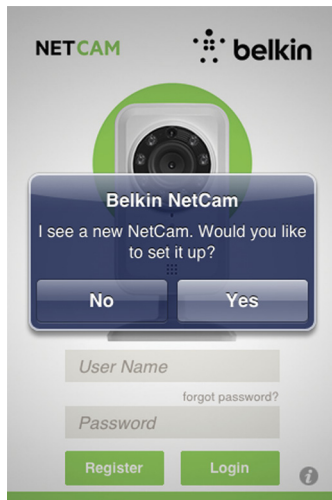

### 4.3 Camera Setup

Click “Continue” to begin setup.



### 4.4 Camera Preview

The camera will show you a preview after successfully connecting to your device.

Click “Connect Camera to Internet.”

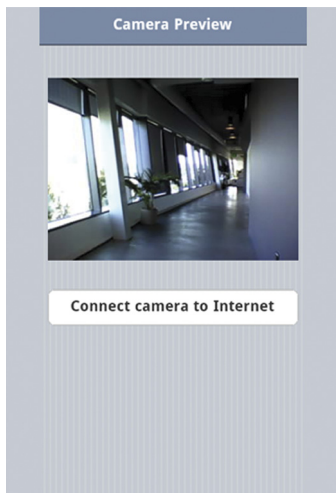

### 4.5 Connect to Internet

Choose your Wi-Fi network to connect to the Internet.



You may also choose to connect to your network via Ethernet cable (not included) by clicking “Ethernet.”

### 4.6 Connect to Internet

Enter your Wi-Fi password if you have a security-enabled network.

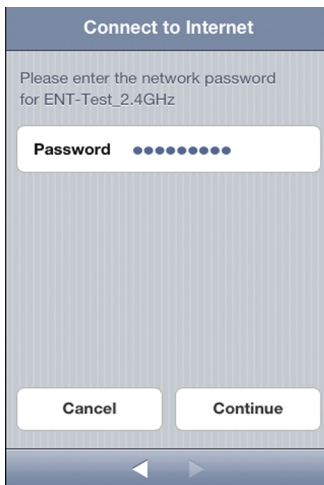

Please wait for the camera to establish connection with the Internet.

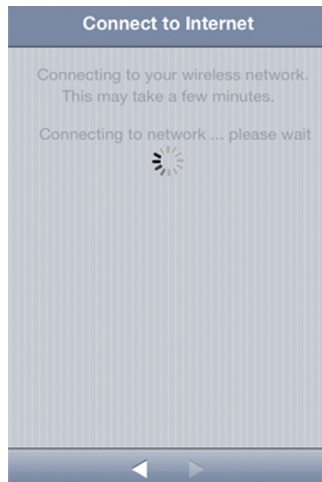



### 4.7 Create an Account

If this is your first time setting up your camera, you will need to create an account.

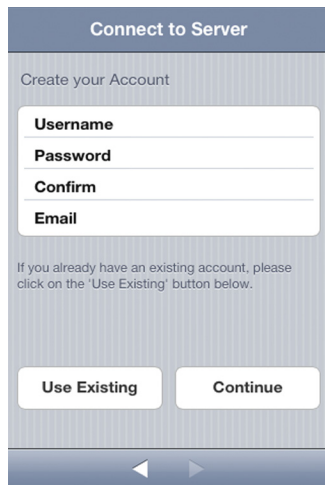

The screenshot shows a mobile application interface titled "Connect to Server". Below the title, it says "Create your Account". There are four input fields stacked vertically, each with a label: "Username", "Password", "Confirm", and "Email". Below these fields, there is a line of text: "If you already have an existing account, please click on the 'Use Existing' button below." At the bottom of the form area, there are two buttons: "Use Existing" and "Continue". The bottom of the screen features a navigation bar with left and right arrow icons.

### 4.8 Use Existing Account

If you have an existing account, select "Use Existing" and then enter your account information. Click "Sign in."

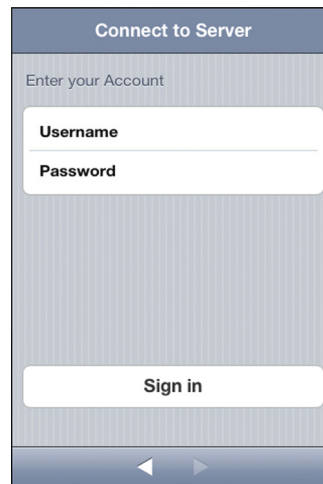

The screenshot shows a mobile application interface titled "Connect to Server". Below the title, it says "Enter your Account". There are two input fields stacked vertically, each with a label: "Username" and "Password". Below these fields, there is a large "Sign in" button. The bottom of the screen features a navigation bar with left and right arrow icons.

### 4.9 Set Up Camera Info

Create the camera name and its description.

Click “Continue.” It will take a few seconds to register the camera with the server.

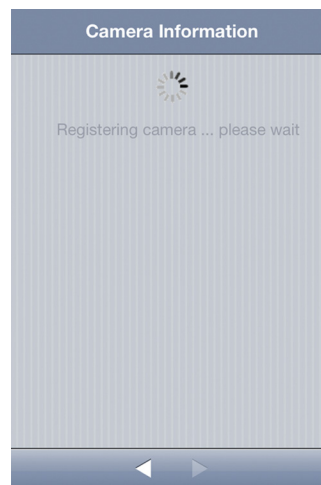
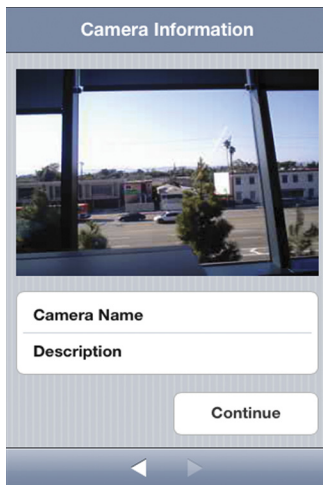

### 4.10 Setup Complete

Please flip the setup switch down on the back of the NetCam. Click “Finish” to complete the setup.

### Congratulations!

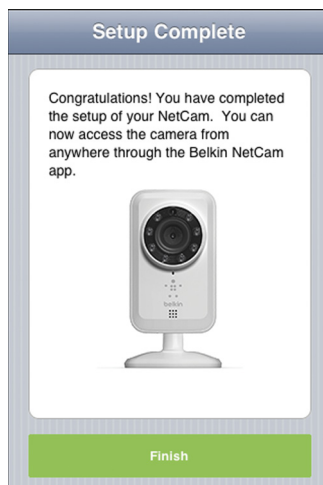

### 5. Set Up on Android Devices

#### 5.1 Connect your device to NetCam Wi-Fi signal

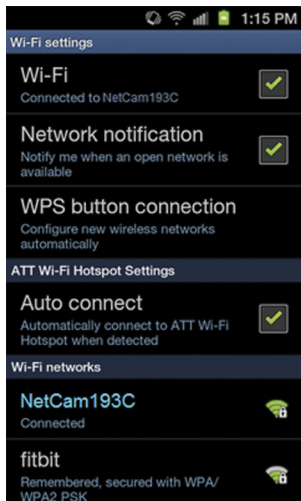

Go to “Settings > Wireless” and “Network > Wi-Fi settings” and connect to the camera Wi-Fi signal.

#### 5.2 Launch NetCam App!

Once your device establishes a connection with the camera, launch the NetCam App. You should see a pop-up message like the one below. Click “Yes” to set up your camera.

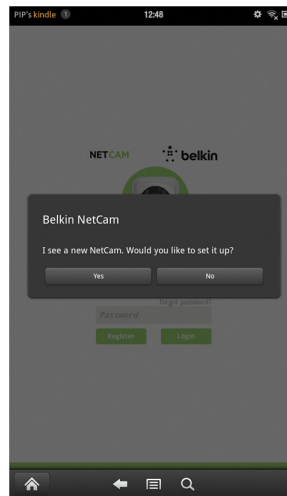

### 5.3 Camera Setup

Click “Continue” to begin setup.

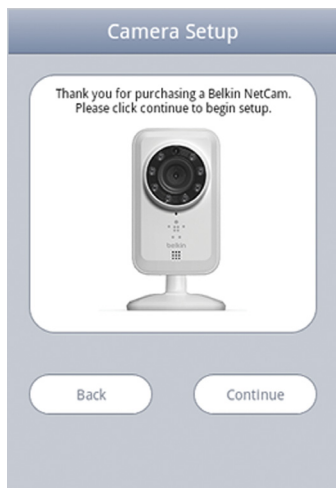

### 5.4 Camera Preview

The camera will show you a preview after successfully connecting to your device. Click “Connect camera to Internet.”

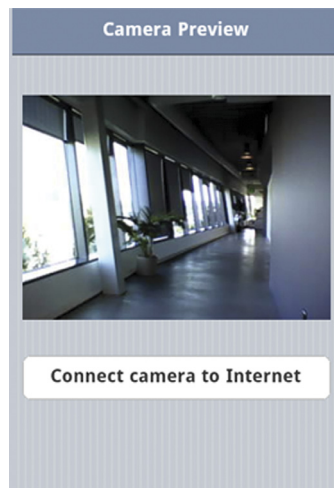

## GETTING STARTED

---

### 5.5 Connect to the Internet

Choose your Wi-Fi network to connect to the Internet.

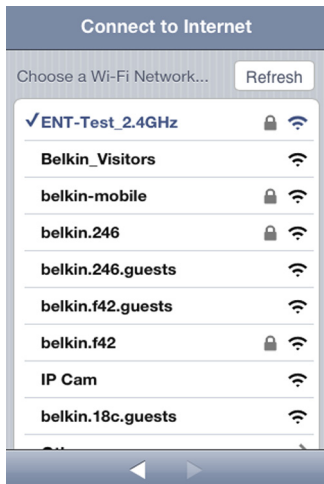

You may also choose to connect to your network via Ethernet cable (not included) by clicking "Ethernet."

### 5.6 Connect to Internet

Enter your Wi-Fi password if you have a security-enabled network.

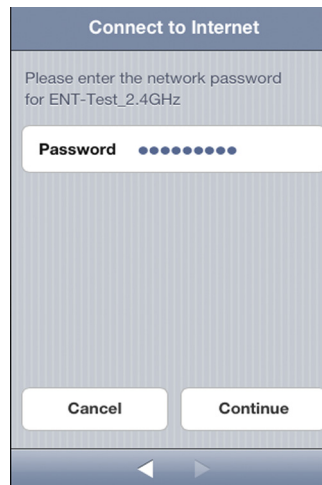

Please wait for the camera to establish an Internet connection.

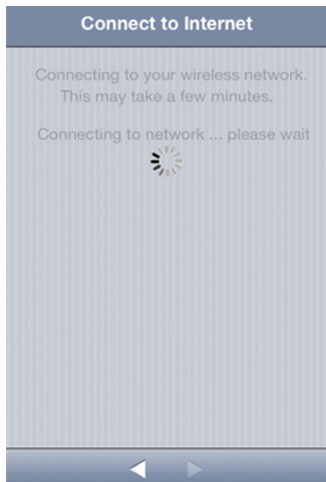

5.7 Create an Account

If this is your first time setting up your camera, you will need to create an account.

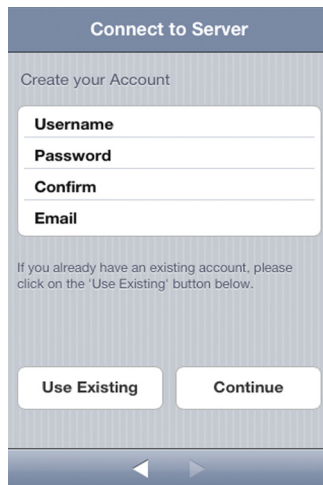

### 5.8 Use Existing Accounts

If you have an existing account, select “Use Existing” and then enter your account information. Click “Sign in.”

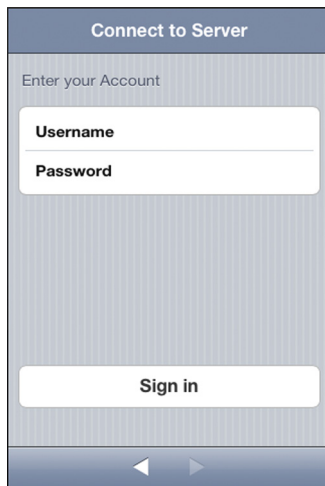

**Connect to Server**

Enter your Account

**Username**

**Password**

**Sign in**

### 5.9 Set Up Camera Info

Create the camera name and its description.

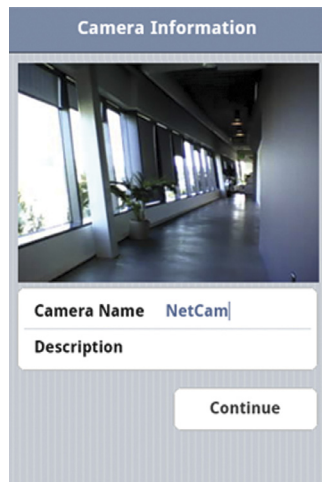

**Camera Information**



**Camera Name** NetCam

**Description**

**Continue**



Click "Continue." It will take a few seconds to register the camera with the server.

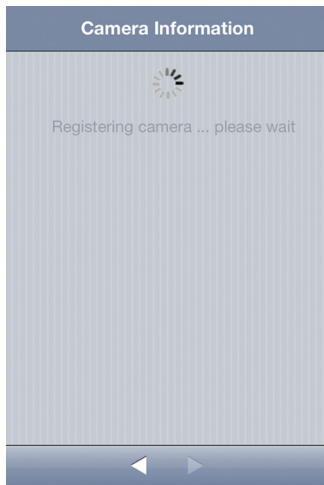

### 5.10 Setup Complete

Please flip the setup switch down on the back of the NetCam. Click "Finish" to complete the setup.

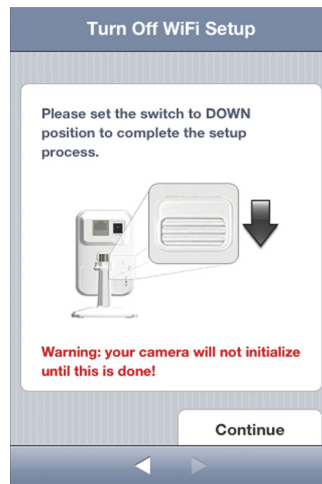

### Congratulations!

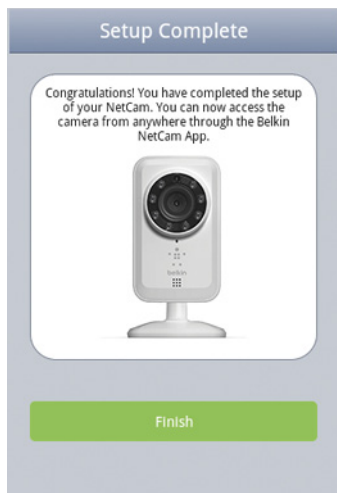

### 6. Mounting Your Camera (optional)

Unscrew camera post from the base and remove weight.

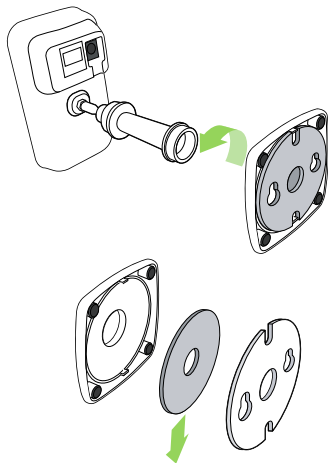

Attach screws to wall and hang plate onto screws.

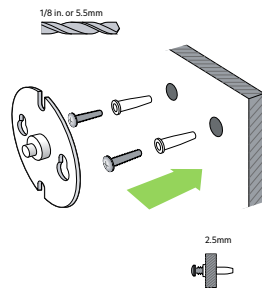

## GETTING STARTED

---

Align base with plate and screw on camera post.

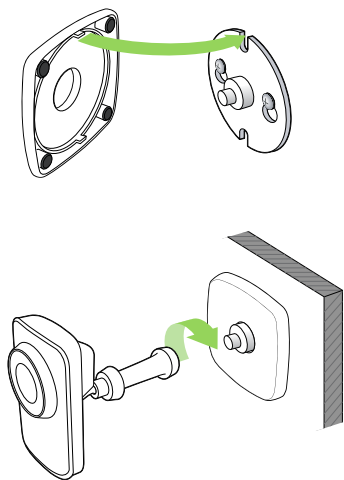

## GETTING TO KNOW YOUR WI-FI CAMERA

---

### Front Panel



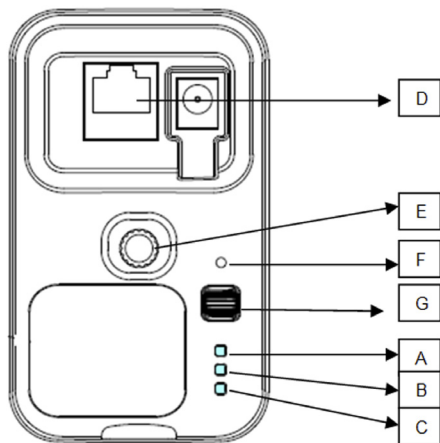

- A: Brightness sensor
- B: Camera sensor
- C: IR LED
- D: Microphone

### Back Panel



### LED Indicators

- A:**  **Setup**  
Green: Setup up mode on  
Amber: Setup mode initializing  
Light Off: Setup mode off

- B:**  **Network**  
Green: Connected to server  
Amber: Connected to local area network only  
Flashing Amber: Not connected to any network  
Flashing Green: Connected to network, ready to set up

- C:**  **Power**  
Green: Power On

### D: RJ45 port:

Can be used for wired setup and for a wired connection with the router while using the NetCam.

### E: Camera holder

You can adjust the NetCam's position by adjusting the holder.

### F: Reset button

Reset System: Press and hold for 1 second to reset the system.  
Factory Default: Press and hold for 20 seconds to restore factory default settings.

### G: Setup switch

Flip up to switch to setup mode.  
Flip down to switch to camera mode.

## TECHNICAL DETAILS

---

### Technical Features

#### Software Features and Specifications

##### App on iOS or Android

- Camera setup
- Live camera viewing
- Save snapshot and video from the live stream
- Live one-way audio
- Camera settings
  - Enable/disable email alert
  - Camera sharing
  - Set camera status (online, offline, private)
  - Video stream (Frame rate, video resolution, quality)
- General settings
  - Reset password
  - Sign in automatically
- Invite friends to view your camera

##### Web App

- Live camera viewing
- Live audio on selected PC web browsers (Internet Explorer®, Firefox®, and Google Chrome™)
- Camera settings
- Camera firmware upgrade
- Delete camera
- Invite friends to view your camera
- Enable/disable email alert

- User account management
- Create new user account
- Reset password



## Main Window

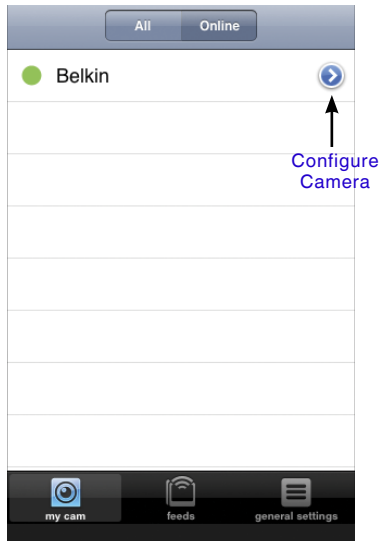

## Camera Configuration

- Name: Name of your camera
- Share/unshare: Make your camera public to your friends or not.
- Status: Change camera status to be online, offline, or private.
- Rotation: Select Normal or Flipped Vertically on the videos.
- IR: Select "Auto," "On," or "Off" of IR LEDs.
- Frame Rate: Up to 30fps
- Quality: 1-5 (Best = 5)
- Video Size: 160x120, 320x240, 640x480.
- Microphone > Enable/Disable Microphone
- Email alert > Enable/Disable email alert

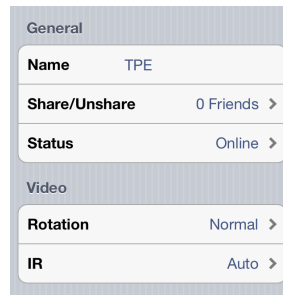



### Camera Viewer



Take a  
Snapshot

Record  
Video

Enable  
Microphone

## Protection

To protect your security against a hacker, a pop-up message will alert you if someone else is logged into your account at the same time as you.

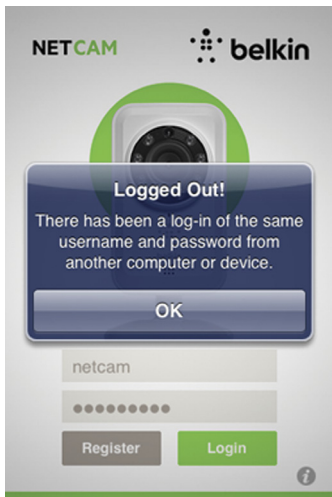

## Web Browser

Access this link via Internet Explorer, Netscape, Firefox, or Google Chrome: <http://www.belkin.com/netcam>

Then you can view the camera via your PC.

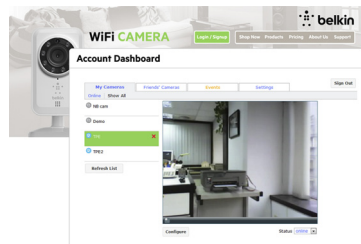
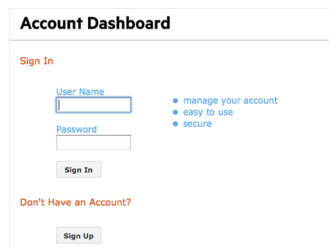

## Hardware Features and Specifications

Camera	
<b>Image Sensor</b>	VGA 1/4 inch CMOS sensor
<b>Lens</b>	Focal length: 3.1mm, F2.6
<b>View Angle</b>	Horizontal: 64° Vertical: 48° Diagonal: 80°
<b>IR LEDs</b>	8 IR LEDs, 850nm 8-meter illumination distance
<b>IR Mode</b>	Always on Always off Auto mode <ul style="list-style-type: none"> <li>● IR turns on when luminance decreases to about 3 lux</li> <li>● IR turns off when luminance increases to about 8 lux</li> </ul>
<b>Ambient Light Sensor</b>	RoHS-compliant 560nm luminance detector

Video	
<b>Codecs</b>	MJPEG, JPEG for still images
<b>Resolution</b>	160x120, 320x240, 640x480
<b>Frame Rate</b>	Up to 30 frames

<b>Still Image Capture</b>	Support VGA and 0.3MP resolution JPEG still capture
<b>Video Features</b>	Adjust image size and quality Flip and mirror image
Audio	
<b>Audio In</b>	Built-in microphone, -38 dB ± 2 dB
<b>Audio Compression</b>	G.711, PCM

Networking	
<b>Network Interface</b>	10/100Base-TX Fast Ethernet 802.11b/g/n WLAN
<b>Wireless Connectivity</b>	802.11b/g/n Wireless with WEP/WPA/WPA2 security
<b>Radio Specifications</b>	RF band: ISM Band 2.4GHz Channels: Varies by country RF Power Output <ul style="list-style-type: none"> <li>● 802.11n: 14 ± 1 dBm Average</li> <li>● 802.11g: 14 ± 1 dBm Average</li> <li>● 802.11b: 16 ± 1 dBm Average</li> </ul>
<b>Antenna</b>	Type: Chip antenna, SMD Gain: 1.3 dBm peak Efficiency: above 65%

General	
<b>System</b>	Processor: RT5350 Speed: 360MHz DRAM: 64MB Flash: 8MB
<b>Button</b>	Reset Button <ul style="list-style-type: none"> <li>● Reset system: Press less than 1 second to reset the system</li> <li>● Factory default: Press and hold 20 seconds to restore the factory default settings</li> </ul>
<b>Switch</b>	Setup mode switch: Turn setup mode on and off
<b>LEDs</b>	Setup Mode LED <ul style="list-style-type: none"> <li>● Solid Green: Setup Mode on</li> <li>● Amber: In progress to switch to Setup Mode</li> <li>● No light: Setup Mode off</li> </ul> Network LED <ul style="list-style-type: none"> <li>● Solid Amber: Local network ok</li> <li>● Solid Green: Connection to Internet ok</li> <li>● Flashing Amber: No network yet</li> <li>● Flashing Green: Global Internet ok</li> </ul> System LED <ul style="list-style-type: none"> <li>● Solid Green: System on</li> </ul>

<b>Power</b>	External AC-to-DC switching power adapter Input: 100-249V AC, 50/60Hz, Output: 5V DC, 1A
--------------	--

## System Requirements

iPhone, iPad, or iPod touch with iOS 4.1 or above or Android smart devices Version 2.2 or above

PC OS: Windows® XP, Windows Vista®, or Windows 7, or Mac OS® X v10.6.8 Snow Leopard

PC browsers: Internet Explorer 8, Google Chrome 16, Firefox 11.1, Safari® 5.1 Using the latest Adobe Flash Player

## Resetting the Camera

The “Reset” button is used in rare cases. In the unlikely event that your camera functions improperly, please use a pin to reset the camera. The Reset button is where the arrow below points. Reset the camera when the switch is in “OFF” mode. After the reset, the camera will resume to the default setting.

- Reset system: Press and hold for 1 second to reset the system
- Reset to factory default: Press and hold for 20 seconds to restore the factory default settings



## TROUBLESHOOTING, SUPPORT, AND WARRANTY

### If I buy more cameras, could I use the same username to connect them?

Unlimited cameras can be added under your own account, but each one should have a different camera name. The figure below shows that you can have different cameras under your account.

### Account Dashboard

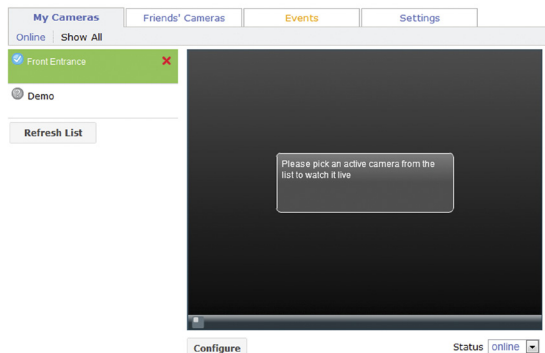

### How can I share my cameras with my friends?

Log in to your account. Under the camera configuration, find the "Sharing" icon. Type in your friends' email addresses to invite them to see your camera.

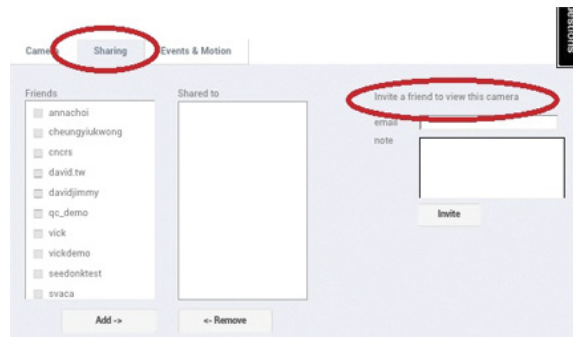

### How can I upgrade the firmware?

Access your NetCam's account from a web browser. Under the camera configuration, a screen will pop up like the one below. Click "Update Now." It will take about 5-10 minutes to upgrade the new firmware.

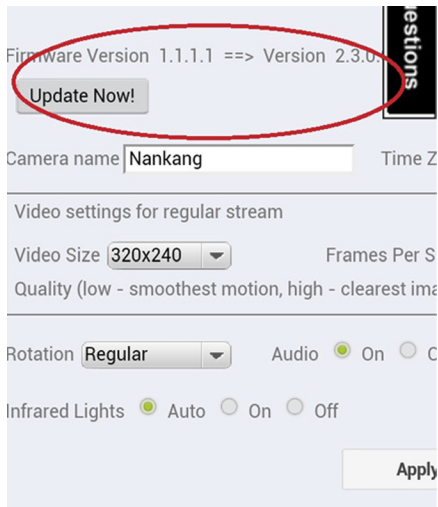

### Can I change my username?

Your username is what identifies your account information, and once set, it cannot be changed. If you later do not like your username, the only recourse is to create a new account. Please note that any subscription services registered in the old account (if applicable) cannot be transferred to the new account.

### Forgot or lost your password?

The NetCam App login screen has a link labeled "Forgot your password?" that takes you to the account sign-in webpage. Type in your username and email address, and then click the Reset button to begin the process of setting up a new password.

### Technical Support

#### US

<http://www.belkin.com/support>

### **Belkin International, Inc., Limited 2-Year Product Warranty**

#### **What this warranty covers.**

Belkin International, Inc. (“Belkin”) warrants to the original purchaser of this Belkin product that the product shall be free of defects in design, assembly, material, or workmanship.

#### **What the period of coverage is.**

Belkin warrants the Belkin product for two years.

#### **What will we do to correct problems?**

##### *Product Warranty.*

Belkin will repair or replace, at its option, any defective product free of charge (except for shipping charges for the product). Belkin reserves the right to discontinue any of its products without notice, and disclaims any limited warranty to repair or replace any such discontinued products. In the event that Belkin is unable to repair or replace the product (for example, because it has been discontinued), Belkin will offer either a refund or a credit toward the purchase of another product from Belkin.com in an amount equal to the purchase price of the product as evidenced on the original purchase receipt as discounted by its natural use.

#### **What is not covered by this warranty?**

All above warranties are null and void if the Belkin product is not provided to Belkin for inspection upon Belkin's request at the sole expense of the purchaser, or if Belkin determines that the Belkin product has been improperly installed, altered in any way, or tampered with. The Belkin Product Warranty does not protect against acts of God such as flood, lightning, earthquake, war, vandalism, theft, normal-use wear and tear, erosion, depletion, obsolescence, abuse, damage due to low voltage disturbances (i.e. brownouts or sags), non-authorized program, or system equipment modification or alteration.



### **How to get service.**

To get service for your Belkin product you must take the following steps:

1. Contact Belkin International, Inc., at 12045 Waterfront Drive, Los Angeles, CA 90094, Attn: Customer Service, or call (800)-223-5546, within 15 days of the Occurrence. Be prepared to provide the following information:
  - a. The part number of the Belkin product.
  - b. Where you purchased the product.
  - c. When you purchased the product.
  - d. Copy of original receipt.

2. Your Belkin Customer Service Representative will then instruct you on how to forward your receipt and Belkin product and how to proceed with your claim.

Belkin reserves the right to review the damaged Belkin product. All costs of shipping the Belkin product to Belkin for inspection shall be borne solely by the purchaser. If Belkin determines, in its sole discretion, that it is impractical to ship the damaged equipment to Belkin, Belkin may designate, in its sole discretion, an equipment repair facility to inspect and estimate the cost to repair such equipment. The cost, if any, of shipping the equipment to and from such repair facility and of such estimate shall be borne solely by the purchaser. Damaged equipment must remain available for inspection until the claim is finalized. Whenever claims are settled, Belkin reserves the right to be subrogated under any existing insurance policies the purchaser may have.

### **How state law relates to the warranty.**

THIS WARRANTY CONTAINS THE SOLE WARRANTY OF BELKIN. THERE ARE NO OTHER WARRANTIES, EXPRESSED OR, EXCEPT AS REQUIRED BY LAW, IMPLIED, INCLUDING THE IMPLIED WARRANTY OF CONDITION OF QUALITY, MERCHANTABILITY OR FITNESS FOR A PARTICULAR PURPOSE, AND SUCH IMPLIED WARRANTIES, IF ANY, ARE LIMITED IN DURATION TO THE TERM OF THIS WARRANTY.

Some states do not allow limitations on how long an implied warranty lasts, so the above limitations may not apply to you.

IN NO EVENT SHALL BELKIN BE LIABLE FOR INCIDENTAL, SPECIAL, DIRECT, INDIRECT, CONSEQUENTIAL OR MULTIPLE DAMAGES SUCH AS, BUT NOT LIMITED TO, LOST BUSINESS OR PROFITS ARISING OUT OF THE SALE OR USE OF ANY BELKIN PRODUCT, EVEN IF ADVISED OF THE POSSIBILITY OF SUCH DAMAGES.

This warranty gives you specific legal rights, and you may also have other rights, which may vary from state to state. Some states do not allow the exclusion or limitation of incidental, consequential, or other damages, so the above limitations may not apply to you.

## REGULATORY INFORMATION

---

### **DECLARATION OF CONFORMITY WITH FCC RULES FOR ELECTROMAGNETIC COMPATIBILITY**

We, Belkin International, Inc., of 12045 E. Waterfront Drive, Playa Vista, CA 90094, declare under our sole responsibility that the device, F7D7601v1, complies with Part 15 of the FCC Rules. Operation is subject to the following two conditions: (1) this device may not cause harmful interference, and (2) this device must accept any interference received, including interference that may cause undesired operation.

### **FCC Statement**

#### **Federal Communication Commission Interference Statement**

This equipment has been tested and found to comply with the limits for a Class B digital device, pursuant to Part 15 of the FCC Rules. These limits are designed to provide reasonable protection against harmful interference in a residential installation.

This equipment generates, uses, and can radiate radio frequency energy, and if not installed and used in accordance with the instructions, may cause harmful interference to radio communications. However, there is no guarantee that interference will not occur in a particular installation. If this equipment does cause harmful interference to radio or television reception, which can be determined by turning the equipment off and on, the user is encouraged to try and correct the interference by one or more of the following measures:

- Reorient or relocate the receiving antenna.
- Increase the distance between the equipment and the receiver.
- Connect the equipment to an outlet on a circuit different from that to which the receiver is connected.
- Consult the dealer or an experienced radio/TV technician for help.

FCC Caution: Any changes or modifications not expressly approved by the party responsible for compliance could void the user's authority to operate this equipment.

### **IMPORTANT NOTE:**

#### **FCC Radiation Exposure Statement:**

This equipment complies with FCC radiation exposure limits set forth for an uncontrolled environment. This equipment should be installed and operated with a minimum distance of 20cm between the radiator and your body.



## Free Manuals Download Website

<http://myh66.com>

<http://usermanuals.us>

<http://www.somanuals.com>

<http://www.4manuals.cc>

<http://www.manual-lib.com>

<http://www.404manual.com>

<http://www.luxmanual.com>

<http://aubethermostatmanual.com>

Golf course search by state

<http://golfingnear.com>

Email search by domain

<http://emailbydomain.com>

Auto manuals search

<http://auto.somanuals.com>

TV manuals search

<http://tv.somanuals.com>